

To: T10 Membership
From: WC Gintz for Adaptec
Advanced Technology Group
Date: March 12, 1998 - San Diego, CA

Hot Plugging on U3 Busses (Second Report)

- Fig 1 Photograph of Backplane cabling and drives
- Fig 2 Close up photo showing probes on Hot Plugged drive.
- Fig 3 Schematic of Probes & two scope triggering
- Fig 4 a) Single Hot Plug Event at fast sweep speed scope trace
b) Same event triggering slow sweep scope trace
- Fig 5 a) Multiple Hot Plug events at fast frame viewing
b) First of multiple events triggering slow sweep scope traces.
- Fig 6 a) Hot UN-plug events at fast sweep speed
b) Same first event triggering slow speed triggering slow sweep.
- Fig 7 a) Spice Simulation Schematic for Lossy 40ft differential cable
b) Spice Schematic detail at "Victim" and "Hot Plug" locations.
- Fig 8 Spice U3 Waveforms with Hot Plug noise injected.

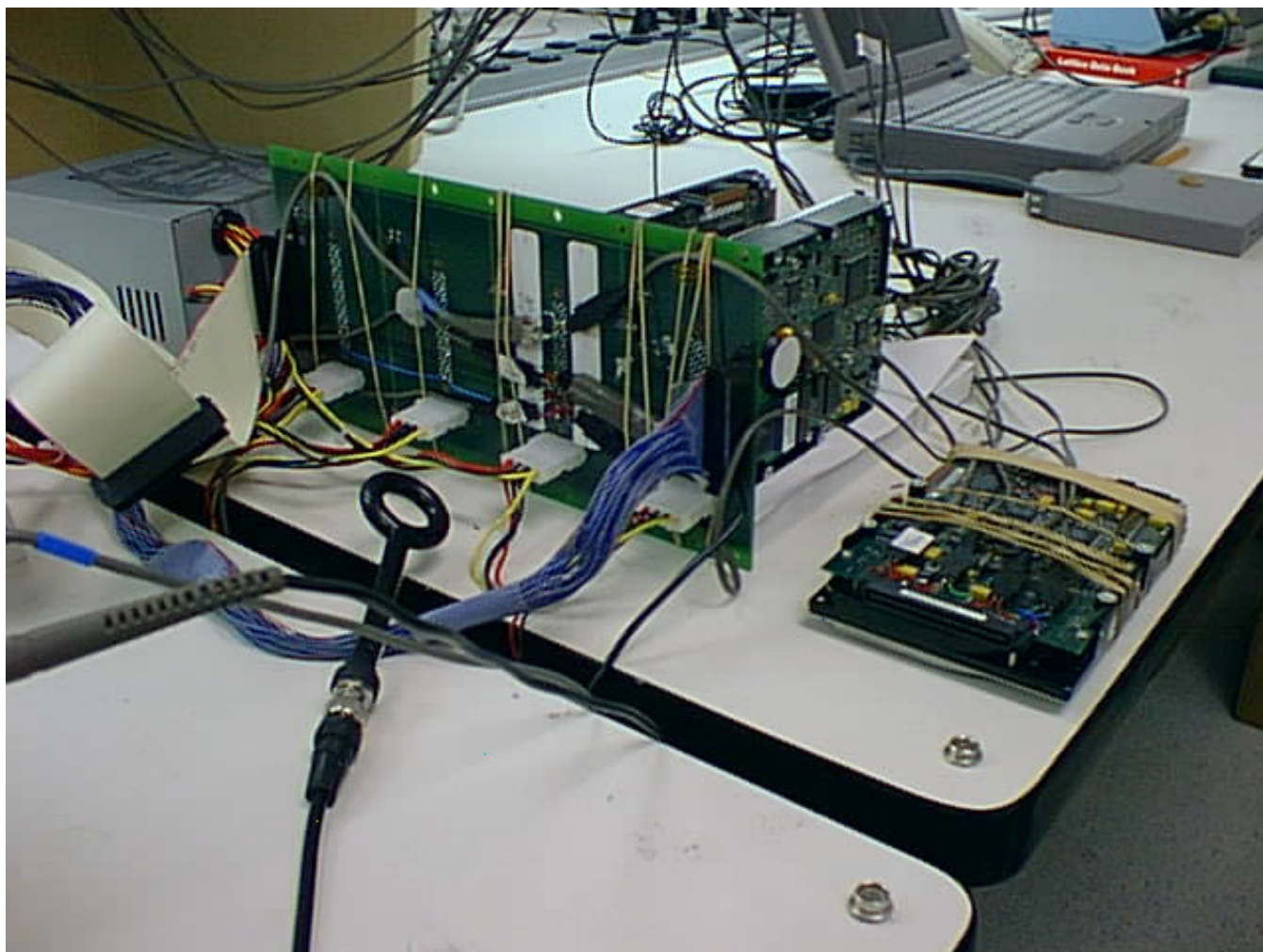

Figure 1 - Backplane cabling and drives

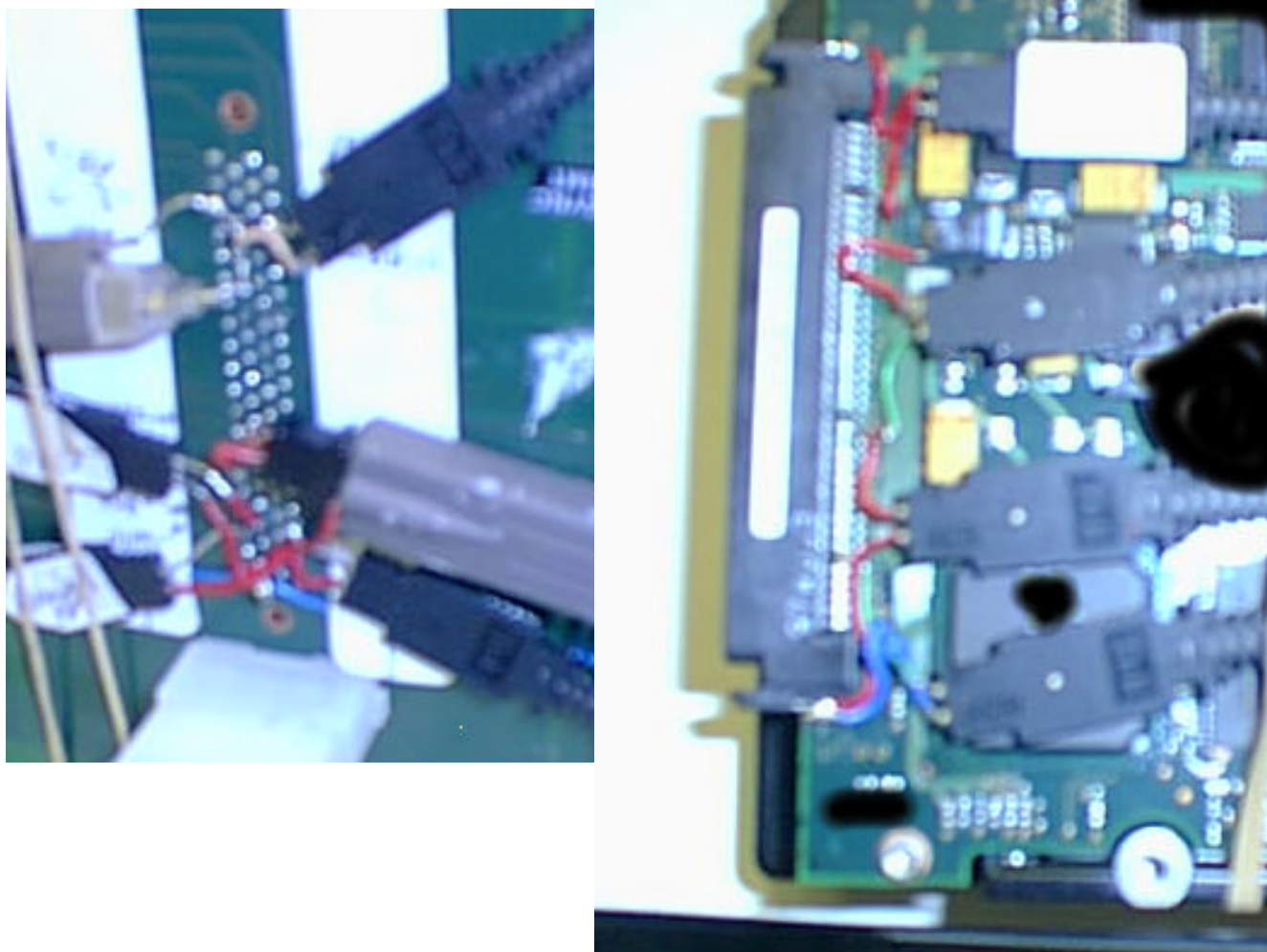

Figure 2- Close up photo showing probes on Hot Plugged drive

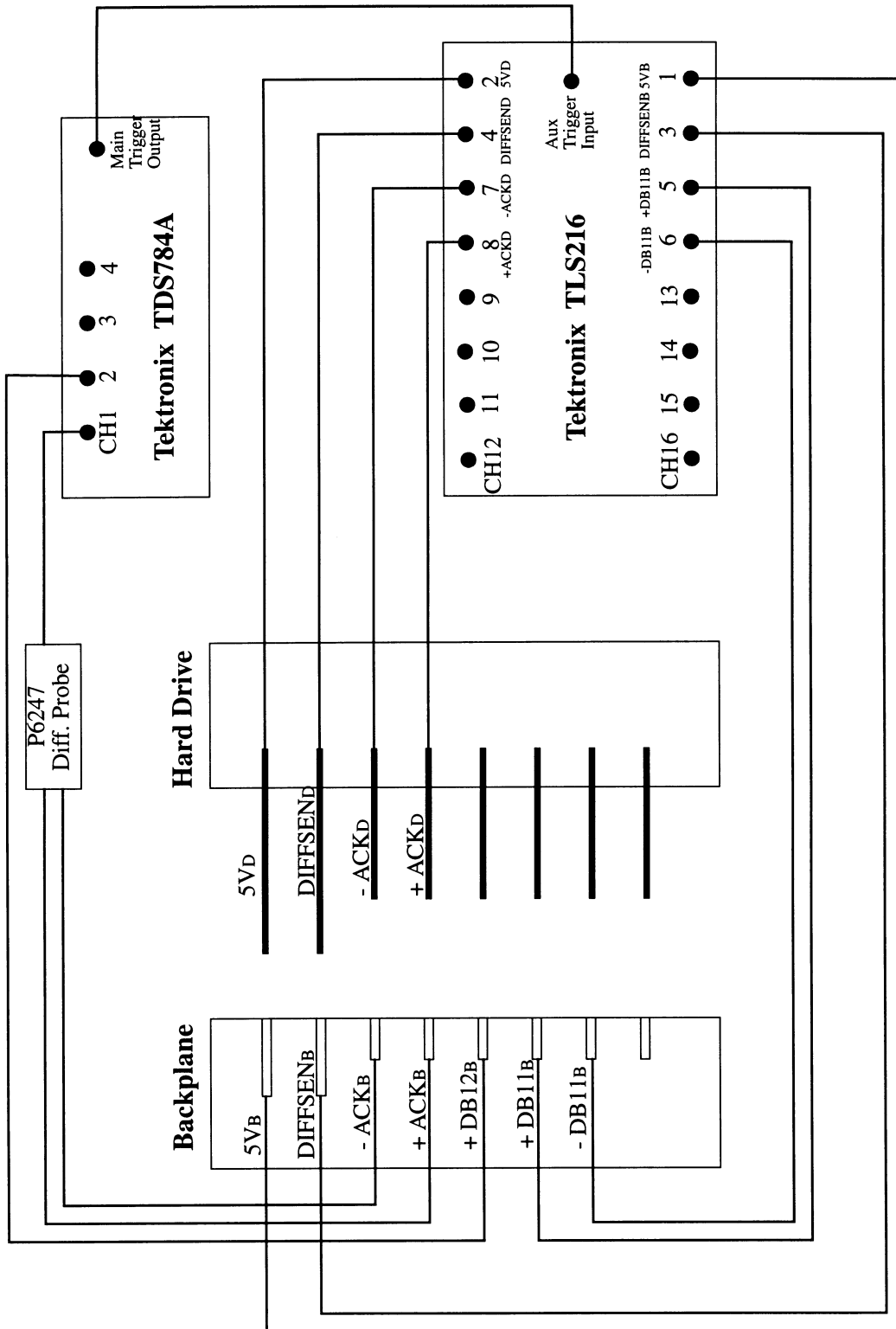

Figure 3 - Schematic of Probes & two scope triggering

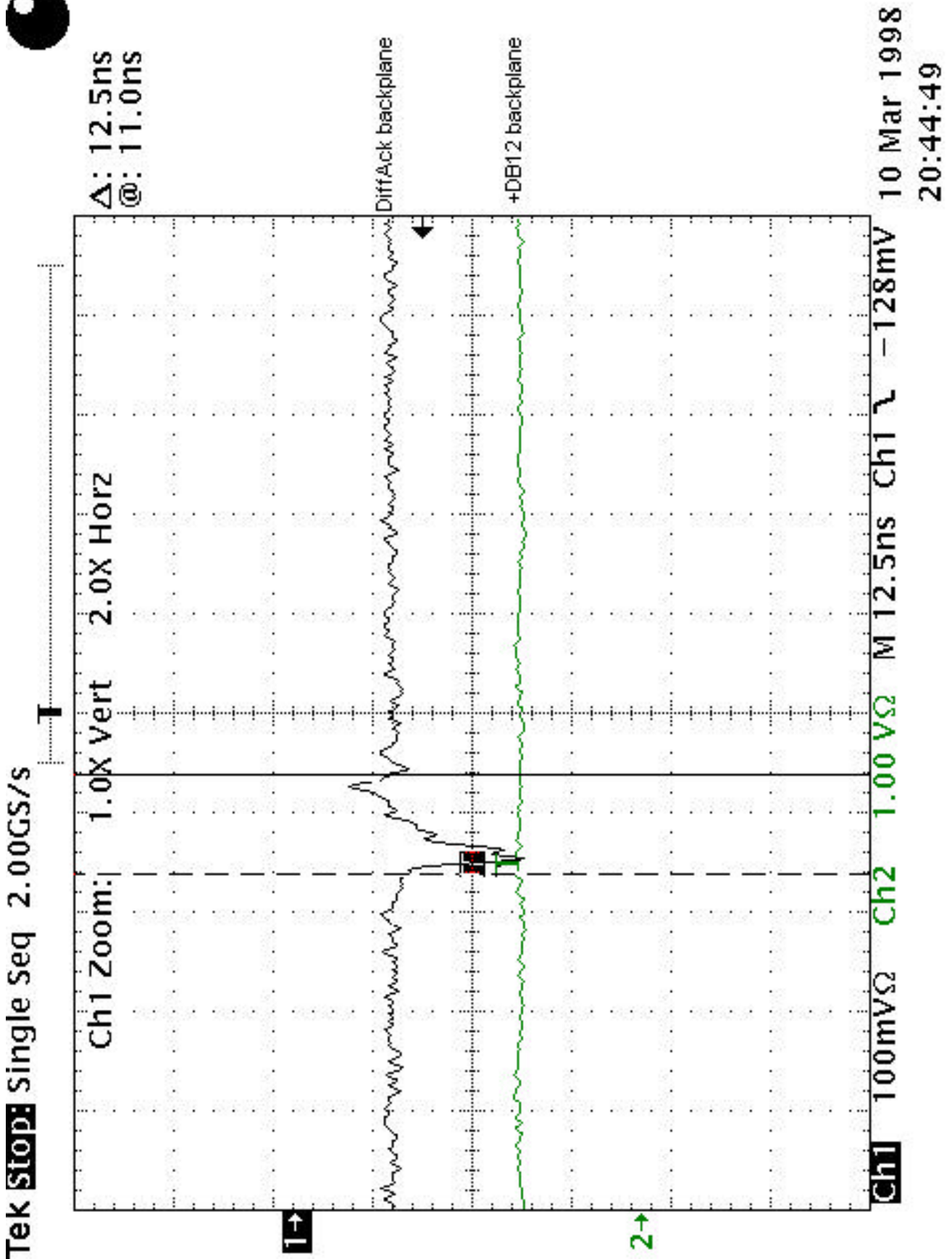

Figure 4a - Single-event hot-plug at fast sweep speed scope trace

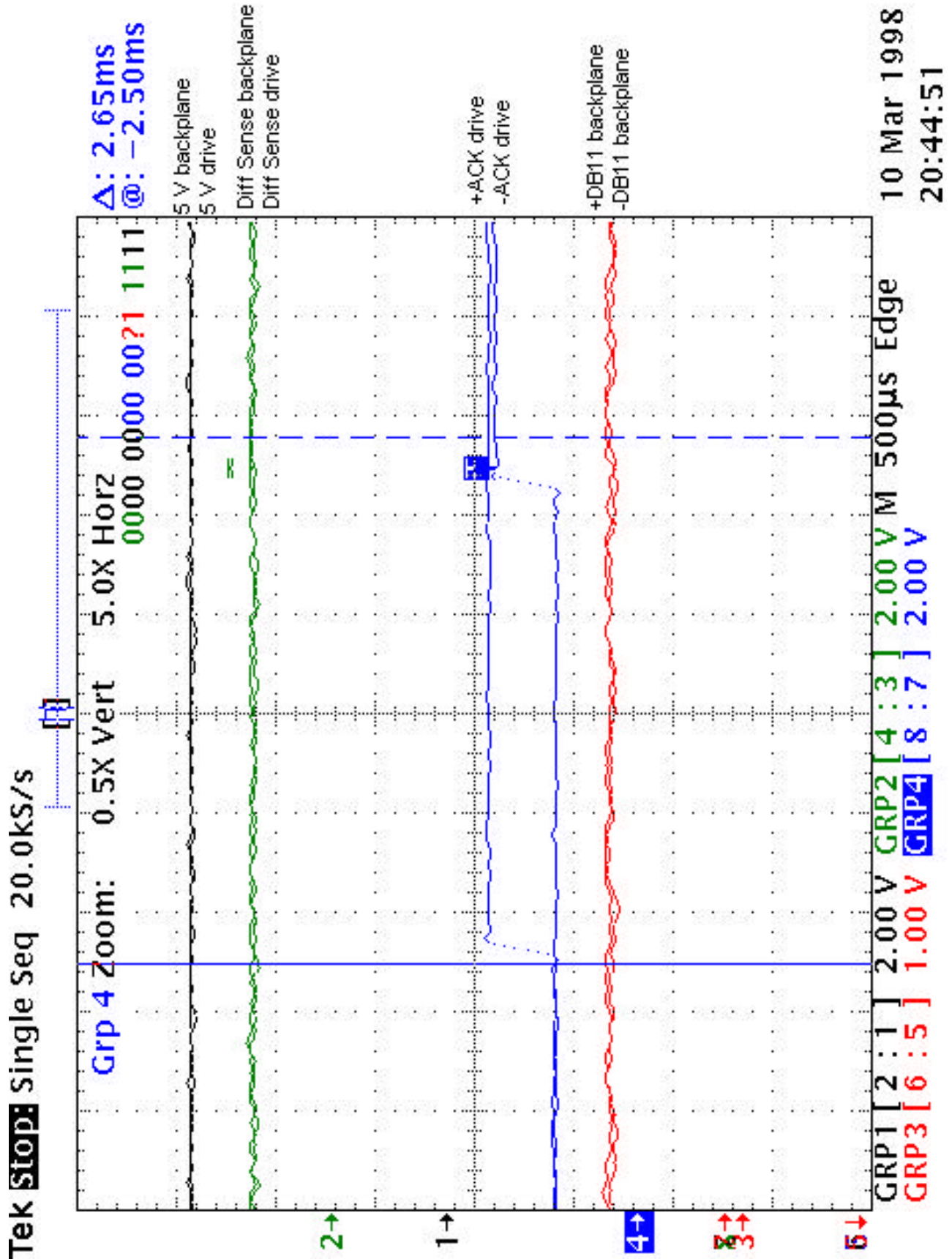

Figure 4b - Same event triggering slow sweep scope trace

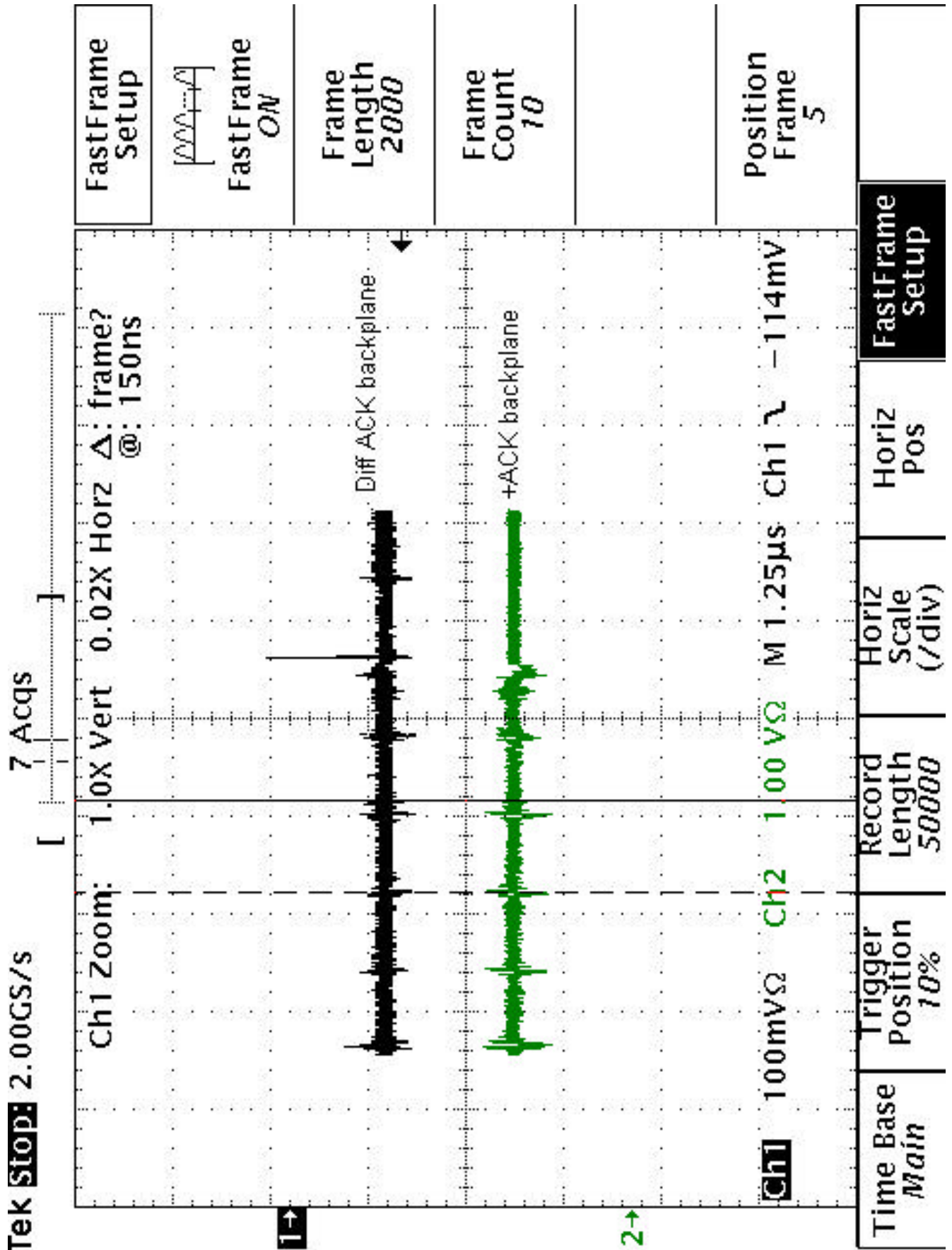

Figure 5a - Multiple-event hot-plug at fast frame viewing

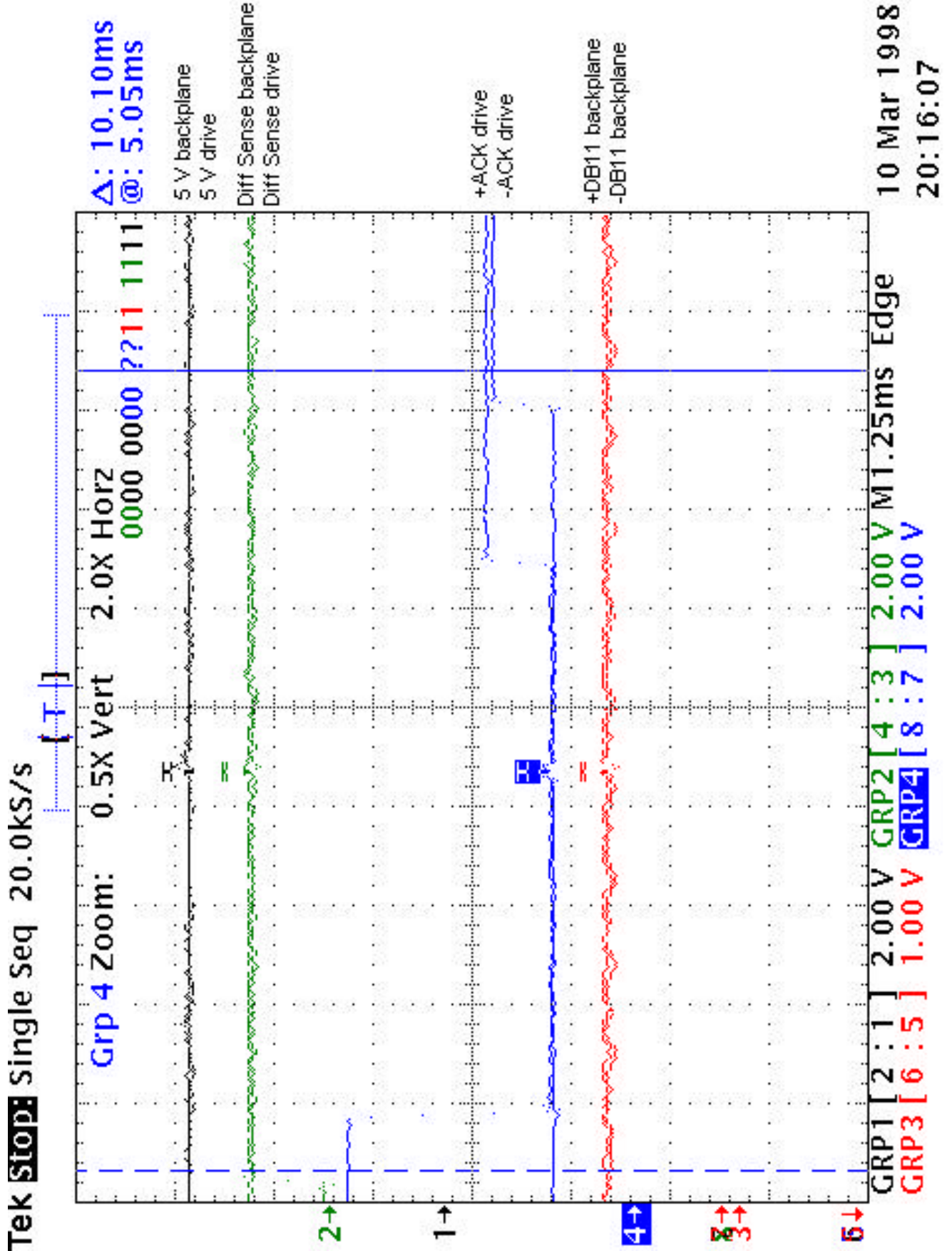

Figure 5b - First of multiple events triggering slow sweep scope traces

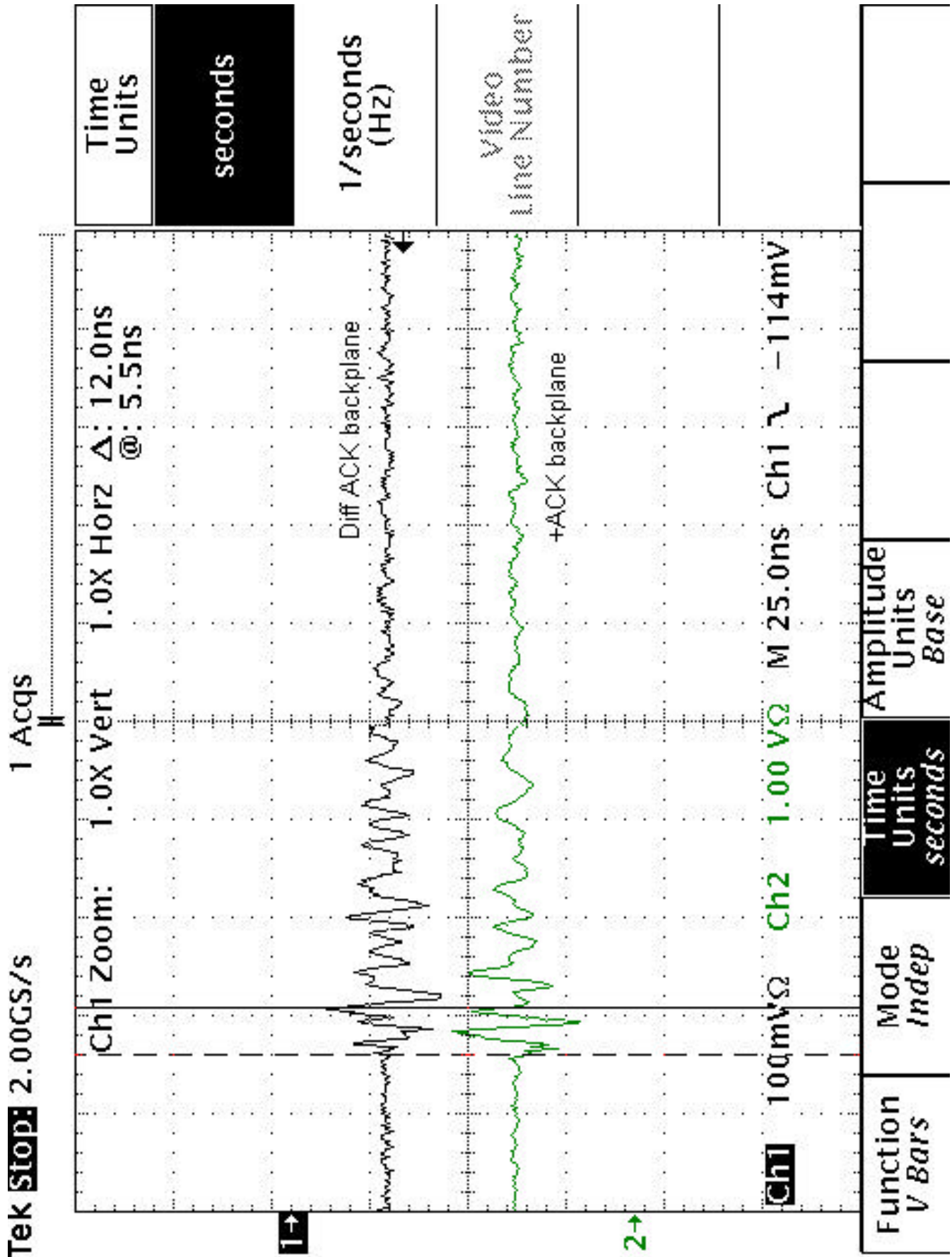

Figure 6a - Hot un-plug events at fast sweep speed

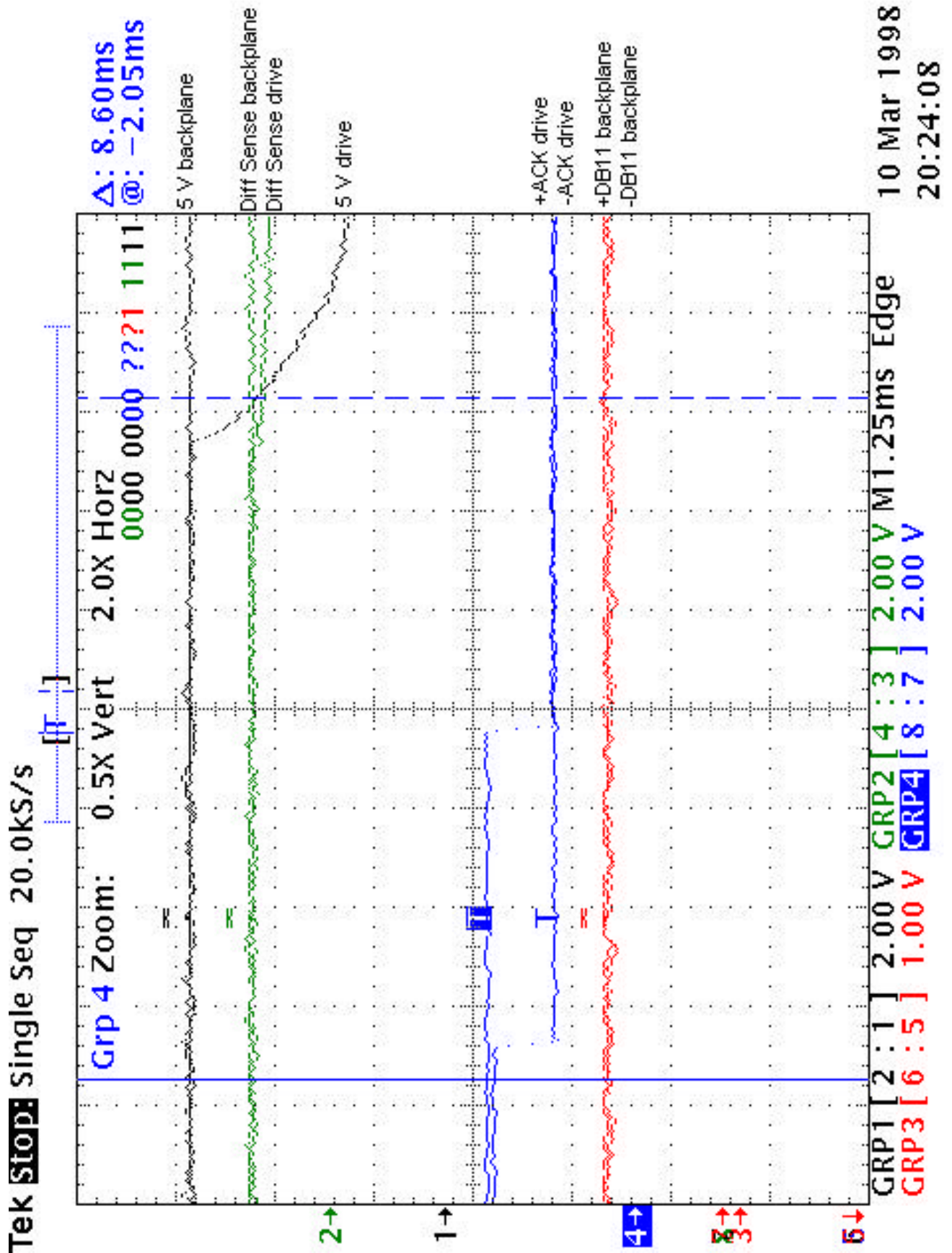

Figure 6b - Same first event triggering slow speed triggering slow sweep

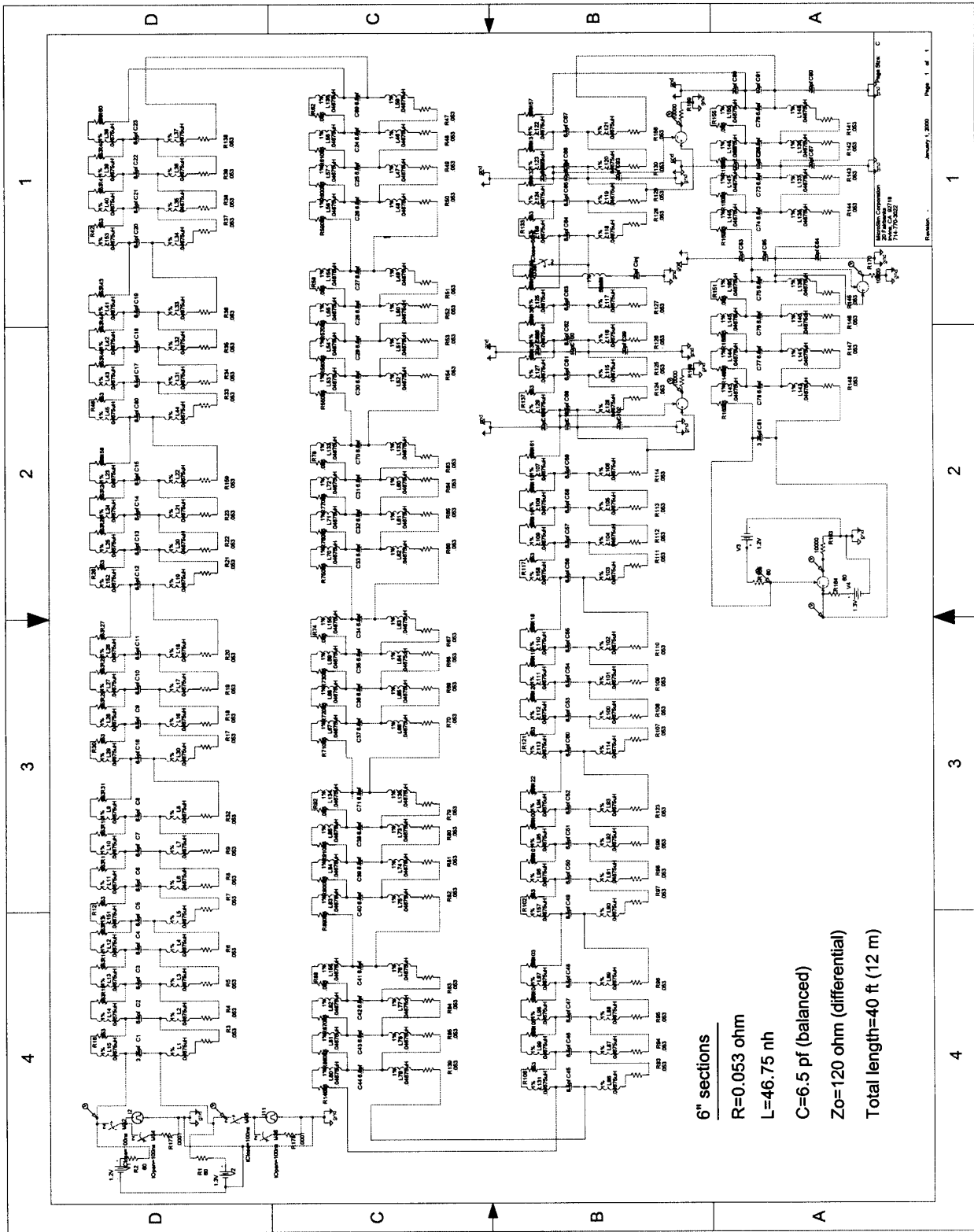
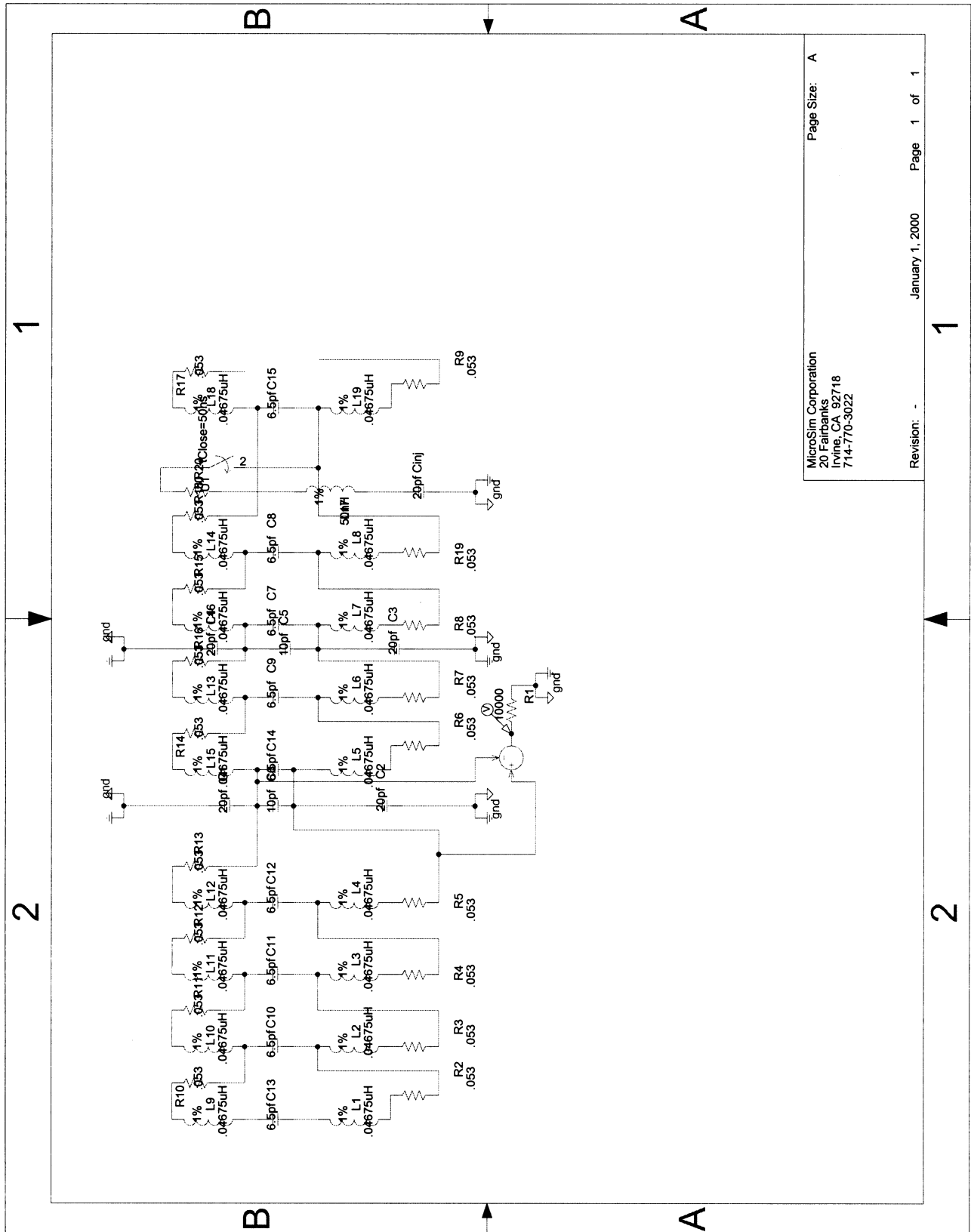

Figure 7a - Spice Simulation Schematic for Lossy 40ft differential cable



MicroSim Corporation
20 Fairbanks
Irvine, CA 92718
714-770-3022

Page Size: A

Revision: -
January 1, 2000
Page 1 of 1

Figure 7b - Spice Schematic detail at "Victim" and "Hot Plug" locations

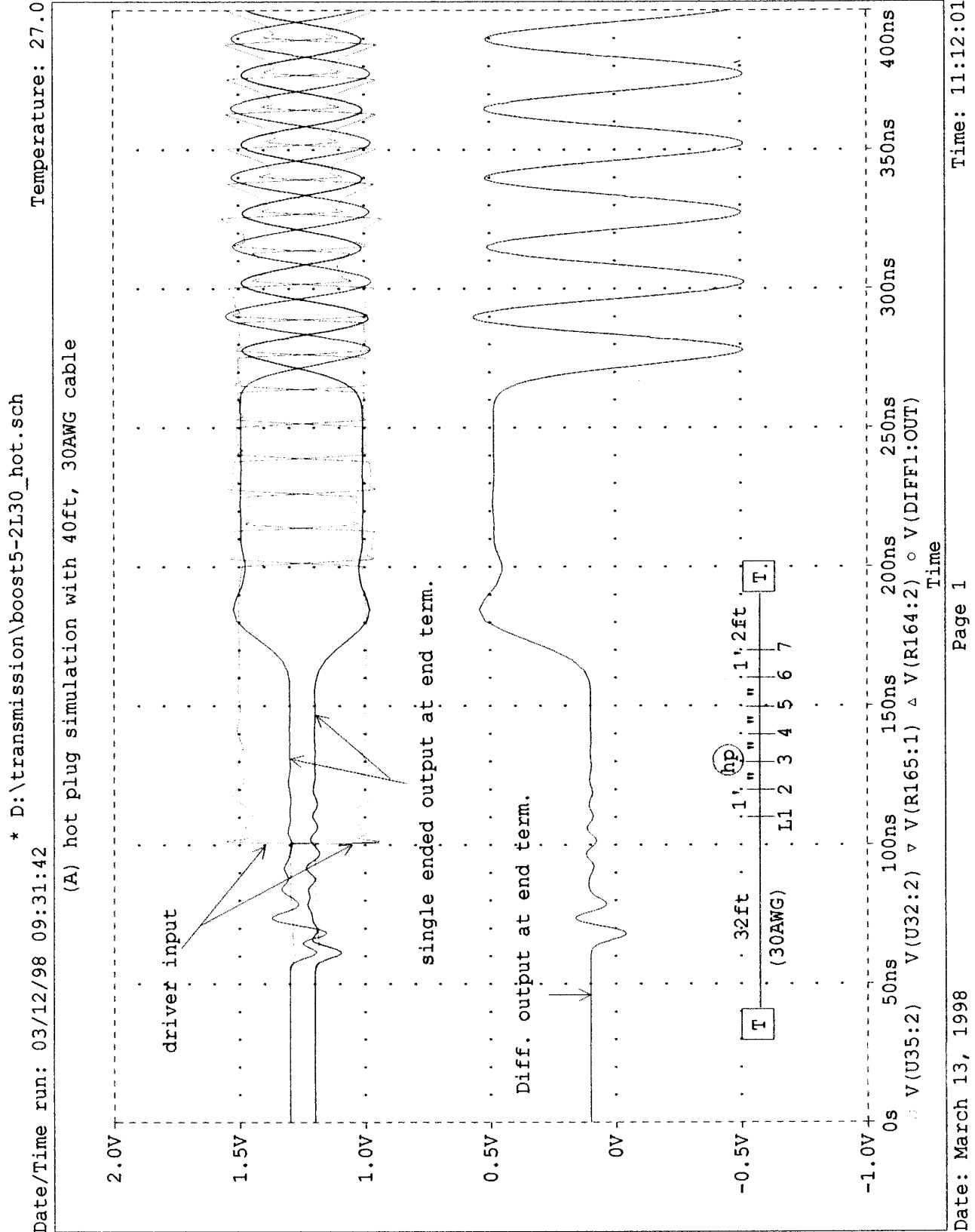

Figure 8 - Spice U3 Waveforms with Hot Plug noise injected