

Mt. Fuji Commands for Multimedia Devices Version 7

Revision 1.00
April 18, 2008 6:46 pm
Status: Draft for Review

T10/08-237R0

INF-8090i v7

This document was developed by an industry group known as the Mt. Fuji Group. This group consisted of optical disc drive manufacturers, operating system vendors, independent software developers, and other optical disc affiliated companies. This document provides for commands to implement CD-R, CD-RW, DVD-ROM, DVD-RAM, DVD-R, DVD-RW, HD DVD-ROM, HD DVD-R, HD DVD-RW and HD DVD-RAM.

This document is the basis for changes made to INF-8090 Rev 6.1 to generate INF-8090 Rev 7.0. The distribution for public review is via the SFF Committee.

Point of Contact:

I. Dal Allan

Chairman SFF Committee
ENDL
14426 Black Walnut Court
Saratoga, CA 95070
Ph: (408) 867-6630
Fax: (408) 867-2115
E-Mail: endlcom@acm.org

SFF specifications are available at
<ftp://ftp.seagate.com/sff>

Technical Editors:

Keiji Katata

PIONEER CORPORATION
6-1-2, Fujimi, Tsurugashima-shi
Saitama, 350-2288
Ph: +81-49-279-2300
E-Mail: keiji_katata@post.pioneer.co.jp

Takaharu Ai

Matsushita Electric Industrial Co., LTD
1-15, Matsuo-cho, Kadoma-shi
Osaka, 571-8504
Ph: +81-6-6906-2706
E-Mail:
ai.takaharu@jp.panasonic.com

Atsushi Ishihara

TOSHIBA CORPORATION
8, Shinsugita-cho, Isogo-ku,
Yokohama-shi
Kanagawa, 235-8522
Ph: +81-45-770-3310
E-Mail: atsushi.ishihara@toshiba.co.jp

Hideki Takahashi

TOSHIBA CORPORATION
8, Shinsugita-cho, Isogo-ku,
Yokohama-shi
Kanagawa, 235-8522
Ph: +81-45-770-3310
E-Mail: hidy.takahashi@toshiba.co.jp

The use of this specification is completely voluntary; its existence does not in any respect preclude anyone, whether he/she has approved the specification or not, from manufacturing, marketing, purchasing, or using products, processes, or procedures not conforming to this specification. This specification is preliminary and should not be used as the basis for any product.

CAUTION NOTICE: This specification may be revised or withdrawn at any time.

SFF Committee Information Specifications

Information Specifications are not developed by the SFF Committee but have been submitted for distribution on the basis that they are of interest to the storage industry. If the members agree, the document is distributed by the SFF Committee. The copyright on the contents remains with the contributor.

Contributors are not required to abide by the SFF patent policy. Readers are advised of the possibility that there may be patent issues associated with an implementation which relies upon the contents of an 'i' specification.

The SFF Committee accepts no responsibility for the validity of the contents.

1.0	Introduction	49
1.1	Abstract.....	49
1.2	Scope.....	50
1.3	Audience	50
1.4	Normative references	50
1.5	Informative references	50
1.6	Prerequisites and related documents.....	50
1.7	Layout of the document	50
1.8	Patents.....	52
1.9	Change history	52
2.0	Conventions	55
2.1	Document conventions	55
2.2	Definitions	55
2.3	Keyword definitions	69
2.4	Symbols, abbreviations and acronyms	70
3.0	CD model	71
3.1	CD media organization	71
3.2	CD physical data format	75
3.2.1	Frame format for audio	75
3.2.2	Sector format for data.....	75
3.2.3	Sub-channel information formats.....	76
3.3	CD audio error reporting	77
3.4	CD READY condition/NOT READY condition.....	77
3.5	Logical Unit Not Busy condition/Busy condition	77
3.6	CD address reporting formats (MSF bit).....	78
3.7	Error reporting	78
3.8	Recording for CD media.....	79
3.8.1	Packet layout for CD.....	79
3.8.2	Addressing method.....	80
3.8.3	Track Descriptor Block (TDB)	80
3.8.4	High speed CD-RW media recording	82
4.0	DVD model	83
4.1	DVD media description	83
4.1.1	DVD specifications	84
4.2	Track structure	85
4.3	ECC block.....	90
4.4	Sector configuration.....	90
4.4.1	Physical sector.....	90
4.4.2	Data Unit 1	91
4.4.3	Data configuration of Data ID field	92
4.5	Data structure of Lead-in Area	94
4.5.1	Control Data Zone.....	95
4.5.1.1	Physical format information	95
4.5.2	R/RW-Physical format information Zone	103
4.5.3	Extra Border Zone.....	106
4.6	DVD READY condition/NOT READY condition.....	106
4.7	Logical Unit Not Busy condition/Busy condition	108
4.8	DVD content protection.....	108
4.8.1	Content protection for read-only DVD	108
4.8.2	Content protection for recordable and rewritable DVD.....	108
4.8.3	Authentication process	108
4.9	Error reporting	110

4.10	Removable medium	110
4.11	Logical blocks.....	110
4.12	Data cache.....	111
4.13	Seek.....	111
4.14	DVD Video format information for CSS Managed Recording	111
4.14.1	Data type in the DVD Video title.....	111
4.14.2	Scrambled data indicators	112
4.15	Region Playback Control (RPC).....	113
4.15.1	Playback limitations by world region	113
4.15.2	Region code setting	113
4.15.2.1	Initial setting.....	113
4.15.2.2	Changing of the Drive Region.....	114
4.15.3	Limits on Drive Region changes.....	114
4.15.4	RPC states	115
4.16	Recording and reading for DVD-RAM media	117
4.16.1	Logical layout of DVD-RAM media	117
4.16.2	Supplementary Spare Area.....	118
4.16.3	DVD-RAM ECC block boundary issue.....	121
4.16.4	Unrecorded ECC blocks.....	121
4.16.5	Read Modify Write	121
4.16.6	Data ID	122
4.16.7	Defect management for DVD-RAM media	122
4.16.8	DMA information.....	124
4.16.9	Scheduling of Linear Replacement	126
4.16.10	Formatting	127
4.16.10.1	Formatting Type 1 - Slow Initialization	127
4.16.10.2	Formatting Type 2 - Quick Improvement	128
4.16.10.3	Formatting Type 4 - Quick Clearing	128
4.16.11	Interruption of formatting	129
4.16.12	Cartridge and Disc Type	129
4.16.13	Write protection of a disc.....	129
4.16.13.1	Write-inhibit hole	130
4.16.13.2	Write-inhibit flag	130
4.16.13.3	Disc Type Identification	130
4.16.13.4	Sensor hole A1	130

4.17	Recording for DVD-R Single Layer media	131
4.17.1	Basics for DVD-R vs. CD-R.....	131
4.17.2	Recording model for DVD-R Single Layer media	131
4.17.2.1	Sequential recording	131
4.17.3	Disc-at-once recording	132
4.17.4	Incremental recording	133
4.17.4.1	Linking and Data Type bit.....	133
4.17.4.2	Linking with 2 KB or 32 KB Linking Loss.....	134
4.17.4.3	Sample sequence of incremental recording:.....	136
4.17.4.4	Lossless-Link.....	136
4.17.4.5	Buffer under-run free recording	136
4.17.5	DVD-Video compatibility issues	136
4.17.6	RZone model.....	137
4.17.7	RZone reservation	138
4.17.7.1	Limitation for number of reserved RZones	138
4.17.7.2	RZone numbering.....	139
4.17.7.3	Block SYNC Guard Area (BSGA).....	139
4.17.7.4	RZone reservation scheme	140
4.17.7.5	Sample sequence for RZone reservation	142
4.17.8	RZone closing	143
4.17.9	Optimum Power Calibration (OPC).....	144
4.17.10	Required actions during write operation.....	144
4.17.10.1	Linking check9 for sequential recording.....	144
4.17.10.2	ECC boundary padding and Data Type bit in ID field.....	145
4.17.10.3	Overwrite is prohibited.....	146
4.17.11	RMD (Recording Management Data) for Single Layer discs.....	147
4.17.11.1	RMD Field 0 (RMD Header)	147
4.17.11.2	The contents of Format 1 RMD for Single Layer disc.....	149
4.17.11.3	When RMD is written in RMA	155
4.17.11.4	Example of write sequence.....	156
4.17.11.5	Border Zone.....	156
4.17.11.6	Disc final closure.....	161
4.17.12	State of disc for interchange.....	162
4.17.13	The data which are recordable by DVD-R logical units	163
4.17.14	Recovery from a damaged disc	163
4.17.14.1	Recovery method from incomplete linking	163
4.17.14.2	Recovery method from RMA write error.....	164
4.17.14.3	Recovery method from RMA EDC error	164
4.17.14.4	Recovery for accident during Border-out writing	165

4.18	Recording for DVD-R DL media	167
4.18.1	The basics for DVD-R DL media	167
4.18.1.1	Three Recording Modes for DVD-R DL disc	167
4.18.1.2	Associated Profile and Feature	168
4.18.1.3	Recording order	169
4.18.1.4	Fixed logical volume space	169
4.18.2	Remapping on Layer Jump recording	169
4.18.3	State of DVD-R DL disc for interchange.....	171
4.18.4	Recording mode for DVD-R DL media.....	172
4.18.4.1	DAO recording	172
4.18.4.2	Incremental recording.....	172
4.18.4.3	Layer Jump recording.....	173
4.18.4.4	Comparison chart among recording modes	173
4.18.5	DVD-R DL Layer Jump Recording	174
4.18.5.1	Recording unit	174
4.18.5.2	RZone reservation	178
4.18.5.3	Layer Jump recording on Invisible/Incomplete RZone.....	183
4.18.5.4	RZone Closing.....	192
4.18.5.5	Border Zone for DVD-R DL media	197
4.18.5.6	Remapping recording example.....	200
4.18.5.7	Disc final closure	205
4.18.6	RMD (Recording Management Data) for DVD-R DL media	207
4.18.6.1	RMD Field 0 (RMD Header) for DVD-R DL disc	207
4.18.6.2	The contents of Format 1 RMD on DVD-R DL disc	210
4.18.6.3	The contents of Format 4 RMD.....	215
4.18.6.4	When RMD is written in RMA	220
4.18.7	DVD-Video compatibility issues for DVD-R DL disc	222
4.18.7.1	Allocation rule of DVD Video format Cell.....	222
4.18.7.2	Typical usage of the third reserved RZone.....	222
4.18.7.3	Recommendation for multiple open RZone recording	222
4.19	Address Mode reservation	223

4.20	Recording/reading for DVD-RW Single Layer media	225
4.20.1	Basics	225
4.20.2	Recording mode	225
4.20.2.1	Sequential recording mode	225
4.20.2.2	Restricted overwrite mode	225
4.20.2.3	Recording mode transition	226
4.20.3	Link position	226
4.20.4	Bordered Area state	226
4.20.4.1	Empty state	226
4.20.4.2	Incomplete state	227
4.20.4.3	Complete state	227
4.20.4.4	Intermediate state	227
4.20.4.5	Data writing on an intermediate state Bordered Area	227
4.20.4.6	Multi-border on DVD-RW SL media	228
4.20.4.7	Recording mode and Bordered Area state transition	228
4.20.5	RMA structure	229
4.20.5.1	RMA structure for Sequential recording mode	230
4.20.5.2	RMA structure for Restricted overwrite mode	230
4.20.6	RMD contents for DVD-RW SL media	231
4.20.6.1	RMD Header - Field 0	231
4.20.6.2	Format 1 RMD Field 1	234
4.20.6.3	Format 1 RMD Field 2 to Field 14	235
4.20.6.4	Format 2 RMD Field 1	235
4.20.6.5	Format 2 RMD Field 2	236
4.20.6.6	Format 2 RMD Field 3 to Field 14	237
4.20.6.7	Format 3 RMD Field 1	237
4.20.6.8	Format 3 RMD Field 2	237
4.20.6.9	Format 3 RMD Field 3	237
4.20.6.10	Format 3 RMD Field 4 to Field 12	238
4.20.6.11	Format 3 RMD Field 13	239
4.20.6.12	Format 3 RMD Field 14	239
4.20.7	Reading/recording of RMD	240
4.20.7.1	RMD recording in Sequential recording mode	240
4.20.7.2	RMD recording in Restricted overwrite mode	240
4.20.7.3	RMD read sequence in Restricted overwrite mode	240
4.20.8	Border Zone	240
4.20.8.1	Structure	241
4.20.8.2	Border Zone size	241
4.20.9	Erasing	241
4.20.9.1	Registration of erase operation in RMD	241
4.20.10	Formatting	242
4.20.10.1	Registration of format operation in RMD	242
4.20.11	Recovery from the incomplete Blank/Format operation	243
4.20.11.1	The theory of the information reporting and read/write action behavior	243
4.20.11.2	Recovery from incomplete erase operation	244
4.20.11.3	Recovery from incomplete format operation	244

4.21	Recording/reading for DVD-RW Dual Layer media.....	245
4.21.1	The basics for DVD-RW Dual Layer media.....	245
4.21.1.1	Abbreviations for this section.....	246
4.21.2	Physical disc structure.....	246
4.21.2.1	Physical disc state.....	246
4.21.2.2	State of DVD-RW DL disc for interchange	248
4.21.2.3	RZone for DVD-RW DL media	249
4.21.2.4	Intermediate Marker	250
4.21.2.5	Recording mode for DVD-RW DL media	251
4.21.2.6	Recorded state of a block	252
4.21.2.7	Structure of the Complete state media.....	253
4.21.2.8	Middle Area setting	255
4.21.3	Logical disc structure	255
4.21.3.1	Associated Profile and Feature	255
4.21.3.2	Logical Disc status	257
4.21.3.3	Implicit format operation.....	257
4.21.3.4	RZone conditions.....	259
4.21.4	Recording mode	260
4.21.4.1	RROW recording mode.....	260
4.21.4.2	LJRROW recording mode.....	260
4.21.5	Command response on each RZone condition.....	265
4.21.6	RMA structure.....	270
4.21.7	RMD contents for DVD-RW DL media	270
4.21.7.1	RMD - Field0 (RMD Header)	270
4.21.7.2	Format 2 RMD Field1	274
4.21.7.3	Format 2 RMD Field2 to Field14.....	274
4.21.7.4	Format 3 RMD Field1	275
4.21.7.5	Format 3 RMD Field2	275
4.21.7.6	Format 3 RMD Field3	276
4.21.7.7	Format 3 RMD Field4 to Field12.....	278
4.21.7.8	Format 3 RMD Field13	278
4.21.7.9	Format 3 RMD Field14	279
4.21.8	Formatting	279
4.21.8.1	Faster formatting mechanism	279
4.21.8.2	Full format	280
4.21.8.3	CD-RW DVD-RW Full format	281
4.21.8.4	Quick Grow format.....	281
4.21.8.5	Grow format	284
4.21.8.6	Fast Re-format.....	285
4.21.8.7	Stop Format operation	289
4.21.9	Closing on DVD-RW DL discs.....	289
4.21.9.1	Disc closing	289
4.21.9.2	LJB closing.....	291
4.21.9.3	Stop Close operation.....	291
4.22	Recording for DVD-Download disc.....	293
4.22.1	The basics for DVD Download Disc for CSS Managed Recording	293
4.22.2	Associated Profile and Feature.....	293
4.22.3	Recording model	293
4.22.4	CPR_MAI handling	294
5.0	HD DVD model	297
5.1	HD DVD media description	297
5.1.1	HD DVD specifications	298
5.2	Track structure	298

5.3	Data segment structure	308
5.3.1	Data segment layout.....	308
5.3.2	Data configuration of Data ID field	309
5.4	Data structure of Lead-in Area	311
5.4.1	Structure of Lead-in Area.....	312
5.4.2	System Lead-in Area.....	312
5.4.2.1	Control Data Zone	312
5.4.3	Connection Area.....	317
5.4.4	Data Lead-in Area	317
5.4.4.1	Data Lead-in Area for HD DVD-ROM.....	317
5.4.4.2	Data Lead-in Area for HD DVD-RAM.....	317
5.4.4.3	Data Lead-in Area for HD DVD-R SL.....	318
5.4.4.4	Data Lead-in Area for HD DVD-R DL.....	319
5.4.4.5	Data Lead-in Area for HD DVD-RW SL.....	320
5.4.4.6	Data Lead-in Area for HD DVD-RW DL.....	323
5.5	Data structure of Lead-out Area	325
5.5.1	System Lead-out Area.....	325
5.5.2	Data Lead-out Area	325
5.5.2.1	Data Lead-out Area for HD DVD-ROM.....	325
5.5.2.2	Data Lead-out Area for HD DVD-R SL.....	325
5.5.2.3	Data Lead-out Area for HD DVD-R DL.....	326
5.5.2.4	Data Lead-out Area for HD DVD-RW SL.....	326
5.5.2.5	Data Lead-out Area for HD DVD-RW DL.....	326
5.5.2.6	Data Lead-out Area for HD DVD-RAM.....	326
5.6	HD DVD READY condition/NOT READY condition.....	327
5.7	Error reporting	327
5.8	Removable medium	328
5.9	Logical blocks.....	328
5.10	Data cache.....	329
5.11	Seek.....	329
5.12	Difference between HD DVD and DVD	329
5.12.1	HD DVD-ROM vs. DVD-ROM	329
5.12.2	HD DVD-R vs. DVD-R	330
5.12.3	HD DVD-RAM vs. DVD-RAM	330

5.13	Recording for HD DVD-R Single Layer media	333
5.13.1	Basics for HD DVD-R vs. DVD-R	333
5.13.2	HD DVD-R media Structure	333
5.13.2.1	RMZ (Recording Management Zone)	333
5.13.2.2	Border zone	343
5.13.2.3	User Data Zone	345
5.13.2.4	Additional Zones for the disc finalization	346
5.13.3	Recording model for HD DVD-R media	346
5.13.3.1	Sequential recording	347
5.13.4	Data recording	347
5.13.4.1	ECC boundary padding and Data Type bit in ID field	347
5.13.5	RZone recording	348
5.13.5.1	RZone reservation	348
5.13.5.2	RZone closing	350
5.13.6	Border zone recording	350
5.13.7	RMZ extension	352
5.13.7.1	RMZ Extension scheme	352
5.13.7.2	Extended RMZ numbering	353
5.13.7.3	RMZ Extension by B-RMZ	353
5.13.7.4	RMZ Extension by U-RMZ	353
5.13.7.5	Sample sequence for RMZ extension by U-RMZ	354
5.13.8	Test Zone extension	354
5.13.9	Optimum Power Calibration (OPC)	355
5.13.10	Disc Final Closure	356
5.13.11	Example for multi-border recognition	359
5.13.12	Error reporting for RMZ exhaustion	360
5.13.12.1	Error reporting for WRITE (10) command and WRITE (12) command	360
5.13.12.2	Error reporting for SYNCHRONIZE CACHE (10) command	361
5.13.12.3	Error reporting for “RZone reservation” by using RESERVE TRACK command	361
5.13.12.4	Error reporting for “RZone closure” by using CLOSE TRACK/SESSION command	362
5.13.12.5	Error reporting for “RMZ extension by U-RMZ” by using RESERVE TRACK command	362
5.13.12.6	Error reporting for “Border closure” by using CLOSE TRACK/SESSION command	363
5.13.12.7	Error reporting for “finalization” by using CLOSE TRACK/SESSION command	364
5.13.12.8	Error reporting for “Test Zone extension” by using FORMAT UNIT command	364
5.13.12.9	Error reporting for SEND OPC INFORMATION command	365
5.14	Recording for HD DVD-R Dual Layer media	367
5.14.1	Profile and Feature	367
5.14.2	Restriction for recording	367
5.14.2.1	Preparation for recording L1	367
5.14.2.2	Middle Area expansion	368
5.14.2.3	RZone reservation	372
5.14.3	Disc Final Closure	374
5.14.3.1	Disc Final Closure Suspension and Restart	376
5.14.4	Example of write sequence	378
5.14.5	RMD (Recording Management Data)	380
5.14.5.1	The contents of RMD	380
5.14.5.2	RMD Field 0 (RMD Header)	380
5.14.5.3	RMD Field 1	384
5.14.5.4	RMD Field 2	386
5.14.5.5	RMD Field 3	386
5.14.5.6	RMD Field 4	386
5.14.5.7	RMD Field 5 - Field 21	387
5.14.5.8	Update timing of RMD in RMZ	388

5.15	Recording for HD DVD-RW Single Layer media	391
5.15.1	Recording mode	391
5.15.1.1	Sequential formatting mode	391
5.15.1.2	Fragment recording mode.....	391
5.15.2	Disc state	391
5.15.2.1	Empty state	391
5.15.2.2	Intermediate state in Sequential formatting mode.....	391
5.15.2.3	Finalized state in Sequential formatting mode	392
5.15.2.4	Intermediate state in Fragment recording mode.....	393
5.15.2.5	Full-finalized state	393
5.15.2.6	Disc state transition	394
5.15.3	ECC block pair status bit map.....	395
5.15.4	Data writing and reading.....	395
5.15.4.1	Data writing and reading on an Intermediate state in Sequential formatting mode	395
5.15.4.2	Data writing and reading on an Intermediate state in Fragment recording mode	395
5.15.4.3	Restriction of writing.....	395
5.15.5	Formatting	396
5.15.5.1	Full format	396
5.15.5.2	HD DVD-RW Full format.....	396
5.15.5.3	Grow format	396
5.15.5.4	Quick format.....	396
5.15.5.5	Quick Grow format.....	396
5.15.5.6	Fragment recording format.....	396
5.15.5.7	Formatting Stop	397
5.15.6	Disc closure.....	399
5.15.6.1	Finalization in Sequential formatting mode	399
5.15.6.2	Full-finalization	400
5.15.6.3	Disc closure stop.....	400
5.15.7	Blanking	402
5.15.7.1	Blank the disc (Full blank)	402
5.15.7.2	Minimally blank the disc	402
5.15.7.3	Blanking stop.....	402
5.15.8	Reported data for each disc state.....	402
5.15.9	RMD (Recording Management Data).....	406
5.15.9.1	The contents of RMD	406
5.15.9.2	RMD Field 0 (RMD Header)	406
5.15.9.3	RMD Field 1	409
5.15.9.4	RMD Field 2.....	411
5.15.9.5	RMD Field 3.....	411
5.15.9.6	RMD Field 4.....	412
5.15.9.7	RMD Field 5.....	413
5.15.9.8	RMD Field 6.....	414
5.15.9.9	RMD Field 7 ~ Field 13	415
5.15.10	Reading/recording of RMD.....	416
5.15.10.1	RMD recording in RDZ.....	416
5.15.10.2	RMD recording in L-RMZ	416
5.15.10.3	RMD read sequence	416

5.16	Recording for HD DVD-RW Dual Layer media	417
5.16.1	Recording mode	417
5.16.1.1	Sequential formatting mode	417
5.16.2	Disc state	417
5.16.2.1	Empty state	417
5.16.2.2	Intermediate state in Sequential formatting mode	417
5.16.2.3	Finalized state in Sequential formatting mode	418
5.16.2.4	Full-finalized state	420
5.16.2.5	Disc state transition	421
5.16.3	ECC block pair status bit map	421
5.16.4	Data writing and reading	422
5.16.4.1	Data writing and reading on an Intermediate state in Sequential formatting mode	422
5.16.4.2	Restriction of writing	422
5.16.5	Formatting	422
5.16.5.1	Full format	423
5.16.5.2	HD DVD-RW Full format	423
5.16.5.3	Grow format	423
5.16.5.4	Quick format	423
5.16.5.5	Quick Grow format	423
5.16.5.6	Formatting Stop	423
5.16.6	Middle Area location change	426
5.16.7	Disc closure	426
5.16.7.1	Finalization in Sequential formatting mode	426
5.16.7.2	Full-finalization	426
5.16.7.3	Disc closure stop	427
5.16.8	Blanking	429
5.16.8.1	Blank the disc (Full blank)	429
5.16.8.2	Minimally blank the disc	429
5.16.8.3	Erasing stop	429
5.16.9	RMD (Recording Management Data)	430
5.16.9.1	The contents of RMD	430
5.16.9.2	RMD Field 0 (RMD Header)	430
5.16.9.3	RMD Field 1	434
5.16.9.4	RMD Field 2	437
5.16.9.5	RMD Field 3	437
5.16.9.6	RMD Field 4	438
5.16.9.7	RMD Field 5	438
5.16.9.8	RMD Field 6	439
5.16.9.9	RMD Field 7 ~ Field 12	440
5.16.9.10	RMD Field 13	440
5.16.9.11	RMD Field 14 ~ Field 19	441
5.16.10	Reading/recording of RMD	442
5.16.10.1	RMD recording in RDZ	442
5.16.10.2	RMD recording in L-RMZ	442
5.16.10.3	RMD read sequence	442

5.17	Recording and reading for HD DVD-RAM media.....	443
5.17.1	Logical layout of HD DVD-RAM media.....	443
5.17.2	Supplementary Spare Area.....	444
5.17.3	Unrecorded ECC blocks.....	447
5.17.4	Read Modify Write	447
5.17.5	Data ID	448
5.17.6	Defect management for HD DVD-RAM media	448
5.17.7	DMA information.....	450
5.17.8	Scheduling of Linear Replacement	452
5.17.9	Formatting	452
5.17.9.1	Formatting Type 1 - Slow Initialization	453
5.17.9.2	Formatting Type 2 - Quick Improvement	453
5.17.9.3	Formatting Type 4 - Quick Clearing	454
5.17.10	Interruption of formatting	454
5.17.11	Cartridge and Disc Type	455
5.17.12	Write protection of a disc.....	455
5.17.12.1	Write-inhibit hole	455
5.17.12.2	Sensor hole A1	455
6.0	Hybrid disc model.....	457
6.1	Background.....	457
6.2	Physical and logical structure of the Hybrid disc	457
6.3	Format-layer selection mechanism using the START STOP UNIT command.....	458
7.0	AACS content protection	461
7.1	AACS Authentication process	462
7.2	AACS Bus Encryption.....	465
8.0	SecurDisc content protection	467
8.1	System description.....	467
8.2	SecurDisc Authentication process	468
9.0	Real-Time Stream recording/playback model	471
9.1	Stream recording operation.....	471
9.2	Stream playback operation	472
9.3	Error handling during Stream recording/playback operation	473
9.3.1	Error handling with Hardware defect management	473
9.3.2	Error handling with Logical unit assisted software defect management	474
9.3.3	Fatal error recovery model with Group 3 timeout	474
9.3.4	Recovery from fatal error of streaming.....	475
9.3.5	RW media specific matters	476
10.0	Logical unit assisted software defect management model.....	477
10.1	Basic actions for defect management	477
10.2	Defect management modes.....	477
10.2.1	Persistent defect management (Persistent-DM) mode	477
10.2.2	Distributed real-time defect management (DRT-DM) mode.....	477
10.3	Enhanced defect reporting	478
10.3.1	Standard playback model for DVD-RW media	478
10.3.2	Four types of defect level.....	478
10.3.3	Error reporting control	479
10.3.4	DBI memory management	482
10.3.4.1	Simple DBI memory model.....	482
10.3.4.2	Large DBI buffer memory model.....	482
10.3.4.3	Small DBI cache memory model	482
10.4	Implicit synchronize cache	484

10.5	Persistent-DM mode behavior	484
10.5.1	RECOVERED ERROR reporting control for Persistent-DM mode.....	485
10.5.2	Recommend host sequence of Persistent-DM mode.....	486
10.6	DRT-DM mode behavior.....	486
10.6.1	Defect Level Transition model.....	487
10.6.2	Certification.....	487
10.6.3	Detecting the use of a defective block	487
10.6.4	Management of defective block	488
10.6.5	Delayed replacement of data on defective block	488
10.6.6	RECOVERED ERROR reporting control for DRT-DM mode	488
10.7	Host recovery action recommendation	489
11.0	Changer Model.....	491
11.1	Sidedness	491
11.1.1	Side Changing Only logical unit	492
11.1.2	Error conditions for Sided Discs	492
11.2	Initialization.....	492
11.3	Changer Addressing.....	493
11.4	Automatic Load and Unload Operations	493
11.5	Delayed Disc load operation.....	493
11.6	PREVENT ALLOW MEDIUM REMOVAL processing	495
11.7	Error Reporting.....	495
12.0	Write protection model	497
12.1	Consideration for compatibility with other device type	497
12.2	Write Protect Feature and related commands.....	497
12.3	Error reporting	498
12.4	Event reporting	498
12.5	Persistent Write Protection exception.....	498
13.0	Power management model	499
13.1	Power state transitions	500
13.1.1	State diagram.....	501
13.1.2	Timers	503
13.1.2.1	STANDBY CONDITION TIMER.....	503
13.1.3	Power management status reporting	505
13.2	Interface Power management timer adjustment	505
14.0	Timeout and Reset models	507
14.1	Timeouts	507
14.1.1	Group 3 timeout for Real Time Stream recording/playback.....	509
14.1.2	Trace time for requested sectors	510
14.1.3	Exception 1: Time for the initial OPC	510
14.1.4	Exception 2: Synchronize cache time	510
14.1.5	Exception 3: Power state transition time to Active state.....	511
14.1.6	Relationship between Group 3 time unit and Unit length.....	511
14.1.7	Recommended Timeout value handling.....	512
14.2	Reset model	512
14.2.1	Power On Reset.....	512
14.2.2	Hard Reset.....	512
14.2.3	Device Reset.....	512
14.2.4	Mapping of reset functions.....	512

15.0	Features	515
15.1	Implementation of Features	516
15.1.1	What's a Feature?.....	516
15.1.2	History	516
15.1.3	Implementation of Features.....	517
15.1.4	Compatibility.....	517
15.1.5	Summary	517
15.2	Morphing commands and functionality.....	518
15.2.1	Morphing operation.....	520
15.2.2	Morphing compatibility considerations	521
15.3	Vendor Unique.....	522
15.4	Delayed Feature reporting	522
16.0	Profiles	525
16.1	Profile 0001h: Obsolete (Non-removable disk).....	525
16.2	Profile 0002h: Removable disk	525
16.3	Profile 0003h: Obsolete (MO Erasable)	525
16.4	Profile 0004h: Obsolete (MO Write Once)	525
16.5	Profile 0005h: Obsolete (AS-MO).....	525
16.6	Profile 0008h: CD-ROM	526
16.7	Profile 0009h: CD-R.....	526
16.8	Profile 000Ah: CD-RW	526
16.9	Profile 0010h: DVD-ROM	527
16.10	Profile 0011h: DVD-R Sequential recording	527
16.11	Profile 0012h: DVD-RAM	528
16.12	Profile 0013h: DVD-RW Restricted Overwrite	528
16.13	Profile 0014h: DVD-RW Sequential recording.....	529
16.14	Profile 0015h: DVD-R Dual Layer Sequential recording	529
16.15	Profile 0016h: DVD-R Dual Layer Jump recording.....	530
16.16	Profile 0017h: DVD-RW Dual Layer.....	531
16.17	Profile 0018h: DVD-Download disc recording.....	532
16.18	Profile 0050h: HD DVD-ROM	532
16.19	Profile 0051h: HD DVD-R.....	533
16.20	Profile 0052h: HD DVD-RAM	533
16.21	Profile 0053h: HD DVD-RW	534
16.22	Profile 0058h: HD DVD-R Dual Layer.....	534
16.23	Profile 005Ah: HD DVD-RW Dual Layer	535
16.24	Profile FFFFh: Logical units Not Conforming to a Standard Profile.....	535
17.0	Packet commands.....	537
17.1	BLANK command	539
17.2	CLOSE TRACK/SESSION command.....	543

17.3	FORMAT UNIT command.....	549
17.3.1	Formatting on Format Type = 00h (Full Format)	552
17.3.2	Formatting on Format Type = 01h (Spare Area Expansion).....	553
17.3.3	Formatting on Format Type = 04h (Obsolete)	553
17.3.4	Formatting on Format Type = 05h (Obsolete)	553
17.3.5	Formatting on Format Type = 10h (-RW Full Format).....	553
17.3.6	Formatting on Format Type = 11h (Grow Session)	553
17.3.7	Formatting on Format Type = 12h (Obsolete)	554
17.3.8	Formatting on Format Type = 13h (Quick Grow Session)	554
17.3.9	Formatting on Format Type = 14h (Obsolete)	555
17.3.10	Formatting on Format Type = 15h (Quick Format)	555
17.3.11	Formatting on Format Type = 16h (Test Zone Expansion)	555
17.3.12	Formatting on Format Type = 17h (Instant Recording Setup for L1).....	555
17.3.13	Formatting on Format Type = 18h (Fast Re-format)	556
17.3.14	Formatting on Format Type = 19h (Fragment recording Format)	556
17.3.15	Formatting on Format Type = 20h (Obsolete)	556
17.3.16	Formatting on Format Type = 24h (MRW Format).....	556
17.3.17	Formatting on Format Type = 26h (DVD+RW Basic Format).....	556
17.3.18	Formatting on Format Type = 30h (BD-RE Format with Spare Areas)	556
17.3.19	Formatting on Format Type = 31h (BD-RE Format without Spare Areas)	556
17.3.20	Formatting on Format Type = 32h (BD-R Format with Spare Areas).....	556

17.4	GET CONFIGURATION command	559
17.4.1	GET CONFIGURATION response data	560
17.4.2	Features	561
17.4.2.1	Feature 0000h: Profile List.....	564
17.4.2.2	Feature 0001h: Core	567
17.4.2.3	Feature 0002h: Morphing.....	569
17.4.2.4	Feature 0003h: Removable Medium	570
17.4.2.5	Feature 0004h: Write Protect.....	572
17.4.2.6	Feature 0010h: Random Readable.....	573
17.4.2.7	Feature 001Dh: MultiRead	575
17.4.2.8	Feature 001Eh: CD Read.....	576
17.4.2.9	Feature 001Fh: DVD Read.....	577
17.4.2.10	Feature 0020h: Random Writable	578
17.4.2.11	Feature 0021h: Incremental Streaming Writable	579
17.4.2.12	Feature 0022h: Obsolete (Sector Erasable)	583
17.4.2.13	Feature 0023h: Formattable.....	583
17.4.2.14	Feature 0024h: Hardware Defect Management.....	584
17.4.2.15	Feature 0025h: Write Once	585
17.4.2.16	Feature 0026h: Restricted Overwrite.....	586
17.4.2.17	Feature 0027h: CD-RW CAV Write	588
17.4.2.18	Feature 0028h: MRW	589
17.4.2.19	Feature 0029h: Enhanced Defect Reporting.....	589
17.4.2.20	Feature 002Ah: DVD+RW	591
17.4.2.21	Feature 002Bh: DVD+R.....	591
17.4.2.22	Feature 002Ch: Rigid Restricted Overwrite	591
17.4.2.23	Feature 002Dh: CD Track at Once.....	593
17.4.2.24	Feature 002Eh: CD Mastering.....	596
17.4.2.25	Feature 002Fh: DVD-R/-RW Write	598
17.4.2.26	Feature 0033h: Layer Jump recording.....	600
17.4.2.27	Feature 0034h: LJ Rigid Restricted Overwrite.....	603
17.4.2.28	Feature 0035h: Stop Long Operation	604
17.4.2.29	Feature 0037h: CD-RW Media Write Support.....	605
17.4.2.30	Feature 0038h: BD-R Pseudo Overwrite Feature.....	605
17.4.2.31	Feature 003Ah: DVD+RW Dual Layer.....	605
17.4.2.32	Feature 003Bh: DVD+R Dual Layer.....	605
17.4.2.33	Feature 0040h: BD Read	605
17.4.2.34	Feature 0041h: BD Write	605
17.4.2.35	Feature 0042h: TSR.....	606
17.4.2.36	Feature 0050h: HD DVD Read	606
17.4.2.37	Feature 0051h: HD DVD Write	607
17.4.2.38	Feature 0052h: HD DVD-RW Fragment Recording.....	611
17.4.2.39	Feature 0080h: Hybrid disc	611
17.4.2.40	Feature 0100h: Power Management	612
17.4.2.41	Feature 0101h: S.M.A.R.T.	613
17.4.2.42	Feature 0102h: Embedded Changer	614
17.4.2.43	Feature 0103h: CD Audio analog play	615
17.4.2.44	Feature 0104h: Microcode Upgrade	617
17.4.2.45	Feature 0105h: Timeout	618
17.4.2.46	Feature 0106h: DVD CSS	619
17.4.2.47	Feature 0107h: Real-Time Streaming	620
17.4.2.48	Feature 0108h: Logical unit Serial Number	622
17.4.2.49	Feature 0109h: Media Serial Number	622
17.4.2.50	Feature 010Ah: Disc Control Blocks	622
17.4.2.51	Feature 010Bh: DVD CPRM.....	622

17.4.2.52	Feature 010Ch: Firmware Information.....	623
17.4.2.53	Feature 010Dh: AACs	625
17.4.2.54	Feature 010Eh: DVD CSS Managed recording.....	626
17.4.2.55	Feature 0110h: VCPS	627
17.4.2.56	Feature 0113h: SecurDisc.....	627
17.5	GET EVENT/STATUS NOTIFICATION command.....	629
17.5.1	Operational Change Request/Notification Class Events.....	631
17.5.2	Power Management Class Events	632
17.5.3	External Request Class Events.....	633
17.5.4	Media Class Events	635
17.5.5	Multi-host Class Events	636
17.5.6	Device Busy Class Events.....	638
17.6	GET PERFORMANCE command.....	643
17.6.1	Performance (Type field = 00h).....	643
17.6.2	Unusable Area Data (Type field = 01h).....	646
17.6.3	Defect Status Data (Type field = 02h)	647
17.6.4	Write Speed (Type field = 03h)	649
17.6.5	DBI (Type field = 04h)	651
17.6.6	DBI cache zone (Type field = 05h).....	653
17.7	INQUIRY command	655
17.7.1	Standard INQUIRY Data	655
17.7.2	Using the INQUIRY command.....	659
17.8	LOAD/UNLOAD MEDIUM command	661
17.9	MECHANISM STATUS command.....	663
17.10	MODE SELECT (10) command.....	667
17.11	MODE SENSE (10) command	669
17.11.1	Page Control.....	669
17.11.1.1	Current Values.....	670
17.11.1.2	Changeable Values	670
17.11.1.3	Default Values	670
17.11.1.4	Saved Values	670
17.11.2	Initial Responses	671
17.11.3	Mode Select/Sense Parameters	671
17.11.3.1	Read-Write Error Recovery mode page	673
17.11.3.2	CD Audio Control mode page.....	680
17.11.3.3	Power Condition mode page	681
17.11.3.4	Informational Exceptions Control mode page.....	683
17.11.3.5	Timeout and Protect mode page.....	685
17.11.3.6	C/DVD Capabilities and Mechanical Status mode page.....	686
17.11.3.7	Write Parameters mode page.....	691
17.12	PAUSE/RESUME command	697
17.13	PLAY AUDIO (10) command	699
17.13.1	PLAY AUDIO (10) with Immediate Packet commands.....	700
17.14	PLAY AUDIO MSF command.....	703
17.15	PREVENT ALLOW MEDIUM REMOVAL command	705
17.16	READ (10) command.....	707
17.17	READ (12) command.....	709
17.18	READ BUFFER command	711
17.18.1	Combined header and data mode (00000b)	711
17.18.2	Vendor-specific mode (00001b)	712
17.18.3	Data mode (00010b).....	712
17.18.4	Descriptor mode (00011b)	712
17.19	READ BUFFER CAPACITY command.....	715
17.20	READ CAPACITY command	717

17.21	READ CD command.....	719
17.21.0.1	Description of Sub-channels R-W	726
17.22	READ CD MSF command.....	729
17.23	READ DISC INFORMATION command	731
17.23.1	Disc Information Block data	732
17.23.2	Track Resources Information	737
17.24	READ DISC STRUCTURE command.....	741
17.24.1	Physical Format Information (Format Code = 00h).....	745
17.24.2	DVD Copyright Information (Format Code = 01h).....	747
17.24.3	DISC KEY (Format Code = 02h).....	747
17.24.4	BCA (Format Code = 03h).....	748
17.24.5	Disc Manufacturing Information (Format Code = 04h).....	749
17.24.6	Copyright Management Information (Format Code = 05h).....	749
17.24.7	Media Identifier (Format Code = 06h).....	750
17.24.8	Media Key Block (Format Code = 07h)	751
17.24.9	Disc Definition Structure (DDS) (Format Code = 08h).....	751
17.24.10	DVD-RAM/HD DVD-RAM Medium Status Information (Format Code = 09h)	752
17.24.11	Spare Area Information (Format Code = 0Ah).....	754
17.24.12	Recording Type Information (Format Code = 0Bh)	755
17.24.13	RMD in the last Border-out (Format Code = 0Ch).....	756
17.24.14	Recording Management Area Data (Format Code = 0Dh)	756
17.24.15	Pre-recorded Information in Lead-in (Format Code = 0Eh)	757
17.24.16	Unique Disc Identifier (Format Code = 0Fh).....	757
17.24.17	Physical Format Information of Control Data Zone in the Lead-in (Format Code = 10h).....	758
17.24.18	HD DVD Copyright Protection Information (Format Code = 12h).....	759
17.24.19	Copyright data section (Format Code = 15h).....	759
17.24.20	HD DVD-R/-RW Medium Status information (Format Code = 19h)	760
17.24.21	Last recorded RMD in the latest RMZ (Format Code = 1Ah).....	760
17.24.22	Layer Boundary Information (Format Code = 20h).....	761
17.24.23	Shifted Middle Area Start Address (Format Code = 21h)	762
17.24.24	Jump Interval size (Format Code = 22h).....	762
17.24.25	Manual Layer Jump Address (Format Code = 23h).....	763
17.24.26	Remapping Address (Format Code = 24h)	763
17.24.27	Volume Identifier of AACCS (Format Code = 80h)	764
17.24.28	Pre-recorded Media Serial Number of AACCS (Format Code = 81h).....	765
17.24.29	Media Identifier of AACCS (Format Code = 82h).....	765
17.24.30	Media Key Block of AACCS (Format Code = 83h)	766
17.24.31	Data Keys of AACCS (Format Code = 84h)	766
17.24.32	LBA Extents for Bus Encryption flag of AACCS (Format Code = 85h)	767
17.24.33	Media Key Block of CPRM (Format Code = 86h).....	768
17.24.34	Hybrid disc structure (Format Code = 90h)	769
17.24.35	Write Protection Status (Format Code = C0h).....	770
17.24.36	DISC Structure List (Format Code = FFh)	770
17.25	READ FORMAT CAPACITIES command	773
17.26	READ SUBCHANNEL command	779
17.26.1	CD Current Position Data Format.....	780
17.26.2	Media Catalogue Number Data Format	781
17.26.3	Track International Standard Recording Code Data Format.....	783
17.26.4	Caching of Sub-Channel Data.....	785

17.27	READ TOC/PMA/ATIP command	787
17.27.1	READ TOC/PMA/ATIP Format 0h.....	789
17.27.2	READ TOC/PMA/ATIP Format 1h.....	790
17.27.3	READ TOC/PMA/ATIP Format 2h.....	791
17.27.4	READ TOC/PMA/ATIP Format 3h.....	793
17.27.5	READ TOC/PMA/ATIP Format 4h.....	794
17.27.6	READ TOC/PMA/ATIP Format 5h.....	795
17.27.7	Sub-channel Q information	796
17.27.8	Example READ TOC/PMA/ATIP Operations	797
17.27.9	Fabrication of TOC information for DVD/HD DVD media.....	798
17.27.9.1	Conversion of addresses on DVD/HD DVD media to CD MSF addressing	798
17.27.9.2	Conversion of DVD/HD DVD track to CD track information.....	799
17.27.9.3	Example Fabricated Data for DVD/HD DVD media.....	799
17.28	READ TRACK INFORMATION command.....	801
17.29	REPAIR RZONE command.....	815
17.30	REPORT KEY command.....	817
17.30.1	REPORT KEY command for DVD CSS/CPPM or CPRM (Key Class = 00h).....	817
17.30.1.1	REPORT KEY data format for DVD CSS/CPPM, or CPRM (Key Class = 00h)	818
17.30.2	REPORT KEY command for AACS (Key Class = 02h).....	823
17.30.2.1	REPORT KEY data format for AACS (Key Class = 02h).....	825
17.30.3	REPORT KEY command for SecurDisc (Key Class = 21h)	828
17.30.3.1	REPORT KEY data format for SecurDisc (Key Class = 21h).....	829
17.31	REQUEST SENSE command.....	833
17.31.1	Sense-key Specific	835
17.31.2	Deferred Errors.....	836
17.31.3	Sense-key and Sense Code Definitions.....	838
17.31.4	Using the REQUEST SENSE command	838
17.32	RESERVE TRACK command.....	839
17.32.1	Size Mode reservation.....	839
17.32.2	Address Mode reservation.....	842
17.33	SCAN command	845
17.34	SEEK command	849
17.35	SEND CUE SHEET command	851
17.35.1	CUE SHEET FORMAT.....	851
17.35.2	Information of the absolute disc location.....	852
17.35.2.1	Control/Address Field	853
17.35.2.2	CTL Field (upper 4 bits).....	853
17.35.2.3	ADR Field (lower 4 bits).....	853
17.35.2.4	TNO.....	854
17.35.2.5	INDEX Field	854
17.35.2.6	DATA FORM.....	854
17.35.2.7	SCMS (Serial Copy Management System)	854
17.35.2.8	DATA FORM OF MAIN DATA.....	854
17.35.2.9	CD-DA Data Form	854
17.35.2.10	CD-ROM mode 1 Form.....	855
17.35.2.11	CD-ROM XA, CD-I Form	855
17.35.2.12	CD-ROM mode 2	856
17.35.3	Data Form of Sub-Channel	856
17.35.4	Absolute Time.....	857
17.35.5	Session Format	857
17.35.6	Pre-gap	857
17.35.7	Post-gap.....	857
17.35.8	Catalog Number	857
17.35.9	ISRC.....	858

17.36	SEND DISC STRUCTURE command	859
17.36.1	User Specific Data (Format Code = 04h).....	861
17.36.2	Copyright Management Information (Format Code = 05h).....	861
17.36.3	Timestamp (Format Code = 0Fh).....	862
17.36.4	Scramble Content Allocation information (Format Code = 17h)	863
17.36.5	Layer Boundary Information (Format Code = 20h).....	864
17.36.6	Shifted Middle Area Start Address (Format Code = 21h)	866
17.36.7	Jump Interval size (Format Code = 22h).....	867
17.36.8	Manual Layer Jump Address (Format Code = 23h).....	868
17.36.9	Remapping Address (Format Code = 24h)	869
17.36.10	Write Data Key of AACS (Format Code = 84h).....	869
17.36.11	LBA Extents for Bus Encryption flag of AACS (Format Code = 85h)	870
17.36.12	Write Protection (Format Code = C0h).....	871
17.37	SEND EVENT command.....	873
17.38	SEND KEY command	875
17.38.1	SEND KEY command for DVD CSS/CPPM or CPRM (Key Class = 00h)	875
17.38.1.1	SEND KEY data format for DVD CSS/CPPM, or CPRM (Key Class = 00h)	876
17.38.2	SEND KEY command for AACS (Key Class = 02h).....	878
17.38.2.1	SEND KEY data format for AACS (Key Class = 02h).....	879
17.38.3	SEND KEY command for SecurDisc (Key Class = 21h)	880
17.38.3.1	SEND KEY data format for SecurDisc (Key Class = 21h).....	881
17.39	SEND OPC INFORMATION command.....	883
17.40	SET CD SPEED command	885
17.41	SET READ AHEAD command	887
17.42	SET STREAMING command.....	889
17.42.1	Performance descriptor.....	889
17.42.2	DBI cache zone Descriptor.....	892
17.43	START STOP UNIT command	895
17.43.1	Online Format-layer change.....	897
17.44	STOP PLAY/SCAN command	899
17.45	SYNCHRONIZE CACHE (10) command.....	901
17.46	TEST UNIT READY command	903
17.46.1	Using the TEST UNIT READY command.....	903
17.47	VERIFY (10) command	905
17.48	WRITE (10) command.....	907
17.49	WRITE (12) command.....	911
17.50	WRITE AND VERIFY (10) command.....	913
17.51	WRITE BUFFER command	915
17.51.1	Combined header and data mode (00000b)	916
17.51.2	Vendor-specific mode (00001b)	916
17.51.3	Data mode (00010b).....	916
17.51.4	Download microcode mode (00100b).....	916
17.51.5	Download microcode and save mode (00101b).....	916
17.51.6	Download microcode with offsets (00110b).....	917
17.51.7	Download microcode with offsets and save mode (00111b)	917
Appendix A - Error Reporting and Sense Codes (Normative)		919
A-1	Error Reporting	919
A-1.1	Deferred Error Reporting.....	919
A-1.2	Error Tables	919

Appendix B - ATAPI Implementation Notes (Normative)	941
B-1 Introduction	941
B-2 ATA Signal Utilization	941
B-3 ATA command Utilization.....	941
B-4 ATA Compatibility	941
B-5 Packet Types	941
B-6 How SCSI is Used by ATAPI.....	941
B-6.1 Differences from the SCSI Standard	942
B-6.2 Reset Usage	942
B-6.3 Power On Reset	942
B-6.4 Hard Reset	942
B-6.5 Device Reset	943
B-6.6 Function Comparison Table	943
B-6.7 Redundant command functionality (Task File vs. Packet).....	943
B-6.8 ATAPI Device Reset	944
B-6.9 Execute Drive Diagnostics	944
B-6.10 ATAPI Identify Device.....	944
B-7 Command Packet Description.....	944
B-7.1 Operation Code.....	945
B-7.2 Logical Block Address	946
B-7.3 Transfer Length	946
B-7.4 Parameter List Length.....	946
B-7.5 Allocation Length	946
B-8 Status	946
B-9 Immediate command processing considerations.....	946
B-10 Command processing considerations and exception conditions.....	947
B-10.1 Selection of an invalid logical unit	947
B-10.2 Parameter Rounding	947
B-11 UNIT ATTENTION condition	948
B-12 Commands and Parameters	948
B-13 SATA Asynchronous Notification.....	948
Appendix C - SCSI Implementation Notes (Normative)	953
C-1 Introduction	953
C-2 SCSI Signal Utilization.....	953
C-3 SCSI Compatibility	953
C-3.1 Use of the RelAdr bit.....	953
C-3.2 Differences from the SCSI Standard	954
C-4 Reset Functionality	954
C-4.1 Power On Reset	954
C-4.2 Hard Reset	954
C-4.3 Device Reset	955
C-4.4 Power management and Device Reset in SCSI	956

C-5	Command Utilization for a SCSI logical unit.....	956
	Appendix D - IEEE 1394 Implementation Notes (Normative)	959
D-1	Introduction.....	959
D-2	IEEE 1394 Signal Utilization.....	959
D-3	Compatibility	959
D-3.1	Use of the RelAdr bit.....	959
D-3.2	Comparison of SBP-2 and MMC-2.....	959
D-4	Reset Functionality	959
D-4.1	Power On Reset	959
D-4.2	Hard Reset	959
D-4.3	Device Reset	960
D-4.4	Power management and Device Reset in IEEE 1394.....	961
D-5	Command Utilization for a IEEE 1394 logical unit.....	961
	Appendix E - Example Event Implementation Notes (Informative)	963
E-1	Design Intent	963
E-1.1	Goals.....	963
E-1.2	Command Use	963
E-1.3	Implementation Hints	963
E-1.4	Interactions with UNIT ATTENTION	963
E-1.5	Sample Implementation of Events.....	963
	Appendix F - Command Implementation Notes (Informative)	965
F-1	READ DISC INFORMATION or READ TRACK INFORMATION command.....	965
F-1.1	Returned data for CD media.....	965
F-1.2	Returned data for DVD media.....	968
F-1.3	Returned data for HD DVD media.....	969
F-2	GET PERFORMANCE command Performance (Type field = 00h).....	971
	Appendix G - CD-Text Format in the Lead-in Area (Informative)	975
G-1	General.....	975
	Appendix H - Mt. Fuji revision history (Informative)	979
H-1	Changes from Mt. Fuji 1 to Mt. Fuji 2.....	979
H-2	Changes from Mt. Fuji 2 to Mt. Fuji 3.....	980
H-3	Changes from Mt. Fuji 3 to Mt. Fuji 4.....	982
H-4	Changes from Mt. Fuji 4 to Mt. Fuji 5.....	984
H-5	Changes from Mt. Fuji 5 to Mt. Fuji 6.....	987
H-6	Feature Descriptor version history	989
	Appendix I - Sample Applications of Events (Informative)	993
I-1	Overview.....	993
I-2	Example logical unit implementation	993
I-2.1	Operation of the PREVENT ALLOW MEDIUM REMOVAL Command.....	993
I-2.2	Operation of the GET CONFIGURATION Command.....	994
I-2.3	Operation of the GET EVENT/STATUS NOTIFICATION Command	994
I-2.4	Operation of the START STOP UNIT Command	995

I-2.5	Operation of the SEND EVENT Command	995
I-2.6	Internal functions	995
I-2.7	Summary	996
I-3	Example host implementations	997
I-3.1	Host use of the Multi-host Class.....	997
I-3.2	Host use of the Operational Change Request/Notification Class	997
I-4	Example Device Busy Class Events implementations.....	998
I-4.1	Example of Device Busy Class Events reporting	998
I-4.2	Time-unit progress indication implementation example	998
I-4.3	Intermediate steps of long operation.....	1000
Appendix J - UDF Key Structure (Informative)		1003
J-1	Introduction	1003
J-2	Read compatibility issue of AVDP and VAT ICB at end LBA.....	1004
J-3	Retrieval method of end LBA for read-only logical unit.....	1004

Table 1 -	Media types that are described in this specification.....	49
Table 2 -	Layout of the document.....	50
Table 3 -	Decimal number representation	55
Table 4 -	The list of symbols, abbreviations and acronyms	70
Table 5 -	Example mixed mode CD disc layout.....	72
Table 6 -	MSF address format	78
Table 7 -	Error conditions and Sense Keys	79
Table 8 -	Track Descriptor Block	80
Table 9 -	Track Descriptor Table.....	81
Table 10 -	Track Descriptor Unit.....	81
Table 11 -	General Parameters of DVD discs	84
Table 12 -	Data Field Number for DVD media.....	92
Table 13 -	Recording Type bit definition for DVD-RAM Ver. 2.2 media	93
Table 14 -	Data Type bit definition	93
Table 15 -	Structure of a Control Data Block.....	95
Table 16 -	Physical format information in Control Data Block	95
Table 17 -	Book Type field definition	96
Table 18 -	Compatible Part Version field definition for DVD-R media	96
Table 19 -	Compatible Part Version field definition for DVD-RW media	96
Table 20 -	Maximum Transfer Rate field definition	97
Table 21 -	Layer Type field definition	97
Table 22 -	Linear Density field definition	97
Table 23 -	Track Density field definition	97
Table 24 -	Data Area Allocation field definition.....	98
Table 25 -	DVD-ROM unique part of Physical format information	98
Table 26 -	DVD-R SL Ver. 2.1 unique part of Physical format information	99
Table 27 -	DVD-Download unique part of Physical format information.....	99
Table 28 -	Disc Identifier field definition for DVD-Download media.....	99
Table 29 -	DVD-RW SL Ver. 1.2 unique part of Physical format information	100
Table 30 -	DVD-R DL Ver. 3.0 unique part of Physical format information	101
Table 31 -	DVD-RW DL unique part of Physical format information.....	101
Table 32 -	Pre-recorded/Embossed information code field definition	102
Table 33 -	DVD-RAM Ver. 2.2 unique part of Physical format information	102
Table 34 -	Structure of an R/RW-Physical format information Block.....	103
Table 35 -	Physical format information in an R/RW-Physical format information Block.....	103
Table 36 -	Data Area Allocation field in R/RW-Physical format information Block.....	104
Table 37 -	DVD-R SL Ver. 2.1 unique part of R-Physical format information.....	104
Table 38 -	DVD-R DL Ver. 3.0 unique part of R-Physical format information	105
Table 39 -	DVD-RW SL Ver. 1.2 unique part of RW-Physical format information	105
Table 40 -	DVD-RW DL Ver. 2.0 unique part of RW-Physical format information.....	106
Table 41 -	Error conditions and Sense Keys	110
Table 42 -	List of Pack types	112
Table 43 -	Scrambled data indicators and corresponded information	112
Table 44 -	Allocation of Data Area of DVD-RAM Ver. 2.2 media (120 mm)	120
Table 45 -	Allocation of Data Area of DVD-RAM Ver. 2.2 media (80 mm)	121
Table 46 -	DDS information (Ver. 2.2)	125
Table 47 -	Disc Certification Flag format (Ver. 2.2).....	126
Table 48 -	Feature of cartridge	129
Table 49 -	2 KB linking vs. 32 KB linking.....	134
Table 50 -	RMD - Field 0.....	147
Table 51 -	RMD Format field definition	148
Table 52 -	Disc Status field definition.....	148
Table 53 -	Unique Disc ID.....	148
Table 54 -	Copy of Pre-pit Information.....	149

Table 55 -	Format 1 RMD - Field 1 (logical unit and OPC information)	150
Table 56 -	Format 1 RMD - Field 2 (User specific data)	151
Table 57 -	Format 1 RMD - Field 3 (Border Zone information).....	151
Table 58 -	Format 1 RMD - Field 4 (RZone Information)	152
Table 59 -	Format 1 RMD - Field 5 - Field 12 (RZone Information ... continued).....	153
Table 60 -	Format 1 RMD - Field 13 (Drive specific information).....	154
Table 61 -	Format 1 RMD - Field 14 (Versatile information).....	155
Table 62 -	Mandatory RMD update condition in RMA	155
Table 63 -	Example of write sequence (blank disc)	156
Table 64 -	Example of write sequence (non-blank disc)	156
Table 65 -	Border Zone size for DVD-R media	157
Table 66 -	Multi-Border example.....	160
Table 67 -	History of DVD-R media format	167
Table 68 -	Profile, Feature and Write Type value for each recording mode.....	169
Table 69 -	Comparison of recording mode.....	174
Table 70 -	Blank disc parameters and related commands in Layer Jump recording mode.....	174
Table 71 -	Reserved RZone parameters.....	175
Table 72 -	Invisible/Incomplete RZone parameters	177
Table 73 -	LBA range of user data recordable area in each LJB of Figure 75 (32 KB Link size).....	189
Table 74 -	Border Zone size for DVD-R DL media	198
Table 75 -	Anchor points (Remappable locations)	200
Table 76 -	RMD - Field 0.....	207
Table 77 -	RMD Format field definition	207
Table 78 -	Disc Status field definition.....	208
Table 79 -	Unique Disc ID.....	208
Table 80 -	Copy of Pre-pit Information for DVD-R DL disc.....	209
Table 81 -	Pre-recorded information code field definition.....	209
Table 82 -	Format 1 RMD - Field 1 (logical unit and OPC information)	210
Table 83 -	Format 1 RMD - Field 2 (User Specific Data).....	211
Table 84 -	Format 1 RMD - Field 3 (Reserved)	211
Table 85 -	Format 1 RMD - Field 4 (RZone Information)	212
Table 86 -	Format 1 RMD - Field 5 - Field 12 (RZone Information ... continued).....	213
Table 87 -	Format 1 RMD - Field 13 (Drive specific information).....	213
Table 88 -	Format 1 RMD - Field 14 (Versatile information).....	214
Table 89 -	Format 4 RMD - Field 1 (logical unit and OPC information)	215
Table 90 -	Format 4 RMD - Field 2 (User Specific Data).....	216
Table 91 -	Format 4 RMD - Field 3 (Border Zone Information).....	216
Table 92 -	Format 4 RMD - Field 4 (RZone Information)	217
Table 93 -	Format 4 RMD - Field 5-Field 12 (RZone Information ... continued).....	218
Table 94 -	Format 4 RMD - Field 13 (Drive specific information).....	219
Table 95 -	Format 4 RMD-Field 14 (Versatile information).....	220
Table 96 -	Mandatory RMD update condition in RMA	221
Table 97 -	RMD Header - Field 0.....	231
Table 98 -	RMD Format field definition	232
Table 99 -	Disc Status field definition.....	232
Table 100 -	Copy of Pre-pit Information.....	233
Table 101 -	RBG Information field definition.....	234
Table 102 -	Format 1 RMD Field 1 (logical unit and OPC information).....	234
Table 103 -	8-bit coded power definition	235
Table 104 -	Format 2 RMD Field 1 (Pointer to Format 3 RMD Set).....	235
Table 105 -	Format 2 RMD Field 2 (Erase Operation Information)	236
Table 106 -	Erase Operation Code and Erase Information fields definition	236
Table 107 -	Format 3 RMD Field 3 (Border Zone and RZone Information)	237
Table 108 -	Format Operation Code and Format Information fields definition.....	238

Table 109 - Format 3 RMD Field 4 (Defect Status Bitmap)	239
Table 110 - Format 3 RMD Field 5 - Field 12 (Defect Status Bitmap).....	239
Table 111 - Border Zone size for DVD-RW SL media.....	241
Table 112 - Information reporting in the case of the incomplete Blank operation.....	244
Table 113 - Information reporting in the case of the incomplete Format operation.....	244
Table 114 - Several parameters of DVD-RW media format	245
Table 115 - Abbreviations for this section	246
Table 116 - Difference of the termination structure between DVD-RW SL and DL.....	250
Table 117 - Discrimination of the logically recorded areas	253
Table 118 - Profile and Feature	256
Table 119 - Command handling on physical Blank state disc.....	257
Table 120 - Relation of physical disc state, logical disc status	258
Table 121 - Parameters for Contiguous condition	265
Table 122 - Parameters for LJA unspecified state of Non-contiguous condition.....	266
Table 123 - Parameters for Manual Layer Jump state of Non-contiguous condition (1).....	267
Table 124 - Parameters for Manual Layer Jump state of Non-contiguous condition (2).....	268
Table 125 - Parameters for Regular Interval state of Non-contiguous condition.....	269
Table 126 - RMD - Field0	270
Table 127 - RMD Format field definition	271
Table 128 - Disc Status field definition.....	271
Table 129 - Copy of Pre-pit Information.....	272
Table 130 - Pre-recorded/Embossed information code field definition	273
Table 131 - RBG Information field definition.....	273
Table 132 - Format 2 RMD Field1	274
Table 133 - Format3 RMD - Field1.....	275
Table 134 - Format 3 RMD Field3.....	276
Table 135 - Format Operation Code, Format Information1 and Format Information2 fields definition	276
Table 136 - The first byte of the Last recorded PSN field.....	277
Table 137 - Format 3 RMD Field4.....	278
Table 138 - Format 3 RMD Field5 - Field12	278
Table 139 - Format3 RMD - Field14.....	279
Table 140 - Comparison of DVD media format.....	293
Table 141 - Sector header value setting.....	295
Table 142 - General Parameters of HD DVD Discs.....	298
Table 143 - Data Field Number for HD DVD-RAM media.....	310
Table 144 - Recording Type bit definition for HD DVD-RAM media	310
Table 145 - Data Type bit definition	310
Table 146 - Structure of a Control data section.....	312
Table 147 - Common part of Physical Format Information	313
Table 148 - Book Type field definition	313
Table 149 - Part Version field definition.....	313
Table 150 - Maximum Transfer Rate field definition	314
Table 151 - Layer Type field definition	314
Table 152 - Linear Density field definition	314
Table 153 - Track Density field definition	315
Table 154 - Data Area Allocation field definition.....	315
Table 155 - HD DVD-ROM unique part of Physical Format Information	316
Table 156 - HD DVD-RAM/-R/-RW unique part of Physical Format Information	316
Table 157 - Structure of the R-Physical Format Information Zone.....	319
Table 158 - Data Area allocation field definition.....	319
Table 159 - Start PSN of Border Zone field definition	319
Table 160 - Structure of the R-Physical format information Zone.....	320
Table 161 - Data area allocation field definition.....	320
Table 162 - Structure of R-Physical Format Information Zone	322

Table 163 - Data Area allocation filed definition.....	322
Table 164 - Structure of the R-Physical format information.....	324
Table 165 - Data area allocation filed definition.....	324
Table 166 - Error conditions and Sense Keys	328
Table 167 - Profile for HD DVD.....	329
Table 168 - Mandatory Features for HD DVD-ROM, DVD-ROM.....	330
Table 169 - Mandatory Features for HD DVD-R, DVD-R.....	330
Table 170 - Mandatory Features for HD DVD-RAM, DVD-RAM.....	331
Table 171 - B-RMZ size for HD DVD-R media.....	334
Table 172 - RMD - Field 0.....	334
Table 173 - Disc Status field definition.....	335
Table 174 - Unique Disc ID.....	335
Table 175 - Data Area allocation.....	336
Table 176 - Renewed Data Area allocation.....	336
Table 177 - Renewal descriptor.....	336
Table 178 - RMD - Field 1 (logical unit and OPC information).....	337
Table 179 - RMD - Field 2 (User Specific Data).....	338
Table 180 - RMD - Field 3 (Border Zone Information).....	338
Table 181 - RMD - Field 4 (RZone Information).....	339
Table 182 - RMD - Field 5-Field 21 (RZone Information ... continued).....	340
Table 183 - Mandatory RMD update condition in RMZ.....	341
Table 184 - Mandatory RMD update condition in RDZ.....	341
Table 185 - Example of write sequence (blank disc).....	342
Table 186 - Example of write sequence (non-blank disc).....	343
Table 187 - Border Zone size for HD DVD-R media.....	344
Table 188 - Terminator size for HD DVD-R media.....	346
Table 189 - Error reporting for WRITE (10) command and WRITE (12) command.....	360
Table 190 - Error reporting for SYNCHRONIZE CACHE (10) command.....	361
Table 191 - Error reporting for “RZone reservation” by using RESERVE TRACK command.....	361
Table 192 - Error reporting for “RZone closure” by using CLOSE TRACK/SESSION command.....	362
Table 193 - Error reporting for “RMZ extension by U-RMZ” by using RESERVE TRACK command (1).....	362
Table 194 - Error reporting for “RMZ extension by U-RMZ” by using RESERVE TRACK command (2).....	363
Table 195 - Error reporting for “Border closure” by using CLOSE TRACK/SESSION command.....	363
Table 196 - Error reporting for “Border closure” by using CLOSE TRACK/SESSION command (2).....	363
Table 197 - Error reporting for “finalization” by using CLOSE TRACK/SESSION command.....	364
Table 198 - Error reporting for “Test Zone extension” by using FORMAT UNIT command (1).....	364
Table 199 - Error reporting for “Test Zone extension” by using FORMAT UNIT command (2).....	365
Table 200 - Error reporting for SEND OPC INFORMATION command.....	365
Table 201 - Inner/outer Guard Track Zone on L0 and Extra Guard Track Zone on L0.....	372
Table 202 - Total reduced capacity by RZone reservation.....	374
Table 203 - Profile.....	377
Table 204 - Current bit condition in Features.....	377
Table 205 - Disc Status in RMD Field 0.....	377
Table 206 - Disc Information Block data.....	377
Table 207 - Example of write sequence (blank disc).....	378
Table 208 - Example of write sequence (non-blank disc).....	378
Table 209 - Example of write sequence (finalization suspended disc).....	379
Table 210 - RMD - Field 0.....	380
Table 211 - Disc Status field definition.....	381
Table 212 - Unique Disc ID.....	381
Table 213 - Data area allocation.....	382
Table 214 - Renewed data area allocation.....	382
Table 215 - Renewal descriptor.....	382
Table 216 - Padding Status.....	383

Table 217 - Test zone allocation.....	383
Table 218 - RMD - Field 1 (logical unit & OPC information).....	384
Table 219 - Test zone usage descriptor	386
Table 220 - RMD - Field 2 (User Specific Data)	386
Table 221 - RMD - Field 4 (RZone Information).....	387
Table 222 - RMD - Field 5 - Field 21 (RZone Information ... continued)	388
Table 223 - Mandatory RMD update condition in RMZ.....	388
Table 224 - Terminator size in Sequential mode.....	392
Table 225 - Reported data for Empty state.....	402
Table 226 - Reported data for Intermediate state in Sequential formatting mode.....	403
Table 227 - Reported data for Finalized state in Sequential formatting mode.....	403
Table 228 - Reported data for Intermediate state in Fragment recording mode.....	404
Table 229 - Reported data for Full-finalized state.....	404
Table 230 - RMD - Field 0	407
Table 231 - Disc Status field definition.....	407
Table 232 - Unique Disc ID.....	408
Table 233 - Data area allocation	408
Table 234 - Padding Status field definition	409
Table 235 - Indicator of RMD initialization field definition.....	409
Table 236 - RMD set information	409
Table 237 - RMD - Field 1 (logical unit & OPC information).....	410
Table 238 - Test zone usage descriptor	411
Table 239 - RMD - Field 2 (User Specific Data)	411
Table 240 - RMD - Field 3 (Format operation information).....	412
Table 241 - Format operation code and the contents of Format information 1 to 2.....	412
Table 242 - RMD - Field 4 (RZone Information).....	412
Table 243 - RMD - Field 5 (Defect status Information).....	413
Table 244 - Defect status of RMD duplication zone	413
Table 245 - Defect status of RMD duplication zone definition.....	413
Table 246 - Defect status of RMZ	413
Table 247 - Defect status of RMZ definition.....	414
Table 248 - Defect status of R-PFI zone	414
Table 249 - Defect status of R-PFI zone definition	414
Table 250 - RMD - Field 6 (ECC block pair status information).....	414
Table 251 - Bit definition	415
Table 252 - RMD - Field 7 ~Field 13 (ECC block pair status information ... continued)	415
Table 253 - Terminator location for RZone on both L0 and L1 in Sequential formatting mode.....	418
Table 254 - Terminator location for RZone on only L0 in Sequential formatting mode	419
Table 255 - RMD - Field 0	431
Table 256 - Disc Status field definition.....	431
Table 257 - Unique Disc ID.....	432
Table 258 - Data area allocation	432
Table 259 - Renewed Data area allocation	433
Table 260 - Renewal descriptor field definition	433
Table 261 - Padding Status	433
Table 262 - Indicator of RMD initialization field definition.....	434
Table 263 - RMD set information	434
Table 264 - RMD - Field 1 (logical unit & OPC information).....	435
Table 265 - Test Zone usage descriptor.....	436
Table 266 - RMD - Field 2 (User Specific Data)	437
Table 267 - RMD - Field 3 (Format operation information).....	437
Table 268 - Format operation code and the contents of Format information 1 to 2.....	437
Table 269 - RMD - Field 4 (RZone Information).....	438
Table 270 - RMD - Field 5 (Defect status Information).....	438

Table 271 - Defect status of RMD duplication zone definition.....	439
Table 272 - Defect status of RMZ definition.....	439
Table 273 - Defect status of R-PFI Zone definition	439
Table 274 - RMD - Field 6 (ECC block pair status in Layer 0 information)	439
Table 275 - Bit definition	440
Table 276 - RMD - Field 7 ~Field 12 (ECC block pair status in Layer 0 information ... continued).....	440
Table 277 - RMD - Field 13 (ECC block pair status in Layer 1 information)	440
Table 278 - Bit definition	441
Table 279 - RMD - Field 14 ~Field 19 (ECC block pair status in L1 information ... continued).....	441
Table 280 - Recommendation default size of Spare Area	445
Table 281 - Allocation of Data Area of HD DVD-RAM Ver. 1.0 media	446
Table 282 - DDS information (Ver. 1.0)	451
Table 283 - Disc Certification Flag format (Ver. 1.0).....	452
Table 284 - Error handling on Stream recording/playback operation	473
Table 285 - Returned error code for commands under the Persistent-DM mode.....	480
Table 286 - Returned error code for READ and VERIFY commands under the DRT-DM mode	480
Table 287 - Returned error code for commands under the DRT-DM mode	480
Table 288 - Returned Deferred error code.....	481
Table 289 - DBI update for READ and VERIFY command	481
Table 290 - DBI update for WRITE and WRITE AND VERIFY command	481
Table 291 - Example of DBI cache zone image	484
Table 292 - Definition of PER bit and EMCDR field of Persistent-DM mode.....	485
Table 293 - Definition of PER bit and EMCDR field of DRT-DM mode	489
Table 294 - Delayed Load Operation by command.....	494
Table 295 - Error conditions and Sense Keys for Changer Mechanisms	495
Table 296 - Power management model states	499
Table 297 - State transition, events and status.....	503
Table 298 - Effects of host actions on timers	504
Table 299 - NOT READY error and Timeout UNIT ATTENTION reporting (by command)	508
Table 300 - Example Reset Function Mapping in ATAPI and SCSI	513
Table 301 - Mandatory Features for Removable Disks.....	525
Table 302 - Mandatory features for CD-ROM	526
Table 303 - Mandatory features for CD-R	526
Table 304 - Mandatory features for CD-RW	527
Table 305 - Mandatory Features for DVD-ROM	527
Table 306 - Mandatory Features for DVD-R Sequential recording	528
Table 307 - Mandatory Features for DVD-RAM	528
Table 308 - Mandatory Features for DVD-RW Restricted Overwrite	529
Table 309 - Mandatory Features for DVD-RW Sequential recording	529
Table 310 - Mandatory Features for DVD-R Dual Layer Sequential recording	530
Table 311 - Mandatory Features for DVD-R Layer Jump recording	530
Table 312 - Mandatory Features for DVD-RW Dual Layer.....	531
Table 313 - Mandatory Features for DVD-Download disc recording.....	532
Table 314 - Mandatory Features for HD DVD-ROM	532
Table 315 - Mandatory Features for HD DVD-R.....	533
Table 316 - Mandatory Features for HD DVD-RAM	533
Table 317 - Mandatory Features for HD DVD-RW	534
Table 318 - Mandatory Features for HD DVD-R Dual Layer.....	534
Table 319 - Mandatory Features for HD DVD-RW Dual Layer.....	535
Table 320 - Mandatory Features for logical units Not Conforming to a Standard Profile.....	535
Table 321 - Packet commands for Multi-Media logical units	537
Table 322 - BLANK Command Descriptor Block.....	539
Table 323 - Blanking Types for CD-RW	540
Table 324 - Blanking Types for DVD-RW SL.....	541

Table 325 - Blanking Types for HD DVD-RW.....	542
Table 326 - BLANK command errors.....	542
Table 327 - CLOSE TRACK/SESSION Command Descriptor Block	543
Table 328 - Close Function field definition.....	544
Table 329 - CLOSE TRACK/SESSION command errors	548
Table 330 - FORMAT UNIT Command Descriptor Block.....	549
Table 331 - DVD-RAM/HD DVD-RAM Defect List Handling	549
Table 332 - FORMAT UNIT Parameter List	550
Table 333 - Format List Header.....	550
Table 334 - Format Descriptor - From READ FORMAT CAPACITIES	552
Table 335 - FORMAT UNIT command errors.....	557
Table 336 - GET CONFIGURATION Command Descriptor Block	559
Table 337 - RT field definition	559
Table 338 - GET CONFIGURATION response data format	560
Table 339 - Feature Header	560
Table 340 - Feature List.....	561
Table 341 - Feature Descriptor generic format.....	564
Table 342 - Profile List Feature Descriptor	564
Table 343 - Profile Descriptor	565
Table 344 - Profile List.....	565
Table 345 - Core Feature Descriptor	567
Table 346 - Physical Interface Standard.....	568
Table 347 - Mandatory commands for Core Feature.....	568
Table 348 - Morphing Feature Descriptor	569
Table 349 - Mandatory commands for Morphing Feature	570
Table 350 - Removable Medium Feature Descriptor	570
Table 351 - Loading Mechanism Type.....	571
Table 352 - Mandatory commands for Removable Medium Feature.....	571
Table 353 - Write Protect Feature Descriptor.....	572
Table 354 - Mandatory commands for Write Protect Feature.....	573
Table 355 - Mandatory mode pages for Write Protect Feature	573
Table 356 - Random Readable Feature Descriptor.....	573
Table 357 - Mandatory commands for Random Readable Feature.....	574
Table 358 - Mandatory mode pages for Random Readable Feature	575
Table 359 - MultiRead Feature Descriptor	575
Table 360 - Mandatory commands for MultiRead Feature	575
Table 361 - CD Read Feature Descriptor	576
Table 362 - Mandatory commands for CD Read Feature.....	577
Table 363 - DVD Read Feature Descriptor	577
Table 364 - Mandatory commands for DVD Read Feature	578
Table 365 - Random Writable Feature Descriptor	578
Table 366 - Mandatory commands for Random Writable Feature.....	579
Table 367 - Incremental Streaming Writable Feature Descriptor	580
Table 368 - Mandatory commands for Incremental Streaming Writable Feature.....	581
Table 369 - Commands that <i>shall not</i> interrupt streaming writing	582
Table 370 - Mandatory mode pages for Incremental Streaming Writable Feature	582
Table 371 - Formattable Feature Descriptor.....	583
Table 372 - Mandatory commands for Formattable Feature	584
Table 373 - Hardware Defect Management Feature Descriptor.....	584
Table 374 - Mandatory mode pages for Hardware Defect Management Feature	585
Table 375 - Write Once Feature Descriptor	585
Table 376 - Mandatory commands for Write Once Feature.....	586
Table 377 - Mandatory mode pages for Write Once Feature	586
Table 378 - Restricted Overwrite Feature Descriptor.....	587

Table 379 - Mandatory commands for Restricted Overwrite Feature.....	587
Table 380 - Mandatory mode pages for Restricted Overwrite Feature	588
Table 381 - CD-RW CAV Write Feature Descriptor	588
Table 382 - Mandatory commands for CD-RW CAV Write Feature	588
Table 383 - Mandatory mode pages for CD-RW CAV Write Feature.....	589
Table 384 - Enhanced Defect Reporting Feature Descriptor.....	589
Table 385 - Relationship between Number of DBI cache zones field and DBI memory model type.....	590
Table 386 - Mandatory commands for Enhanced Defect Reporting Feature	590
Table 387 - Mandatory mode pages for Enhanced Defect Reporting Feature	591
Table 388 - Rigid Restricted Overwrite Feature Descriptor.....	592
Table 389 - Mandatory commands for Rigid Restricted Overwrite Feature	593
Table 390 - CD Track at Once Feature Descriptor.....	593
Table 391 - Mandatory commands for CD Track at Once Feature	594
Table 392 - Commands that <i>shall not</i> interrupt Track at Once writing	595
Table 393 - Mandatory mode pages for CD Track at Once Feature	595
Table 394 - CD Mastering Feature Descriptor	596
Table 395 - Mandatory commands for CD Mastering Feature - Raw mode	597
Table 396 - Mandatory mode pages for CD Mastering Feature - Raw mode	597
Table 397 - Mandatory commands for CD Mastering Feature - Session at Once mode.....	598
Table 398 - Mandatory mode pages for CD Mastering Feature - Session at Once mode	598
Table 399 - DVD-R/-RW Write Feature Descriptor	599
Table 400 - Mandatory commands for DVD-R/-RW Write Feature.....	599
Table 401 - Mandatory mode pages for DVD-R/-RW Write Feature.....	600
Table 402 - Layer Jump recording Feature Descriptor.....	601
Table 403 - Mandatory commands for Layer Jump recording Feature	602
Table 404 - Commands that <i>shall not</i> interrupt streaming writing	602
Table 405 - Mandatory mode pages for Layer Jump recording Feature	603
Table 406 - LJ Rigid Restricted Overwrite Feature Descriptor.....	603
Table 407 - Mandatory commands for LJ Rigid Restricted Overwrite Feature	604
Table 408 - Stop Long Operation Feature Descriptor	605
Table 409 - Mandatory commands for Stop Long Operation Feature.....	605
Table 410 - HD DVD Read Feature Descriptor	606
Table 411 - Mandatory commands for HD DVD Read Feature.....	607
Table 412 - HD DVD Write Feature Descriptor	607
Table 413 - Mandatory commands for HD DVD Write Feature - HD DVD-R SL	608
Table 414 - Mandatory commands for HD DVD Write Feature - HD DVD-R DL.....	609
Table 415 - Mandatory commands for HD DVD Write Feature - HD DVD-RAM.....	609
Table 416 - Mandatory commands for HD DVD Write Feature - HD DVD-RW SL.....	610
Table 417 - Mandatory commands for HD DVD Write Feature - HD DVD-RW DL.....	610
Table 418 - HD DVD-RW Fragment Recording Feature Descriptor.....	611
Table 419 - Hybrid disc Feature Descriptor	612
Table 420 - Mandatory commands for Hybrid disc Feature.....	612
Table 421 - Power Management Feature Descriptor	613
Table 422 - Mandatory commands for Power Management Feature	613
Table 423 - Mandatory mode pages for Power Management Feature.....	613
Table 424 - S.M.A.R.T. Feature Descriptor	614
Table 425 - Embedded Changer Feature Descriptor	615
Table 426 - Mandatory commands for Embedded Changer Feature.....	615
Table 427 - CD Audio analog play Feature Descriptor.....	616
Table 428 - Mandatory commands for CD Audio analog play Feature	616
Table 429 - Mandatory mode pages for CD Audio analog play Feature.....	617
Table 430 - Microcode Upgrade Feature Descriptor.....	617
Table 431 - Mandatory commands for Microcode Upgrade Feature	618
Table 432 - Timeout Feature Descriptor	618

Table 433 - Mandatory commands for Timeout Feature	619
Table 434 - DVD CSS Feature Descriptor	619
Table 435 - Mandatory commands for DVD CSS Feature.....	620
Table 436 - Real-Time Streaming Feature Descriptor	620
Table 437 - Mandatory commands for Real-Time Streaming Feature.....	621
Table 438 - Mandatory mode pages for Real-Time Streaming Feature	621
Table 439 - Logical unit Serial Number Feature Descriptor	622
Table 440 - DVD CPRM Feature Descriptor	623
Table 441 - Mandatory commands for DVD CPRM Feature.....	623
Table 442 - Firmware Information Feature Descriptor	624
Table 443 - AACS Feature Descriptor	625
Table 444 - Mandatory commands for AACS Feature.....	625
Table 445 - DVD CSS Managed recording Feature Descriptor	626
Table 446 - Mandatory commands for DVD CSS Managed recording Feature	627
Table 447 - SecurDisc Feature Descriptor.....	627
Table 448 - Mandatory commands for SecurDisc Feature.....	628
Table 449 - GET CONFIGURATION command errors	628
Table 450 - GET EVENT/STATUS NOTIFICATION Command Descriptor Block	629
Table 451 - Notification Class Request field definition	630
Table 452 - Notification Status List.....	631
Table 453 - Event Header.....	631
Table 454 - Notification Class field definition	631
Table 455 - Operational Change Request/Notification Class Event Descriptor.....	632
Table 456 - Operational Event field definition.....	632
Table 457 - Operation Request/Report field definition	632
Table 458 - Power Management Class Event Descriptor.....	633
Table 459 - Power Event field definition	633
Table 460 - Power Status field definition.....	633
Table 461 - External Request Class Event Descriptor.....	634
Table 462 - External Request Event field definition	634
Table 463 - External Request Status field definition.....	634
Table 464 - External Request field definition.....	635
Table 465 - Media Class Event Descriptor.....	635
Table 466 - Media Event field definition	636
Table 467 - Media Status Byte format.....	636
Table 468 - Multi-host Class Event Descriptor	637
Table 469 - Multi-host Event field definition.....	637
Table 470 - Multi-host Status codes	637
Table 471 - Multi-host Priority field definition.....	638
Table 472 - Device Busy Class Event Descriptor	638
Table 473 - Device Busy Event field definition	638
Table 474 - Device Busy Status field definition.....	639
Table 475 - GET EVENT/STATUS NOTIFICATION command errors	640
Table 476 - GET PERFORMANCE Command Descriptor Block	643
Table 477 - Type field values description	643
Table 478 - Performance Result Data.....	644
Table 479 - Performance Header.....	644
Table 480 - Performance Descriptor - Nominal Performance.....	645
Table 481 - Performance Descriptor - Exceptions	646
Table 482 - Unusable Area Type values.....	646
Table 483 - Unusable Area Data	647
Table 484 - Unusable Area Header	647
Table 485 - Unusable Area Descriptor	647
Table 486 - Defect Status Data.....	648

Table 487 - Defect Status Header	648
Table 488 - Defect Status Descriptor.....	649
Table 489 - Write Speed Result Data	650
Table 490 - Write Speed Header	650
Table 491 - Write Speed Descriptor	650
Table 492 - Write Rotation Control values.....	651
Table 493 - DBI data	651
Table 494 - DBI data Header.....	652
Table 495 - DBI Descriptor	652
Table 496 - Error Level Type values	653
Table 497 - GET PERFORMANCE command errors	653
Table 498 - INQUIRY Command Descriptor Block.....	655
Table 499 - INQUIRY Data Format.....	656
Table 500 - Peripheral Qualifier definitions.....	657
Table 501 - Peripheral Device Types	657
Table 502 - Relationship of BQue and CmdQue bits	659
Table 503 - INQUIRY command errors.....	659
Table 504 - LOAD/UNLOAD MEDIUM Command Descriptor Block	661
Table 505 - Load/Unload or Optional Selection Operations	661
Table 506 - LOAD/UNLOAD MEDIUM command errors	662
Table 507 - MECHANISM STATUS Command Descriptor Block	663
Table 508 - Mechanism Status Parameter List	663
Table 509 - Mechanism Status Header	664
Table 510 - Slot Table Response format	665
Table 511 - MECHANISM STATUS command errors	665
Table 512 - MODE SELECT (10) Command Descriptor Block.....	667
Table 513 - MODE SELECT (10) command errors.....	668
Table 514 - MODE SENSE (10) Command Descriptor Block	669
Table 515 - Page Control (PC) field	669
Table 516 - MODE SENSE (10) command errors	671
Table 517 - Mode Parameter List	671
Table 518 - Mode Parameter Header.....	672
Table 519 - Mode page format	672
Table 520 - Mode page codes.....	672
Table 521 - Block Descriptor Block Sizes for Read.....	673
Table 522 - Read-Write Error Recovery mode page format	674
Table 523 - Error Recovery Descriptions (CD media).....	676
Table 524 - Error Recovery Descriptions (DVD/HD DVD media)	678
Table 525 - CD Audio Control mode page format.....	680
Table 526 - Example CDDA Output Port Channel Selection Codes	681
Table 527 - Attenuation Levels for Audio.....	681
Table 528 - Power Condition mode page format.....	682
Table 529 - Informational Exceptions Control mode page format.....	683
Table 530 - Method of Reporting Informational Exceptions (MRIE) field	684
Table 531 - Timeout and Protect mode page format	685
Table 532 - C/DVD Capabilities and Mechanical Status mode page format	686
Table 533 - Loading Mechanism Type (LMT).....	688
Table 534 - Digital Output format	690
Table 535 - logical unit Write Speed Performance Descriptor Table format.....	690
Table 536 - Rotation Control field definition	690
Table 537 - Write Parameters mode page format.....	692
Table 538 - Write Type field	693
Table 539 - Multisession/Border field definition	694
Table 540 - Data Block Type codes	695

Table 541 - Link Size field definition.....	696
Table 542 - Session Format codes	696
Table 543 - PAUSE/RESUME Command Descriptor Block.....	697
Table 544 - PAUSE/RESUME command errors.....	697
Table 545 - PLAY AUDIO (10) Command Descriptor Block.....	699
Table 546 - Play or Scan overlapped command operation.....	700
Table 547 - PLAY AUDIO (10) command errors.....	701
Table 548 - PLAY AUDIO MSF Command Descriptor Block	703
Table 549 - PLAY AUDIO MSF command errors	704
Table 550 - PREVENT ALLOW MEDIUM REMOVAL Command Descriptor Block.....	705
Table 551 - Actions for Lock/Unlock/Eject (Persistent bit = 0).....	706
Table 552 - PREVENT ALLOW MEDIUM REMOVAL command errors	706
Table 553 - READ (10) Command Descriptor Block	707
Table 554 - READ (10) command errors	708
Table 555 - READ (12) Command Descriptor Block	709
Table 556 - READ BUFFER Command Descriptor Block.....	711
Table 557 - READ BUFFER Mode field	711
Table 558 - READ BUFFER header	712
Table 559 - READ BUFFER descriptor.....	713
Table 560 - Buffer offset boundary	713
Table 561 - READ BUFFER command Errors	713
Table 562 - READ BUFFER CAPACITY Command Descriptor Block.....	715
Table 563 - READ BUFFER CAPACITY data when Block bit of CDB = 0.....	715
Table 564 - READ BUFFER CAPACITY data when Block bit of CDB = 1	716
Table 565 - READ BUFFER CAPACITY command errors.....	716
Table 566 - READ CAPACITY Command Descriptor Block.....	717
Table 567 - READ CAPACITY DATA	717
Table 568 - READ CAPACITY command errors	718
Table 569 - READ CD Command Descriptor Block	719
Table 570 - READ CD, Expected Sector Type field definition	720
Table 571 - READ CD, Header(s) Code field definition	720
Table 572 - READ CD, Error Flag(s) field definition.....	721
Table 573 - READ CD, Sub-Channel Data Selection Bits field definition.....	721
Table 574 - Formatted Q-subcode Data (A Total of 16 Bytes).....	722
Table 575 - Number of Bytes Returned Based on Data Selection Field	723
Table 576 - CD-DA (Digital Audio) Data Block Format.....	724
Table 577 - P-W Raw	727
Table 578 - R-W De-Interleaved & Error Corrected.....	727
Table 579 - Sub-channel R-W, Allowed Mode/Item Combinations	728
Table 580 - READ CD command errors	728
Table 581 - READ CD MSF Command Descriptor Block	729
Table 582 - READ CD command errors	730
Table 583 - READ DISC INFORMATION Command Descriptor Block.....	731
Table 584 - Data Type field definition	731
Table 585 - Disc Information Block.....	732
Table 586 - Status of Last Session field definition.....	733
Table 587 - Disc Status field definition.....	734
Table 588 - BG Format Status field definition	735
Table 589 - Disc Type field definition	736
Table 590 - OPC Table Entry (Obsoleted)	737
Table 591 - Example Data Rates	737
Table 592 - Track Resources Information Block	738
Table 593 - Maximum possible number of appendable Tracks value.....	738
Table 594 - READ DISC INFORMATION command errors.....	739

Table 595 - READ DISC STRUCTURE Command Descriptor Block	741
Table 596 - Media Type field definition.....	741
Table 597 - Format Code field definitions for Media Type = 0000b	742
Table 598 - Format Code field definitions for media format independent information.....	744
Table 599 - Format Code field definitions for media independent information.....	744
Table 600 - READ DISC STRUCTURE Data format (With Format Code = 00h)	745
Table 601 - Starting Physical Sector Number of Data Area.....	746
Table 602 - READ DISC STRUCTURE Data format (With Format Code = 01h)	747
Table 603 - READ DISC STRUCTURE Data format (With Format Code = 02h)	747
Table 604 - READ DISC STRUCTURE Data format (With Format Code = 03h)	748
Table 605 - READ DISC STRUCTURE Data format (With Format Code = 04h)	749
Table 606 - READ DISC STRUCTURE Data format (With Format Code = 05h)	749
Table 607 - CPR_MAI field definition.....	750
Table 608 - READ DISC STRUCTURE Data format (With Format Code = 06h)	750
Table 609 - READ DISC STRUCTURE Data format (With Format Code = 07h)	751
Table 610 - READ DISC STRUCTURE Data format (With Format Code = 08h)	752
Table 611 - READ DISC STRUCTURE Data format (With Format Code = 09h)	752
Table 612 - Disc Type Identification field definition.....	753
Table 613 - RAM-SWI Information field definition	753
Table 614 - READ DISC STRUCTURE Data format (With Format Code = 0Ah).....	754
Table 615 - READ DISC STRUCTURE Data format (With Format Code = 0Bh).....	755
Table 616 - Recording Type Information Data field definition	755
Table 617 - READ DISC STRUCTURE Data format (With Format Code = 0Ch).....	756
Table 618 - READ DISC STRUCTURE Data format (With Format Code = 0Dh).....	756
Table 619 - READ DISC STRUCTURE Data format (With Format Code = 0Eh).....	757
Table 620 - READ DISC STRUCTURE Data format (With Format Code = 0Fh).....	757
Table 621 - READ DISC STRUCTURE Data format (With Format Code = 10h)	758
Table 622 - READ DISC STRUCTURE Data format (With Format Code = 12h)	759
Table 623 - READ DISC STRUCTURE Data format (With Format Code = 15h)	759
Table 624 - READ DISC STRUCTURE Data format (With Format Code = 19h)	760
Table 625 - READ DISC STRUCTURE Data format (With Format Code = 1Ah).....	760
Table 626 - READ DISC STRUCTURE Data format (With Format Code = 20h)	761
Table 627 - READ DISC STRUCTURE Data format (With Format Code = 21h)	762
Table 628 - READ DISC STRUCTURE Data format (With Format Code = 22h)	763
Table 629 - READ DISC STRUCTURE Data format (With Format Code = 23h)	763
Table 630 - READ DISC STRUCTURE Data format (With Format Code = 24h)	764
Table 631 - READ DISC STRUCTURE Data format (With Format Code = 80h)	764
Table 632 - READ DISC STRUCTURE Data format (With Format Code = 81h)	765
Table 633 - READ DISC STRUCTURE Data format (With Format Code = 82h)	765
Table 634 - READ DISC STRUCTURE Data format (With Format Code = 83h)	766
Table 635 - READ DISC STRUCTURE Data format (With Format Code = 84h)	766
Table 636 - READ DISC STRUCTURE Data format (With Format Code = 85h)	767
Table 637 - READ DISC STRUCTURE Data format (With Format Code = 86h)	768
Table 638 - READ DISC STRUCTURE Data format (With Format Code = 90h)	769
Table 639 - Format-layer type code definition	769
Table 640 - READ DISC STRUCTURE Data format (With Format Code = C0h).....	770
Table 641 - READ DISC STRUCTURE Data format (With Format Code = FFh).....	770
Table 642 - Structure List entry.....	771
Table 643 - READ DISC STRUCTURE command Errors.....	771
Table 644 - READ FORMAT CAPACITIES Command Descriptor Block	773
Table 645 - Read Format Capacities Data Format	773
Table 646 - Capacity List Header.....	774
Table 647 - Current/Maximum Capacity Descriptor.....	774
Table 648 - Descriptor Type field definition.....	774

Table 649 - Formattable Capacity Descriptor(s)	775
Table 650 - Format Types.....	775
Table 651 - Returned Current/Maximum Descriptor for Combination of drive and media.....	777
Table 652 - READ FORMAT CAPACITIES command errors	777
Table 653 - READ SUBCHANNEL Command Descriptor Block	779
Table 654 - Sub-channel Data Format Codes.....	779
Table 655 - Sub-channel Data Header format	780
Table 656 - CD Current Position Data format (Format Code 01h)	780
Table 657 - Audio Status codes	781
Table 658 - ADR Sub-channel Q Field	781
Table 659 - Media Catalogue Number Data Format (Format Code 02h).....	782
Table 660 - UPC Format.....	783
Table 661 - Track International Standard Recording Code Data Format.....	783
Table 662 - Raw ISRC Format on the CD Disc	784
Table 663 - ISRC Format of Data Returned to host	784
Table 664 - READ SUBCHANNEL command errors	785
Table 665 - READ TOC/PMA/ATIP Command Descriptor Block	787
Table 666 - Format code definitions for READ TOC/PMA/ATIP command.....	788
Table 667 - READ TOC/PMA/ATIP Data Format (With Format field = 0h)	789
Table 668 - READ TOC/PMA/ATIP Data Format (With Format field = 1h)	790
Table 669 - READ TOC/PMA/ATIP Data Format (With Format field = 2h)	791
Table 670 - READ TOC/PMA/ATIP Track Descriptors	792
Table 671 - READ TOC/PMA/ATIP Data Format (With Format field = 3h)	793
Table 672 - READ TOC/PMA/ATIP Data Format (With Format field = 4h)	794
Table 673 - Disc Type and Disc Sub Type field definition.....	795
Table 674 - READ TOC/PMA/ATIP Data Format (With Format field = 5h)	795
Table 675 - Lead-in Area, Sub-channel Q formats.....	796
Table 676 - Bit Definitions for the Control field in Sub-channel Q.....	797
Table 677 - Example READ TOC/PMA/ATIP Operations	797
Table 678 - Values for Control field in READ TOC/PMA/ATIP	798
Table 679 - Example READ TOC/PMA/ATIP Operations for DVD/HD DVD media - Format 1	799
Table 680 - Example READ TOC/PMA/ATIP Operations for DVD/HD DVD media - Format 0.....	799
Table 681 - READ TOC/PMA/ATIP command errors	800
Table 682 - READ TRACK INFORMATION Command Descriptor Block	801
Table 683 - Logical Block Address/ Track/Session Number field definition	802
Table 684 - Track Information Block.....	803
Table 685 - LJRS field definition	805
Table 686 - Write Parameter Restrictions due to Track/RZone State	807
Table 687 - Track/RZone Status Indications	809
Table 688 - Data Mode definition (CD)	810
Table 689 - Next Writable Address definition (CD)	811
Table 690 - End Address of the Invisible/Incomplete RZone	813
Table 691 - READ TRACK INFORMATION command errors	814
Table 692 - REPAIR RZONE Command Descriptor Block	815
Table 693 - REPAIR RZONE command errors	815
Table 694 - Key Class Definitions.....	817
Table 695 - REPORT KEY Command Descriptor Block (Key Class = 00h).....	817
Table 696 - KEY Format code definitions for REPORT KEY command (Key Class = 00h)	818
Table 697 - REPORT KEY Data format (With KEY Format = 000000b, Key Class = 00h).....	819
Table 698 - REPORT KEY Data format (With KEY Format = 000001b, Key Class = 00h).....	819
Table 699 - REPORT KEY Data format (With KEY Format = 000010b, Key Class = 00h).....	820
Table 700 - REPORT KEY Data format (With KEY Format = 000100b, Key Class = 00h).....	820
Table 701 - CGMS field definition.....	821
Table 702 - REPORT KEY Data format (With KEY Format = 000101b, Key Class = 00h).....	821

Table 703 - REPORT KEY Data format (With KEY Format = 001000b, Key Class = 00h).....	822
Table 704 - Type Code field definition	822
Table 705 - RPC Scheme.....	823
Table 706 - REPORT KEY Data format (With KEY Format = 010001b, Key Class = 00h).....	823
Table 707 - REPORT KEY Command Descriptor Block (Key Class = 02h).....	824
Table 708 - KEY Format code definitions for REPORT KEY command (Key Class = 02h)	825
Table 709 - REPORT KEY Data format (With KEY Format = 000000b, Key Class = 02h).....	825
Table 710 - REPORT KEY Data format (With KEY Format = 000001b, Key Class = 02h).....	826
Table 711 - REPORT KEY Data format (With KEY Format = 000010b, Key Class = 02h).....	826
Table 712 - REPORT KEY Data format (With KEY Format = 100000b, Key Class = 02h).....	827
Table 713 - REPORT KEY Data format (With KEY Format = 100001b, Key Class = 02h).....	827
Table 714 - REPORT KEY Command Descriptor Block (Key Class = 21h).....	828
Table 715 - KEY Format code definitions for REPORT KEY command (Key Class = 21h)	829
Table 716 - REPORT KEY Data format (With KEY Format = 000000b, Key Class = 21h).....	829
Table 717 - REPORT KEY Data format (With KEY Format = 000001b, Key Class = 21h).....	830
Table 718 - REPORT KEY Data format (With KEY Format = 000010b, Key Class = 21h).....	831
Table 719 - REPORT KEY command errors	831
Table 720 - REQUEST SENSE Command Descriptor Block.....	833
Table 721 - Request Sense Standard Data	834
Table 722 - Field Pointer Bytes	835
Table 723 - Actual Retry Count Bytes	836
Table 724 - Zone Number Bytes	836
Table 725 - Progress Indication.....	836
Table 726 - Sense Key descriptions.....	838
Table 727 - REQUEST SENSE command errors.....	838
Table 728 - RESERVE TRACK Command Descriptor Block	839
Table 729 - RMZ bit definition	839
Table 730 - Track Reservation Parameter definition for the Size Mode reservation	840
Table 731 - RZone/RMZ reservation sizing (HD DVD).....	840
Table 732 - RZone reservation sizing (DVD)	841
Table 733 - Track reservation sizing (CD).....	841
Table 734 - Track Reservation Parameter definition for the Address Mode reservation.....	842
Table 735 - RESERVE TRACK command errors	843
Table 736 - SCAN Command Descriptor Block	845
Table 737 - Type field	846
Table 738 - Scan Starting Address in Logical Block Format.....	846
Table 739 - Scan Starting Address in AMIN, ASEC and AFRAME Format	846
Table 740 - Scan Starting Address in Track Number (TNO) Format	847
Table 741 - SCAN command errors	847
Table 742 - SEEK Command Descriptor Block.....	849
Table 743 - SEEK command errors.....	849
Table 744 - SEND CUE SHEET Command Descriptor Block.....	851
Table 745 - Cue Sheet Format.....	851
Table 746 - Sample Cue Sheet.....	852
Table 747 - CUE Sheet Data	853
Table 748 - CTL/ADR Byte	853
Table 749 - Control Field	853
Table 750 - ADR Field	853
Table 751 - Data Form Byte	854
Table 752 - SCMS Byte.....	854
Table 753 - CD-DA Data Form	854
Table 754 - CD-DA Data format (1 Sample)	855
Table 755 - CD-ROM Mode 1.....	855
Table 756 - CD-ROM XA, CD-I.....	855

Table 757 - CD-ROM Mode 2.....	856
Table 758 - Data Form of Sub-channel	856
Table 759 - Catalog Number (N1..N13).....	858
Table 760 - ISRC (I1..I12).....	858
Table 761 - SEND CUE SHEET command errors.....	858
Table 762 - SEND DISC STRUCTURE Command Descriptor Block.....	859
Table 763 - Media Type field definition.....	859
Table 764 - Format Code definitions for SEND DISC STRUCTURE command (Media Type = 0).....	860
Table 765 - SEND DISC STRUCTURE Data Format (With Format Code = 04h).....	861
Table 766 - SEND DISC STRUCTURE Data Format (With Format Code = 05h).....	861
Table 767 - CPR_MAI field definition.....	862
Table 768 - SEND DISC STRUCTURE Data Format (With Format Code = 0Fh).....	862
Table 769 - SEND DISC STRUCTURE Data Format (With Format Code = 17h).....	863
Table 770 - Title Set Zone information	864
Table 771 - Scramble Extent information entry	864
Table 772 - SEND DISC STRUCTURE Data Format (With Format Code = 20h).....	865
Table 773 - SEND DISC STRUCTURE Data Format (With Format Code = 21h).....	866
Table 774 - SEND DISC STRUCTURE Data Format (With Format Code = 22h).....	867
Table 775 - SEND DISC STRUCTURE Data Format (With Format Code = 23h).....	868
Table 776 - SEND DISC STRUCTURE Data Format (With Format Code = 24h).....	869
Table 777 - SEND DISC STRUCTURE Data Format (With Format Code = 84h).....	869
Table 778 - SEND DISC STRUCTURE Data Format (With Format Code = 85h).....	870
Table 779 - SEND DISC STRUCTURE Data Format (With Format Code = C0h)	871
Table 780 - SEND DISC STRUCTURE command errors.....	871
Table 781 - SEND EVENT Command Descriptor Block	873
Table 782 - SEND EVENT command errors	874
Table 783 - Key Class definitions	875
Table 784 - SEND KEY Command Descriptor Block (Key Class = 00h).....	875
Table 785 - Key Format code definitions for SEND KEY command (Key Class = 00h).....	876
Table 786 - SEND KEY Parameter List (With KEY Format = 000001b, Key Class = 00h)	876
Table 787 - SEND KEY Parameter List (With KEY Format = 000011b, Key Class = 00h)	877
Table 788 - SEND KEY Parameter List (With KEY Format = 000110b, Key Class = 00h)	877
Table 789 - SEND KEY Command Descriptor Block (Key Class = 02h).....	878
Table 790 - Key Format code definitions for SEND KEY command (Key Class = 02h).....	879
Table 791 - SEND KEY Parameter List (With KEY Format = 000001b, Key Class = 02h)	879
Table 792 - SEND KEY Parameter List (With KEY Format = 000010b, Key Class = 02h)	880
Table 793 - SEND KEY Command Descriptor Block (Key Class = 21h).....	880
Table 794 - Key Format code definitions for SEND KEY command (Key Class = 21h).....	881
Table 795 - SEND KEY Parameter List (With KEY Format = 000001b, Key Class = 21h)	881
Table 796 - SEND KEY command errors	882
Table 797 - SEND OPC INFORMATION Command Descriptor Block.....	883
Table 798 - SEND OPC INFORMATION Parameter List (Obsolete)	884
Table 799 - SEND OPC INFORMATION command errors.....	884
Table 800 - SET CD SPEED Command Descriptor Block.....	885
Table 801 - Rotational Control field definition	885
Table 802 - SET CD SPEED command errors.....	886
Table 803 - SET READ AHEAD Command Descriptor Block.....	887
Table 804 - SET READ AHEAD command errors.....	887
Table 805 - SET STREAMING command Descriptor Block	889
Table 806 - Type field values description	889
Table 807 - Performance Descriptor.....	890
Table 808 - DBI cache zone Descriptor	892
Table 809 - DBI cache zone Header.....	892
Table 810 - DBI cache zone Descriptor(s)	893

Table 811 - SET STREAMING command errors	893
Table 812 - START STOP UNIT Command Descriptor Block.....	895
Table 813 - Start/Stop and Eject Operations	895
Table 814 - Actions for Eject/Load Disc in Changer	896
Table 815 - Power Conditions	897
Table 816 - START STOP UNIT command errors.....	897
Table 817 - STOP PLAY/SCAN Command Descriptor Block.....	899
Table 818 - STOP PLAY/SCAN command Errors	900
Table 819 - SYNCHRONIZE CACHE (10) Command Descriptor Block	901
Table 820 - SYNCHRONIZE CACHE (10) command errors	901
Table 821 - TEST UNIT READY Command Descriptor Block.....	903
Table 822 - TEST UNIT READY command errors.....	904
Table 823 - VERIFY (10) Command Descriptor Block.....	905
Table 824 - VERIFY (10) command errors.....	906
Table 825 - WRITE (10) Command Descriptor Block	907
Table 826 - LBA to MSF translation (CD).....	908
Table 827 - WRITE (10) command errors	910
Table 828 - WRITE (12) Command Descriptor Block	911
Table 829 - WRITE AND VERIFY (10) Command Descriptor Block	913
Table 830 - WRITE AND VERIFY (10) command errors	913
Table 831 - WRITE BUFFER Command Descriptor Block.....	915
Table 832 - WRITE BUFFER Mode field definition.....	915
Table 833 - WRITE BUFFER command errors	918
Table 834 - All Error Codes	920
Table 835 - Basic Error Codes.....	932
Table 836 - Media Access Error Codes.....	935
Table 837 - Write Error Codes	938
Table 838 - Session/Border Error Codes	939
Table 839 - Authentication Error Codes.....	939
Table 840 - Reset Function Mapping	942
Table 841 - Reset Function Comparison	943
Table 842 - Typical Command Packet for Most commands	945
Table 843 - Typical Command Packet for Some Extended commands	945
Table 844 - Operation Code	946
Table 845 - Packet Commands for ATAPI Multi-Media devices	950
Table 846 - Example Hard Reset Implementation	955
Table 847 - Reset Function Comparison	956
Table 848 - Packet Commands for SCSI Multi-Media Devices.....	956
Table 849 - Reset Function Comparison	961
Table 850 - Packet Commands for IEEE 1394 Multi-Media Devices	961
Table 851 - Example of READ DISC Information returned for CD media.....	966
Table 852 - Example of READ TRACK INFORMATION returned for CD media.....	967
Table 853 - Example of READ DISC Information returned for DVD media.....	968
Table 854 - Example of READ TRACK INFORMATION returned for DVD media	969
Table 855 - READ DISC INFORMATION returned value for HD DVD media	970
Table 856 - READ TRACK INFORMATION returned value for HD DVD media.....	971
Table 857 - 4X - 6X CAV, 6X CLV combination 650MB CD-R writing speed profile	971
Table 858 - 40X CAV 650MB CD-R writing speed profile	972
Table 859 - 10X-16X-20X-24X ZCLV 650MB CD-R writing speed profile.....	972
Table 860 - 16X CAV 4.7GB DVD-R writing speed profile	973
Table 861 - 2X-4X-6X-8X ZCLV 4.7GB DVD-R writing speed profile	973
Table 862 - CD-Text Pack Data format for the Lead-in Area.....	975
Table 863 - Pack Type Indicator Definitions	976
Table 864 - Feature Descriptor Version	989

Table 865 - Persistent Prevent Behavior 996

Figure 1 -	CD-R/RW disc layout	73
Figure 2 -	CD-ROM sector formats	73
Figure 3 -	Packet Layout	79
Figure 4 -	Example of Packet written Track layout	80
Figure 5 -	Physical and logical layout of DVD-ROM Single Layer media	85
Figure 6 -	Physical and logical layout of PTP DVD-ROM Dual Layer media	86
Figure 7 -	Physical and logical layout of OTP DVD-ROM DL/-R DL/-RW DL media	87
Figure 8 -	Physical and logical layout of DVD-R SL/-RW SL/Download SL media	88
Figure 9 -	Physical and logical layout of DVD-RAM Ver. 2.2 media	89
Figure 10 -	Formation of Data Unit 3	90
Figure 11 -	Physical sector of DVD-ROM and DVD-R/-RW media	90
Figure 12 -	Physical sector of DVD-RAM	91
Figure 13 -	Data Unit 1	91
Figure 14 -	Data ID field definition	92
Figure 15 -	Data structure of Lead-in Area	94
Figure 16 -	Structure of Extra Border Zone	106
Figure 17 -	Device Key Exchange and Authentication State Diagram	109
Figure 18 -	Authentication Flag Sequence	109
Figure 19 -	Structure of a Pack	112
Figure 20 -	Region state diagram	115
Figure 21 -	Zoning of DVD-RAM media	117
Figure 22 -	Supplementary Spare Area example (120 mm, Ver. 2.2)	119
Figure 23 -	Usage of Spare Area (Ver. 2.2)	119
Figure 24 -	Slipping Replacement Example (Ver. 2.2)	123
Figure 25 -	Linear Replacement Example (Ver. 2.2)	124
Figure 26 -	DDS/PDL Block and SDL Block	125
Figure 27 -	Limitation of maximum number of sectors for PDL and SDL	126
Figure 28 -	Formatting Type 1 - Slow Initialization	128
Figure 29 -	Formatting Type 2 - Quick Improvement	128
Figure 30 -	Formatting Type 4 - Quick Clearing	129
Figure 31 -	Disc-at-once Recording	132
Figure 32 -	Example of incremental recording	133
Figure 33 -	Relation between Data Type bit and Linking Loss Area	134
Figure 34 -	Difference between 2 KB and 32 KB linking	135
Figure 35 -	Link position in physical sector (DVD-R SL Ver.2.1)	135
Figure 36 -	Example of DVD-Video volume structure	137
Figure 37 -	RZone status definitions	138
Figure 38 -	Typical sequence for making of UDF bridge disc	139
Figure 39 -	BSGA (Block SYNC Guard Area)	140
Figure 40 -	Start position of RZone reservation	140
Figure 41 -	RZone reservation after 2 KB linking loss	141
Figure 42 -	RZone reservation after BSGA/32 KB linking loss	142
Figure 43 -	Example of RZone reservation sequence	143
Figure 44 -	OPC direction	144
Figure 45 -	Sequential recording in an RZone	145
Figure 46 -	ECC boundary padding	145
Figure 47 -	Forward overwrite	146
Figure 48 -	Backward overwrite	146
Figure 49 -	RMA and RMD block structure	147
Figure 50 -	Border Zone and Bordered Area (Border)	157
Figure 51 -	Relation between RZone number and Border Zone	158
Figure 52 -	Bordered Area status definitions	159
Figure 53 -	Border Zone structure	160
Figure 54 -	Pointers for multi-Border recognition	161

Figure 55 - Finalize	162
Figure 56 - Example of error recovery sequence.....	163
Figure 57 - Repair incomplete linking	164
Figure 58 - DVD-R DL disc recording mode and Bordered Area state transition	168
Figure 59 - APs update problem of Multi-Border with Layer Jump recording	171
Figure 60 - State for DVD-R DL disc interchange	172
Figure 61 - Example of Disc-at-once recording on DVD-R DL disc	172
Figure 62 - Example of incremental recording on DVD-R DL disc.....	173
Figure 63 - Example of Layer Jump recording.....	173
Figure 64 - RZone definition for Layer Jump recording	176
Figure 65 - LJB structure of Invisible/Incomplete RZone.....	177
Figure 66 - Laser beam profile.....	179
Figure 67 - Eccentric between L0 and L1	179
Figure 68 - Tolerance between L0 and L1	180
Figure 69 - Physical overview of Layers	180
Figure 70 - Blank Areas and RZone shape	181
Figure 71 - Small Reserved RZone.....	182
Figure 72 - Invisible RZone shape.....	182
Figure 73 - Formula to get the number of sectors in the Clearance at a given LBA on L0.....	183
Figure 74 - Manual Layer Jump on Layer Jump recording mode	186
Figure 75 - Regular Interval Layer Jump.....	188
Figure 76 - Layer Jump Address report	189
Figure 77 - NWA motion on Layer Jump	191
Figure 78 - BSGA and Linking Loss Area at Layer Jump Address	192
Figure 79 - Reserved RZone closing.....	193
Figure 80 - Incomplete RZone closing when NWA is on L0.....	194
Figure 81 - Incomplete RZone closing when NWA is on L1	194
Figure 82 - Last recorded user data sector indication	195
Figure 83 - padding by SYNCHRONIZE CACHE (10) command.....	196
Figure 84 - Border Zone structure for DVD-R DL media	197
Figure 85 - Detail structure of Border Zone for DVD-R DL disc	198
Figure 86 - Reduced Border-out	199
Figure 87 - Example sequence of Disc-at-once like Layer jump recording	202
Figure 88 - Example sequence of multi-Border recording with remapping	203
Figure 89 - Example sequence of Packet recording with remapping	204
Figure 90 - Example read behavior of remapped ECC block.....	205
Figure 91 - Disc final closure in Layer Jump recording mode	205
Figure 92 - Disc final closure in Incremental recording mode	206
Figure 93 - Padding under Lead-out to create Shifted Middle Area.....	206
Figure 94 - Usage example of the 3rd NWA on Incremental Recording mode.....	222
Figure 95 - Address Mode reservation for Layer Jump recording.....	223
Figure 96 - Address Mode reservation for CD-R/DVD-R Incremental recording	224
Figure 97 - Link position in physical sector (DVD-RW)	226
Figure 98 - An example of Intermediate state Bordered Area on DVD-RW SL media	227
Figure 99 - DVD-RW SL recording mode and Bordered Area state transition.....	229
Figure 100 - RMA structure on Blanked disc	230
Figure 101 - RMA structure for Restricted overwrite mode.....	231
Figure 102 - Physical disc state examples	247
Figure 103 - Additional restrictions of DVD-RW DL media for disc interchange	248
Figure 104 - Examples of the recorded condition.....	249
Figure 105 - Examples of Intermediate Marker on Layer jump recording	251
Figure 106 - Structure of Complete media state examples	254
Figure 107 - DVD-RW DL physical disc state and logical disc status.....	258
Figure 108 - RZone condition transition diagram.....	259

Figure 109 - LJBs on DVD-RW DL disc	262
Figure 110 - Overwritability of the Buffer Block	263
Figure 111 - WRITE command	264
Figure 112 - Example of Full Format operation	280
Figure 113 - Example allocation of the Middle Area	281
Figure 114 - Example of Quick Grow Format operation - Case 1.....	282
Figure 115 - Example of Quick Grow Format operation - Case 2.....	283
Figure 116 - Example of Grow Format operation.....	284
Figure 117 - Example of Fast Re-format operation - Case 1	286
Figure 118 - Example of Fast Re-format operation - Case 2.....	287
Figure 119 - Example of the reported Number of Blocks for Fast Re-format.....	288
Figure 120 - Example of Disc Closing.....	290
Figure 121 - Example of Scramble Content Allocation.....	295
Figure 122 - Physical and logical layout of HD DVD-ROM SL media	299
Figure 123 - Physical and logical layout of Parallel Track Path HD DVD-ROM media	300
Figure 124 - Physical and logical layout of Opposite Track Path HD DVD-ROM media	301
Figure 125 - Physical and logical layout of HD DVD-R SL media	302
Figure 126 - Physical and logical layout of HD DVD-R DL media.....	303
Figure 127 - Physical and logical layout of HD DVD-RW SL media.....	304
Figure 128 - Physical and logical layout of HD DVD-RW DL media	305
Figure 129 - Physical and logical layout of HD DVD-RAM media (1).....	306
Figure 130 - Physical and logical layout of HD DVD-RAM media (2).....	307
Figure 131 - Layout of a Data segment.....	308
Figure 132 - Data frame layout.....	309
Figure 133 - Data ID field definition	309
Figure 134 - Data Structure of the Lead-in	311
Figure 134 - Structure of a Control data zone.....	312
Figure 135 - Layout of the RDZ	318
Figure 136 - Layout of RDZ	321
Figure 137 - Layout of L-RMZ.....	322
Figure 138 - Layout of RDZ	323
Figure 139 - Layout of L-RMZ.....	324
Figure 140 - Structure of Data Lead-out Area for non-finalized HD DVD-R SL media	325
Figure 141 - Structure of original Data Lead-out area for HD DVD-R DL media.....	326
Figure 142 - Structure of Data Lead-out Area for HD DVD-RAM.....	327
Figure 143 - Example of the finalized disc structure	333
Figure 144 - RMD structure and location in RMZ	334
Figure 145 - Border Zone structure.....	343
Figure 146 - Bordered Area status definitions	344
Figure 147 - Border Zone structure.....	345
Figure 148 - Example of User data zone structure.....	345
Figure 149 - RZone status definitions.....	346
Figure 150 - Example of Data recording	347
Figure 151 - ECC boundary padding	348
Figure 152 - Start position of RZone reservation	349
Figure 153 - Example of RZone reservation sequence.....	350
Figure 154 - Relation between RZone number and Border Zone.....	351
Figure 155 - Current RMZ.....	352
Figure 156 - Current RMZ State Diagram.....	353
Figure 157 - Sample sequence for RMZ extension by U-RMZ.....	354
Figure 158 - Example for extending Test Zone	355
Figure 159 - Disc Final Closure without Terminator.....	357
Figure 160 - Disc Final Closure with Terminator.....	358
Figure 161 - Example of searching the last recorded PSN of the finalized disc.....	359

Figure 162 - Example of searching the last recorded PSN of the Incomplete Border disc	360
Figure 163 - Physical restriction for recording L1	368
Figure 164 - Middle Area expansion	369
Figure 165 - Limitation of Middle Area expansion	370
Figure 166 - Guard Track Zone allocation.....	371
Figure 167 - Example of capacity reducing by RZone reservation	373
Figure 168 - Example of final area structure	375
Figure 169 - Finalization State Diagram.....	376
Figure 170 - RMD structure and location in L-RMZ.....	380
Figure 171 - Example of disc structure of Intermediate state in Sequential formatting mode	392
Figure 172 - Example of disc structure of Finalized state in Sequential formatting mode.....	392
Figure 173 - Example of disc structure of Intermediate state in Fragment recording mode	393
Figure 174 - Example of disc structure of Full-finalized state	393
Figure 175 - Single Layer Disc state transition at the completion of the operation	394
Figure 176 - Example of “Full format” and “Quick format” stop	398
Figure 177 - Example of “Grow format” and “Quick Grow format” stop	399
Figure 178 - Example of Finalization stop.....	401
Figure 179 - RMD structure and location in L-RMZ.....	406
Figure 180 - Example of disc structure of Intermediate state in Sequential formatting mode	417
Figure 181 - Example of Finalized structure for RZone on both L0 and L1 in Sequential formatting mode	418
Figure 182 - Example of Finalized structure for RZone on only L0 in Sequential formatting mode.....	419
Figure 183 - Example of disc structure of Full-finalized state	420
Figure 184 - Dual Layer Disc state transition at the completion of the operation.....	421
Figure 185 - Example of “Full format” and “Quick format” stop	424
Figure 186 - Example of “Grow format” and “Quick Grow format” stop	425
Figure 187 - Example of “Finalization” stop	428
Figure 188 - RMD structure and location in L-RMZ.....	430
Figure 189 - Zoning of HD DVD-RAM media	443
Figure 190 - Supplementary Spare Area example (120 mm, Ver. 1.0)	445
Figure 191 - Usage of Spare Area (Ver. 1.0).....	446
Figure 192 - Slipping Replacement Example (Ver. 1.0).....	449
Figure 193 - Linear Replacement Example (Ver. 1.0).....	450
Figure 194 - DDS/PDL Block and SDL Block.....	451
Figure 195 - Limitation of maximum number of sectors for PDL and SDL	452
Figure 196 - Formatting Type 1 - Slow Initialization.....	453
Figure 197 - Formatting Type 2 - Quick Improvement	454
Figure 198 - Formatting Type 4 - Quick Clearing	454
Figure 199 - Example of Hybrid disc.....	457
Figure 200 - Example Physical sector number assignment for each Format-layer	457
Figure 201 - Comparison of disc exchange and Format-layer changing sequences	458
Figure 202 - State diagram of Format-layer changing	460
Figure 203 - AACS Authentication State Diagram	464
Figure 204 - SecurDisc system overview	467
Figure 205 - Logical unit-host authentication.....	468
Figure 206 - Example of Data Allocation in the case of Linear Replacement	471
Figure 207 - An example of data allocation on the Stream recording operation	472
Figure 208 - An example of data allocation on the Stream recording operation	475
Figure 209 - An example of RW media characteristics	476
Figure 210 - Example of DBI memory blocks.....	483
Figure 211 - Example of defect level transition.....	487
Figure 212 - Example of changer mechanism	491
Figure 213 - Changer State Diagram	493
Figure 214 - State transition, events and status.....	502
Figure 215 - Adjustment of command termination time on different media	511

Figure 216 - Morphing States - Event Generation.....	519
Figure 217 - Morphing States - Event Reporting.....	520
Figure 218 - Example of CD-R/-RW Feature reporting	523
Figure 219 - Example Feature Relationships.....	563
Figure 220 - Execution of a command that may cause Logical Unit Busy	640
Figure 221 - READ CD Data Stream Order	725
Figure 222 - Read CD Sub-channel, R-W (100b).....	726
Figure 223 - Location of Sub-channel Data.....	857
Figure 224 - Stop Play/Play Audio/Audio Scan/Pause/Resume Sequencing	899
Figure 225 - TEST UNIT READY State Diagram	904
Figure 226 - Example of CD Multisession recorded/stamped* disc	965
Figure 227 - Example of DVD-R Multi-Border disc	968
Figure 228 - Example of HD DVD-R Single Layer Multi-Border disc.....	970
Figure 229 - Execution of a command that may cause Logical Unit Busy condition	998
Figure 230 - Execution of Stair type implementation of CD-R session closing.....	999
Figure 231 - Execution of clock type implementation of CD-R session closing.....	1000
Figure 232 - Command validity check of CD-R session closing.....	1001
Figure 233 - Disc ejection with data writing of tray type	1001
Figure 234 - Basic UDF Structure	1003
Figure 235 - Basic UDF Structure used on sequentially written media.....	1003

1.0 Introduction

This document provides a command set for a variety of multimedia devices. Previous standards contained descriptions applicable to only one interface, such as ATAPI or SCSI. This specification documents how to command a logical unit regardless of the type of interface used. However, while every attempt was made to make the command sets common across interfaces, different operating behavior of various transports led to implementation differences. These differences are highlighted in annexes.

This document was based on ATAPI CD-ROM command set specification that was known as SFF8020i. The number of supported media types are broadened in proportion to the appearance of wide variety of optical media. This document has been developed by proposal basis and that the media types described by this version of this specification are listed as shown in Table 1.

Table 1 - Media types that are described in this specification

Media type	Physical specifications and versions
CD-ROM	Yellow Book
CD-R	Orange Book Part II
CD-RW	Orange Book Part III
DVD-ROM	Ver. 1.0
DVD-RAM	Ver. 2.2
DVD-R SL	Ver. 2.1 (for General)
DVD-R DL	Ver. 3.0
DVD-RW SL	Ver. 1.2
DVD-RW DL	Ver. 2.0
HD DVD-ROM	Ver. 1.1
HD DVD-RAM	Ver. 1.0
HD DVD-R SL	Ver. 1.0
HD DVD-R DL	Ver. 2.0
HD DVD-RW SL	Ver. 1.0
HD DVD-RW DL	Ver. 2.0

For the other media types such as DVD+R/+RW or BD, see MMC for its specific command descriptions.

DVD is the successor to CD. DVD logical units are capable of storing large amounts of data, and in some cases will be able to play movies. Logical units conforming to this specification will be backward compatible with CD logical units. This specification combines the capabilities and command set of the CD with the capabilities of DVD.

HD DVD is the successor to DVD. Interface between a host and a HD DVD logical units is designed to keep the good compatibility with DVD as possible. The followings are the basic concept of HD DVD.

- HD DVD-ROM is based on DVD-ROM.
- HD DVD-R is based on DVD-R.
- HD DVD-RAM is based on DVD-RAM.
- HD DVD-RW is based on DVD-RW.

1.1 Abstract

This document defines a standard method for interfacing a storage device to a host using various transports including ATAPI, SCSI, and IEEE 1394.

1.2 Scope

This document is intended to be used with external standards for the transport of commands and data. It also lists several peer command set standards as normative references. In the event of a conflict between one of the base documents and this document, the interpretation of this document *shall* prevail *only if this document acknowledges that a conflict exists between the documents*.

1.3 Audience

This document is intended for use by computer system, host software, storage peripheral, and interface chip set vendors.

1.4 Normative references

The following standards contain provisions which, when referenced in the text of this specification, constitute provisions of this Specification. At the time of publication, the editions indicated were valid. All standards are subject to revision, and parties to agreements based on this Specification are encouraged to investigate the possibility of applying the most recent editions of the standards indicated below. Members of IEC and ISO maintain registers of currently valid International Standards.

- ANSI INCITS 304-1997 Information Technology - SCSI-3 Multimedia Commands (MMC)
- DVD/HD DVD Book, DVD Forum
- ISO/IEC 10149:1989, Information technology - Data Interchange on Read-only 120 mm Optical Data Disks.
- IEC 908:1987, Compact Disc Digital Audio System.
- ANSI INCITS 317-1998 AT Attachment with Packet Interface Extension (ATA/ATAPI-4)

1.5 Informative references

- ANSI INCITS 408-2005 Information Technology - SCSI Primary Commands - 3 (SPC-3)

1.6 Prerequisites and related documents

The reader is expected to have a basic understanding of the ATA/SCSI hardware and software interfaces as well as the ATA/SCSI documents. Specifically, the following documents are required for understanding and implementing an ATA Multi-Media logical unit because this document is based on them:

- CBEMA, ATA (AT Attachment) ANSI Draft Standard, Revision 9482K, December 2, 1994, Document Number X3T10/948, Computer and Business Equipment Manufacturer's Association. This is referred to as the ATA Document.
- ANSI X3T9.2/375R, Small Computer System Interface
- Red, Yellow, Green, Orange Books and CD-ROM XA Specification.

1.7 Layout of the document

This document is broken into several sections as shown in Table 2.

Table 2 - Layout of the document

Section 1.0, "Introduction" on page 49	Introduction, scope, purpose etc.
Section 2.0, "Conventions" on page 55	Describes conventions used in the document, and a definitions of terms and signals.
Section 3.0, "CD model" on page 71	Description of command and media supported by Multi-Media logical units. This section provides a tutorial on the technology of CD as well as specific requirements for a logical unit that supports the CD media.

Table 2 - Layout of the document (continued)

<i>Section 4.0, "DVD model" on page 83</i>	Description of command and media supported by Multi-Media logical units. This section provides a tutorial on the technology of DVD as well as specific requirements for a logical unit that supports the DVD media.
<i>Section 5.0, "HD DVD model" on page 297</i>	Description of command and media supported by Multi-Media logical units. This section provides a tutorial on the technology of HD DVD as well as specific requirements for a logical unit that supports the HD DVD media.
<i>Section 6.0, "Hybrid disc model" on page 457</i>	Description of operations for Hybrid disc supported logical units
<i>Section 7.0, "AACs content protection" on page 461</i>	Description of AACs content protection and authentication process.
<i>Section 8.0, "SecurDisc content protection" on page 467</i>	Description of SecurDisc content protection and authentication process.
<i>Section 9.0, "Real-Time Stream recording/playback model" on page 471</i>	Description of real-time streaming recording/playback on optical media.
<i>Section 10.0, "Logical unit assisted software defect management model" on page 477</i>	Description of software defect management with enhanced defect reporting capable logical unit.
<i>Section 11.0, "Changer Model" on page 491</i>	Description of the requirements and operation of logical units that is able to select from a number of internally stored media.
<i>Section 12.0, "Write protection model" on page 497</i>	Description of the operations for write protection for the Multi-Media logical unit.
<i>Section 13.0, "Power management model" on page 499</i>	Description of the requirements for power management for the Multi-Media logical unit.
<i>Section 14.0, "Timeout and Reset models" on page 507</i>	Description of the requirements for timeouts and resets for the Multi-Media logical unit.
<i>Section 15.0, "Features" on page 515</i>	Description of specific functionality that is implemented in groupings.
<i>Section 16.0, "Profiles" on page 525</i>	Description of Groupings of Features that may be supported.
<i>Section 17.0, "Packet commands" on page 537</i>	Description of packet based commands for Multi-Media logical units.
<i>Appendix A - "Error Reporting and Sense Codes (Normative)" on page 919</i>	Descriptions of error behavior and Sense Key, ASC, and ASCQ assignments
<i>Appendix B - "ATAPI Implementation Notes (Normative)" on page 941</i>	Overview of the Packet Interface and how the "Layering" of Packets and ATA occurs.
<i>Appendix C - "SCSI Implementation Notes (Normative)" on page 953</i>	Integration notes for logical units that make use of the SCSI interface.
<i>Appendix D - "IEEE 1394 Implementation Notes (Normative)" on page 959</i>	Implementation notes for using this command set with IEEE 1394.
<i>Appendix E - "Example Event Implementation Notes (Informative)" on page 963</i>	Notes on using and implementing the GET EVENT/STATUS NOTIFICATION command.
<i>Appendix F - "Command Implementation Notes (Informative)" on page 965</i>	Notes on using and implementing the READ DISC INFORMATION and READ TRACK INFORMATION commands.
<i>Appendix G - "CD-Text Format in the Lead-in Area (Informative)" on page 975</i>	Description of the CD-Text format.
<i>Appendix H - "Mt. Fuji revision history (Informative)" on page 979</i>	Revision history of the Mt. Fuji documents
<i>Appendix I - "Sample Applications of Events (Informative)" on page 993</i>	Application of Events
<i>Appendix J - "UDF Key Structure (Informative)" on page 1003</i>	Notes on how to use this command set to read UDF written media.

1.8 Patents

The developers of this specification have requested that holders of patents that may be required for the implementation of the specification, disclose such patents to the publisher. However, neither the developers nor the publisher have undertaken a patent search in order to identify which, if any, patents apply to this specification.

No position is taken with respect to the validity of any claim or any patent rights that may have been disclosed. Details of submitted statements may be obtained from the publisher concerning any statement of patents and willingness to grant a license under these rights on reasonable and nondiscriminatory terms and conditions to applicants desiring to obtain such a license.

1.9 Change history

- Mt.Fuji Ver. 7 Revision 0.6 created and distributed August 1, 2006. All modifications are applied to and based on Mt.Fuji Ver. 6 Rev. 1.0 document.
 - HD DVD-R DL commands and model section are added.
 - A keyword "Restricted" is newly defined.
 - Numerical notation of decimal number is changed to ISO style.
- Mt.Fuji Ver. 7 Revision 0.7 created and distributed May 07, 2007.
 - Descriptions for DVD-R Ver. 1.0, DVD-R for Authoring Ver. 2.0 and DVD-RAM Ver. 1.0 are removed.
 - AS-MO related descriptions are obsolete. See INF-8090i Rev 6.1 for its descriptions.
 - AS-MO Profile is obsolete.
 - MO Erasable Profile is obsolete.
 - MO Write Once Profile is obsolete.
 - The Sector Erasable Feature is obsolete.
 - HD DVD-RW model section is added and related commands, Profile, Feature are added or updated.
 - Add Session/Border and Quick Add Border format operations are obsolete.
 - Zone Reformat operation is obsolete.
 - Zone Format operation is obsolete.
 - AACs model section is updated to support Bus Encryption and related commands, Profile, Feature are updated.
 - Load bit is added to Removable Medium Feature Descriptor.
 - A recommendation for host during direct overwriting on DVD-RW media is added.
 - Key Class for "Security Service-A" is obsolete.
 - EBP bit of WRITE command is obsolete and replaced by TSR bit.
 - 2/04/07 error is added to the returned error codes for the case that read/write command is terminated due to busy state of the logical unit.
 - 5/6F/08 error is added.
 - Change history (Mt. Fuji 4 ~ Mt. Fuji 6) is added to the History section.
- Mt.Fuji Ver. 7 Revision 0.8 created and distributed May 28, 2007.
 - DVD-RW DL model section is added and related commands, Profile, Feature are added or updated.
 - DVD-Download and CSS Managed recording model section is added and related commands, Profile, Feature are added or updated.
- Mt.Fuji Ver. 7 Revision 0.9 created and distributed July 25, 2007.
 - AACs Bus Encryption model section and related commands are modified to keep up with the latest version of AACs specification.
 - SecurDisc model section is added and related commands, Feature are added or updated.
 - Structure of the Scramble Extent information of SEND DISC STRUCTURE command is re-defined as Scramble Content Allocation information to differentiate Title Set Zone information from Scramble Extent information entries.
 - CSS Managed recording model section is updated to clarify some points.
 - Reference of DVD-RAM specification is changed from ver. 2.1 to ver. 2.2.
- Mt.Fuji Ver. 7 Revision 0.91 created and distributed September 04, 2007.
 - Power Management Feature is added to the "Logical units Not Conforming to a Standard" Profile.

- Other misc. clarification and corrections have been made.
- Mt.Fuji Ver. 7 Revision 0.92 created and distributed October 02, 2007.
 - Non-removable disk Profile is obsolete. See INF-8090i Rev 6.1 for its descriptions.
 - The Format Code 86h is added to the READ DISC STRUCTURE Command and related AACS model section is revised.
 - Other misc. clarification and corrections have been made.
- Mt.Fuji Ver. 7 Revision 0.93 created and distributed October 25, 2007.
 - Description about Physical Interface Asynchronous Notification is added in section 17.5 on page 629 is added.
 - B-13, "*SATA Asynchronous Notification*" on page 948 is added.
 - Other misc. clarification and corrections have been made.
- Mt.Fuji Ver. 7 Revision 0.94 created and distributed November 15, 2007.
 - Definition and some description about Physical Interface Asynchronous Notification are revised.
 - Other misc. clarification and corrections have been made.
- Mt.Fuji Ver. 7 Revision 0.95 created and distributed January 29, 2008.
 - 13.2, "*Interface Power management timer adjustment*" on page 505 is added.
 - Other misc. clarification and corrections have been made.
- Mt.Fuji Ver. 7 Revision 0.99 created and distributed March 18, 2008.
 - Set Minimum Performance bit (**SMP**) bit of is added and SET READ AHEAD Command is removed in/from Feature 0107h: Real-Time Streaming Feature (ADh).
 - *Structure Length field is removed from Table 642 - Structure List entry on page 771.*
 - Description of **Last Layer Jump Address** field for DVD-RW DL media is revised.
 - Additional explanation about host usage of Table 480 - *Performance Descriptor - Nominal Performance* on page 645 and additional implementation examples F-2 "*GET PERFORMANCE command Performance (Type field = 00h)*" on page 971 are added.
 - Other misc. clarification and corrections have been made.
- Mt.Fuji Ver. 7 Revision 1.00 created and distributed April 18, 2008.
 - Clarification is added for 17.24.36, "*DISC Structure List (Format Code = FFh)*" on page 770.
 - Other misc. clarification and corrections have been made.

2.0 Conventions

2.1 Document conventions

This document was written for both the drive firmware designer and host software designers. Media specific information is given when it is helpful to the software designer, as it is assumed that the firmware designers have access to the appropriate media standards. All such information is informative, and where a conflict occurs between this documentation and the media documentation, the media documentation *shall* prevail.

A complete set of commands is documented. However, logical units are not required to implement all commands. The specific requirements for implementing commands is listed within the Features of the GET CONFIGURATION command. If a command is implemented, it *shall* be implemented as defined.

Certain words and terms used in this document have specific meaning beyond the normal English meaning. These words and terms are defined either in this section or in the text where they first appear and are indicated with an initial capital. Names of signals, commands, status, and sense keys are in all uppercase (e.g., REQUEST SENSE). Lower case is used for words having the normal English meaning.

Fields containing only one bit are usually referred to as the <name> bit instead of the <name> field. Numbers that are not immediately followed by a lower case b or h are decimal. Numbers immediately followed by a lower case b are in binary, and numbers immediately followed by a lower case h are in hexadecimal. The notation “Hex” may appear in the headings of tables, indicating that all numbers in the column are written in hexadecimal. (NNh for Hexadecimal, where NN refers to two hexadecimal digits 0-9, A-F.) All Sense Key information (written as N/NN/NN) is in Hexadecimal.

The representation of decimal number and decimal sign used in this specification is ISO style (i.e., each group of three digits from decimal sign are separated by a space and a comma is used as the decimal sign). Table 3 shows the example of decimal number representation.

Table 3 - Decimal number representation

Decimal value	ISO representation	Example
2048	2 048 ^a	A sector size is 2 048 bytes.
65536	65 536	An ECC block size on HD DVD media is 65 536 bytes.
8.54	8,54	The capacity of DVD-ROM Dual Layer disc is 8,54 gigabytes.

a. As an exception, if a 4-digit represents year, the digit is not separated by a space (e.g., June 15, 2048).

2.2 Definitions

2.2.1 AACSS (Advanced Access Content System)

A system for protecting audiovisual content stored on the prerecorded or recordable optical media for consumer use with PC and CE devices.

2.2.2 Absolute M/S/F Field

See “MSF Address.”

2.2.3 AES

Advanced Encryption Standard (AES) is a cryptographic algorithm that uses symmetric block cipher. AES is defined by Federal Information Processing Standards Publication 197.

2.2.4 AGID (Authentication Grant ID)

A value used for resource control during key management. Individual key management threads are identified through the use of AGID.

2.2.5 ATA (*AT Attachment*)

ATA defines the physical, electrical, transport, and command protocols for the internal attachment of block storage devices.

2.2.6 ATAPI (*AT Attachment Packet Interface*)

A device which complies with INCITS 317:199x, the AT Attachment Packet Interface. In this document such devices are referred to as devices implementing the Packet command feature set.

2.2.7 Audio Sector

See “Sector.”

2.2.8 BCA (*Burst Cutting Area*)

Provides a unique physical identification mark for individual DVD and HD DVD media. This area is not directly addressable by the user.

2.2.9 BCD (*Binary Coded Decimal*)

The number system used on the physical CD-ROM and CD-DA media. Numbers that use this notation have the “bcd” suffix attached. A byte has two 4-bit values, each of which may have a value from 0 to 9. The maximum value is 99bcd (99 decimal). BCD is only used on the physical CD media.

2.2.10 Block

The term “Block” refers to data sent to/from the host. The Block is data addressed by a Logical Block Address (LBA). Generally the amount of data in a Block is controlled by the command.

2.2.11 Block SYNC (*SY0*)

First frame SYNC (SY0) of the first sector of an ECC block.

2.2.12 Book

Term that is used to indicate a book that specifies a CD, DVD or HD DVD standard.

2.2.13 Bordered Area

A contiguous area of a disc that contains user data which is located between Lead-in/Border-in Area and Lead-out/Border-out Area.

2.2.14 Border-in Area

The area that contains the pointer to the next Border Zone and is located immediately following Border-out.

2.2.15 Border-out Area

The area that follows each Bordered Area and contains the latest RMD copies and so on. This area is used to avoid pickup overrunning for DVD/HD DVD logical units.

2.2.16 Border recording

A method that is used for interchange of DVD-R media between DVD-R logical unit and DVD read-only logical unit with Border Zone during Incremental recording mode or Layer Jump recording mode. For HD DVD, a method that is used for interchange of HD DVD-R media between HD DVD-R logical unit and HD DVD read-only logical unit with Border Zone.

2.2.17 Border Zone

A generic term that is named for Border-out and Border-in.

2.2.18 B-RMZ

The RMZ located in the Border-in Area.

2.2.19 BSGA (Block SYNC Guard Area)

A BSGA is an ECC block that is located at the beginning of a recorded area. The BSGA is required where the recorded area immediately follows an unrecorded area. The BSGA is used to guarantee that the following ECC block(s) is(are) readable.

2.2.20 Bus Key

A cryptographic key shared by the host and the logical unit as a result of an authentication process.

2.2.21 CD-DA

Compact Disc-Digital Audio (CD-DA) is a standardized medium for recording digital/audio information. The “Red Book” defines CD-DA media. See IEC 908:1987.

2.2.22 CD-R

Compact Disc-Recordable (CD-R) is a standardized medium defined by the “Orange Book Part 2.” The CD-R system gives the opportunity to write once and read many times CD information. The recorded CD-R disc may be Red Book compatible, so it is able to be played back on any conventional CD-player. The CD-R format gives the possibility for both Audio and Data recording.

2.2.23 CD-ROM

Compact Disc-Read Only Memory (CD-ROM) is a standardized medium for recording digitized audio and digital data. CD-ROM is used to describe media with digital data rather than discs that encode audio only. The ISO/IEC 10149 standard defines CD-ROM media.

2.2.24 CD-RW

Compact Disc-Rewritable (CD-RW) is a standardized medium defined by the “Orange Book Part 3.” The CD-RW system gives the opportunity to write, erase, overwrite and read CD information. The recorded CD-RW disc has a lower reflectivity than a ‘Red Book compatible’ disc, so it *shall* be played back on CD-RW enabled (MultiRead) CD-players. The CD-RW enabled CD-player can therefore read out CD-RW discs as well as CD-R and conventional CD discs. The CD-RW format gives the possibility for both Audio and Data recording.

2.2.25 CD Control Field

The CD Control Field is a 4-bit field in the Q sub-channel data indicating the data type. It indicates audio versus data and the type of audio encoding, etc. The control field is also found in the table of contents entries.

2.2.26 CD Data Mode

A byte in the header of CD data sectors. This indicates if data is present and the format of the data.

2.2.27 CD media

Term that is used when referring to media that conforms to the CD standards.

2.2.28 CD Standard

Comprised of one or more of the following documents available from Sony and Philips:

- Red Book, CD -DA
- Yellow Book, (ISO/IEC 10149) CD-ROM
- Orange book part 2, CD-Recordable and part 3 CD-Rewritable
- White book, CD-Video
- Green Book, CD Interactive, CD-I
- CD-ROM XA
- Enhanced Music CD Extra
- Multi-session CD

2.2.29 CD Text

A method for storing text information on a CD-DA disc.

2.2.30 CDB (Command Descriptor Block)

The structure used to communicate commands from a host to a logical unit.

2.2.31 Cell

Term that is used in DVD-Video specification. The Cell is the basic presentation unit to be played back. See DVD Book Part 3.

2.2.32 Challenge key

Data used during an authentication key exchange process.

2.2.33 Changer

“Changer” is a mechanical device which allows a single Multi-Media device to load and unload multiple media without user intervention.

2.2.34 CIRC (Cross Interleaved Reed-Solomon Code)

CIRC is the error detection and correction technique used within small frames of CD audio or data. The CIRC bytes are present in all CD-ROM data modes. The error correction procedure which uses the CIRC bytes is referred to as the CIRC based algorithm. In most CD-ROM logical units, this function is implemented in hardware.

2.2.35 Command Packet

“Command Packet” is a structure used to communicate commands from a host to a logical unit. See Command Descriptor Block.

2.2.36 CPPM (Content Protection for Pre-Recorded Media)

A system for protecting DVD-Audio content on DVD-ROM media.

2.2.37 CPRM (Content Protection for Recordable Media)

A system for protecting audio-visual content on recordable DVD media.

2.2.38 CSS (DVD-Video Content Scramble System)

A system for protecting DVD-Video content on DVD-ROM media.

2.2.39 Data Area

The area between the Lead-in Area and the Lead-out Area in which user data is recorded. In case of Border recording, the Data Area contains Border Zones.

In case of the finalized DVD-R DL media and DVD-RW DL media, the Layer 0 part of Data Area is between the Lead-in Area and Middle Area, and the Layer 1 part of Data Area is between the Middle Area and the Lead-out Area.

2.2.40 Data Recordable Area

The area that is available to record user data.

2.2.41 Data Sector

See “Sector.”

2.2.42 Defect Management

Methods for handling the defective areas on media. The defective areas may or may not be readable.

2.2.43 Disc at once recording

A method in which Lead-in, user data and Lead-out are recorded sequentially without interruption, and no pointer to a next possible session exists.

2.2.44 Disc Key

A value used during the encryption/decryption process of title key data on DVD media.

2.2.45 Double Sided

DVD/HD DVD disc structure is two transparent substrates joined together such that the recorded Layers are on the inside. A double sided disc has two recorded sides.

2.2.46 Drive Certificate Challenge

Data used during an AACS authentication process. This is used for the host to verify legitimacy of the logical unit.

2.2.47 Drive Key

Data used during an AACS authentication process. This is used, together with the Host Key to generate the Bus Key.

2.2.48 Drive Test zone

This zone is used mainly for the power calibration and located in Data Lead-in Area and Data Lead-out Area. This zone is called PCA in the case of DVD-R.

2.2.49 Dual Layer

When there are exactly two recording Layers accessible from a given side of the media. L0 is closest to the read-out side of the media and Layer 1 is further away.

2.2.50 DVD Control Data Zone

The DVD Control Data Zone is comprised of 192 ECC blocks in the Lead-in Area of a DVD medium. The content of 16 sectors in each Block is repeated 192 times. This area contains information concerning the disc.

2.2.51 DVD Copyright Information

The DVD Copyright Information is recorded in the DVD Control Data Zone and contain information supplied by the content provider.

2.2.52 DVD-R

DVD Recordable (DVD-R) is a standardized medium defined by the “DVD-Book” and ECMA-279.

2.2.53 DVD-R DL

DVD-R Dual Layer media that comply with DVD Specifications for Recordable Disc for Dual Layer (DVD-R for DL) part one Physical Specifications.

2.2.54 DVD-R SL

DVD-R Single Layer media that comply with DVD Specifications for Recordable Disc for General Part one Physical Specifications.

2.2.55 DVD-RAM

DVD-Random Access Memory (DVD-RAM) is a standardized medium defined by the “DVD-Book” and ECMA-272. The media is to be written and read many times over the recording surface of the disc using the phase-change rewritable effect.

2.2.56 DVD-ROM

DVD-Read Only Memory (DVD-ROM) is a standardized medium defined by the “DVD-Book” and ECMA-267.

2.2.57 DVD-ROM DL

DVD-ROM Dual Layer media that comply with DVD Specification for Read only Disc part one Physical Specifications.

2.2.58 DVD-ROM SL

DVD-ROM Single Layer media that comply with DVD Specification for Read only Disc part one Physical Specifications.

2.2.59 DVD-RW

DVD Re-recordable (DVD-RW) is a standardized medium defined by the “DVD-Book” and ECMA-338. The media may be written and read many times over the recording surface of the disc using the phase-change rewritable effect.

2.2.60 DVD-RW DL

DVD-RW Dual Layer media that comply with DVD Specifications for Re-recordable Disc for Dual Layer (DVD-RW for DL) Part 1 Physical Specifications.

2.2.61 DVD-RW SL

DVD-RW Single Layer media that comply with DVD Specification for Re-recordable Disc (DVD-RW) part one Physical specifications.

2.2.62 DVD Disc Manufacturing Information

The DVD Disc Manufacturing Information is recorded in the DVD Control Data Zone and contain information supplied by disc manufacturer.

2.2.63 DVD media

Term that is used when referring to media that conforms to the DVD standards.

2.2.64 DVD Reference Code

The DVD Reference code is comprised of 2 ECC blocks (32 sectors) in the Lead-in Area and used for the adjustment of the equalizer system of the drive hardware.

2.2.65 DVD Standard

Comprised of one or more of the following documents available from the DVD Forum:

- DVD Specification for Read only Disc Part 1 Physical Specifications
- DVD Specification for Read only Disc Part 2 File system Specifications
- DVD Specification for Read only Disc Part 3 Video Specifications
- DVD Specification for Read only Disc Part 4 Audio Specifications
- DVD Specification for Recordable Disc Part 1 Physical Specifications
- DVD Specification for Recordable Disc Part 2 File system Specifications
- DVD Specifications for Recordable Disc for Authoring Part 1 Physical Specifications
- DVD Specifications for Recordable Disc for Authoring Part 2 File system Specifications
- DVD Specifications for Recordable Disc for General Part 1 Physical Specifications
- DVD Specifications for Recordable Disc for General Part 2 File system Specifications
- DVD Specifications for Recordable Disc for Dual Layer (DVD-R for DL) Part 1 Physical Specifications
- DVD Specification for Rewritable Disc Part 1 Physical Specifications
- DVD Specification for Rewritable Disc Part 2 File system Specifications
- DVD Specification for Re-recordable Disc (DVD-RW) Part 1 Physical Specifications
- DVD Specification for Re-recordable Disc (DVD-RW) Part 2 File system Specifications
- DVD Specifications for Re-recordable Disc for Dual Layer (DVD-RW for DL) Part 1 Physical Specifications
- DVD Specification for Rewritable/Re-recordable Discs Part 3 Video Recording (DVD-VR)

2.2.66 EAN (European Article Number)

Controlled by the GS1 (formerly known as EAN International) located at rue Royale 29, 1000 Brussels, Belgium.

2.2.67 ECC (Error Correction/Correcting Code)

Code for detecting and correcting errors in a data field.

2.2.68 ECC block

An ECC block is a self-contained block of data and error correction codes. On DVD media, this is a group of 16 DVD sectors. On HD DVD media, this is a group of 32 HD DVD sectors.

2.2.69 EDC (Error Detection Code)

Code for detecting an error in a data field.

2.2.70 Field

A Field is a group of one or more contiguous bits.

2.2.71 Fixed Middle Area

On DVD-R DL and DVD-RW DL discs, if the start PSN of Middle Area on L0 is the PSN of the next of the last sector of the Data Recordable Area on L0 specified by the pre-recorded or embossed Control Data Zone in the Lead-in Area, the Middle Area is referred to as Fixed Middle Area.

2.2.72 Format

The arrangement or layout of information on media.

2.2.73 Frame

A sector on CD media. Also the F field unit of a MSF CD address. The smallest addressable unit in the main channel.

2.2.74 Groove

The wobbled guidance track on recordable media. (e.g., CD-R and DVD-R).

2.2.75 Hardware Defect Management

A Defect Management that the defect list is managed by the logical unit. See 2.2.42 Defect Management.

2.2.76 HD DVD Control Data Zone

The HD DVD Control Data Zone is comprised of 192 ECC blocks in the System Lead-in Area of a HD DVD medium. The content of 32 sectors in each Block is repeated 192 times. This area contains information concerning the disc.

2.2.77 HD DVD Disc Manufacturing Information

The HD DVD Disc manufacturing information is recorded in the HD DVD Control Data Zone and contain information supplied by disc manufacturer.

2.2.78 HD DVD media

Term that is used when referring to media that conforms to the HD DVD standards.

2.2.79 HD DVD Reference Code

The HD DVD Reference code is comprised of 1 ECC block (32 sectors) in the Lead-in Area and used for the adjustment of the equalizer system of the drive hardware.

2.2.80 HD DVD Standard

Comprised of one or more of the following documents available from the DVD Forum:

- DVD Specifications for High Density Read-only Disc part one Physical Specifications
- DVD Specifications for High Density Read-only Disc part two File system specifications
- DVD Specifications for High Definition Video (HD DVD-Video)
- DVD Specifications for High Density Recordable Disc part one Physical Specifications
- DVD Specifications for High Density Recordable Disc part two File system specifications
- DVD Specifications for High Density Rewritable Disc part one Physical Specifications
- DVD Specifications for High Density Rewritable Disc part two File system specifications
- DVD Specifications for High Definition Video Recording (HD DVD-VR)

2.2.81 Hold Track State

When a Multi-Media logical unit enters the hold track state the optical pick-up is maintained at an approximately constant radial position on media. This allows a paused operation to be resumed without latency due to seeking. However, rotational latency may be incurred.

2.2.82 Host Certificate Challenge

Data used during an AACS authentication process. This is used for the logical unit to verify legitimacy of the host.

2.2.83 Host Key

Data used during an AACS authentication process. This is used, together with the Drive Key to generate the Bus Key.

2.2.84 ID

A four byte field in the header of DVD/HD DVD sectors which contains sector information and a physical sector number.

2.2.85 IED (ID Error Detection code)

Code for detecting errors in an ID field on DVD/HD DVD media.

2.2.86 Incremental recording

Recording of the disc by several distinct recording actions (for example, at different times using different recording logical units). For DVD-R, in this recording mode, the specified linking scheme either 2 KB link or 32 KB link is used. For HD DVD-R, lossless linking scheme is used at any time.

2.2.87 Index

An index is a subdivision of a logical track. A track may have indices from 0 to 99. Index numbers within a track are sequential.

2.2.88 Invalid

Invalid refers to a reserved or unsupported field or code value.

2.2.89 Last Recorded Address (LRA)

Last Recorded Address is the Logical Block Address of the last recorded user data Block in an RZone.

2.2.90 Layer

The recorded information is in Layers as seen from one side of a DVD/HD DVD Disc. There are Single and Dual Layer discs. In the case of Dual Layer discs the data is recorded using either OTP or PTP. Layers are numbered sequentially, starting from 0. See 2.2.152 Single Layer and 2.2.49 Dual Layer.

2.2.91 Layer Jump Address

The Layer Jump Address is the logical block address on a Layer that cause NWA transition to the other Layer in an RZone during the Layer Jump recording. In the case of DVD-R Dual Layer discs, the end logical block address of User Data Area on L0 and the logical block address that is located immediately before the Shifted Middle Area are also Layer Jump Addresses.

2.2.92 Layer Jump recording

A kind of sequential recording to perform recording on Layer 0 and Layer 1 alternately on a Dual Layer medium. On DVD-R Dual Layer discs, the Format 4 RMD is used to perform Layer Jump recording.

2.2.93 LBA (Logical Block Address)

The LBA defines a mapping mode to a linear address space.

2.2.94 LBA Extent

The LBA Extent is a collection of the sectors to which consecutive LBAs are assigned. The LBA Extent is a part or whole of the LBA Space.

2.2.95 LBA Space

The LBA Space is a collection of the sectors in between the LBA 0 to the maximum LBA of the medium. Only one active LBA Space exists on mounted medium or the online Format-layer.

Typically, the LBA Space of the formatted or finalized random readable media is from LBA 0 to maximum LBA reported by READ CAPACITY command. The LBA Space of the sequential recording media and the restricted overwrite media in Intermediate state includes the sectors which will be able to be accessed by LBA by future writing.

2.2.96 Lead-in Area

The CD Lead-in Area is the area on a CD disc preceding the first track. The area contains the TOC data and precedes each program area. The main channel in the Lead-in Area contains audio or data null information. This area is coded as track zero but is not directly addressable via the command set. The Q sub-channel in this area is coded with the Table of Contents information.

The DVD Lead-in Area is the area comprising physical sectors 1,2 mm wide or more adjacent to the inside of the Data Area. The area contains the Control data and precedes the Data Area.

The HD DVD Lead-in Area is the area consists of 3 parts; System Lead-in Area, Connection area and Data Lead-in Area.

2.2.97 Lead-out Area

The CD Lead-out Area is the area on a CD disc beyond the last information track. The main channel in the Lead-out Area contains audio or data null information. This area is coded as track AAbcd but is not directly addressable via the command set.

The DVD Lead-out Area is the area comprising physical sectors 1,0 mm wide or more adjacent to the outside of the Data Area in Single Layer discs and Dual Layer PTP (Parallel Track Path) discs, or area comprising physical sectors 1,2 mm wide or more adjacent to the inside of the Data Area in Layer 1 of OTP (Opposite Track Path) discs.

The HD DVD Lead-out Area consists of 1 or 3 parts as follows:

- HD DVD-ROM (OTP) Lead-out Area consists of System Lead-out Area, Connection area and Data Lead-out Area.
- HD DVD-ROM (PTP)/R/RAM Lead-out Area consists of Data Lead-out Area only.

2.2.98 L-EC

Layered Error Correction (L-EC) is an error correction technique used with CD-ROM sectors.

2.2.99 Linking Loss Area

For DVD-R/-RW, area that is used for linking the new recording data after the previous recording data when Incremental recording or Layer Jump recording mode are selected.

2.2.100 Link size

The minimum additional consumption of user data area except padding of unrecorded user data sectors in the last ECC block that is performed at the end of the user data recording.

2.2.101 Logical Block

See “Block.”

2.2.102 Logical Track

A track is a logical sub-division of the CD media. A disc has from one to ninety-nine tracks. The data within a track is always of the same type. A track may be either CD-ROM or CD-Audio. A disc may start at any track number.

2.2.103 logical unit

A physical or virtual peripheral device addressable through a device.

2.2.104 LPP (Land Pre-pit)

Pits embossed on land during the manufacture of a DVD-R disc substrate which contains address information.

2.2.105 L-RMZ

RMZ located in the Data Lead-in Area.

2.2.106 LUN (logical unit Number)

The address of a logical unit.

2.2.107 Magazine

A container for multiple discs or cartridges.

2.2.108 Medium

A single disc.

2.2.109 Middle Area

Area comprising physical sectors 1,0 mm wide or more adjacent to the outside of the Data Area in OTP (Opposite Track Path) disc on both Layers of Dual Layer media.

On DVD-R DL and DVD-RW DL media, the Middle Area represents either the Shifted Middle Area or the Fixed Middle Area.

2.2.110 MMC

MMC (Multi-Media Commands) is one of SCSI-3 standards. MMC describes the command set for multi-media devices such as CD, DVD based upon (but not necessarily compatible with) SCSI-2.

2.2.111 Morph

An Event that occurs whenever the data that would be reported by a GET CONFIGURATION command changes.

2.2.112 MSF Address

(Minute/Second/Frame) The physical address, expressed as a sector count relative to either the beginning of the medium (absolute) or to the beginning of the current track (relative). As defined by the CD standards, each F field unit is one sector, each S field unit is 75 F field units, each M field unit is 60 S field units. Valid contents of F fields are binary values from 0 through 74. Valid contents of S fields are binary values from 0 through 59. Valid contents of M fields are bcd values from 0 through 79 in the user Data Area.

2.2.113 Multi-Media logical unit

A logical unit that conforms to MMC device model. The device type of the Multi-Media logical unit is 05h. The device type is identified by the contents of the Peripheral Device Type field in the standard INQUIRY data.

2.2.114 Next Border Marker

The sector that is a flag to indicate whether the next Border-in Area, Bordered Area and Border-out Areas exist or not.

2.2.115 Next Writable Address (NWA)

Data appendable address during sequential recording and Restricted Overwrite mode with intermediate state.

2.2.116 One

“One” represents a true signal value or a true condition of value.

2.2.117 OPC (Optimum Power Calibration)

A process to determine the optimum recording power for a given disc/logical unit system.

2.2.118 OTP (Opposite Track Path)

An OTP disc has a Lead in, two separated user areas, Lead-out, and a Middle Area. The physical sector number (PSN) of sectors in L0 increases toward the Middle Area. The physical sector number (PSN) of sectors in Layer 1 are numbered with the complement of the L0 sector below it. The sector numbering in Layer 1 increases from the Middle Area to the Lead-out Area. The relation between the Logical Block Address and the physical sector number is shown in Figure 7 - *Physical and logical layout of OTP DVD-ROM DL/R DL/RW DL media* on page 87 and Figure 124 - *Physical and logical layout of Opposite Track Path HD DVD-ROM media* on page 301.

2.2.119 Output Port

The Output Port is a means for connecting to data ports other than the host interface, e.g., Audio.

2.2.120 Packet

A recording unit which includes an integer number of contiguous sectors. For CD media, a Packet includes a Link block, four Run-in blocks, two Run-out blocks and User Data blocks. For DVD/HD DVD media, a Packet includes ECC block(s).

2.2.121 Page

Several commands use regular parameter structures that are referred to as pages. These pages are identified with a value known as a page code.

2.2.122 Pause Area

A “Pause Area” is a transition area at the beginning or end of a CD audio track encoded with audio silence. This transition area is required where the CD audio track immediately precedes a CD data track.

2.2.123 PCA (Power Calibration Area)

Area used for Optimum Power Calibration. This area ends at the start of the RMA or PMA.

2.2.124 Phase-change

A physical effect in which a laser beam irradiated area of a recording film is heated so as to reversibly change from an amorphous state to a crystalline state, and vice versa.

2.2.125 Physical Interface Asynchronous Notification

Physical Interface is a conductive device or electrical connector and its protocol joining the host and the device together, i.e. ATAPI, SCSI, or IEEE 1394. Asynchronous notification is a mechanism for a device to send a notification to the host that the device requires attention.

2.2.126 Physical Track

A concept of a continuous spiral where the physical track begins at a point in the spiral continuing for 360 degrees along the spiral. A spiral contains multiple physical tracks.

2.2.127 PI error correction

An error correction process of user data in an ECC block using inner-code parity (PI) of the ECC block.

2.2.128 PMA (Program Memory Area)

PMA is the area for temporary storage of Table of Contents entries. This area starts right after the PCA and it ends at the start of the Lead-in.

2.2.129 PO error correction

An error correction process of user data in an ECC block using outer-code parity (PO) of the ECC block.

2.2.130 Post-gap Area

Post-gap Area is a transition area at the end of a data track and is encoded with null information. This transition area is required where the data track immediately precedes an audio track.

2.2.131 Pre-gap Area

Pre-gap Area is a transition area at the beginning of a data track and is encoded with null information. This transition area is required where the data track immediately follows an audio track.

2.2.132 Pre-Groove

The wobbled guidance track on recordable media. (e.g., CD-R and DVD-R).

2.2.133 Program Area

Contains the user data on CD media.

2.2.134 PSN (Physical Sector Number)

Each sector on DVD/HD DVD media is addressable by the logical unit using an address called the Physical Sector Number or PSN. Not all of these sectors are addressable using an LBA. In the SCSI world this address is normally called the Physical Block Address or PBA.

2.2.135 PTP (Parallel Track Path)

A PTP disc has a Lead in, user area and Lead-out in each layer respectively. The physical sector number (PSN) of both layers increase to the Lead-out in parallel. The relation between the Logical Block Address and the physical sector number is shown in Figure 6 - *Physical and logical layout of PTP DVD-ROM Dual Layer media* on page 86 and Figure 123 - *Physical and logical layout of Parallel Track Path HD DVD-ROM media* on page 300.

2.2.136 RDZ (RMD duplication zone)

RDZ is the zone for recording the latest RMD. This zone starts right after the Guard track zone and ends at the start of the L-RMZ.

2.2.137 Read/Modify/Write

Read/Modify/Write operation is a type of write operation and performs the following operation.

- Read data from a medium into a data buffer using the smallest writable unit (e.g., Packet/ECC block).
- Modify portions of that data with the data from the host.
- Write these data to the medium using the smallest writable unit.

2.2.138 Reed-Solomon code

An error detection and/or correction code which is particularly suited to the correction of errors which occur in bursts or are strongly correlated.

2.2.139 Region Code

A value used to identify a region of the world for DVD. Currently, there are only six regions defined.

2.2.140 Relative M/S/F Field

See “MSF Address.”

2.2.141 RMA (Recording Management Area)

RMA is the area for recording RMD. This area starts right after the PCA and it ends at the start of the Lead-in.

2.2.142 RMD (Recording Management Data)

The data to be stored in RMA/RMZ/RDZ.

2.2.143 RMZ (Recording management zone)

RMZ is the zone for recording RMD. Three kinds of RMZ formats are defined, L-RMZ, B-RMZ and U-RMZ.

2.2.144 RPC (Regional Playback Control)

The technique used to prevent CSS movie content from being viewed outside the content provider’s specified region(s) of the world.

2.2.145 RZone

The RZone is a collection of logical blocks with a defined sequence of recording. The RZone is a structure to manage a data appendable point. The logical blocks on a layer in an RZone are contiguous.

In case of Layer Jump recording capable medium, LBA may be discontinuous at a Layer transition point in an RZone.

2.2.146 SBC

SBC (SCSI Block Commands) is one of SCSI-3 standards. SBC describes the command sets for block-oriented direct-access devices such as magnetic disk drives.

2.2.147 Sector

For CD media, “Sector” refers to the data contained in one frame. In the CD-ROM standard document the term Block is used for this unit. Equivalent to an MSF Frame.

For DVD/HD DVD media, “Sector” is the smallest addressable part of a medium.

2.2.148 SecurDisc

A system that allows to protect data on recordable optical media.

2.2.149 Sequential Recording

A method for recording sectors contiguously onto the media. The data appendable address is indicated by NWA.

2.2.150 Session

A contiguous area of a Disc that contains a Lead-in, a Program Area (PA), and a Lead-out.

2.2.151 Shifted Middle Area

On DVD-R DL and DVD-RW DL discs, if the start PSN of Middle Area on L0 is equal to or smaller than the PSN of the last sector of the Data Recordable Area on L0 specified by the pre-recorded or embossed Control Data Zone in the Lead-in Area, the Middle Area is referred to as Shifted Middle Area.

2.2.152 Single Layer

There is exactly one recording layer accessible from a given side of the media.

2.2.153 Single Sided

The DVD/HD DVD disc mechanical structure of two transparent substrates joined together such that the recorded layers are on the inside. Single sided discs have one recorded side and one unrecorded side.

2.2.154 SPC

SPC (SCSI Primary Commands) is one of SCSI-3 standards. SPC contains the definition of the basic commands for all SCSI devices. SPC is used in conjunction with a standard for the specific device type.

2.2.155 Software Defect Management

A Defect Management that the defect list is managed by the host. See 2.2.41 Defect management.

2.2.156 Sub-channel

CD media have a main channel and a sub-channel. The sub-channel area has eight parts called P, Q, R, S, T, U, V, and W. The Q-sub-channel contains information useful to the controller and drive, such as the control field and MSF addresses.

2.2.157 SY0

See “Block Sync.”

2.2.158 Terminator

The data to be recorded as a Data Lead-out Area.

2.2.159 Title Key

A value used during the encryption/decryption process of user data on DVD media.

2.2.160 TOC (Table Of Contents)

The table of contents has information on the type of disc and the starting address of the tracks. This information is encoded in the Q sub-channel, in the Lead-in Area of CD media.

2.2.161 Track Relative Logical Address

An address of a Logical Blocks relative to the beginning of a logical track.

2.2.162 Transition Area

Sector at the beginning or end of logical tracks e.g., Pause Area, Pre-Gap, Lead-out, Post-gap that are coded with null information are called transition areas. Where required by the media standards, these areas have minimum lengths. The maximum lengths are not specified. Transition areas at the beginning of a logical track are encoded with index zero.

2.2.163 UPC (Universal Product Code)

Controlled by the GS1 US (formerly known as UC Council, Inc.,) located at 1009 Lenox Drive, Suite 202 Lawrenceville, NJ 08648.

2.2.164 U-RMZ

RMZ located in the User Data Area.

2.2.165 User Data

The data that is normally transferred across the logical unit interface by and for read and write commands.

2.2.166 Volume

1. A side of a medium. 2. The perceived loudness of audio.

2.2.167 Write back cache

During write operation, the data that is to be written to the medium is first stored in the cache memory, then written to the medium at a later time. The command may complete prior to the data being written to the medium.

2.2.168 Zero

Zero is a false signal value or a false condition of a variable.

2.3 Keyword definitions

Several keywords are used to differentiate between different levels of requirements and optionality, as follows:

2.3.1 expected

A keyword used to describe the behavior of the hardware or software in the design models assumed by this specification. Other hardware and software design models may also be implemented.

2.3.2 may

A keyword that indicates flexibility of choice with no implied preference.

2.3.3 shall

A keyword indicating a mandatory requirement. Designers are required to implement all such mandatory requirements to ensure interoperability with other products.

2.3.4 should

A keyword indicating flexibility of choice with a strongly preferred alternative. Equivalent to the phrase "it is recommended."

2.3.5 obsolete

A keyword indicating items that were defined in prior version of this specification but have been removed from this document.

2.3.6 restricted

A keyword indicating items that are not defined in this specification but are defined in SCSI standards. A restricted field is treated as a reserved in this specification.

2.3.7 *mandatory*

A keyword indicating items required to be implemented as defined by this specification.

2.3.8 *optional*

A keyword that describes features which are not required to be implemented by this specification. However, if any optional feature defined by the specification is implemented, it *shall* be implemented as defined by the specification. Describing a feature as optional in the text is done to assist the reader. If there is a conflict between text and tables on a feature described as optional, the table *shall* be accepted as being correct.

2.3.9 *reserved*

A key word referring to bits, bytes, words, fields and code values that are set aside for future standardization. Their use and interpretation may be specified by future extensions to this or other specification. A reserved bit, byte, word or field *shall* be set to zero, or in accordance with a future extension to this specification. The recipient *shall* not check reserved bits, bytes, words or fields. Receipt of reserved code values in defined fields *shall* be treated as an error.

2.4 *Symbols, abbreviations and acronyms*

Table 4 - The list of symbols, abbreviations and acronyms

Symbols /abbreviation	Definition
BB	Buffer Block
Border	Bordered Area
Border-in	Border-in Area
Border-out	Border-out Area
CDZ	Control Data Zone
CE	Consumer Electronics
DAO	Disc-at-Once
DL	Dual Layer
IM	Intermediate Marker
ISO	International Organization for Standardization
L0	Layer 0
L1	Layer 1
Lead-in	Lead-in Area
Lead-out	Lead-out Area
LJ	Layer jump
LJB	Layer Jump Block
LLA	Linking Loss Area
LRA	Last Recorded Address
LSB	Least Significant Bit
MA	Middle Area
MSB	Most Significant Bit
NWA	Next Writable Address
PC	Personal Computer
R-PFI	R-Physical Format Information
SAO	Session-at-Once
SL	Single Layer
TAO	Track-at-Once

3.0 CD model

Data transfer may begin with any of the consecutively numbered logical blocks. Data on CD logical units is addressed the same as for (magnetic) direct-access logical units. Some CD logical units support a separate information stream (e.g., audio and/or video but referred to as audio in this Section) transmitted via a connection other than the ATA Bus. This specification defines commands for controlling these other information streams for CD logical units.

CD logical units are designed to work with any disc that meets IEC 908. Many new logical units read CD data discs, digital audio discs, and audio-combined discs (i.e., some Tracks are audio, some Tracks are data).

Note: Important notice to implementor of CD-R and CD-RW applications

There are still large number of logical units that can only record to CD-R and CD-RW media, and they are mostly MMC-1 compatible. This specification defines many commands, but implementor of this specification need to be notified that Legacy CD-R/RW logical units may only recognize the MMC-1 command scheme.

Typical commands that are supported in this category of logical units are as follows:

*BLANK
CLOSE TRACK/SESSION
FORMAT UNIT
INQUIRY
MODE SELECT
MODE SENSE
PREVENT ALLOW MEDIUM REMOVAL
READ BUFFER CAPACITY
READ DISC INFORMATION
READ TOC/PMA/ATIP
READ TRACK INFORMATION
REQUEST SENSE
RESERVE TRACK
SET CD SPEED
START STOP UNIT
SYNCHRONIZE CACHE (10)
TEST UNIT READY
WRITE (10)*

3.1 CD media organization

The formats written on the CD-ROM and CD-DA (Digital Audio) media require special interfacing considerations.

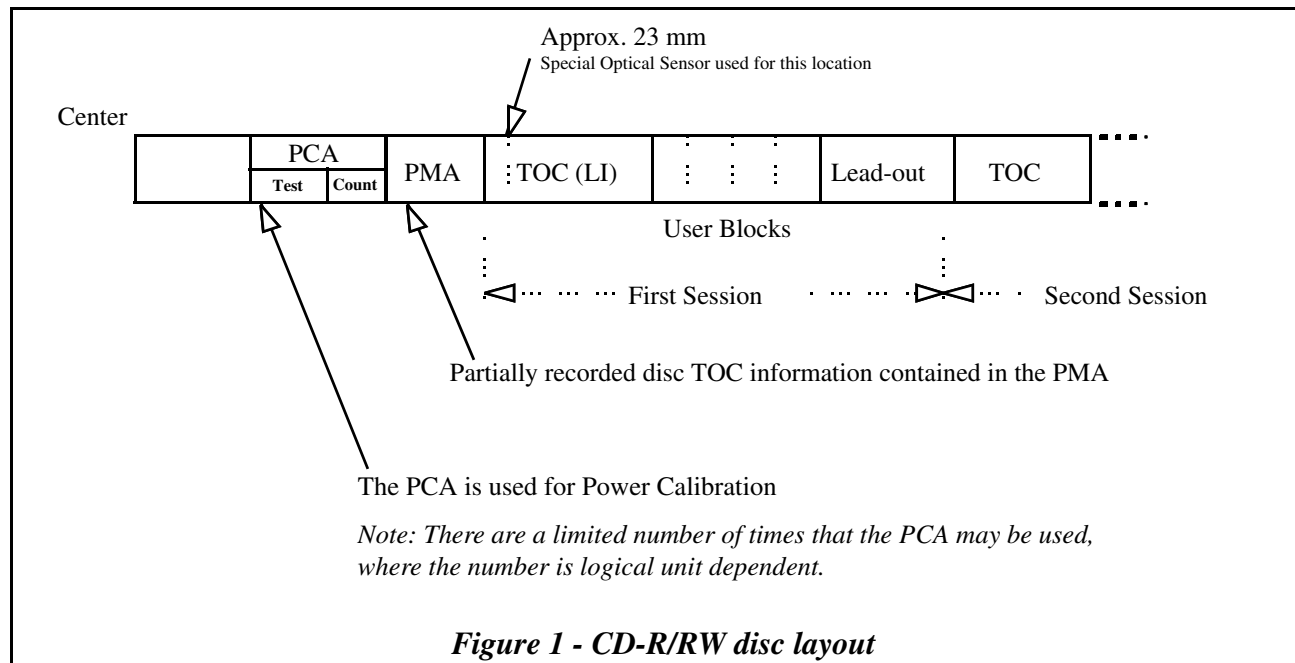
Discs may contain either audio, data or a mixture of the two. Table 5 gives an example of an audio-combined disc to illustrate the relationship between the logical block addresses reported and the MSF address encoded on the media.

Note: The term "Frame" is used in two different ways in the CD media standards. The intended meaning can only be determined from the context. Whenever possible, this description replaces the larger data unit with the more familiar term sector. The primary exception to this policy is the use of frame when referring to the MSF address. In the MSF context, one frame (F field unit) equals one sector. On a typical two channel CD-DA media, each frame (F field unit) is played in 1/75th of a second.

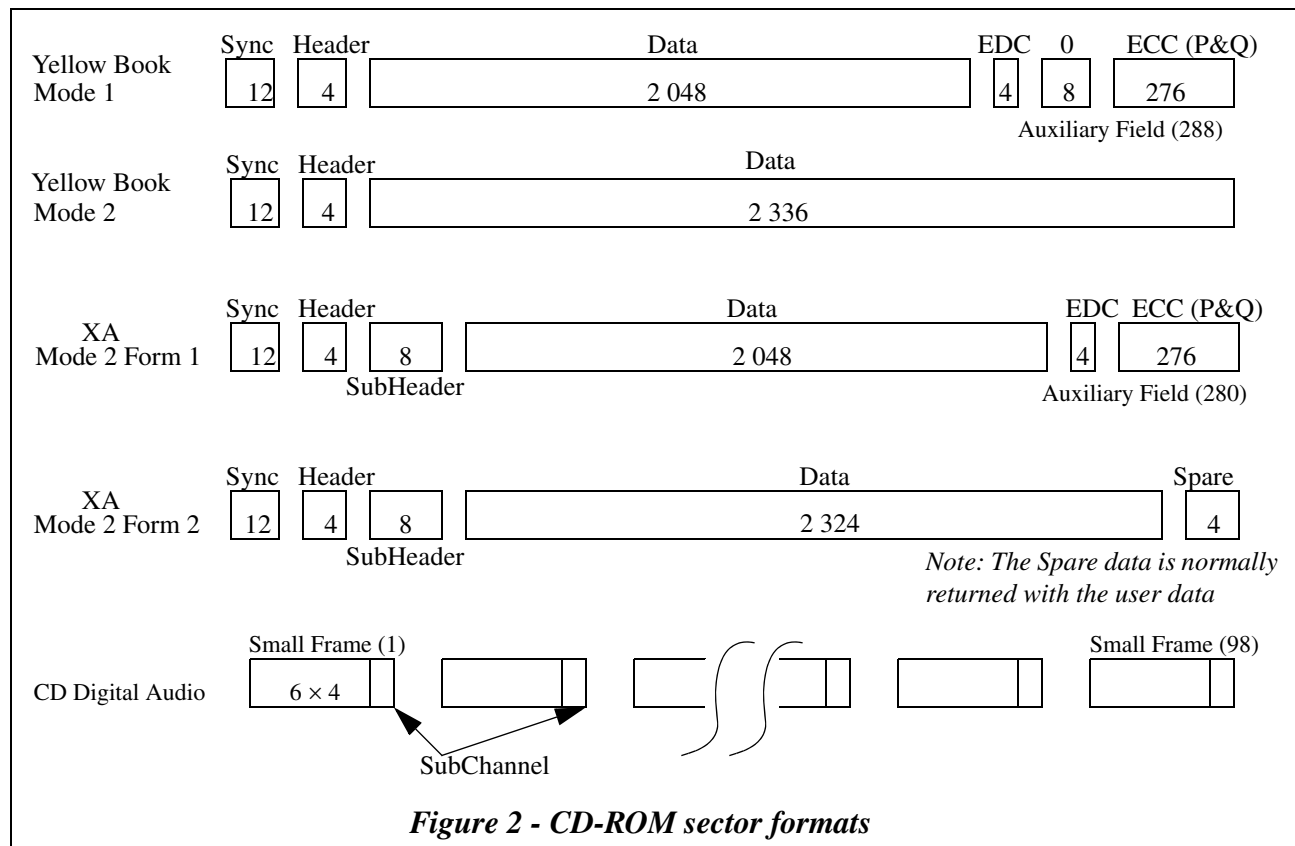
Table 5 - Example mixed mode CD disc layout

Block Description	Logical Address (Decimal)	Absolute MSF Address ^a (Hex)	Track and Index	Sector is Info or is Pause	Mode Audio or Data	CD-ROM Data Mode ^b
Lead-in Area ^c	---	---	0/-	---	Audio	---
Pre-gap ^c	---	00/00/00	1/0	Pause	Data	Null
1st Track data	0 000 ^d	00/02/00 ^e	1/1	Info	Data	L-EC
2nd Track data	6 000 ^d	01/16/00 ^e	2/1	Info	Data	L-EC
	7 500	01/2A/00	2/2	Info	Data	L-EC
Post-gap	9 000	02/02/00	2/3	Pause	Data	Null
Pause-silence	9 150	02/04/00	3/0	Pause	Audio	---
3rd Track audio	9 300	02/06/00	3/1	Info	Audio	---
	11 400	02/22/00	3/2	Info	Audio	---
4th Track audio	21 825	04/35/00	4/1	Info	Audio	---
Pre-gap part 1	30 000	06/2A/00	5/0	Pause	Audio	---
Pre-gap part 2	30 075	06/2B/00	5/0	Pause	Data	Null
5th Track data	30 225	06/2D/00	5/1	Info	Data	L-EC
Last information	263 999	3A/29/4A	5/1	Info	Data	L-EC
Post-gap	264 000	3A/2A/00	5/2	Pause	Data	Null
Lead-out Track	264 150	3A/2C/00 ^f	AA/0	Pause	Audio	---

- a. Absolute MSF address repeated in the header field of data blocks.
- b. The CD-ROM data mode is stored in the header of data Tracks. This indicates that the block is part of a data pre-gap or post-gap (null), that this is a data block using the auxiliary field for L-EC symbols (ECC - CD-ROM data mode one), or that this is a data block using the auxiliary field for user data (CD-ROM data mode two).
- c. Table of contents information is stored in the sub-channel of Lead-in Area. The Lead-in Area is coded as Track zero. Track zero and the initial 150 sector pre-gap (or audio pause) are not accessible with logical addressing.
- d. Exact value returned by READ TOC/PMA/ATIP command.
- e. Value stored in Table of Contents with zero tolerance.
- f. Value stored in Table of Contents; exact, if Lead-out Track is coded as data, or plus or minus 75 blocks if coded as audio.



The physical format defined by the CD-ROM media standards provides 2 352 bytes per sector. For usual computer data applications, 2 048 bytes are used for user data, 12 bytes for a synchronization field, 4 bytes for a sector address tag field and 288 bytes - the auxiliary field - for L-EC (CD-ROM data mode 1). In less critical applications, the auxiliary field may also be used for user data (CD-ROM data Mode 2 / Form 2).



A CD logical sector size is 2 048, 2 052, 2 056, 2 324, 2 332, 2 336, 2 340 or 2 352 bytes per sector. These values correspond to the user data plus various configurations of header, subheader and EDC/ECC.

This same area of the CD-ROM or CD audio media may store 1/75th of a second of two channel audio information formatted according to the CD-DA specification. (These audio channels are usually the left and right components of a stereo pair.) An audio only density code value may be used to declare an area of the media to be invalid for data operations.

For data and mixed mode media (those conforming to ISO/IEC 10149), logical block address Zero *shall* be assigned to the block at MSF address 00/02/00. For audio media (those conforming only to IEC 908), logical block address Zero *shall* be assigned to the actual starting address of Track 1. This may be approximated by using the starting address of Track 1 contained in the Table of Contents (TOC) or by assigning logical block address Zero to the block at MSF address 00/02/00.

A Track may be viewed as a partition of the CD address space. The CD media contains from one to ninety-nine Tracks. All information sectors of a Track are required to be of the same type (audio or data) and mode. Each change in the type of information on the disc requires a change in Track number. A disc containing both audio and data would have at least two Tracks, one for audio and one for data.

The Tracks of a CD media are numbered consecutively with values between 1 and 99. However, the first information Track may have a number greater than 1. Tracks have a minimum length of 300 sectors including any transition area that is part of a Track.

The CD media standards require transition areas between Tracks encoded with different types of information. In addition, transition areas may be used at the beginning or end of any Track. For audio Tracks the transition areas are called pause areas. For data Tracks, transition areas are called pre-gap and post-gap areas. See Table 5 - *Example mixed mode CD disc layout* on page 72 for an example. The IEC 908 and ISO/IEC 10149 standards specify minimum time durations for these areas. Maximum time durations are not specified.

Transition areas are formatted and the logical address continues to increment through transition areas. Some media (i.e., discs with only one Track) may not have transition areas. The means to determine the location of the transition areas is vendor or application-specific and is addressed by other standards (e.g., ISO 9660).

CD is unique in the respect that some logical blocks on a disc may not be accessible by all commands. SEEK commands may be issued to any logical block address within the reported capacity of the disc. READ (10) commands cannot be issued to logical blocks that occur in some transition areas, or to logical blocks within an audio Track. PLAY AUDIO (10) commands cannot be issued to logical blocks within a data Track.

CD media have Lead-in and Lead-out Areas. These areas are outside of the user-accessible area as reported in the READ CAPACITY command data. The Lead-in Area of the media is designated Track zero. The Lead-out Area is designated Track AAh. The sub-channel Q in the Lead-in Track contains a Table of Contents (TOC) of the disc.

Note: The READ FORMAT CAPACITIES command returns the logical block address of the last block prior to the Lead-out Area. This location may be in a transition area and therefore not a valid address for read operations.

The Table of Contents gives the absolute MSF location of the first information sector of each Track. Control information (e.g., audio/data, method of audio encoding) for each Track is also given in the TOC. However, the TOC does not distinguish between the different modes of data Tracks (i.e., CD-ROM Data Mode 1 vs. CD-ROM Data Mode 2).

The MSF locations of the beginning of data Tracks in the TOC are required to be accurate; however, the TOC values for audio Tracks have a tolerance of plus or minus 75 sectors. Information from the TOC can be used to reply to a READ CAPACITY command. When this is done, the logical unit implementor *shall* consider the possible tolerances and return a value that allows access to all information sectors.

An index is a partition of a Track. Pre-gap areas are encoded with an index value of zero. Pause areas at the beginning of audio Tracks are also encoded with an index value of zero. The first information sector of a Track has an index value of one. Consecutive values up to 99 are permitted. Index information is not contained in the TOC. Not all sectors are encoded with the index value in the Q-sub-channel data (the requirement is 9 out of 10). A sector without an index value is presumed to have the same index as the preceding sector.

Tracks and indexes are not defined to be any particular length, (except for a minimum Track length of 300 sectors.) A CD disc may be created with a single information Track that has a single index; or with 99 information Tracks, each with 99 indices.

The sub-channel information which is part of each sector includes a Track relative MSF location value giving the distance from the first information sector of the Track. On the media, this value decreases during the pre-gap area (sectors with index values of 0) and increases for the rest of the Track. The data, returned by the READ SUBCHANNEL command with MSF bit set to zero, converts this to a Track relative logical block address (TRLBA). The TRLBA is continually increasing over the whole Track, and pre-gap areas *shall* return negative values. When the MSF bit in the READ SUBCHANNEL command is set to one, the MSF Track relative location value from the media is reported without change.

Note: The purpose of accessing MSF addresses less than 00/02/00 MSF is to retrieve information, such as packet size, from incrementally written discs. This information exists in the Track Descriptor Block in the pre-gap area. Users can read this information by scanning the area between 00/01/00 MSF to 00/02/00 MSF. While the media may contain multiple redundant copies of the pre-gap data, the logical unit shall only return one copy. The logical unit may not be able to read 00/00/00 MSF since there is no Sub-Q information before this frame. See the Orange Book Part 2 for additional details.

3.2 CD physical data format

The physical format of CD-ROM and CD-DA media uses a smaller unit of synchronization than the more familiar magnetic or optical recording systems. The basic data stream synchronization unit is a small frame. This is not the same large frame (sector) as referred to in the MSF unit. Each small frame consists of 588 bits. A sector on CD media consists of 98 small frames.

A CD small frame consists of:

1. 1 synchronization pattern (24+3 bits)
2. 1 byte of sub-channel data (14+3 bits)
3. 24 bytes of data ($24 \times (14+3)$ bits)
4. 8 bytes of CIRC code ($8 \times (14+3)$ bits) Total: 588 bits.

Data, sub-channel and CIRC bytes are encoded with an 8-bit to 14-bit code; then three merging bits are added. The merging bits are chosen to provide minimum low-frequency signal content and optimize phase lock loop performance.

3.2.1 Frame format for audio

Each small frame of an audio Track on a two-channel CD-DA or CD-ROM media consists of six digitized 16-bit samples of each audio channel. These 24 bytes of data are combined with a synchronization pattern, CIRC bytes and a sub-channel byte to make a frame. Each frame takes approximately 136,05 μ s to play. This gives a sampling rate of 44,1 kHz for each channel. The sub-channel information creates the higher level sector grouping for audio Tracks.

3.2.2 Sector format for data

The data bytes of 98 small frames comprise the physical unit of data referred to as a sector. (98 small frames times 24 bytes per small frame equals 2 352 bytes of data per sector.)

A sector that contains CD-ROM Data Mode 1 data has the following format:

1. 12 byte synchronization field
2. 4 byte CD-ROM data header:
 - Absolute M field
 - Absolute S field
 - Absolute F field
 - CD-ROM data mode field
3. 2 048 byte user data field
4. 4 byte error detection code
5. 8 bytes zero
6. 276 byte layered error correction code

A sector that contains CD-ROM Data Mode 2 data has the following format:

1. 12 byte synchronization field
2. 4 byte CD-ROM data header
 - Absolute M field
 - Absolute S field
 - Absolute F field
 - CD-ROM data mode field
3. 2 336 byte user data field (2 048 bytes of mode 1 data plus 288 bytes of auxiliary data)

Note: Many logical units are capable of returning CD-ROM data mode one data in a CD-ROM data mode two format. This allows the user to investigate the error detection and error correction codes. However data encoded as CD-ROM data mode two cannot be read as CD-ROM data mode one data.

3.2.3 Sub-channel information formats

The sub-channel byte of each frame is assigned one bit for each of the 8 sub-channels, designated P, Q, R, S, T, U, V, W.

Sub-channel P is a simple flag bit that may be used for audio muting control and Track boundary determination.

Sub-channel Q has a higher level of structure. All the sub-channel Q bits of a sector define the sub-channel Q information block. (For audio Tracks, decoding the Q sub-channel is the only way to distinguish sector boundaries.)

The sub-channel Q block consists of 98 bits, one bit from each small frame in a sector. Three formats are defined for the sub-channel Q information block. The first format provides location information and is defined as follows:

1. 2-bit sub-channel synchronization field
2. 4-bit ADR field (defines the format)
3. 4-bit control field (defines the type of information in this sector)
4. 8-bit Track number
5. 8-bit index number
6. 24-bit Track relative MSF address
7. 8 bits Reserved (0)
8. 24-bit Absolute MSF address
9. 16-bit CRC error detection code

This format is required to exist in at least nine out of ten consecutive sectors.

The second and third formats are optional. If used, they *shall* exist in at least one out of 100 consecutive sectors. They include the absolute frame byte of the MSF address to provide location information continuity.

The second format gives the catalogue number of the disc (UPC/EAN bar code number). This information is constant over the whole media.

The third format gives the International Standard Recording Code (ISRC) for each Track. The ISRC is defined in ISO 3901. This format is not present on Lead-in or Lead-out Tracks and may change only after the Track number changes.

3.3 CD audio error reporting

PLAY AUDIO commands with the immediate bit set in the audio control mode return status as soon as the command has been validated (which may involve a seek to the starting address). The playback operation continues and may complete without notification to the host. Error termination of audio operations *shall not* be reported to the host.

The status of the play operation may be determined by issuing a REQUEST SENSE command. The sense key is set to NO SENSE and the audio status is reported in the Additional Sense Code Qualifier field.

3.4 CD READY condition/NOT READY condition

The READY condition occurs after a disc is inserted and the logical unit has performed its initialization tasks. These tasks may include reading the Lead-in information from the media. This “READY” is different from and should not be confused with the ATA READY status. A CHECK CONDITION status *shall* be returned for the NOT READY condition only for commands that require or imply a disc access.

A NOT READY condition may occur for the following reasons:

1. There is no disc mounted.
2. The logical unit is unable to load or unload the disc.
3. The logical unit is performing an extended operation as the result of an Immediate mode command such as FORMAT UNIT or BLANK. This condition is defined in Logical Unit Not Busy condition/Busy condition.

The logical unit *shall* spin up and make the disc ready for media accesses when a new disc is detected.

After the logical unit becomes ready, the logical unit may enter the power state in which the logical unit was when the previous medium was removed.

Any media access that occurs when the logical unit is not spinning *shall* spin the media up and not generate an error. Any media access that is requested while a deferred operation is in progress (i.e., writing from a write cache) *shall not* generate an error.

Note: Accesses to the media can be satisfied from the logical unit’s cache and may not require the media to be spinning.

Some commands are allowed to generate a “NOT READY” CHECK CONDITION, and others are not. Table 299 - *NOT READY error and Timeout UNIT ATTENTION reporting (by command)* on page 508.

3.5 Logical Unit Not Busy condition/Busy condition

While a logical unit is in Logical Unit Busy condition after the logical unit becomes READY condition, the logical unit may not be able to execute some commands and will respond with CHECK CONDITION status. The following Sense Key/ASC/ASCQ are defined for possible Logical Unit Busy condition.

- 2/04/04 LOGICAL UNIT NOT READY, FORMAT IN PROGRESS,
- 2/04/07 LOGICAL UNIT NOT READY, OPERATION IN PROGRESS
- 2/04/08 LOGICAL UNIT NOT READY, LONG WRITE IN PROGRESS.

Some commands (e.g., RESERVE TRACK command, SEND OPC INFORMATION command) that do not have the Immed bit in their Command Descriptor Block may cause a Logical Unit Busy condition.

There are several cases that are not Logical Unit Busy conditions.

1. Commands that have an **Immed** bit set to one in their Command Descriptor Block may cause a Logical Unit Busy condition. During cached recording when the write buffer has become full, a logical unit may respond to a WRITE command with CHECK CONDITION status, 2/04/08 LOGICAL UNIT NOT READY, LONG WRITE IN PROGRESS. This case is not a Logical Unit Busy condition.
2. While a logical unit is recognizing a medium at the medium insertion, the logical unit responds to a TEST UNIT READY command with CHECK CONDITION status, 2/04/01 LOGICAL UNIT IS IN PROCESS OF BECOMING READY. This case is not a Logical Unit Busy condition. It is because that the logical unit may not be Ready condition if the logical unit does not support the inserted medium. The logical unit cannot show the remaining time to be not busy before the logical unit recognizes the medium.
3. A logical unit may become Busy under the conditions described above, however, the logical unit is not required to become Busy. For example, if the host sends a CLOSE TRACK/SESSION command with **Immed** bit set to one to close a track and the track is already closed, the logical unit may terminate the command with GOOD status and never enter the Logical Unit Busy condition.

3.6 CD address reporting formats (MSF bit)

Several CD specific commands can return addresses either in logical block address or in MSF format. The READ SUBCHANNEL, and READ TOC/PMA/ATIP commands have this feature.

Table 6 - MSF address format

Bit Byte	7	6	5	4	3	2	1	0
0	Reserved							
1	M Field							
2	S Field							
3	F Field							

An MSF bit of zero requests that the logical block address format be used for the absolute address field or for the offset from the beginning of the current Track expressed as a number of logical blocks in a CD Track relative address field.

An MSF bit of one requests that the MSF format be used for these fields. In certain transition areas, the relative MSF addresses are decreasing positive values. The absolute MSF addresses are always increasing positive values. The M, S, and F Fields are expressed as binary numbers.

3.7 Error reporting

If any of the following conditions occur during the execution of a command, the CD logical unit *shall* return CHECK CONDITION status. The appropriate sense key and additional sense code *shall* be set. The following list illustrates some error conditions and the applicable sense keys. The list does not provide an exhaustive enumeration of all conditions that may cause the CHECK CONDITION status.

Table 7 - Error conditions and Sense Keys

Condition	Sense Key
Invalid logical block address	ILLEGAL REQUEST
Unsupported option requested	ILLEGAL REQUEST
Attempt to read a blank block	ILLEGAL REQUEST
Attempt to play a data block as audio	ILLEGAL REQUEST
Device reset or medium change since last command	UNIT ATTENTION
Self diagnostic failed	HARDWARE ERROR
Unrecorded read error	MEDIUM ERROR / HARDWARE ERROR
Recovered read error	RECOVERED ERROR
Overrun or other error that might be resolved by repeating the command	ABORTED COMMAND

In the case of an invalid logical block address, the sense data information field *shall* be set to the logical block address of the first invalid address.

In the case of an attempt to read a blank or previously unwritten block, the sense data information field *shall* be set to the logical block address of the first blank block encountered. The data read up to that block *shall* be transferred.

There are other special error situations for CD logical units. The following cases *shall* cause CHECK CONDITION status, 5/63/00 END OF USER AREA ENCOUNTERED ON THIS TRACK:

1. a post-gap area is encountered (i.e., a block with CD-ROM Data Mode 0);
2. a pre-gap area is encountered (i.e., a block with index equal to 0);
3. The information type (e.g., Data Mode vs. Audio) changes.

When not performing audio playback, if the logical block address requested is not within a data Track, the command *shall* be terminated with CHECK CONDITION status, 5/64/00 ILLEGAL MODE FOR THIS TRACK. This applies to audio-combined and audio media.

3.8 Recording for CD media

There are several kinds of writing method of recording data in CD media. Session At Once, Track At Once, and Packet Writing are all used as methods of recording CD media. There is a special case of Session At Once recording known as Disc At Once. Packet Writing can be further classified into Variable Packet Writing and Fixed Packet Writing.

3.8.1 Packet layout for CD

The layout of a Packet on CD media is shown in Figure 3. Each packet starts with Link block followed by four Run-in blocks. The User data blocks are placed directly after the Run-in blocks. Finally, two Run-out blocks are located following the User data blocks. In the case of Fixed packet writing, the size of each Packet in a Track is constant in length.

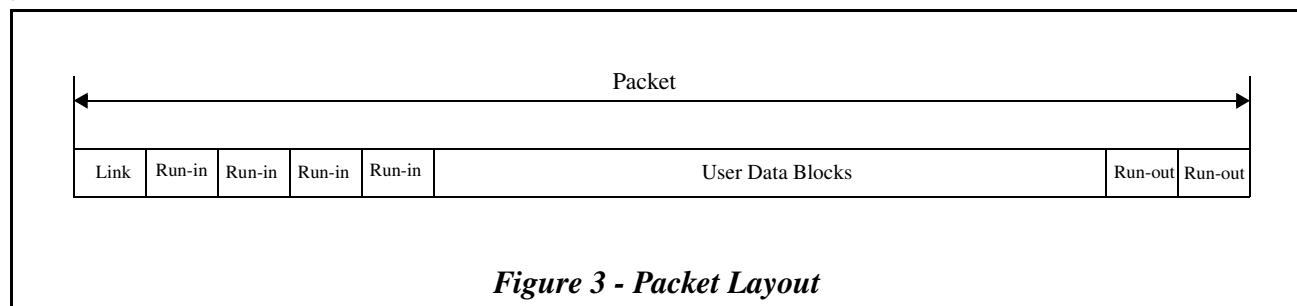
**Figure 3 - Packet Layout**

Figure 4 shows an example of the layout of packet written Track.

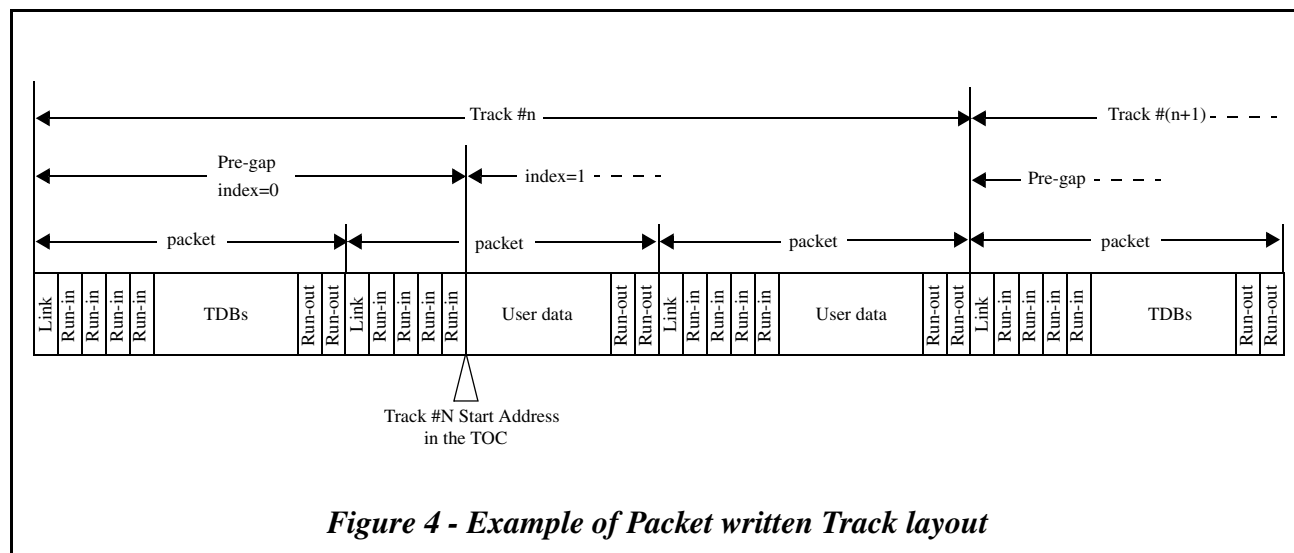


Figure 4 - Example of Packet written Track layout

3.8.2 Addressing method

For CD media, there are two kinds of addressing. Except for the space within a Fixed Packet written Track, the Logical Block Address has a one-to-one relationship to the physical block number. This type of addressing is called “Method 1 Addressing” and Logical Block Numbers are assigned to Link, Run-in, and Run-out blocks as well as User Data Blocks. In Fixed Packet written Tracks, the Logical Block Address is converted to the physical block number using “Method 2 Addressing.” In this case, Logical Block Addresses are not assigned to Link, Run-in, and Run-out blocks.

3.8.3 Track Descriptor Block (TDB)

Information about current Track attributes is encoded in the Pre-gap in a Track Descriptor Block (TDB). Optionally, all preceding Track attributes are included in the TDB. The TDB is recorded in all sectors in the second half of the Pre-gap. The TDB starts at byte 0 in the user data field of each sector. The TDB consists of Track descriptor table and Track descriptor unit(s). The Track descriptor unit gives the information such as the writing method of the Track and the packet size. The Track descriptor unit *shall* be used by the logical unit to determine Packet type and Packet size for a Packet recorded Track. If the disc is recorded using Session At Once, the TDB may not be present.

Table 8 - Track Descriptor Block

Bit	7	6	5	4	3	2	1	0
Byte								
0 - 7	Track Descriptor Table							
0 - N	Track Descriptor Unit(s)							

Track Descriptor Table consists of 8 bytes and is structured as shown below.

Table 9 - Track Descriptor Table

Bit Byte	7	6	5	4	3	2	1	0
0	Track Descriptor Identification (54h)							
1	Track Descriptor Identification (44h)							
2	Track Descriptor Identification (49h)							
3	Pre-Gap Length							
4								
5	Type of Track Descriptor Unit							
6	Lowest Track Number							
7	Highest Track Number							

The Track Descriptor Identification fields contain the Hexadecimal code: '54 44 49' (ASCII "TDI").

The Pre-Gap Length field contain the number of blocks of the second part of this Pre Gap, encoded in BCD.

The Type of Track Descriptor Unit field indicates which Track Descriptor Units are present. When this field set to 00h, indicates that Track Descriptor Units of previous Tracks are present in this Track Descriptor Block. When this field set to 01h, indicates that only the Track Descriptor Units of the current Track is present in this Track Descriptor Block. All other values are reserved for future use.

The Lowest Track Number field indicates that the lowest Track number described in this Track Descriptor Block, encoded in BCD.

The Highest Track Number field indicates that the highest Track number described in this Track Descriptor Block, encoded in BCD.

Track Descriptor Unit describes the data attributes of the Track and consists of 16 bytes. The contents of these 16 bytes are shown in Table 10.

Table 10 - Track Descriptor Unit

Bit Byte	7	6	5	4	3	2	1	0
0	Track Number							
1	(MSB)	Write Method of the Track						(LSB)
2	Packet Size							
3								
4								
5	Reserved							
:								
:								
15								

The Track Number field contains that the number of the Track to which this Track Descriptor Unit belongs, BCD encoded.

The Write Method of the Track field when Bit 7 through Bit 4 set to 1000b, indicates that the Track is an uninterrupted written data Track that consists of only one packet. In this case, Bit 3 through Bit 0 are reserved and set to 0000b.

When the Bit 7 through Bit 4 set to 1001b, indicates that the Track is an incrementally written data Track that consists of more than one packet. In this condition, when Bit 3 through Bit 0 set to 0000b, indicates that the packet size is variable

length. And if Bit 3 through Bit 0 set to 0001b, indicates that the packet size is fixed length. All other values for Bit 3 through Bit 0 are reserved.

When the Bit 7 through Bit 4 set to 0000b, indicates that the Track is an uninterrupted written audio Track. In this condition, Bit 3 through Bit 0 are reserved and set to 0000b.

All other values for Bit 7 through Bit 4 are reserved. And any corresponded values for Bit 3 through Bit 4 are also reserved.

The Packet Size field *shall* be interpreted as follows:

For Incremental written Tracks with fixed Packet Size (Byte 1 = 91h), these bytes contains the BCD encoded Packet Size in sectors (MSBytes first). For Incremental written Tracks with variable Packet Size (Byte 1='90' hex), and Uninterrupted written Data Tracks (Byte 1 = 80h), these three bytes contain the code FFFFFFFh.

3.8.4 High speed CD-RW media recording

High speed CD-RW is defined in Orange Book Part 3 volume 2. High speed CD-RW recording speed ranges are from 4× to 10× recording and also allows CAV recording. Upon CAV recording, write speed needs to be set for each track. If the logical unit is not capable of recording continuous track in CAV, then the logical unit *shall* use CLV mode with initial speed of CAV recording. For example, if the 4×-10× CAV recording is attempted for track at once (TAO) mode, but the logical unit does not support CAV for TAO mode, then the logical unit *shall* choose 4× CLV recording for that track. This condition is not considered as an error.

High speed CD-RW media cannot be recorded using logical units that comply with only Orange Book Part 3 volume 1. Upon write attempt to the High speed CD-RW media using Orange Book Part 3 volume 1 complying logical unit, some logical units returns CHECK CONDITION status, 7/27/00 WRITE PROTECTED¹, or 3/02/00 NO SEEK COMPLETE. Recommended error code for this case is to return 5/30/05 CANNOT WRITE MEDIUM - INCOMPATIBLE FORMAT.

In order to minimize the impact to the large number of MMC-1 based CD-R/-RW logical units and software, extensions of SET CD SPEED command and C/DVD Capabilities and Mechanical Status mode page are defined as an optional Feature. Also SET STREAMING command and GET PERFORMANCE command for CD-R/-RW implementation are defined.

Command Sequence example:

Upon media insertion, host issues READ TRACK INFORMATION command to find the NWA. Then either C/DVD Capabilities and Mechanical Status mode page or GET PERFORMANCE command are used to identify the logical unit's capability for the mounted media.

Host then issues either SET CD SPEED command or SET STREAMING command for the track to be recorded. Also the host sets an appropriate write parameters, and ready to write data.

1. Some CD-RW logical units may return 05/27/00.

4.0 DVD model

The DVD model is the description for the DVD media (DVD-ROM, DVD-R/-RW, DVD-RAM, DVD-Download). See 2.2.63, "DVD media" on page 60. For DVD+RW/+R media, refer to the latest version of MMC (<http://www.t10.org>).

The DVD has been selected by the industry to be the replacement for the CD. It has many advantages over the CD technology. The DVD media format is not backward compatible with the CD devices. The primary reason for this change was driven by the need for large amounts of data for Digital Video (Movies). Simple increase in density would not accomplish this.

Like CD logical units/media there are three types of DVD logical unit/media: Read Only (DVD-ROM), Write only Once (DVD-R, DVD-Download), and Write Multiple times (DVD-RAM, DVD-RW). Each of these media has the possibility of one or two sides, and DVD-ROM/DVD-R may have one or two Layers per side.

A DVD logical unit may be capable of reading CD-ROM, CD-R and CD-RW media. This backwards compatibility allows a DVD logical unit to replace a CD-ROM logical unit in most systems. Although the DVD logical unit may be capable of reading the older CD media, it may not support the same commands as the CD-ROM logical unit. There are some simplifications to the command set supported. Commands that were necessary only for legacy support for the existing CD-ROM drivers have been removed.

The play mechanism may be removed from some DVD logical units. The DVD media provides several and better types of audio. It is likely that the host system will provide the needed support for these new and more capable audio data streams.

A DVD logical unit will look different to the host depending on the type of media that is currently being used. The host system will now need to deal with a logical unit that changes the commands that are possible, based on the type of media that is currently in the logical unit. This type of operation will be handled via the use of Features, Profiles, and Events. This new concept will allow the logical unit to implement various capabilities. The host will detect and configure the logical unit given the various capabilities that are possible.

4.1 DVD media description

- DVD media can contain information on one side (Single Sided) or on both sides (Double Sided).
- DVD-ROM/R disc has two types of Layer structure: Single Layer (SL) and Dual Layer (DL).
- Each Layer on either side contains a spiral track. This track contains a Lead-in, Data Area, and a Middle Area or a Lead-out.
- DVD-ROM Dual Layer discs have two types of track path: Parallel Track Path and Opposite Track Path. DVD-R DL discs have only Opposite Track Path.
- One ECC block, having 37 856 bytes, consists of 16 sectors.
- There is no TOC nor Sub-channel.
- Addressing from the host is LBA (Logical Block Address) only.
- Information concerning error correction that has been performed is not usually returned to the host.
- Some data on DVD media is used only inside of the DVD logical unit and is not transferred to the host computer. This is due in part because the Physical Addresses (PSN) that the DVD uses are not allowed across the Interface.
- The host access unit (Read or Write User Data) is 2 Kilobytes (2 048 bytes).

4.1.1 DVD specifications

Table 11 specifies some DVD parameters.

Table 11 - General Parameters of DVD discs

		Capacity (120 mm disc) [Gbytes]	Capacity (80 mm disc) [Gbytes]	Wavelength for read [nm]	Wavelength for write [nm]	Data Bit Length [μm]	Channel bit length [μm]	Min Pit/Mark length [μm]	Max Pit/Mark length [μm]	Track Pitch [μm]	User data per sector [bytes]	Error Correction Code	ECC Constraint Length	correctable burst error length [mm]	scan velocity (Ref.) [m/s]	channel bit rate [Mbps]	user data bit rate [Mbps]												
DVD-ROM SL	1x-speed	4,70	1,46	635/650	N/A	0,267	0,133	0,400	1,866	0,74	2 048	RS (208, 192, 17) \times RS (182, 172, 11)	16 sectors	6,0	3,49	26,16	11,08												
	3x-speed														10,47	78,47	33,24												
DVD-R SL Ver. 2.1	1x-speed				3,49										26,16	11,08													
	4x-speed ^c				13,96										104,64	44,32													
DVD-Download	2x-speed ^a				6,98										52,32	22,16													
DVD-RW SL Ver. 1.2	1x-speed				3,49										26,16	11,08													
	2x-speed ^c				6,98										52,32	22,16													
DVD-ROM DL	1x-speed				8,54										2,66	650	N/A	0,293	0,147	0,440	2,054	0,74	2 048	RS (208, 192, 17) \times RS (182, 172, 11)	16 sectors	6,5	3,84	11,08	11,08
	3x-speed																										11,52	78,47	33,24
DVD-R DL Ver. 3.0	26,16																11,08												
	7,68 ^b	52,32 ^b	22,16 ^b																										
DVD-RW DL Ver. 2.0	8,16	58,36	22,16																										
	8,49	58,36	22,16																										
DVD-RAM Ver. 2.2	2x-speed	4,70	-	650	0,280	0,140	0,420	1,960	0,615	0,615	2 048	RS (208, 192, 17) \times RS (182, 172, 11)	16 sectors	6,3	8,16	58,36	22,16												
	3x-speed ^c														12,24	87,55	33,24												
	2x-speed														8,16	58,36	22,16												
	3x-speed ^c														12,24	87,55	33,24												

a. DVD-R for General Optional Specification: DVD Download Disc for CSS Managed Recording

b. This value represents basic recording speed.

c. Defined in Optional specifications for each media

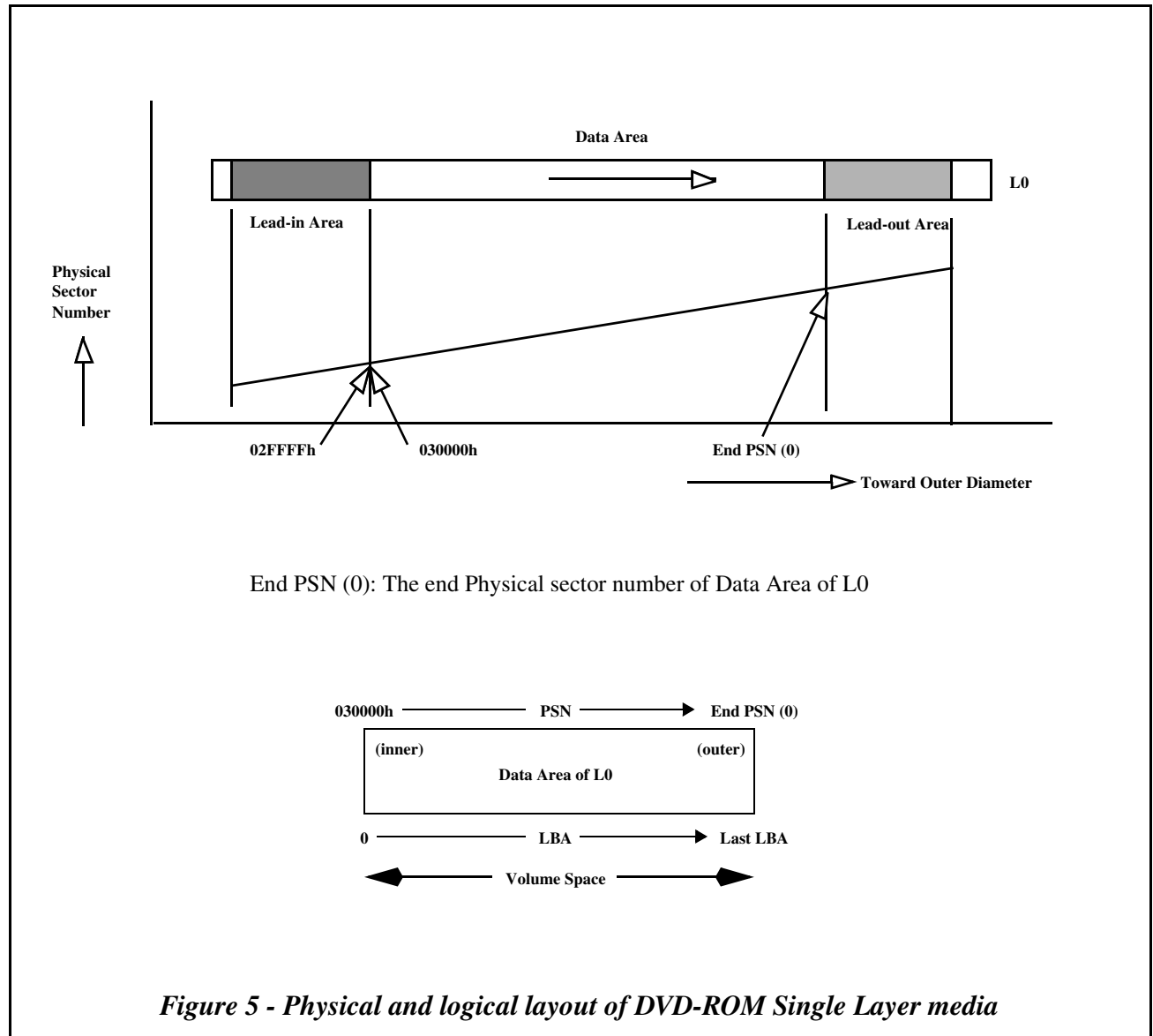
Note: The ranged values for DVD-RAM in Table 11 reflect its Zoned CLV format.

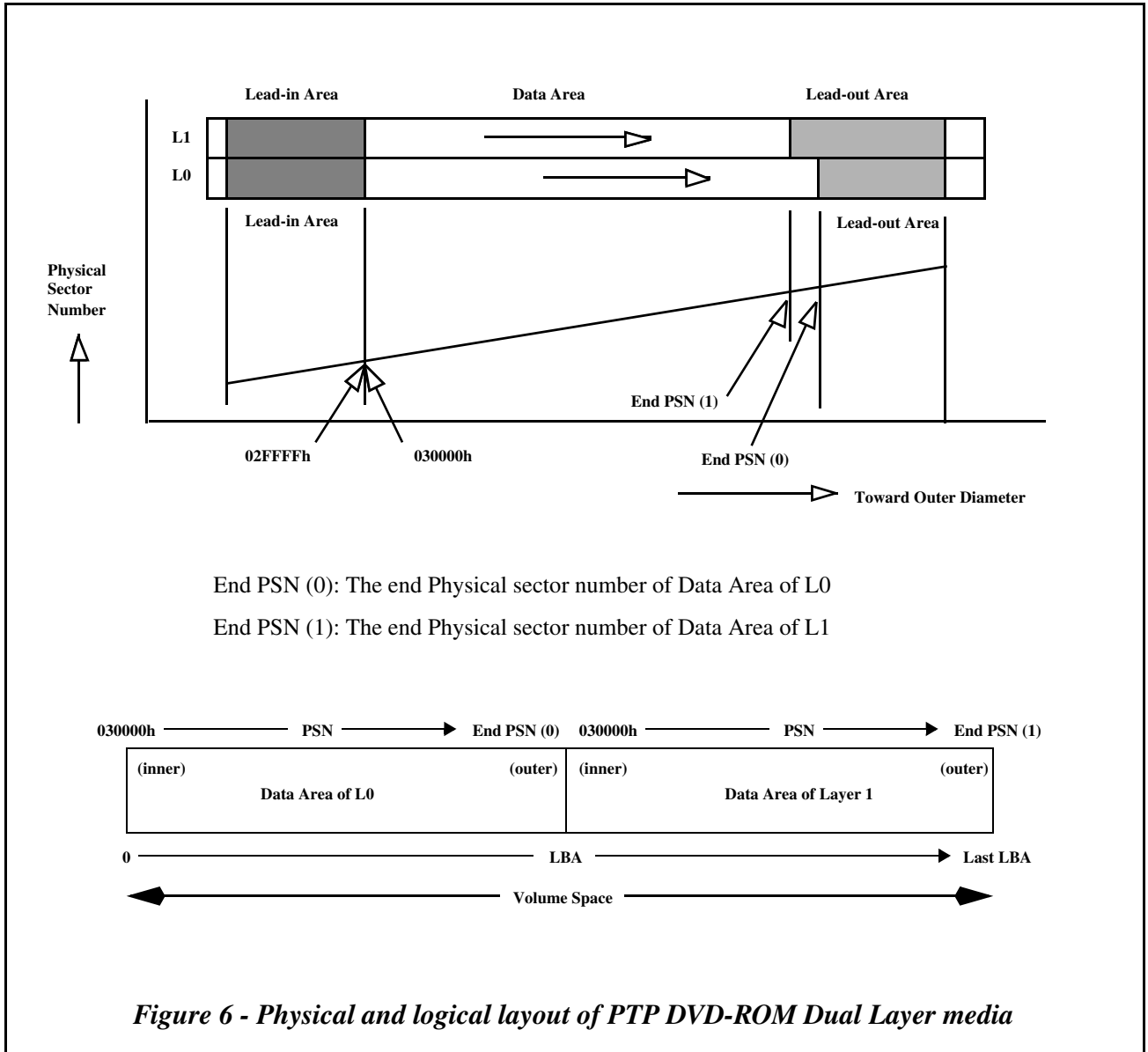
4.2 Track structure

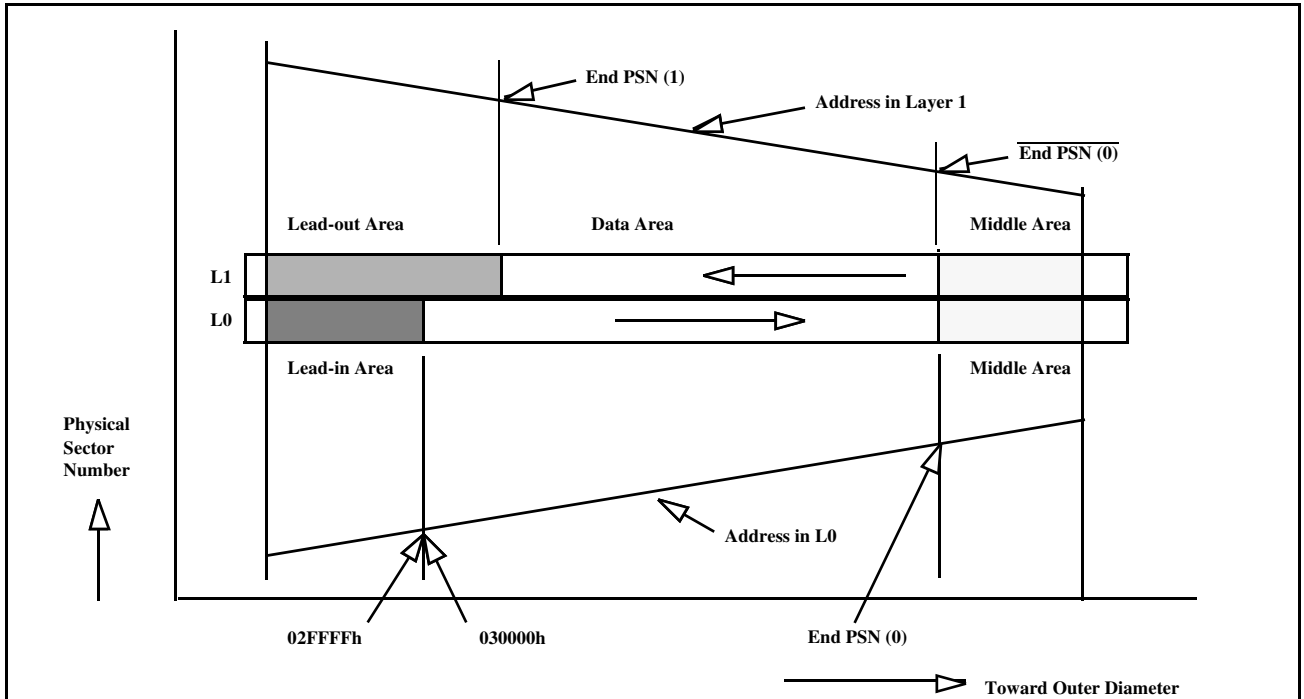
There are two types of track path for DVD-ROM Dual Layer discs, either parallel or opposite. When the path is parallel each track has its own Lead-in and Lead-out.

There are two addresses used in the DVD system, the Block address contained in the sector headers (Physical Sector Number), and the address used to reference the blocks from the host system (LBA). The address used from the host starts at 0 and progresses up through the end of the recorded information on the disc. LBA 0 corresponds with the sector address of 030000h on DVD-ROM media. Only the Data Area is generally addressable using an LBA.

Figure 5 through Figure 9 show examples of LBA to Physical Sector Number translations for DVD media.







End PSN (0): The end Physical sector number of Data Area of L0. The End PSN (0) is a multiple of 16.

$\overline{\text{End PSN (0)}}$: The number calculated so that each bit of the End PSN (0) is inverted.

End PSN (1): The end Physical sector number of Data Area of L1

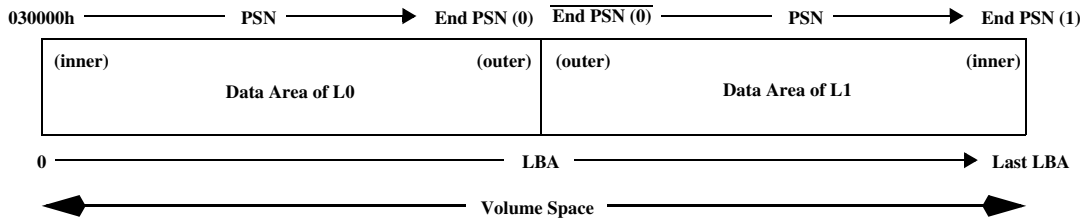
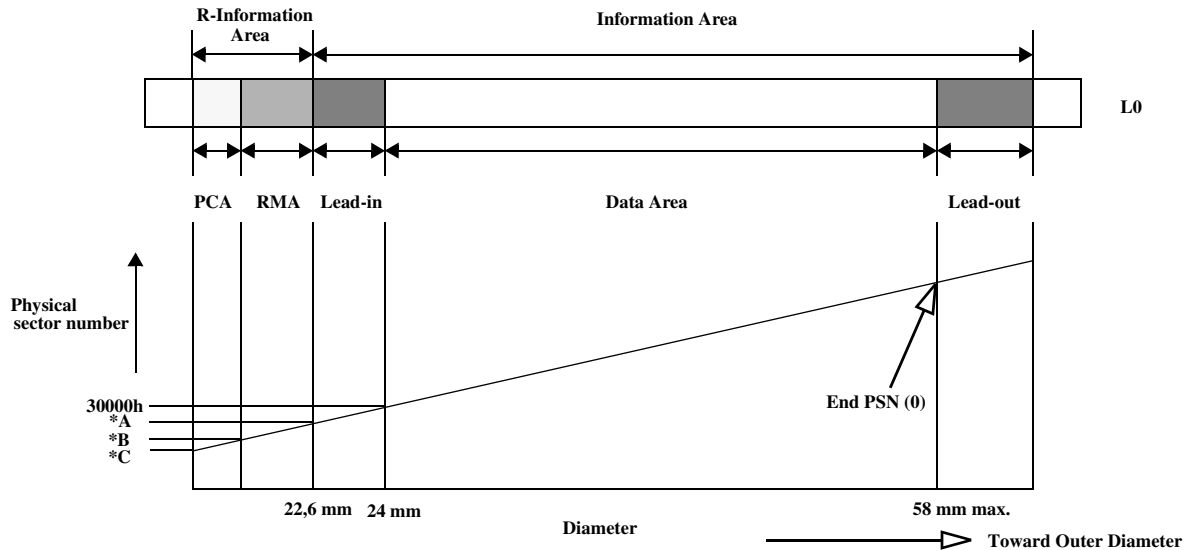
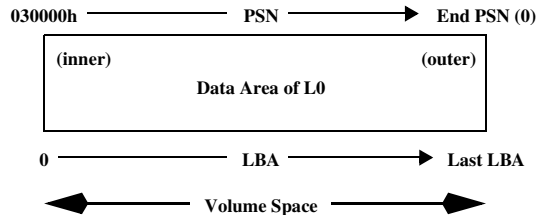


Figure 7 - Physical and logical layout of OTP DVD-ROM DL/-R DL/-RW DL media

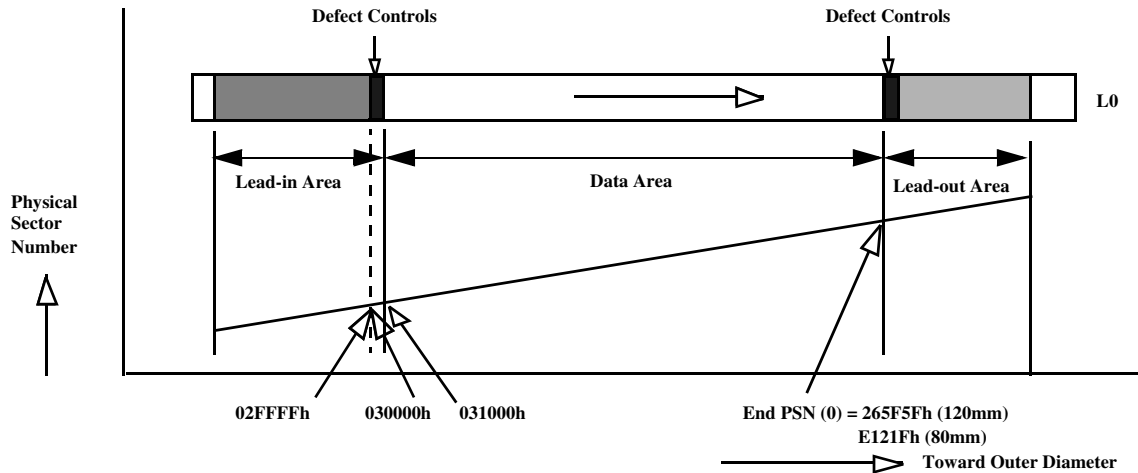


- *A (Lead-in start address) 22FA0h: DVD-RW SL Ver. 1.2
DVD-R SL Ver. 2.1
203C0h: DVD-Download (pre-recorded)
- *B (RMA Start address) 203C0h: DVD-RW SL Ver. 1.2
DVD-R SL Ver. 2.1
Note: RMA is not defined for DVD-Download media
- *C (PCA start address) 1E800h: DVD-RW SL Ver. 1.2
DVD-R SL Ver. 2.1
DVD-Download



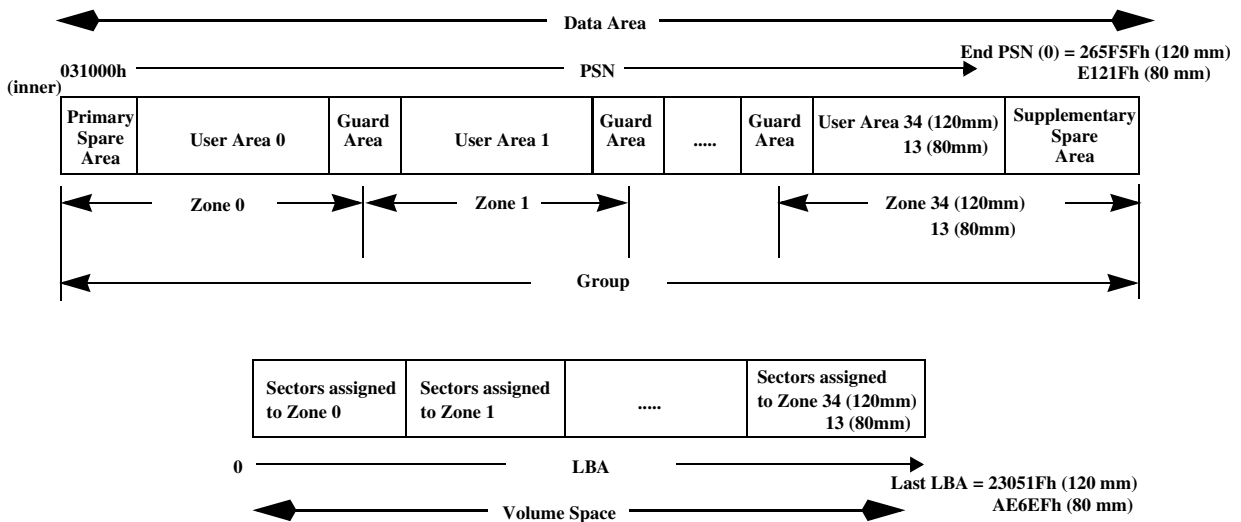
End PSN (0): The end Physical sector number of Data Area of L0

Figure 8 - Physical and logical layout of DVD-R SL/-RW SL/Download SL media



End PSN (0): The end Physical sector number of Data Area of L0

Defect Controls are non user addressable blocks, used for drive controlled defect management. These blocks contain Defect management Areas (DMAs). Defect controls begins 030000h. This is the Data Area for DVD-ROM and for DVD-R. The Data Area begins 031000h for DVD-RAM.



- DVD-RAM Ver. 2.2 media contains 35 zones in the case of 120 mm and 14 zones in the case of 80 mm.
- Each of these zone has equal radial size except Zone 34 in the case of 120 mm and Zone 13 in the case of 80 mm, therefore number of ECC blocks per zone increase from 2 450 at the Inner Diameter to 6 608 in the case of 120 mm and 5 852 in the case of 80 mm at the Outer Diameter.
- There are two types of Spare Area, Primary Spare Area (PSA) and Supplementary Spare Area (SSA).
- DVD-RAM Ver. 2.2 media has PSA, and may have SSA. Pre-assigned SSA is selectable and SSA is expandable after Formatting.
- The User Area may contain defective sectors which are replaced by sectors in the Spare Area; therefore, the number of user accessible sectors in each zone is kept at a predetermined number.

Figure 9 - Physical and logical layout of DVD-RAM Ver. 2.2 media

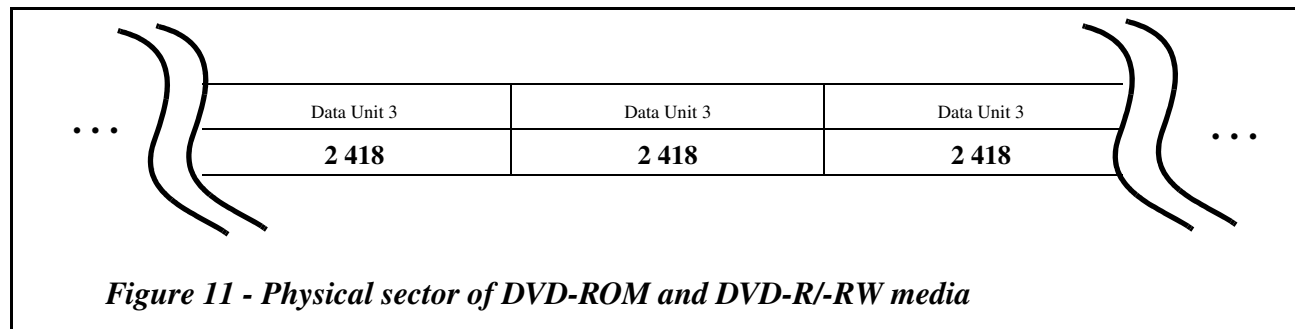
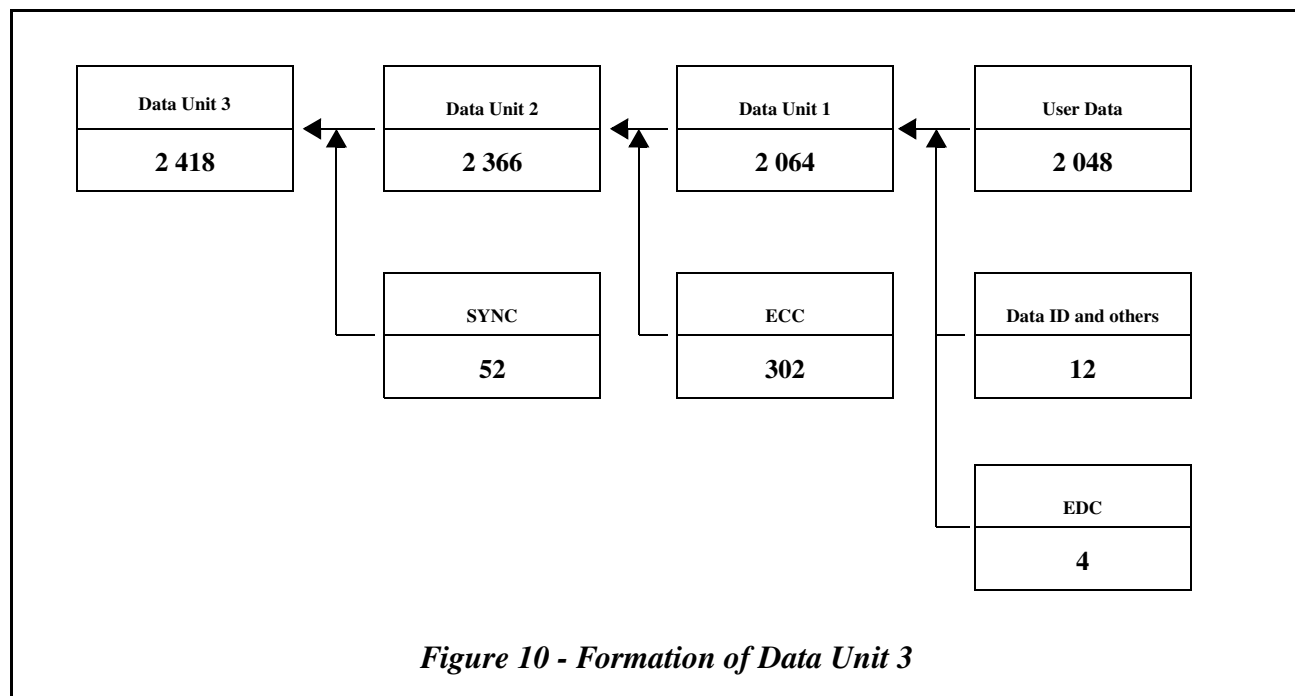
4.3 ECC block

The user data is contained in ECC blocks. Each ECC block is made up of 16 sectors and is used to provide error correction. To read any data, the whole ECC block *shall* be read and error correction applied. When the ECC block is written during formatting or normal write operation, the user data and the ECC information is encoded and written to sectors as a whole ECC block.

4.4 Sector configuration

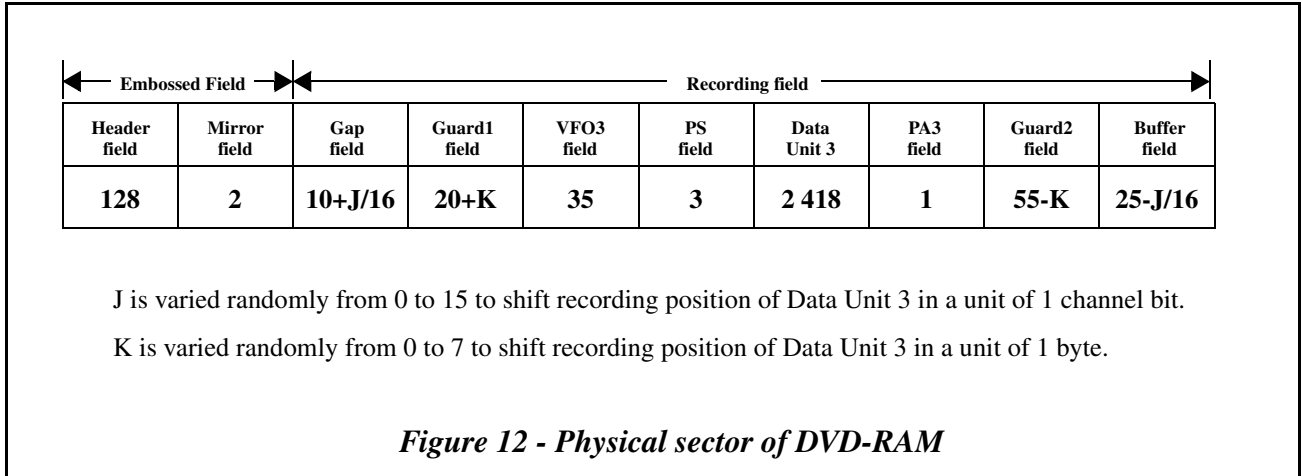
4.4.1 Physical sector

The data recorded to the DVD media is in a format called “Data Unit 3,” which consists of 2 048 bytes of User Data, 12 bytes of Data ID and others, 4 bytes of error detection code (EDC), 302 bytes of ECC and 52 bytes of SYNC. During the formation of the Data Unit 3, there are intermediate products which are called “Data Unit 1” and “Data Unit 2” according to the stage of signal processing as shown in Figure 10. The Data Unit 3 is identical among DVD-ROM, DVD-R/-RW, and DVD-RAM. In the case of DVD-ROM, and DVD-R/-RW, only the Data Unit 3 is recorded. DVD-RAM media has other fields in between each Data Unit 3 as shown in Figure 12.

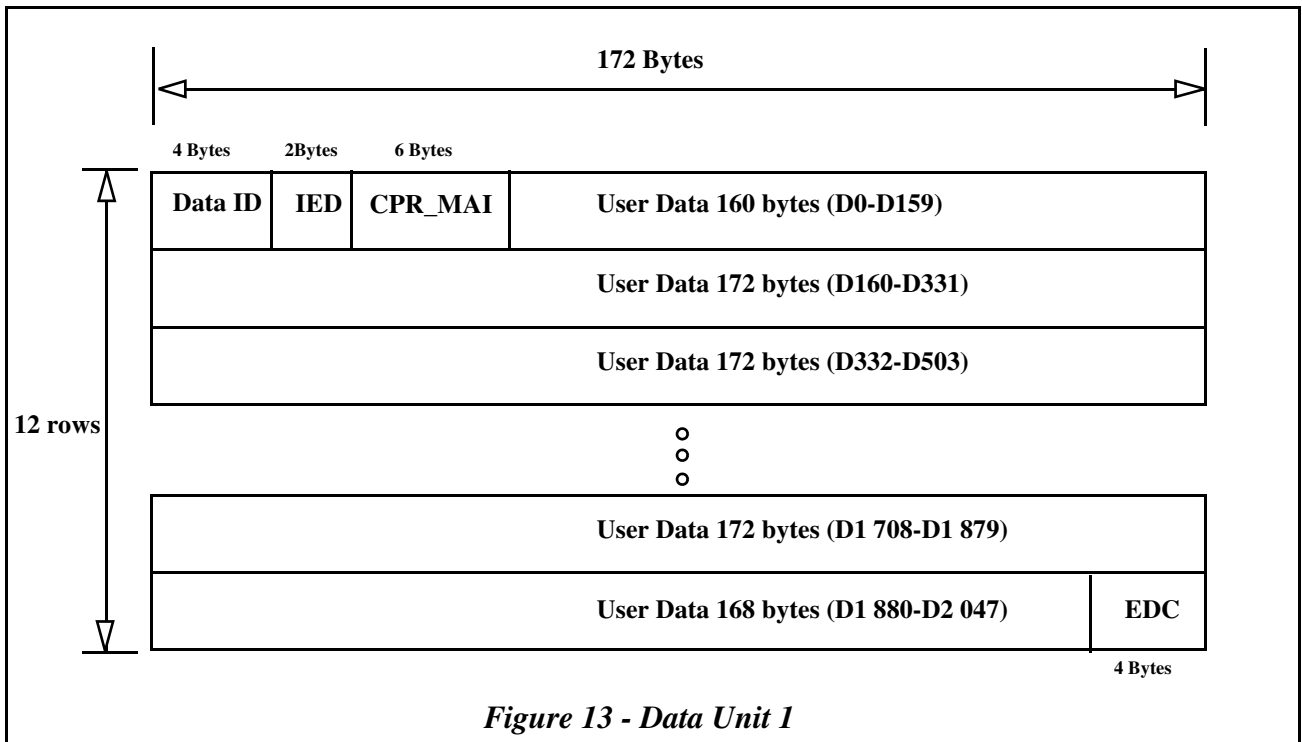


The physical sector of DVD-RAM consists of Data Unit 3, preceding fields and succeeding fields to it and embossed fields. The Data Unit 3 is identical with that for DVD-ROM. The Header field contains four physical IDs. In the case of

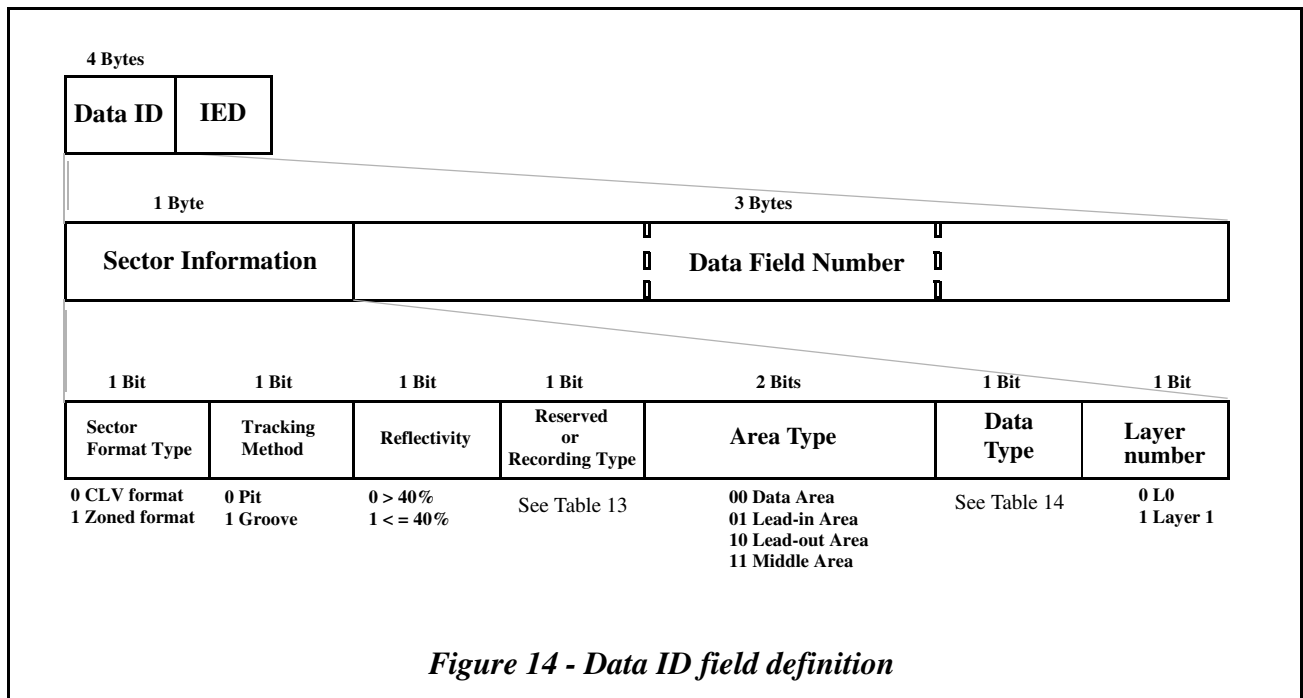
DVD-RAM, there are two sets of IDs. One that is contained in the Data Unit 1 and another that is pre-recorded. Addressing of sectors for DVD-RAM will only use the physical (pre-recorded) ID. After formatting, it is possible for the ID in Data Unit 1 to contain an invalid address.



4.4.2 Data Unit 1



4.4.3 Data configuration of Data ID field



The Data Field Number comprises PSN for DVD-ROM, and DVD-R/-RW. In the case of DVD-RAM, see Table 12.

Table 12 - Data Field Number for DVD media

Area	Media Type	Description	Contents
Lead-in and Lead-out	ROM, -R, RAM, -RW	Pre-recorded information or written for DVD-R/-RW media	PSN
Data Area	ROM, -R, -RW	Pre-recorded information or Written for DVD-R/-RW media	PSN
	RAM	ECC block written by the host	LBA + 31000h
		ECC block not written by the host after formatting	Any of the following three cases (1) Initialization pattern (2) Unrecorded (3) Old value of LBA + 31000h assigned before previous re-formatting

Table 13 - Recording Type bit definition for DVD-RAM Ver. 2.2 media ^a

Area		Definition
Embossed data zone		Reserved
Rewritable data zone	Lead-in Area, Lead-out Area	Reserved
	Data Area	0b: General data ^b 1b: Real-time data ^c

- a. The definition of the bit for other than DVD-RAM Ver. 2.2 media is Reserved.
- b. General data: Linear replacement algorithm is applied to a Block containing the corresponding sector if the Block is defective.
- c. Real-time data: Linear replacement algorithm is not applied to a Block containing the corresponding sector even if the Block is defective.

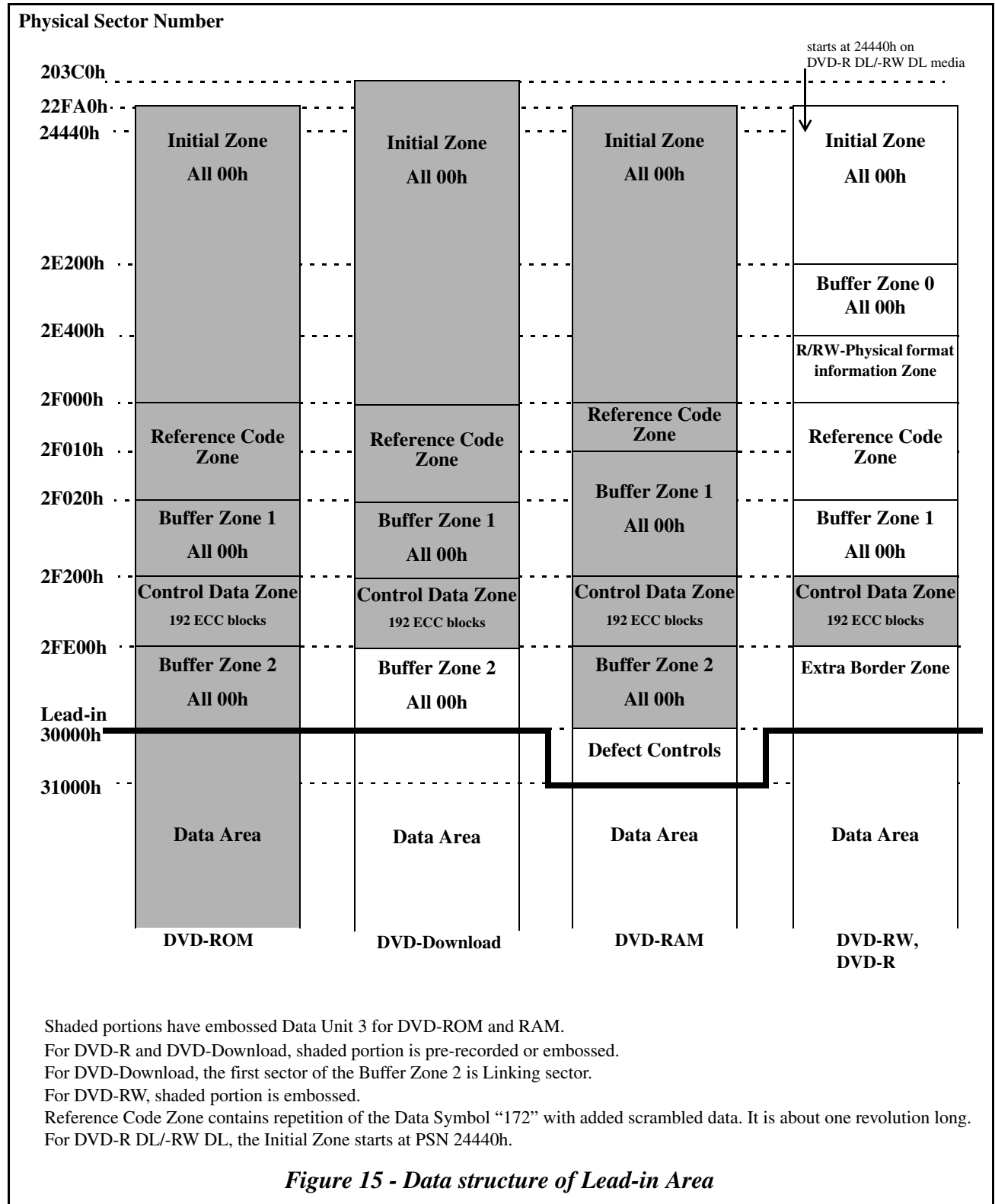
The Data Type bit specifies the data type of a sector as defined in Table 14.

Table 14 - Data Type bit definition

Media Type	Data Type bit	
	0	1
DVD-ROM/Download	Read-only data	N/A
DVD-RAM	Embossed data	Rewritable data
DVD-R	Read-only data	Next sector is Linking data
DVD-RW SL	Re-recordable data	Next sector is Linking data
DVD-RW DL	Re-recordable data	Intermediate Marker or Next sector is Linking data

4.5 Data structure of Lead-in Area

Figure 15 shows the Lead-in structure of each type of DVD medium.



4.5.1 Control Data Zone

The Control Data Zone contains 192 ECC blocks. The Control Data Zone comprises repetition of a Control Data Block which size is 16 sectors (= 1 ECC block). See Table 15 for a Control Data Block structure.

For DVD-RW media, the Control Data Zone is embossed. In case of DVD-RW SL Ver. 1.0 media, the embossed portion may not be readable. The logical unit may use RW-Physical format information Zone or Extra Border Zone instead of Control Data Zone. See 4.5.2.

For DVD-R media, the Control Data Zone is pre-recorded or embossed by disc manufacturer.

The Disc manufacturing information field *shall* be ignored by logical units.

Table 15 - Structure of a Control Data Block

Sector Number	Description
0	Physical format information
1	Disc manufacturing information
2-15	Reserved

4.5.1.1 Physical format information

Physical format information is structured as shown in Table 16. For DVD-Download disc (DVD-R for General Optional Specification: DVD Download Disc for CSS Managed Recording), the same definition with DVD-ROM media is used for each fields in Physical format information.

Table 16 - Physical format information in Control Data Block

Bit Byte	7	6	5	4	3	2	1	0
0	Book Type				Part Version ^a			
1	Disc Size				Maximum Transfer Rate			
2	Reserved	Number of Layers		Track Path	Layer Type			
3	Linear Density				Track Density			
4-15	Data Area Allocation							
16	BCA Flag ^b	Reserved						
17-2 047	Medium unique data							

a. For DVD-R and DVD-RW media, the name of this field is defined as Compatible Part Version.

b. For DVD-R and DVD-RW media, the name of this bit is defined as NBCA Flag.

The Book Type field identifies the type of media specification. The definition is described in Table 17.

Table 17 - Book Type field definition

Value	Definition
0000b	DVD-ROM/DVD-Download
0001b	DVD-RAM
0010b	DVD-R
0011b	DVD-RW
1001b	DVD+RW
1010b	DVD+R
others	Reserved

The Part Version field identifies the version number within a Book Type. Table 18 and Table 19 shows the definition of the Compatible Part Version field on DVD-R and DVD-RW media.

Table 18 - Compatible Part Version field definition for DVD-R media

Value	Definition
0000b	Version 0.9x for test use only, not for consumer product
0001b	Version 1.0x
0010b	Version 1.1x
0100b	Version 1.9x for test use only, not for consumer product
0101b	Version 2.0x, when the Extended Part version field value is 00h. Version 2.0x compatible, when the Extended Part version field value is not 00h and specifies actual version.
0110b	Version is higher than 2.0 and specified by the Extended Part version field
others	Reserved

Table 19 - Compatible Part Version field definition for DVD-RW media

Value	Definition
0000b	Version 0.9x for test use only, not for consumer product
0001b	Version 1.0x
0010b	Version 1.1x when the Extended Part version field value is 00h. Version 1.1x compatible, when the Extended Part version field value is not 00h and specifies actual version
0011b	Version is higher than 1.1 and specified by the Extended Part version field
others	Reserved

The Disc Size field, when set to 0000b, indicates a 120 mm disc. When set to 0001b, indicates an 80 mm disc. All other values are reserved.

The Maximum Transfer Rate field identifies the maximum data transfer rate found in the contents (e.g., video data) on the medium. See Table 20.

Table 20 - Maximum Transfer Rate field definition

Value	Definition
0000b	2,52 Mbps
0001b	5,04 Mbps
0010b	10,08 Mbps
0011b	30,24 Mbps
0100b-1110b	Reserved
1111b	No maximum transfer rate is specified.

The Number of Layers field identifies the number of Layers on the current side. 00b indicates one Layer, 01b indicates two Layers, and other values are reserved.

The Track Path field, when set to 0b, indicates a PTP or Single Layer disc. When set to 1b, indicates an OTP disc.

The Layer Type field identifies the Layer according to Table 21.

Table 21 - Layer Type field definition

Bit	Definition
0	When set to one, the Layer contains embossed user Data Area
1	When set to one, the Layer contains recordable user Data Area
2	When set to one, the Layer contains re-writable user Data Area
3	Reserved

The Linear Density field identifies the bit density according to Table 22.

Table 22 - Linear Density field definition

Value	Definition
0000b	0,267 $\mu\text{m}/\text{bit}$
0001b	0,293 $\mu\text{m}/\text{bit}$
0010b	0,409-0,435 $\mu\text{m}/\text{bit}$
0100b	0,280-0,291 $\mu\text{m}/\text{bit}$
1000b	0,353 $\mu\text{m}/\text{bit}$
others	Reserved

The Track Density field identifies the track density according to Table 23.

Table 23 - Track Density field definition

Value	Definition
0000b	0,74 $\mu\text{m}/\text{track}$
0001b	0,80 $\mu\text{m}/\text{track}$
0010b	0,615 $\mu\text{m}/\text{track}$
others	Reserved

Table 24 describes the contents of the Data Area Allocation field.

Table 24 - Data Area Allocation field definition

Byte	DVD-ROM SL, DVD-Download, DVD-ROM DL (PTP)	DVD-ROM DL (OTP), DVD-R DL, DVD-RW DL	DVD-RW SL, DVD-R SL	DVD-RAM
4	00h			
5	Starting PSN of Data Area (030000h)			Starting PSN of Data Area (031000h)
6				
7				
8	00h			
9	End PSN of Data Area		Outer limit of Data Recordable area ^a	End PSN of Data Area
10				
11				
12	00h			
13	000000h	End PSN of L0	000000h	
14				
15				

- a. A DVD logical unit that does not support reading of R/RW-Physical format information Zone or Extra Border Zone on DVD-R SL or DVD-RW SL media, may report this value as recorded capacity, e.g., returned data of READ CAPACITY command, even if data is not fully recorded in Data Recordable area. In this case, reading of the last addressable LBA may cause pick-up over-run. See *Appendix J-2 "Read compatibility issue of AVDP and VAT ICB at end LBA"* on page 1004.

For DVD-RAM, the end PSN is the PSN for the last spare sector of the last zone. It should not be used for counting user capacity.

The BCA Flag identifies the existence of Burst Cutting Area (BCA)/NBCA on the medium. 0b indicates non-existence of BCA/NBCA, 1b indicates existence of BCA/NBCA on the medium.

Table 25, Table 26, Table 27, Table 29, Table 30 and Table 33 show the format unique descriptors for each media type.

Table 25 - DVD-ROM unique part of Physical format information

Bit Byte	7	6	5	4	3	2	1	0
17-32	Reserved							
33	Twin Format Flag	Reserved						
34-2 047	Reserved							

The Twin Format Flag bit, when set to 1, indicates that the medium is HD DVD-ROM/DVD-ROM Twin Format Disc.

Table 26 - DVD-R SL Ver. 2.1 unique part of Physical format information

Bit Byte	7	6	5	4	3	2	1	0
17	Revision number of maximum recording speed							
18	Revision number of minimum recording speed							
19-25	Revision number table of recording speed							
26	Class							
27	Extended Part Version							
28-31	Reserved							
32-35	Start PSN of the Extra Border Zone (= 02FE10h)							
36-39	Start PSN of Physical format information blocks in Extra Border Zone (= 02FFA0h)							
40-511	Reserved							
512-2 047	Extended pre-recorded information							

Table 27 - DVD-Download unique part of Physical format information

Bit Byte	7	6	5	4	3	2	1	0
17-510	Reserved							
511	Disc Identifier							
512-2 047	Extended PFI information							

When the Disc Identifier field is set to 01000001b, Extended PFI information field is valid. These bytes *shall* include the contents in the Pre-pit data block Field ID1 to ID5. For more information, see DVD book.

Table 28 - Disc Identifier field definition for DVD-Download media

Bit Byte	7	6	5	4	3	2	1	0
511	Disc indicator				Major digit of Revision number			

The Disc indicator field is set to 0100b: DVD Download Disc for CSS Managed Recording. All other values are reserved.

The Major digit of Revision number field is set to 0001b: Revision 1. All other values are reserved. Major digit indicates the digit x for the Revision number x.y by binary notation.

Table 29 - DVD-RW SL Ver. 1.2 unique part of Physical format information

Bit Byte	7	6	5	4	3	2	1	0
17	Revision number of maximum recording speed							
18	Revision number of minimum recording speed							
19-25	Revision number table of recording speed							
26	Class							
27	Extended Part Version							
28-31	Reserved							
32-35	Start PSN of the Extra Border Zone (= 02FE10h)							
36-39	Start PSN of Physical format information blocks in Extra Border Zone (= 02FFA0h)							
40-511	Reserved							
512-2 047	Extended embossed information							

The **Revision number of maximum recording speed** field identifies the Revision number of maximum applicable recording speed of this disc. The bit 7 to bit 4 of this field indicates the major revision number of the Optional Specification. The bit 3 to bit 1 of this field indicates the minor revision number of the Optional Specification. This field is set to 00h if the **Class** field is set to 00h.

The **Revision number of minimum recording speed** field identifies the Revision number of minimum applicable recording speed of this disc. The bit 7 to bit 4 of this field indicates the major revision number of the Optional Specification. The bit 3 to bit 1 of this field indicates the minor revision number of the Optional Specification. This field is set to 00h if the **Class** field is set to 00h.

Example of Revision number:

0000 0000b means Revision 0.0

0001 0000b means Revision 1.0

The **Revision number table of recording speed** field identifies all revision numbers supported by this disc other than the revision numbers specified in the **Revision number of maximum recording speed** field and the **Revision number of minimum recording speed** field. The bit 7 to bit 4 of each byte in this field indicates the major revision number of the Optional Specification. The bit 3 to bit 1 of each byte in this field indicates the minor revision number of the Optional Specification. In this field, a byte value of 00h means “unused” and does not mean Revision number 0.0.

The **Class** field identifies all supported basic recording speeds by this disc. Each bit assignment and its Basic recording speed is specified in applicable DVD book.

The **Extended Part Version** field identifies actual Book Part Version. The bit 7 to bit 4 of this field indicates the major Version number of the Extended Part Version. The bit 3 to bit 0 of this field indicates the minor Version number of the Extended Part Version.

Example of Version number:

0010 0001b means Version 2.1

0010 1001b means Version 2.9 (for test use only, not for consumer product)

0011 0000b means Version 3.0

Table 30 - DVD-R DL Ver. 3.0 unique part of Physical format information

Bit Byte	7	6	5	4	3	2	1	0
17	Revision number of maximum recording speed							
18	Revision number of minimum recording speed							
19-25	Revision number table of recording speed							
26	Class							
27	Extended Part Version							
28-31	Reserved							
32-35	Start PSN of the Extra Border Zone (= 02FE10h)							
36-39	Start PSN of Physical format information blocks in Extra Border Zone (= 02FFA0h)							
40	Pre-recorded information code							
41	Tracking polarity flag and AR flag							
42-511	Reserved							
512-2 047	Extended pre-recorded information							

Table 31 - DVD-RW DL unique part of Physical format information

Bit Byte	7	6	5	4	3	2	1	0
17	Revision number of maximum recording speed							
18	Revision number of minimum recording speed							
19-25	Revision number table of recording speed							
26	Class							
27	Extended Part Version							
28-31	Reserved							
32-35	Start PSN of the current RMD in Extra Border Zone							
36-39	Start PSN of the Physical format information blocks in Extra Border Zone							
40	Pre-recorded/Embossed information code							
41-511	Reserved							
512-2 047	Extended embossed information							

Pre-recorded/Embossed information code field indicates the embossed/pre-recorded status of Control Data Zone, Initial zone in the Lead-in, Lead-out, and Fixed Middle Areas at the time of disc manufacturing. Table 32 shows the definition of this field.

Table 32 - Pre-recorded/Embossed information code field definition

Bit	Area	Definition
0	Control Data Zone	0b: embossed 1b: Reserved
1	Lead-in Area	0b: the Initial zone is not embossed 1b: the Initial zone is embossed
2	Fixed Middle Area	0b: neither pre-recorded nor embossed by disc manufacturer. 1b: either pre-recorded or embossed by disc manufacturer.
3	Lead-out Area	0b: not embossed 1b: embossed
4-7	-	Reserved

Table 33 - DVD-RAM Ver. 2.2 unique part of Physical format information

Bit Byte	7	6	5	4	3	2	1	0
32	Disc Type Identification							
33-499	Reserved							
500	Velocity							
501-548	Write conditions at Velocity							
549-596	Disc manufacture's name							
597-612	Disc manufacture's supplementary information							
613-623	Write power control parameters							
624-699	Reserved							
700	3×-speed Velocity (optional)							
701-757	Write condition at 3×-speed Velocity (optional)							
758-2 047	Reserved							

4.5.2 R/RW-Physical format information Zone

The R/RW-Physical format information Zone is defined for DVD-R and DVD-RW media. The R/RW-Physical format information Zone contains 192 ECC blocks. The R/RW-Physical format information Zone comprises repetition of a R/RW-Physical format information Block which size is 16 sectors (= 1 ECC block).

The structure of an R/RW-Physical format information Block is shown in Table 34. On DVD-Download media, R-Physical format information Zone is not defined.

Table 34 - Structure of an R/RW-Physical format information Block

Sector Number	Description
0	Reserved
1	Manufacturing information
2	Physical format information
3-15	Reserved

The structure of Physical format information in the R/RW-Physical format information Block is shown in Table 35. The field definitions are same as that of Physical format information in the Control Data Block unless otherwise specified.

Table 35 - Physical format information in an R/RW-Physical format information Block

Bit Byte	7	6	5	4	3	2	1	0
0	Book Type ^a				Compatible Part Version ^a / DL indicator ^b			
1	Disc Size ^a				Maximum Transfer Rate			
2	Reserved	Number of Layers ^a		Track Path ^a	Layer Type ^a			
3	Linear Density ^a				Track Density ^a			
4-15	Data Area Allocation							
16	NBCA flag ^a	Reserved						
17-2 047	Media unique data							

a. These fields are copied from pre-recorded Physical format information in Control Data Block.

b. The definition of the DL indicator field is valid only for DVD-R DL and DVD-RW DL discs.

The static information in R/RW-Physical format information Block are basically copied from the Control Data Block in pre-recorded/embossed Control Data Zone. Some dynamic information (e.g., the Maximum Transfer Rate field, the Data Area Allocation fields, Border Zone location information) *shall* be recorded with the latest appropriate value.

The DL indicator field indicates that the mounted disc is Dual Layer disc. This definition is only applicable to DVD-R DL and DVD-RW DL discs. If DVD-R DL or DVD-RW DL disc is mounted, this field *shall* be set to 1111b to indicate the disc is Dual Layer disc. All other values are reserved.

The definition of the Data Area Allocation field in R/RW-Physical format information Block is shown in Table 36.

Table 36 - Data Area Allocation field in R/RW-Physical format information Block

Byte	DVD-R SL/DVD-RW SL (Disc-at-once)	DVD-R SL / DVD-RW SL (Incremental) and DVD-RW SL (Restricted Overwrite)	DVD-R DL/DVD-RW DL
4	00h	00h	00h
5	Starting PSN of Data Area (= 30000h)	Starting PSN of Data Area (= 30000h)	Starting PSN of Data Area (= 30000h)
6			
7			
8	00h	00h	00h
9	End PSN of Data Area	Last Recorded Sector Number of the last RZone in the Bordered Area ^a	Maximum recorded PSN of the Data Area ^b
10			
11			
12	00h	00h	00h
13	000000h	000000h	Maximum recorded PSN of the Data Area on Layer 0 ^c
14			
15			

- a. On DVD-RW SL discs, when the Lead-in or Border-in is recorded in Restricted Overwrite mode, and when the last Bordered Area is in an Intermediate state, this field is set to 30000h.
- b. This field indicates the maximum PSN that contains valid user data. On DVD-RW DL discs, this field is set to 30000h when the disc is Intermediate state.
- c. On DVD-R DL discs, when the Data Area on Layer 1 is not recorded, the value of this field is same as the value of the Maximum recorded PSN of the Data Area field when Format 1 RMD is used. When Format 4 RMD is used, this field indicates End PSN of Layer 0.
On DVD-RW DL discs, this field is set to the same value as Maximum recorded PSN of the Data Area when the Data Recordable area on L1 is not logically recorded. When the Data Recordable area on L1 is logically recorded, this field is set to the same value as End PSN of L0.

Table 37, Table 38 and Table 39 show the unique part of R/RW-Physical format information for each media type. When the Lead-in is recorded in the Disc-at-once recording mode, this field contains all 00h data.

Table 37 - DVD-R SL Ver. 2.1 unique part of R-Physical format information

Bit Byte	7	6	5	4	3	2	1	0
17	Revision number of maximum recording speed ^a							
18	Revision number of minimum recording speed ^a							
19-25	Revision number table of recording speed ^a							
26	Class ^a							
27	Extended Part Version ^a							
28-31	Reserved							
32-35	Start PSN of the current Border-out							
36-39	Start PSN of the next Border-in							
40-511	Reserved							
512-2 047	Copy of Extended pre-recorded information ^a							

- a. These fields are copied from pre-recorded Physical format information in Control Data Block.

Table 38 - DVD-R DL Ver. 3.0 unique part of R-Physical format information

Bit Byte	7	6	5	4	3	2	1	0
17	Revision number of maximum recording speed ^a							
18	Revision number of minimum recording speed ^a							
19-25	Revision number table of recording speed ^a							
26	Class ^a							
27	Extended Part Version ^a							
28-31	Reserved							
32	Reserved							
33	Start PSN of the current Border-out							
34								
35								
36	Reserved							
37	Start PSN of the next Border-in							
38								
39								
40	Pre-recorded information code ^a							
41	Tracking polarity flag and AR flag ^a							
42	Reserved				RBVF4	RBVF3	RBVF2	RBVF1
43-511	Reserved							
512-2 047	Extended pre-recorded information ^a							

a. These fields are copied from pre-recorded Physical format information in Control Data Block.

The RBVF#n bits indicates the validity of the nth Anchor Point Data (APD#n) recorded in Superficial Border Zone and Extra Border-in. If set to 0b, the APD#n is not used for remapping. If set to 1b, the APD#n is valid and is used to return as the remapping data.

Table 39 - DVD-RW SL Ver. 1.2 unique part of RW-Physical format information

Bit Byte	7	6	5	4	3	2	1	0
17	Revision number of maximum recording speed ^a							
18	Revision number of minimum recording speed ^a							
19-25	Revision number table of recording speed ^a							
26	Class ^a							
27	Extended Part Version ^a							
28-31	Reserved							
32-35	Start PSN of the current Border-out							
36-39	Start PSN of the next Border-in							
40-511	Reserved							
512-2 047	Copy of Extended embossed information ^a							

a. These fields are copied from pre-recorded Physical format information in Control Data Block.

Table 40 - DVD-RW DL Ver. 2.0 unique part of RW-Physical format information

Bit Byte	7	6	5	4	3	2	1	0
17	Revision number of maximum recording speed ^a							
18	Revision number of minimum recording speed ^a							
19-25	Revision number table of recording speed ^a							
26	Class ^a							
27	Extended Part Version ^a							
28-31	Reserved							
32	Reserved							
33-35	Start PSN of the Middle Area							
36-39	Reserved							
40	Pre-recorded/Embossed information code ^b							
41-511	Reserved							
512-2 047	Extended embossed information ^a							

a. These fields are copied from pre-recorded/embossed Physical format information in Control Data Block.

b. This field value is copied from Pre-recorded/Embossed information code field in Format 3 RMD Field 0. This field is not the copy of Pre-recorded/Embossed information code field in pre-recorded/embossed Physical format information in Control Data Block.

4.5.3 Extra Border Zone

The Extra Border Zone is defined for DVD-RW and DVD-R media.

The structure of Extra Border Zone is similar to Border Zone. However, the length of Extra Border Zone is only 32 ECC blocks and there are no Next Border Markers and Stop Blocks. The Extra Border Zone structure is shown in Figure 16.

In case of DVD-R DL disc, there is same amount of buffer zone on L1 called Superficial Extra Border Zone. It has same kind of structure as Superficial Border-out and Superficial Border-in. See 4.18.5.5, "Border Zone for DVD-R DL media" on page 197

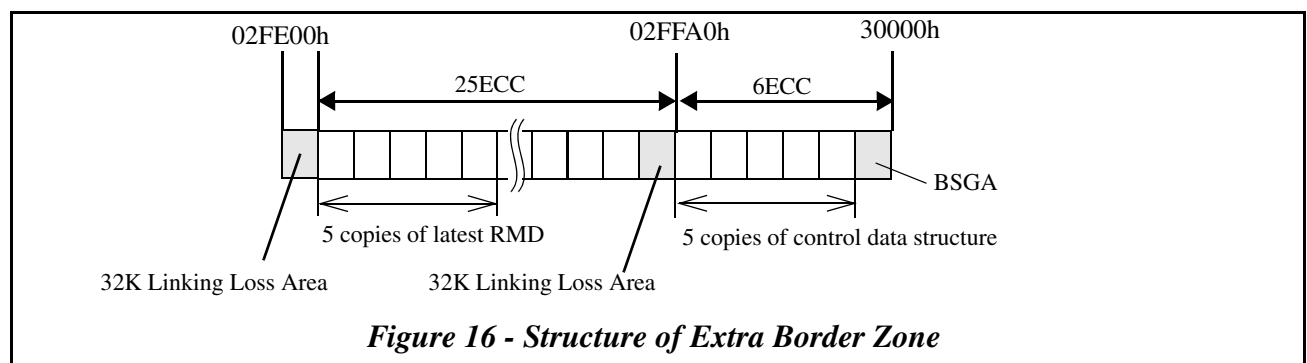


Figure 16 - Structure of Extra Border Zone

4.6 DVD READY condition/NOT READY condition

The READY condition occurs after a disc is inserted and the logical unit has performed its initialization tasks. These may include reading the Lead-in information from the media. This "READY" is different from and should not be confused with the ATA READY status. A CHECK CONDITION status *shall* be returned for the NOT READY condition only for commands that require or imply a disc access.

A NOT READY condition may occur for the following reasons:

1. There is no disc mounted, see 4.10, "*Removable medium*" on page 110
2. The logical unit is unable to load or unload the disc.
3. The logical unit is performing an extended operation as the result of an Immediate mode command such as FORMAT UNIT or BLANK. This condition is defined in Section 4.7, "*Logical Unit Not Busy condition/Busy condition*" on page 108.

The logical unit *shall* attempt to spin up and make the disc ready for media accesses when a new disc is detected.

After the logical unit becomes ready, the logical unit may enter the power state in which the logical unit was when the previous medium was removed.

Any media access that occurs when the logical unit is in the IDLE or STANDBY state *shall* spin the media up and not generate an error. Any media access that is requested while a deferred operation is in progress (i.e., writing from a write cache) *shall not* generate an error. Any media access that is requested while the logical unit is processing an Immediate command, e.g., BLANK or FORMAT UNIT with the Immediate bit set, may result in a NOT READY condition.

Note: Accesses to the media can be satisfied from the logical unit's cache and may not require the media to be spinning.

4.7 Logical Unit Not Busy condition/Busy condition

Logical Unit Not Busy condition/Busy condition are defined for DVD. See *Section 3.5, "Logical Unit Not Busy condition/Busy condition"* on page 77

4.8 DVD content protection

DVD Content Protection is made up of two basic concepts. The first is to scramble the content of the data such that it is unscrambled before it can be used. The capability to unscramble the content is provided only under conditions that require products that follow rules governing the copying, playback, and output of the content. The second basic concept is to use an "Authentication" process to exchange protected information (such as cryptographic Keys) required for the unscramble operation. This process ensures the integrity of such information during transfer from the logical unit to the host.

4.8.1 Content protection for read-only DVD

The DVD-Video Content Scrambling System (CSS) is used to protect DVD-Video content on read-only Discs. Content Protection for Prerecorded Media (CPPM) is used to protect DVD-Audio content on read-only Discs. For discs containing CSS or CPPM protected content (or both), the same authentication process is used. Thus, logical unit that support CSS authentication will also support CPPM without modification. Any read by the host to a disc that contains CSS scrambled content and a sector with a Title Key present, when the Authentication Success Flag (ASF) is set to zero *shall* be terminated with a CHECK CONDITION status, 5/6F/03 READ OF SCRAMBLED SECTOR WITHOUT AUTHENTICATION. For more information on the authentication process, see Figure 17. For more information on the Authentication Success Flag, see Figure 18.

Note: Although CSS and CPPM use the same authentication process for transferring the Disc Key or Album ID, CPPM protected sectors do not contain a Title Key. Thus for CPPM, the TITLE KEY Format is not used, and the Authentication Success Flag is not relevant.

For CSS protected content (DVD-Video) only, playback of the content is limited to specific regions of the world, as described in *Section 4.15, "Region Playback Control (RPC)"* on page 113.

4.8.2 Content protection for recordable and rewritable DVD

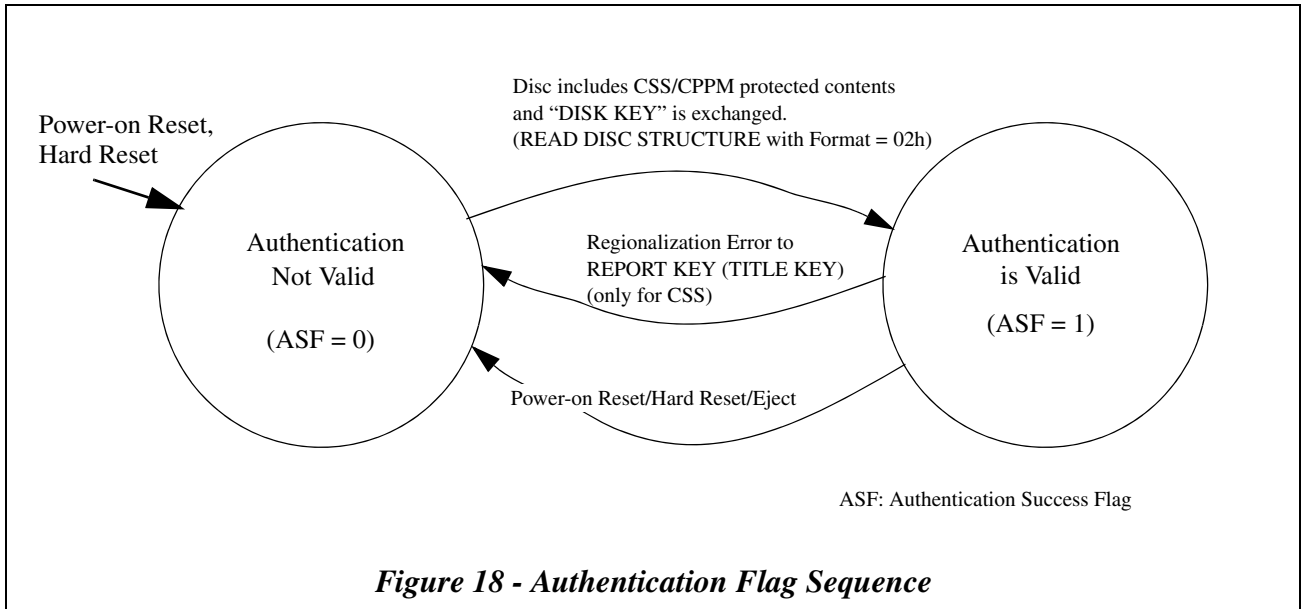
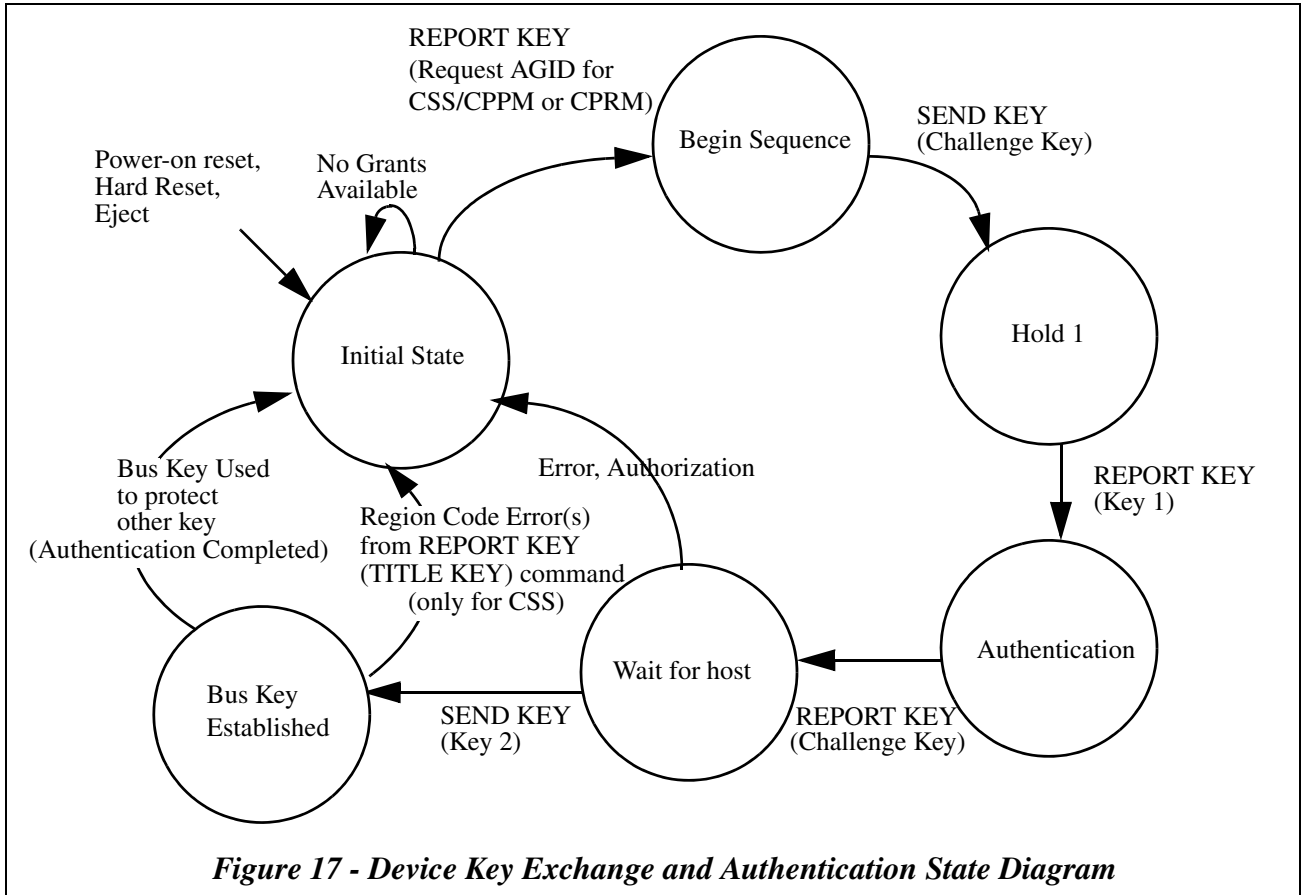
Content Protection for Recordable Media (CPRM) is used to protect audio and video content on recordable and rewritable DVD discs. The interface between the host and logical unit for CPRM is similar to that for CPPM, with the following differences:

- CPRM uses a "MEDIA IDENTIFIER" to bind protected content to the disc on which it is recorded. Before encrypting or decrypting such content the host reads the MEDIA IDENTIFIER value using the READ DISC STRUCTURE command with Format Code code 06h.
- The CPRM "MEDIA KEY BLOCK" is located in the Lead-in Area, and is read by the host using the READ DISC STRUCTURE command with Format Code code 07h.

The CPRM "MEDIA IDENTIFIER" and "MEDIA KEY BLOCK" are protected during transfer to the host using the same Authentication process used for CSS and CPPM, with the addition of a Message Authentication Code (MAC) algorithm described in the CPRM specification. For more information on the authentication process, see Figure 17.

4.8.3 Authentication process

Host *shall* reset hung authentication processes in the logical unit by invalidating the corresponding AGID. The host may detect lost grants by refusal of the Start Authentication Process operation. This diagram assumes the appropriate CSS/ CPPM/CPRM media is loaded. See Figure 17 and Figure 18.



4.9 Error reporting

If any of the following conditions occur during the execution of a command, the logical unit *shall* return CHECK CONDITION status. The appropriate Sense Key and additional sense code *shall* be set. The following list illustrates some error conditions and the applicable Sense Keys. The list does not provide an exhaustive enumeration of all conditions that may cause the CHECK CONDITION status.

Table 41 - Error conditions and Sense Keys

Condition	Sense Key
Invalid logical block address	ILLEGAL REQUEST
Unsupported option requested	ILLEGAL REQUEST
Attempt to read a blank block (where illegal)	ILLEGAL REQUEST
Attempt to play a data block as audio	ILLEGAL REQUEST
Logical unit reset or medium change since last command	UNIT ATTENTION
Self diagnostic failed	HARDWARE ERROR
Unrecovered read error	MEDIUM ERROR / HARDWARE ERROR
Recovered read error	RECOVERED ERROR
Overrun or other error that might be resolved by repeating the command	ABORTED COMMAND

In the case of an invalid logical block address, the sense data information field *shall* be set to the logical block address of the first invalid address.

In the case of an attempt to read a blank or previously unwritten block, the sense data information field *shall* be set to the logical block address of the first blank block encountered. The data read up to that block *shall* be transferred.

4.10 Removable medium

DVD medium is sometimes contained within a cartridge to prevent damage to the recording surfaces. The combination of medium and optional cartridge is often called a volume.

A disc has an attribute of being mounted or de-mounted on a suitable transport mechanism. A disc is mounted when the logical unit is capable of performing read operations to the medium or is able to format it. A mounted disc may not be accessible by a host if it has been reserved by another host. A disc is de-mounted at any other time (e.g., during loading, unloading, or storage).

A host may check whether a disc is mounted by issuing a TEST UNIT READY command. In addition, there now exists the Removable Medium Feature. This Feature allows the host to prevent the removal of any media, as well as sensing requests from the user to remove media.

The PREVENT ALLOW MEDIUM REMOVAL command allows a host to restrict the demounting of the disc. This is useful in maintaining system integrity. If the logical unit implements cache memory, it *shall* ensure that all logical blocks of the medium contain the most recent data prior to permitting demounting of the disc. If the host issues a START STOP UNIT command to eject the disc, and is prevented from demounting by the PREVENT ALLOW MEDIUM REMOVAL command, the START STOP UNIT command is rejected by the logical unit.

4.11 Logical blocks

Blocks of data are stored on the medium along with additional information that the controller uses to manage the storage and retrieval. The format of the additional information is unique and is hidden from the host during normal read or write operations. This additional information is often used to identify the physical location of the blocks of data and the address of the logical block, and to provide protection against the loss of the user data.

The address of the first logical block is zero. The address of the last logical block is [n-1], where [n] is the number of logical blocks available on the medium. A READ FORMAT CAPACITIES command may be issued to determine the

value of [n-1]. If a command is issued that requests access to a logical block not within the capacity of the medium, the command is terminated with CHECK CONDITION status, 5/21/00 LOGICAL BLOCK ADDRESS OUT OF RANGE.

The number of bytes of data contained in a logical block is known as the block length. Each logical block has a block length associated with it. The block length *shall not* be different for each logical block on the medium. The block descriptor in the MODE SENSE (10) data describes the block length that is used on the medium. The block descriptor *shall not* be present for an ATAPI Multi-Media logical unit. In addition, the Block Descriptor has been made Obsolete in this specification.

The location of a logical block on the medium is not required to have a specific relationship to the location of any other logical block. However, in a typical logical unit the logical blocks are located in an ascending order. The time to access the logical block at address [x] and then the logical block at address [x+1] need not be less than time to access [x] and then [x+100].

4.12 Data cache

Some logical units implement cache memory. A cache memory is usually an area of temporary storage in the logical unit with a fast access time that is used to enhance performance. It exists separately from the blocks of data stored and is normally not directly accessible by the host. Use of cache memory for write or read operations typically reduces the access time to a logical block and can increase the overall data throughput.

During read operations, the logical unit uses the cache memory to store blocks of data that the host may request at some future time. The algorithm used to manage the cache memory is not part of this specification. However, parameters are provided to advise the logical unit about future requests, or to restrict the use of cache memory for a particular request.

Sometimes the host may wish to have the blocks of data read from the medium instead of from the cache memory. The force unit access (FUA) bit is used to indicate that the logical unit *shall* access the physical medium. For a write operation, setting FUA to one causes the logical unit to complete the data write to the physical medium before completing the command. For a read operation, setting FUA to one causes the logical blocks to be retrieved from the physical medium.

Commands may be implemented by the logical unit that allow the host to control other behavior of the cache memory:

- The MODE SENSE (10) command defines a page for the control of cache behavior and handles certain basic elements of cache replacement algorithms.
- The SYNCHRONIZE CACHE (10) command is used by the host to guarantee that data in the cache has been moved to the media.

4.13 Seek

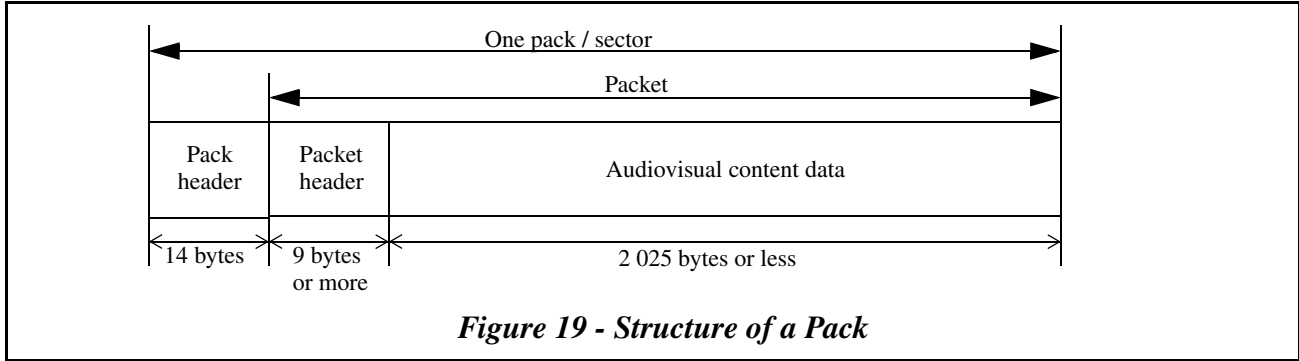
The SEEK command provides a way for the host to position the logical unit in preparation for access to a particular logical block at some later time. Since this positioning action is implicit in other commands, the SEEK command may not be useful with some logical units.

4.14 DVD Video format information for CSS Managed Recording

Audiovisual contents in DVD Video may be scrambled by CSS. In the scrambled audiovisual contents, some data is scrambled and some data is not scrambled. In the case of the scrambled data, the CP_SEC bit in the CPR_MAI field of the Data Unit 1 *shall* be set to 1. Additionally the CPM bit and the CGMS bit field in the CPR_MAI field of the scrambled audiovisual contents *shall* be set to 1b and 11b. See 4.4.2, "Data Unit 1" on page 91 for structure of Data Unit 1.

4.14.1 Data type in the DVD Video title

The Video and related data in the audiovisual contents are named as Video Object (VOB). See Figure 36 - *Example of DVD-Video volume structure* on page 137 for DVD Video title structure. The audiovisual data in the VOB is named as Pack. The size of one Pack is one sector. See Figure 19.



Four types of Packs are defined for the VOB.

Table 42 - List of Pack types

Pack	Data (in Pack)
Navigation Pack (NV_PCK)	Presentation Control Information (PCI) and Data Search Information (DSI)
Video Pack (V_PCK)	Video data
Audio Pack (A_PCK)	Audio data
Sub-picture Pack (SP_PCK)	Sub-picture data

NV_PCK is never scrambled because it is used to search the VOB (Video scene) in the audiovisual content. And some Packs are not scrambled according to the CSS PROCEDURAL SPECIFICATIONS. Refer to the specific specification for detail information.

4.14.2 Scrambled data indicators

In the DVD-Video and DVD disc specification, there are two fields that show the Pack scrambling status field in sector header and field in user data.

Table 43 - Scrambled data indicators and corresponded information

bit/field	Bit position	description
CP_SEC bit	Byte 0, bit 6 in CPR_MAI field of Data Unit 1 (in sector header)	1: data in the Pack is scrambled 0: data is not scrambled
PES_scrambling_control field (this field is not defined in NV_PCK)	Byte 20, bit 5-4 of V_PCK, A_PCK, and SP_PCK (in Packet header of user data)	00b: data in the Pack is not scrambled 01b: data is scrambled by CSS 10b: Reserved 11b: data is scrambled by other method
	Byte 21, bit 5-4 of NV_PCK: part of the bit rate field	00b (fixed value)

4.15 Region Playback Control (RPC)

There is an additional copy management capability used for Copy Protected DVD-ROM media that limits the playback of content to specific regions of the world. The capability is called Region Playback Control (RPC) or Regionalization.

4.15.1 Playback limitations by world region

The use of Regionalization is limited to Discs that employ CSS. There are two places that contain region information, one in the logical unit and another for each media that contains CSS Scrambled Title(s). When the region in the logical unit and that of the CSS Title are different, the system *shall* prevent the playback of that title (movie).

When a REPORT KEY command with KEY Format Code of 04h (Title Key) is received by a logical unit that is in the Bus Key Established state (see Figure 17 - *Device Key Exchange and Authentication State Diagram* on page 109), and the region code of the current media is not playable in the current region set in the logical unit, the command *shall* be terminated with CHECK CONDITION status, 5/6F/04 MEDIA REGION CODE IS MISMATCHED TO LOGICAL UNIT REGION. Regionalized CSS media *shall* be deemed not playable if the region of the logical unit is not set.

If the Region Code Mismatch error is generated, the Authentication Success Flag (ASF) *shall* be reset to zero.

The logical unit will report the current RPC state using the REPORT KEY command with KEY Format Code 08h. The logical unit *shall not* report an error concerning media to this KEY Format code.

Note: Some current logical units may return the error concerning media. In this case, host should ignore this error and host should proceed to the next step. The logical unit may support RPC. When “5/6F/04 MEDIA REGION CODE IS MISMATCHED TO LOGICAL UNIT REGION” error is reported, host should check the logical unit RPC setting.

4.15.2 Region code setting

Two methods have been defined for setting the region code in the DVD logical unit. Each method has the same end result, specifying which region *shall* be used to determine if it is allowable to play a movie which has a region code included within the information on the disc in this drive.

The logical unit has the following four Region States according to the Drive Region setting (see Figure 20):

- | | |
|----------------------|---|
| 1. NONE state | The Drive Region has not been set and the host Computer <i>shall</i> set the initial Drive Region value in the logical unit. The region setting counter <i>shall</i> be 5. The logical unit <i>shall</i> respond to the REPORT KEY command, KEY Format 01000b, with successful command completion and a Region Mask value of FFh. |
| 2. SET state | The Drive Region has been set and the change of the Region is acceptable. The region setting counter <i>shall</i> initially be 4, decrementing to 2. |
| 3. LAST CHANCE state | The Drive Region has been set and the change of the Region is acceptable. In order to change the Drive Region using a command method, an inserted disc <i>shall</i> have the same single region with the requested Region. The region setting counter <i>shall</i> be 1. |
| 4. PERMANENT state | The Drive Region has been set and the change of the Region is not acceptable. The region setting counter <i>shall</i> be 0. However, the Drive Region can be re-initialized by the vendor to become the NONE state. |

4.15.2.1 Initial setting

In the NONE state, the Drive Region has not been set and the host *shall* set the initial Drive Region value in the logical unit. The region setting counter *shall* be 5. The logical unit *shall* respond to the REPORT KEY command, KEY Format 01000b, with successful command completion and a Region Mask value of FFh.

The Drive Region *shall* be set by one of the two methods specified. In case of the command method, the drive ignores the region code of the inserted medium. In the command method, the host *shall* set a preferable region, the value of which is specified in the Preferred Drive Region Code field of the SEND KEY command with KEY Format = 000110b. On execution of this command, the drive ignores the region code of the inserted medium.

After the successful execution of setting the Drive Region, the region setting counter *shall* be decremented to 4 and the drive *shall* enter SET state.

4.15.2.2 Changing of the Drive Region

In the SET state, the Drive Region has been already set and may be changed by one of the following two methods. After the successful execution of changing the Drive Region, the region setting counter *shall* be decremented. When the region setting counter is 1, the drive *shall* enter into the LAST CHANCE state.

In the LAST CHANCE state, the Drive Region may be changed by one of the following two methods. In the case of command method with a disc, the inserted disc *shall* have the same single Region Code value as the Preferred Drive Region Code specified in the SEND KEY command. After the successful execution of the Drive Region change, the region setting counter *shall* be zero and the drive *shall* enter into the PERMANENT state.

In the PERMANENT state, the user cannot change the Drive Region.

4.15.2.2.1 Command method for changing the Drive Region with a CSS enabled disc

To set the Drive Region, the procedure *shall* be executed as follows;

1. Insert a disc having the requested Region, (this is not required for the Initial Setting)
2. Issue a SEND KEY command with the KEY Format = 000110b. The requested Region Code value *shall* be specified in the Preferred Drive Region Code field.

When the logical unit receives the SEND KEY command correctly, the Drive Region is changed to the requested region.

If the disc does not have the same region code value as the Preferred Drive Region Code specified in the SEND KEY command, then the command *shall* be terminated with CHECK CONDITION status, 5/6F/04 MEDIA REGION CODE IS MISMATCHED TO LOGICAL UNIT REGION.

4.15.2.2.2 Setting disc method for changing the Drive Region

The Drive Region may be set by inserting a special disc which contains a specific region code. This special disc does not require any command intervention.

4.15.3 Limits on Drive Region changes

Any of the methods defined in this specification may be used up to five times to set a logical unit's region. If the new region is the same as the old region, the region setting process *shall* be treated as if it had not occurred.

If an attempt by the user is made to change the Drive Region more than five times, the SEND KEY command *shall* terminate with CHECK CONDITION status, 5/6F/05 DRIVE REGION MUST BE PERMANENT/REGION RESET COUNT ERROR.

For more information on the region code setting process, see Figure 20.

4.15.4 RPC states

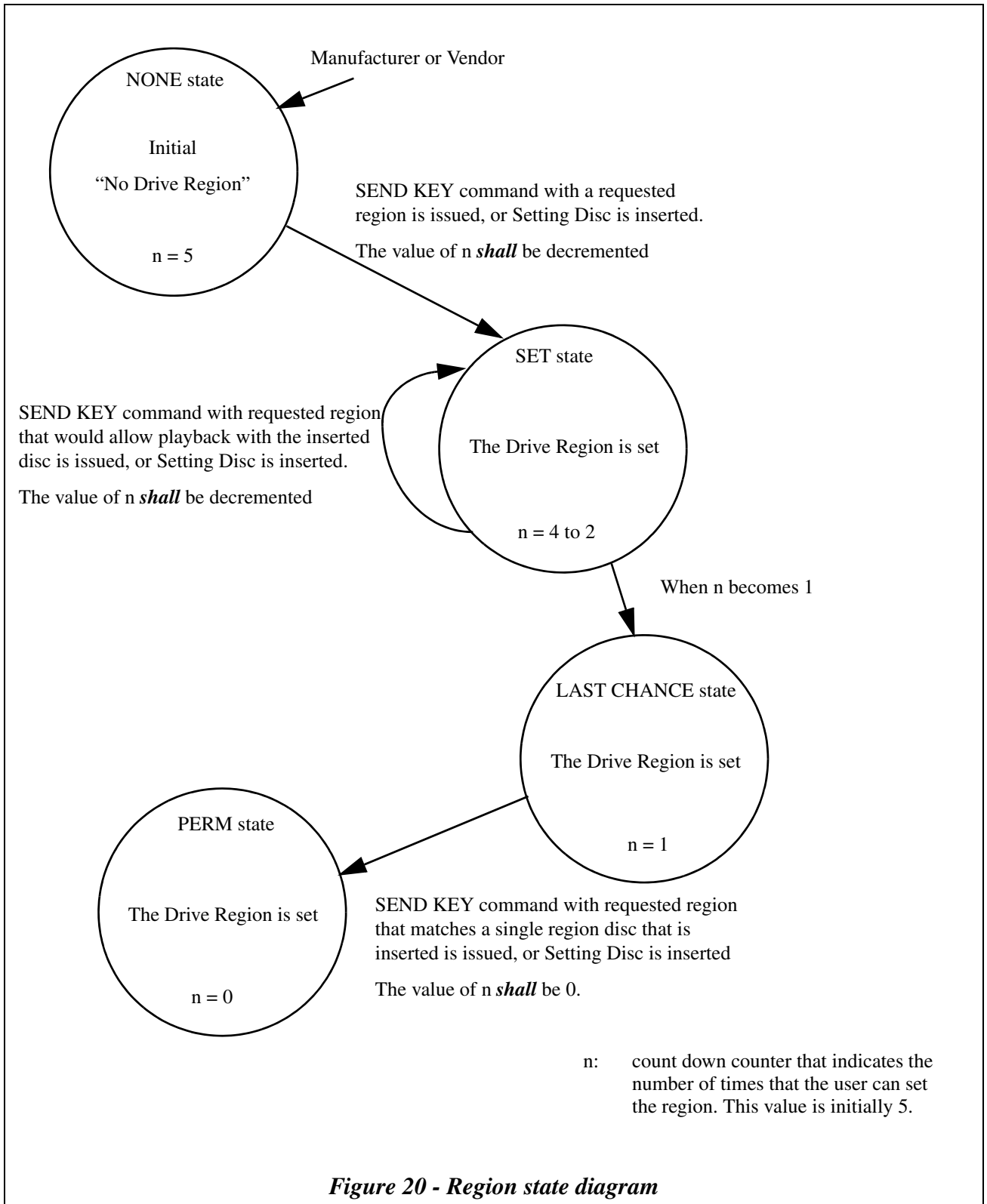


Figure 20 - Region state diagram

4.16 Recording and reading for DVD-RAM media

DVD-RAM media is directly addressable by a logical block address and permits reading and writing from any of the consecutively numbered logical blocks. Though the Logical Block Addresses are consecutive, the actual data may not be stored in a consecutive manner because of defect management and the existence of physical sectors which do not directly correspond to logical blocks. Such physical sectors comprise spare sectors and unused sectors.

4.16.1 Logical layout of DVD-RAM media

DVD-RAM media is divided into multiple Zones. The first sector of each revolution in these Zones always align. The data is recorded using a constant angular velocity within each Zone, thus the actual size of the “bits” within a zone increase from the beginning of a zone toward the end of the zone. This keeps the data rate constant for reading and writing within each Zone with constant rotational speed. Each Zone has a fixed radius in width and as such each contains a different number of sectors.

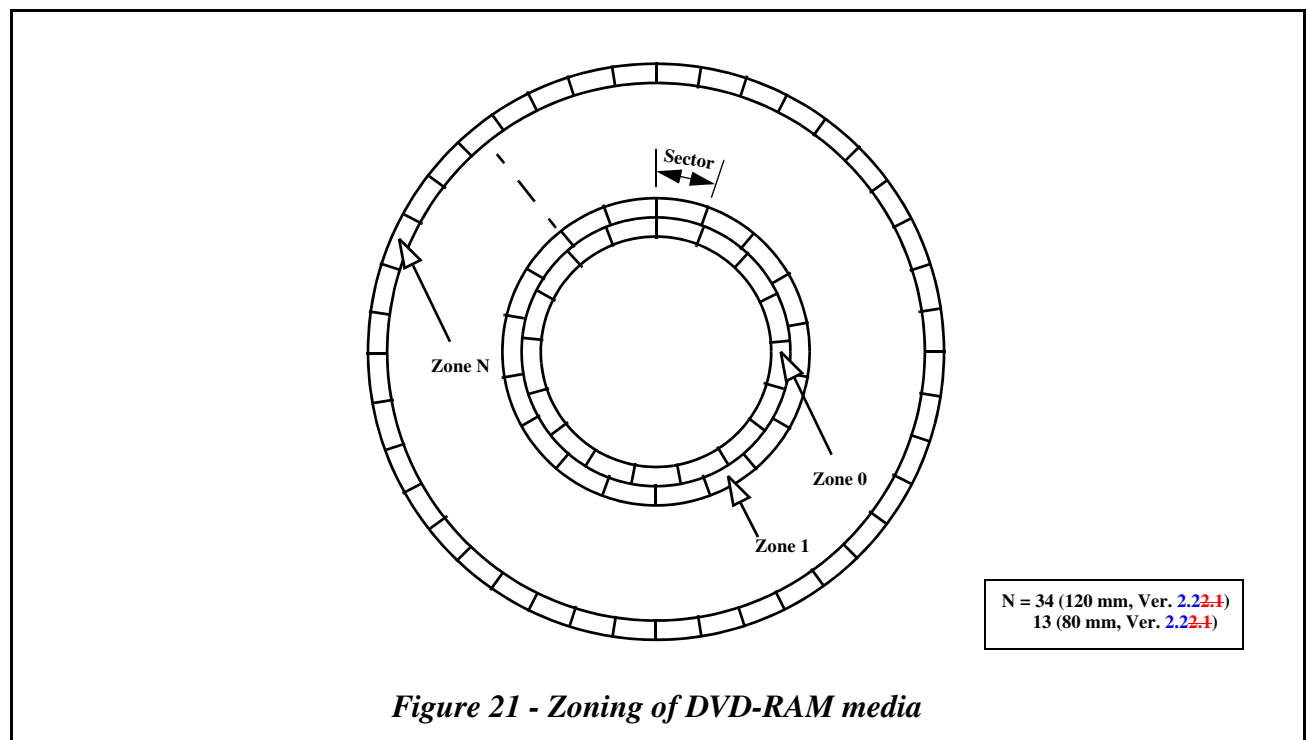


Figure 21 - Zoning of DVD-RAM media

The Data Area begins at 031000h for DVD-RAM, apart from DVD-ROM and DVD-R, where Data Areas begin at 030000h. This is caused by the existence of Defect Controls. There are two Defect Controls: one is located immediately before the Data Area and starts at 030000h, and the other is located immediately after the Data Area. The Defect Controls are non-user addressable areas. These blocks contain Defect Management Areas (DMAs).

The DMA contains Disc Definition Structure (DDS) for the recording method used for formatting of the disc, a Primary Defect List (PDL) for recording defective sectors identified at formatting of the disc, and a Secondary Defect List (SDL) for recording defective ECC blocks identified during writing/reading user data.

- DVD-RAM Ver. 2.2

The Data Area has one or two Spare Areas. There are two types of Spare area, Primary Spare Area (PSA) and Supplementary Spare Area (SSA). See Figure 9 - *Physical and logical layout of DVD-RAM Ver. 2.2 media* on page 89. Primary Spare Area is always pre-assigned at Initialization/Re-initialization. Pre-assigned Supplementary Spare Area is selectable at Initialization/Re-initialization. And Supplementary Spare Area is expandable after Initialization/Re-initialization. The User Area and Spare Areas contain user accessible sectors addressed by an LBA. The LBAs increase toward the Outer Diameter. Defective sectors are replaced by sectors in the Spare Area. The last LBA is 23051Fh in the case of 120 mm and AE6EFh in the case of 80 mm.

The location of Primary Spare Area is written in the DDS and the location of Supplementary Spare Area is written in the SDL.

The total number of sectors in Primary Spare Area is 12 800 in the case of 120 mm and 5 120 in the case of 80 mm. DVD-RAM Ver. 2.2 has only one group. The total number of sectors in Supplementary Spare Area is from 0 to 97 792 in the case of 120 mm and 89 088 in the case of 80 mm. The Guard Area is located at the boundary to prevent signal crosstalk between Zones (See Table 44). LBA of first Sector in the Group in Table 44 is the case of no defects in the media.

4.16.2 *Supplementary Spare Area*

As long as a disc is used with a cartridge, PSA has enough size to ensure user data. PSA is allocated in inner area of the Data Area regardless of formatting type. A block in the PSA is used as a replacement block of a defective block in the user Data Area according to Slipping Replacement Algorithm or Linear Replacement Algorithm.

When a disc is used without a cartridge, defective blocks caused by contamination may increase unexpectedly. In order to supplement insufficiency of spare blocks, SSA can be allocated on formatting or after formatting. SSA is allocated in the most outer area of the Data Area and may grow toward inner radius.

On formatting of a disc, the host can allocate SSA with FORMAT UNIT command with Format Type field of 00h in the Format Descriptor. See Figure 22. The number of blocks to be used for user data recording is specified with Number of Blocks field in the Format Descriptor, and the rest of Data Area is assigned for SSA. All allocatable number of blocks *shall* be returned in Formattable Descriptors with Format Type field of 00h in response to READ FORMAT CAPACITIES command. On the formatting with Format Type with 00h, defect management information may be changed and user data written before the formatting is not guaranteed.

If the number of available spare blocks decreases because of many replacement operation, SSA is expandable after formatting of a disc. The logical unit *shall* report CHECK CONDITION status, 1/5D/03 FAILURE PREDICTION THRESHOLD EXCEEDED - Predicted Spare Area Exhaustion in response to the command after detecting consumption of available spare blocks. If the host receives the Recovered Error for consumption of spare area, the host should issue FORMAT UNIT command with Format Descriptor that contains Format Type field of 01h and the Number of Blocks field. The Format Descriptor, that is sent with FORMAT UNIT command *shall* be one of the Formattable Descriptors returned by READ FORMAT CAPACITIES command. All allocatable number of blocks *shall* be returned in Formattable Descriptors with Format Type field of 01h in response to READ FORMAT CAPACITIES command, but Formattable Descriptors that contain the Number of Blocks larger than or equal to the current Number of Blocks *shall not* be returned. If the area that is newly allocated to the SSA includes user data, the host should move the user data and update file management information. On expansion operation of SSA, user data that is included in the LBA Space after expansion *shall* be retained and defect management information *shall not* be changed.

SSA *shall* be used after PSA exhaustion. See Figure 23. The Spare Area is used in descending Block order in each of Spare Areas, and the defective sectors in the Spare Area and the corresponding replacement sectors, which have been already registered in the PDL or the SDL, *shall not* be used as spare sectors.

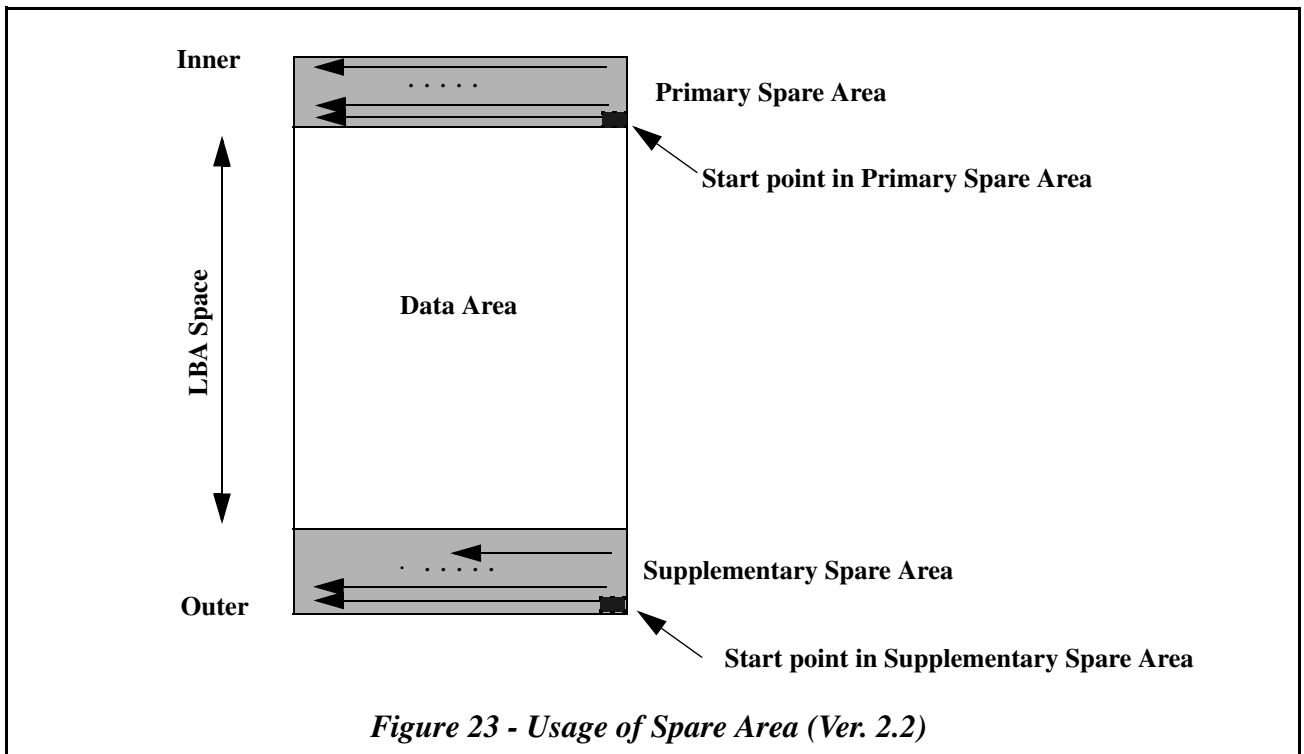
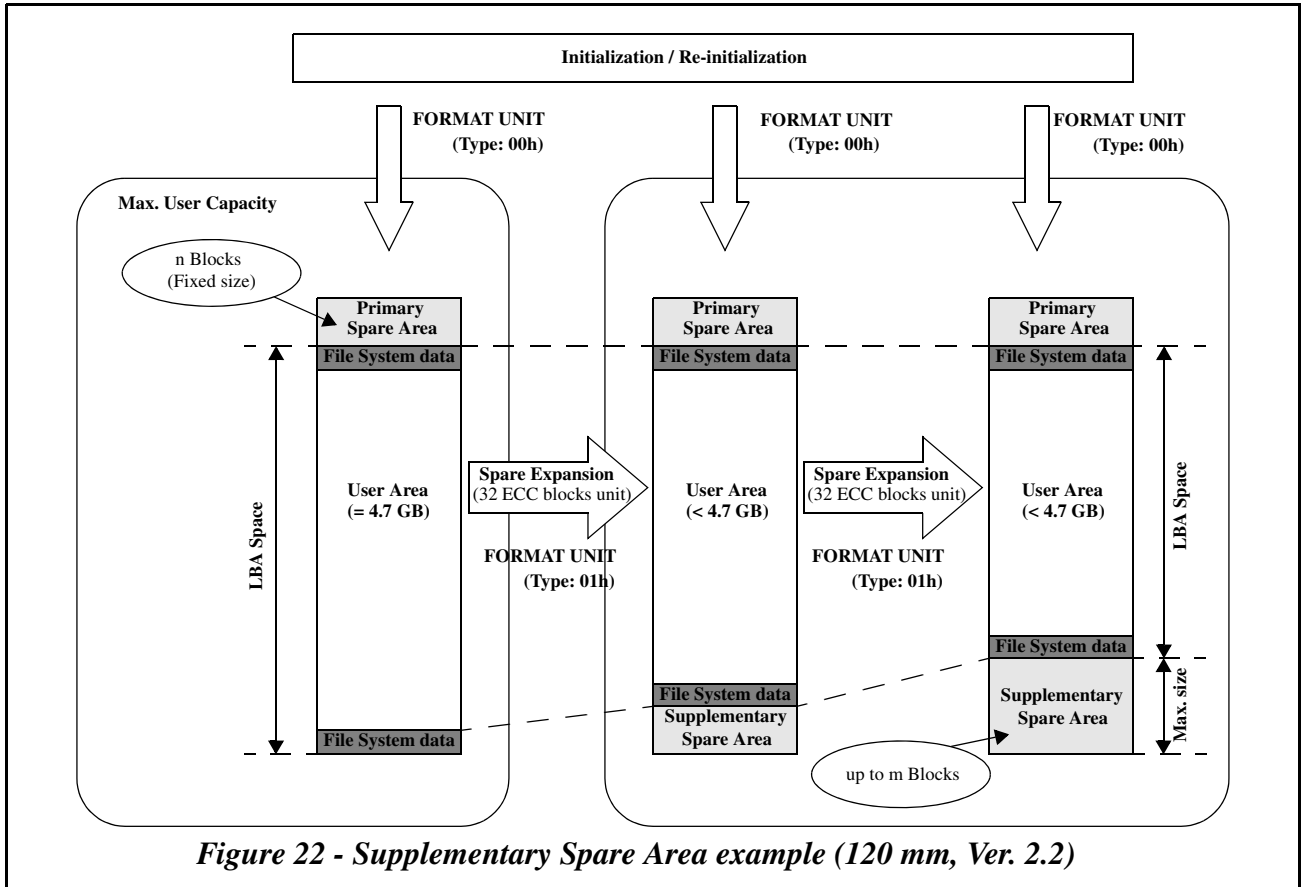


Table 44 - Allocation of Data Area of DVD-RAM Ver. 2.2 media (120 mm)

Zone No.	Group No.	No. of Physical Sectors				LBA of first Sector in the Zone ^a
		Guard Area	User Area	Spare Area	Guard Area	
0	0	0	22 240	12 800	64	0
1	0	64	40 640	0	64	22 240
2	0	64	42 208	0	64	62 880
3	0	64	43 776	0	64	105 088
4	0	64	45 344	0	64	148 864
5	0	64	46 912	0	64	194 208
6	0	64	48 480	0	64	241 120
7	0	64	50 048	0	64	289 600
8	0	80	51 584	0	80	339 648
9	0	80	53 152	0	80	391 232
10	0	80	54 720	0	80	444 384
11	0	80	56 288	0	80	499 104
12	0	80	57 856	0	80	555 392
13	0	80	59 424	0	80	613 248
14	0	80	60 992	0	80	672 672
15	0	80	62 560	0	80	733 664
16	0	96	64 096	0	96	796 224
17	0	96	65 664	0	96	860 320
18	0	96	67 232	0	96	925 984
19	0	96	68 800	0	96	993 216
20	0	96	70 368	0	96	1 062 016
21	0	96	71 936	0	96	1 132 384
22	0	96	73 504	0	96	1 204 320
23	0	96	75 072	0	96	1 277 824
24	0	112	76 608	0	112	1 352 896
25	0	112	78 176	0	112	1 429 504
26	0	112	79 744	0	112	1 507 680
27	0	112	81 312	0	112	1 587 424
28	0	112	82 880	0	112	1 668 736
29	0	112	84 448	0	112	1 751 616
30	0	112	86 016	0	112	1 836 064
31	0	112	87 584	0	112	1 922 080
32	0	128	89 120	0	128	2 009 664
33	0	128	90 688	0	128	2 098 784
34	0	128	105 600-M ^b	M	0	2 189 472
Total	N/A	3 136	2 295 072-M	12 800+M	3 072	N/A

a. "LBA of first Sector in the Zone" is for a defect free disc.

b. Where 'M' is the number which is multiple of 512 sectors (32 ECC blocks), and maximum number of 'M' is 97 792.

Table 45 - Allocation of Data Area of DVD-RAM Ver. 2.2 media (80 mm)

Zone No.	Group No.	No. of Physical Sectors				LBA of first Sector in the Zone ^a
		Guard Area	User Area	Spare Area	Guard Area	
0	0	0	29 920	5120	64	0
1	0	64	40 640	0	64	29 920
2	0	64	42 208	0	64	70 560
3	0	64	43 776	0	64	112 768
4	0	64	45 344	0	64	156 544
5	0	64	46 912	0	64	201 888
6	0	64	48 480	0	64	248 800
7	0	64	50 048	0	64	297 280
8	0	80	51 584	0	80	347 328
9	0	80	53 152	0	80	398 912
10	0	80	54 720	0	80	452 064
11	0	80	56 288	0	80	506 784
12	0	80	57 856	0	80	563 072
13	0	80	93 552-M ^b	M	0	620 928
Total	N/A	928	714 480-M	5 120+M	912	N/A

a. "LBA of first Sector in the Zone" is for a defect free disc.

b. Where 'M' is the number which is multiple of 512 sectors (32 ECC blocks), and maximum number of 'M' is 89 088.

4.16.3 DVD-RAM ECC block boundary issue

The location of logical sectors is derived from the defect list information. When a physical sector is found defective and newly slipped during formatting, a result is that the ECC block boundaries change and thus the addressing of all the following sectors in that zone changes. Following any new "slipping" of a physical sector, all the following ECC blocks in that zone **shall** be written with new ECC block boundaries before reading. The only exception is a case when all the following ECC blocks have been written with the initialization pattern used at certification which can be determined by the Data ID of the logical block. In this case, the logical unit discriminates the initialization pattern even when the ECC block boundaries are incorrect and **shall** treat these ECC blocks as if all zero data has been written.

4.16.4 Unrecorded ECC blocks

A DVD-RAM disc which has not been certified may contain unrecorded ECC blocks to which user data has not been written. The logical unit **shall** return all zero data in response to an attempt to read logical blocks from such unrecorded ECC blocks. Further, a logical block may contain an initialization pattern used at certification which can be discriminated by the Data ID of the logical block. The logical unit also returns all zero data in response to an attempt to read such Logical Blocks containing the initialization pattern.

4.16.5 Read Modify Write

Any attempt to write data less than one ECC block causes a read-modify-write operation in the logical unit, which requires more than one rotation to write the data, if data is not cached.

1. Reading an ECC block containing the designated logical blocks (First path)
2. Overlay the data to be written onto the read out ECC block data
3. Writing the modified ECC block data back to the same addresses (Second path)

When an ECC block designated for Read-Modify-Write operation is physically unwritten or contains the initialization pattern used at certification, which can be discriminated by the Data ID of the Logical Block, the logical unit writes all zero data to the logical blocks in the ECC block other than the designated Logical Blocks from the host.

A technique to provide better performance with DVD-RAM media is to write data in sizes that are a multiple of 32 768 bytes starting at a logical block address that is a multiple of 16, which results in a one path direct overwrite operation. These values can be determined from the Random Readable Feature Descriptor (see 17.4.2.6, "Feature 0010h: Random Readable" on page 573).

4.16.6 Data ID

DVD-RAM has major differences from DVD-ROM, DVD-R/-RW, DVD+RW in that embossed Headers are used to identify the physical sectors. The address used by the logical unit to read or write sectors is the "physical" address, not the Data ID.

4.16.7 Defect management for DVD-RAM media

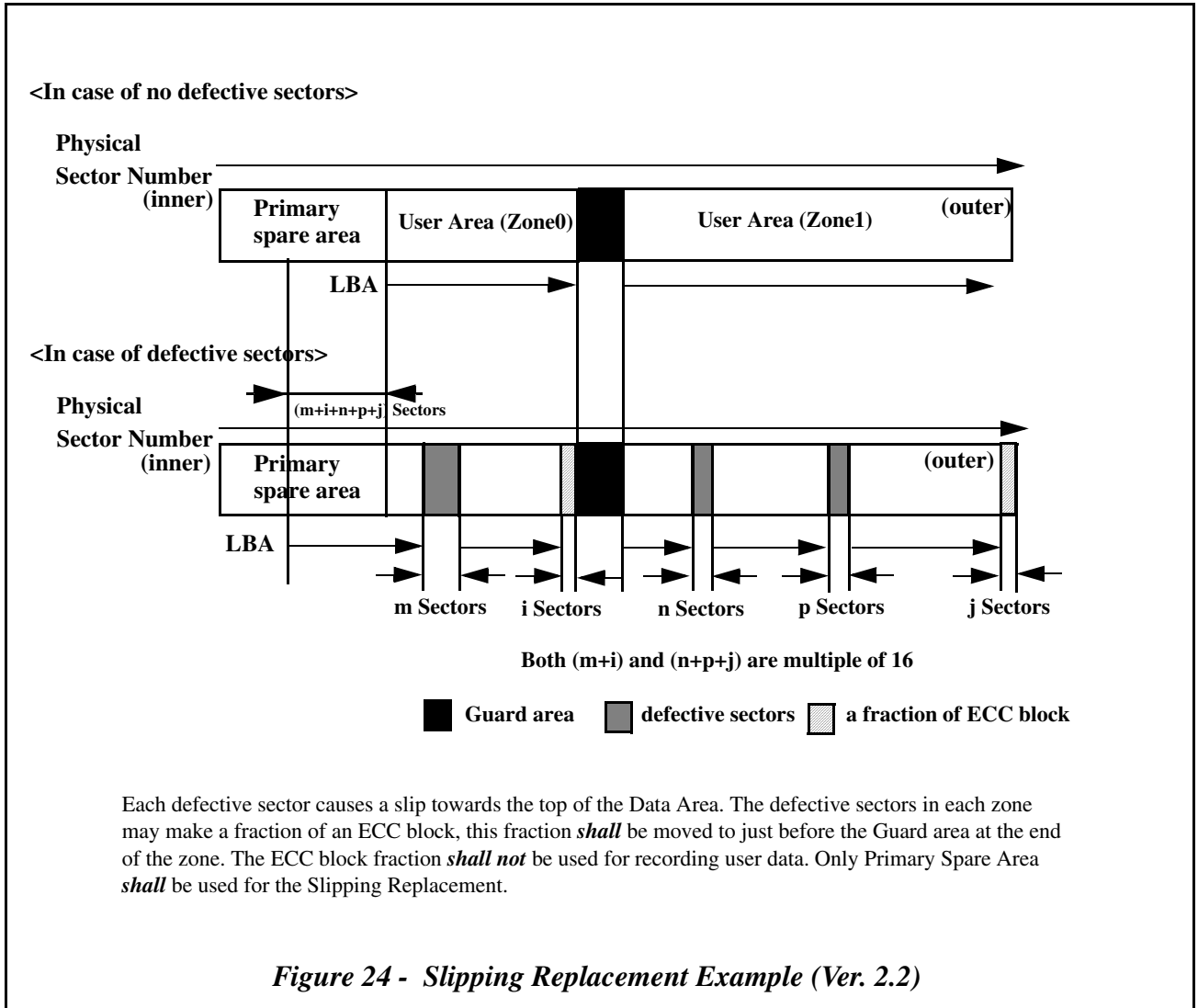
Defective physical sectors in the Data Area of DVD-RAM media are managed by the logical unit according to the defect management scheme specified in the DVD Book for Rewritable Disc, Part 1: Physical Specifications.

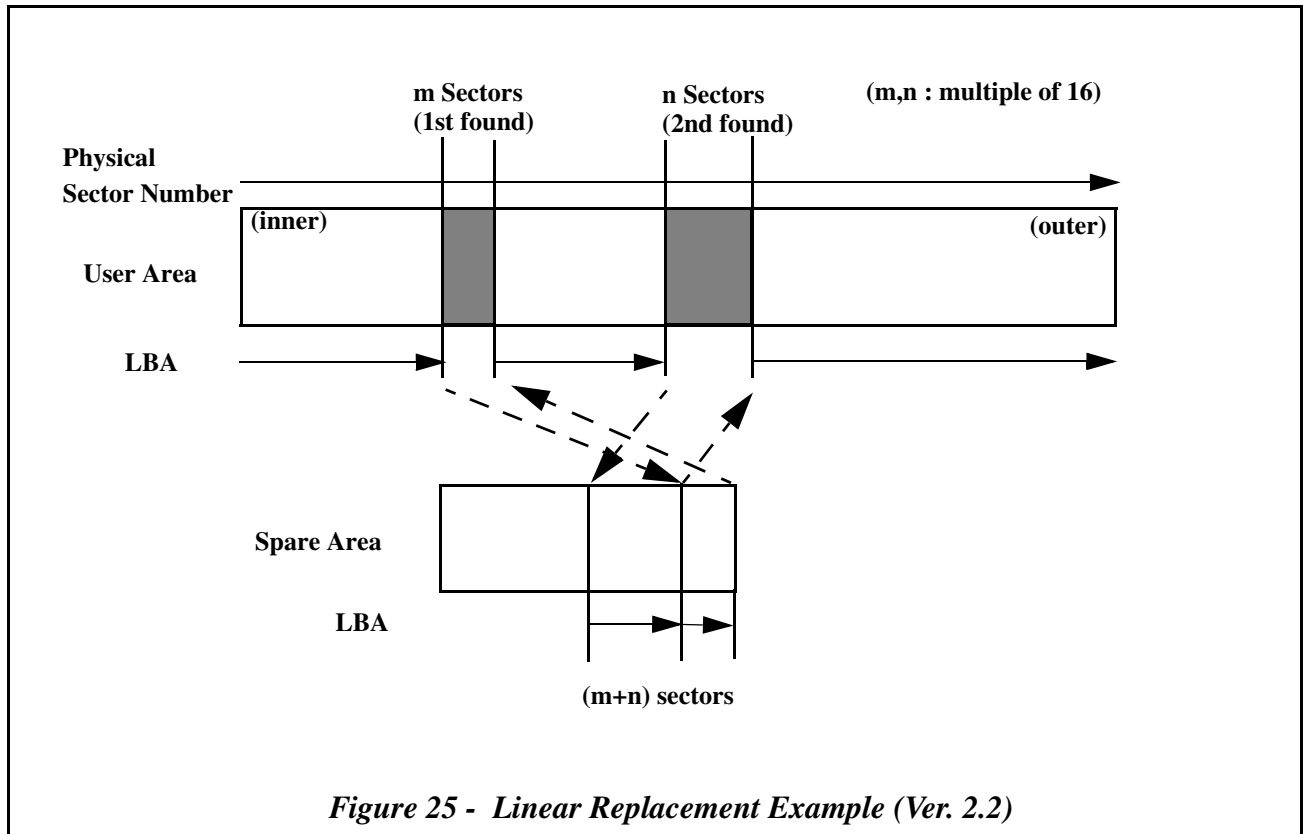
Two replacement methods are defined for defective physical sectors:

Slipping replacement is the first method in which a defective physical sector is replaced by the first non-defective physical sector following the defective physical sector. The slipping replacement is performed in units of a physical sector. Defective sectors replaced by the slipping replacement are listed in Primary Defect List (PDL) recorded on the DVD-RAM media during formatting. Contents of the PDL on DVD-RAM media can be changed only by formatting. The number of sectors in a group to be listed in the PDL **shall not** exceed the number of sectors in the Spare Area in that group. Entries of the PDL consist of three categories: P-list, G₁-list and G₂-list.

- Defective physical sectors encountered by media manufacturer before shipment of the DVD-RAM media are listed in the P-list. A defect is registered to the P-list in a unit of 1 physical sector. Time to perform the slipping replacement for a defective sector listed in the P-list is minimal, because it requires time only to pass the defective sector. The P-list **shall** be preserved during any formatting and **shall** be always used in order to avoid possible change of ECC block framing by formatting.
- Defective physical sectors encountered by certification after shipment of the DVD-RAM media are listed in the G₁-list. A defect is registered to the G₁-list in a unit of 1 physical sector. Time to perform the slipping replacement for a defective sector listed in the G₁-list is minimal as in the P-list. The G₁-list **shall** be always used and **shall** only be changed with certification in order to avoid possible change of ECC block framing by formatting.
- Defective physical sectors transformed from the SDL by formatting are listed in the G₂-list. A defect registered to the G₂-list consumes 16 entries at once. Time to perform the Slipping Replacement for defective sector listed in the G₂-list is longer than the time for P-list or G₁-list, because it requires time to pass 16 consecutive sector. However, it is still much faster than Linear Replacement because it does not require a Seek operation to the Spare Area. The G₂-list can be changed without certification, however, the G₂-list **shall** be disposed at certification in order to avoid possible change of ECC block framing by formatting.

Linear Replacement is the second method in which a defective physical sector is replaced by the first available physical sector out of spare sectors. The linear replacement is performed in a unit of 16 physical sectors (an ECC block). An ECC block found to be defective is replaced by the first available good spare ECC block of the group. If there is no spare ECC block left in that group, the first available good spare ECC block of another group is used (DVD-RAM Ver. 2.2 has only one group). Defective ECC blocks replaced by the Linear Replacement are listed in the Secondary Defect List (SDL) recorded on the DVD-RAM media. Contents of the SDL on DVD-RAM media are updated whenever an ECC block is found to be defective. When a replacement ECC block is found to be defective, a new replacement ECC block will be substituted and the SDL will be updated on the media. Chaining of replacement will not be performed, direct pointer method will be applied. Time to perform the Linear Replacement is longest because it requires seek operation to the Spare Area and writing/reading the replacement ECC block. However, this is the only method to register a new defect without formatting the media.





4.16.8 DMA information

The Defect Management Area (DMA) consists of two ECC blocks. The first ECC block contains the Disc Definition Structure (DDS) for the recording method used for formatting of the disc, and the Primary Defect List (PDL) for recording defective sectors identified at formatting of the disc. The DDS contains the following information.

- In-process (In-progress, in the case of DVD-RAM Ver. 2.2) flag indicating formatting operation is completed or not. This flag enables to recover a suspended formatting operation.
- A flag indicating the media has been certified by media manufacturer or not.
- A flag indicating the media has been certified by the logical unit or not.

The PDL contains information of defective sectors to be replaced by the slipping replacement. Though the PDL has a capacity to hold defective sector information for up to 7 679 sectors in the case of 120 mm and 4 095 sectors in the case of 80 mm, there is another limitation of the maximum number. See Figure 27 - *Limitation of maximum number of sectors for PDL and SDL* on page 126.

The second ECC block contains the Secondary Defect List (SDL) for recording defective ECC blocks identified during writing/reading user data. Though the SDL has a capacity to hold the defective ECC block information up to 3 837 ECC blocks which corresponds to 61 392 sectors, there is another limitation of the maximum number. See Figure 27 - *Limitation of maximum number of sectors for PDL and SDL* on page 126.

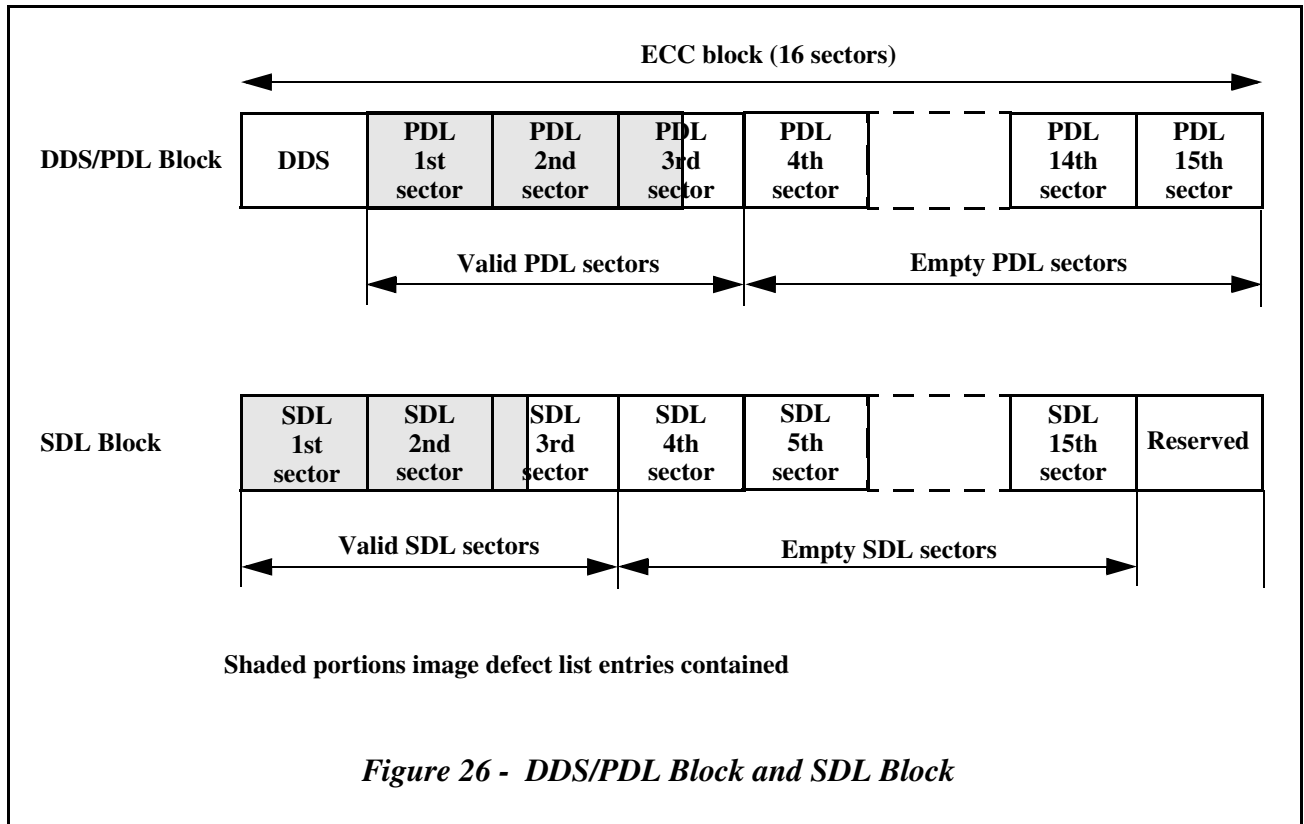


Table 46 - DDS information (Ver. 2.2)

Bit Byte	7	6	5	4	3	2	1	0
0 - 1	DDS Identifier (0A0Ah)							
2	Reserved							
3	Disc Certification Flag							
4 - 7	DDS/PDL Update Counter							
8 - 9	Number of Groups (0001H)							
10 - 11	Number of zones							
12 - 79	Reserved							
80 - 87	Location of Primary spare area							
88 - 91	Location of LSN0							
92 - 255	Reserved							
256 - 259	Start LSN for Zone0							
260 - 263	Start LSN for Zone1							
:	:							
308 - 311	Start LSN for Zone13							
312 - 315	Start LSN for Zone14 (Reserved in the case of for 80 mm)							
:	:							
392 - 395	Start LSN for Zone34 (Reserved in the case of for 80 mm)							
396 - 2 047	Reserved							

Table 47 - Disc Certification Flag format (Ver. 2.2)

Bit							
7	6	5	4	3	2	1	0
Formatting in-progress	Reserved					The whole disc has been certified by user	The disc has been certified by disc manufacturer

The size of the defect lists will be limited by several factors. As the information about all defects in the PDL and the SDL *shall* be used to access LBAs, the defect lists would normally be kept in the logical unit's memory. So that this does not become a problem for some logical units, the total size will have a maximum. The total defect list (memory) size *shall not* exceed 32 Kbytes (60 Kbytes in the case of 120 mm, 46 Kbytes in the case of 80 mm, in Ver. 2.2). As there are two defect lists, the size of each will be considered. Each list will always contain data from a whole number of sectors. For example, if a single PDL entry is used, the memory size will be 2 048 bytes, not 4 only.

($1 \leq S_{PDL} \leq 15$, $1 \leq S_{SDL} \leq 15$), in the cases of 120 mm discs

($1 \leq S_{PDL} \leq 8$, $1 \leq S_{SDL} \leq 15$), in the cases of 80 mm discs

$$S_{PDL} = INT \left[\frac{(E_{PDL} \times 4 + 4) + 2\,047}{2\,048} \right]$$

$$S_{SDL} = INT \left[\frac{(E_{SDL} \times 8 + 24) + 2\,047}{2\,048} \right]$$

S_{PDL} is the number of sectors used to hold PDL entries

S_{SDL} is the number of sectors used to hold SDL entries

E_{PDL} is the number of PDL entries

E_{SDL} is the number of SDL entries

Figure 27 - Limitation of maximum number of sectors for PDL and SDL

4.16.9 Scheduling of Linear Replacement

The DVD-RAM format is designed to enable the following Linear Replacement methods, with some consideration for issues of real-time data recording, where for example the reassignments are disabled during some operations.

- When recording data with verification by the WRITE AND VERIFY (10) command, the logical unit has an opportunity to evaluate the written data and if the data is found defective, the logical unit may perform a Linear Replacement.
- For data recorded without verification, the logical unit has an opportunity to evaluate the written data when the host attempts to read the data from that LBA and if the data is found defective but correctable by ECC, the logical unit may perform the Linear Replacement operation, if read reassignment is enabled.

4.16.10 Formatting

Formatting is required at the beginning of use of DVD-RAM media. During formatting, the logical unit defines correspondence between LBAs and physical addresses and records relevant information in the Defect Management Areas. All the user data in the formatted extent is lost during the formatting. Media certification may be included as a part of the formatting. No defect list *shall* be transferred from the host, i.e. there *shall* be no D-list for DVD-RAM media.

The certification process included in the formatting should not be confused with media certification from a media manufacturer. The logical unit controlled “certification” allows the logical unit to write and verify all the sectors on the media. This operation allows some defects to be registered in the G₁-list for the Slipping Replacement. These are not the same as certification defects from the media manufacture which is recorded in the P-list. The result of the “certification” process of the FORMAT UNIT command is to leave every sector with a special ID content called the “Initialization pattern.” This type of ECC block *shall* be treated as though all zero data has been written. This is the same as an unwritten ECC block.

There is a case where the spare sectors available are exhausted:

- During a re-formatting, when SDL entries are converted to G₂-list entries.

When these happen, the logical unit *shall* place the overflow sectors into the SDL and replace these sectors with spare sectors from another zone. During re-formatting, SDL entries that cannot be converted to PDL entries will be kept in the SDL, but the replacement location may change. During a formatting with certification, when new PDL entries are added that cannot be used because there are not enough spare sectors in that zone, a new SDL entry *shall* be created. In both cases, the SDL may not be empty after the FORMAT UNIT command completes.

If the total number of spare sectors are exhausted during a FORMAT UNIT command, the format operation will not stop, but will ignore those defects that cannot be replaced and a RECOVERED ERROR *shall* be reported at the completion.

If the size of the PDL & SDL are going to exceed the limit in Figure 27, the logical unit *shall* discard defect entries until the size does not exceed that limit.

There can be considered four kinds of formatting depending on how the certification performed and how the old defect list (G₁-list and G₂-list) is treated:

4.16.10.1 Formatting Type 1 - Slow Initialization

The purpose of Formatting Type 1 is to initialize the medium using the media manufacturer’s defect list (P-list), assuming that the media has defects not in the P-list. The logical unit performs its own certification. The execution time is long, at least one hour or more. Every physical sector should be written with initialization pattern and verified.

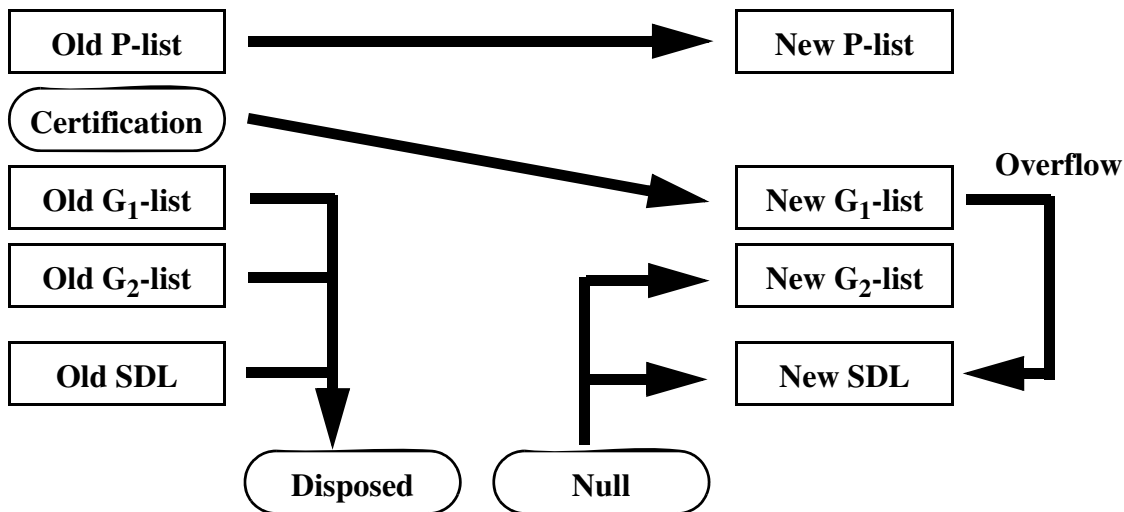


Figure 28 - Formatting Type 1 - Slow Initialization

4.16.10.2 Formatting Type 2 - Quick Improvement

The purpose of Formatting Type 2 is to remove reassigned sectors for Linear Replacement and change them to Slipping Replacement. The total number of Spare sectors available remains the same. The execution time is very little, only several seconds is expected.

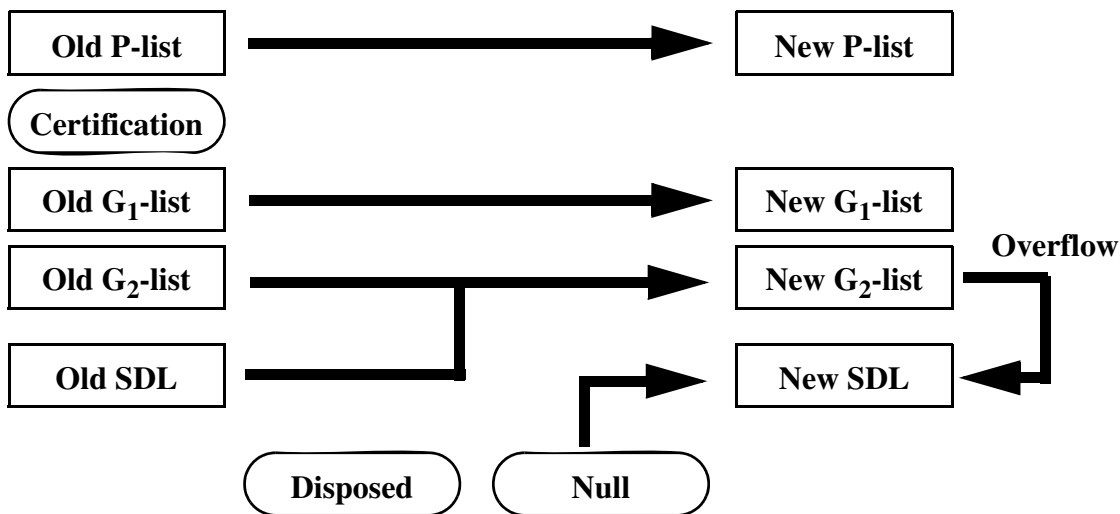


Figure 29 - Formatting Type 2 - Quick Improvement

4.16.10.3 Formatting Type 4 - Quick Clearing

The purpose of Formatting Type 4 is to initialize the media for use, using only media manufacturer defect information. Another purpose is to return the media to the latest certified state by removing reassigned sectors for Linear Replacement and the G₂-list. The execution time is very little; only several seconds is expected.

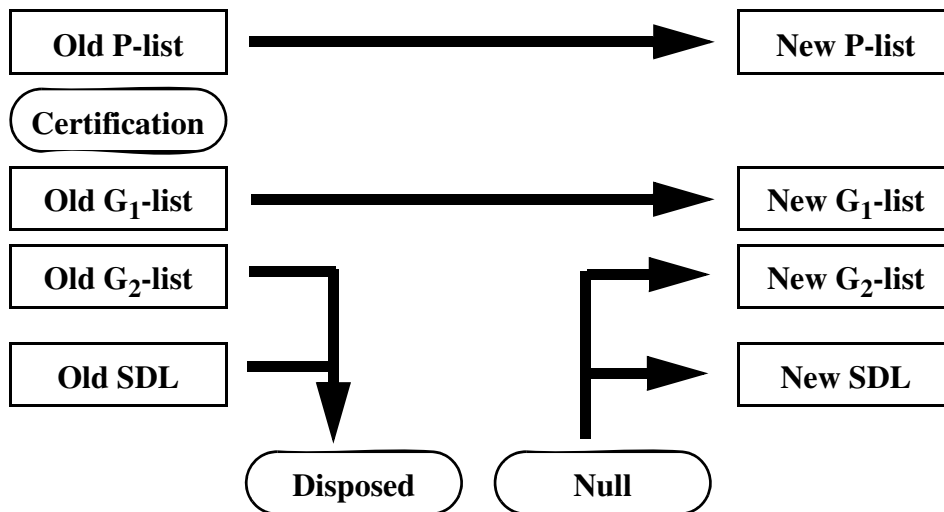


Figure 30 - Formatting Type 4 - Quick Clearing

4.16.11 Interruption of formatting

An interruption of formatting by reset, or power off may cause the media to be unusable without another formatting operation. In any case, all the user data in the formatting extent shall be assumed to be lost, because correspondence between the LBAs and physical addresses may have been changed.

- An interruption of formatting Type 1 may cause the media to be unusable because of uncompleted change of the ECC boundaries. Any access to the media in this condition other than a proper FORMAT UNIT command shall be terminated with CHECK CONDITION status, 3/31/00 MEDIUM FORMAT CORRUPTED. The only recovery operation to this case is another formatting by formatting Type 1 only.
- An interruption of formatting Type 2 causes the media to be usable as there is no media certify operation.
- An interruption of formatting Type 4 causes the media to be usable as there is no certification operation.

4.16.12 Cartridge and Disc Type

There are three types of cartridges, Type 1, Type 2 and Type 3. See Table 48. Each cartridge has a sensor hole that indicates whether a media has taken out at least once or not, and has a write-inhibit hole for the usable side. A disc may be used without a cartridge.

Table 48 - Feature of cartridge

	Type 1 cartridge	Type 2 cartridge ^a	Type 3 cartridge ^a
Reversibility	Reversible	Non-reversible	Non-reversible
Removability of a disc from the cartridge	Impossible	Possible	Possible
Original condition of a sensor hole A1	Closed	Closed	Open

a. The difference between Type 2 and Type 3 is the condition of the sensor hole A1. The sensor hole A1 of Type 2 is originally closed. The sensor hole A1 of Type 3 is always open. See Section 4.16.13.4.

4.16.13 Write protection of a disc

There are two types of write protection conditions, one is the condition set directly by users and the other is the condition for the other reasons such as a vender specific implementation.

There are three factors affecting the write protection conditions for DVD-RAM media. They are Write-inhibit hole, disc type identification and Write-inhibit flag. The explanation of each factor and the possible status of the command execution are described below.

4.16.13.1 Write-inhibit hole

This hole is the mechanical switch/tab for write protection on a cartridge. When this hole is closed, the logical unit may write/modify information according to the other write protection conditions. When this hole on a cartridge is open, the logical unit **shall not** write/modify/initialize any information (including user data, defect management information and Write-inhibit flag) on the disc.

Host is able to get the Write-inhibit hole condition as a CWP bit value using READ DISC STRUCTURE command with Format Code code C0h or 09h.

4.16.13.2 Write-inhibit flag

The Write-inhibit flag can be used for a write protection function for a disc without a cartridge. When the disc is initialized logical unit **shall** set the flag to zero. Supporting the functionality to change this flag is optional. This flag is recorded on the disc surface. When this flag is set to zero, the logical unit may write/modify information according to the other write protection conditions. When this flag on a disc is set to one, the logical unit **shall not** write/modify/initialize any information (including user data and defect management information) on the disc surface. The flag itself is not write protected.

Host is able to get the Write-inhibit flag condition as a PWP^a bit value using READ DISC STRUCTURE command with Format Code code C0h or 09h, and set/reset PWP bit using SEND DISC STRUCTURE command with Format Code code C0h.

4.16.13.3 Disc Type Identification

Disc Type Identification is defined in the embossed Lead-in Area. Disc Type Identification indicates whether the disc can be written without cartridge or not.

When this field of a disc is set to 00h, the logical unit **shall not** write/modify any information (including user data, defect management information and Write-inhibit flag) onto the disc mounted without cartridge. In this case, MSWI bit **shall** be set to one. See 12.3, "Error reporting" on page 498.

When this field is set to 10h and the disc is not in the cartridge, some logical units become the write disabled condition. In this case, MSWI bit **shall** be set to one. See 12.3, "Error reporting" on page 498. On the other hand, some logical units become the write enabled condition. A logical unit may reject certain write operations without verification because verify after write is recommended. In this case, the command **shall** be terminated with CHECK CONDITION status, 7/27/06 CONDITIONAL WRITE PROTECT.

Host is able to get the Disc Type Identification value by using READ DISC STRUCTURE command with Format Code code 09h.

4.16.13.4 Sensor hole A1

The Sensor hole A1 indicates whether the disc had been taken out from a cartridge or not. The Sensor hole A1 is closed when the disc had never been taken out from the cartridge. The Sensor hole A1 is open when once the disc had been taken out from the cartridge. In the case of the Sensor hole A1 open, verify after write is recommended. A logical unit may reject certain write operations without verification. In this case, the command **shall** be terminated with CHECK CONDITION status, 7/27/06 CONDITIONAL WRITE PROTECT. These differences depend on the drive implementation for keeping data integrity.

Note: WRITE (12) command with Streaming bit set to one may not be affected by the Sensor hole A1 status. If logical unit does not permit execution of the command when Sensor hole A1 is open, the command is terminated with CHECK CONDITION status, 7/27/06 CONDITIONAL WRITE PROTECT.

Host is able to get the sensor hole A1 condition as a Out bit value using READ DISC STRUCTURE command with Format Code code 09h.

4.17 Recording for DVD-R Single Layer media

4.17.1 Basics for DVD-R vs. CD-R

Generally the contents on a DVD disc are managed using the OSTA Universal Disk Format (UDF) file system. (UDF Bridge may also be used.) A DVD-ROM disc is similar to a CD-ROM disc in that it has one Mode 1 data track with Lead-in and Lead-out. A DVD disc does not have pre-gap or post-gap.

DVD-R is similar to CD-R. It is a write-once media that in most cases will be readable by a DVD read-only logical unit. There are some capabilities that are defined by this specification and could cause some media to not be readable by legacy DVD read-only logical units. DVD-R provides data appendability using incremental sequential writing.

One major difference between DVD-R and CD-R is the Track. DVD-R does not have an Audio Track and Sub-channel data, thus there is no Table of Contents like on CD. Data written on a DVD-R disc looks like a Mode 1 data track on a CD-R disc. For DVD-R, three appendable points are provided. To control (manage) data appendable points in a data recordable area, the concept of an RZone has been introduced. An RZone contains data elements of Next Writable Address, Last Recorded Address, Start Address and Length, which is similar to a CD Track.

Both DVD-R and CD-R use a Link sector to stop and resume recording. Because of differences between the cross-interleaved ECC of CD and the 32K ECC blocks of DVD, the linking scheme is a little different. CD-R uses Run-out, Link, and Run-in sectors. DVD-R uses Linking Loss Area, padding and Block SYNC Guard Area (BSGA)¹. These Linking Loss sectors use Logical Block Address (LBA) space.

DVD-R has a Recording Management Area (RMA) to store Recording Management Data (RMD) including the RZone information, Disc Status and other helpful information for file system management. RMA is located out of the user Data Area. RMD block size is 32 KB.

4.17.2 Recording model for DVD-R Single Layer media

DVD-R Single Layer media supports two types of recording; disc-at-once (un-interrupted) and incremental. In case of incremental recording, when recording is interrupted, linking *shall* be used.

The **Write Type** field in the Write Parameters mode page is used to specify if disc-at-once recording or incremental recording will be used.

4.17.2.1 Sequential recording

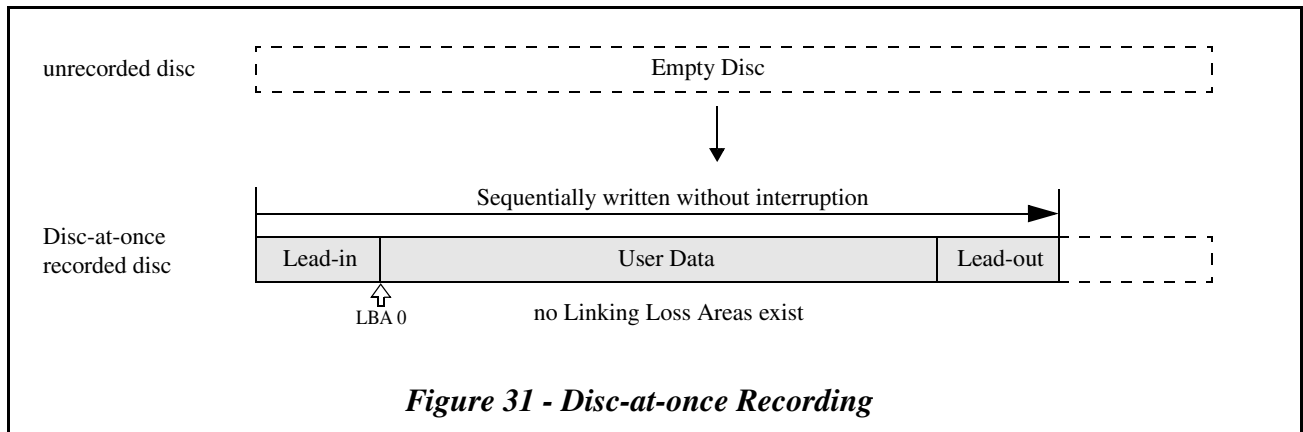
DVD-R media makes use of sequential recording. This type of recording does not permit random access for recording purposes. Recording may only occur at predefined recording (appendable) points.

Multiple Appendable points may exist within management areas for sequential recording. The data *shall* be written sequentially from each appendable point. Each start/stop of recording occurs in a special structure called a Linking Loss Area.

1. Block SYNC Guard Area (BSGA) was called "Block Sync Guarantee Linking Loss (BSGLL)" in the old revisions of this specification.

4.17.3 Disc-at-once recording

Disc-at-once recording is recording data including Lead-in and Lead-out sequentially written to the media without interruption. There are no Linking Loss Areas in the recorded data from Lead-in through the end of Lead-out. Disc-at-once recording is used to create fully compatible media which behaves like DVD-VIDEO/ROM media.



For disc-at-once recording, the Information Area *shall* be recorded more than 70 mm in diameter. If the recorded length is less than 70 mm in diameter, the logical unit *shall* write Lead-out up to 70 mm in diameter. See the DVD-ROM Book Part 1.

Sample sequence of disc-at-once recording:

1. Set the Write Type field in the Write Parameters mode page to “disc-at-once.”
2. Specify transfer user data size by using the RESERVE TRACK command.
3. Issue WRITE (10) command from logical sector number 0.
The logical unit *shall* perform Optimum Power Calibration (OPC).
Write and verify RMD in RMA.
The logical unit starts writing from the Lead-in through Data Recordable Area.
4. Repeat WRITE (10) command for all data.

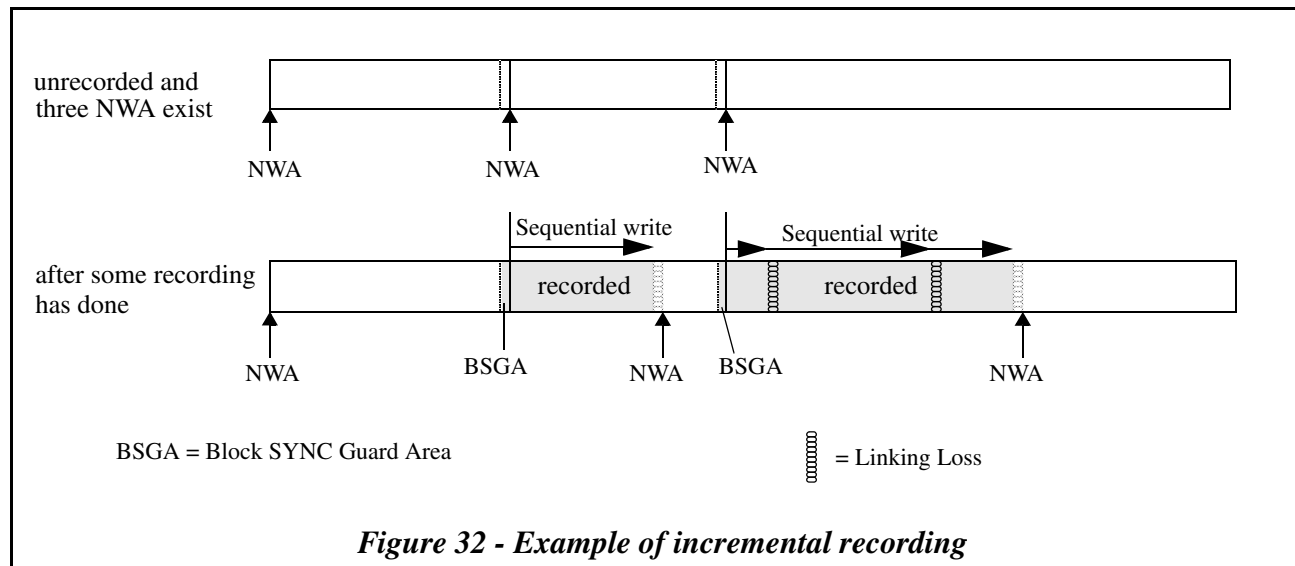
When all user data has been written on the medium, the logical unit starts writing Lead-out.

If a buffer under-run occurs, the logical unit *shall* stop writing immediately and the logical unit *shall* start writing of Lead-out.

4.17.4 Incremental recording

In the case of incremental recording, user data is written sequentially from each NWA. A variable amount of user data is written at several distinct times. Each recording begins and ends with a link. Linking Loss and Block SYNC Guard Areas do not contain user data and are used during recording to allow discontinuous recording of data.

For DVD-R media to be readable by DVD read-only logical units, the media *shall* contain a Lead-in and a Lead-out or Border-out. The Border-out is similar to the Lead-out. For more information, see DVD-R Book Part 1.

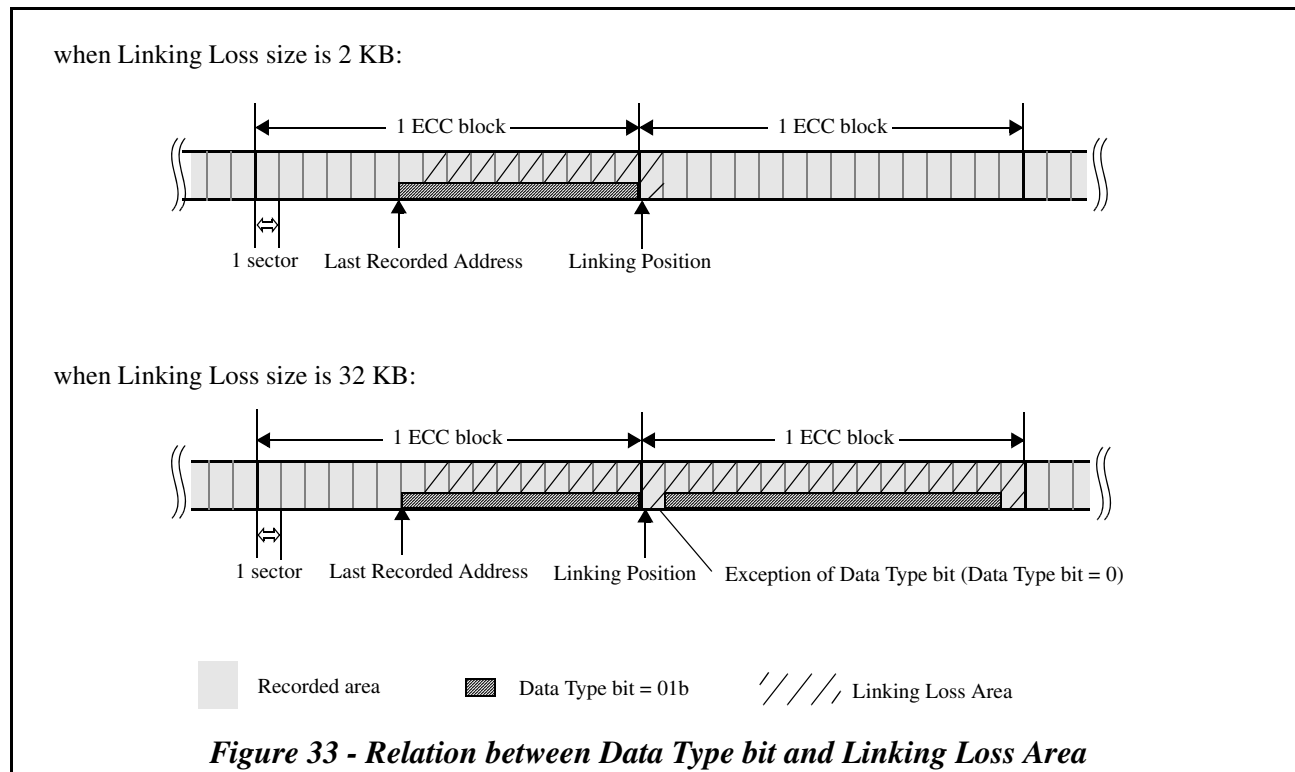


4.17.4.1 Linking and Data Type bit

When recording is interrupted, e.g., due to SYNCHRONIZE CACHE (10) occurring, the logical unit *shall* perform linking. Currently, two Linking Loss Area sizes are defined: 2 KB and 32 KB. The Link Size field in the Write Parameters mode page is used to specify Linking Loss Area size. Mixing the two Linking Loss Area sizes on the same disc is allowed.

LBAs are assigned to Linking Loss Area sectors. Addressing similar to "Method 2" for CD media is not provided for DVD-R media.

The Data Type bit of the Identification Data (first 4 bytes of physical sector) when set to 0, indicates that the next sector is a normal data sector. When the Data Type bit is set to 1, indicates that the next sector belongs to a Linking Loss Area. If the sector contains a linking position, the Data Type bit of the sector *shall* be set to 0, even if the next sector will be a Linking Loss sector. This exception is due to the possibility of changing the link size. If a sector is part of a Linking Loss Area and the Link Flag in the previous sector is readable, no ECC related error *shall* be returned to the host in response to any command that would require the logical unit read that sector. This would include commands such as READ (10), VERIFY (10), REPORT KEY, and WRITE AND VERIFY (10).



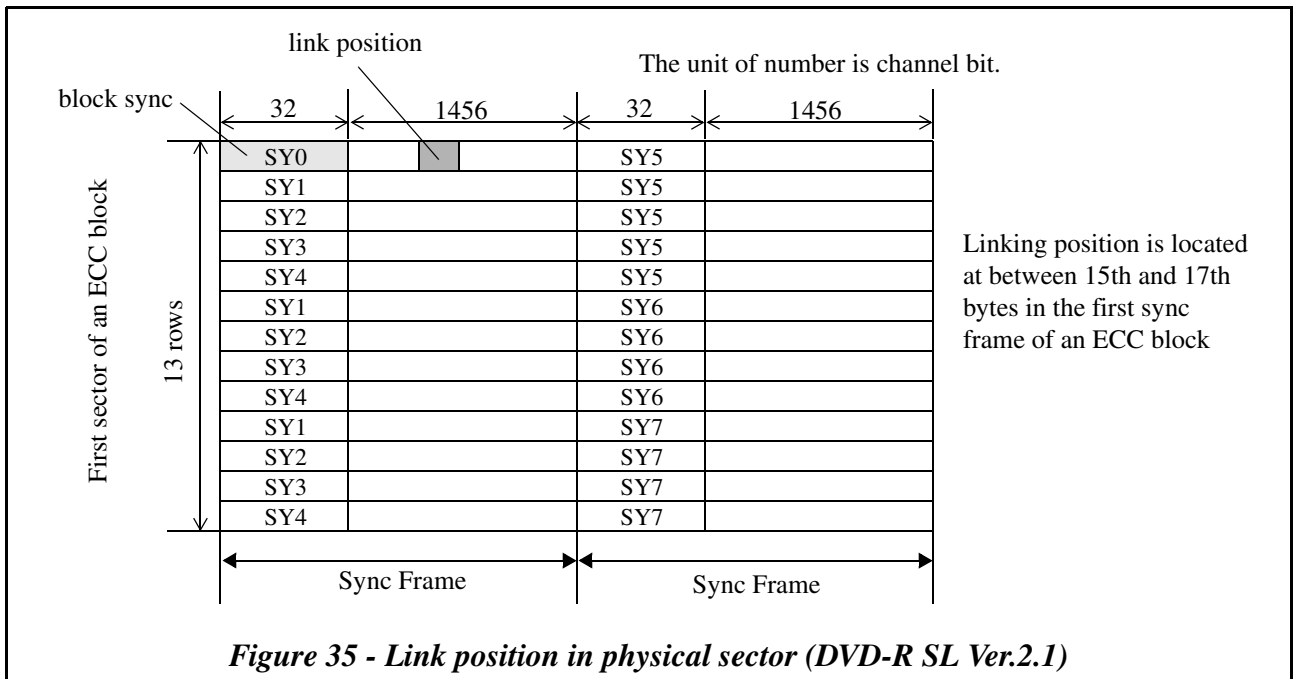
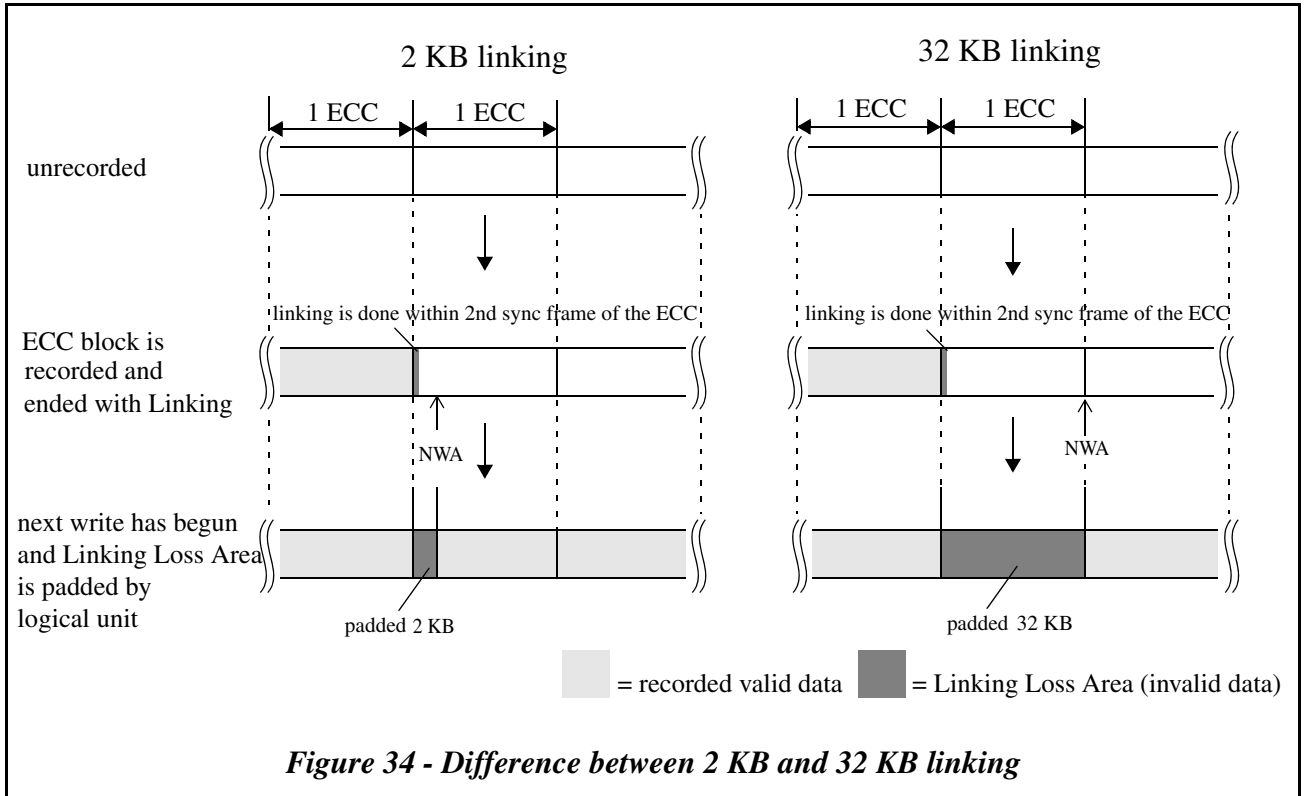
4.17.4.2 Linking with 2 KB or 32 KB Linking Loss

If the Linking Loss Area size is set to 32 KB, all of the sectors within a linking ECC block are used as Linking Loss Area. Those ECC blocks can be ignored and no error correction need be provided by the logical unit. A drawback however, is that 16 sectors are exhausted by each link operation.

If the Linking Loss Area size is set to 2 KB, the first sector of the linking ECC block is used as Linking Loss Area. The remaining 15 sectors of the ECC block are available for valid user data. As the Parity Bytes used for error correction do not include the correct data from the Link point, the error correction capability may be degraded. If the logical unit uses Erasure Correction techniques and the data contained in the Link Sector has been written with zeros, then the degradation of the error correction capability will be very small.

Table 49 - 2 KB linking vs. 32 KB linking

2 KB linking	32 KB linking
less overhead (padding is done up to 2 KB)	more overhead (padding is done up to 32 KB)
ECC may be degraded	ECC not affected



4.17.4.3 *Sample sequence of incremental recording:*

1. Set the Write Type field in the Write Parameters mode page to “incremental”.
2. Set the Link Size field in the Write Parameters mode page to 1 (2 KB) or 16 (32 KB).
3. If necessary, reserve RZone by using RESERVE TRACK command.
4. Inquire NWA of the specified RZone by using READ TRACK INFORMATION command.
5. Issue WRITE (10) command from NWA.
The logical unit may perform OPC.
If an RZone was newly reserved, the logical unit *shall* store the RZone information in the RMA prior to writing.
The logical unit starts writing from NWA.
6. Repeat WRITE (10) command for all data to be transferred.
7. Optionally issue SYNCHRONIZE CACHE (10) command.

When all the user data is written on the medium, the logical unit *shall* perform linking.

Once Write Type is selected and a write operation has begun, Write Type is not changeable. If Write Type does not match the disc status, the command *shall* be terminated with CHECK CONDITION status, 5/26/00 INVALID FIELD IN PARAMETER LIST.

4.17.4.4 *Lossless-Link*

The linking that does not set Data Type bit in physical ID of a sector is referred to as Lossless-Link. Linking loss sectors are not generated when Lossless-Link is performed.

The Lossless-Link *shall not* be performed at the end of an RZone. The Lossless-Link is able to be performed only during writing. Each RZone *shall* be terminated with 2 KB or 32 KB linking.

4.17.4.5 *Buffer under-run free recording*

DVD-R logical unit may support buffer under-run free recording for sequential recording. The Buffer Under-run Free Enable (BUFE) bit in Write Parameters mode page is used to specify if buffer under-run free recording will be used during sequential recording. During a continuous writing, if BUFE bit is set to 1, the logical unit writes the data to the medium without link generation occurring. When the logical unit detects buffer under-run, the logical unit *shall* perform the Lossless-Link to guarantee the first PI line data of ECC block where under-run will occur. Logical unit restarts writing from the Lossless-Link point when following write data is sent by the host without any error. If the writing is forced by a SYNCHRONIZE CACHE (10) command, a link *shall* be generated. Commands that are listed in Table 369 - *Commands that shall not interrupt streaming writing* on page 582 *shall not* generate a link.

If BUFE bit is set to 0, when buffer becomes empty (under-run occurs), the logical unit *shall* perform normal linking with Linking Loss sectors. The following WRITE (10) command may be terminated with CHECK CONDITION status, 5/21/02 INVALID ADDRESS FOR WRITE.

4.17.5 *DVD-Video compatibility issues*

To record DVD-VIDEO format on DVD-R media, disc-at-once recording is compatible; compatibility is limited in incremental mode (each file *shall* be recorded as one “packet”). In the case of incremental recording, to record DVD-Video files correctly, the following limitations *shall* be taken into consideration.

All DVD Video Title Sets (VTS) are managed by the Video Manager (VMG). The VMG is recorded as files that are named VIDEO_TS.IFO, VIDEO_TS.VOB (optional), and VIDEO_TS.BUP. The order of the files is specified and it is not possible to change the order.

The VMG *shall* be placed before any VTS. The VMG contains the information of the VTS location as offset from VMG start logical sector. Once VMG is recorded, VTS that is not registered in the VMG, cannot be further appended.

Each file *shall* be recorded as a single extent. Therefore each file *shall* be recorded as one packet.

To guarantee the continuous playback of MPEG 2 data stream, VTS files *shall* be recorded contiguously and garbage sectors and Linking Loss sectors are not allowed between Video Object (VOB) files within a VTS. This is because the VOB files consist of a continuous video stream.

See *DVD-ROM Book Part 3* for further information on these limitations.

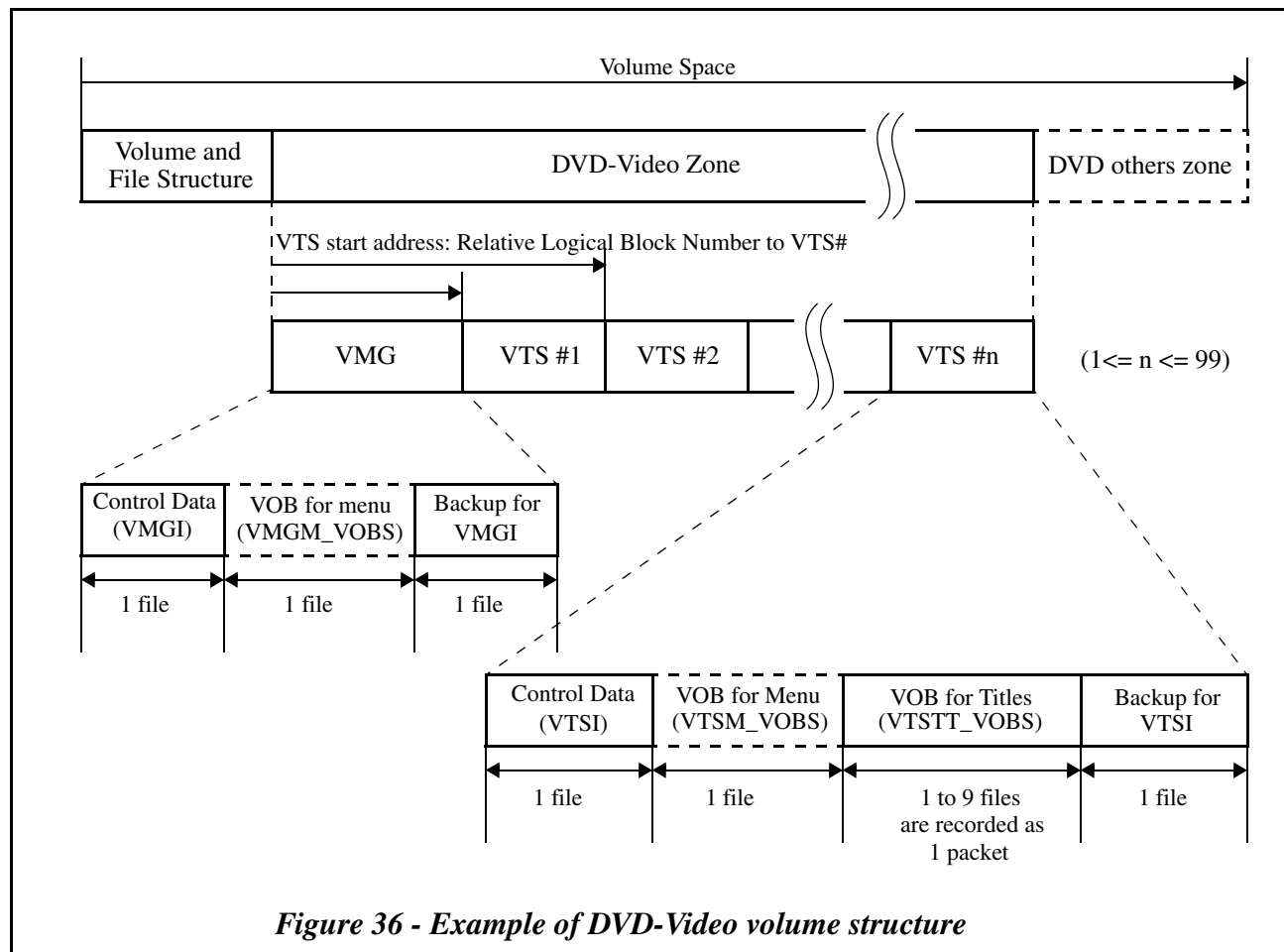
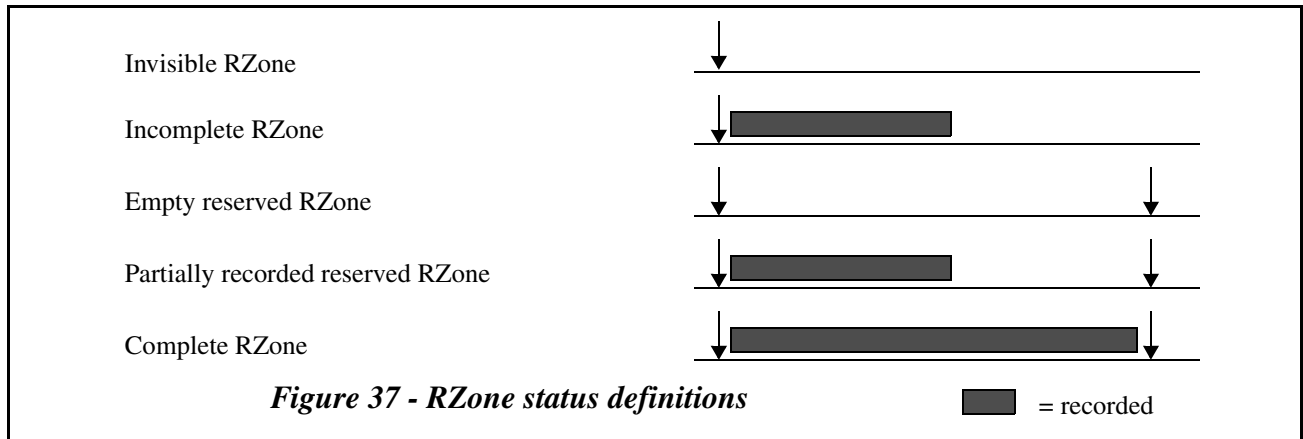


Figure 36 - Example of DVD-Video volume structure

4.17.6 RZone model

The RZone is defined for DVD-R to manage appendable points. The RZone status changes according to its recording stage. These status names are shown in Figure 37 below.



Invisible/Incomplete RZone: The RZone only has a start address. End address is not defined. This kind of RZone is always located on the outermost portion of the media and is data appendable.

Empty reserved RZone/Partially recorded reserved RZone: The RZone has a start address and end address. This kind of RZone is always data appendable.

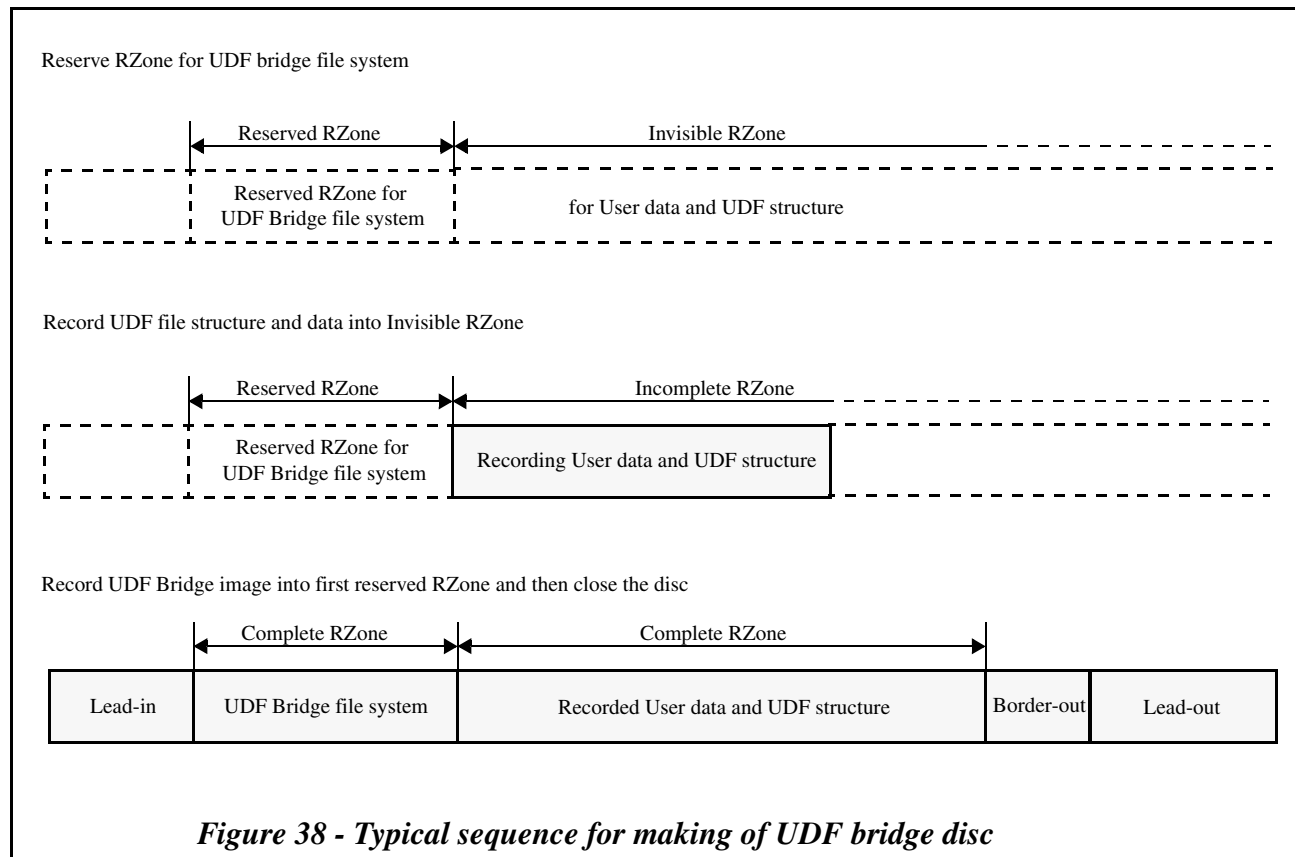
Complete RZone: The RZone is closed or completely filled with data. This kind of RZone has no NWA and can not append data.

4.17.7 RZone reservation

4.17.7.1 Limitation for number of reserved RZones

A part of the disc space can be reserved for an RZone. For DVD, the maximum number of RZones which can be reserved at the same time is two. In other words, the maximum number of data appendable RZones is three (2 Reserved RZone + 1 Invisible/Incomplete RZone). If two RZones are already reserved, no more RZones can be reserved. To reserve a new RZone, either one or both of the current reserved RZones *shall* be closed. Once closed, a new RZone can be reserved.

Figure 38 shows an example sequence for making of a UDF Bridge disc on DVD-R media. In the Figure, two RZones are used for recording. One RZone is reserved for UDF Bridge file system. User data is written by Sequential UDF in the Invisible/Incomplete RZone.



The RESERVE TRACK command is used to reserve RZones. If attempting to reserve an RZone when two RZones are already reserved, the command *shall* be terminated with CHECK CONDITION status, 5/72/05 NO MORE RZONE RESERVATIONS ARE ALLOWED.

Attempting to reserve an RZone when less than three ECC blocks remain in the RMA, the command *shall* be terminated with CHECK CONDITION status, 3/73/05 PROGRAM MEMORY AREA/RMA IS FULL. Three RMD blocks are required for each of reservation, RZone closure or Border closure.

The BSGA (See 4.17.7.3) at the end of each RZone is not writable by the host. If a command attempts to write data beyond reserved RZone length during writing in the RZone, the command *shall* be terminated with CHECK CONDITION status, 5/21/02 INVALID ADDRESS FOR WRITE.

4.17.7.2 RZone numbering

The RZone numbers *shall* start from 1. The number of the Invisible RZone is increased by one following a reservation. After the reservation is done, the RZone number given to the new reserved RZone is the RZone number of the old Invisible RZone that existed before the reservation.

4.17.7.3 Block SYNC Guard Area (BSGA)

To read an ECC block correctly, block SYNC (first SY0) of the ECC block needs to be recorded.

Regardless of Linking Loss area size, if writing occurs for an ECC block immediately following an unwritten ECC block, the block SYNC (first SY0) is not written due to linking (the linking position is in first or second sync frame). An ECC block *shall* be recorded to guarantee readability of the following ECC block(s). An ECC block which is recorded after a written ECC block is readable. The preceding ECC block is referred to as BSGA (Block SYNC Guard Area) and is always 32 KB in size. A BSGA is the same as a 32 KB Linking Loss Area. See Figure 39.

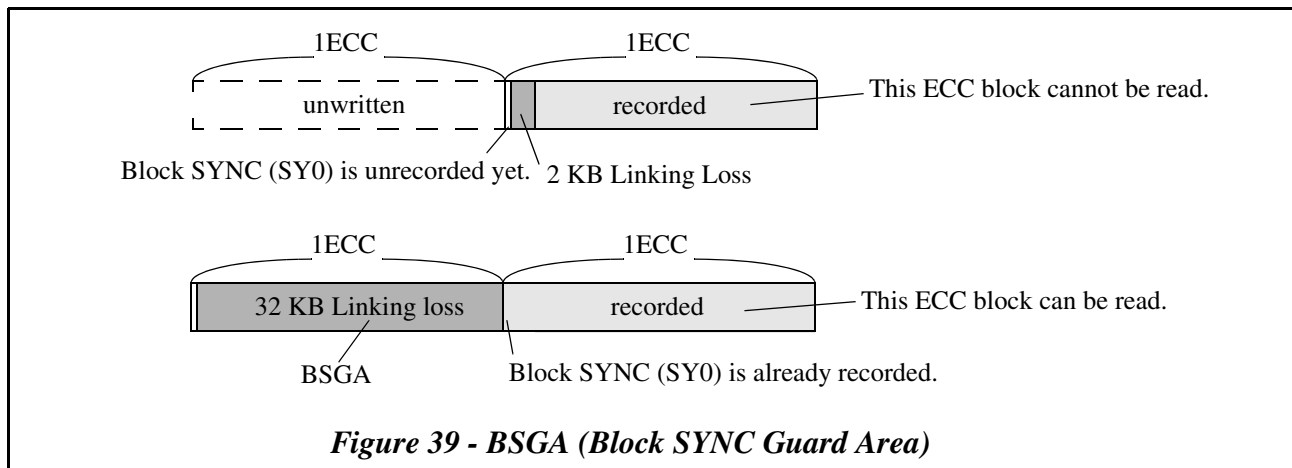


Figure 39 - BSGA (Block SYNC Guard Area)

4.17.7.4 RZone reservation scheme

There are two types of RZone reservation scheme. The one is Size Mode reservation and the other is Address Mode reservation. See Section 17.32, "RESERVE TRACK command" on page 839.

In the case of Size Mode reservation, the RZone *shall* only be reserved from the NWA of the Invisible RZone. If the last RZone is Incomplete RZone, the Incomplete RZone *shall* be closed prior to reserving a new RZone. The start address of the new Invisible RZone is the NWA of the previous Incomplete RZone.

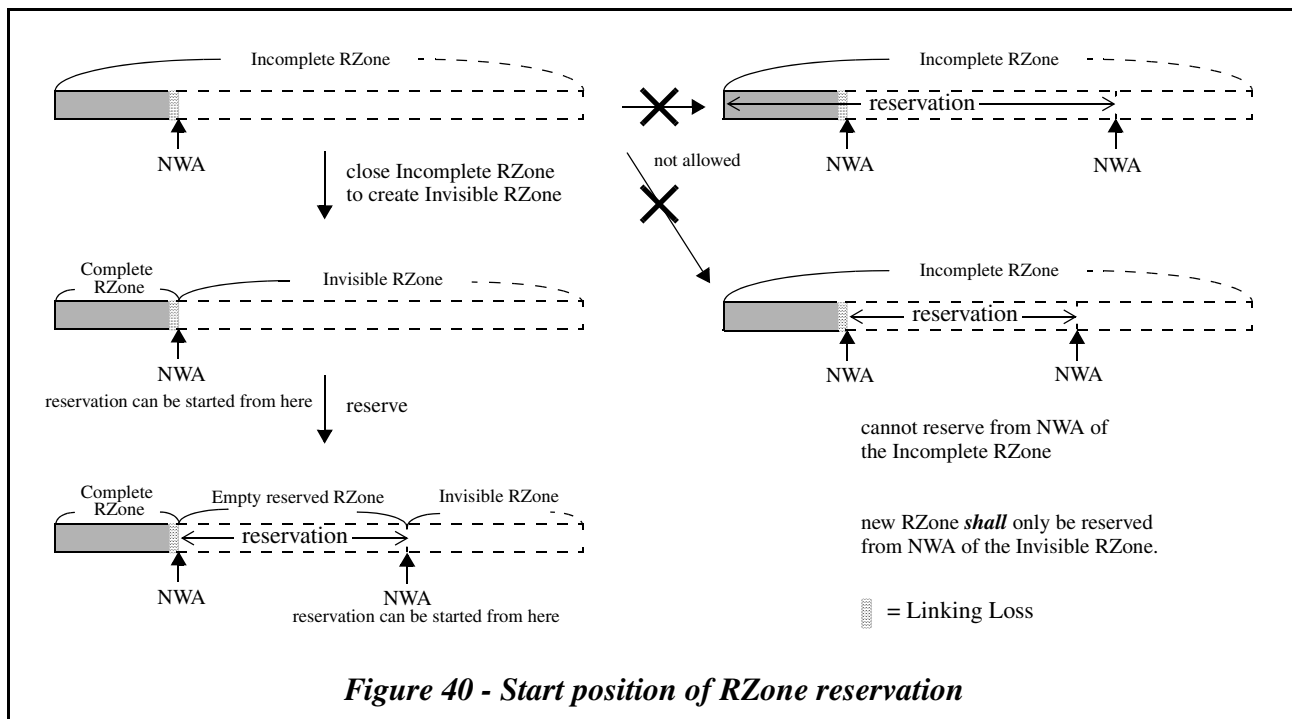


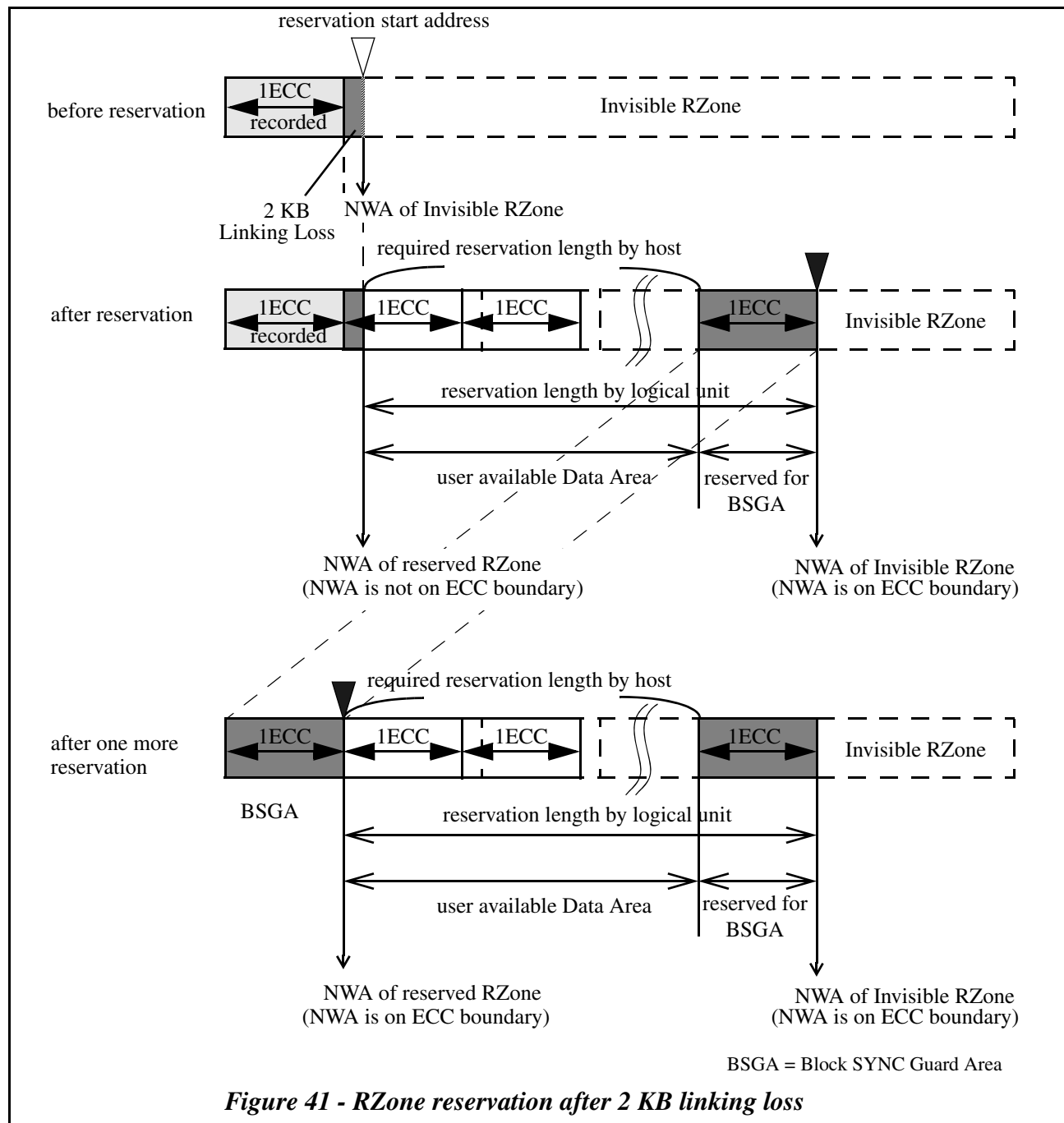
Figure 40 - Start position of RZone reservation

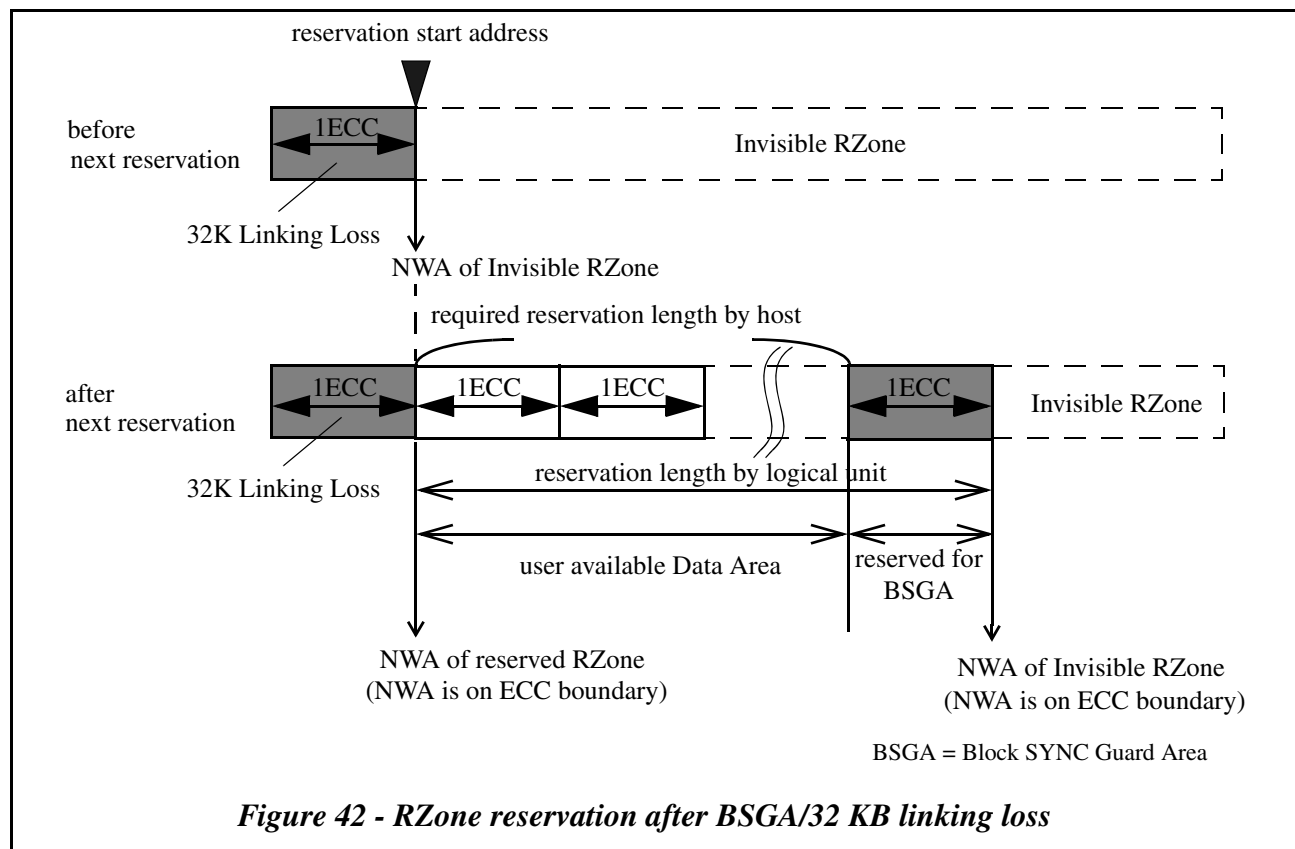
When reservation is required, the logical unit *shall* allocate appropriate length for the RZone in the Data Recordable Area.

In the case of Disc-at-Once recording, RZone reservation *shall* be done only once to specify user data length to be transferred from host to the logical unit. The allocated reserved length is the same as host required length to keep compatibility with DVD-ROM discs. There is no need to round up the length to ECC block unit and no BSGA *shall* be added to the reserved length. For disc-at-once recording, there is only one RZone and Border.

For incremental recording, allocated length *shall* take the Linking Loss Area size into consideration. The tail of a reserved RZone is round up to the ECC block unit and one ECC block length is added to the reserved RZone as a BSGA except when the reservation size is the same as the remaining disc capacity. If the reservation size is equal to the remaining disc capacity, the BSGA *shall not* be added to the reserved RZone size.

The start address of the RZone following reserved RZone is always on the ECC boundary because of the BSGA.





In the case of incremental recording and if Linking Loss Area size is set to 2 KB, available reserved RZone size may or may not be multiple of 32 KB. The available reserved RZone size is depend on its start address. When reserved RZone start address is on an ECC boundary, the available size is $32 \times N$ (KB). For example, the BSGA of the immediately preceding reserved RZone exists or the RZone starts from the next sector of Lead-in/Border-in. Otherwise, the available data size is $30 + 32 \times N$ (KB). If Linking Loss Area size is set to 32 KB, available reserved RZone size is always $32 \times N$ (KB).

The number of free blocks of the RZone may be different between 2 KB Linking Loss size and 32 KB Linking Loss size. For example, when Linking Loss size is set to 2 KB and last ECC block of the reserved RZone is unwritten, remaining free block size that reported by READ TRACK INFORMATION command is 15 blocks. However, if Linking Loss size is changed to 32 KB, remaining free blocks that reported by READ TRACK INFORMATION command becomes 0 even if there are unrecorded 15 blocks. Such kind of RZone is still Partially recorded reserved RZone and **shall not** be considered as a Complete RZone. To distinguish this kind of RZone, RT bit of the READ TRACK INFORMATION command is used. The RT bit of one indicates that the RZone is Empty reserved or Partially recorded reserved status. The RT bit of zero indicates that the RZone is Complete, Invisible, or Incomplete status.

4.17.7.5 Sample sequence for RZone reservation

An example of RZone reservation sequence is shown in Figure 43. Initially, a blank medium has only Invisible RZone. NWA is LBA 0 (reference A). When a write operation has begun without reservation, the NWA is proportionally incremented by written data length (reference B).

If reservation is required, the Incomplete RZone **shall** be closed. Then a new Invisible RZone is created. The new reserved RZone is allocated from the NWA of the Invisible RZone with required length (reference C).

Sequential writing can be started from each NWA of the RZone (reference D).

When two reserved RZones already exist, no more can be reserved (reference E and F). For reservation of a new RZone, a close RZone operation is required to close one or both of the reserved RZones (reference G). When Close RZone is done, the RZone is complete.

Note: The Linking Loss area except for BSGA is omitted in Figure 43.

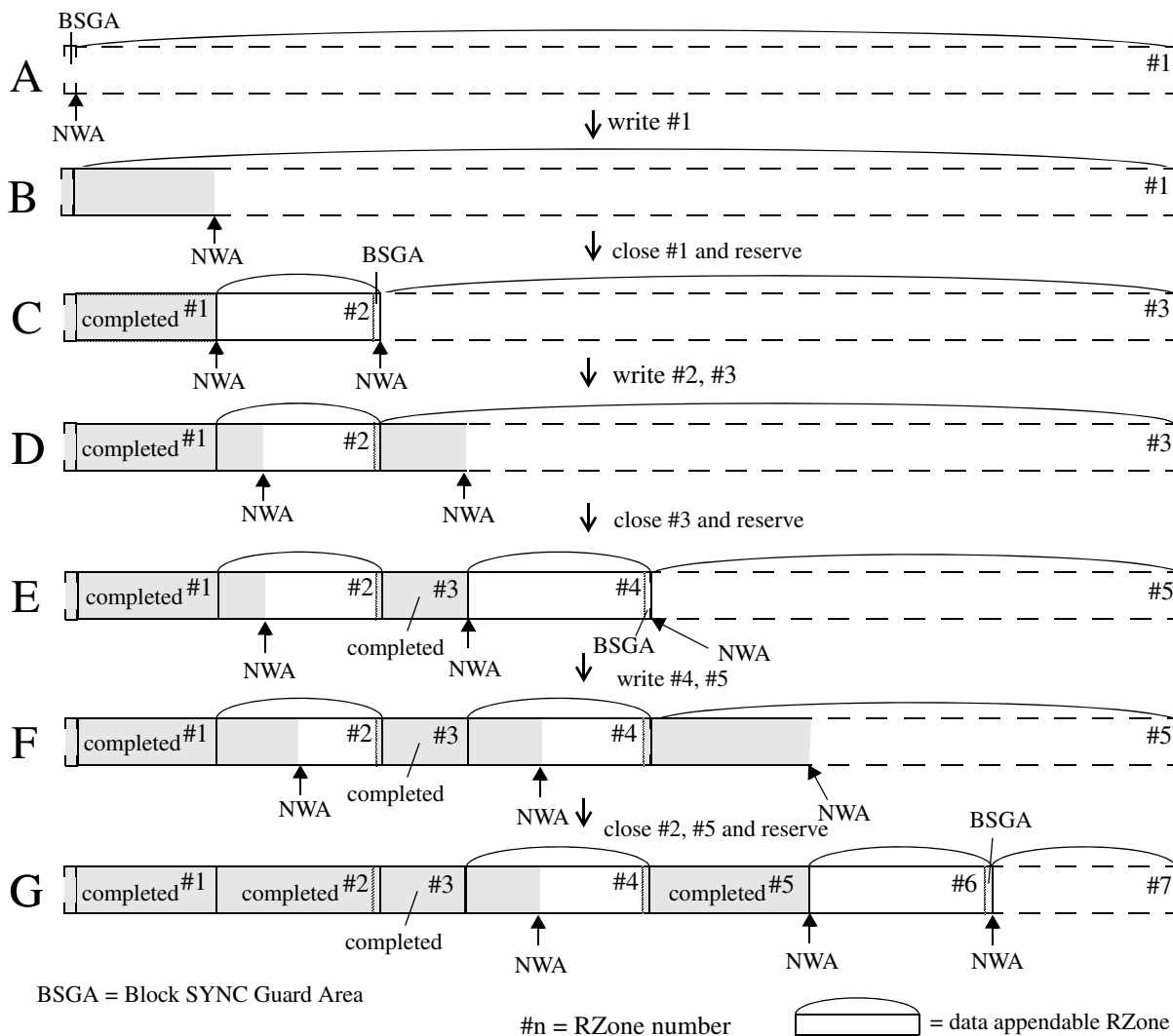


Figure 43 - Example of RZone reservation sequence

4.17.8 RZone closing

This section explains what *shall* be done by a logical unit when an RZone is closed.

When a Reserved RZone is closed:

1. Logical unit *shall* write RMD in RMA.
2. Then the logical unit *shall* pad 00h data until the end of the Reserved RZone with Data Type bit = 0.

When an Incomplete RZone is closed:

1. Logical unit *shall* write RMD in RMA.
2. A new Invisible RZone which has RZone number N+1 is created from the NWA of the closed Incomplete RZone which has RZone number N.

There are three purposes of closing an Incomplete RZone:

1. To reserve a new RZone
2. To close Border
3. To make the logical unit write an RMD in RMA for backup against error.

When an Invisible RZone is closed, nothing is done by the logical unit.

4.17.9 Optimum Power Calibration (OPC)

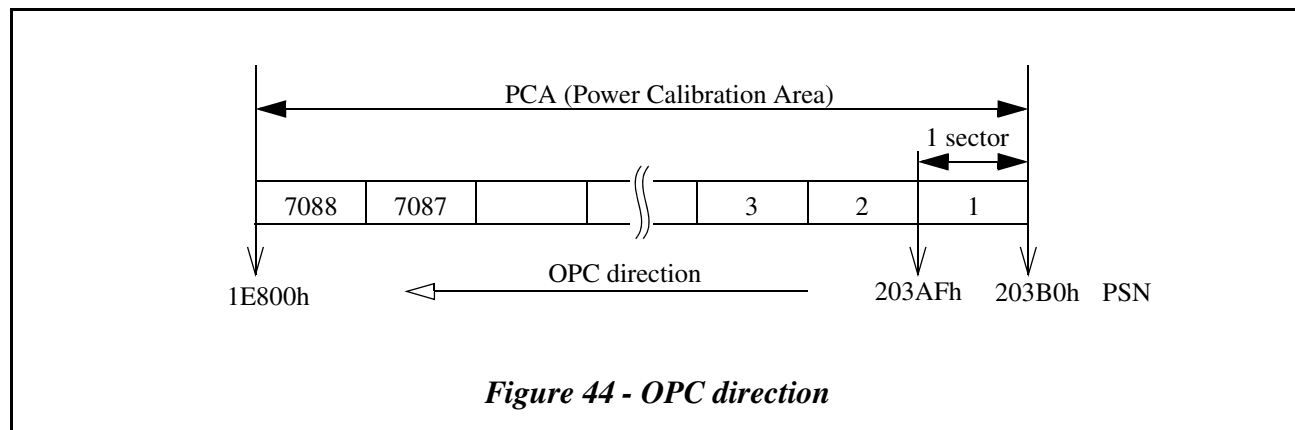
Optimum power calibration (OPC) is required to determine the optimum recording laser power for the mounted DVD-R media. If necessary, OPC operation may be performed automatically when the medium has been first inserted into the logical unit and the first WRITE (10) command is issued. When OPC operation is done, RMA may be updated by the logical unit.

An OPC *shall* be performed against current writing speed only.

The PCA (Power Calibration Area) is located from Physical Sector Numbers (PSN) 1E800h to 203AFh. For each OPC, one recording sector (26 sync frames) is assigned. The OPC start address is in descending order within the PCA. As an example, the first power calibration is in PSN 203AFh and the second power calibration is in PSN 203AEh. See Figure 44. Typically, power calibration can be done 7,088 times for each medium. However, actual OPC times and timing are logical unit dependent.

On DVD-R SL media, 256 sectors in the outer PCA is reserved for disc manufacturers use. Therefore a logical unit starts OPC from PSN 202AFh for DVD-R SL media.

If a host requires OPC at desired timing, the SEND OPC INFORMATION command is used.



4.17.10 Required actions during write operation

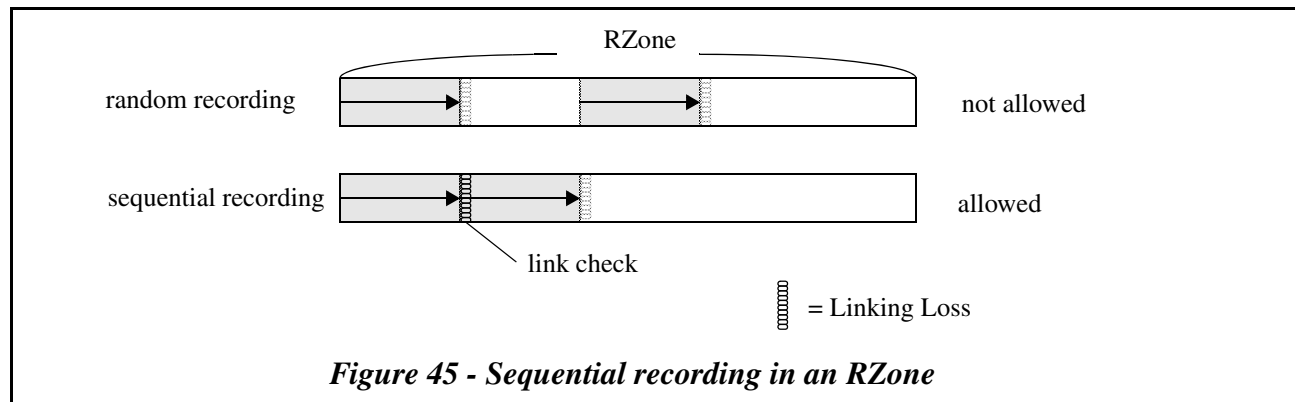
4.17.10.1 Linking check9 for sequential recording

Random writing within an RZone is not allowed (Sequential recording *shall* be used for DVD-R).

It is required that writing is always started from NWA of the RZone.

The logical unit *shall* check Linking Loss to recognize the LRA and NWA.

When a WRITE (10) command is attempting to write to other than the NWA, the command *shall* be terminated with CHECK CONDITION status, 5/21/02 INVALID ADDRESS FOR WRITE.



4.17.10.2 ECC boundary padding and Data Type bit in ID field

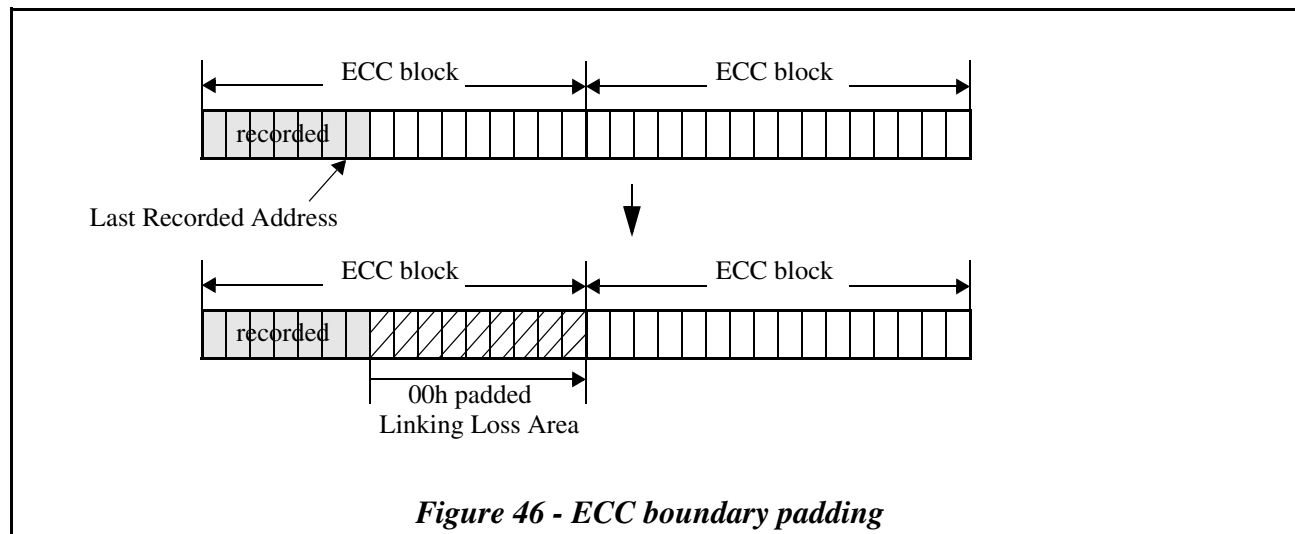
The logical unit writes data to the medium only when multiple ECC data blocks are received or the SYNCHRONIZE CACHE (10) command is issued. When the SYNCHRONIZE CACHE (10) operation has been done and the last recorded data address is not an address of the last sector of an ECC block, the logical unit *shall* pad to the ECC block boundary with value 00h. This padded area is also called a Linking Loss Area. See Figure 46.

The Last Recorded Address is the address of the last block of user data. The ECC padding *shall not* affect the Last Recorded Address.

Note: The READ TRACK INFORMATION command is used to get the Last Recorded Address of the RZone.

A SYNCHRONIZE CACHE (10) command may be used to mark the end of the Write data stream.

In the case of buffer under-run, if the WRITE (10) command is completed without error, the data which is less than one ECC block *shall* be padded with 00h and the logical unit *shall* make a Linking Loss Area. (If the data length to be transferred becomes less than a sector boundary, the host *shall* pad to the sector boundary with value 00h.)



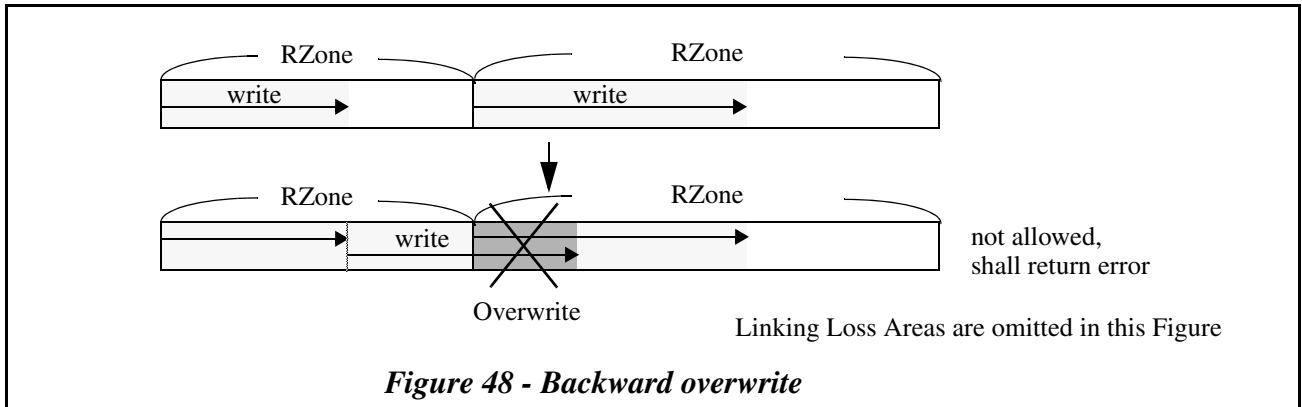
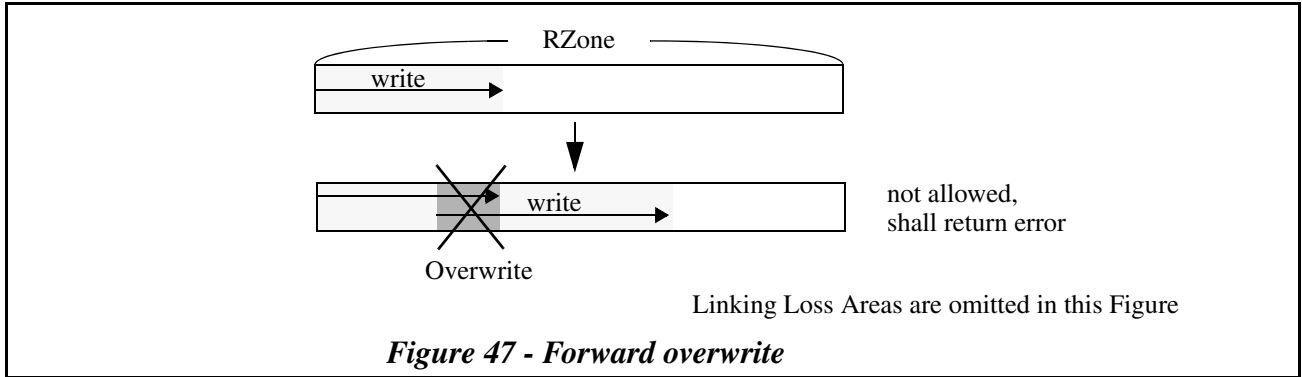
Data Type bit of Data ID field, when set to 1, indicates that the next sector belongs to the Linking Loss Area except in the following cases.

- If a sector is used for linking and contains linking position, Data Type of the sector **shall** be set to 0.
- If a sector is used for error recovery scheme, Data Type bit of the sector is dependent on the error recovery scheme. See Figure 57 - *Repair incomplete linking* on page 164.

4.17.10.3 Overwrite is prohibited

The logical unit **shall** avoid overwrites to previously written data. Overwriting may cause data destruction.

When the WRITE (10) command is attempting to write to a previously written sector, the command **shall** be terminated with CHECK CONDITION status, 5/21/02 INVALID ADDRESS FOR WRITE.



4.17.11 RMD (Recording Management Data) for Single Layer discs

The RMD block size is 32 KB. Its physical format is the same as an ECC block. When RMD is written in RMA, 2 KB linking is used. Therefore, the valid part of each RMD block is 30 KB. The RMA size allows for approximately 700 RMD updates. When the remaining RMA is less than 15 ECC blocks and an RMD update is required by any command, the logical unit *shall* terminate the command with CHECK CONDITION status, 1/73/06 PROGRAM MEMORY AREA/RMA IS ALMOST FULL. When the remaining RMA is less than 3 ECC blocks and an RMD update is required by any command, the logical unit *shall* terminate the command with CHECK CONDITION status, 3/73/05 PROGRAM MEMORY AREA/RMA IS FULL.

The RMA and RMD block structure are shown in Figure 49 below.

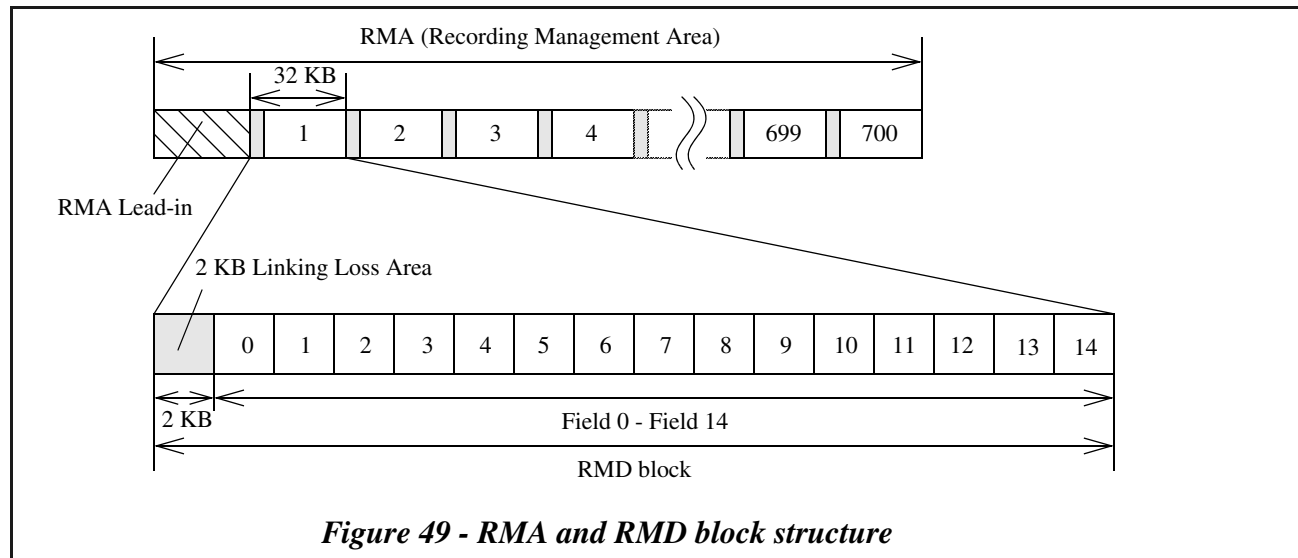


Figure 49 - RMA and RMD block structure

The RMD block consists of 15 fields and a Linking Loss Area. The contents of each Field is defined in the following tables.

Initial value of RMD *shall* be 0. The RMD structures described in this section are defined by DVD-R SL Ver. 2.1. For the RMD structure of the other versions of DVD-R discs, refer to the applicable DVD-R Book.

4.17.11.1 RMD Field 0 (RMD Header)

RMD Field 0 specifies general information of the disc. Table 50 shows the structure of RMD Field 0.

Table 50 - RMD - Field 0

Bit Byte	7	6	5	4	3	2	1	0
0-1	(MSB) RMD Format							(LSB)
2	Disc Status							
3	Reserved							
4-21	(MSB) Unique Disc ID							(LSB)
22-127	Copy of Pre-pit Information							
128-2 047	Reserved							

The RMD Format field specifies the format of the following RMD Field 1-14 which is used on the medium. RMD Format field is defined in Table 51.

Table 51 - RMD Format field definition

Value	Definition
0	Reserved
1	The following RMD Field 1-14 are recorded as Format 1 RMD.
2-3	Reserved for DVD-RW media
4	Reserved for DVD-R Dual Layer media
5-65 535	Reserved

The Disc Status field indicates the disc status. Disc Status field is defined in Table 52.

Table 52 - Disc Status field definition

Value	Definition
0	The disc has no written data in Data Recordable Area (only RMD is written)
1	The disc is in Disc-at-once recording mode
2	The disc is in Incremental recording mode
3	The disc is completed and not appendable in the case of incremental recording
4-255	Reserved

The Unique Disc ID field *shall* be recorded and structured as defined in Table 53. The Unique Disc Identifier contains time stamp fields. The time format should be UTC 24 hour clock¹. This field *shall* be set by the SEND DISC STRUCTURE command. This time stamp data sent by the SEND DISC STRUCTURE command may also be used in the OPC related field in RMD Field 1 and may help the judgement to do OPC. The logical unit *shall* update the time stamp during power on. Strict accuracy of time is not required.

Table 53 - Unique Disc ID

Bit Byte	7	6	5	4	3	2	1	0
0-1	Reserved							
2-3	(MSB) Random Data							(LSB)
4-7	(MSB) Year							(LSB)
8-9	(MSB) Month							(LSB)
10-11	(MSB) Day							(LSB)
12-13	(MSB) Hour							(LSB)
14-15	(MSB) Minute							(LSB)
16-17	(MSB) Second							(LSB)

The Random Data field is a random number.

The Year field specifies the year coded in ASCII in the range “0001” to “9999”.

The Month field specifies the month of the year coded in ASCII in the range “01” to “12”.

The Day field specifies the day of the month coded in ASCII in the range “01” to “31”.

1. UTC = universal time coordinated

The **Hour** field specifies the hour of the day coded in ASCII in the range “00” to “23”.

The **Minute** field specifies the minute of the hour coded in ASCII in the range “00” to “59”.

The **Second** field specifies the second of the minute coded in ASCII in the range “00” to “59”.

The **Copy of Pre-pit Information** field contains the copy of Pre-pit Information data which is recorded as LPP (Land Pre-Pit). Copy of Pre-pit Information structure is shown in Table 54. The Pre-pit information data is specified by DVD-R Book Part 1.

Table 54 - Copy of Pre-pit Information

Bit Byte	7	6	5	4	3	2	1	0
22	Field ID (= 01h)							
23	Application code							
24	Disc Physical code							
25-27	(MSB)	Last address of Data Recordable Area						(LSB)
28	LPP Part Version				Extension code			
29	Reserved							
30	Field ID (= 02h)							
31	OPC suggested code (β value)				OPC suggested code (Recording power)			
32	Wavelength code							
33-36	1st field of Write Strategy code							
37	Reserved							
38	Field ID (= 03h)							
39-44	1st field of Manufacturer ID							
45	Reserved							
46	Field ID (=04h)							
47-52	2nd field of Manufacturer ID							
53	Reserved							
54	Field ID (= 05h)							
55-60	2nd field of Write Strategy code							
61	Reserved							
62-77	2 \times -speed recording parameters							
78-127	4 \times -speed recording parameters							

Note: The RMD structures described in this section are defined by DVD-R SL Ver. 2.1. For the RMD structure of the other versions of DVD-R discs, refer to the applicable DVD-R Book.

4.17.11.2 The contents of Format 1 RMD for Single Layer disc

4.17.11.2.1 Format 1 RMD Field 1

Format 1 RMD Field 1 contains some logical unit and OPC related information. Table 55 shows the structure of Format 1 RMD Field 1.

There are four sets of OPC data blocks. These are prepared for the case of four different DVD-R logical units writing to a disc. The logical unit *shall* use an empty set or its own. If there is no owned or empty OPC data block, the logical unit may use the oldest time stamp OPC data block.

Table 55 - Format 1 RMD - Field 1 (logical unit and OPC information)

Bit Byte	7	6	5	4	3	2	1	0
0-31	Drive manufacturer ID #1							
32-47	Serial Number #1							
48-63	Model Number #1							
64-67	1st field of Write Strategy Code #1							
68-71	Recording Power #1							
72-79	Time stamp #1							
80-83	Power Calibration Address #1							
84-107	Running OPC Information #1							
108-113	2nd field of Write Strategy Code #1							
114-115	DSV #1							
116-127	Reserved							
:	:							
384-415	Drive manufacturer ID #4							
416-431	Serial Number #4							
432-447	Model Number #4							
448-451	1st field of Write Strategy Code #4							
452-455	Recording Power #4							
456-463	Time stamp #4							
464-467	Power Calibration Address #4							
468-491	Running OPC Information #4							
492-497	2nd field of Write Strategy Code #4							
498-499	DSV #4							
500-511	Reserved							
512-2 047	Reserved							

The Drive manufacturer ID #n field is recorded in binary and specifies unique drive manufacturer identifier of the logical unit.

The Serial Number #n field is recorded as ASCII code and specifies serial number of the logical unit.

The Model Number #n field is recorded as ASCII code and specifies the recorder model number.

The 1st field of Write Strategy Code #n field specifies the basic write strategy code that is specified by DVD-R Book Part 1.

The Recording Power #n field may be used to store the value of the OPC result. The format of this field is vendor-specific. If this field is set to 0, this field is invalid.

The Time stamp #n field may be used to store date and time when OPC is performed. This field, if used, is recorded in binary. If this field is set to 0, this field is invalid.

The Power Calibration Address #n field may be used to specify the start ECC block address of the PCA where the last OPC was performed. If this field is set to 0, this field is invalid.

The Running OPC Information field may be used to specify values concerning running OPC. The format is vendor-specific. If this field is set to 0, this field is invalid.

The 2nd field of Write Strategy Code #n field specifies the adaptive write strategy code that is specified by DVD-R Book Part 1.

If the disc is incrementally recorded and when RMD is updated, the DSV field *shall* be recorded. This field is used to specify the last DSV (Digital Sum Value) in binary notation.

4.17.11.2.2 Format 1 RMD Field 2

Format 1 RMD Field 2 can be used freely and format of this field is user-specific.

Table 56 - Format 1 RMD - Field 2 (User specific data)

Bit Byte	7	6	5	4	3	2	1	0
0-2 047	User Specific Data							

The User Specific Data field is available for user specific data. This field may be used, otherwise this field *shall* be set to all 00h.

4.17.11.2.3 Format 1 RMD Field 3

Format 1 RMD Field 3 may contain Border Zone information and *shall* be recorded as follows.

Table 57 - Format 1 RMD - Field 3 (Border Zone information)

Bit Byte	7	6	5	4	3	2	1	0
0-3	(MSB) Start Sector Number of Border-out #1							(LSB)
4-7	(MSB) Start Sector Number of Border-out #2							(LSB)
8-11	(MSB) Start Sector Number of Border-out #3							(LSB)
:	:							
2 036-2 039	(MSB) Start Sector Number of Border-out #510							(LSB)
2 040-2 043	(MSB) Start Sector Number of Border-out #511							(LSB)
2 044-2 047	(MSB) Start Sector Number of Border-out #512							(LSB)

The Start Sector Number of Border-out #n field, if it contains other than 0, indicates that the start sector number of the nth Border-out.

4.17.11.2.4 Format 1 RMD Field 4

Format 1 RMD Field 4 contains RZone related information and *shall* be recorded as follows.

Table 58 - Format 1 RMD - Field 4 (RZone Information)

Bit Byte	7	6	5	4	3	2	1	0
0-1	(MSB) Invisible/Incomplete RZone number (Last RZone Number)							(LSB)
2-3	(MSB) First Open RZone number							(LSB)
4-5	(MSB) Second Open RZone number							(LSB)
6-15	Reserved							
16-19	(MSB) Start Sector Number of RZone #1							(LSB)
20-23	(MSB) Last Recorded Address of RZone #1							(LSB)
24-27	(MSB) Start Sector Number of RZone #2							(LSB)
28-31	(MSB) Last Recorded Address of RZone #2							(LSB)
:	:							
2 032-2 035	(MSB) Start Sector Number of RZone #253							(LSB)
2 036-2 039	(MSB) Last Recorded Address of RZone #253							(LSB)
2 040-2 043	(MSB) Start Sector Number of RZone #254							(LSB)
2 044-2 047	(MSB) Last Recorded Address of RZone #254							(LSB)

The Invisible/Incomplete RZone Number field contains the Invisible/Incomplete RZone number of the medium. If the last RZone state is neither Invisible nor Incomplete due to disc finalization, this field contains the last Complete RZone number.

The First Open RZone number field, if recorded with value other than 0, contains the current appendable Reserved RZone number and the value *shall* be different from the Second Open RZone number field. If this field is set to 0, there is no Empty reserved RZone or Partially recorded reserved RZone corresponding to this field.

Second Open RZone number field, if recorded with value other than 0, contains the current appendable Reserved RZone number and the value *shall* be different from the First Open RZone number field. If this field is set to 0, there is no Empty reserved RZone or Partially recorded reserved RZone corresponding to this field.

When the Incomplete RZone is closed, the Invisible/Incomplete RZone Number field contains the number of the new Invisible RZone number (N+1). When Reserved RZone is closed, the corresponding First (Second) Open RZone number field *shall* be set to 0.

The Start Sector Number of RZone #n field contains the start sector number of the RZone which has RZone number #n.

The Last Recorded Address of RZone #n field contains the last recorded address of the RZone which has RZone number #n. If this field is set to 0, this field is not valid. If RZone #n is not closed, the value of this field may not be correct and a link point search is required to determine the correct LRA.

Note: The LRA reported by the READ TRACK INFORMATION command is always correct.

When the RZone is not closed, even if the Last Recorded Address of RZone #n field contains a value, the logical unit *shall* determine the current LRA of the RZone. When RZone is closed, Last Recorded Address of RZone #n field *shall* be recorded before RZone padding.

4.17.11.2.5 Format 1 RMD Field 5 - Field 12

Format 1 RMD Field 5 through Field 12 may contain RZone related information continued from Format 1 RMD Field 4.

Table 59 - Format 1 RMD - Field 5 - Field 12 (RZone Information ... continued)

Bit Byte	7	6	5	4	3	2	1	0
0-3	(MSB) Start Sector Number of RZone #n							(LSB)
4-7	(MSB) Last Recorded Address of RZone #n							(LSB)
8-11	(MSB) Start Sector Number of RZone #(n+1)							(LSB)
12-15	(MSB) Last Recorded Address of RZone #(n+1)							(LSB)
:	:							
2 032-2 035	(MSB) Start Sector Number of RZone #(n+253)							(LSB)
2 036-2 039	(MSB) Last Recorded Address of RZone #(n+253)							(LSB)
2 040-2 043	(MSB) Start Sector Number of RZone #(n+254)							(LSB)
2 044-2 047	(MSB) Last Recorded Address of RZone #(n+255)							(LSB)

The Start Sector Number of RZone #n field contains start sector number of the RZone which has RZone number #n.

The Last Recorded Address of RZone #n field contains the last recorded address of the RZone which has RZone number #n. If this field is set to 0, this field is not valid. If RZone #n is not closed, the value of this field may not be correct and a link point search is required to determine the correct LRA.

Note: The LRA reported by the READ TRACK INFORMATION command is always correct.

When the RZone is not closed, even if the Last Recorded Address of RZone #n field contains a value, the logical unit *shall* determine the current LRA of the RZone. When RZone is closed, Last Recorded Address of RZone #n field *shall* be recorded before RZone padding.

4.17.11.2.6 Format 1 RMD Field 13

Table 60 shows the structure of Format 1 RMD Field 13. This Field contains drive specific information. There are eight sets of drive specific information blocks. These are prepared for the case of up to eight different DVD-R logical units writing to a disc. The unused fields in Format 1 RMD Field 13 *shall* be set to zero.

Table 60 - Format 1 RMD - Field 13 (Drive specific information)

Bit Byte	7	6	5	4	3	2	1	0
0-31	Drive manufacturer ID #1							
32-47	Serial Number #1							
48-63	Model Number #1							
64-66	Recorded RMA address (ECC block address) #1							
67-127	Drive specific data #1							
:	:							
896-927	Drive manufacturer ID #8							
928-943	Serial Number #8							
944-959	Model Number #8							
960-962	Recorded RMA address (ECC block address) #8							
963-1 023	Drive specific data #8							
1 024-2 047	Additional drive specific information for recorder #1							

The Drive Manufacturer ID #n field is recorded in binary and contains unique drive manufacturer identifier.

The Serial Number #n field is recorded in ASCII code and contains the serial number of the logical unit.

The Model Number #n field is recorded in ASCII code and contains the drive model number of the logical unit.

The Recorded RMA address #n field specifies the starting RMA address which is used to record RMD including the information of specific drive. This field is specified in ECC block address.

The Drive specific data #n field may be recorded to store the drive specific data. If this field is set to zero, this field is invalid.

The Additional Drive specific data for recorder #1 field may be recorded to store the additional drive specific data for logical unit #1. If this field is set to zero, this field is invalid.

4.17.11.2.7 Format 1 RMD Field 14

Table 61 shows the structure of Format 1 RMD Field 14.

Table 61 - Format 1 RMD - Field 14 (Versatile information)

Bit Byte	7	6	5	4	3	2	1	0
0	Outer disc testing area flag							
1-4	Testing address							
5-2 047	Reserved							

The Outer disc testing area flag field indicates whether the outer disc testing method is applied to this media. If this field is set to 01h, the outer disc testing method is applied, and if set to 00h the outer disc testing method is not applied. The outer disc testing method is specified by DVD-R Book.

The Testing address field indicates the start ECC block address of Outer disc testing area where the last OPC was performed. This field is set to 00h when the Outer disc testing area flag is set to 00h.

4.17.11.3 When RMD is written in RMA

Usually, RMD may be cached in the logical unit memory. As occasion calls, RMD *shall* be written in RMA. By using RMD caching, the logical unit can avoid waste of RMA. The timing when RMD is written in RMA is shown in Table 62.

Table 62 - Mandatory RMD update condition in RMA

condition
1. When a WRITE (10) command is issued following a RESERVE TRACK command, before the start of writing, RMD <i>shall</i> be written in RMA.
2. When a CLOSE TRACK/SESSION command is issued, before the start of the close operation for either RZone or Border, RMD <i>shall</i> be written in RMA.
3. When a SYNCHRONIZE CACHE (10) command is issued following SEND DISC STRUCTURE command which specifies User Specific Data, RMD <i>shall</i> be written in RMA.
4. When the difference between the last recorded sector number in fact and "Last Recorded Address of RZone #n" recorded in the latest RMD is larger than 16 MB, RMD <i>shall</i> be written in RMA. However if the logical unit is busy (e.g., writing is in progress), the update may be done at a later time.

When writing in the same Incomplete RZone for an extended period of time, RMD may not be recorded for a long time. To force writing of the RMD, the host should close the Incomplete RZone after a certain time has passed. Then the new information is written into the RMA. Although the Invisible RZone number is increased due to the closing of the Incomplete RZone, the NWA of the new Invisible RZone is the same as the NWA of the closed Incomplete RZone.

4.17.11.4 Example of write sequence

This section explains one example of a write sequence. See Table 63 and Table 64.

Table 63 - Example of write sequence (blank disc)

Sequence	user/host	logical unit action
1	Insert blank disc	check RMD
2	Specify Write Type (disc-at-once/incremental) and Unique Disc Identifier (MODE SENSE (10), MODE SELECT (10), and SEND DISC STRUCTURE commands)	cache (RMD Field 0)
3	Specify other Identifier field. (SEND DISC STRUCTURE command)	cache (RMD Field 1)
4	Specify User Specific Data field of RMD if needed. (SEND DISC STRUCTURE command)	cache (RMD Field 2)
5	Reserve RZones if needed. (RESERVE TRACK command)	cache (RMD Field 4 - Field 12)
6	get NWA (READ TRACK INFORMATION command)	calculate and send to host
7	start writing from NWA (WRITE (10) command)	1. do OPC 2. write RMD in RMA if RZone is reserved. 3. start writing 4. if buffer become empty, stop writing with linking.
8	close RZone or Bordered Area (CLOSE TRACK/SESSION command)	1. write RMD in RMA prior to close RZone or Bordered Area 2. pad RZone or write Border-in/Lead-in and Border-out/Lead-out.

Table 64 - Example of write sequence (non-blank disc)

	user/host	logical unit action
1	Insert non-blank disc	check RMD check Write Type
2	Specify User Specific Data field of RMD if needed. (SEND DISC STRUCTURE command)	cache (RMD Field 2)
3	Reserve RZones if needed. (RESERVE TRACK command)	cache (RMD Field 4 - Field 12)
4	get NWA (READ TRACK INFORMATION command)	search and send to host
5	start writing from NWA (WRITE (10) command)	1. do OPC, if needed 2. write RMD in RMA if RZone is reserved 3. start writing 4. if buffer becomes empty, stop writing with linking
6	close RZone or Bordered Area (CLOSE TRACK/SESSION command)	1. write RMD in RMA prior to close RZone or Bordered Area 2. pad RZone or write Border-in/Lead-in and Border-out/Lead-out

4.17.11.5 Border Zone

Border Zone is used for Border recording to interchange DVD-R media between DVD-R and DVD read-only logical units.

Border Zone provides a solution for pickup overrun problem of DVD read-only logical unit. Once Border is closed, there are no unrecorded areas between Lead-in/Border-in and Border-out except for Next Border Marker (See 4.17.11.5.5, "Border-out contents" on page 159).

Disc structure with Border Zone is shown in Figure 50 below.

Note: Linking Loss and BSGA is omitted in this figure.

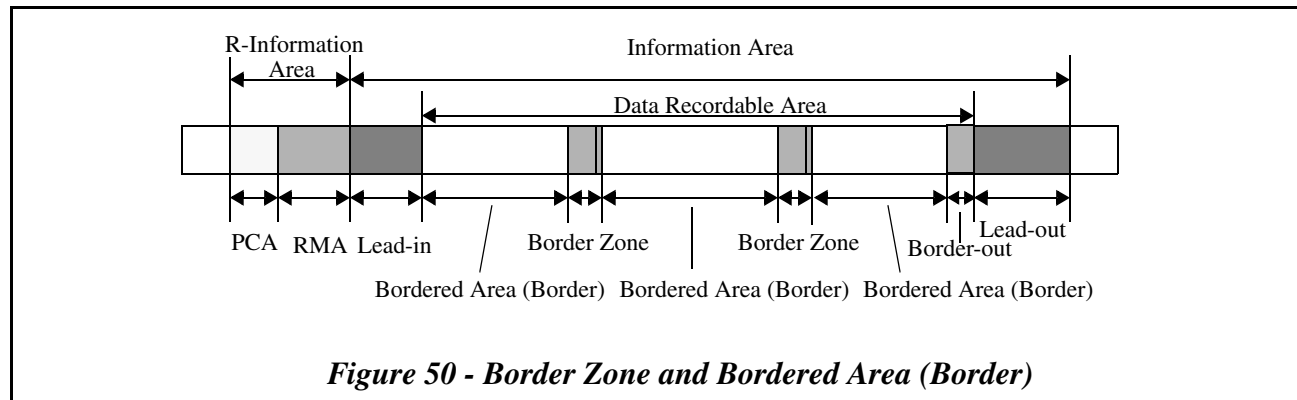


Figure 50 - Border Zone and Bordered Area (Border)

4.17.11.5.1 Border Zone size and length

The Border-out start address *shall* be located after PSN 3FF00h. If a CLOSE TRACK/SESSION command is issued when recorded user data end address is less than PSN 3FF00h, the logical unit *shall* pad with 00h data through PSN 3FEFFh. The recorded area width of 3 mm in the radial direction is guaranteed by this padding.

Border Zone size is dependent on its starting address and order. Table 65 shows the relationship between location and Border Zone size for DVD-R SL media.

- First Border Zone length is approximately 0,5 mm in the radius.
- The other Border Zone length is approximately 0,1 mm in the radius except Final Border Zone.

Note: Final Border Zone means that which is written when the Disc is finally closed with Lead-out. See 4.17.11.6, "Disc final closure" on page 161.

Table 65 - Border Zone size for DVD-R media

Physical sector number of beginning Border Zone	3FF00h-B25FFh	B2600h-1656FFh	165700h-
First Border Zone Size	1 792 ECC blocks 56 MBytes ^a	2 368 ECC blocks 74 MBytes	2 944 ECC blocks 92 MBytes
Second and above Border Zone Size	384 ECC blocks 12 MBytes	480 ECC blocks 15 MBytes	608 ECC blocks 19 MBytes

a. MByte = 1 024 × 1 024 bytes

4.17.11.5.2 Recording for Border Zone

Each logical sector in Border Zone *shall* be assigned to a Logical Block Address (LBA). Each logical sector of Data Recordable Area *shall* be identified by a unique logical sector number. LBAs *shall* be integers assigned in ascending sequence, starting with 0 from the PSN 30000h.

A Border Zone consists of a Border-out, a Data Area, and a Border-in. Border-out/in is written when a CLOSE TRACK/SESSION command is issued with Close Function=010b.

Border Zone is recorded with following sequence.

1. Close all opened (Empty reserved/Partially recorded reserved/Incomplete) RZones by using a CLOSE TRACK/SESSION command with the Close Function=001b.
2. Issue CLOSE TRACK/SESSION command to close Bordered Area (Close Function=010b).
3. Border-out is recorded from NWA of the Invisible RZone. Border-in of this Border Zone is still unrecorded at this time. The Border-in will be recorded when next CLOSE TRACK/SESSION command is issued.
4. If Lead-in is still unwritten, Lead-in is recorded on the medium. If Lead-in is already written, Border-in is recorded after the previously written Border-out.

When a CLOSE TRACK/SESSION command which specifies the closing of the Border, regardless of Linking Loss size, Border Zone *shall* be written from ECC boundary.

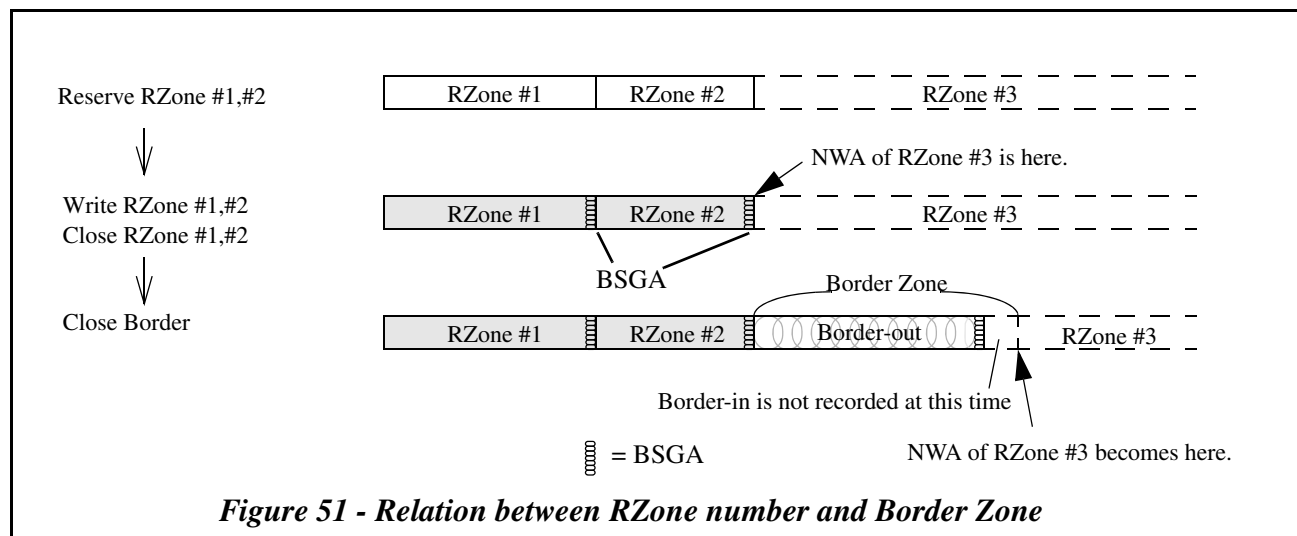
When 32 KB Linking Loss size is selected, Border Zone is written from NWA of the Invisible RZone. If 32 KB Linking Loss size is not selected, logical unit *shall* pad 00h from the NWA of the Invisible RZone to the end of the ECC block and then Border Zone is written from the beginning of next ECC block. This padded area is referred to as Border-out Padding. Border-out Padding is used to align the start address of the Border-out on the ECC boundary.

If Border Zone start LBA is less than 0FF00h, the logical unit *shall* pad with 00h data up to LBA 0FEFFh and then Border Zone is written from LBA 0FF00h.

RZone numbers are not assigned to Border Zone. The Invisible RZone number is not incremented due to Border Zone writing.

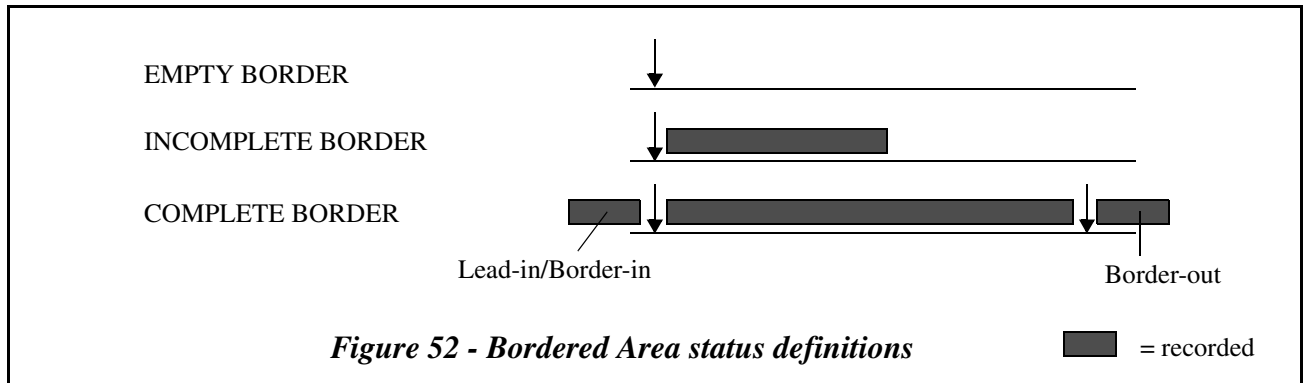
After Border Zone writing, NWA of the Invisible RZone is moved to the following written Border Zone. Figure 51 shows an example of the write sequence and relationship between RZone number and Border Zone.

The Border-in which immediately follows last Border-out *shall* remain unrecorded when the Border Zone is written. This unrecorded Border-in will be used for next Bordered Area. The unrecorded Border-in will be recorded when the next Bordered Area is closed.



4.17.11.5.3 Border Zone status

Bordered Area status changes according to its recording stage.



4.17.11.5.4 Border-in contents

Border-in contains five copies of control data structure which has the same structure as the control data that is recorded in the Lead-in.

To provide the information concerning the Border Zone to the DVD read-only logical unit which has no capability of RMA reading, the Physical Format Information field of Lead-in/Border-in contains the pointer to the Border Zone and LRA information for last RZone. See Table 26 - *DVD-R SL Ver. 2.1 unique part of Physical format information* on page 99 and Table 24 - *Data Area Allocation field definition* on page 98.

In final closing of a disc, the start PSN of the Next Border-in field in the Physical Format Information **shall** be set to 00h.

4.17.11.5.5 Border-out contents

Border-out consists of Border RMD Area, Stop Blocks and Next Border Markers. When a Border-out will be followed by Lead-out Area, Stop Blocks and Next Border Markers may be omitted. Such a Border-out is also called as truncated Border-out.

Border-out has Border RMD Area (5 ECC blocks) which has five copies of latest RMD. Border RMD Area is recorded to provide the information concerning the Bordered Areas to the DVD read-only logical unit which has no capability of RMA reading.

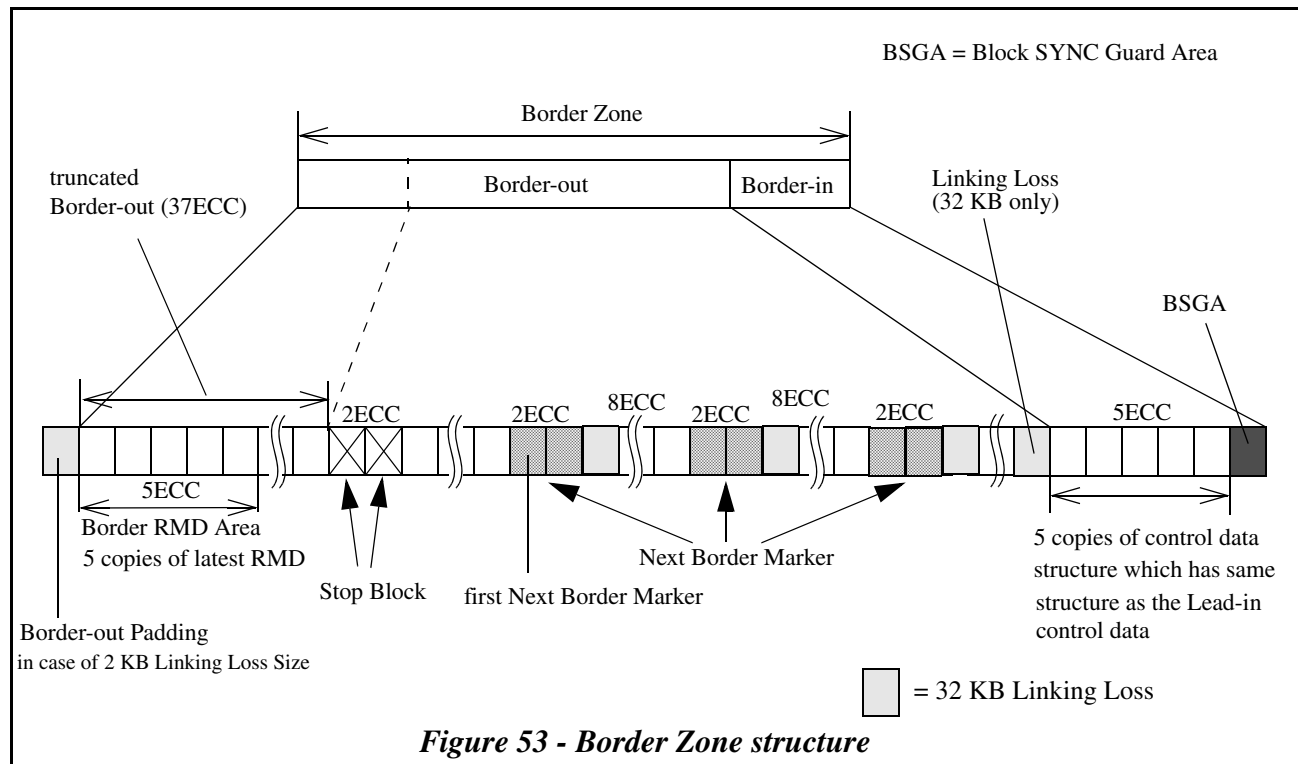
Stop Blocks (2 ECC blocks) are located relatively 38th and 39th ECC blocks from the beginning of the Border-out. The Area type of Stop Block has Lead-out attribute. Stop Block prevents the logical unit which expects Lead-out existence from pick up over-run.

Border-out also contains Next Border Marker (three occurrences of 2 ECC blocks). This specifies whether the next Border exists or not. When next Border does not exist and Lead-out is still unwritten, the Next Border Marker in the last Border-out **shall** remain in a mirror state (unwritten). When closing a Border, the previous Next Border Marker **shall** be written with 00h or two copies of updated Physical Format information block data of the latest Border-in. In the final closing of a disc, the Next Border Marker in the final Border-out **shall** be padded with 00h and have a Lead-out attribute.

The first Next Border Marker in Border-out is located in half of the Border-out. The start address of first Next Border Marker is calculated by following formula:

$$((\textit{Start sector number of the next Border-in}) + (\textit{Start sector number of the current Border-out})) / 2$$

The whole structure of Border Zone is shown in Figure 53.

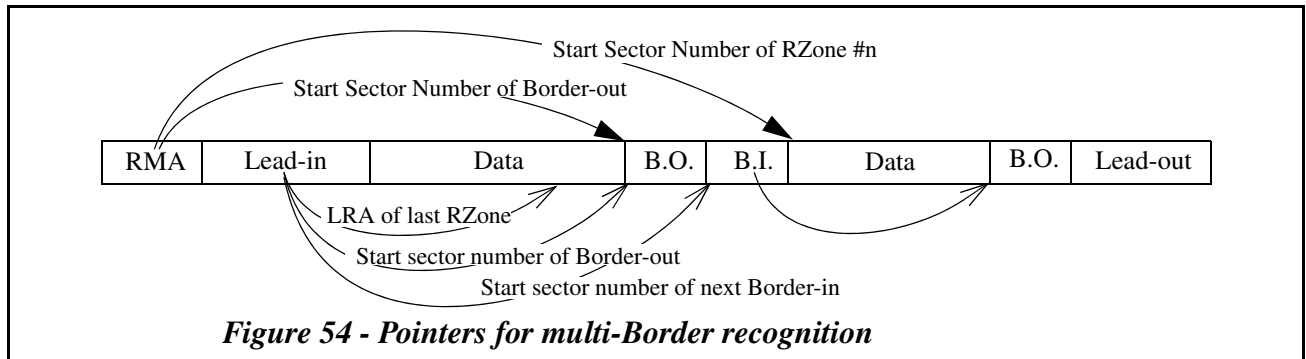


4.17.11.5.6 Example for multi-Border recognition

To explain how to recognize a Border Zone, a sample recognition sequence for a Multi-Border recorded disc is shown below.

Table 66 - Multi-Border example

Sequence	sample sequence
1	insert disc
2	logical unit reads Physical format information field in Lead-in data. - check Start Address of Border-out - check Start Address of Border-in
3	logical unit reads Next Border Marker in Border-out. - check whether next Bordered Area is exist or not and find next Bordered Area
4	logical unit reads Physical format information in Border-in. - check whether Book Type is DVD-R or not - check Start Address of Border-out - check Start Address of Border-in
5	logical unit reads Next Border Marker in Border-out. - check whether next Bordered Area is exist or not and find no next Bordered Area
6	host reads LBA16 by using READ command. - check which kind of file system is used on the media - if UDF and a VAT (See OSTA UDF 1.5 or later) is used, read VAT ICB which recorded at the LRA - get LRA by READ TRACK INFORMATION command
7	host reads VAT ICB at Last Recorded Address by using READ command. - get VAT address from VAT ICB - read VAT



4.17.11.6 Disc final closure

If the Multisession/Border field in the Write Parameters mode page is set to 00b, when CLOSE TRACK/SESSION command which intends to close the Border is issued, the final closure operation *shall* be started for the disc. After this operation, Lead-out is appended after the last Border-out and data cannot be appended to the disc any more. The total length of the last Border-out and Lead-out *shall* be about 0,5 mm in the radial direction. See Table 65 - *Border Zone size for DVD-R media* on page 157.

To recognize whether the disc is finalized or not, the following conditions are checked. If one of the following condition is met, the disc *shall* be considered a finalized disc and is not appendable.

- Start PSN of the next Border-in field of Lead-in/Border-in contains 0.
- Next Border Marker is recorded as Lead-out attribute.
- Disc Status field of RMD contains “Complete” status.

Final closure operation (Finalize) is done in the following sequence:

1. Set Multisession/Border field in Write Parameters mode page to 00b.
2. Close all opened RZone(s).
3. Issue CLOSE TRACK/SESSION command with Close Function=010b.
4. Updated RMD is written in RMA with Disc Status field “Complete”.

If the last Bordered Area (Border) is incomplete status and Lead-in is already written:

5. Border-out for current incomplete Border and Lead-out are written with the following conditions:
Border-out *shall* be recorded until Stop Block.
Lead-out *shall* be recorded after the Stop Block.
6. Border-in for current Border is written with following condition.
The Start Sector Number of Next Border-in field *shall* be set to 0.
7. Next Border Marker in previous Border-out is padded with 00h and set to Area Type field of Data ID 00b. (normal data sector)

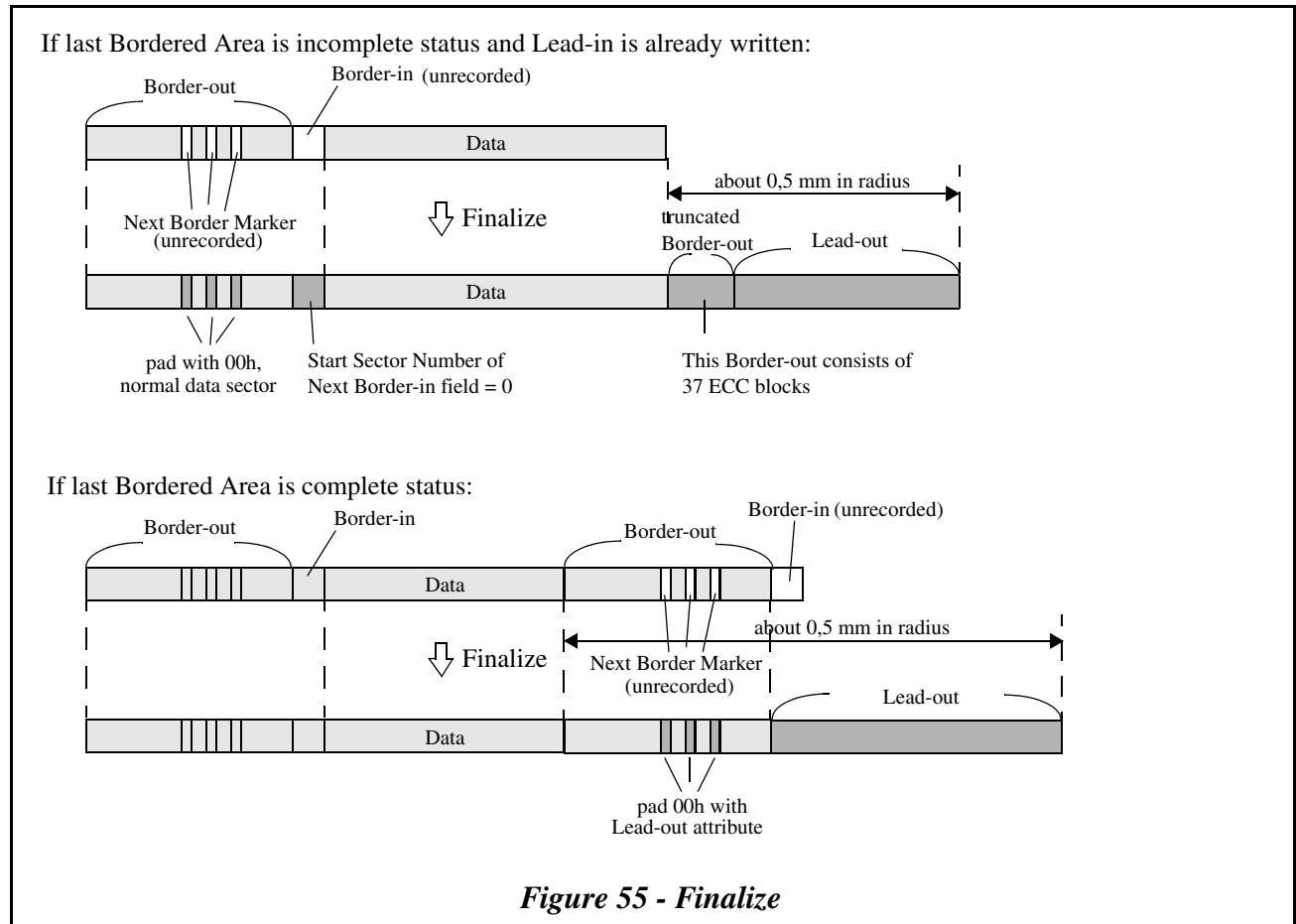
If the last Bordered Area (Border) is incomplete status and Lead-in is still unwritten:

5. Border-out for current incomplete Border and Lead-out are written with following condition.
Border-out or truncated Border-out *shall* be recorded. If the remaining capacity of Data Recordable Area is not sufficient for Border-out, truncated Border-out *shall* be recorded.
Lead-out *shall* be recorded after the Border-out or truncated Border-out.
6. Lead-in is recorded.
The Start Sector Number of Next Border-in field *shall* be set to 0.

If the last Bordered Area (Border) is empty status and Lead-in is already written:

5. Lead-out *shall* be recorded immediately following the last Border-out where there is reserved space for the next Bordered Area's Border-in.
6. Next Border Markers in last Border-out *shall* be padded with 00h and set to Area Type field of Data ID 01b. (Lead-out)

The total radial width of last Border-out and Lead-out *shall* be about 0,5mm.



4.17.12 State of disc for interchange

To make recorded user data readable by DVD read-only logical units, a Lead-in/Border-in and Border-out/Lead-out *shall* be recorded at each end of recorded user data.

In disc-at-once recording, Lead-in through Lead-out is always written in one recording action. Therefore DVD-R media which is written by disc-at-once recording is ready to be read by any DVD read-only logical unit.

In incremental recording, DVD-R media cannot be read by DVD read-only logical units unless Lead-in/Border-in and Border-out is written at each end of Bordered Areas.

4.17.13 The data which are recordable by DVD-R logical units

The data types which are recordable by a DVD-R logical unit are listed below.

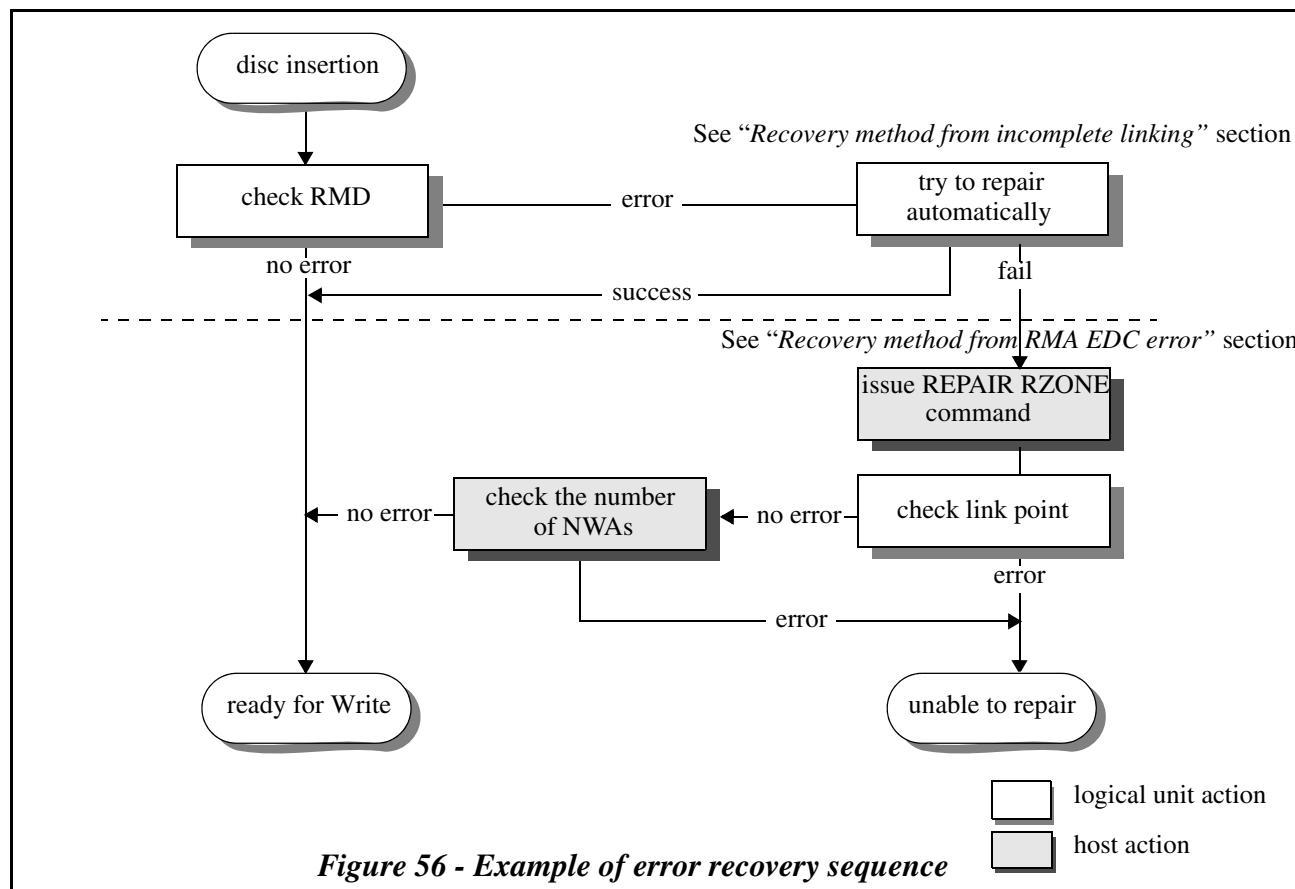
- User data in Data Area
- Copyright Management Information in Data Area
 - CPM
 - CGMS
- Control data in Lead-in Area
 - manufacturing Information field (copied from RMD Field-2)
- RMD in RMA area

Note: The manufacturing Information field of DVD-R media contains user specific data. It may be written by authoring software.

4.17.14 Recovery from a damaged disc

An RZone or RMD may be damaged with incomplete status (no linking) at the end of the written data. This may be caused by a HARD RESET or a power-fail condition during an incremental recording.

A recorded data may not be readable due to EDC error. The disc may be dirty or cracked after recording.

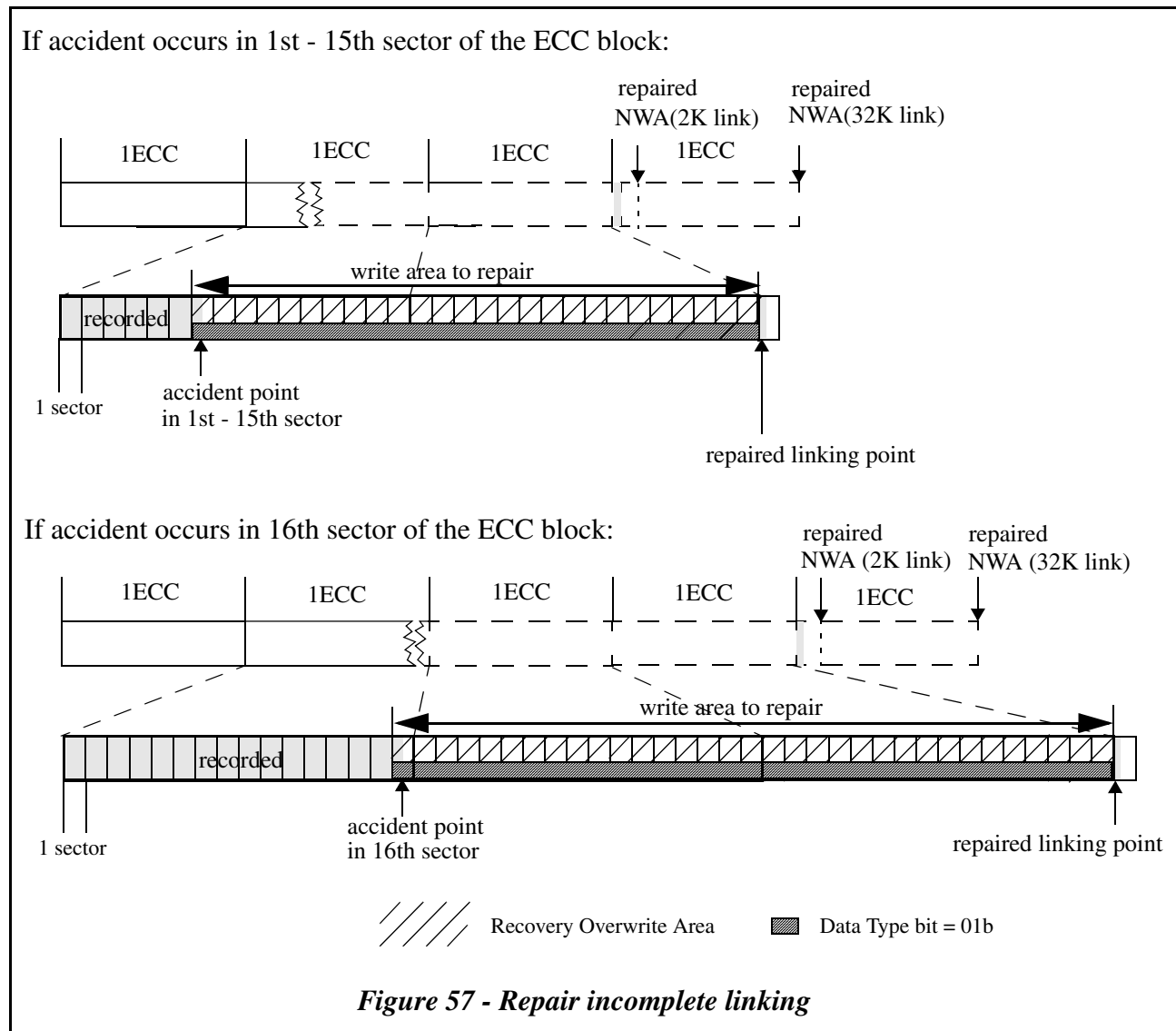


4.17.14.1 Recovery method from incomplete linking

If an ECC block is damaged accidentally, the logical unit overwrites from the damaged sector of the ECC block with Data Type bit 1. If an error occurs in the first through 15th sector of the ECC block, the logical unit writes one more ECC block with Data Type bit 1 immediately following the damaged ECC block. If an error occurs in the 16th sector of the ECC block, the logical unit writes two more ECC blocks with Data Type bit 1 immediately following the damaged ECC

block. See Figure 57. In this case, the Last Recorded Address is the last readable sector and does not belong to the Linking Loss sector. Automatically repaired NWA is the first sector of the ECC block which is following padded ECC block(s).

The automatic repair *shall* be done by the logical unit. The actual padding to the damaged RZone *shall* be done when the next write operation is issued to the RZone. The damaged status of the RZone is kept to notice the RZone has damage even if the disc is newly inserted in another logical unit before the repair operation is performed.



4.17.14.2 Recovery method from RMA write error

The recovery method is the same as 4.17.14.1. In this case, there are no modifications in the data recordable area and previously recorded RMD is available as a valid RMD.

4.17.14.3 Recovery method from RMA EDC error

If the logical unit can not read the RMD, the RZone information such as “number of RZones”, “start address of RZone”, “boundary of RZone” is not recognized by the logical unit.

If the last RMD in the RMA is un-recovered because of an EDC error, the logical unit *shall* report the RMA un-recovered error. The logical unit *shall* report CHECK CONDITION status, 3/57/00 UNABLE TO RECOVER TABLE-OF-CONTENTS to any command which requires access to the RMA.

When the last RMD in the RMA is un-recovered because of an EDC error, recovery is as follows:

1. When the host receives an error, clean the media. Eject the media and check the surface. If the surface is dirty, clean the disc.
2. When the error code UNABLE TO RECOVER TABLE-OF-CONTENTS is reported and the media has been cleaned, host *shall* send a REPAIR RZONE command with TRACK/RZONE number 0, telling the logical unit to try to recover using the old RMD in the RMA. When the REPAIR RZONE command with RZone number 0 is issued, the logical unit *shall* try to read the latest readable RMD and check NWAs on the disc. If all NWAs coincide on the disc in the recovered RMD, the logical unit *shall* report GOOD status to the REPAIR RZONE command. The system *shall* check the number of NWAs (open RZones) with the READ TRACK INFORMATION command. If the number of NWAs on disc and file system are the same, the recovered RMD of RMA is correct. System can recognize the disc status successfully.

When latest RMD is not readable and if some reserved RZones had been completed/closed since last readable RMD was written, the logical unit *shall* return CHECK CONDITION status, 3/57/00 UNABLE TO RECOVER TABLE-OF-CONTENTS. In this case, the new Incomplete/Invisible RZone may exist at the outside of the assumed Incomplete RZone. For example, when the last readable RMD reflects the disc status such as case **F** of Figure 43 - *Example of RZone reservation sequence* on page 143 and actual current disc status is the case **G** of Figure 43, logical unit and host might not be aware of the existence of the RZone number 7 of Figure 43.

To make the backup of RMD in RMA, see 4.17.11.3, "When RMD is written in RMA" on page 155.

4.17.14.4 Recovery for accident during Border-out writing

To close a Border, Border-out *shall* be written prior to writing the Border-in.

When an error occurs while writing the information blocks of the Border-out (copies of RMD), the following action may be attempted by the logical unit. If an error occurs while writing data other than information blocks, the logical unit will restart the write at the end of the Border-out.

1. The logical unit attempts to repair the damaged ECC block automatically.
2. If repair is successful, the logical unit updates the RMA with the latest RMD which contains the new Border-out start address (repaired NWA).
3. Rewrites Border-out from repaired NWA.
4. Writes Border-in (or Lead-in) containing the repaired start address of Border-out.

4.18 Recording for DVD-R DL media

4.18.1 The basics for DVD-R DL media

DVD-R DL disc is developed to provide a write-once DVD recordable media with the same capacity as DVD-ROM Dual Layer disc. There are two recording layers on a single side and they are referred to as Layer 0 (L0) and Layer 1 (L1). The L0 is made up from semi-transparent/semi-reflective material so that the laser beam can pass through to the L1. (The L1 is relatively distant from the disc surface than the L0.)

Up to 8,54 gbytes capacity (= same as DVD-ROM Dual Layer disc capacity) is available for recording while the Single Layer disc can hold up to 4,7 gbytes of data. The mechanical dimensions, sector layout, Control Data Zone structure, and recorded signal characteristics (focus/tracking signal) of DVD-R DL medium are almost same as that of DVD-ROM Dual Layer medium. When a disc/Border is closed for interchange, it is expected that the disc is readable by DVD players and DVD read-only logical units.

Although DVD-ROM DL media have two kinds of track path (i.e., Opposite Track Path (OTP) and Parallel Track Path (PTP)), DVD-R DL disc specification defines only OTP discs to avoid user confusion. The OTP disc is the majority usage in case of DVD-ROM Dual Layer discs and is suitable for recording of video and audio contents due to minimum transition time at the Layer Jump Address.

The lowermost writing speed for DVD-R DL media is 2× speed (Scan velocity for write = 7,68 m/s).

The maximum number of NWAs is incremented by one in comparison to DVD-R Single Layer media to support real-time DVD-Video format recording at Layer Jump Address. Maximum three RZones can be reserved at a same time. Maximum available number of NWAs and current valid NWAs are reported by the Track Resources Information of READ DISC INFORMATION command.

Table 67 shows the comparison chart of some parameters between different versions of DVD-R media format.

Table 67 - History of DVD-R media format

DVD-R Version Characteristics	DVD-R Ver. 1.0	DVD-R SL Ver. 2.1	DVD-R DL Ver. 3.0
Capacity per side (120 mm)	3,95 gbytes ^a	4,7 gbytes ^a	8,54 gbytes ^a
Channel bit length (μm)	0,147	0,133	0,147
Track pitch (μm)	0,80	0,74	0,74
Number of Layers per side	1	1	2
Reflectivity	45 to 85%	45 to 85%	16 to 27%
Control Data Zone	recordable	pre-recorded/embossed	pre-recorded/embossed
Maximum Number of NWAs	3	3	4
Standard recording speed	1×	1×/2×	2×

a. gbytes = 1 000 × 1 000 × 1 000 bytes

4.18.1.1 Three Recording Modes for DVD-R DL disc

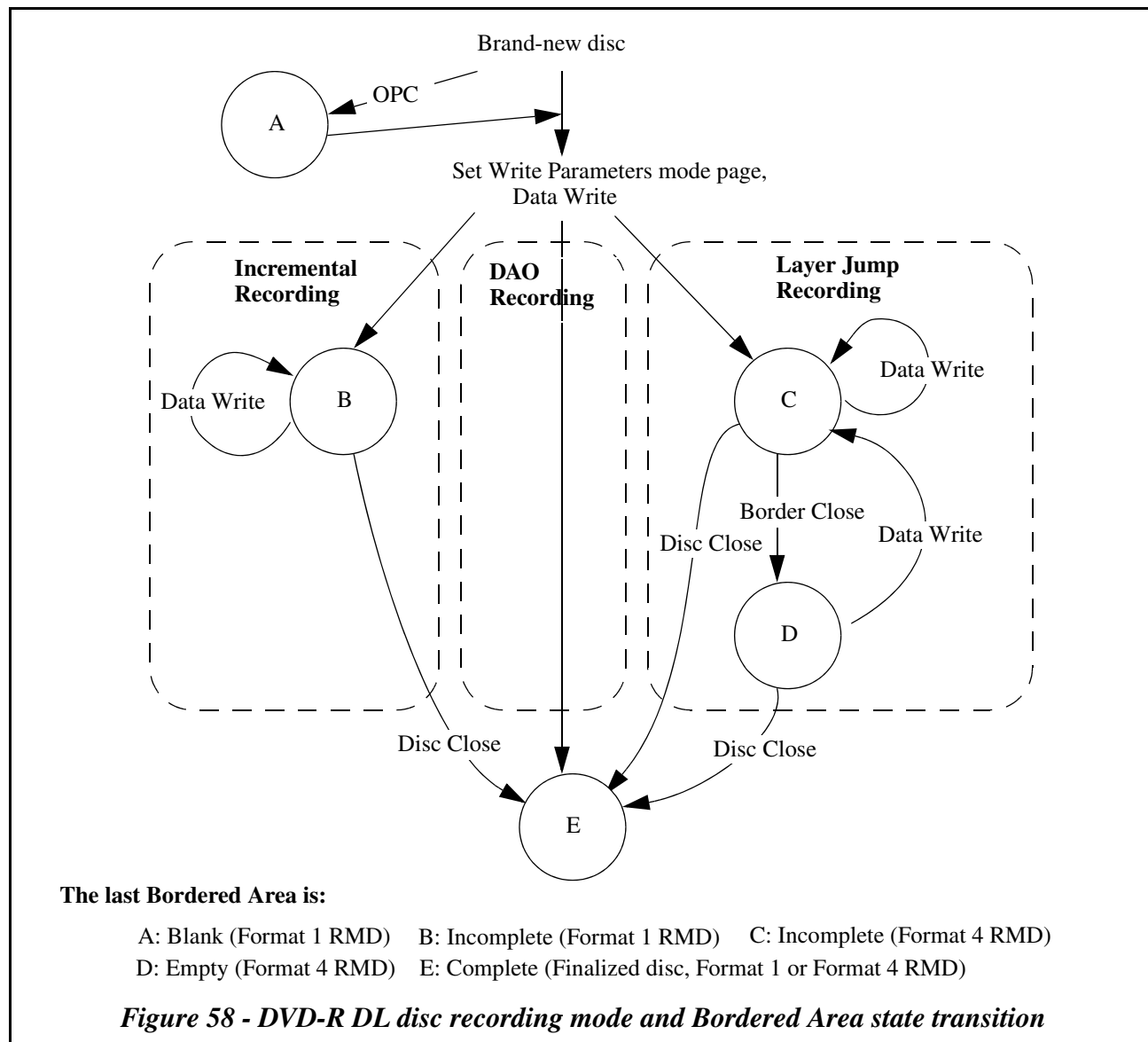
DVD-R DL disc has three recording modes. They are Disc-at-Once recording, Incremental recording, and Layer Jump recording modes. To facilitate the Layer Jump recording, new RMD format (= Format 4) is defined in addition to Format 1 RMD. The Format 1 RMD is defined for conventional recording methods (i.e., Disc-at-once and Incremental recording) that are being used on DVD-R Single Layer media. Some contents of the Format 1 RMD is also expanded.

The multi-Border recording is only supported by the Layer Jump recording mode with Format 4 RMD. Even after the closing of a Border, a user can continue recording until the medium capacity becomes full. If a disc is recorded with multi-Border, the first Bordered Area would be at least readable by legacy DVD read-only logical units and players.

If the Disc Status field of Format 1 RMD is set to blank status (= 00h), none of the recording modes is specified to the disc. When a host specifies the disc as Layer Jump recording mode, the Disc Status field of Format 4 RMD with

Incremental recording status (= 02h) is recorded in RMA after the Format 1 RMD with blank status. To specify Layer Jump recording mode, the Write Type field of Write Parameters mode page *shall* be set to 04h (= Layer Jump recording).

Figure 58 shows the recording mode and Bordered Area status transition diagram for DVD-R DL disc.



4.18.1.2 Associated Profile and Feature

When a blank DVD-R DL disc is installed in a logical unit, the logical unit reports the most appropriate Profile code in the Current Profile field of Table 339 - Feature Header on page 560. If a logical unit supports both DVD-R Dual Layer Sequential recording Profile and DVD-R Dual Layer Jump recording Profile, the logical unit returns these two Profile Descriptors in the Profile List Feature Descriptor. If default value of the Write Type field in Write Parameters mode page is set to 00h or 02h (Incremental or DAO recording), the Current Profile field may be set to Profile 0015h: DVD-R Dual Layer Sequential recording. If default value of the Write Type field is set to 04h (Layer Jump recording), the Current Profile field may be set to Profile 0016h: DVD-R Dual Layer Jump recording. The LJRS field value of READ TRACK INFORMATION command depends on the Write Type field value of Write Parameters mode page. When the

Write Type field value is invalid for DVD-R DL disc, the LJRS field may be set to compatible value with default value setting of the Write Type field for the disc.

Once recording mode is fixed, the recording mode is not changed and the logical unit *shall* report the assigned recording mode information by the LJRS field of READ TRACK INFORMATION command.

The Write Type field of the Write Parameters mode page *shall* be set to associated value with the specified recording mode on the disc. Otherwise the logical unit *shall* terminate disc writing operation with CHECK CONDITION status, 5/64/00 ILLEGAL MODE FOR THIS TRACK.

When the Feature 0033h: Layer Jump recording Feature is current, regardless of the BUFE bit setting, Buffer Under-run Error Free recording *shall* be performed. Therefore the host should issue SYNCHRONIZE CACHE (10) command to finish the data recording. Table 68 shows the relationship between recording mode and associated parameters.

Table 68 - Profile, Feature and Write Type value for each recording mode

Specified recording mode on the disc	Associated parameters to be set to the logical unit		
	Profile to be current	Feature to be current	Write Type ^a value to be set
Disc-at-Once	Profile 0015h: DVD-R Dual Layer Sequential recording	Feature 002Fh: DVD-R/-RW Write Feature	02h (Disc-at-once)
Incremental		Feature 0021h: Incremental Streaming Writable Feature	00h (Incremental)
Layer Jump	Profile 0016h: DVD-R Dual Layer Jump recording	Feature 0033h: Layer Jump recording Feature	04h (Layer Jump)

a. The Write Type field of Write Parameters mode page

4.18.1.3 Recording order

There is a strong recommendation that the area on L1 should be recorded through the recorded area on L0. The transmissivity is different between recorded area and unrecorded area on L0. If the recording order is not kept, the recorded signal characteristics on L1 would not have the uniformity due to different transmissivity on L0. This may cause a trouble to Automatic Threshold Control (ATC) of the logical unit when the recorded data on L1 is read.

4.18.1.4 Fixed logical volume space

The End PSN of L0 field value in Control Data Zone is fixed and not changeable because the Control Data Zone is pre-recorded or embossed by disc manufacturer. See Figure 15 - *Data structure of Lead-in Area* on page 94. This means that the logical volume space is fixed and the start address of Middle Area is also fixed to "End PSN of L0 +1" because the LBA in the logical volume space and PSN have one-to-one relationship (i.e., LBA = PSN-30000h). See Figure 7 - *Physical and logical layout of OTP DVD-ROM DL/-R DL/-RW DL media* on page 87.

4.18.2 Remapping on Layer Jump recording

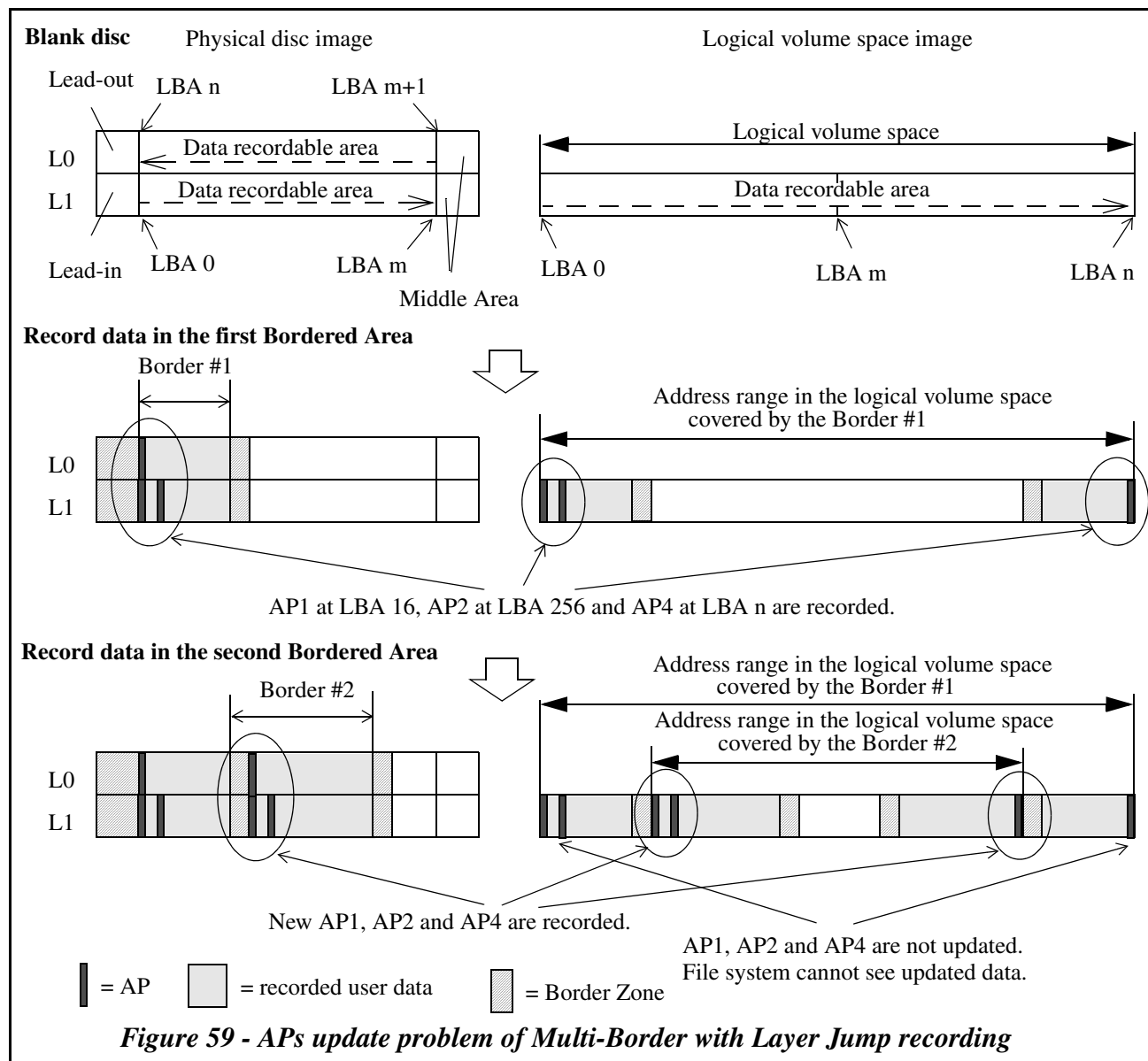
Address remapping mechanism is newly developed to adapt UDF file system and ISO-9660 file system for Layer Jump recording on DVD-R DL disc. When writing software uses the remapping mechanism correctly and the logical unit supports the reading of remapping information, the reading environment of a host is able to treat the multi-Border recorded DVD-R DL disc as if it is single Border recorded disc.

When the Layer Jump recording is used, the file system such as UDF may not work well without remapping mechanism. A file system starts data reading from some of Anchor Points (APs) of DVD-R DL disc to recognize the logical volume and file structure. See Appendix J -, "*UDF Key Structure (Informative)*" on page 1003. In case of UDF, the Volume Recognition Sequence (VRS) and the Anchor Volume Descriptor Pointers (AVDP) are the kind of APs described in this section. UDF uses at least 2 of 3 APs that are located at the LBA 256, n-256 and n (where the n is LBA of the maximum recorded user data sector in the logical volume space on the disc). Those APs may be recorded in the logical format operation. In case of Layer Jump recording, those APs may be recorded in the early recording period. After the APs are

recorded, the recorded data on APs cannot be updated. Figure 59 shows an example of multi-Border recording that contrasts physical disc image with logical volume space image. In Figure 59, the address range in the logical volume space covered by the first Bordered Area involves the address range in the logical volume space covered by the second Bordered Area. Therefore UDF file system cannot see the updated volume structure recorded in the second Bordered Area. To solve this problem, Format 4 RMD provides the address remapping mechanism. Up to four ECC blocks that contain APs can be remapped to alternative ECC blocks. See Figure 88 - *Example sequence of multi-Border recording with remapping* on page 203.

Layer Jump with Border recording also provides physical read compatibility with DVD read-only logical units. The first Bordered Area recorded by the Layer jump recording is physically same as the Data Area on DVD-ROM OTP Dual Layer disc. Therefore, the playback system using DVD read-only logical unit is able to read at least the first Bordered Area even if the logical unit does not support the multi-Border structure on Dual Layer disc. To provide file system level read compatibility with legacy DVD read-only logical units, a host may need to take care of the position of AP3 and AP4. For example, UDF file system requires the AP4 and/or AP3 at LBA n and LBA $n-256$, respectively (n is the maximum recorded user data LBA). Legacy DVD read-only logical units may retrieve LBA n from the pre-recorded CDZ. Thus the AP4 and AP3 locations should match to those information.

See 4.18.5.4.3, "APs data writing" on page 195.

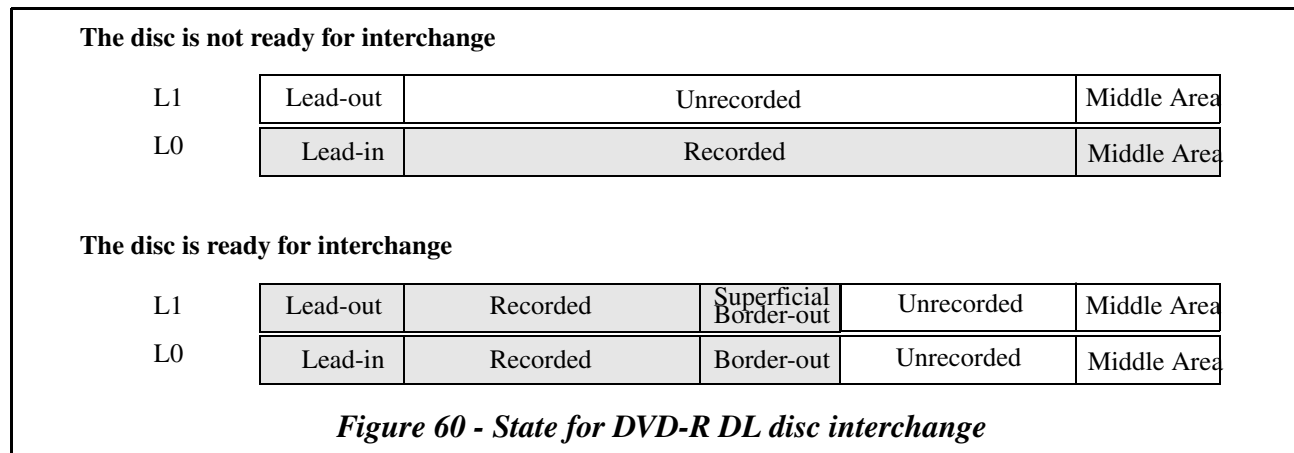


4.18.3 State of DVD-R DL disc for interchange

In general, to make the recorded user data on DVD-R disc physically readable by DVD read-only logical units, at least the following three conditions must be satisfied to prevent the typical DVD read-only logical unit optical pickup from overrunning to the unrecorded area due to the tracking servo mechanism,

- at the inner end of the recorded user Data Area, buffer zone such as Lead-in is located,
- at the outer end of the recorded user Data Area, buffer zone such as Border Zone or Middle Area is located,
- all the sectors from the beginning of the inner buffer zone to the end of the outer buffer zone are recorded.

In addition to the conditions above, in case of DVD-R DL disc, Lead-out and all the sectors on L1 located at the radius between the inner part of Lead-in and the outer part of Border Zone/Middle Area on L0 must also be recorded. See Figure 60.



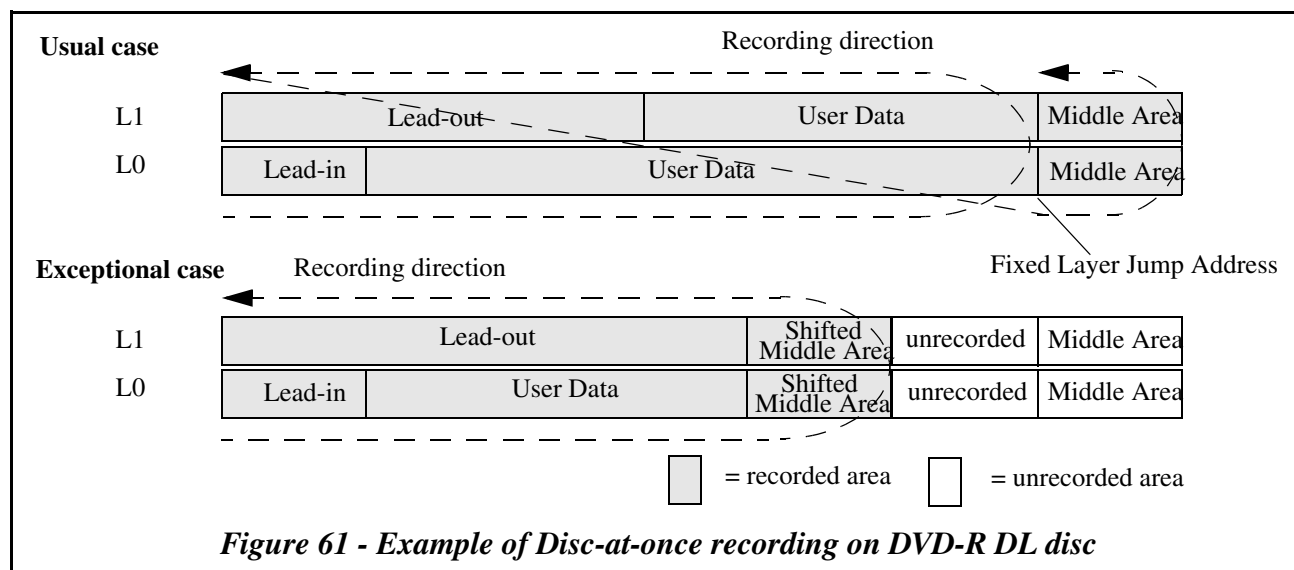
4.18.4 Recording mode for DVD-R DL media

DVD-R DL media makes use of sequential recording as well as Single Layer discs. DVD-R DL media supports three kind of recording modes. They are Disc-at-Once (DAO) recording, Incremental recording, and Layer Jump recording. Once a recording mode is determined, the recording mode *shall* not be changed afterwards.

4.18.4.1 DAO recording

DAO recording is supported by DVD-R DL media by using Format 1 RMD. Lead-in through Lead-out is recorded in one recording action. The Middle Area on L0 and L1 may be recorded after Lead-out is written. The Layer Jump Address is fixed location and is not changeable.

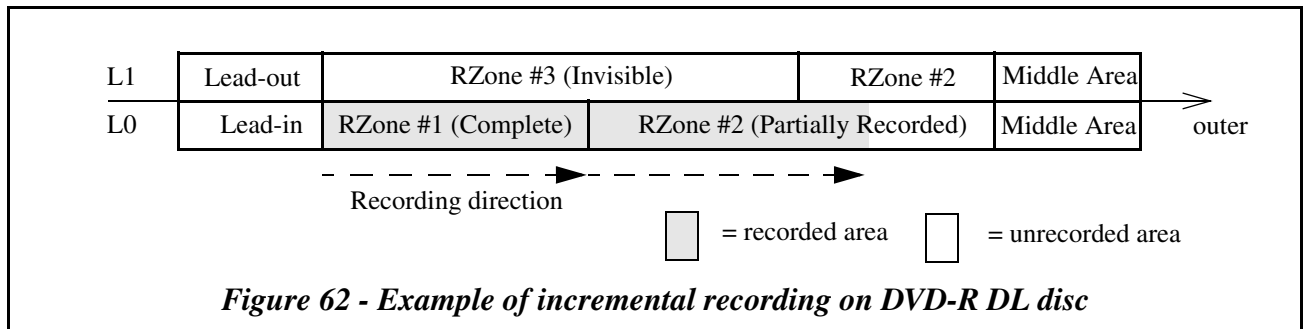
When DAO recording is used, all unrecorded user Data *shall* be recorded. When the amount of user data to be recorded is less than the capacity of L0, the Shifted Middle Area may be used as an exceptional case. See Figure 61.



4.18.4.2 Incremental recording

Incremental recording is supported by DVD-R DL media by using Format 1 RMD. The RZone reservation scheme is same as the Single Layer disc case. See Figure 62. The multi-Border recording is not defined for incremental recording because Border Zone is meaningless in terms of interchangeability between DVD-R DL logical units and DVD read-only logical units.

When the disc is finalized, all unrecorded user Data Area *shall* be recorded to make the disc readable by DVD read-only logical units. However, if no RZone is reserved in L1 and no user data is recorded in L1, the Shifted Middle Area may be used as an exceptional case at disc final closure. See Figure 92 - *Disc final closure in Incremental recording mode* on page 206.



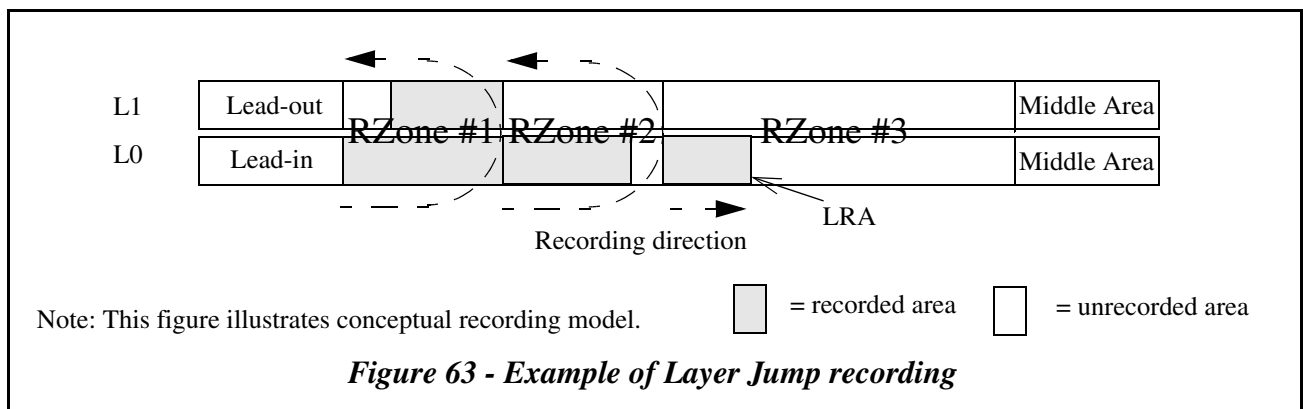
4.18.4.3 Layer Jump recording

Layer Jump recording allows to set Layer Jump Address to record both Layers alternately. The symmetrical L1 part can be recorded after the portion of L0 is recorded. This allows quick closing of the disc with Border Zone for DVD read-only logical unit compatibility. Data can be added after closed border. The Layer Jump recording uses Format 4 RMD. The RZone usage is different from the other recording modes.

Layer Jump recording allows to set several Layer Jump Address including Reserved RZone at any position to record both Layers alternately. The symmetrical L1 part can be recorded after the portion of L0 is recorded. This allows quick closing of the disc with Border Zone for DVD read-only logical unit compatibility. Data can be added after closed border. The Layer Jump recording uses Format 4 RMD. The RZone usage is different from the other recording modes.

Note: DVD-R Dual Layer Book has no definition of Layer Jump recording mode explicitly. When the Disc status field of Format 4 RMD Field 0 is set to 02h = "Incremental recording", the disc is regarded as Layer Jump recording mode described in this specification.

An example of Layer Jump recording is illustrated in Figure 63. The detail of Layer Jump recording and related issues are described in the following sections.



4.18.4.4 Comparison chart among recording modes

Table 69 is the comparison chart of capability of DVD-R DL disc.

Table 69 - Comparison of recording mode

Associated capability Recording mode	Recording order management	Recording Area	Quick disc closing ^a	Multi-Border recording ^b
Disc-at-Once (Figure 61)	no need to care	contiguous entire disc (single RZone)	no	no
Incremental (Figure 62)	application responsibility ^c	contiguous in RZone (multiple RZones)	no	no
Layer Jump (Figure 63)	logical unit responsibility	Not contiguous, divided by Layer Jump Address ^d	yes	yes

a. See 4.18.5.7, "Disc final closure" on page 205.

b. Data Appendability after disc becomes ROM compatible. See 4.18.5.5, "Border Zone for DVD-R DL media" on page 197.

c. When the application uses multiple of open RZones (NWAs), recording order of Layers should be considered. See 4.18.7.3, "Recommendation for multiple open RZone recording" on page 222.

d. When the application uses Layer Jump recording, the Layer Jump Address should be considered. See 4.18.5.1, "Recording unit" on page 174.

4.18.5 DVD-R DL Layer Jump Recording

4.18.5.1 Recording unit

RZone is defined to manage recordable data area and recorded data area on DVD-R disc. This is very similar to Track of CD-R disc. An RZone may have recorded part, recordable part and NWA. In the case of DAO recording or Incremental recording mode on DVD-R DL disc, the usage of the RZone is same as that of DVD-R Single Layer discs (i.e., the RZone is specified by the start LBA, contiguous length and Last Recorded Address). In the case of Layer Jump recording of DVD-R DL disc, the usage and geometric definition of the RZone are different from the case of DAO recording and Incremental recording mode (i.e., the RZone is specified by the start LBA, end LBA, Last Recorded Address and Layer Jump Address). On Layer Jump recording mode, a Reserved RZone is used to manage the recording sequence of the Layer jump recording. In addition, the Layer Jump Block (LJB) is newly defined to manage the recording sequence of the Layer Jump recording in a subdivision of the Invisible/Incomplete RZone. A Reserved RZone is considered to have one LJB.

4.18.5.1.1 Blank disc parameters

Table 70 shows fields of commands that returns blank disc parameters.

Table 70 - Blank disc parameters and related commands in Layer Jump recording mode

Disc parameter to be returned	READ TRACK INFORMATION command ^a	READ DISC STRUCTURE command
Start LBA on L0	Track Start Address field	Starting Physical Sector Number of Data Area field of Physical Format Information of Control Data Zone in the Lead-in (Format Code = 10h)
End LBA on L0	Next Layer Jump Address field	L0 Data Area Capacity field of Layer Boundary Information (Format Code = 20h)
End LBA on L1	Track Size / RZone End Address field	End Sector Number in L0 field of Physical Format Information of Control Data Zone in the Lead-in (Format Code = 10h)

a. RZone number is set to 1. The Write Type field of Write Parameters mode page is set to 04h (Layer Jump).

4.18.5.1.2 Reserved RZone structure

An RZone of Layer Jump recording mode may have two separated recording parts on L0 and L1. The RZone can be written sequentially from the beginning of L0 part through the end of L1 part of the RZone via the Layer Jump Address. When an RZone is reserved, a host is able to recognize the geometric structure of the Reserved RZone as four parameters returned by the READ TRACK INFORMATION command. Those are the Track Start Address field (to indicate the Start LBA of Figure 64), the Next Layer Jump Address field or the Last Layer Jump Address field (LJA), the Last Recorded Address field (LRA) and the Track Size / RZone End Address field (End LBA). The Last Layer Jump Address field reports the last Layer Jump Address on L0 (from L0 to L1). This field does not report the Layer Jump Address on L1 (from L1 to L0). See Figure 65. In case of Layer Jump recording, the LJRS field of a Reserved RZone is set to 01b and the Track Size / RZone End Address field reports the end LBA of the RZone. The LJA and End LBA are the LBA of the end sector of an ECC block. See Figure 64. Table 71 explains the relationship between these fields and fields of Format 4 RMD on the disc for logical unit implementation.

Table 71 - Reserved RZone parameters

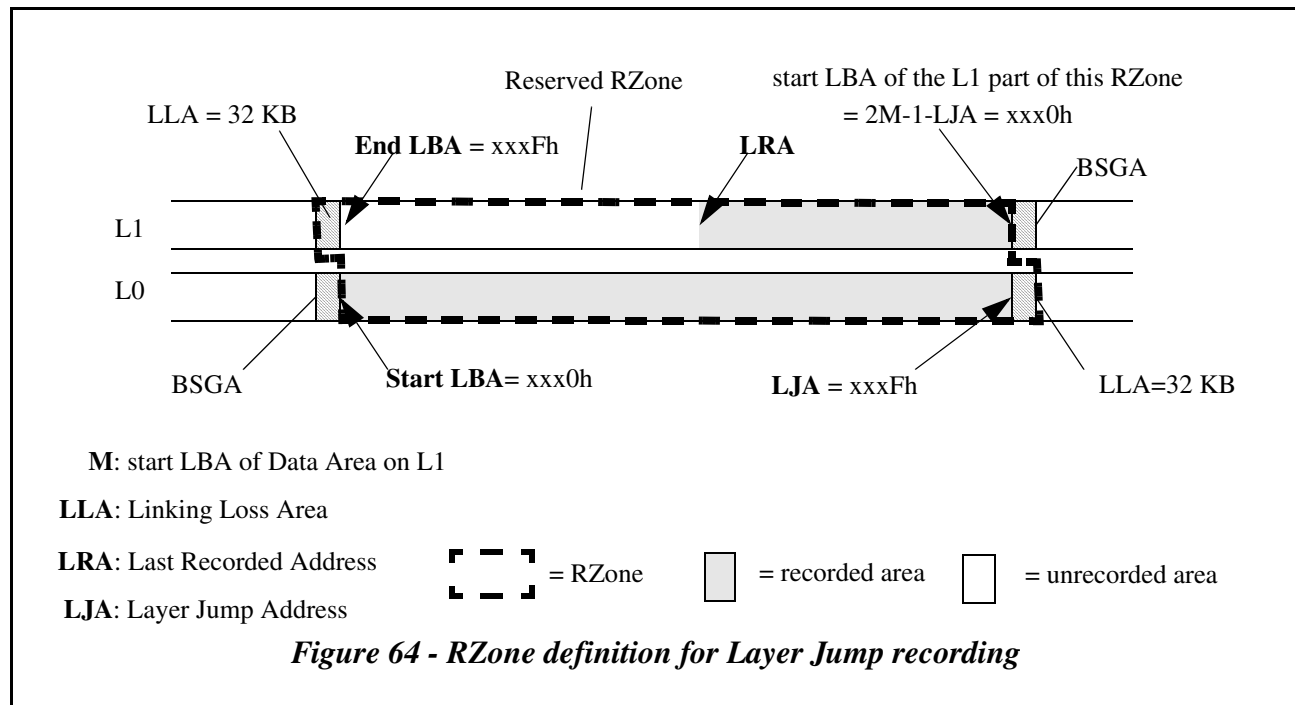
RZone parameter of Figure 64	READ TRACK INFORMATION command	Format 4 RMD - Field 4 (RZone Information)
Start LBA	Track Start Address	Start sector number of RZone #1
LJA	Next Layer Jump Address or Last Layer Jump Address	Layer Jump Address of RZone #1
LRA	Last Recorded Address	Last recorded address of RZone #1
End LBA	Track Size / RZone End Address	End sector number of RZone #1

Either one of the Next Layer Jump Address field or the Last Layer Jump Address field specifies the LJA of the Reserved RZone if the RZone has L1 part. Otherwise, both fields are set to zero. In Layer Jump recording mode, when the NWA is located on L1 in an Reserved RZone, the Last Layer Jump Address field reports the Layer Jump Address of the Reserved RZone and the Next Layer Jump Address field reports zero. When the NWA is located on L0 in an Reserved RZone, the Next Layer Jump Address field reports the Layer Jump Address of the Reserved RZone and the Last Layer Jump Address field reports zero. When a Reserved RZone is closed, the Next Layer Jump Address field *shall* report zero. And if the closed RZone has L1 part, the Last Layer Jump Address field *shall* report the outermost LBA on L0 in the closed RZone. If the closed RZone does not have L1 part, the Last Layer Jump Address field *shall* report zero.

Layer Jump Address of the Reserved RZone regardless of the location of the LRA to show the geometric structure of the RZone.

The Link Size field of Write Parameters mode page should be set to 32 KB during Layer Jump recording for easy implementation.

The Linking Loss Areas (LLA) located at the each end of Reserved RZone boundary on L0 and L1 are 32 KB in size even if the Link Size is set to 2 KB. See Figure 64.



4.18.5.1.3 LJB structure of Invisible/Incomplete RZone

In case of Invisible/Incomplete RZone, the LJB is defined as minimum recording region. Invisible/Incomplete RZone may be recorded as multiple of LJBs. If the RZone does not have L1 part, LJB cannot be assigned to the RZone.

An LJB is defined by the Next Layer Jump Address field, the Last Layer Jump Address field and the Last Recorded Address field of READ TRACK INFORMATION command. Only one active LJB that has NWA is reported. In case of Figure 65, parameters of LJB #4 are reported. The Next Layer Jump Address field *shall* be actual logical block address of the sector that will cause Layer Jump at write. When an NWA is located on L1 in the last LJB, no more Layer jump will occur and the Next Layer Jump Address field reports zero. In this case, the host should calculate the end address of data recordable area in the last LJB by using free blocks information and NWA information returned by the READ TRACK INFORMATION command.

When the NWA is located on L0, the Last Layer Jump Address field reports the Layer Jump Address on L0 that was used in the previous LJB. If the previous LJB does not exist in the RZone, this field is set to zero. When an Incomplete RZone is closed, the Next Layer Jump Address field of the closed RZone *shall* report zero. And if the closed RZone has L1 part, the Last Layer Jump Address field *shall* report the outermost LBA on L0 in the closed RZone regardless of the location of the LRA to show the geometric structure of the closed RZone. If the closed RZone does not have L1 part, the Last Layer Jump Address field *shall* report zero.

The LLA (Linking Loss Area) of LJB on L0 can be 2 KB in size (one sector). BSGA of LJB is 32 KB in size (16 sectors).

In case of Regular Interval Layer Jump recording, Invisible/Incomplete RZone is divided into many LJBs. See 4.18.5.3.3, "Regular Interval Layer Jump" on page 187.

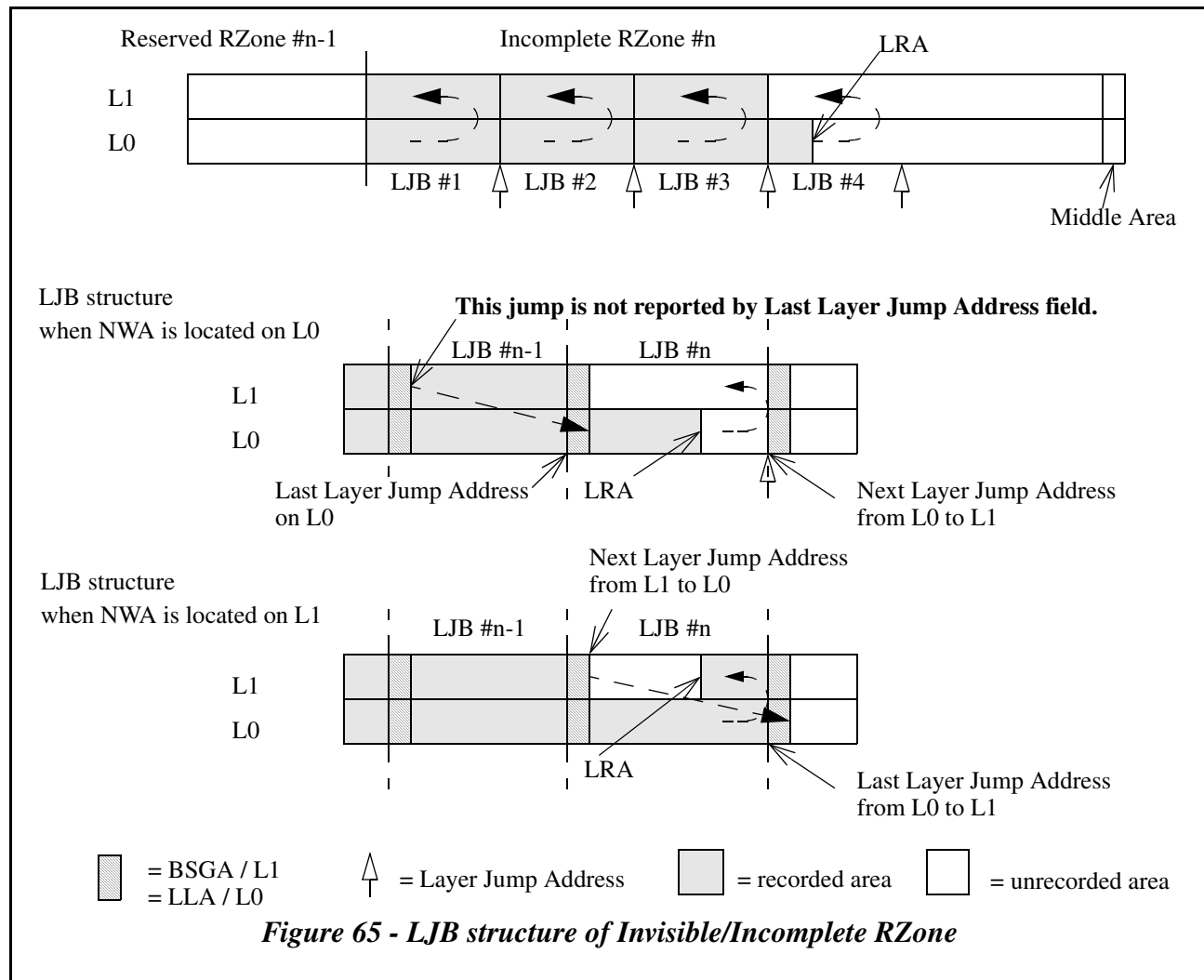


Table 72 explains the relationship of the values in the fields of READ TRACK INFORMATION command and the related fields of Format 4 RMD of the disc for logical unit implementation.

Table 72 - Invisible/Incomplete RZone parameters

READ TRACK INFORMATION command	Format 4 RMD - Field 4 (RZone Information)
Track Start Address	Start Sector Number of Invisible RZone
Last Recorded Address	Last recorded address of Invisible RZone
Track Size / RZone End Address	End sector number of Invisible RZone
LJRS field ^a	Jump interval
When NWA is on L0	
Next Layer Jump Address ^b	Layer Jump Address of Invisible RZone ^c
Last Layer Jump Address	Previous Layer Jump Address of Invisible RZone
When NWA is on L1	
Next Layer Jump Address	Previous Layer Jump Address of Invisible RZone ^d
Last Layer Jump Address ^b	Layer Jump Address of Invisible RZone

- a. READ DISC STRUCTURE command with Format Code=22h (Jump Interval) reports this information in case of Regular Interval Layer Jump recording mode (4.18.5.3.3, on page 187).
- b. This field reports either one of Layer Jump Addresses that is caused by Shifted Middle Area or Fixed Middle Area if the Layer Jump Address of Invisible RZone is set to zero.
- c. READ DISC STRUCTURE command with Format Code=23h (Manual Layer Jump Address) reports this information in case of Manual Layer Jump recording mode (See 4.18.5.3.2, on page 184).
- d. The value of the Next Layer Jump Address field is calculated from the value of the Previous Layer Jump Address of Invisible RZone field. See “LJB structure when NWA on L1” of Figure 65.

When RMD is written to the disc, these parameters of RMD *shall* be updated correctly as shown in Table 72.

4.18.5.1.4 Consideration of NWA check in logical unit

This subsection describes two typical examples of NWA recovery method in an LJB when RMD is not updated in appropriate timing.

During a recording, RMD may not be updated in appropriate timing by some reason. See Table 96 - *Mandatory RMD update condition in RMA* on page 221. If NWA is not found on the Layer specified by the LRA field of RMD, the logical unit may check another Layer from inverted physical sector address of Layer Jump Address for opposite direction.

In the case of “LJB structure when NWA is located on L0” of Figure 65, when the new RMD that shows LJB#n was not recorded by some reason, the last RMD should have the information of the previous recorded LJB. When the LRA shows the address of L1 in LJB#n-1, the logical unit finds no NWA on L1. The logical unit may check L0 from the Layer Jump Address of Invisible RZone to find correct NWA in LJB#n.

In the case of “LJB structure when NWA is located on L1” of Figure 65, when LRA of LJB#n shows the address of L0, the logical unit finds no NWA on L0 in LJB#n. The logical unit may check L1 from inverted physical address of Layer Jump Address of Invisible RZone to find correct NWA in LJB#n.

4.18.5.2 RZone reservation

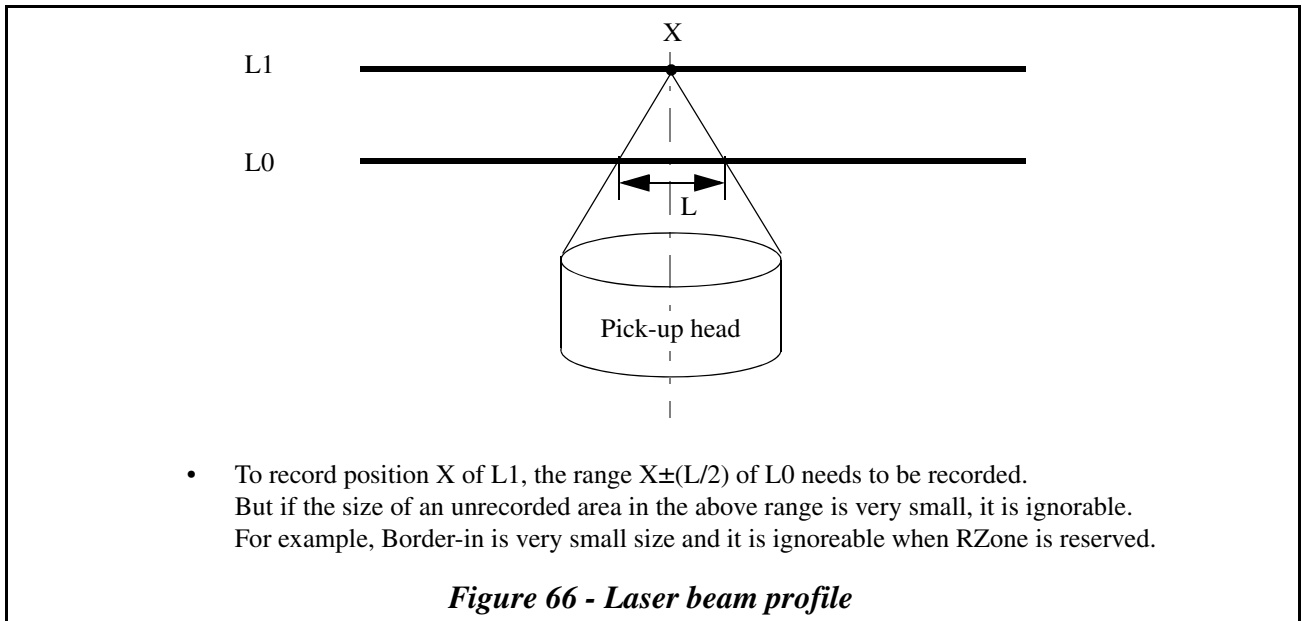
An RZone can be reserved with host specified amount of size. The reserved size on L0 and L1 may not be the same. RZone is reserved with various physical shapes depending on the condition such as its size and recording status of the previous RZone.

4.18.5.2.1 Restrictions of physical assignment rule of RZone with Format 4 RMD

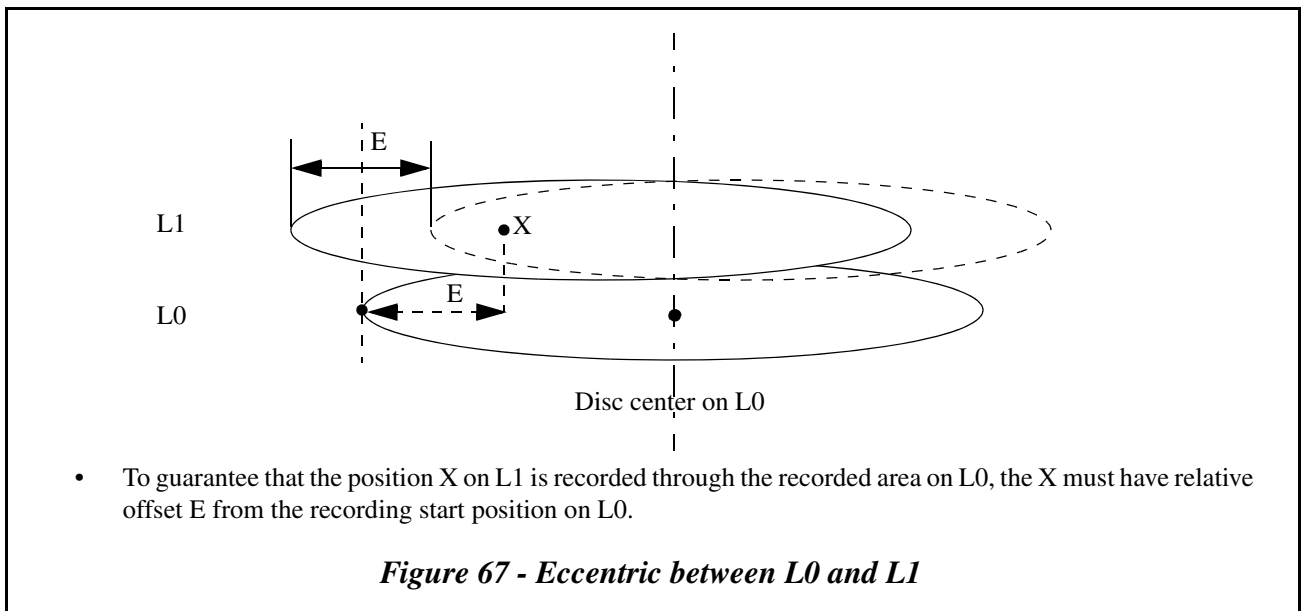
To keep the recording order of L0 and L1, a gap may be allocated between L1 part of RZones due to several physical factors. Therefore, when Layer Jump recording is used with RZone reservation, full disc capacity may not be available. Disc manufacturer and logical unit control these physical factors and restrictions.

There are several factors for the necessity of gap in between RZones.

- Laser beam profile
When the laser is focused on L1, the beam penetrates L0 with some amount of range. This range *shall* be recorded prior to recording of the L1.

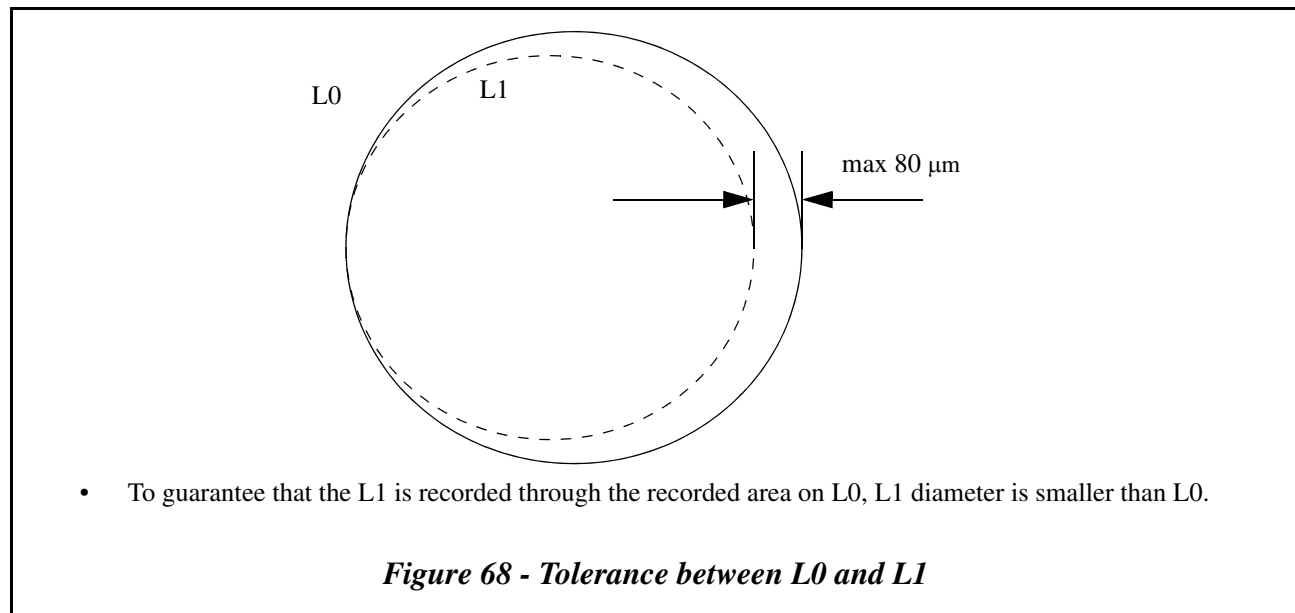


- Eccentric (Radial run-out) between L0 and L1
When an RZone is reserved, the eccentric between L0 and L1 is considered to keep the recording order of Layer.



DVD-R DL Book specifies these factors and it is referred to as Physical Clearance in this document. The Physical Clearance is calculated as follows:

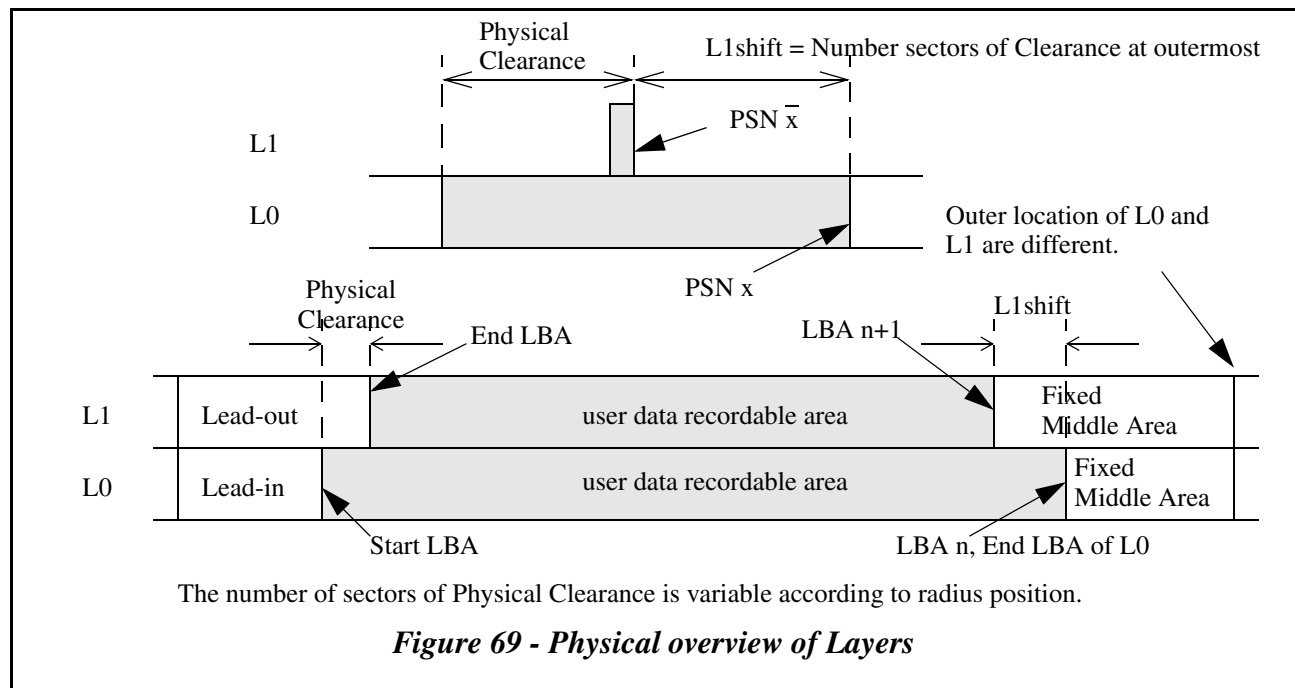
- Tolerance of diameter difference between L0 and L1
When L0 disc and L1 disc are build by injection molding, the diameter size difference between L0 and L1 is maximum 80 μm .



Physical Clearance = Half of laser beam diameter on L0 ($2/L$) - maximum ignoreable size of unrecorded area on L0 + Eccentric between L0 and L1 (E) + half of tolerance. It is approximately 105 μm width at outermost radius.

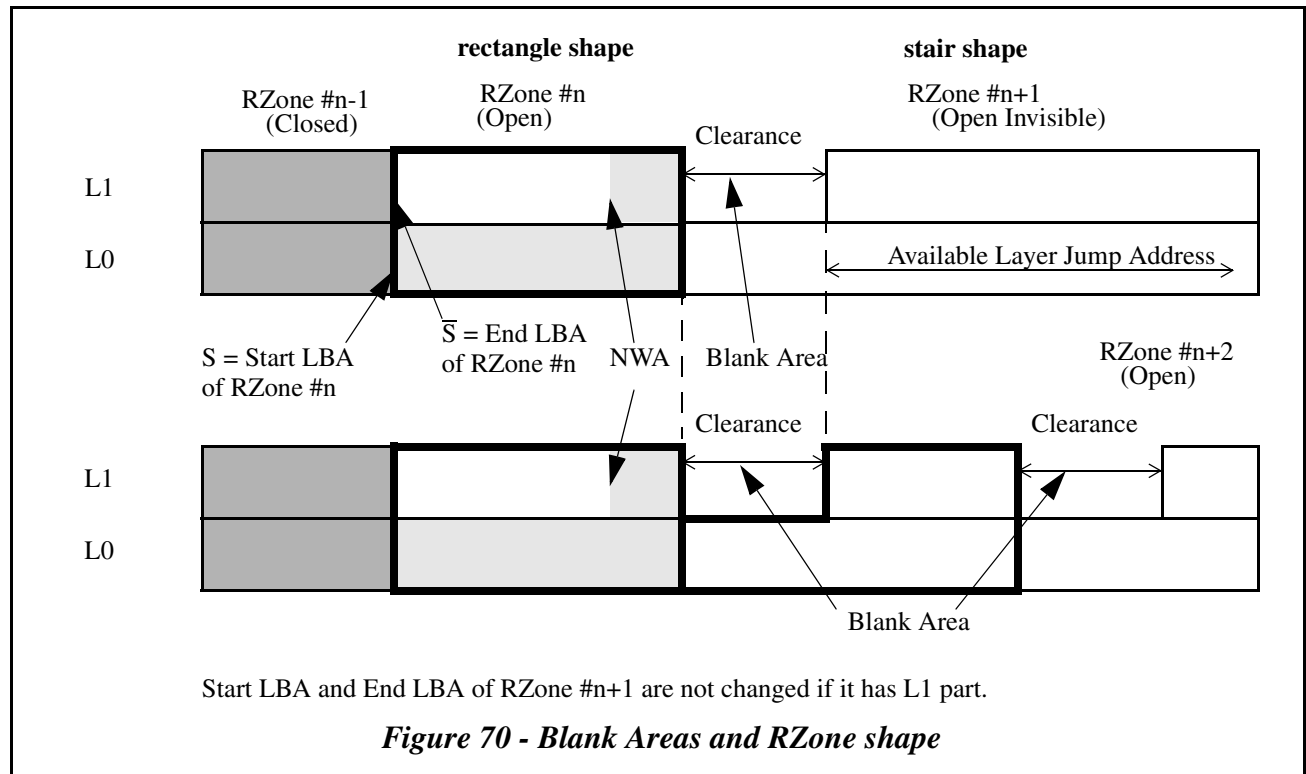
To write an ECC block on L1, minimally the Physical Clearance + L1shift size of L0 needs to be recorded as shown in Figure 69. As the result, DVD-R DL disc is designed and is made to keep L1 smaller than L0. Therefore the capacity of L1 is smaller than L0. The outermost location of Fixed Middle Area are different on L0 and L1. The length of the Fixed Middle Area on L0 is shorter than the length on the L1.

Hereafter, this document uses the term “Clearance” as the number of sectors that consists of Physical Clearance and L1Shift of Figure 69.



4.18.5.2.2 RZone shape and Blank Area

In case of Layer Jump recording, an RZone may have two recording parts on L0 and L1 as shown in Figure 64. If the previous RZone is not closed status, when new Invisible RZone is generated, an unusable area is allocated at the inner side of the Invisible RZone on L1 to keep the recording order between L0 and L1. This unusable area is referred to as Blank Area. The Blank Area will never be usable to record user data even if the previous RZone will become closed status. The length of a Blank Area is calculated by the Clearance.



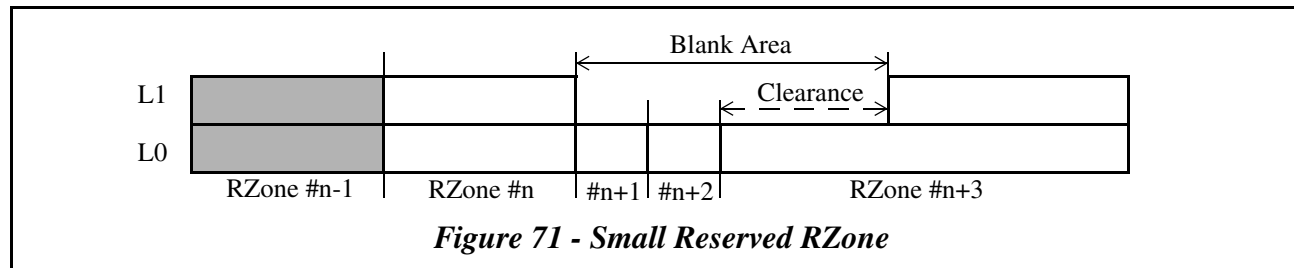
As a result, two Blank Areas that are not recordable for user data may be allocated at both sides of the Reserved RZone on L1. These Blank Areas are registered in RMD at RZone reservation and it will be padded by logical unit automatically if all RZones surrounding the Blank Area are closed. Because of the Blank Area, there are two types of Reserved RZone shape. One has a rectangle shape (e.g., RZone #n in Figure 70). The recording capacity of L0 and L1 are the same. Another has a shape like the stairs (e.g., RZone #n+1 in Figure 70). The recording capacity of L0 and L1 are different.

When previous part is Border Zone or when Incomplete RZone is closed then new Invisible RZone is made (e.g., RZone #n-1 in Figure 70), the next RZone (e.g., RZone #n in Figure 70) does not have Blank Area between previous part and the RZone. In this case, the Reserved RZone has even number of ECC blocks for free blocks. The number of free blocks on L0 part and L1 part are same.

Regardless of the recording status (recorded or not) of L0 of the previous RZone (e.g., RZone #n in Figure 70) when the previous RZone is open, the following new Reserved RZone (e.g., RZone #n+1 in Figure 70) **shall** have two Blank Areas that the size is Clearance on both sides if the new Reserved RZone has L1 part. In this case, the start LBA and the end LBA of RZone #n+1 **shall not** change. On the other hand, even if the previous RZone (e.g., RZone #n or #n+1 in Figure 70) is closed, the size of Blank Areas **shall not** change. These Blank Areas **shall** be padded by logical unit at least when the Bordered Area is closed. When a Blank Area is padded, the registration entry of the Blank Area in RMD **shall** be updated. Maximum eight Blank Areas can be registered in RMD.

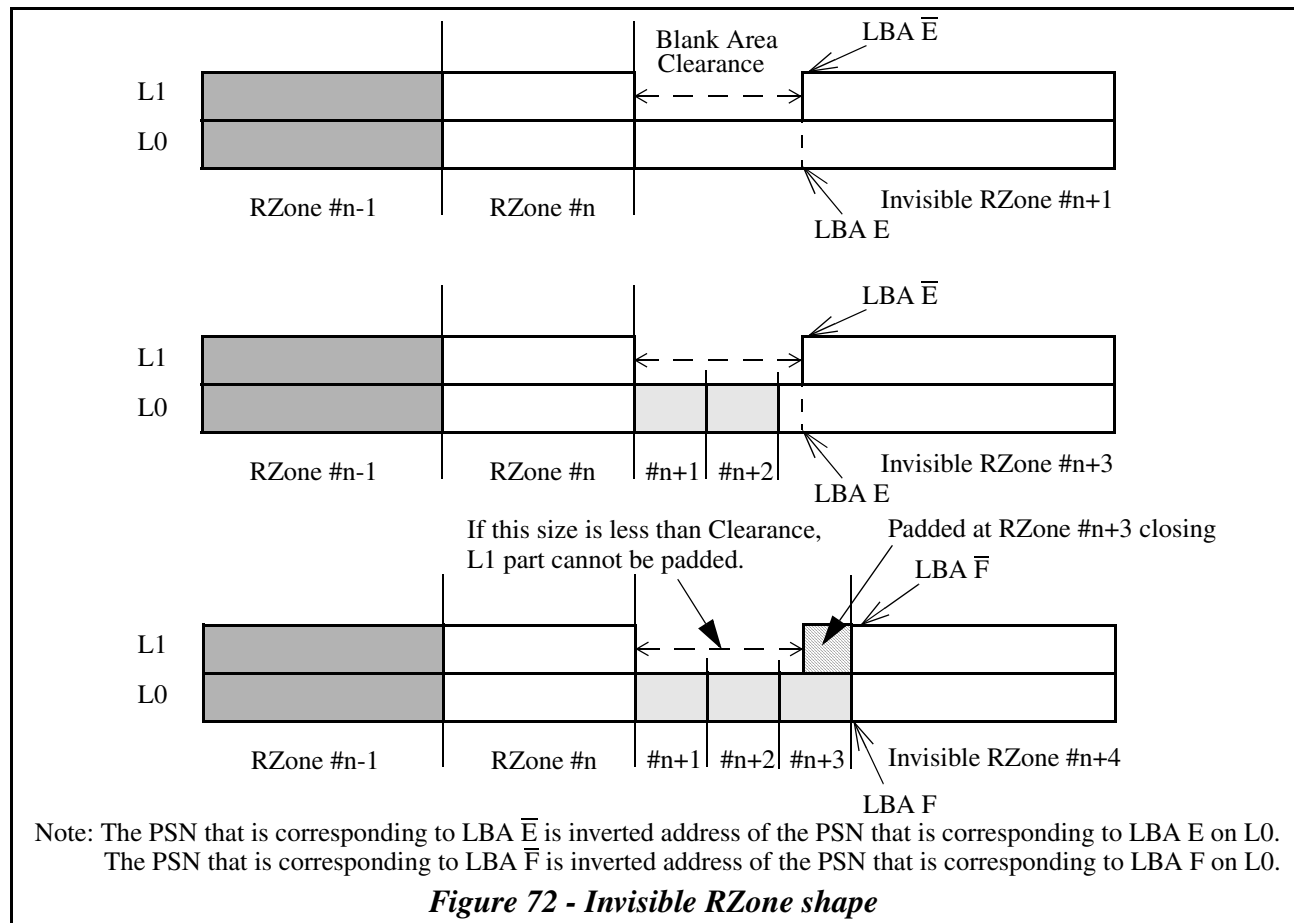
When the size of a Reserved RZone is smaller than the Clearance size (e.g., RZone #n+1 and #n+2 in Figure 71), the Reserved RZone does not have recordable part on L1 and it exists on L0 only. This is the exceptional case of the stair-shape Reserved RZone. In case of Figure 71, the Layer Jump Address of RZone #n+1/#n+2 field of Format 4 RMD

Field 4 is set to zero. The End PSN of new Invisible RZone (#n+3) *shall* move to keep Clearance from the last reserved RZone (#n+2). The Blank Area information registered in RMD starts from RZone number n+3 to RZone number n. The actual address range is from (End LBA of RZone #n+3) +17 to (RZone #n Layer Jump Address on L1)-1.

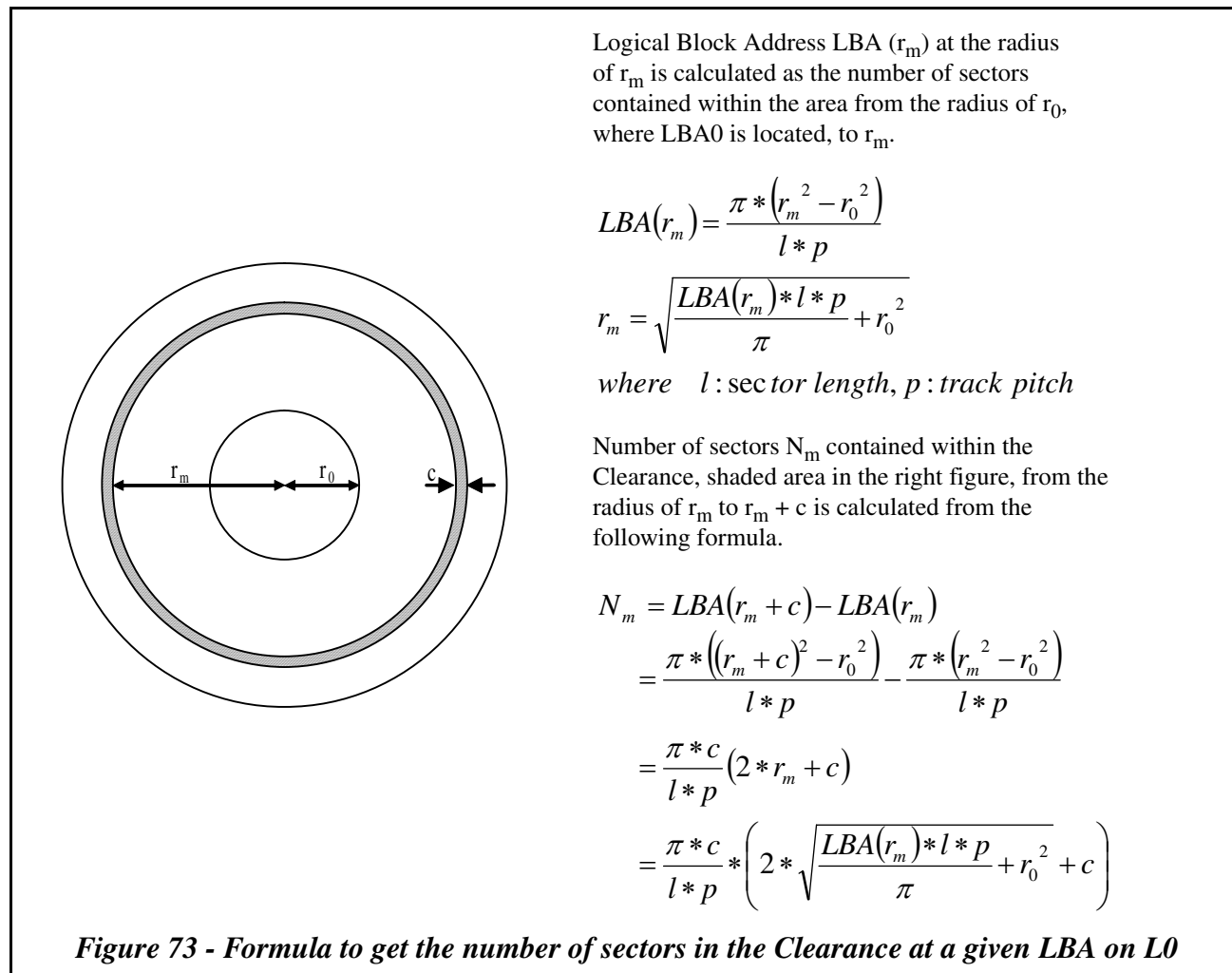


Even if the last RZone that is located just before Middle Area does not have recordable part on L1 due to Clearance, Blank Area is registered by the last RZone number.

When small part of Incomplete RZone is written and closed repeatedly (e.g., RZone #n+1 and #n+2 in Figure 72), the End LBA of new Invisible RZone does not move (e.g., RZone #n+3 in Figure 72). If NWA of the Incomplete RZone is located on L0 and larger than LBA E of Figure 72, when the Incomplete RZone (e.g., RZone #n+3 in Figure 72) is closed, the logical unit *shall* pad the area on L1 that is corresponding to the area on L0 between LBA E and NWA (= hatched area in Figure 72). And the End LBA of new Invisible RZone *shall* be set to the LBA on L1 (= LBA \bar{F} in Figure 72) that is corresponding to the Start LBA of new Invisible RZone (= LBA \bar{F} in Figure 72). See 4.18.5.4.2, "Closing of Invisible/Incomplete RZone" on page 193.



Note: The PSN that is corresponding to LBA \bar{E} is inverted address of the PSN that is corresponding to LBA E on L0. The PSN that is corresponding to LBA \bar{F} is inverted address of the PSN that is corresponding to LBA F on L0.



4.18.5.3 Layer Jump recording on Invisible/Incomplete RZone

Layer Jump recording allows recording on both Layers alternately. There are three methods to change the recording Layer.

- RZone reservation RESERVE TRACK command
- Manual Layer Jump SEND DISC STRUCTURE command, Manual Layer Jump Address (Format Code = 23h)
- Regular Interval Layer Jump SEND DISC STRUCTURE command, Jump Interval size (Format Code = 22h)

One of above three Layer Jump recording methods can be specified only when the RZone is Invisible state. To change the Layer Jump recording method of the Incomplete RZone, the RZone **shall** be closed and new Invisible RZone **shall** be created.

Only when DVD-R DL disc is empty state (Disc Status field in Disc Information Block data of READ DISC INFORMATION command is set to Empty Disc (00b)), the disc can be set to the Layer Jump recording mode by setting the Write Type field of Write Parameters mode page to 04h (= Layer Jump recording).

When the last RZone is Invisible RZone and neither the Manual Layer Jump Address nor Jump Interval size for Regular Interval Layer Jump recording is specified (LJRS=01b, RT=0, Blank=1, FP=0 in Track Information Block of READ TRACK INFORMATION command), the Next Layer Jump Address field shows the Layer Jump Address caused by Fixed Middle Area or Shifted Middle Area. In this condition, one of Layer Jump methods can be specified to the RZone. Even if Manual Layer Jump Address (Format Code = 23h) or Jump Interval size (Format Code = 22h) is specified by the

SEND DISC STRUCTURE command, the logical unit *shall not* register the address in RMD before actual data is written to the Invisible RZone.

When the LJRS is set to 11b (Regular Interval Layer Jump recording), the host should check the Jump Interval size by the READ DISC STRUCTURE command with Format Code = 22h to ensure the write performance of the recording application that requires specific data recording rate. If the Jump Interval size is not appropriate for the recording application, the host may close the Incomplete RZone to specify a new Jump Interval size.

It is recommended that logical unit should update RMD to register Layer Jump Address or Jump Interval size after a write command is issued and before user data of the write command is recorded on the disc. The SYNCHRONIZE CACHE (10) command may cause RMD update at each time. Therefore host should set Layer Jump Address or Jump Interval size at the beginning of data writing.

Note: When the data writing is started, the Jump Interval size cannot be set and changed until the Incomplete RZone is closed.

4.18.5.3.1 RZone reservation

Reservation of an RZone is valid only for Invisible RZone. When a Reserved RZone is created in Layer Jump recording mode, the Reserved RZone may have one Layer Jump Address as shown in Figure 64 - *RZone definition for Layer Jump recording* on page 176. After all part of L0 of the Reserved RZone is recorded, NWA moves to L1.

4.18.5.3.2 Manual Layer Jump

Manual Layer Jump method is valid only for Invisible/Incomplete RZone of Layer Jump recording mode.

The SEND DISC STRUCTURE command with Format Code = 23h is used to specify the Layer Jump Address on L0 to create writing address on L1 of Invisible/Incomplete RZone.

Only one Layer Jump Address can exist on Incomplete/Invisible RZone at any given time. After the Layer Jump has happened at the specified Layer Jump Address, a new Layer Jump Address can be specified. If a host tries to specify the Layer Jump Address when there is valid Layer Jump Address, the command *shall* be terminated with CHECK CONDITION status, 5/24/00 INVALID FIELD IN CDB. If a host tries to specify the Layer Jump Address when a data remains in the logical unit's write buffer, the command *shall* be terminated with CHECK CONDITION status, 5/2C/00 COMMAND SEQUENCE ERROR.

The Layer Jump address *shall* be the end sector address of an ECC block (xxxxFh) on L0. The range available for the Layer Jump Address in Incomplete RZone starts from the end LBA of the ECC block that contains NWA-1 on L0 and ends at the start LBA of Middle Area-17.

When the NWA is located on L1, the available address range for the Layer Jump Address starts from the end LBA of the ECC block that contains the previous Layer Jump Address + 32. The range available for the Layer Jump Address in Invisible RZone starts from the end LBA of the ECC block that contains NWA and ends at the start LBA of Middle Area-17. However, when a Layer Jump destination address on L1 is located in a Blank Area, the corresponding address on L0 is not available as a Layer Jump Address. For example in case of Figure 74, the L0 area under the Clearance of RZone #n+3 is not available for the Layer Jump Address. When Layer Jump is not available at the specified Layer Jump Address due to Clearance, the SEND DISC STRUCTURE command with Format Code = 23h *shall* be terminated with CHECK CONDITION status, 5/26/00 INVALID FIELD IN PARAMETER LIST.

When the start address of the Shifted Middle Area is specified by the SEND DISC STRUCTURE command with Format Code = 21h at the lower address than the Manual Layer Jump Address specified by the SEND DISC STRUCTURE command with Format Code = 23h, the Manual Layer Jump Address becomes invalid. See 4.18.5.6.5, "Disc-at-Once like way" on page 201 about the usage of the Shifted Middle Area.

When NWA reaches to the Layer Jump Address on L0, NWA moves from L0 to L1. When all recordable blocks on L1 are recorded, NWA moves from L1 to L0. NWA is discontinuous at the Layer Jump Address.

The Manual Layer Jump Address specified by a SEND DISC STRUCTURE command with Format Code = 23h is reported by the READ DISC STRUCTURE command with Format Code = 23h until the Layer Jump occurs at the specified address. The Next Layer Jump Address field of READ TRACK INFORMATION command *shall* report the same address if the Manual Layer Jump Address is the address where the next Layer Jump occurs. When no Layer Jump

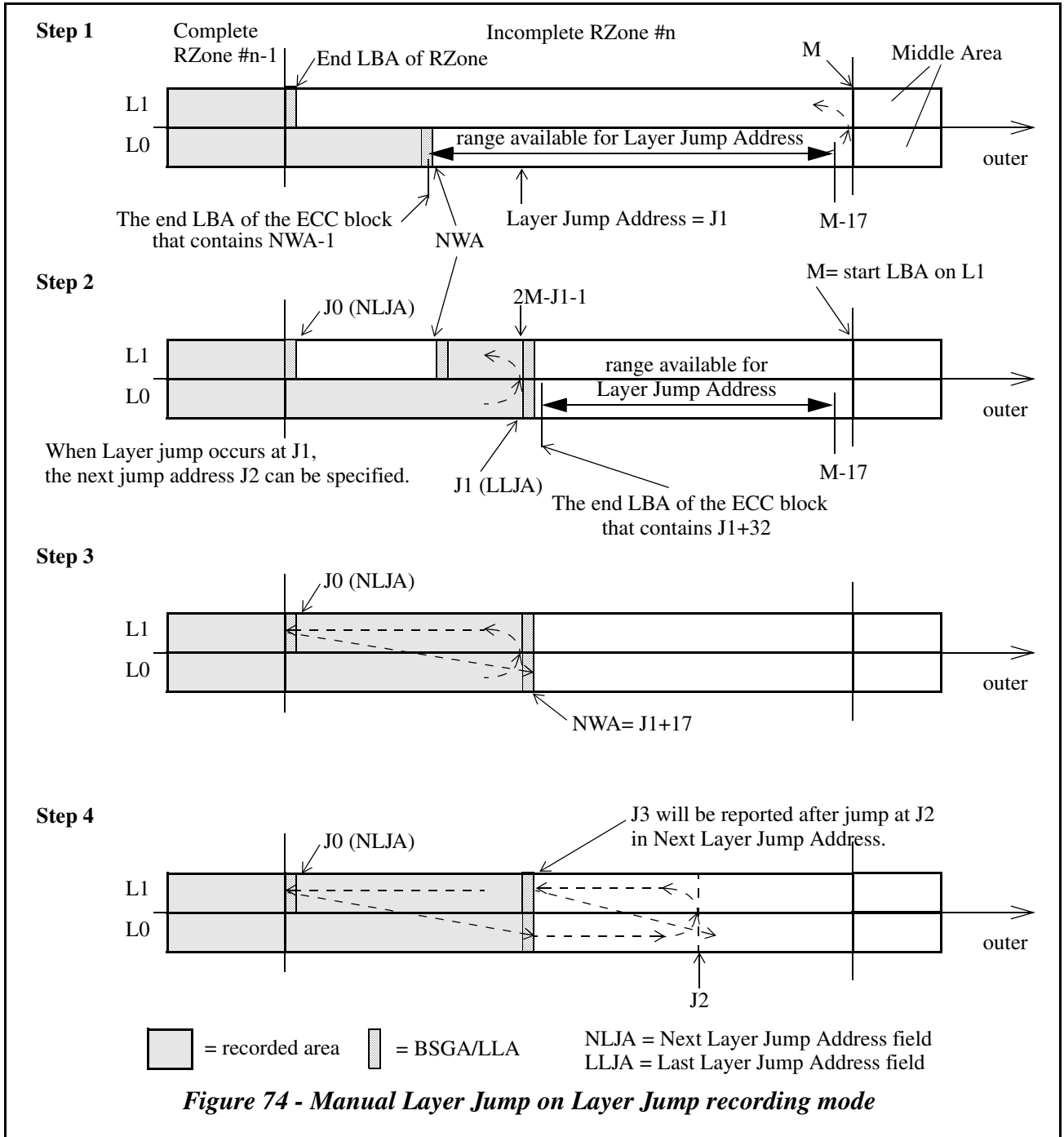
Address is specified by the SEND DISC STRUCTURE command with Format Code = 23h and the NWA of Invisible/Incomplete RZone is located on L0, the Next Layer Jump Address field reports Fixed or Shifted Middle Area start address -1 on L0. When Layer Jump from L0 to L1 has happened at Manual Layer Jump Address, the next Manual Layer Jump Address can be specified. And the Next Layer Jump Address field reports Layer Jump Address on L1.

Recording may be completed by repeating this Layer Jump operation. When a Layer Jump Address is specified, RMD is updated to register the Layer Jump Address when the LRA is located on L0.

Note: Too many Layer Jump operations may cause performance problem and RMA exhaustion problem.

Figure 74 is an example of Layer Jump recording.

- Initial state: No jump address is specified. The Next Layer Jump Address field = Fixed or Shifted Middle Area start address-1.
- Step 1: Jump address J1 is specified. The Next Layer Jump Address field = J1.
The READ DISC STRUCTURE command with Format Code = 23h (Manual Layer Jump Address) reports J1.
- Step 2: Layer Jump has happened at J1. The Next Layer Jump Address field = J0.
The READ DISC STRUCTURE command with Format Code = 23h reports zero.
New Layer Jump Address (J2) can be specified. The J2 *shall not* be registered in RMD during writing L1. If J2 is specified, the READ DISC STRUCTURE command with Format Code = 23h reports J2.
- Step 3: NWA moves to L0 again after writing J0. The Next Layer Jump Address field = Fixed or Shifted Middle Area start address-1 if J2 is not specified.
- Step 4: Jump address J2 is specified. The Next Layer Jump Address field = J2.
The READ DISC STRUCTURE command with Format Code = 23h reports J2.
- Future step: After NWA moves to L1, The Next Layer Jump Address field reports J3.
The READ DISC STRUCTURE command with Format Code = 23h reports zero until new Layer Jump Address is specified.



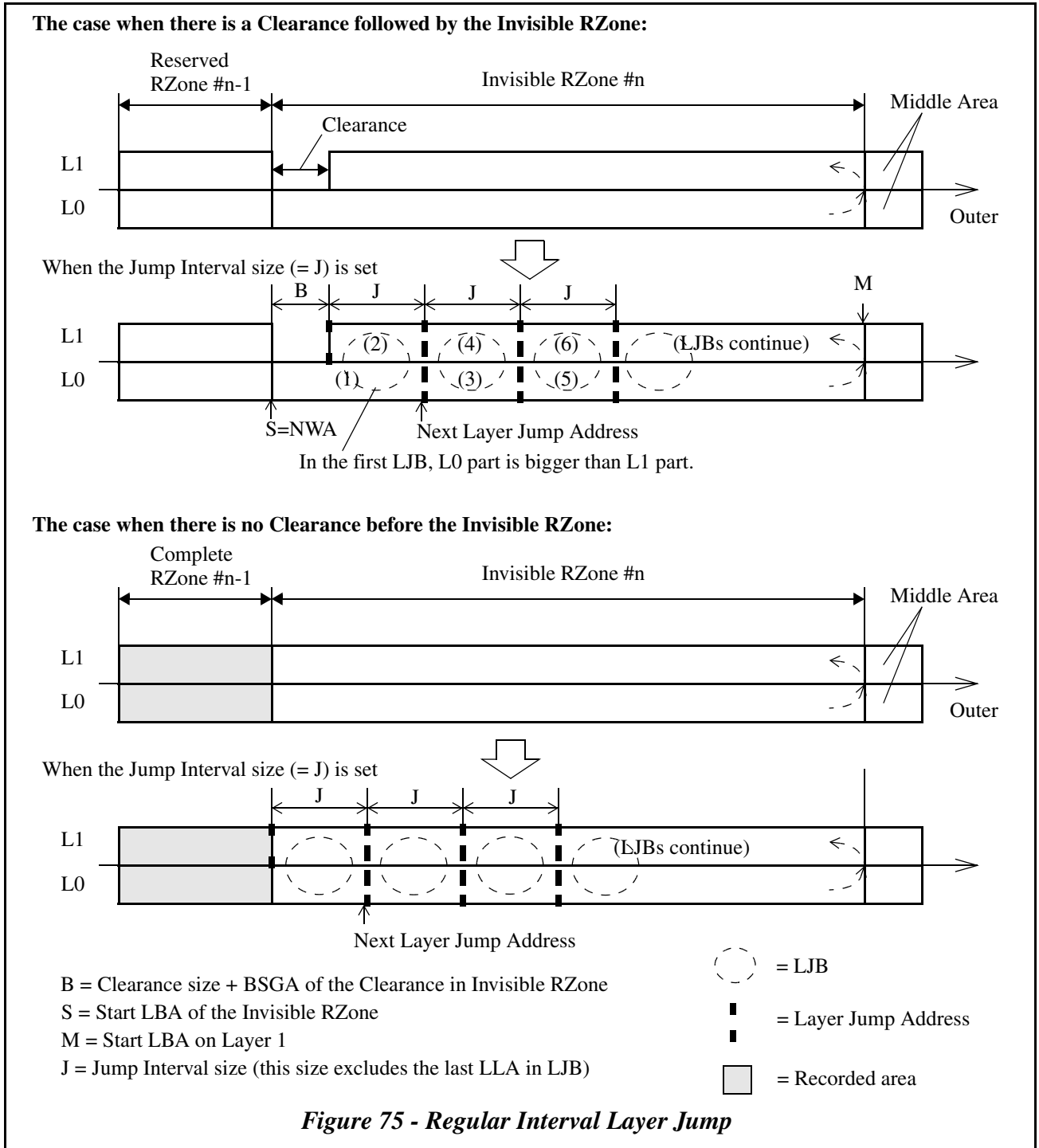
4.18.5.3.3 Regular Interval Layer Jump

Regular Interval Layer Jump method can be specified only when the RZone is Invisible state and no Manual Layer Jump Address is specified. When the last RZone is Invisible state, the Jump Interval size on L1 can be specified for the RZone by the SEND DISC STRUCTURE command with **Format Code = 22h**. The Jump Interval size does not contain Linking blocks such as BSGA. The Invisible RZone may be divided into many LJBs. See 4.18.5.1.3, on page 176.

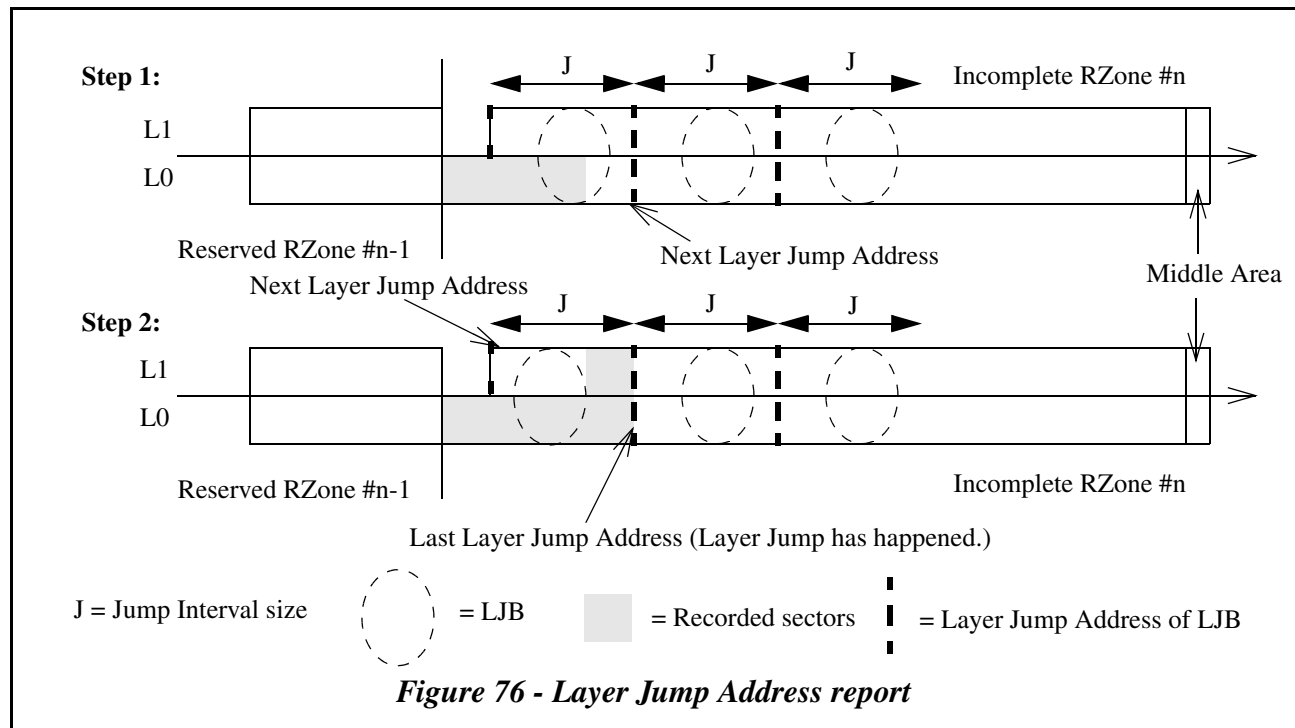
When the Invisible RZone is created and if the previous RZone is open Reserved RZone, a Blank Area is allocated on L1 between the Reserved RZone and the Invisible RZone. For such an Invisible RZone, the size of the L0 part of the first LJB is bigger than the size of its L1 part because of the Blank Area as shown in Figure 75.

The Jump Interval size of Incomplete RZone is not changeable. To change the Jump Interval size or to change the Layer Jump mode between Manual Layer Jump and Regular Interval Layer Jump, the Incomplete RZone **shall** be closed to create new Invisible RZone. When the Incomplete RZone is closed, the Regular Interval Layer Jump mode is cleared.

In case of DVD-R DL disc, the Jump Interval size **shall** be 512 ECC blocks (16 MB) or greater and 4 095 ECC blocks (127,9 MB) or smaller. If non-supported size is specified by the SEND DISC STRUCTURE command with **Format Code = 22h**, the command **shall** be terminated with CHECK CONDITION status, 5/26/00 INVALID FIELD IN PARAMETER LIST. Layer Jump action needs extra time against seek time in the same Layer. Layer Jump from L1 to L0 takes longer seek time than L0 to L1 due to OTP. The Jump Interval size should be appropriate size for the recording application if it requires specific data recording rate. Otherwise read operation (e.g., seamless playback) may be broken (e.g., pause of video or sound).



Before Jump Interval size is specified, the Next Layer Jump Address field of READ TRACK INFORMATION command reports the end LBA of L0. After the Jump Interval size is specified, the Next Layer Jump Address field reports the first Layer Jump Address of the first LJB in the Invisible RZone. When NWA is located on L0, the Next Layer Jump Address field *shall* report the Layer Jump Address on L0 of the current LJB (Step 1 of Figure 76). When a Layer Jump has happened and NWA is located on L1, the Next Layer Jump Address field *shall* report the Layer Jump Address on L1 of the current LJB in the Incomplete RZone (Step 2 of Figure 76).



4.18.5.3.4 Recordable area allocation of Regular Interval Layer Jump recording

Table 73 shows the start logical block address and the end logical block address of the each recording areas of LJBs in Figure 75 when 32 KB Linking Loss Area is used. This formula may be used to locate recording data to the recordable areas.

Table 73 - LBA range of user data recordable area in each LJB of Figure 75 (32 KB Link size)

Recording area	Start LBA	End LBA
(1)	S ^a	S+B+J-1
(2)	M ^b *2-S-B ^c -J	M*2-S-B-1
(3)	S+B+J ^d +16	S+B+J*2+15
(4)	M*2-S-B-J*2-16	M*2-S-B-J-17
(5)	S+B+J*2+32	S+B+J*3+31
(6)	M*2-S-B-J*3-32	M*2-S-B-J*2-33
:	:	:
(odd number area) ^e	S+B+(J+16)*(n ^f -1)	S+B+(J+16)*n-17
(even number area) ^g	M*2-S-B-(J+16)*p ^h +16	M*2-S-B-(J+16)*(p-1)-1

- a. S: start logical block address of the Invisible/Incomplete RZone
- b. M: start logical block address of the L1
- c. B: number of sectors of Clearance + BSGA of the Clearance located in the end of the Invisible RZone on L1.
(B=2M-S-1-End LBA of Invisible RZone)
- d. J: number of sectors of Jump Interval
- e. formula for the recording area with odd number shows the start/end LBA of recordable area in a LJB on L0.
The first LJB is not described by this formula.
- f. n is integer number larger than or equal to 2. When n=2, the corresponding recording area is (3), and when n=3, the corresponding recording area is (5) and so on.

- g. formula for the recording area with even number shows the start/end LBA of recordable area in a LJB on L1.
- h. p is integer number larger than or equal to 1. When p=1, the corresponding recording area is (2), and when p=2, the corresponding recording area is (4) and so on.

4.18.5.3.5 LRA of RZone and Closing of Bordered Area

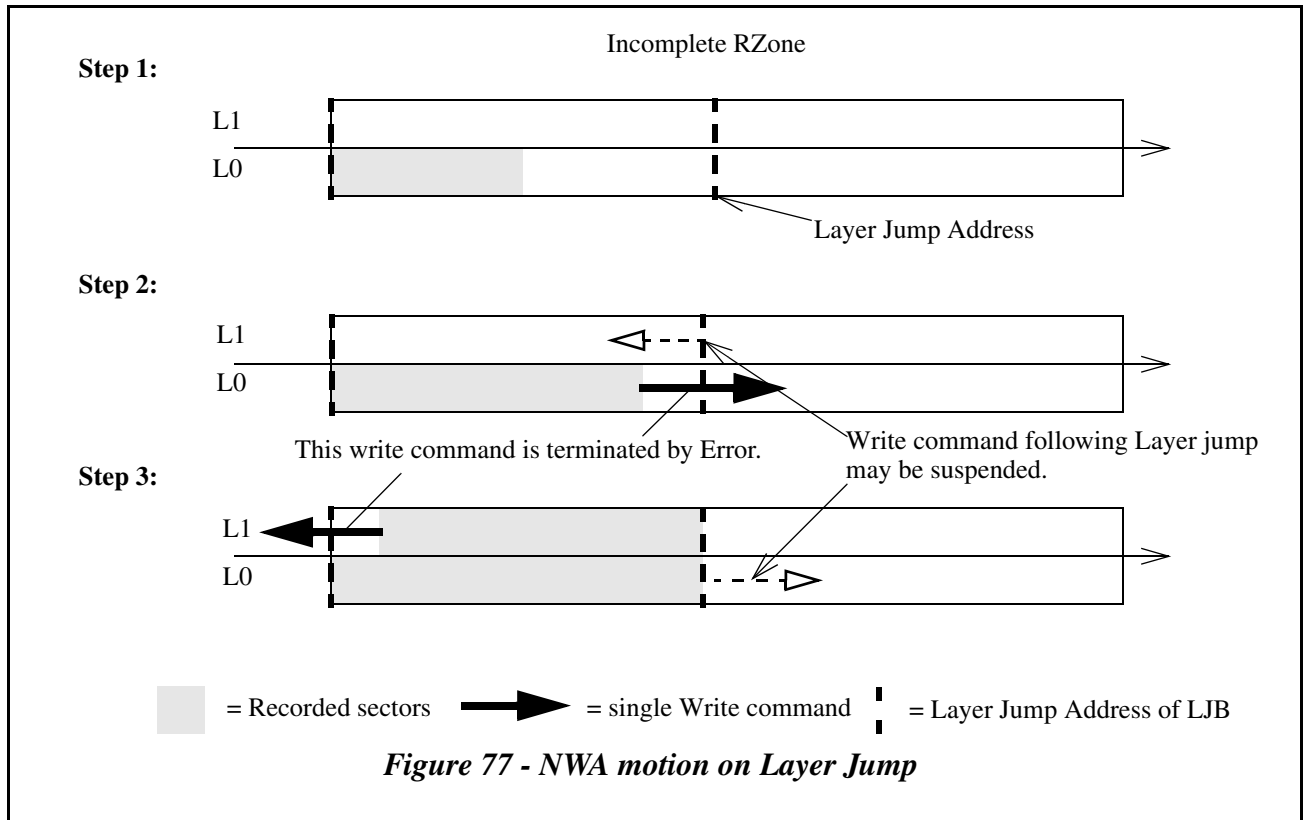
LRA of Incomplete RZone indicates the latest recorded user data address to identify NWA of the RZone. Therefore the LRA may not be the maximum recorded user data address of the Incomplete RZone during performing of the Layer Jump recording in the Incomplete RZone. The Maximum recorded PSN of the Data Area field of Table 36 - *Data Area Allocation field in R/RW-Physical format information Block* on page 104 **shall** contain the maximum recorded address of user data that may not be same as the LRA of the RZone that has the maximum recorded address. Therefore logical unit **shall** check the last ECC block of the Bordered Area to distinguish padding sectors in the ECC block (e.g., Figure 83 - *padding by SYNCHRONIZE CACHE (10) command* on page 196).

If there is no user data sector in the last ECC block of the Bordered Area, the RZone that contain the last ECC block of the Bordered Area is closed by the CLOSE TRACK/SESSION command. To distinguish whether the LRA is the maximum recorded user data address of the RZone, a logical unit should check the Data Type bit of last two ECC blocks. When the Data Type bit is set to one in the ECC blocks, the LRA is not the maximum recorded user data address and if the Data Type bit is set to zero, the LRA is the maximum recorded user data address.

4.18.5.3.6 NWA motion at Layer Jump

At Layer Jump Address, NWA moves from a Layer to the other Layer. Therefore NWA changes discontinuously except at the end LBA on L0. Host **shall** maintain NWA at Layer Jump Address to issue WRITE command. When single WRITE command exceeded Layer Jump Address other than the end LBA on L0, the WRITE command **shall** be terminated with CHECK CONDITION status, 5/21/03 INVALID WRITE CROSSING LAYER JUMP.

When logical unit begins recording on the other Layer including Layer change at Middle Area, the logical unit may suspend the following write command by CHECK CONDITION status, 2/04/08 LOGICAL UNIT NOT READY, LONG WRITE IN PROGRESS. It is because that logical unit may perform OPC for the new Layer. Some logical unit may not support multiple of writing address to store in buffer except Layer Jump Address. See Figure 77.



4.18.5.3.7 Layer Jump Address and BSGA/Linking Loss Area

In Incremental recording or DAO recording mode, when recording of L0 is finished, the next recording starts from the outermost data recordable area on L1. When the recording is continued without recording of Middle Area, the 32 KB Linking Loss Area is generated at the beginning of Middle Area on L0 and the BSGA *shall* be recorded at the end of the Middle Area on L1 prior to start writing the user data on L1.

During performing of Layer Jump recording in Incomplete RZone, the BSGA and Linking Loss Area *shall* be recorded and generated at the Layer Jump Address with the same manner. See Figure 78.

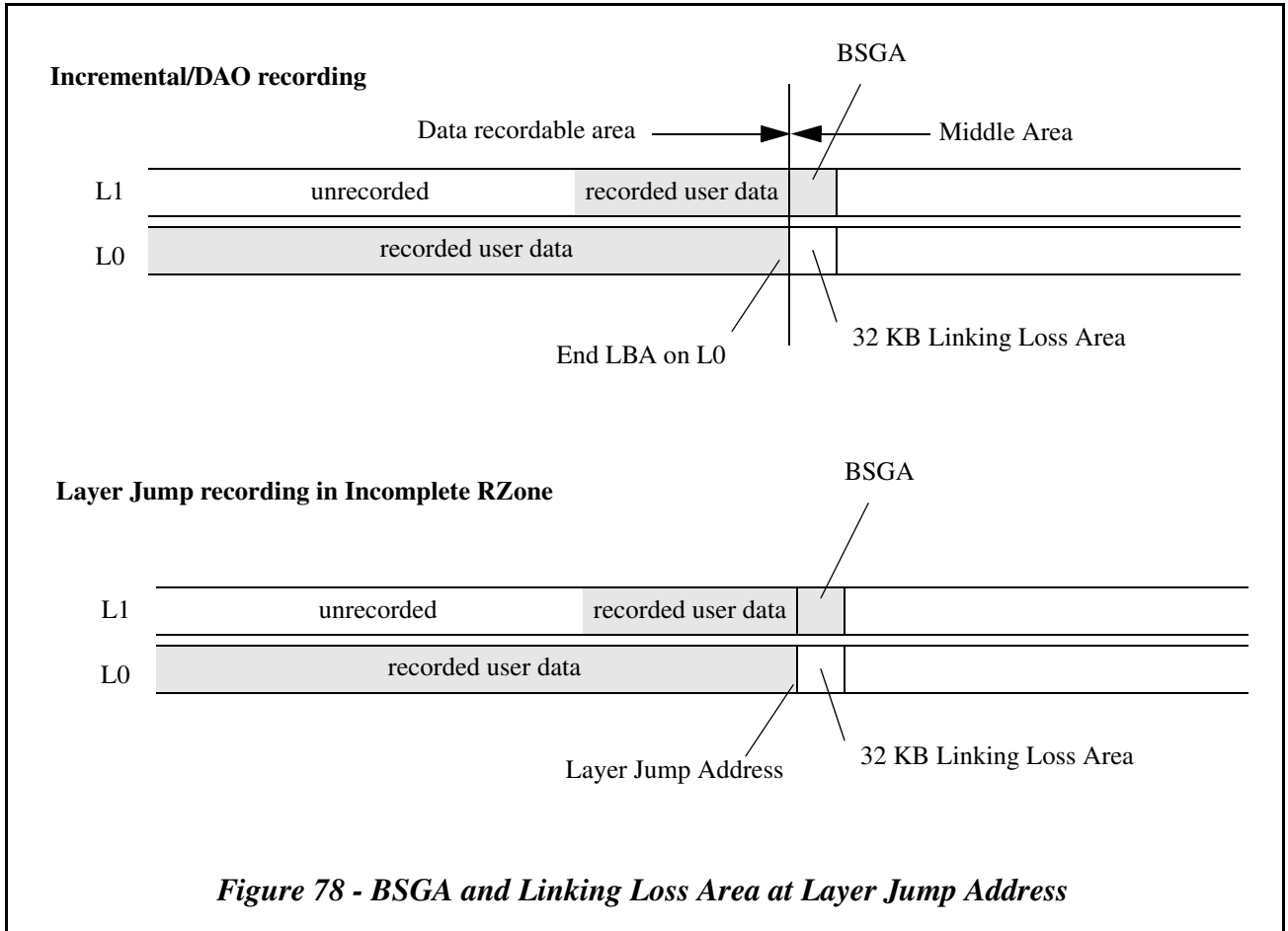


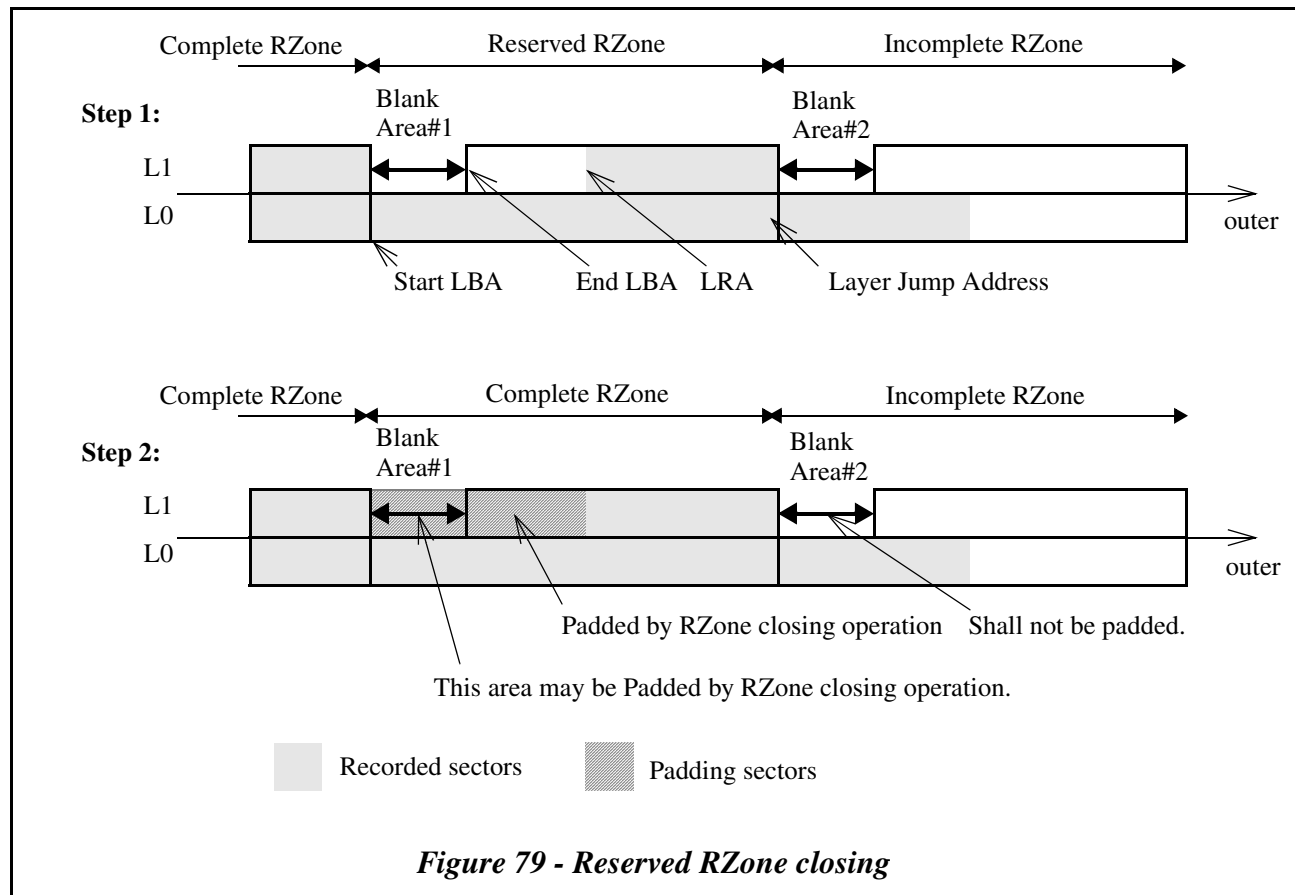
Figure 78 - BSGA and Linking Loss Area at Layer Jump Address

4.18.5.4 RZone Closing

When RZone is closed in Layer Jump recording mode, the Complete RZone is represented by four parameters like an Reserved RZone as shown in Figure 64.

4.18.5.4.1 Closing of Reserved RZone

Unrecorded blocks of an RZone *shall* be padded by the logical unit when the RZone is closed. The Blank Area between Complete RZone and the RZone to be closed may be padded during the RZone closing operation (e.g., Blank Area #1 in Figure 79). The Blank Area that is adjacent to a non-Complete RZone *shall not* be padded (e.g., Blank Area #2 in Figure 79).

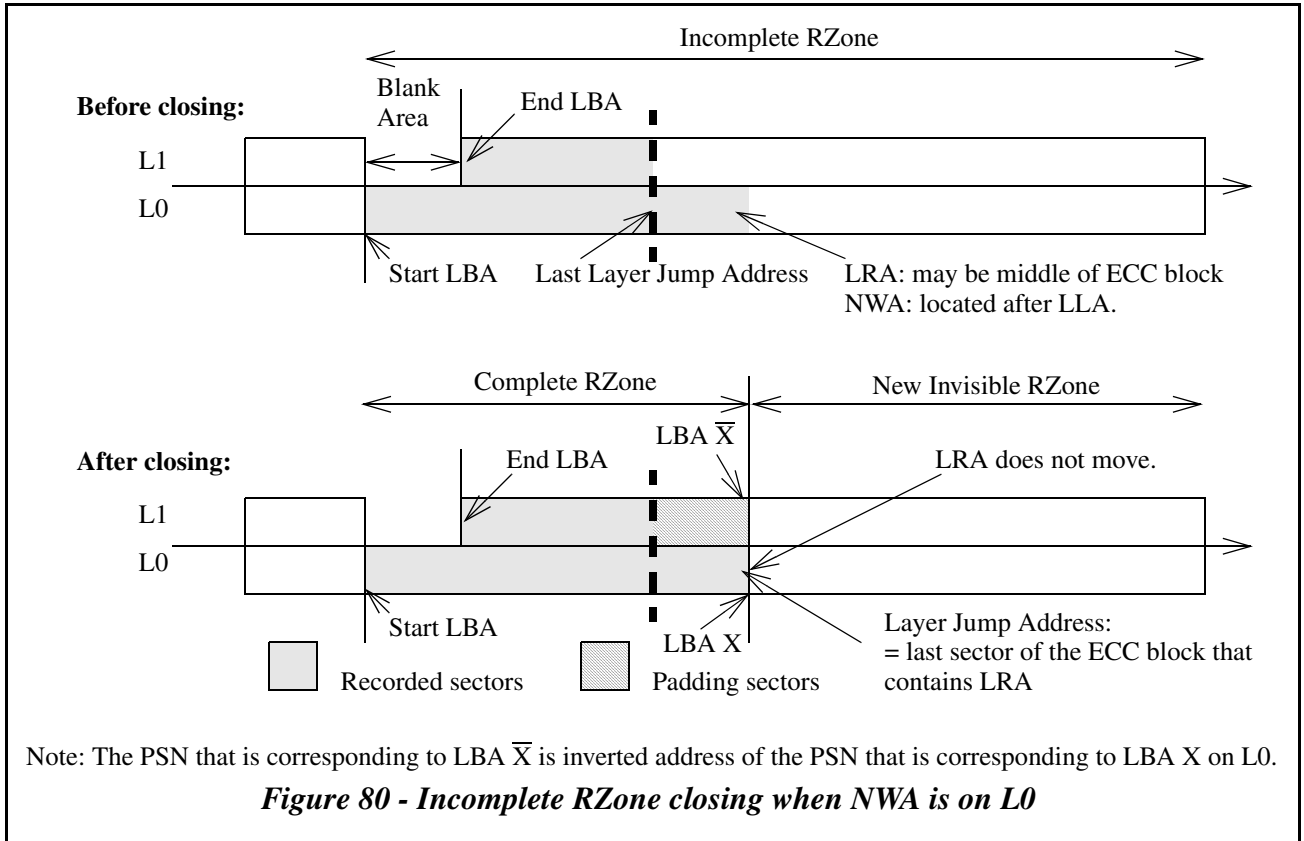


4.18.5.4.2 Closing of Invisible/Incomplete RZone

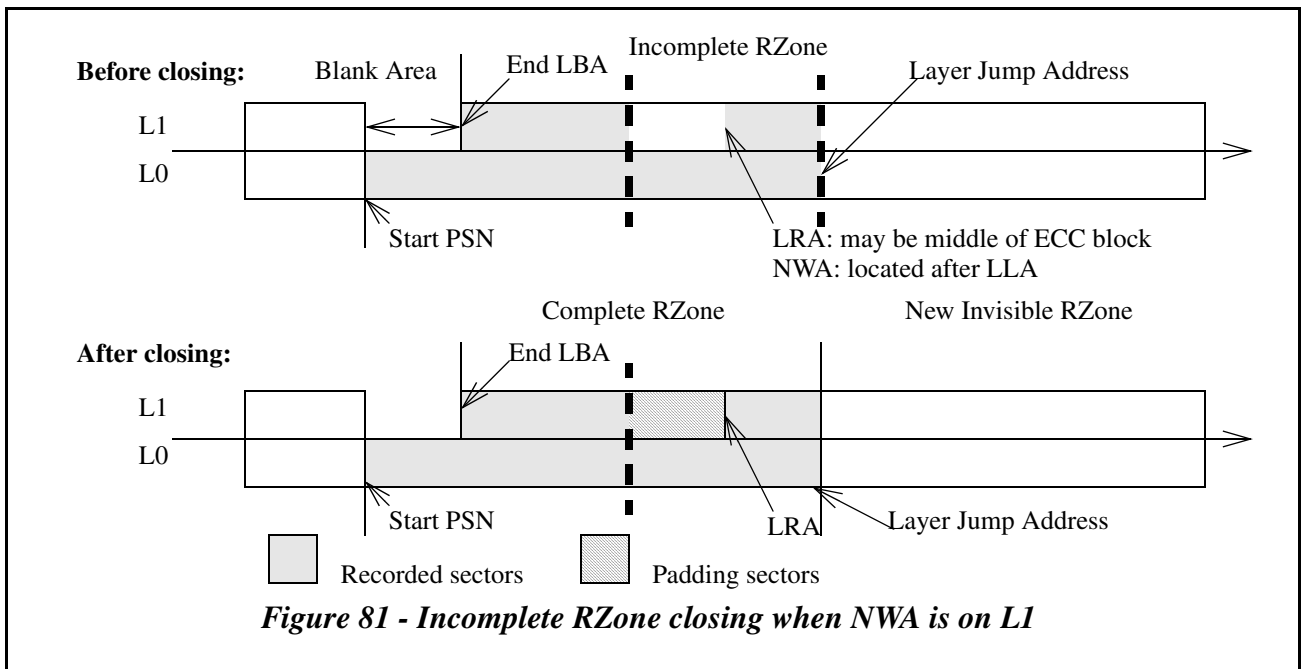
When an Invisible RZone is closed, actually no action is performed. When the disc or the Border is closed, the Shifted Middle Area or Border-out is recorded from the NWA of the Invisible RZone.

When Incomplete RZone of Manual Layer Jump or Regular Interval Layer Jump is closed, Complete RZone and Invisible RZone are created. The LRA of new Complete RZone is the same address of the LRA of old Incomplete RZone. LRA means logical block address of the latest recorded user data sector.

When NWA of Incomplete RZone is located on L0, new Invisible RZone is created from the NWA. The last sector of the ECC block that contains the last recorded sector on L0 becomes Layer Jump Address of the Complete RZone. The unrecorded part of L1 *shall* be padded. If previous RZone is Complete RZone, the Blank Area may be padded.



When NWA is located on L1, new Invisible RZone is created from the last Layer Jump Address + 17 on L0. The last Layer Jump Address of the Incomplete RZone becomes Layer Jump Address of the Complete RZone. The unrecorded part of L1 *shall* be padded. If previous RZone is Complete RZone, the Blank Area may be padded.

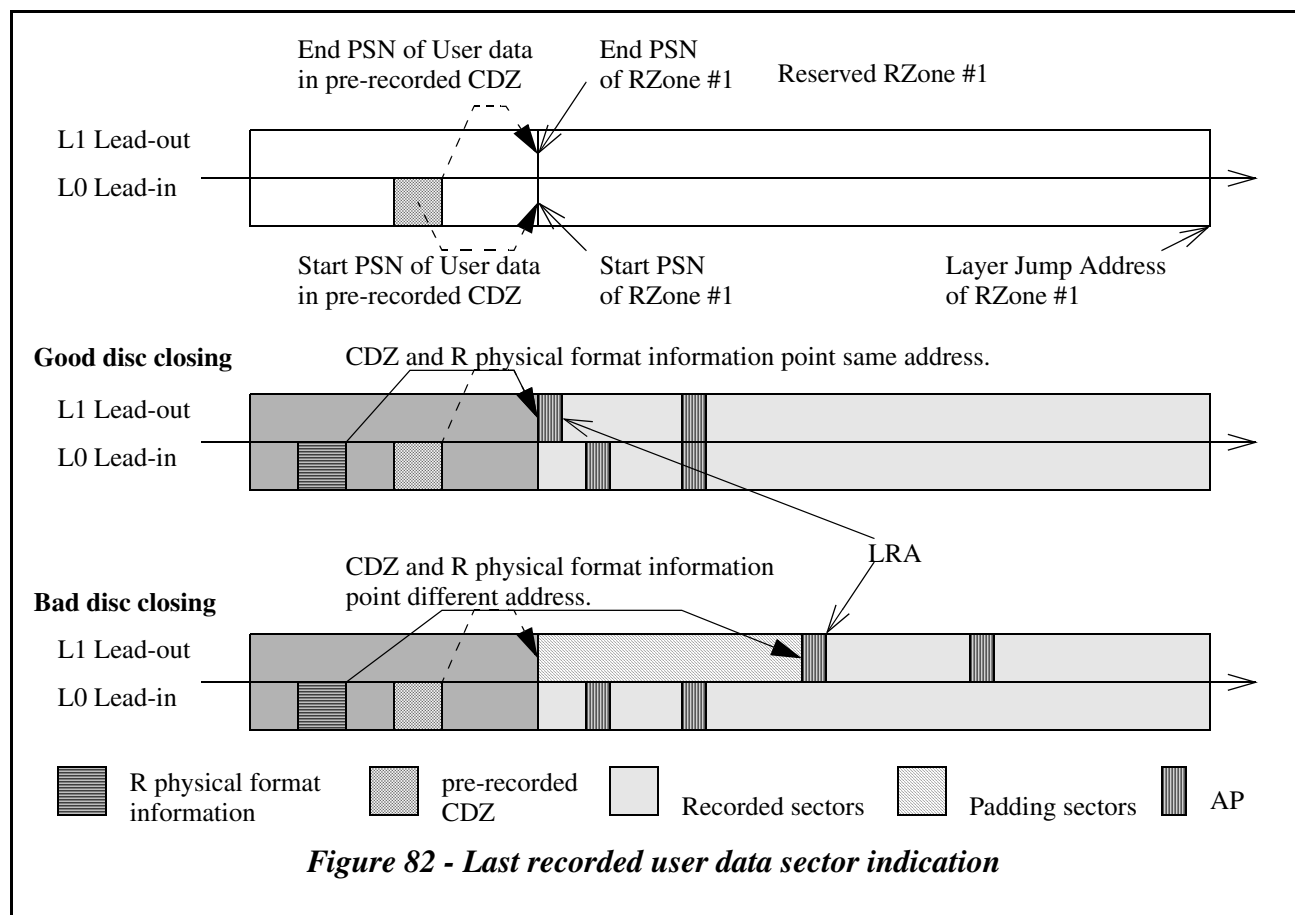


4.18.5.4.3 APs data writing

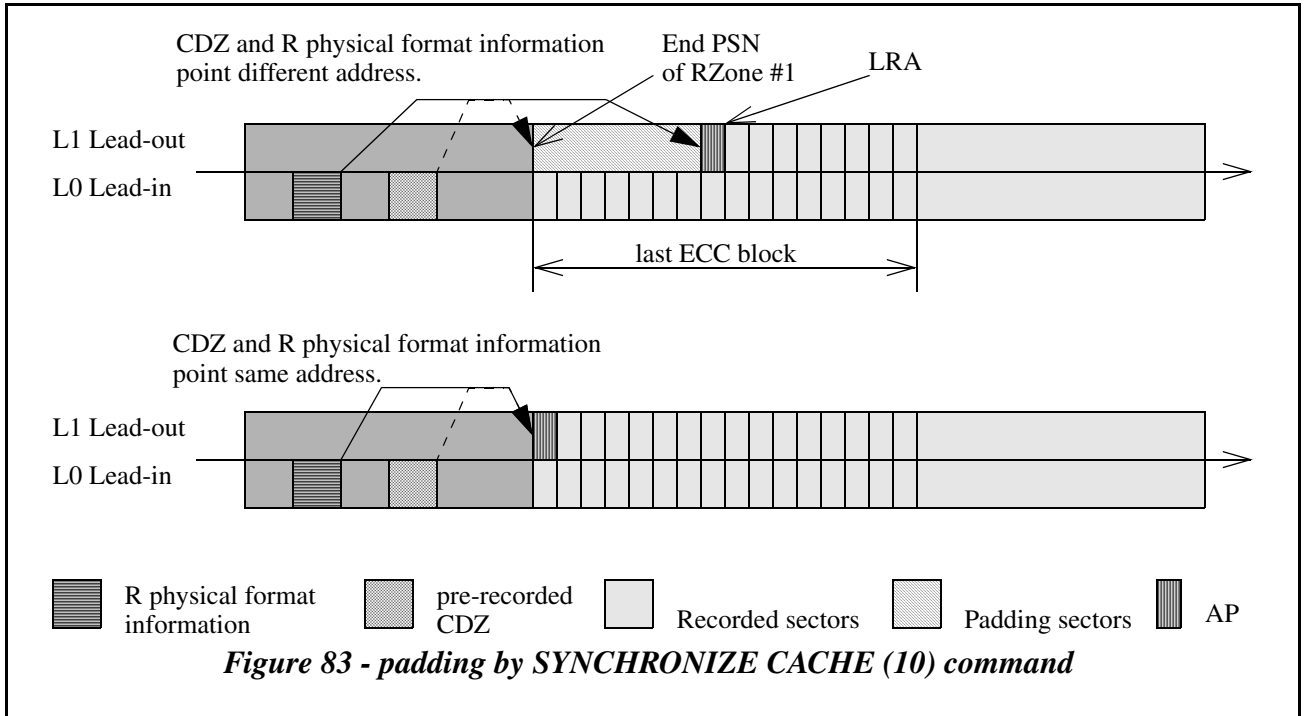
In case of DVD-R medium, there are two parameters that show the last user data recorded address of the disc in Lead-in. One parameter is **Maximum recorded PSN of the Data Area** of Table 34 - *Structure of an R/RW-Physical format information Block* on page 103 that show actual the last user data recorded address of the disc. Another is **End PSN of Data Area** of Table 24 - *Data Area Allocation field definition* on page 98 that is pre-recorded in CDZ (4.5.1, "Control Data Zone" on page 95). A DVD read-only logical unit may read pre-recorded **End PSN of Data Area** to inquiry the last user data recorded address of the disc. When **Maximum recorded PSN of the Data Area** and **End PSN of Data Area** are different, the DVD read-only logical unit cannot retrieve data on AP4 and AP3 correctly (Figure 82).

It is recommended that host writes all blocks in the RZone that include **End PSN of Data Area** to write AP data at **End PSN of Data Area** that is pre-recorded. When **End PSN of an RZone** is same address of **End PSN of Data Area**, host should write AP data to the sector of **End PSN**.

Host should not use CLOSE TRACK/SESSION command to pad un-recorded area of the first reserved RZone (e.g., Bad disc closing of Figure 82).



Host should not pad un-recorded sectors in the last ECC block of the RZone by SYNCHRONIZE CACHE (10) command (e.g., Figure 83).



4.18.5.4.4 Maximum Recorded address check at the first Bordered Area closing

In case of Layer Jump recording, LRA of the first RZone may not mean the maximum recorded user data sector of the first Bordered Area. Logical unit *shall* check the actual maximum recorded user data sector of the Bordered Area to set Maximum recorded PSN of the Data Area field. See 4.18.5.3.5, "LRA of RZone and Closing of Bordered Area" on page 190.

4.18.5.5 Border Zone for DVD-R DL media

For DVD-R DL media, the Border Zone is defined only for Layer Jump recording with Format 4 RMD. The purpose of the Border Zone is to prevent pick-up overrun of DVD read-only logical unit and is to provide read compatibility as well as Single Layer disc. Data is appendable by multi-Border recording after DVD-R DL disc becomes readable by DVD read-only logical unit.

The Border Zone structure for DVD-R DL disc is shown in Figure 84 below.

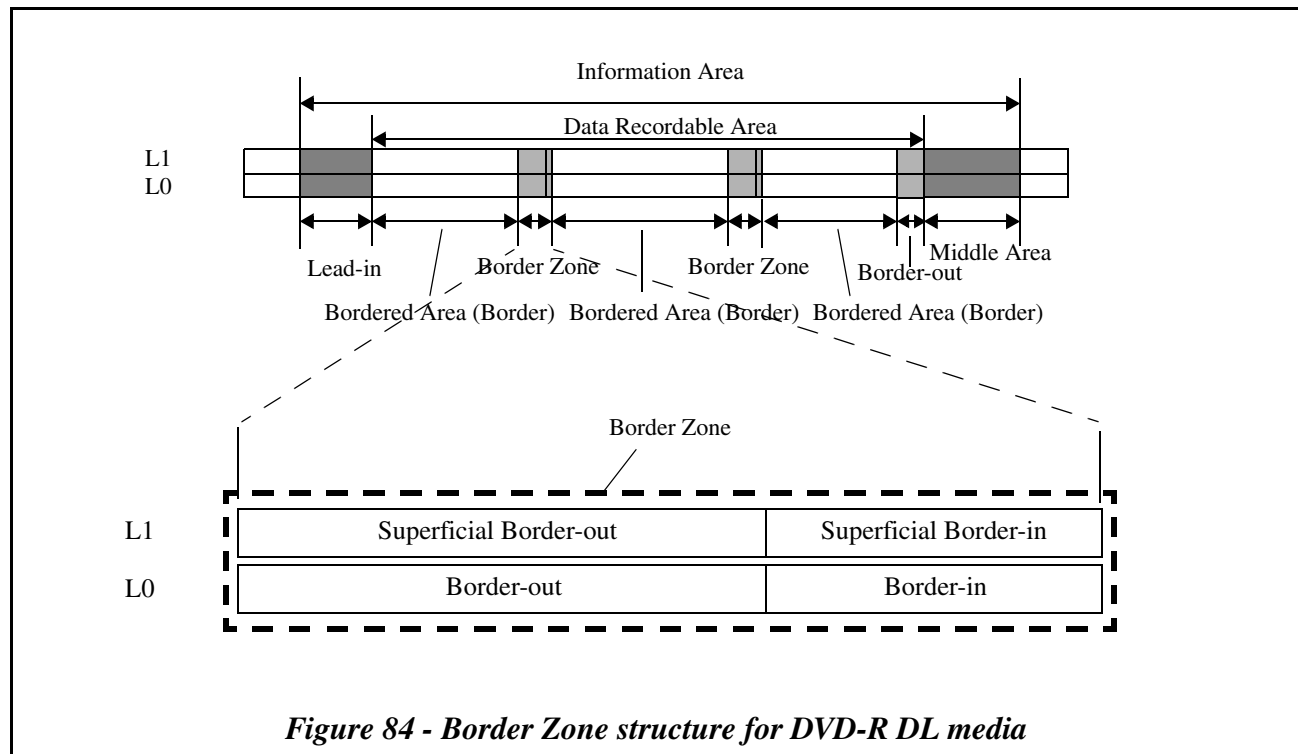
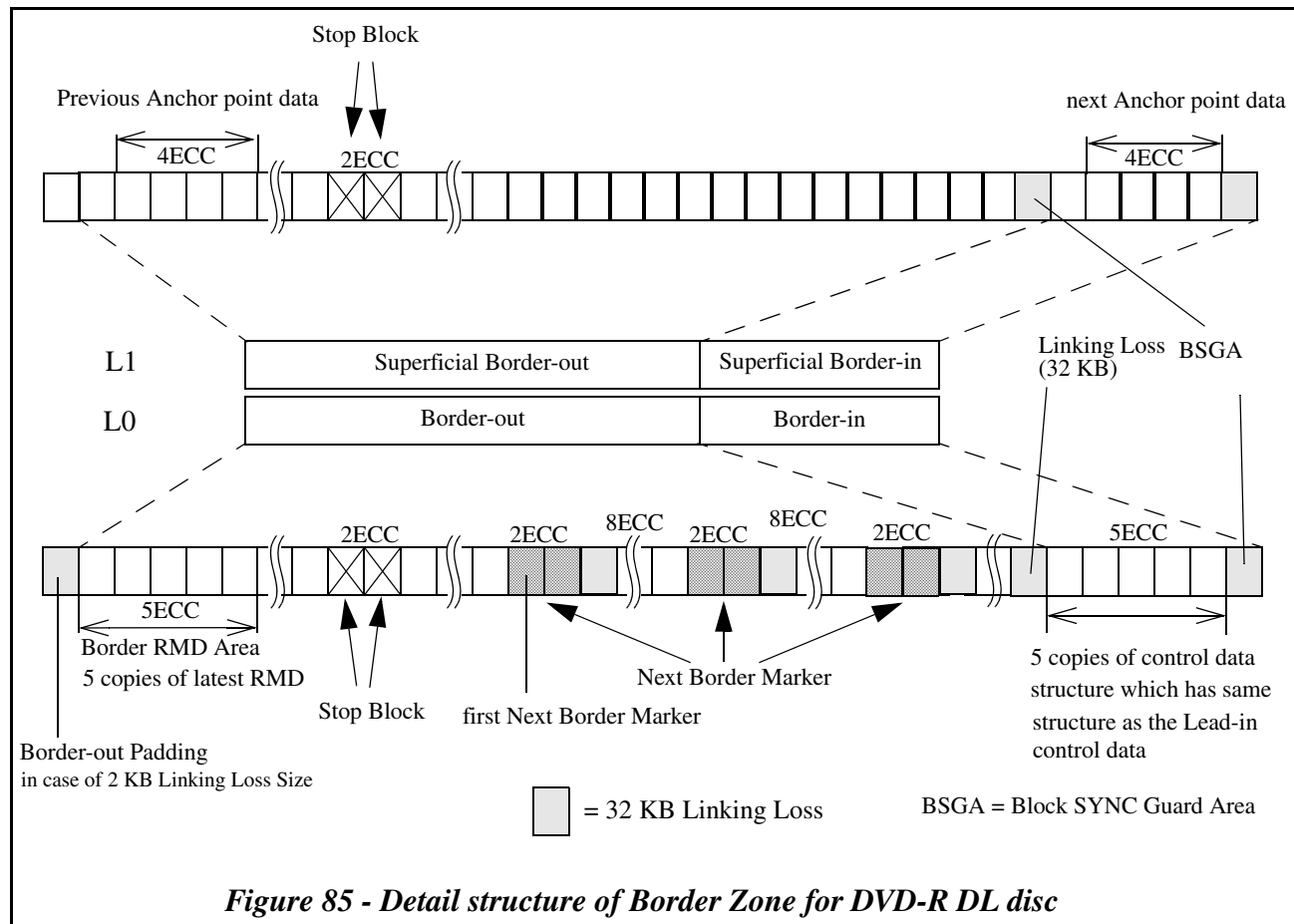


Figure 84 - Border Zone structure for DVD-R DL media

The Border-out and Border-in structure on L0 is same as that of single Layer disc. For DVD-R DL disc, there are same amount of buffer zone on L1 called Superficial Border-out and Superficial Border-in. They are used to store the back-up copies of remapped data at Border closing. The detail structure of Border Zone is depicted in Figure 85.



4.18.5.5.1 Border Zone size and length

Border Zone size is dependent on its starting address. See Table 74. The Border-out start address *shall* be located after PSN 3FEFFh. The logical unit *shall* pad with 00h data through PSN 3FEFFh when Bordered Area is closed and user data is recorded less than LBA 0FEFFh (Size *shall* be 0,554 mm in radial direction).

Table 74 - Border Zone size for DVD-R DL media

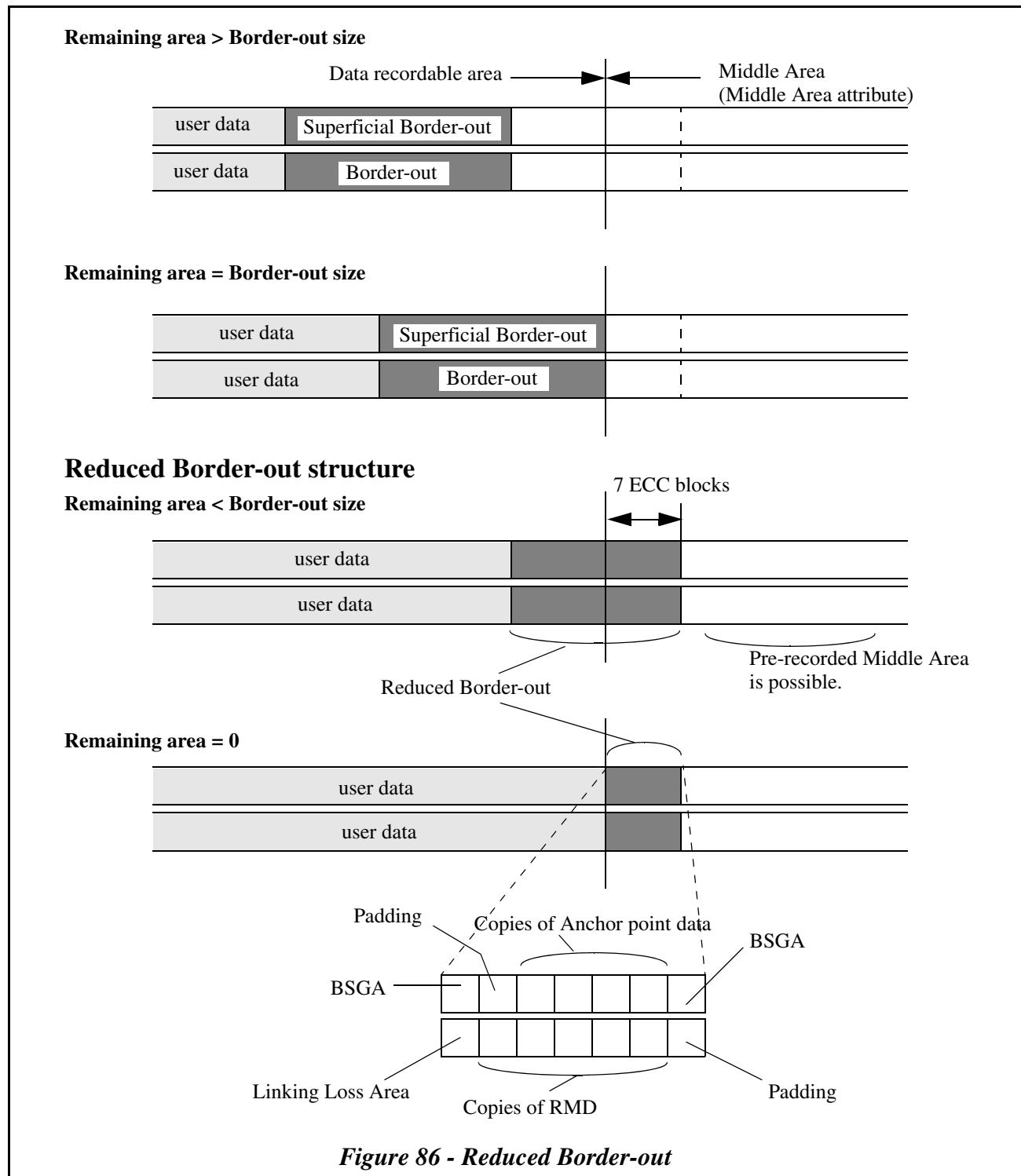
Physical sector number of beginning Border Zone	3FF00h-B25FFh	B2600h-1656FFh	165700h-
Border Zone size	1 844 ECC blocks 115,3 MBytes ^a	2 442 ECC blocks 152,6 MBytes	2 972 ECC blocks 185,8 MBytes

a. MByte = 1 024 × 1 024 bytes

In the case of DVD-R DL, the Border Zone width of the second Border Zone and later are almost same size with the first Border Zone in the radial direction. In future version of DVD-R DL format, the second and later Border Zone size can be changed to be smaller than the first Border Zone size. It is recommended to design logical unit that can correspond to the size change in the future. The first Next Border Marker address is calculated from Border-out start address and Next Border-in start address. The Next Border-in start address of Empty / Incomplete Bordered Area is calculated from the Start PSN of the first RZone in the Bordered Area.

4.18.5.5.2 Reduced Border-out

In Layer Jump recording mode, when the remaining user data capacity is not sufficient to record Border-out, the Border-out is recorded with different manner. When the remaining area is less than the Border-out size, the Border-out size is shrank to fit the remaining data recordable area and a part of Border-out (7 ECC blocks) is recorded at innermost Middle Area with Middle Area attribute. This assures the linear logical volume space to the host.



4.18.5.6 Remapping recording example

There are two remapping mechanisms defined for DVD-R DL media. One is the RMD remapping that is referred by DVD-R Dual Layer logical unit. The other is the Border Zone remapping that is referred by DVD read-only logical unit. When the Border is closed, the DVD-R DL logical unit automatically creates the Border Zone remapping from the RMD remapping information.

A host can remap up to four user data locations called Anchor points. The remappable address is specified by DVD-R DL Book as shown in Table 75. The remapping is done in ECC block unit. Therefore ECC blocks that contain Anchor points are remapped and the start sector number of these remapped ECC blocks are registered in Format 4 RMD Field 3.

DVD-R DL logical unit performs remapping data at reading ECC blocks that contain APs according to Format 4 RMD. When the Border is closed, the remapping information is stored in updated Physical format information and replacement data is stored in Superficial Border-in/out. Therefore DVD read-only logical units can also utilize the remapping mechanism to retrieve correct file system information.

The Maximum Last Recorded Address on L1 should be the same address with End PSN of Data Area in pre-recorded CDZ (4.5.1, "Control Data Zone" on page 95). Otherwise legacy DVD read-only logical unit cannot retrieve data on AP3 and AP4 in the first Bordered Area. See 4.18.5.4.3, "APs data writing" on page 195. See 4.18.5.1, "Recording unit" on page 174 for RZone structure.

Table 75 - Anchor points (Remappable locations)

Anchor point	Location
AP1	PSN 30010h (LBA16)
AP2	PSN 30100h (LBA256)
AP3	Maximum Last Recorded Address - 256 on L1
AP4	Maximum Last Recorded Address on L1

Typical operation sequence of remapping is explained as follows.

- Write ECC block of an AP.
- Write alternative ECC block for updated data of the AP.
- Issue SYNCHRONIZE CACHE (10) command to ensure to be written on the disc.
- Remap the AP by Remapping Address (Format Code = 24h) of SEND DISC STRUCTURE command to the alternative ECC block
- Close the Border by CLOSE TRACK/SESSION command.

4.18.5.6.1 AP remap operation

To remap an AP, the ECC block of the AP and its alternative ECC block *shall* be recorded. The Maximum Last Recorded Address of user data in the disc *shall* be the address on L1. The Write Type field of Write Parameters mode page *shall* be set to Layer Jump recording. See Table 68 - Profile, Feature and Write Type value for each recording mode on page 169.

Before closing the first Bordered Area, position of AP3 and AP4 need to be considered. When a RZone is reserved and unrecorded part exists on L1, the Maximum Last Recorded Address may be changed after the previous reserved RZone is recorded. Once the first Border is closed, the position of AP3, AP4 is fixed and is not changeable.

To remap the Anchor points, the SEND DISC STRUCTURE command with Format Code = 24h is used. Host needs to perform read-modify-write because the other sectors in the ECC block of an AP may have its own data. Host reads the original 16 sectors from an ECC block of AP (may be may not be remapped), updates some parts, and then writes the data to an alternative ECC block on an NWA. If multiple of APs need to be updated, host performs this operation up to 4 times. Then host issues SEND DISC STRUCTURE command with Format Code = 24h to remap the ECC block of the AP to the alternative ECC block up to 4 times. Logical unit may not write user data and remapping information on the

disc with above operation immediately to reduce RMD consumption. It is recommended that host issues SYNCHRONIZE CACHE (10) command to finish all data recording.

After the remapping operation, when a host requests to read a sector in the ECC block of an AP, updated data from the alternative ECC block is returned to the host automatically. See 4.18.5.6.8, "Read behavior of logical unit for remapped ECC block" on page 204. Once a remapping is specified to an AP, the remapping that is done by RMD cannot be cleared. It is because that to change the used AP to the other AP (e.g., AP4 to AP3), old data on the AP that becomes unused **shall** be updated correctly. For example AP4 has AVDP. When using AP4 is stopped, and when AP3 is newly used, AP4 **shall** be updated to non AVDP data and AP3 **shall** have new AVDP by remapping.

4.18.5.6.2 Canceling of AP3, AP4 remapping by RMD in the first Bordered Area

When the alternative ECC block address of an AP#n remapping (e.g., the Re-mapping block sector number for AP1 field) points to the ECC block of the AP#n itself in the first Bordered Area, the RMD remapping **shall not** be succeeded to the superficial Extra Border-in and the first superficial Border-out. The corresponding Re-mapping data Block Valid Flag (RBVF) in Table 37 - DVD-R SL Ver. 2.1 unique part of R-Physical format information on page 104 **shall not** be set to 1.

For example, if RZone#1 is reserved and L1 part is not recorded, then the Maximum Last Recorded Address on L1 is the L1 maximum recorded address of the Incomplete RZone that is RZone#2. During Layer Jump recording in RZone#2, AP4 remapping is performed on the Maximum Last Recorded Address on L1 of RZone#2. To close the Bordered Area, AP4 data are copied to the end address of the RZone#1. Then Maximum Last Recorded Address on L1 moves to the end address of the RZone#1. The alternative address of AP4 is set to the address AP4 itself, then the AP4 remapping is canceled.

4.18.5.6.3 Termination of remapping recording

To show the termination of some recording that uses remapping, one of the alternative ECC block address should be the ECC block address that contain LRA of the Incomplete RZone or LRA of the last RZone (other than Invisible RZone). This means that the sector on LRA of the last RZone should contain some file system data to be written on an AP. The host is able to retrieve the alternative ECC block address by READ DISC STRUCTURE command with Format Code = 24h. Otherwise Border should be closed.

4.18.5.6.4 Multi-Border recording with remapping

When CLOSE TRACK/SESSION command is issued to close the Border, the replacement data on a ECC block of an AP are copied to both Superficial Border-out and Superficial Border-in. If a ECC block of an AP is remapped, the corresponding RBVF **shall** be set to 1 except when the remapping is canceled in the first Bordered Area. See 4.18.5.6.2. A DVD read-only logical units can utilize these information to return correct replacement data in the ECC block of the AP to the host.

There are three typical recording ways that are Disc-at-Once like way, Session-at-Once like way, and flexible packet recording like way. Session-at-Once like way and flexible packet recording like way use remapping. The Session-at-Once like recording may be used for data writing of DVD recording application. Variable packet like recording may be used for PC data writing.

4.18.5.6.5 Disc-at-Once like way

When multi-Border recording is not necessary and total data size to be recorded is known, Shifted Middle Area is useful. A host creates a complete data image on the large buffer (e.g., HDD) then writes the image on DVD-R disc. Shifted Middle Area is set to appropriate position for the recording data size by the SEND DISC STRUCTURE command with Format Code = 21h. The address **shall** be the start sector address of an ECC block (xxxx0h). The range available for Shifted Middle Area starts from the first LBA of the ECC block that contains NWA+15 on L0 and ends at the first LBA of the last ECC block on L0. When NWA is on L1, the available start address range starts from the first writable address of L0 part after Layer Jump happens at Next Layer Jump Address on L1. When Layer Jump is not available at the specified start address due to Clearance, the SEND DISC STRUCTURE command with Format Code = 21h **shall** be terminated with CHECK CONDITION status, 5/26/00 INVALID FIELD IN PARAMETER LIST. See Figure 93 - Padding under Lead-out to create Shifted Middle Area on page 206. If a host tries to specify the Shifted Middle Area start address when a data remains in the logical unit's write buffer, the command **shall** be terminated with CHECK CONDITION status, 5/2C/00 COMMAND SEQUENCE ERROR.

All data is written to the end of the disc through the Layer Jump Address of the Shifted Middle Area. Then disc is closed by CLOSE TRACK/SESSION command. Even if Multisession/Border field of Write Parameters mode page allows Next Border, the disc *shall* be closed. The logical block address is discontinuous on the boundary of Layer Jump Address of Shifted Middle Area. See Figure 87.

Once Shifted Middle Area is specified, data recording is not allowed to the outer area from Shifted Middle Area. The outer area may be used as Disc Test Area (e.g., Power Calibrations) if logical unit supports the function.

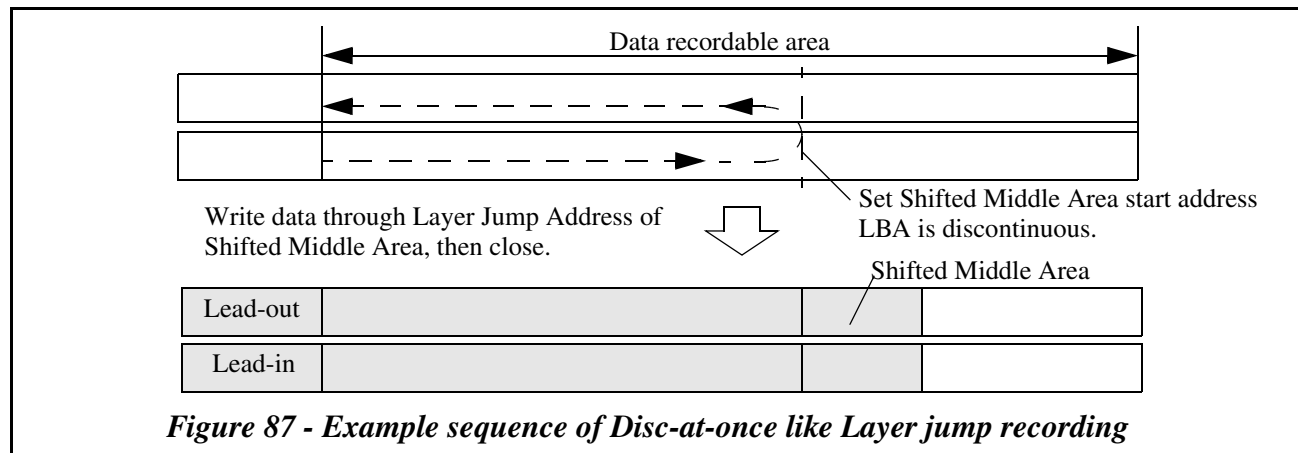


Figure 87 - Example sequence of Disc-at-once like Layer jump recording

4.18.5.6.6 Session-at-Once like way

A host creates a complete data image of the Bordered Area on the large buffer (e.g., HDD) then writes the image on DVD-R disc. Other host may use own intermediate file system to write incremental data on Incomplete RZone of the DVD-R disc. Then the host creates interchangeable File System information from intermediate file system and writes it to the Reserved RZone. Host closes the Bordered Area to make the disc readable by DVD read-only logical unit. To record the second and later Bordered Areas, host repeats same manner, but remaps the APs to new places in the new Bordered Area.

In this case, remapping in the first Bordered Area is not necessary. For DVD recording application format (DVD-VR, AR and SR), remapping by the RBVF in the first Bordered Area is prohibited to keep compatibility of the reading data in the first Bordered Area by legacy DVD read-only logical unit that does not support reading multi-border of DVD-R DL disc. See Figure 88.

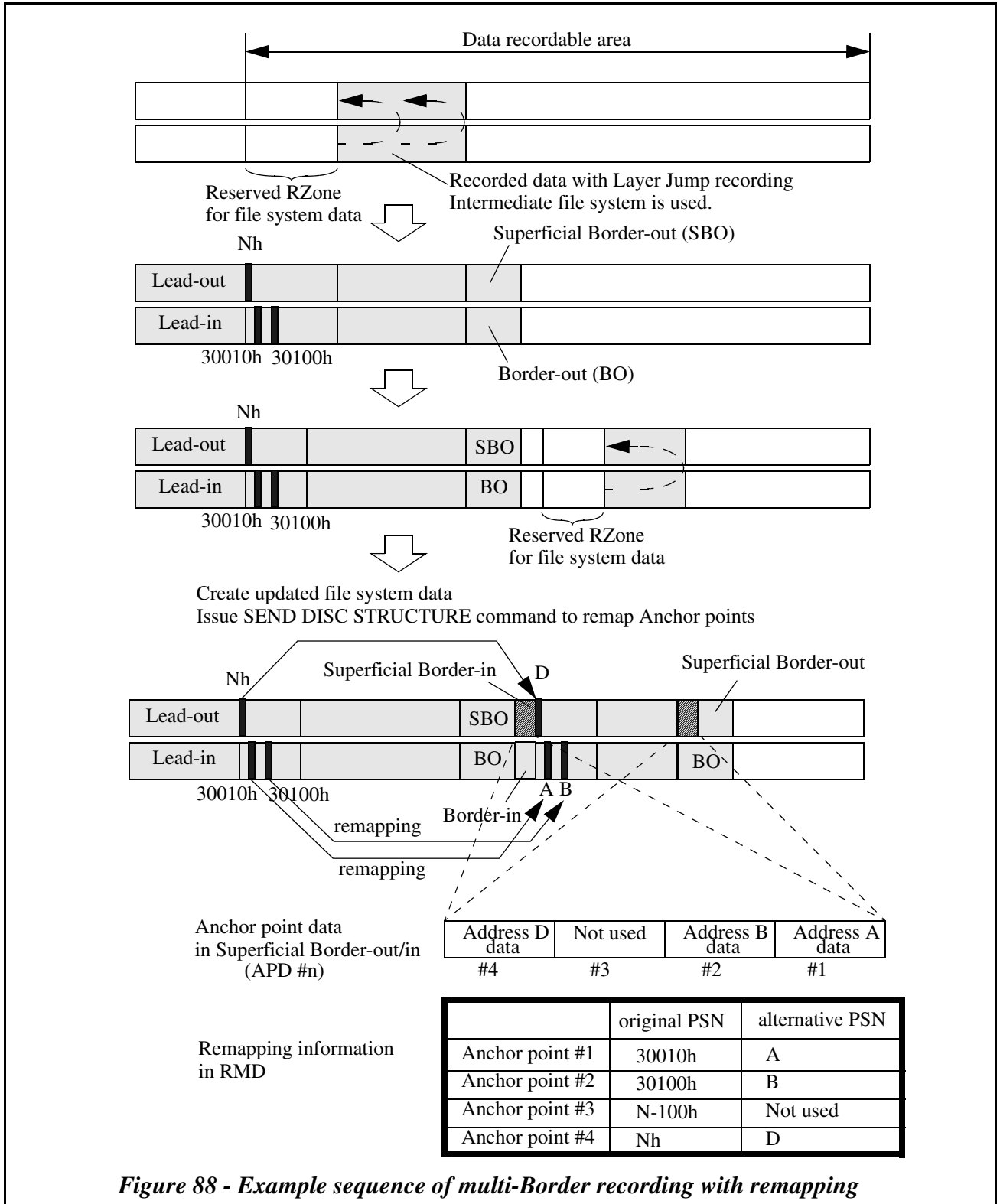
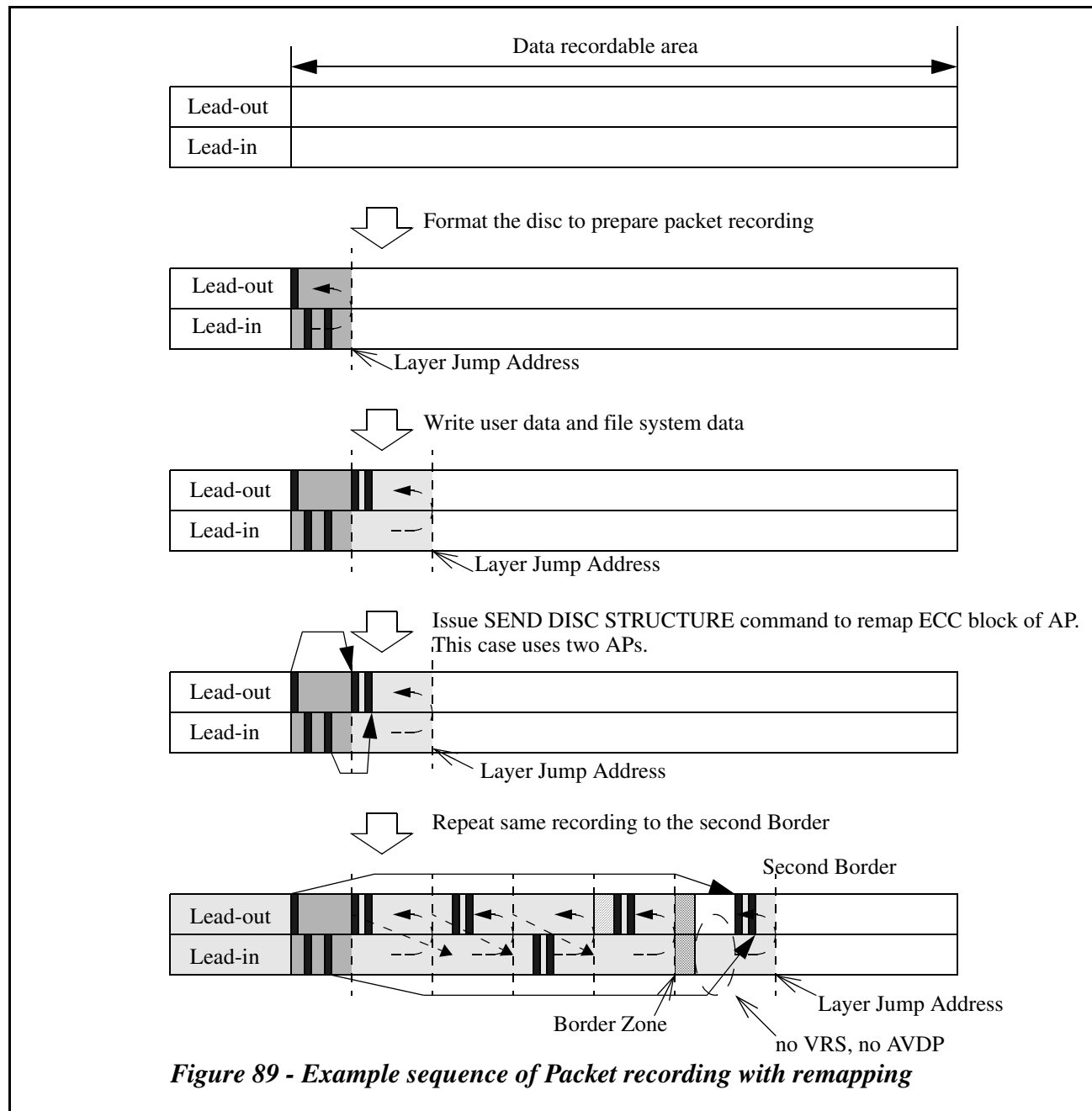


Figure 88 - Example sequence of multi-Border recording with remapping

4.18.5.6.7 Variable packet recording like way

Host writes user data, interchangeable file system data and updated AP data to Incomplete RZone. Then host remaps the AP to the alternative ECC blocks. In this case, host may not close Border to interchange the data among recordable logical units. Host may use Incomplete disc state for data interchange. In this case, 16th sector and 256th sector from the beginning of the second Bordered Area may not contain VRS and AVDP of file system.



4.18.5.6.8 Read behavior of logical unit for remapped ECC block

When a read request is issued to a sector that is located within the remapped ECC block, the drive will return the updated data in its alternative ECC block to the host. The writer logical unit that reports Feature 0033h: Layer Jump recording Feature *shall* return the updated data on the alternative block. Read only logical unit that support multi-border reading also *shall* return the updated data correctly. See Figure 90.

But it is recommended that host starts the read operation within the remapped ECC block to read updated data correctly. It is because that when a read operation does not start within the remapped ECC block and the reading has started from previous ECC block through remapped ECC block, some Read only logical unit that have poor implementation may not report the replacement data C:R:E but C:D:E as shown in Figure 90.

When a read request is issued to the alternative ECC block, the contents of the alternative block is returned to the host as it is.

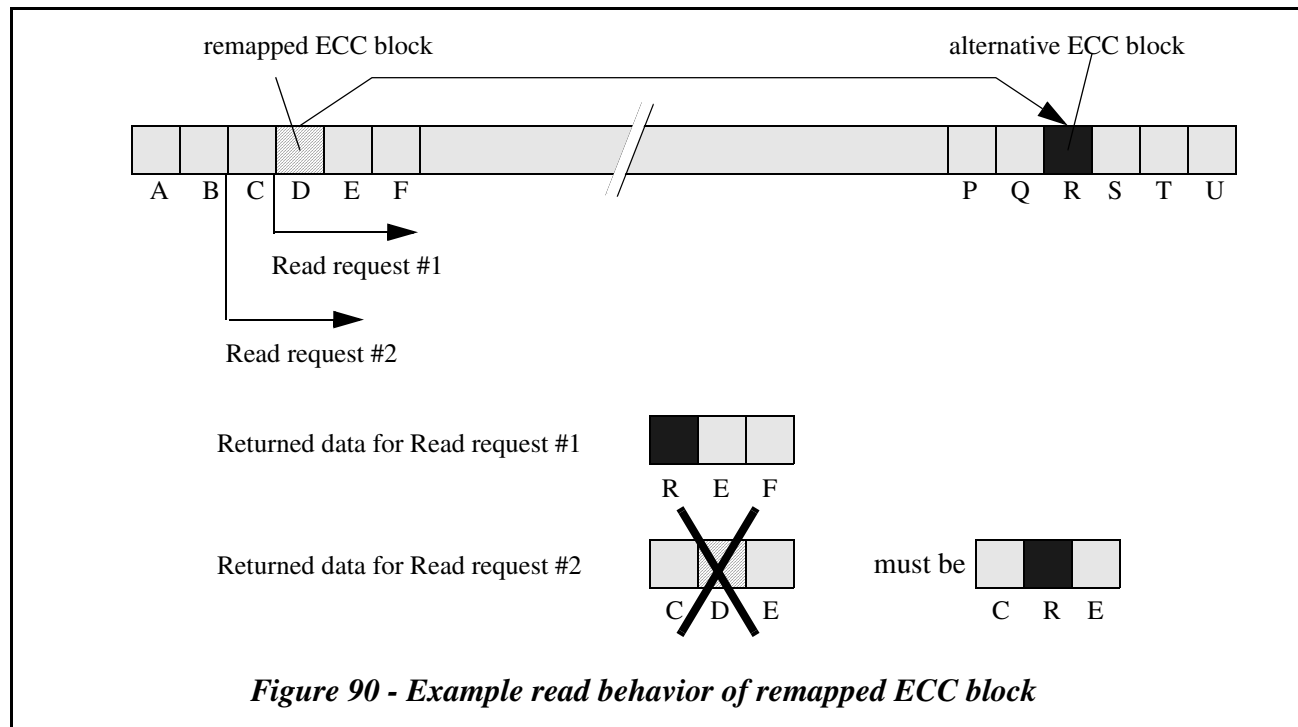


Figure 90 - Example read behavior of remapped ECC block

4.18.5.7 Disc final closure

In Layer Jump recording mode, when the disc is closed to prohibit further recording (= disc final closure), the Shifted Middle Area or Fixed Middle Area is recorded at the end of the user data. No additional recording is allowed beyond the Shifted Middle Area. When the Shifted Middle Area is recorded, the Information Area shall be recorded more than 70 mm in diameter. If the recorded length is less than 70 mm in diameter, the logical unit shall write Shifted Middle Area up to 70 mm in diameter. See DVD-R Book Part 1.

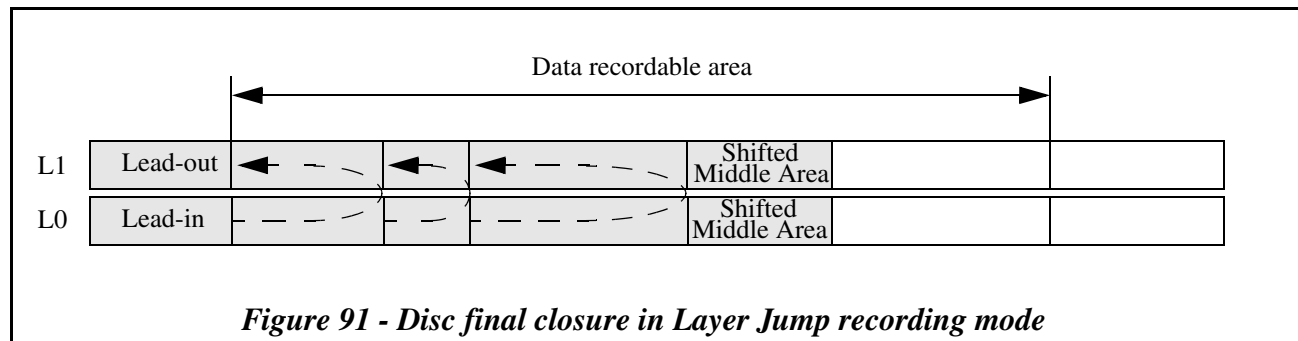
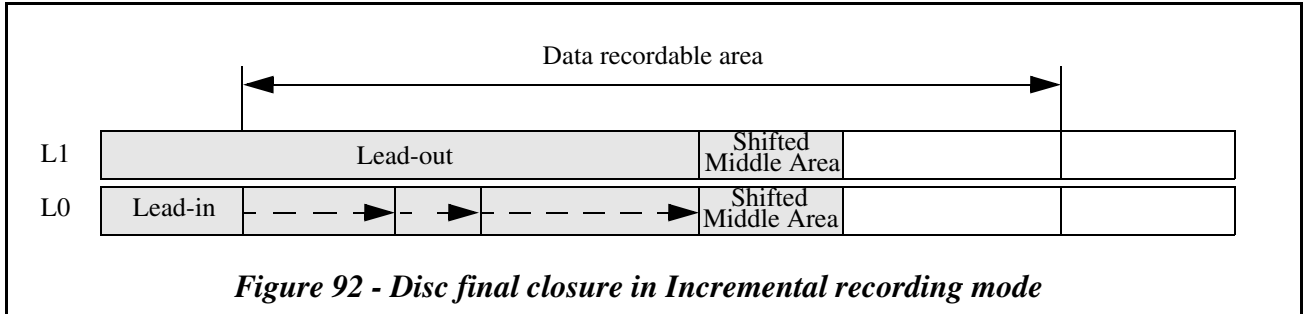


Figure 91 - Disc final closure in Layer Jump recording mode

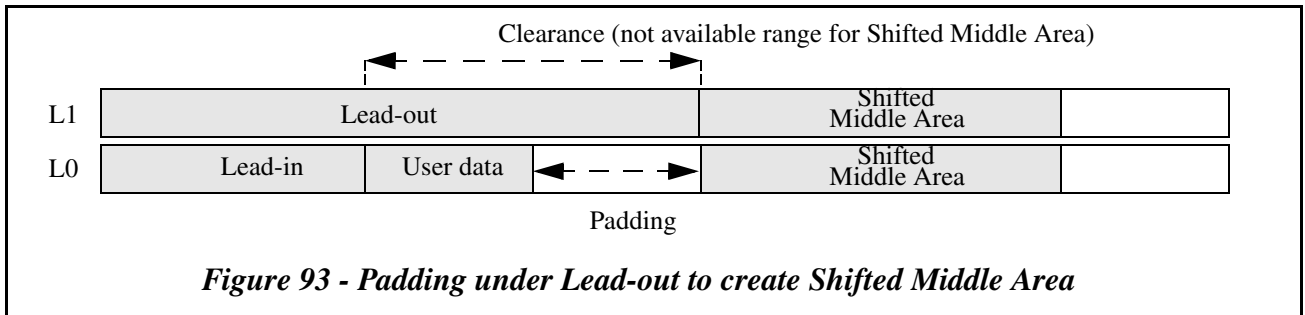
Shifted Middle Area can be specified by the SEND DISC STRUCTURE command with Format Code = 21h. See 4.18.5.6.5.

In the case of Incremental recording mode, the Shifted Middle Area can be applied at disc final closure when data is recorded on L0 only. If user data is recorded on both L0 and L1 at disc final closure, the all open RZones *shall* be closed first and the logical unit *shall* pad the remaining area on L1 with Lead-out.



4.18.5.7.1 Padding under Lead-out for Shifted Middle Area

As shown in Figure 69 - *Physical overview of Layers* on page 180, Lead-out is larger than the Lead-in to have the Clearance. The Shifted Middle Area cannot be created under the Lead-out. When user Data Area size is smaller than the Clearance size made by Lead-out, the logical unit *shall* pad remaining area to create the Shifted Middle Area. See Figure 93.



4.18.6 RMD (Recording Management Data) for DVD-R DL media

The size of RMA is expanded and RMD can be updated approximately 816 times. The RMD is sequentially recorded from the inner side of L0 and when RMA on L0 is filled up, RMD is recorded from the outer side of RMA on L1.

The RMD structure is same as that of DVD-R Single Layer media. The contents of each Field is defined in the following tables.

4.18.6.1 RMD Field 0 (RMD Header) for DVD-R DL disc

RMD Field 0 specifies general information of the disc and is structured as follows.

Table 76 - RMD - Field 0

Bit Byte	7	6	5	4	3	2	1	0
0-1	(MSB) RMD Format							(LSB)
2	Disc Status							
3	Reserved							
4-21	(MSB) Unique Disc ID							(LSB)
22-85	(MSB) Copy of Pre-pit Information							(LSB)
86-89	Start sector number of the Shifted Middle Area							
90	Pre-recorded information code							
91	Reserved							
92-95	End address of pre-recorded Lead-in Area							
96-99	End address of pre-recorded Middle Area on Layer 0							
100-103	Start address of pre-recorded Middle Area on Layer 1							
104-107	Start address of pre-recorded Lead-out Area							
108-2 047	Reserved							

The RMD Format field specifies the format of the following RMD Field 1 - Field 14 which is used on the medium. RMD Format field is defined in Table 77.

Table 77 - RMD Format field definition

Value	Definition
0000h	Reserved
0001h	The following RMD Field 1-14 is recorded as Format 1 RMD defined for DVD-R DL disc.
0002h-0003h	Reserved for DVD-RW media
0004h	The following RMD Field 1-14 is recorded as Format 4 RMD. This format code is defined only for DVD-R DL disc.
0005h-FFFFh	Reserved

The Disc Status field indicates the disc status. Disc Status field is defined in Table 78.

Table 78 - Disc Status field definition

Value	Definition
00h	The disc has no written data in Data Recordable Area (only RMD is written)
01h	The disc is in Disc-at-once recording mode
02h	The disc is in Incremental recording mode
03h	The disc is completed and not appendable in the case of Incremental recording
04h-FFh	Reserved

The Unique Disc ID field is recorded and structured as defined in Table 79. The Unique Disc Identifier contains time stamp fields. The time format should be UTC 24 hour clock¹. This field *shall* be set by the SEND DISC STRUCTURE command. This time stamp data sent by the SEND DISC STRUCTURE command may also be used in the OPC related field in RMD Field 1 and may help the judgement to do OPC. The logical unit *shall* update the time stamp during power on. Strict accuracy of time is not required.

Table 79 - Unique Disc ID

Bit Byte	7	6	5	4	3	2	1	0
0-1	Reserved							
2-3	(MSB)			Random Data				(LSB)
4-7	(MSB)			Year				(LSB)
8-9	(MSB)			Month				(LSB)
10-11	(MSB)			Day				(LSB)
12-13	(MSB)			Hour				(LSB)
14-15	(MSB)			Minute				(LSB)
16-17	(MSB)			Second				(LSB)

The Random Data field is a random number.

The Year field specifies the year coded in ASCII in the range “0001” to “9999”.

The Month field specifies the month of the year coded in ASCII in the range “01” to “12”.

The Day field specifies the day of the month coded in ASCII in the range “01” to “31”.

The Hour field specifies the hour of the day coded in ASCII in the range “00” to “23”.

The Minute field specifies the minute of the hour coded in ASCII in the range “00” to “59”.

The Second field specifies the second of the minute coded in ASCII in the range “00” to “59”.

1. UTC = universal time coordinated

The Copy of Pre-pit Information field contains the copy of Pre-pit Information data which is recorded as LPP (Land Pre-Pit). Copy of Pre-pit Information structure is shown in Table 80. Pre-pit information data is specified by DVD-R Book Part 1.

Table 80 - Copy of Pre-pit Information for DVD-R DL disc

Bit Byte	7	6	5	4	3	2	1	0
22	Field ID = 01h							
23	Application code							
24	Disc Physical code							
25-27	(MSB)	Last address of Data Recordable Area on Layer 0						(LSB)
28	LPP Part Version				Extension code			
29	Reserved							
30	Field ID = 02h							
31-32	Reserved							
33-35	(MSB)	Last address of Data Recordable Area on Layer 1						(LSB)
36-37	Reserved							
38	Field ID = 03h							
39-44	1st field of Manufacturer ID							
45	Reserved							
46	Field ID = 04h							
47-52	2nd field of Manufacturer ID							
53	Reserved							
54	Field ID = 05h							
55-60	Reserved							
61-85	Reserved							

The Start sector number of the Shifted Middle Area field indicates the start PSN of the Shifted Middle Area on L0 when the Shifted Middle Area is specified or recorded. Otherwise this field is filled with 00h.

The Pre-recorded information code field identifies that whether the pre-recordable area is recorded or not.

Table 81 - Pre-recorded information code field definition

Bit	Definition
0	This bit is set to zero to indicate that the Control Data Zone is pre-recorded
1	When set to one, it indicates that the Lead-in Area is pre-recorded except the Extra Border-zone and the R-Physical format information zone. When set to zero, it indicates that the Lead-in Area is not pre-recorded.
2	When set to one, it indicates that the Middle Area on L0 and L1 is fully pre-recorded. When set to zero, it indicates that the Middle Area is not pre-recorded.
3	When set to one, it indicates that the Lead-out is pre-recorded. When set to zero, it indicates that the Lead-out is not pre-recorded.
4-7	Reserved

The End address of pre-recorded Lead-in Area field indicates the end address of pre-recorded Lead-in Area. When the bit 1 of Pre-recorded information code field is set to one, this field is valid.

The End address of pre-recorded Middle Area on Layer 0 field indicates the end address of pre-recorded Middle Area on L0. When the bit 2 of Pre-recorded information code field is set to one, this field is valid.

The Start address of pre-recorded Middle Area on Layer 1 field indicates the start address of pre-recorded Middle Area on L1. When the bit 2 of Pre-recorded information code field is set to one, this field is valid.

The Start address of pre-recorded Lead-out Area field indicates the start address of pre-recorded Lead-out. When the bit 3 of Pre-recorded information code field is set to one, this field is valid.

4.18.6.2 The contents of Format 1 RMD on DVD-R DL disc

4.18.6.2.1 Format 1 RMD Field 1

Format 1 RMD Field 1 contains some logical unit and OPC related information and *shall* be recorded as defined in Table 82. There are four sets of OPC data blocks. These are prepared for the case of four different DVD-R logical units writing to a disc. The logical unit *shall* use an empty set or its own. If there is no owned or empty OPC data block, the logical unit may use the oldest time stamp OPC data block.

Table 82 - Format 1 RMD - Field 1 (logical unit and OPC information)

Bit Byte	7	6	5	4	3	2	1	0
0-31	Drive manufacturer ID #1							
32-47	Serial Number #1							
48-63	Model Number #1							
64-79	2×-speed Write Strategy code for Layer 0 #1							
80-83	Recording power #1							
84-91	Timestamp #1							
92-95	Power Calibration Address #1							
96-107	Running OPC Information #1							
108-123	2×-speed Write Strategy code for Layer 1 #1							
124-125	DSV #1							
126-127	Reserved							
:	:							
384-415	Drive manufacturer ID #4							
416-431	Serial Number #4							
432-447	Model Number #4							
448-463	2×-speed Write Strategy code for Layer 0 #4							
464-467	Recording power #4							
468-475	Timestamp #1							
476-479	Power Calibration Address #4							
480-491	Running OPC Information #4							
492-507	2×-speed Write Strategy code for Layer 1 #4							
508-509	DSV #4							
510-511	Reserved							
512-2 047	Reserved							

The Drive manufacturer ID #n field is recorded in binary and specifies unique drive manufacturer identifier of the logical unit.

The Serial Number #n field is recorded as ASCII code and specifies serial number of the logical unit.

The Model Number #n field is recorded as ASCII code and specifies the recorder model number.

The 2×-speed Write Strategy Code for Layer 0 #n field is recorded and specifies the 2×-speed write strategy code for L0 that is specified by DVD-R Book Part 1.

The Recording Power #n field may be used to store the value of the OPC result. The format of this field is vendor-specific. If this field is set to 0, this field is invalid.

The Timestamp #n field may be used to store date and time when OPC is performed. This field, if used, is recorded in binary. If this field is set to 0, this field is invalid.

The Power Calibration Address #n field may be used to specify the start ECC block address of the PCA where the last OPC was performed. If this field is set to 0, this field is invalid.

The Running OPC Information field may be used to specify values concerning running OPC. The format is vendor-specific. If this field is set to 0, this field is invalid.

The 2×-speed Write Strategy Code for Layer 1 #n field *shall* be recorded and specifies the 2×-speed write strategy code for L1 that is specified by DVD-R Book Part 1.

If the disc is incrementally recorded and when RMD is updated, the DSV field *shall* be recorded. This field is used to specify the last DSV (Digital Sum Value) in binary notation.

4.18.6.2.2 Format 1 RMD Field 2

Format 1 RMD Field 2 can be used freely and format of this field is user-specific.

Table 83 - Format 1 RMD - Field 2 (User Specific Data)

Bit Byte	7	6	5	4	3	2	1	0
0-2 047	User Specific Data							

The User Specific Data field is available for recording of user specific data. The use of this field is optional. If not used, this field *shall* be set to 0.

4.18.6.2.3 Format 1 RMD Field 3

Format 1 RMD Field 3 is reserved and *shall* be set to 0 for DVD-R DL disc.

Table 84 - Format 1 RMD - Field 3 (Reserved)

Bit Byte	7	6	5	4	3	2	1	0
0-2 047	Reserved							

4.18.6.2.4 Format 1 RMD Field 4

Format 1 RMD Field 4 contains RZone related information and *shall* be recorded as follows.

Table 85 - Format 1 RMD - Field 4 (RZone Information)

Bit Byte	7	6	5	4	3	2	1	0
0-1	(MSB) Invisible/Incomplete RZone Number (Last RZone Number)							(LSB)
2-3	(MSB) First Open RZone number							(LSB)
4-5	(MSB) Second Open RZone number							(LSB)
6-7	Third Open RZone number							
8-15	Reserved							
16-19	(MSB) Start Sector Number of RZone #1							(LSB)
20-23	(MSB) Last Recorded Address of RZone #1							(LSB)
24-27	(MSB) Start Sector Number of RZone #2							(LSB)
28-31	(MSB) Last Recorded Address of RZone #2							(LSB)
:	:							
2 032-2 035	(MSB) Start Sector Number of RZone #253							(LSB)
2 036-2 039	(MSB) Last Recorded Address of RZone #253							(LSB)
2 040-2 043	(MSB) Start Sector Number of RZone #254							(LSB)
2 044-2 047	(MSB) Last Recorded Address of RZone #254							(LSB)

The Invisible/Incomplete RZone Number field contains the Invisible/Incomplete RZone number of the medium. If the last RZone state is neither Invisible nor Incomplete due to disc finalization, this field contains the last Complete RZone number.

The First Open RZone number field, if recorded with value other than 0, contains the current appendable Reserved RZone number. If this field is set to 0, there is no Empty reserved RZone or Partially recorded reserved RZone corresponding to this field.

The Second Open RZone number field, if recorded with value other than 0, contains the current appendable Reserved RZone number. If this field is set to 0, there is no Empty reserved RZone or Partially recorded reserved RZone corresponding to this field.

The Third Open RZone number field, if recorded with value other than 0, contains the current appendable Reserved RZone number. If this field is set to 0, there is no Empty reserved RZone or Partially recorded reserved RZone corresponding to this field.

When the Incomplete RZone is closed, the Invisible/Incomplete RZone Number field contains the number of the new Invisible RZone number (N+1). When Reserved RZone is closed, the corresponding First (Second) Open RZone number field *shall* be set to 0.

The Start Sector Number of RZone #n field contains the start sector number of the RZone which has RZone number #n.

The Last Recorded Address of RZone #n field contains the last recorded address of the RZone which has RZone number #n. If this field is set to 0, this field is not valid. If RZone #n is not closed, the value of this field may not be correct and a link point search is required to determine the correct LRA.

Note: The LRA reported by the READ TRACK INFORMATION command is always correct.

When the RZone is not closed, even if the Last Recorded Address of RZone #n field contains a value, the logical unit *shall* determine the current LRA of the RZone. When RZone is closed, Last Recorded Address of RZone #n field *shall* be recorded before RZone padding.

4.18.6.2.5 Format 1 RMD Field 5 - Field 12

Format 1 RMD Field 5 through Field 12 may contain RZone related information continued from Format 1 RMD Field 4.

Table 86 - Format 1 RMD - Field 5 - Field 12 (RZone Information ... continued)

Bit Byte	7	6	5	4	3	2	1	0
0-3	(MSB) Start Sector Number of RZone #n							(LSB)
4-7	(MSB) Last Recorded Address of RZone #n							(LSB)
8-11	(MSB) Start Sector Number of RZone #(n+1)							(LSB)
12-15	(MSB) Last Recorded Address of RZone #(n+1)							(LSB)
:	:							
2 032-2 035	(MSB) Start Sector Number of RZone #(n+253)							(LSB)
2 036-2 039	(MSB) Last Recorded Address of RZone #(n+253)							(LSB)
2 040-2 043	(MSB) Start Sector Number of RZone #(n+254)							(LSB)
2 044-2 047	(MSB) Last Recorded Address of RZone #(n+255)							(LSB)

The Start Sector Number of RZone #n field contains start sector number of the RZone which has RZone number #n.

The Last Recorded Address of RZone #n field contains the last recorded address of the RZone which has RZone number #n. If this field is set to 0, this field is not valid. If RZone #n is not closed, the value of this field may not be correct and a link point search is required to determine the correct LRA.

Note: The LRA reported by the READ TRACK INFORMATION command is always correct.

When the RZone is not closed, even if the Last Recorded Address of RZone #n field contains a value, the logical unit *shall* determine the current LRA of the RZone. When RZone is closed, Last Recorded Address of RZone #n field *shall* be recorded before RZone padding.

4.18.6.2.6 Format 1 RMD Field 13

Format 1 RMD Field 13 contains drive specific information and *shall* be recorded as defined in Table 87. There are eight sets of logical unit specific information blocks. These are prepared for the case of eight different DVD-R logical units writing to a disc. The unused fields in Format 1 RMD Field 13 *shall* be set to zero.

Table 87 - Format 1 RMD - Field 13 (Drive specific information)

Bit Byte	7	6	5	4	3	2	1	0
0-31	Drive manufacturer ID #1							
32-47	Serial Number #1							
48-63	Model Number #1							
64-66	Recorded RMA address (ECC block address) #1							
67-127	Drive specific data #1							
:	:							
896-927	Drive manufacturer ID #8							
928-943	Serial Number #8							
944-959	Model Number #8							
960-962	Recorded RMA address (ECC block address) #8							
963-1 023	Drive specific data #8							
1 024-2 047	Additional drive specific information for recorder #1							

The Drive Manufacturer ID #n field is recorded in binary and contains unique drive manufacturer identifier.

The Serial Number #n field is recorded in ASCII code and contains the serial number of the logical unit.

The Model Number #n field is recorded in ASCII code and contains the drive model number of the logical unit.

The Recorded RMA address #n field specifies the starting RMA address which is used to record RMD including the information of specific drive. This field *shall* be specified in ECC block address.

The Drive specific data #n field may be recorded to store the drive specific data. If this field is set to zero, this field is invalid.

The Additional Drive specific data for recorder #1 field may be recorded to store the additional drive specific data for logical unit #1. If this field is set to zero, this field is invalid.

4.18.6.2.7 Format 1 RMD Field 14

Format 1 RMD Field 14 is defined as follows.

Table 88 - Format 1 RMD - Field 14 (Versatile information)

Bit Byte	7	6	5	4	3	2	1	0
0	Flexible Outer Disc Testing Area flag							
1-4	Testing address of Flexible Outer Disc Testing Area on Layer 0							
5-8	Testing address of Flexible Outer Disc Testing Area on Layer 1							
9-12	Testing address of Inner Disc Testing Area on Layer 0							
13-16	Testing address of Inner Disc Testing Area on Layer 1							
17-20	Testing address of Outer Disc Testing Area on Layer 0							
21-24	Testing address of Outer Disc Testing Area on Layer 1							
25-28	Testing address of optional Inner Disc Testing Area on Layer 1							
29-2 047	Reserved							

When each Disc Testing Area are used, these filed are set. For detail information, see DVD-R Book Ver. 3.0.

4.18.6.3 The contents of Format 4 RMD

4.18.6.3.1 Format 4 RMD Field 1

Format 4 RMD Field 1 contains some logical unit and OPC related information and *shall* be recorded as defined in Table 89. There are four sets of OPC data blocks. These are prepared for the case of four different DVD-R logical units writing to a disc. The logical unit *shall* use an empty set or its own. If there is no owned or empty OPC data block, the logical unit may use the oldest time stamp OPC data block.

Table 89 - Format 4 RMD - Field 1 (logical unit and OPC information)

Bit Byte	7	6	5	4	3	2	1	0
0-31	Drive manufacturer ID #1							
32-47	Serial Number #1							
48-63	Model Number #1							
64-79	2×-speed Write Strategy code for Layer 0 #1							
80-83	Recording power #1							
84-91	Timestamp #1							
92-95	Power Calibration Address #1							
96-107	Running OPC Information #1							
108-123	2×-speed Write Strategy code for Layer 1 #1							
124-125	DSV #1							
126-127	Reserved							
:	:							
384-415	(MSB)	Drive manufacturer ID #4						(LSB)
416-431	(MSB)	Serial Number #4						(LSB)
432-447	(MSB)	Model Number #4						(LSB)
448-463	2×-speed Write Strategy code for Layer 0 #4							
464-467	Recording power #4							
468-475	Timestamp #1							
476-479	Power Calibration Address #4							
480-491	Running OPC Information #4							
492-507	2×-speed Write Strategy code for Layer 1 #4							
508-509	DSV #4							
510-511	Reserved							
512-2 047	Reserved							

The Drive manufacturer ID #n field is recorded in binary and specifies unique drive manufacturer identifier of the logical unit.

The Serial Number #n field is recorded as ASCII code and specifies serial number of the logical unit.

The Model Number #n field is recorded as ASCII code and specifies the recorder model number.

The 2×-speed Write Strategy Code for Layer 0 #n field *shall* be recorded and specifies the write strategy code that is specified by DVD-R Book Part 1.

The Recording Power #n field may be used to store the value of the OPC result. The format of this field is vendor-specific. If this field is set to 0, this field is invalid.

The Timestamp #n field may be used to store date and time when OPC is performed. This field, if used, is recorded in binary. If this field is set to 0, this field is invalid.

The Power Calibration Address #n field may be used to specify the start ECC block address of the PCA where the last OPC was performed. If this field is set to 0, this field is invalid.

The Running OPC Information field may be used to specify values concerning running OPC. The format is vendor-specific. If this field is set to 0, this field is invalid.

The 2×-speed Write Strategy Code for Layer 1 #n field *shall* be recorded and specifies the write strategy code that is specified by DVD-R Book Part 1.

If the disc is incrementally recorded and when RMD is updated, the DSV field *shall* be recorded. This field is used to specify the last DSV (Digital Sum Value) in binary notation.

4.18.6.3.2 Format 4 RMD Field 2

Format 4 RMD Field 2 can be used freely and format of this field is user-specific.

Table 90 - Format 4 RMD - Field 2 (User Specific Data)

Bit Byte	7	6	5	4	3	2	1	0
0-2 047	(MSB) User Specific Data							(LSB)

The User Specific Data field is available for user specific data. This field may be used, otherwise this field *shall* be set to 0.

4.18.6.3.3 Format 4 RMD Field 3

Format 4 RMD Field 3 may contain Border Zone information and *shall* be recorded as follows.

Table 91 - Format 4 RMD - Field 3 (Border Zone Information)

Bit Byte	7	6	5	4	3	2	1	0
0-3	(MSB) Re-mapping block sector number for AP1							(LSB)
4-7	(MSB) Re-mapping block sector number for AP2							(LSB)
8-11	(MSB) Re-mapping block sector number for AP3							(LSB)
12-15	(MSB) Re-mapping block sector number for AP4							(LSB)
16-31	Reserved							
32-35	(MSB) Start Sector Number of Border-out #1							(LSB)
36-39	(MSB) Start Sector Number of Border-out #2							(LSB)
40-43	(MSB) Start Sector Number of Border-out #3							(LSB)
:	:							
2 036-2 039	(MSB) Start Sector Number of Border-out #502							(LSB)
2 040-2 043	(MSB) Start Sector Number of Border-out #503							(LSB)
2 044-2 047	(MSB) Start Sector Number of Border-out #504							(LSB)

The Re-mapping block sector number for AP#n field, if it contains other than 0, indicates that the first sector number of the alternative ECC block that contains the AP#n.

The Start Sector Number of Border-out #n field, if it contains other than 0, indicates that the start sector number of the Border-out.

4.18.6.3.4 Format 4 RMD Field 4

Format 4 RMD Field 4 contains RZone related information and *shall* be recorded as follows.

Table 92 - Format 4 RMD - Field 4 (RZone Information)

Bit Byte	7	6	5	4	3	2	1	0
0-1	(MSB) Invisible/Incomplete RZone Number (Last RZone Number)							(LSB)
2-3	(MSB) First Open RZone number							(LSB)
4-5	(MSB) Second Open RZone number							(LSB)
6-7	Third Open RZone number							
8-15	Reserved							
16-19	(MSB) Start Sector Number of Invisible RZone							(LSB)
20-23	(MSB) Layer Jump Address of Invisible RZone							(LSB)
24-27	(MSB) End sector number of Invisible RZone							(LSB)
28-31	(MSB) Last recorded address of Invisible RZone							(LSB)
32-35	(MSB) Previous Layer Jump Address of Invisible RZone							(LSB)
36-37	(MSB) Jump interval							(LSB)
38-47	Reserved							
48-51	(MSB) Start sector number of RZone #1							(LSB)
52-55	(MSB) Layer Jump Address of RZone #1							(LSB)
56-59	(MSB) End sector number of RZone #1							(LSB)
60-63	(MSB) Last recorded address of RZone #1							(LSB)
:	:							
2 032-2 035	(MSB) Start Sector number of RZone #125							(LSB)
2 036-2 039	(MSB) Layer Jump Address of RZone #125							(LSB)
2 040-2 043	(MSB) End sector number of RZone #125							(LSB)
2 044-2 047	(MSB) Last recorded address of RZone #125							(LSB)

The Invisible/Incomplete RZone Number field contains the Invisible/Incomplete RZone number of the medium. If the last RZone state is neither Invisible nor Incomplete due to disc finalization, this field contains the last Complete RZone number.

The First Open RZone number field, if recorded with value other than 0, contains the current appendable Reserved RZone number. If this field is set to 0, there is no Empty reserved RZone or Partially recorded reserved RZone corresponding to this field.

The Second Open RZone number field, if recorded with value other than 0, contains the current appendable Reserved RZone number. If this field is set to 0, there is no Empty reserved RZone or Partially recorded reserved RZone corresponding to this field.

The Third Open RZone number field, if recorded with value other than 0, contains the current appendable Reserved RZone number. If this field is set to 0, there is no Empty reserved RZone or Partially recorded reserved RZone corresponding to this field.

When the Incomplete RZone is closed, the Invisible/Incomplete RZone Number field contains the number of the new Invisible RZone number (N+1). When Reserved RZone is closed, the corresponding First (Second) Open RZone number field *shall* be set to 0.

The Start Sector Number of RZone #n field contains the start sector number of the RZone which has RZone number #n.

The Layer Jump Address of RZone #n field contains the physical Layer Jump Address of the RZone when Layer Jump recording is applied. When the RZone #n is a Reserved RZone, this field is set to a non-zero value.

The End sector number of RZone #n field contains the End sector number of Invisible RZone When Layer Jump recording is applied.

The Last Recorded Address of RZone #n field contains the last recorded address of the RZone which has RZone number #n. If this field is set to 0, this field is not valid. If RZone #n is not closed, the value of this field may not be correct and a link point search is required to determine the correct LRA.

Note: The LRA reported by the READ TRACK INFORMATION command is always correct.

When the RZone is not closed, even if the Last Recorded Address of RZone #n field contains a value, the logical unit *shall* determine the current LRA of the RZone. When RZone is closed, Last Recorded Address of RZone #n field *shall* be recorded before RZone padding.

4.18.6.3.5 Format 4 RMD Field 5 - Field 12

Format 4 RMD Field 5 through Field 12 may contain RZone related information continued from RMD Field 4.

Table 93 - Format 4 RMD - Field 5-Field 12 (RZone Information ... continued)

Bit Byte	7	6	5	4	3	2	1	0
0-3	(MSB) Start Sector Number of RZone #n							(LSB)
4-7	(MSB) Layer Jump Address of RZone #n							(LSB)
8-11	(MSB) End Sector Number of RZone #n							(LSB)
12-15	(MSB) Last Recorded Address of RZone #n							(LSB)
:	:							
2 032-2 035	(MSB) Start Sector Number of RZone #(n+127)							(LSB)
2 036-2 039	(MSB) Layer Jump Address of RZone #(n+127)							(LSB)
2 040-2 043	(MSB) End Sector Number of RZone #(n+127)							(LSB)
2 044-2 047	(MSB) Last Recorded address of RZone #(n+127)							(LSB)

The Start Sector Number of RZone #n field contains start sector number of the RZone which has RZone number #n.

The Layer Jump Address of RZone #n field contains the latest Layer Jump Address of the RZone which has RZone number #n.

The End sector number of RZone #n field contains the End sector number of the RZone which has RZone number #n.

The Last Recorded Address of RZone #n field contains the last recorded address of the RZone which has RZone number #n. If this field is set to 0, this field is not valid. If RZone #n is not closed, the value of this field may not be correct and a link point search is required to determine the correct LRA.

Note: The LRA reported by the READ TRACK INFORMATION command is always correct.

When the RZone is not closed, even if the Last Recorded Address of RZone #n field contains a value, the logical unit *shall* determine the current LRA of the RZone. When RZone is closed, Last Recorded Address of RZone #n field *shall* be recorded before RZone padding.

4.18.6.3.6 Format 4 RMD Field 13

Format 4 RMD Field 13 contains drive specific information and *shall* be recorded as defined in Table 94. There are eight sets of logical unit specific information blocks. These are prepared for the case of eight different DVD-R logical units writing to a disc. The unused fields in Format 4 RMD Field 13 *shall* be set to zero.

Table 94 - Format 4 RMD - Field 13 (Drive specific information)

Bit Byte	7	6	5	4	3	2	1	0
0-31	Drive manufacturer ID #1							
32-47	Serial Number #1							
48-63	Model Number #1							
64-66	Recorded RMA address (ECC block address) #1							
67-127	Drive specific data #1							
:	:							
896-927	Drive manufacturer ID #8							
928-943	Serial Number #8							
944-959	Model Number #8							
960-962	Recorded RMA address (ECC block address) #8							
963-1 023	Drive specific data #8							
1 024-2 047	Additional drive specific information for recorder #1							

The Drive Manufacturer ID #n field is recorded in binary and contains unique drive manufacturer identifier.

The Serial Number #n field is recorded in ASCII code and contains the serial number of the logical unit.

The Model Number #n field is recorded in ASCII code and contains the drive model number of the logical unit.

The Recorded RMA address #n field specifies the starting RMA address which is used to record RMD including the information of specific drive. This field *shall* be specified in ECC block address.

The Drive specific data #n field may be recorded to store the drive specific data. If this field is set to zero, this field is invalid.

The Additional Drive specific data for recorder #1 field may be recorded to store the additional drive specific data for logical unit #1. If this field is set to zero, this field is invalid.

4.18.6.3.7 Format 4 RMD Field 14

Format 4 RMD Field 14 is defined as follows.

Table 95 - Format 4 RMD-Field 14 (Versatile information)

Bit Byte	7	6	5	4	3	2	1	0
0	Flexible Outer Disc Testing Area flag							
1-4	Testing address of Flexible Outer Disc Testing Area on Layer 0							
5-8	Testing address of Flexible Outer Disc Testing Area on Layer 1							
9-12	Testing address of Inner Disc Testing Area on Layer 0							
13-16	Testing address of Inner Disc Testing Area on Layer 1							
17-20	Testing address of Outer Disc Testing Area on Layer 0							
21-24	Testing address of Outer Disc Testing Area on Layer 1							
25-28	Testing address of optional Inner Disc Testing Area on Layer 1							
29-2 015	Reserved							
2 016-2 017	Start pointer of Blank Area #1							
2 018-2 019	End pointer of Blank Area #1							
2 020-2 021	Start pointer of Blank Area #2							
2 022-2 023	End pointer of Blank Area #2							
2 024-2 025	Start pointer of Blank Area #3							
2 026-2 027	End pointer of Blank Area #3							
2 028-2 029	Start pointer of Blank Area #4							
2 030-2 031	End pointer of Blank Area #4							
2 032-2 033	Start pointer of Blank Area #5							
2 034-2 035	End pointer of Blank Area #5							
2 036-2 037	Start pointer of Blank Area #6							
2 038-2 039	End pointer of Blank Area #6							
2 040-2 041	Start pointer of Blank Area #7							
2 042-2 043	End pointer of Blank Area #7							
2 044-2 045	Start pointer of Blank Area #8							
2 046-2 047	End pointer of Blank Area #8							

When each Disc Testing Area are used, these Disc Testing Area filed are set. For detail information, see DVD-R Book Ver. 3.0.

Start pointer of Blank Area #n field specifies the nth Blank Area start location on L1. This field contains RZone number of RZone that is adjacent to outer side of the nth Blank Area. The start PSN of the nth Blank Area is calculated from the End sector number of the RZone.

End pointer of Blank Area #n field specifies the nth Blank Area end location on L1. This field contains RZone number of RZone that is adjacent to inner side of the nth Blank Area. The end PSN of the nth Blank Area is calculated from the Layer Jump Address of the RZone.

The RZone numbers listed in the Start/End pointer of Blank Area #n fields are sorted in ascending order.

See Figure 71 - *Small Reserved RZone* on page 182.

4.18.6.4 When RMD is written in RMA

Some RMD update conditions are added to DVD-R DL disc.

Usually, RMD may be cached in the logical unit memory. As occasion calls, RMD *shall* be written in RMA. By using RMD caching, the logical unit can avoid waste of RMA. The timing when RMD is written in RMA is shown in Table 96.

Table 96 - Mandatory RMD update condition in RMA

conditions
When a WRITE (10) command is issued following a RESERVE TRACK command, before the start of writing, RMD <i>shall</i> be written in RMA.
When a CLOSE TRACK/SESSION command is issued, before the start of the close operation for either RZone or Border, RMD <i>shall</i> be written in RMA.
When a SYNCHRONIZE CACHE (10) command is issued following SEND DISC STRUCTURE command which specifies User Specific Data.
Disc status specified in RMD Field 0 is changed (pre-recorded area information is included)
Start sector number of Border-out Area specified in RMD Field 3 is changed
Some Disc Testing Area specified in RMD Field 14 is newly used
Invisible RZone number, First Open RZone number, Second Open RZone number, or Third Open RZone specified in RMD Field4 is changed
The difference between the sector number of the last recorded sector in RZone #i and “Last recorded address of RZone #i” registered in the latest Format 1 RMD becomes larger than 32 MB
The number of recorded sector becomes larger than 32 MB in the case of Format 4 RMD is used
Layer Jump Address of Invisible/Incomplete RZone is specified by SEND DISC STRUCTURE command when LRA is on L0 ^a
Jump Interval in Format 4 RMD Field4 is set
Start sector number of Shifted Middle Area specified in Format 4 RMD Field 0 is changed
Re-mapping block sector number for AP#n (n = 1, 2, 3, 4) specified in Format 4 RMD Field 3 is changed
RZone number of Blank Area specified in Format 4 RMD Field 14 is changed

- a. During NWA is located on L1, the LJA specified by the command *shall not* be registered in RMD. After Layer Jump from L1 to L0 has happened and when host has sent data to be written on L0 part, the LJA *shall* be registered in RMD at appropriate timing.

When writing in the same Incomplete RZone for an extended period of time, RMD may not recorded for a long time. To force writing of the RMD, the host should close the Incomplete RZone after a certain time has passed. Then the new information is written into the RMA. Although the Invisible RZone number is increased due to the closing of the Incomplete RZone, the NWA of the new Invisible RZone is the same as the NWA of the closed Incomplete RZone.

Note: Updating RMD is not required as long as the sequence of data recording operation is in process by a disc recorder.

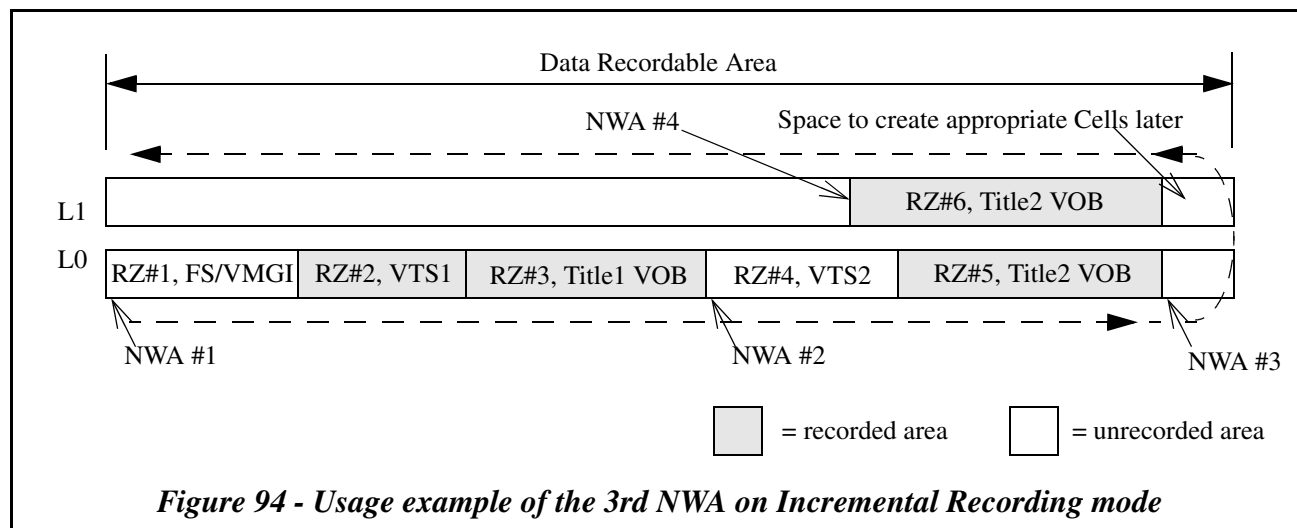
4.18.7 DVD-Video compatibility issues for DVD-R DL disc

4.18.7.1 Allocation rule of DVD Video format Cell

DVD Video Specification Part 3 specifies that a Cell *shall not* be located on different Layers, *shall* be terminated in one Layer. The Cells beside Layer jump *shall* be non-seamless. DVD-R DL disc has only OTP. The Layer Jump Address on OTP from L0 to L1 *shall* be ECC boundary. It is very difficult to encode such Cells. It is because that usually Cell boundary is not match with ECC block boundary. Usually Cells are encoded as seamless. If a recorded disc does not match with this Cell alignment rule, some DVD players cannot play the disc back from L0 to L1. The players freeze at the end of L0 typically.

4.18.7.2 Typical usage of the third reserved RZone

In case of Incremental-recording method, the Layer Jump Address is fixed at Fixed Middle Area position. In this case, treatment of Cell alignment at the Layer Jump Address is very difficult during real-time encoding/recording. It is necessary that such Cells are encoded and are recorded at later. To allow real-time stream recording without considering the Layer Jump Address alignment, the third reserved RZone may be used. The third reserved RZone that is assigned at the Layer Jump position may be recorded at the termination real-time recording.



4.18.7.3 Recommendation for multiple open RZone recording

In case of Incremental recording mode, RESERVE TRACK command is able to create NWA on L1. It is strongly recommended that when an application uses multiple of open RZones for its specific purpose, before writing from new NWA on L1, unrecorded area of L0 (e.g., RZ#1, RZ#4, and RZ#5 of Figure 94) should be recorded. In case of Figure 94, RZ#6 start address should be bigger than or equal to associated area of L0 (e.g., 2M - NWA #3 - 1). The size of RZ#4 should be smaller than 15 μ m radius width. Logical unit does not report any error even if the recording order is not kept.

4.19 Address Mode reservation

To make a new NWA on a sequential recording media, the RESERVE TRACK command is used. There are two kind of methods to create a new NWA.

1. To specify the Track/RZone reservation size (Size Mode reservation)
2. To specify the NWA of new Invisible RZone directly (Address Mode reservation)

The latter method is newly defined and is referred to as Address Mode reservation. The Address Mode reservation facilitates a host to specify NWA to the host desired location. In the former method, the host have to calculate Track/RZone gaps such as Run-in, Run-out or Linking Loss Area to allocate new NWA to the specific address. In particular, it is rather complicated when the disc is in Layer Jump recording mode on DVD-R Dual Layer disc due to Clearance or Blank Area. In the case of Address Mode reservation, the specified address *shall* be the multiple of blocking factor shown by the **Blocking** field of Random Readable Feature (0010h). If the specified address is not valid, the command *shall* be terminated with CHECK CONDITION status, 5/24/00 INVALID FIELD IN CDB.

In the case of Incremental recording the Address Mode reservation works for Incomplete Track/RZone in addition to Invisible Track/RZone except Fixed Packet mode (Method 2 Addressing) Incomplete Track of CD. The specified address *shall* be in between NWA of the Invisible/Incomplete Track/RZone and the end LBA of the Invisible/Incomplete Track/RZone on L0. In the case of Layer Jump recording mode, the Address Mode reservation works for Invisible RZone only. The specified address *shall* be an L0 address. A reservation may make two recording parts on L0 and L1.

In the case of DVD-R Incremental Recording mode, when NWA of the Incomplete Track/RZone is specified as reservation address, the recorded part of the Incomplete Track/RZone changes to Complete Track/RZone as shown in Figure 96. Unrecorded part changes to Invisible Track/RZone. When higher address than the NWA is specified for reservation address, a Reserved Track/RZone and new Invisible Track/RZone are made.

In the case of CD-R Incremental Recording mode, the reservation address *shall* be bigger than or equal to NWA + pre-gap size + link size as shown in Figure 96. Minimum Track size rule for new Reserved Track *shall* be kept. For more information, see RESERVE TRACK command.

After the Address Mode reservation, the number of free blocks of the Reserved RZone needs to be checked by READ TRACK INFORMATION command.

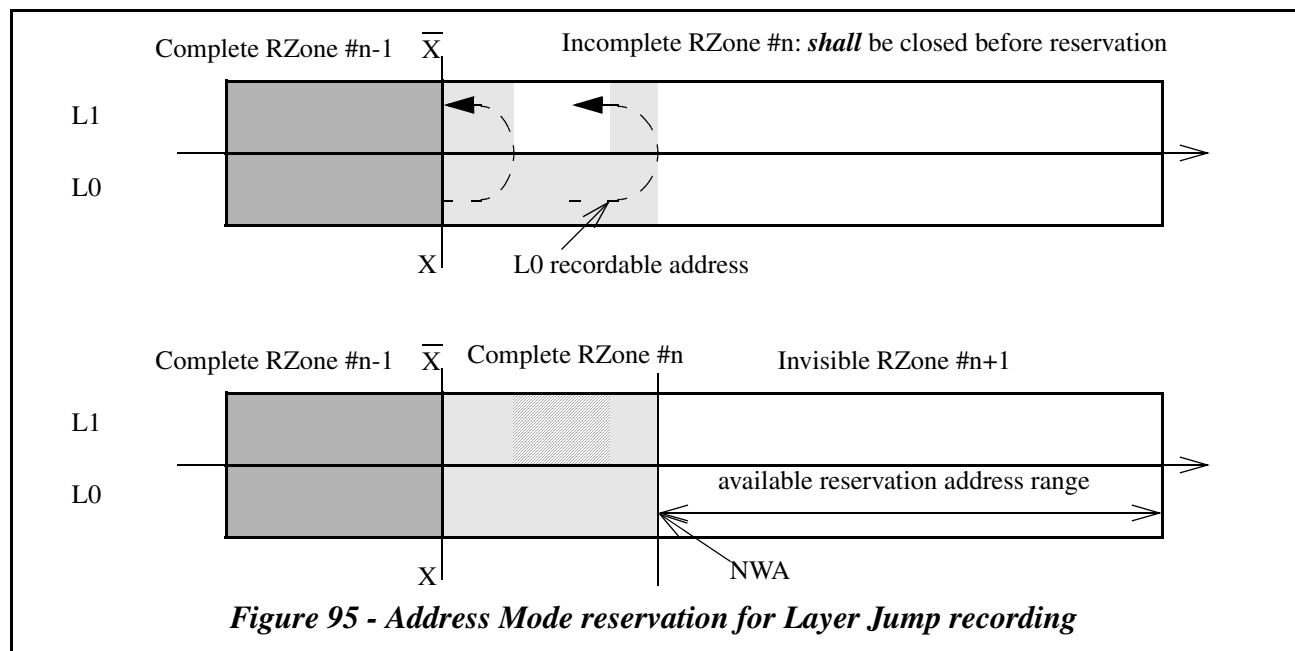
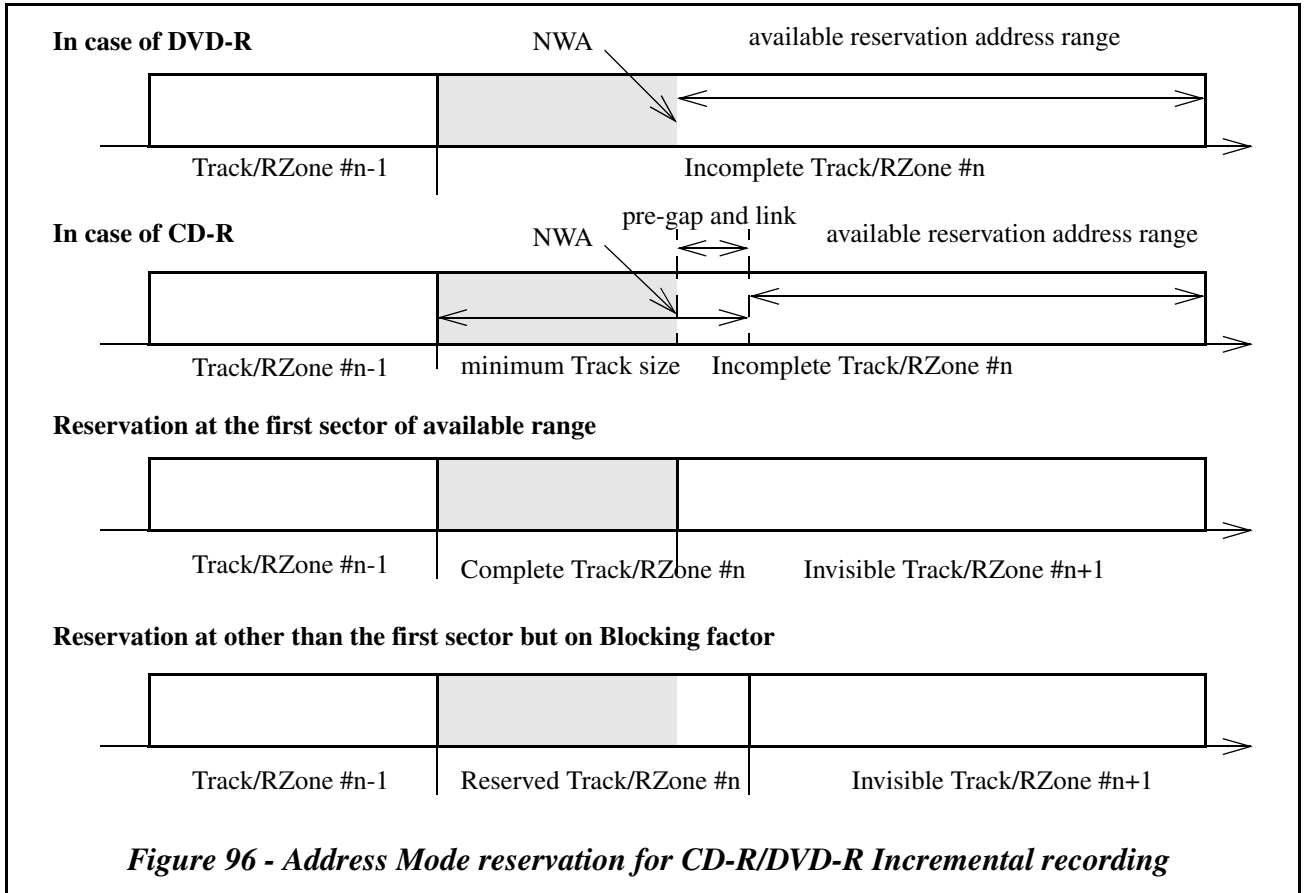


Figure 95 - Address Mode reservation for Layer Jump recording



4.20 Recording/reading for DVD-RW Single Layer media

4.20.1 Basics

DVD-RW Single Layer (SL) media has additional properties compared with DVD-R media. These properties are ability to overwrite and ability to erase.

The structure of DVD-RW SL media is the same as DVD-R SL media that complies with DVD-R SL Ver. 2.1 specification. DVD-RW SL medium consists of Power Calibration Area (PCA), Recording Management Area (RMA), Lead-in Area, Data Area and Lead-out Area. Data Area may contain Border Zones.

4.20.2 Recording mode

DVD-RW SL media supports two fundamentally different recording modes that are Sequential recording mode and Restricted overwrite mode. One of them is allowed on a disc surface. These two modes are able to be recognized by different format of Recording Management Data (RMD) that is recorded on the disc. See 4.20.5, "RMA structure" on page 229.

4.20.2.1 Sequential recording mode

The Sequential recording mode is provided to write data on DVD-RW SL media with the same manner as DVD-R. See Section 4.17, "Recording for DVD-R Single Layer media" on page 131. Overwriting is prohibited during this recording mode even if the mounted media is overwritable. However, the erasable functionality is available.

When a DVD-RW SL medium is in Sequential recording mode, the logical unit is only able to perform sequential recording (Disc-at-once or Incremental). The Write Type field in Write Parameters mode page is used to specify if Disc-at-once recording or incremental recording will be used. If a buffer under-run occurs during sequential recording, Lossless-Link may be performed. See Section 4.17.4.5, "Buffer under-run free recording" on page 136.

4.20.2.2 Restricted overwrite mode

The Restricted overwrite mode provides the restricted overwrite method to write user data on a DVD-RW medium. A format operation is required in advance to use the media as available for writing of user data using restricted overwrite method.

When a media is in Restricted overwrite mode, the logical unit is able to overwrite randomly within a formatted area on the media. If the last Bordered Area is intermediate state (See Section 4.20.4.4), the logical unit is able to append data from NWA that appears during intermediate state.

There are some restrictions when overwriting is performed on DVD-RW media. The logical unit is able to record data only by the multiple of ECC block length. Host *shall* write data in integral multiple of 16 sectors starting at a logical block address that is an integral multiple of 16. If a WRITE command does not start at the integral multiple of 16 logical block address, the command *shall* be terminated with CHECK CONDITION Status, 5/21/02 INVALID ADDRESS FOR WRITE. If Transfer Length field value of WRITE command is not an integral multiple of 16 sectors, the command *shall* be terminated with CHECK CONDITION Status, 5/24/00 INVALID FIELD IN CDB. The logical unit writes a series of ECC blocks sequentially without Linking Loss sectors. The logical unit does not perform hardware defect management, Read Modify Write, and Verify after Write. The logical unit does not use method 2 addressing of CD.

Write Parameters mode page *shall not* be used during Restricted overwrite mode.

Attempting to read an unwritten portion *shall* be caused CHECK CONDITION Status, 8/00/00 BLANK CHECK.

4.20.2.2.1 Restricted overwrite method

The logical unit starts writing from a Link position in the first Sync frame of an ECC block and stop writing at a Link position of an ECC block that is next ECC block of the last ECC block sent by the host. This is the basic operation of restricted overwrite.

For Restricted overwrite mode, the Data Type bit in physical ID of sector just before the ECC block by which writing is begun is not written by the logical unit. Any linking becomes Lossless-Link¹ during Restricted overwrite mode.

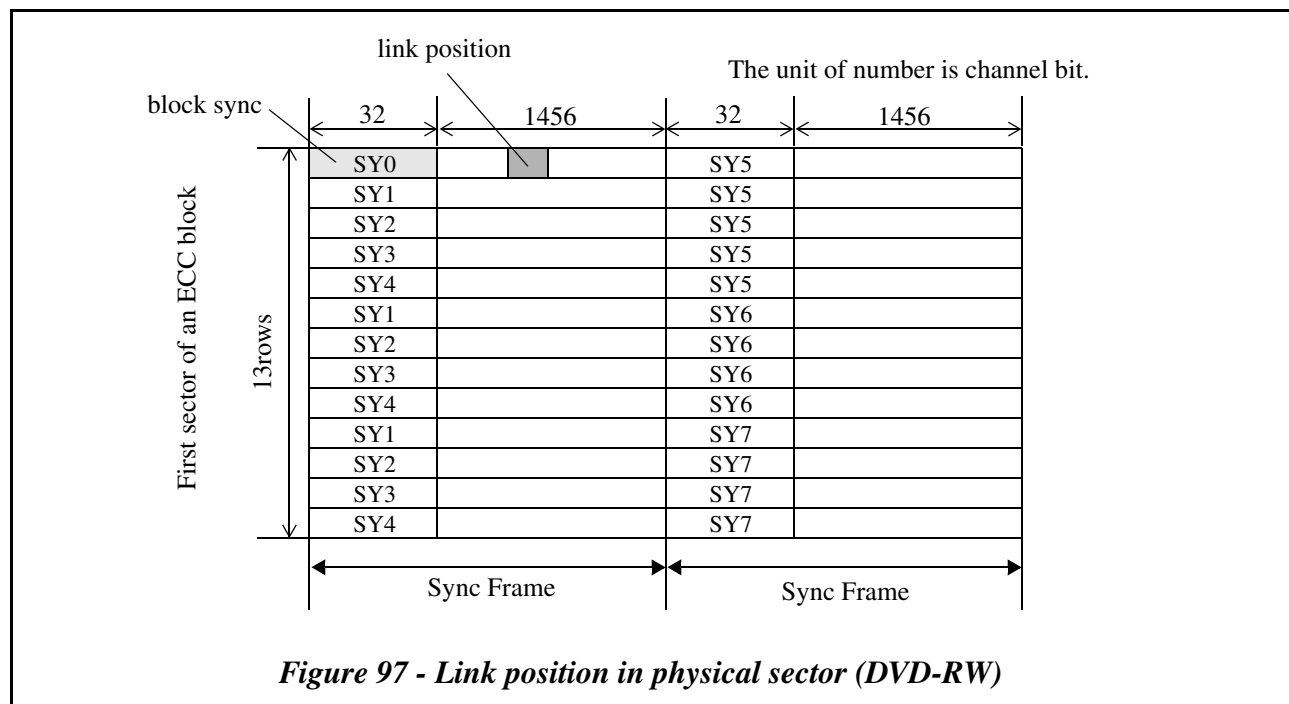
1. See 4.17.4.4, "Lossless-Link" on page 136.

4.20.2.3 Recording mode transition

When a physically blank DVD-RW SL disc is inserted into the DVD-RW logical unit, the disc is treated as in Sequential recording mode. The FORMAT UNIT command (Format Type = "Full" or "Quick") is used to format the DVD-RW SL media. When the medium is formatted, the logical unit and disc enter the Restricted overwrite mode and restricted overwrite method is available on the disc. To the contrary, the BLANK command (Blanking Type = "Blank the disc" or "Minimally blank the disc") is used to make the disc blank and the recording mode is changed to Sequential recording mode.

4.20.3 Link position

Any writing *shall* start/stop at a Link position. On DVD-RW media, Link position is located at between 15th and 17th bytes in the first sync frame of an ECC block as shown in Figure 97. Thus the first PI line of the ECC block by which writing is begun may be degraded. From an error correction point of view, the data in the PI line containing Link position are recovered by outer-code parity (PO) directional error correction.



4.20.4 Bordered Area state

A Bordered Area on DVD-RW SL media is classified into four different states according to its recording phase and recording mode. These states are called Empty, Incomplete, Complete, and Intermediate. The Intermediate state is newly defined for DVD-RW SL. Others are the same as defined in 4.17.11.5.3, "Border Zone status" on page 158. The relationship between recording mode and Bordered Area states are shown in Figure 99.

4.20.4.1 Empty state

When the disc is in Sequential recording mode and if Bordered Area contains no user data and no Lead-in/Border-in and Lead-out/Border-out are written for the Bordered Area, the Bordered Area is Empty state. When a Bordered Area is blanked by BLANK command (Blanking Type = Blank the disc, Minimally blank the disc, Erase the last Border), the Bordered Area is also considered as an Empty state.

When the disc is in Restricted overwrite mode, there is no empty state Bordered Area. Even if the last Bordered Area is complete state, empty state Bordered Area never appears on the disc during Restricted overwrite mode.

4.20.4.2 Incomplete state

When the disc is in Sequential recording mode and if user data is recorded without Lead-in/Border-in and Lead-out/Border-out of the Bordered Area, the Bordered Area is incomplete state. This state only appears during Sequential recording mode.

4.20.4.3 Complete state

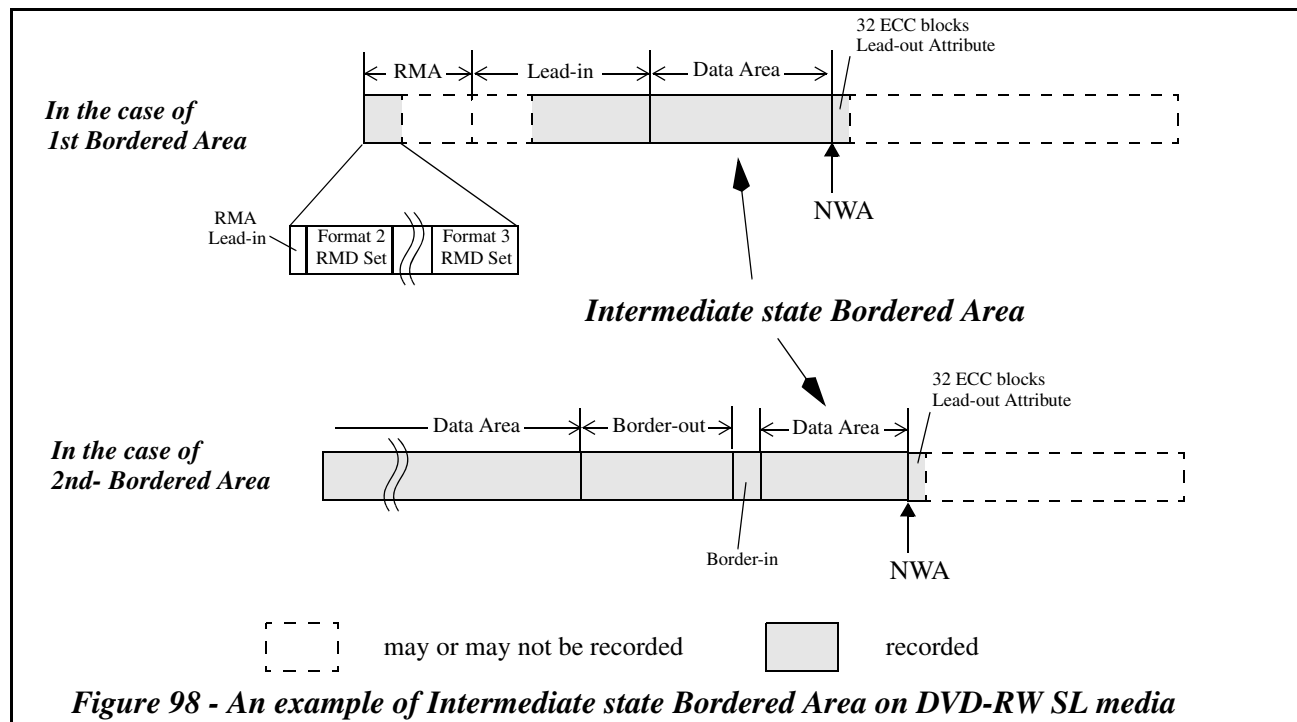
When the Lead-in/Border-in and Lead-out/Border-out of the Bordered Area are completely recorded, the Bordered Area is complete state.

4.20.4.4 Intermediate state

When there is only one Bordered Area on a disc, if a part of Lead-in¹ is recorded and 32 ECC blocks with Lead-out attribute are recorded after the end of user data, the Bordered Area is in the intermediate state.

When there are two or more Bordered Areas on a disc, if Border-in is recorded and 32 ECC blocks with Lead-out attribute are recorded after the end of user data, the Bordered Area is in the intermediate state. The intermediate state only appears at the last Bordered Area during Restricted overwrite mode. Figure 98 shows an example of Intermediate state Bordered Area on DVD-RW SL media.

When the last Bordered Area is in Intermediate state, Starting PSN of Data Area field and Last recorded address of last RZone in the Bordered Area field in Physical Format Information of the last Lead-in/Border-in *shall* be set to 30000h. Start PSN of the current Border-out field and Start PSN of the next Border-in field in the DVD-RW unique part of the Physical Format Information of the last Lead-in/Border-in *shall* be set to 00h.



4.20.4.5 Data writing on an intermediate state Bordered Area

When a Bordered Area is in an intermediate state, the logical unit reports the NWA where the last addressable block plus 1 of the intermediate Bordered Area. See Figure 98. The medium can be overwritten within a Bordered Area less than the NWA and data is sequentially appendable from the NWA to the full capacity of a disc. When data is written across the

1. At least RW-Physical format information Zone, Reference Code Zone, Buffer Zone 1, and Extra Border Zone *shall* be recorded.

NWA, 32 ECC blocks with Lead-out attribute *shall* be recorded at each stop of writing. The NWA is reported by READ TRACK INFORMATION command.

When the size of an intermediate state Bordered Area is increased by any value more than 4 Mbytes since the last RMD is written in RMA, and the recording pauses, and the logical unit estimates that there is enough time, the last recorded address *shall* be registered in the End Sector Number of RZone #n field of the valid Format 3 RMD. This information is used to search NWA or to recover an incomplete recording on the intermediate Bordered Area.

When the logical unit detects the intermediate state Bordered Area, the logical unit *shall* search the ECC blocks with Lead-out attribute from the last recorded address registered in the End Sector Number of RZone #n field to recognize the NWA. If the logical unit cannot detect any ECC blocks with Lead-out attribute within the appropriate area after the last recorded address registered in the End Sector Number of RZone #n field, the RZone is considered as damaged (Damage = 1, NWA_V = 1). The automatic repair *shall* be performed. The NWA *shall* be set to the next sector of the last recorded address registered in the Format Information 2 field. When a WRITE is applied on the NWA, and the recording pauses, the logical unit *shall* record 32 ECC blocks with Lead-out attribute.

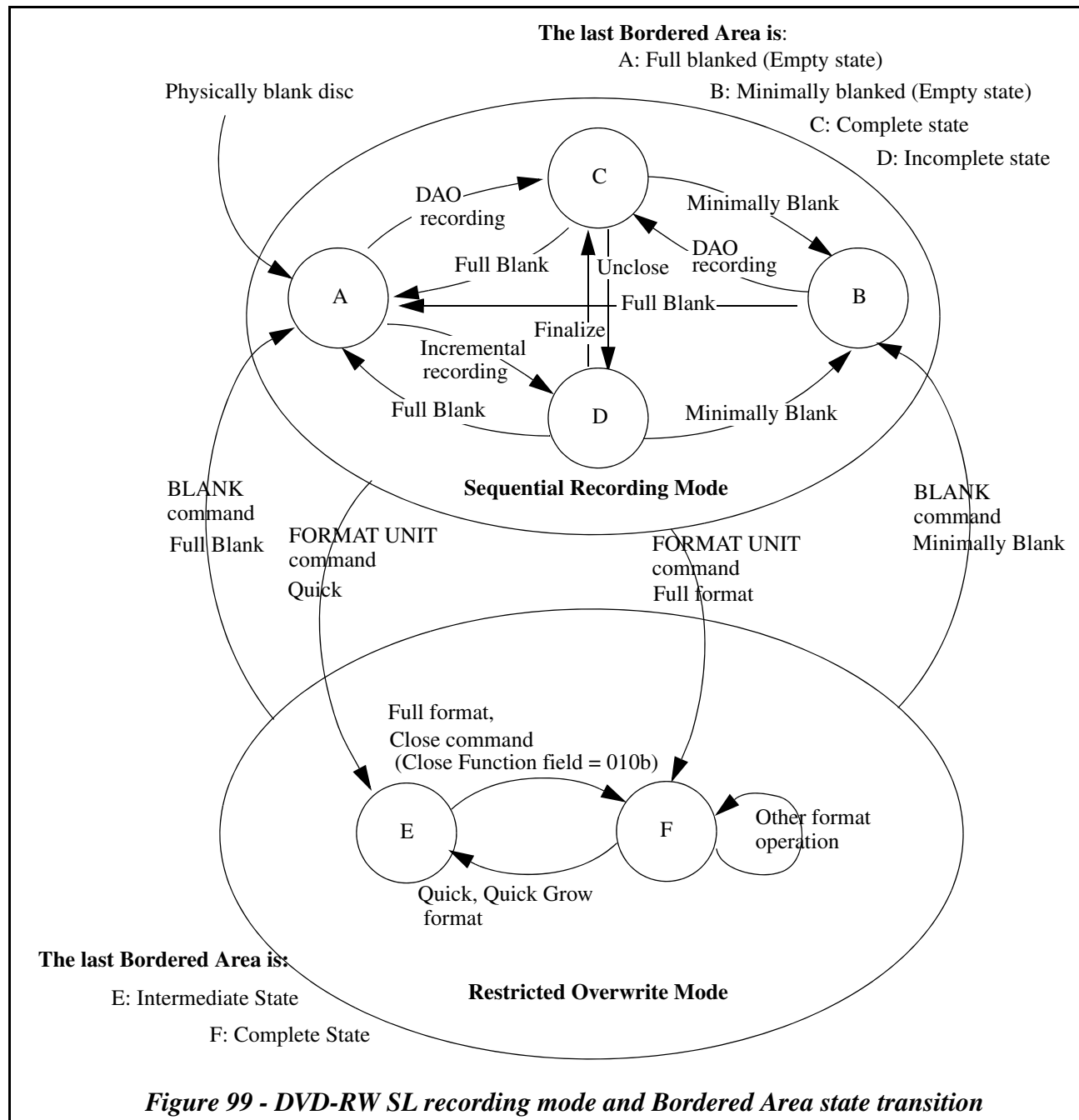
To change the intermediate state Bordered Area to complete state, CLOSE TRACK/SESSION command (Close Function=010b) is used.

4.20.4.6 Multi-border on DVD-RW SL media

For DVD-RW SL Restricted Overwritten media, multiple Bordered Areas are allowed up to 16. The structure and method for recognition of Multi-border disc is the same as the case of DVD-R. However, it is different in DVD-RW SL media that there is no Next Border Marker in Border-out. See Figure 54 - *Pointers for multi-Border recognition* on page 161.

4.20.4.7 Recording mode and Bordered Area state transition

Figure 99 shows the relationship between Recording mode and Bordered Area state transition.



4.20.5 RMA structure

Three kinds of RMD formats are defined for DVD-RW SL media. They are Format 1, Format 2, and Format 3 RMDs. The Format 1 RMD is used only for Sequential recording mode. The Format 3 RMD is used only for Restricted overwrite mode. The Format 2 RMD is used for both recording mode. The physical format of an RMD block is the same as an ECC block. The RMD block consists of 15 Fields and a Linking Loss Area. The Linking Loss Area and each Field is 2 KB in size.

RMA logical structure and RMD usage are different between Sequential recording mode and Restricted overwrite mode.

4.20.5.1 RMA structure for Sequential recording mode

When a DVD-RW SL media is in Sequential recording mode, Format 1 RMD and Format 2 RMD are used and the RMA is logically divided into two parts.

The first part is located at the beginning of RMA and consists of an RMA Lead-in and five Format 2 RMD blocks. Each of these five Format 2 RMD blocks *shall* contain same data except RBG Information field. These five RMD blocks are referred to as RMD Set. The first part is mainly used for storing the erase status information.

The second part is remaining area of the RMA. The second part is used as same manner with DVD-R recording and contains 695 RMD blocks. The Format 1 RMD *shall* be used in the second part.

The RMA logical structure for Sequential recording mode is shown in Figure 100.

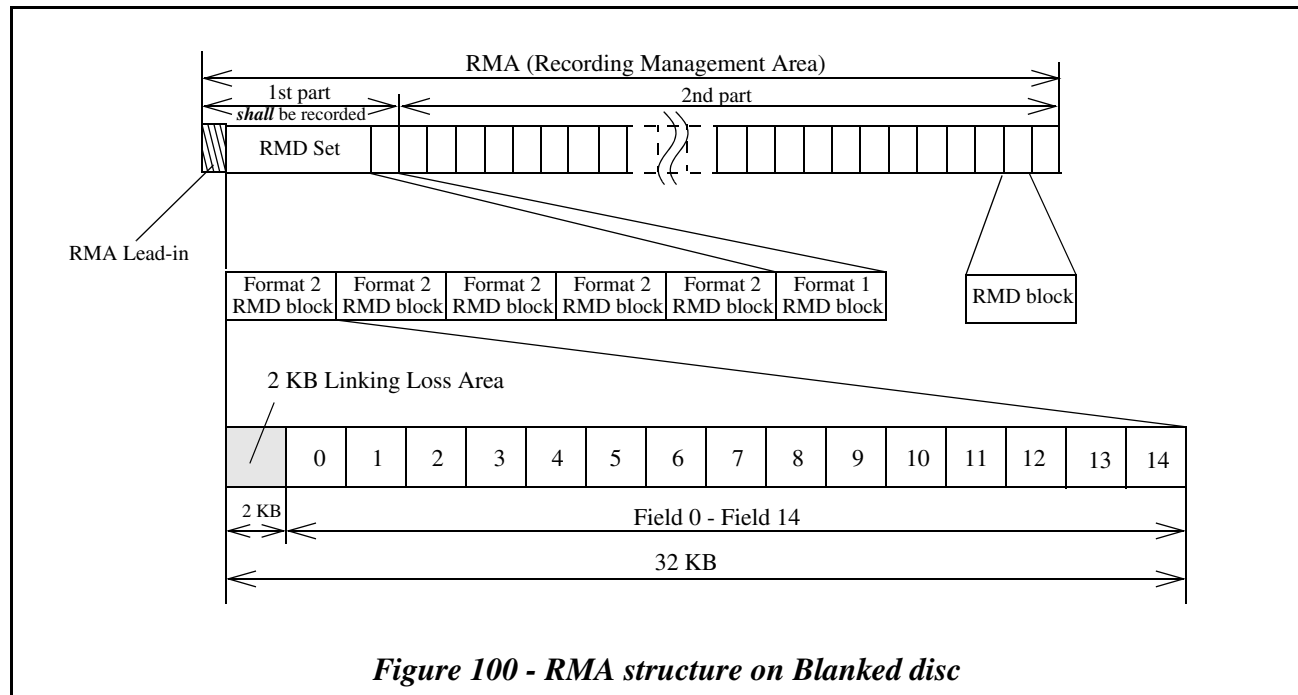


Figure 100 - RMA structure on Blanked disc

4.20.5.2 RMA structure for Restricted overwrite mode

When the DVD-RW media is in Restricted overwrite mode, the RMA is divided into five RMA Segments. Each RMA Segment is constant in length and is divided into 28 RMD Sets. Each RMD Set consists of five RMD blocks. The contents of all five RMD blocks in the RMD Set are equivalent except RBG Information field. This redundancy is only for error tolerance.

The RMA logical structure for Restricted overwrite mode is shown in Figure 101.

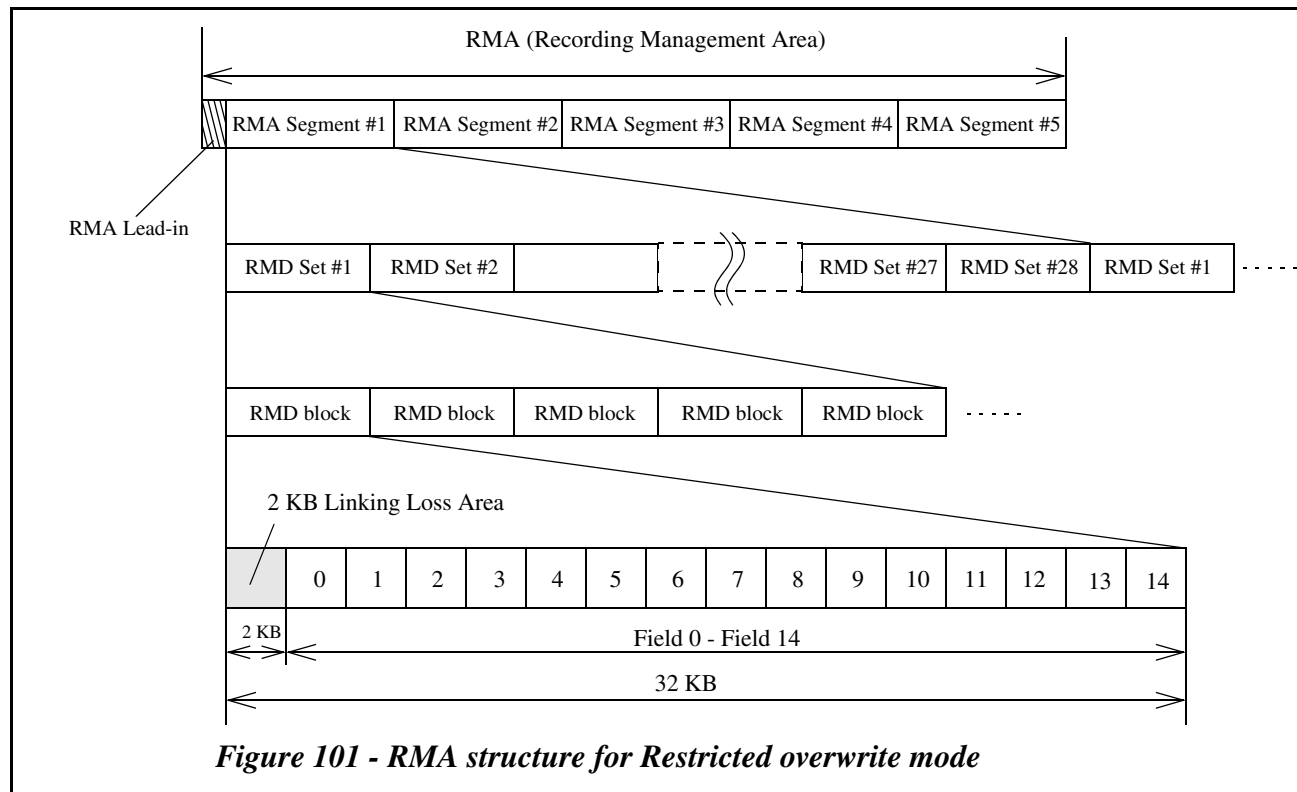


Figure 101 - RMA structure for Restricted overwrite mode

The Format 2 RMD blocks *shall* be recorded in the first RMD Set of an RMA Segment. The Format 3 RMD blocks *shall* be recorded as an RMD Set and are located other than the first RMD Set of an RMA Segment. There is only one pair of valid Format 2 RMD Set and Format 3 RMD Set in the RMA. The valid Format 2 RMD contains pointer to the current valid Format 3 RMD Set in the same RMA Segment.

4.20.6 RMD contents for DVD-RW SL media

All the initial value of RMD is 0. The RMD structures described in this section are defined by DVD-RW SL Ver. 1.2. For the other versions of DVD-RW discs, see applicable DVD-RW Book for the RMD structures.

4.20.6.1 RMD Header - Field 0

The RMD Field 0 (RMD Header) is commonly used by every format of RMD and specifies the general information of the disc and *shall* be recorded as follows. Table 97 shows the structure of RMD Field 0.

Table 97 - RMD Header - Field 0

Bit Byte	7	6	5	4	3	2	1	0
0-1	(MSB) RMD Format							(LSB)
2	Disc Status							
3	Reserved							
4-21	(MSB) Unique Disc ID							(LSB)
22-85	(MSB) Copy of Pre-pit Information							(LSB)
86-127	Reserved							
128	RBG Information							
129-2 047	Reserved							

The RMD Format field *shall* be recorded and specifies the format of the following RMD Field 1- Field 14 which is used on the medium. RMD Format field is defined in Table 98.

Table 98 - RMD Format field definition

Value	Definition
0	Reserved
1	The following RMD Field 1-14 are recorded as Format 1 RMD specified in DVD-RW SL Ver. 1.2.
2	The following RMD Field 1-14 are recorded as Format 2 RMD specified in DVD-RW SL Ver. 1.2.
3	The following RMD Field 1-14 are recorded as Format 3 RMD specified in DVD-RW SL Ver. 1.2.
4	Reserved
5-65 535	Reserved

The Disc Status field indicates the disc status. Disc Status field is defined in Table 99.

The most significant bit of the Disc Status field indicates whether the disc is write protected or not. If the most significant bit of the Disc Status field is set to 1, the disc is write protected. Otherwise, the disc is not write protected. When the Disc Status is 05h, 10h, or 11h, the most significant bit *shall not* be set.

Table 99 - Disc Status field definition

Value	Definition	Available RMD Format
Not Write Protected		
00h	The disc has no written data in Data Recordable Area (only RMDs are written) In the case of Format 2 RMD block, this status indicates that the disc is in Sequential recording mode and its current disc status is specified by the Disc Status field of valid Format 1 RMD block.	All
01h	The disc is in Disc-at-once recording mode	Format 1
02h	The disc is in Incremental recording mode	Format 1
03h	The disc is the finalized disc in the case of Incremental recording	Format 1
04h	The disc is minimally blanked	Format 1
05h	The erase operation is in progress on the disc	Format 1
06h-0Fh	Reserved	-
10h	The disc is in Restricted overwrite mode. Its current disc status is specified by Disc Status field of Format 3 RMD block.	Format 2
11h	The formatting of a border is in progress on the disc	Format 1, 3
12h	The disc is in Restricted overwrite mode	Format 3
13h	The last Bordered Area is in the Intermediate state	Format 3
14h-7Fh	Reserved	-
Write Protected		
80h	The disc has no written data in Data Recordable Area (only RMDs are written) and write protected except R-Information area	Format 1, 3
81h	The disc is in Disc-at-once recording mode and write protected except R-Information area	Format 1
82h	The disc is in Incremental recording mode and write protected except R-Information area	Format 1
83h	The disc is the finalized disc in the case of Incremental recording and write protected except R-Information area	Format 1
84h	The disc is minimally blanked and write protected except R-Information area	Format 1
85h-91h	Reserved	-

Table 99 - Disc Status field definition (continued)

Value	Definition	Available RMD Format
92h	The disc is in Restricted overwrite mode and write protected except R-Information area	Format 3
93h	The last Bordered Area is in Intermediate state and write protected except R-Information area	Format 3
94h-FFh	Reserved	-

Unique Disc ID field *shall* be recorded and structured as specified in Table 53 - *Unique Disc ID* on page 148.

Copy of Pre-pit Information field contains the copy of Pre-pit Information data that is recorded as LPP (Land Pre-Pit) on DVD-RW media. Copy of Pre-pit Information structure is shown in Table 100. Pre-pit information data is specified by DVD-RW Book Part 1.

Table 100 - Copy of Pre-pit Information

Bit Byte	7	6	5	4	3	2	1	0
22	Field ID (= 01h)							
23	Application code							
24	Disc Physical code							
25-27	(MSB)	Last address of Data Recordable Area						(LSB)
28	LPP Part Version				Extension code			
29	Reserved							
30	Field ID (= 02h)							
31	OPC suggested code (Recording power)							
32	OPC suggested code (Erasing power)							
33-36	1 st field of Write Strategy code							
37	Reserved							
38	Field ID (= 03h)							
39-44	1 st field of Manufacturer ID							
45	Reserved							
46	Field ID (= 04h)							
47-52	2 nd field of Manufacturer ID							
53	Reserved							
54	Field ID (= 05h)							
55-60	2 nd field of Write Strategy code							
61-85	Reserved							

The RMD Block Group Information (RBG Information) field is structured as Table 101. This field *shall* be used when RMD blocks are recorded sequentially with same contents. The RMD blocks that are recorded sequentially with the same contents (except RBG Number field) is referred to as RMD Block Group. The RMD blocks of RMD Block Group have the same RBG Length value. The RBG Number value starts from 1 and is increased by 1 up to RBG Length value in the RMD blocks of RMD Block Group. If only one RMD block is recorded in order to update RMD contents, RBG Length and RBG Number of each RMD block *shall* be set to 1. If this field is set to 0, this field is invalid.

Table 101 - RBG Information field definition

Bit Byte	7	6	5	4	3	2	1	0
128	RBG Number				RBG Length			

4.20.6.2 Format 1 RMD Field 1

Format 1 RMD Field 1 contains some logical unit and OPC related information. Table 102 shows the structure of Format 1 RMD Field 1.

There are four sets of OPC data blocks. These are prepared for the case of four different DVD-RW logical units writing to a disc. The logical unit *shall* use an empty set or its own. If there is no owned or empty OPC data block, the logical unit may use the oldest time stamp OPC data block.

Table 102 - Format 1 RMD Field 1 (logical unit and OPC information)

Bit Byte	7	6	5	4	3	2	1	0
0-31	Drive Manufacturer ID #1							
32-47	Serial Number #1							
48-63	Model Number #1							
64-67	1 st field of Write Strategy Code #1							
68-71	Recording Power #1							
72-79	Time stamp #1							
80-83	Power Calibration Address #1							
84-107	Running OPC Information #1							
108-113	2 nd field of Write Strategy Code #1							
114-115	Reserved							
116-117	Recording Power by the 8-bit coded power #1							
118-127	Reserved							
:	:							
384-415	Drive Manufacturer ID #4							
416-431	Serial Number #4							
432-447	Model Number #4							
448-451	1 st field of Write Strategy Code #4							
452-455	Recording Power #4							
456-463	Time stamp #4							
464-467	Power Calibration Address #4							
468-491	Running OPC Information #4							
492-497	2 nd field of Write Strategy Code #4							
498-499	Reserved							
500-501	Recording Power by the 8-bit coded power #4							
502-511	Reserved							
512-2 047	Reserved							

Drive Manufacturer ID #n field is recorded in binary and specifies unique drive manufacturer identifier of the DVD-RW logical unit.

Serial Number, Model Number, Recording Power, Timestamp, Power Calibration Address, Running OPC Information fields definitions are the same as specified in 4.17.11.2.1, "Format 1 RMD Field 1" on page 149.

1st field of Write Strategy Code #n field specifies the write strategy code of the Write Strategy type 1 in the pre-pit data block of Field ID 2. Write strategy code is specified by DVD-RW Book Part 1.

2nd field of Write Strategy Code #n field specifies the write strategy code of the Write Strategy type 2 in the pre-pit data block of Field ID 5. Write strategy code is specified by DVD-RW Book Part 1.

Recording Power by the 8-bit coded power #n field may be used to specify the recording power value of the OPC result by using the 8-bit coded power. This value may be the expected output from the objective lens of the Pickup Head Unit in a logical unit that OPC was performed. The 8-bit coded power indicates the Laser power value as a number n between 1 to 255. See Table 103. If this field is set to 0, this field is invalid.

Table 103 - 8-bit coded power definition

n	Laser Power
1-200	n/10 [mW]
201-255	Reserved

4.20.6.3 Format 1 RMD Field 2 to Field 14

The definitions of Format 1 RMD Field 2 to Field 14 are the same as defined in 4.17.11.2.2, "Format 1 RMD Field 2" on page 151 through 4.17.11.2.7, "Format 1 RMD Field 14" on page 155.

4.20.6.4 Format 2 RMD Field 1

The Format 2 RMD Field 1 contains pointer to the start address of the Format 3 RMD Set in the same RMA Segment.

Table 104 - Format 2 RMD Field 1 (Pointer to Format 3 RMD Set)

Bit Byte	7	6	5	4	3	2	1	0
0-3	(MSB) Update Counter							(LSB)
4-7	(MSB) Format 3 RMD Set Pointer							(LSB)
8-11	Reserved							
12-13	(MSB) Erase Operation Counter							(LSB)
14-15	Reserved							
16	RSDS #8	RSDS #7	RSDS #6	RSDS #5	RSDS #4	RSDS #3	RSDS #2	Reserved
17	RSDS #16	RSDS #15	RSDS #14	RSDS #13	RSDS #12	RSDS #11	RSDS #10	RSDS #9
18	RSDS #24	RSDS #23	RSDS #22	RSDS #21	RSDS #20	RSDS #19	RSDS #18	RSDS #17
19	Reserved				RSDS #28	RSDS #27	RSDS #26	RSDS #25
20-2 047	Reserved							

The Update Counter field contains the number of times to which this RMD Set is rewritten. The initial value of this field is 0. The value of this field *shall* be incremented by 1 when this field is rewritten. The value is taken over and is also incremented when the RMA Segment that is used to record RMD Set is changed. In the case of Restricted overwrite mode, this value is used to determine which RMA Segment is current.

The Format 3 RMD Set Pointer field contains pointer to start address of the latest Format 3 RMD Set in this RMA Segment. The indicated RMD Set contains Format 3 RMD blocks. In the case of Sequential recording mode, this field *shall* be set to 0.

The Erase Operation Counter field contains the number of times that Disc Erase operation is performed. The value of this field *shall* be incremented by 1 when the disc is erased. The initial value of this field is 0.

The RMA Segment Defect Status (RSDS #n) bit indicates whether the Format 3 RMD Set in the RMA Segment is defective or not. If set to 1, the RMD Set #n of the RMA Segment is defective (EDC error occur in at least 3 RMD blocks of an RMD Set). Otherwise the RMD Set #n of the RMA Segment is non-defective. In the case of Sequential recording mode, this field *shall* be set to 0.

4.20.6.5 Format 2 RMD Field 2

The Format 2 RMD Field 2 contains the information of erase operation. In the case of Restricted overwrite mode, these fields *shall* be set to 0.

Table 105 - Format 2 RMD Field 2 (Erase Operation Information)

Bit Byte	7	6	5	4	3	2	1	0	
0	Erase Operation Code								
1	Reserved								
2-5	(MSB)				Erase Information 1				(LSB)
6-9	(MSB)				Erase Information 2				(LSB)
10-2 047	Reserved								

The Erase Operation Code field contains the Operation Code of the erase operation.

The Erase Information 1, 2 fields contain the information related with Erase Operation Code.

The Erase Operation Code and Erase Information 1, 2 are defined in Table 106.

Table 106 - Erase Operation Code and Erase Information fields definition

Erase Operation Code	Erase Information 1	Erase Information 2	Erase Operation type
0	-	-	No erase operation is in progress.
1	Start PSN of Erasing ^a	Marker PSN ^b	Blank the Disc
2	Start PSN of Erasing	Marker PSN	Minimally blank the Disc
3, 4	-	-	Reserved
5	Start PSN of Erasing	Marker PSN	Blank an RZone Tail ^c
6	Start PSN of the last Border-in ^d	Marker PSN	Unclose the last Border
7	Start PSN of Erasing	Marker PSN	Erase the last Border
8 and above	-	-	Reserved

a. Start PSN of Erasing contains the Physical Sector Number of the first sector of the ECC block where the specified erase operation *shall* be started.

b. Marker PSN contains the Physical Sector Number of the last sector of the ECC block where the erase operation *shall* be finished.

c. If “Unreserve an RZone” operation is requested by BLANK command, this Erase operation type is also used. If the last RZone is incomplete state, the entire Incomplete RZone is erased. If the last RZone is Invisible RZone, the Invisible RZone number is decremented by one and the RZone that just before the Invisible RZone is erased.

d. This field contains PSN of Linking loss sector just before the Border-in.

4.20.6.6 Format 2 RMD Field 3 to Field 14

Format 2 RMD Field 3 through Field 14 are reserved for future standardization and *shall* be set to 00h.

4.20.6.7 Format 3 RMD Field 1

The Format 3 RMD Field 1 contains some logical units and OPC related information as defined in Table 102 - *Format 1 RMD Field 1 (logical unit and OPC information)* on page 234.

4.20.6.8 Format 3 RMD Field 2

The Format 3 RMD Field 2 contains user specific data as defined in Table 56 - *Format 1 RMD - Field 2 (User specific data)* on page 151.

4.20.6.9 Format 3 RMD Field 3

The Format 3 RMD Field 3 contains Border Zone and RZone related information and *shall* be recorded as shown in Table 107. The maximum number of Border Zone is 16 and each Bordered Area has only one RZone. This Field also contains the information of the format operation.

Table 107 - Format 3 RMD Field 3 (Border Zone and RZone Information)

Bit Byte	7	6	5	4	3	2	1	0
0	Format Operation Code							
1	Reserved							
2-5	(MSB) Format Information 1				(LSB)			
6-9	(MSB) Format Information 2				(LSB)			
10-13	Reserved							
14-17	(MSB) Start PSN of the Border-out #1				(LSB)			
18	Reserved						Defect #1	BAM #1
19-21	Reserved							
22-25	(MSB) Start PSN of the Border-in #2				(LSB)			
26-29	(MSB) Start PSN of the Border-out #2				(LSB)			
30	Reserved						Defect #2	BAM #2
31-33	Reserved							
:	:							
190-193	(MSB) Start PSN of the Border-in #16				(LSB)			
194-197	(MSB) Start PSN of the Border-out #16				(LSB)			
198	Reserved						Defect #16	BAM #16
199-201	Reserved							
202-255	Reserved							
256-257	(MSB) Last RZone Number				(LSB)			
258-261	(MSB) Start Sector Number of RZone #1				(LSB)			
262-265	(MSB) End Sector Number of RZone #1				(LSB)			
:	:							
378-381	(MSB) Start Sector Number of RZone #16				(LSB)			
382-385	(MSB) End Sector Number of RZone #16				(LSB)			
386-2 047	Reserved							

The Format Operation Code field contains the Operation Code of the format operation.

The Format Information 1, 2 contain the information related with Format Operation Code.

The meaning of Format Operation Code and Format Information 1, 2 are defined in Table 108.

Table 108 - Format Operation Code and Format Information fields definition

Format Operation Code	Format Information 1 field	Format Information 2 field	Format operation
0	invalid	invalid	No format operation is in progress.
1	Start PSN ^a	Number of ECC blocks ^b	Full Format
2	Start PSN	Number of ECC blocks	Grow the last Border Format
3	Start PSN	Number of ECC blocks	Add Border Format
4	Start PSN	Number of ECC blocks ^c	Quick Grow the last Border Format
5	Start PSN	Number of ECC blocks ^c	Quick Add Border Format ^d
6	Start PSN	Marker PSN ^e	Close the Intermediate Border
7 and above	-	-	Reserved

- Start PSN contains the start Physical Sector Number of the first sector of the ECC block where the specified format operation **shall** be started. The start address should be other than the addresses where the RMD block that is to be updated for the format operation.
- Number of ECC blocks contains the value that is the number of user data ECC blocks to be formatted by the specified format operation.
- At completion of the format operation, this field **shall** be set to last recorded address of the formatted Bordered Area. See 4.20.4.5, "Data writing on an intermediate state Bordered Area" on page 227.
- When "Quick" format operation is requested by FORMAT UNIT command, this Format Operation Code value is also used. The Start PSN value is set to the beginning of a part of Lead-in that is less than 30000h and only one intermediate state Bordered Area is created on a medium.
- Marker PSN contains the Physical Sector Number of the last sector of the ECC block where the close operation **shall** be finished. (last sector number of Border-out)

The Start Sector Number of Border-out #n field indicates that the start sector number of the Border-out which belongs to Bordered Area #n. If this field contains 0, this field is invalid.

The Defect #n bit of 1, indicates that the critical portion¹ of the Bordered Area is defective¹.

The BAM #n (Bordered Area Modification) bit of 1, indicates that the write operation is done within the Bordered Area #n at least once.

The Start Sector Number of Border-in #n field indicates that the start sector number of the Border-in which belongs to Bordered Area #n. If this field contains 0, this field is invalid.

The Last RZone Number field contains the last RZone number of the medium.

The Start Sector Number of RZone #n field contains the start sector number of the RZone which has RZone number #n.

The End Sector Number of RZone #n field contains the end address of the RZone which has RZone number #n. Start PSN of current Border-out field value of Border-in is the next sector of End Sector Number of RZone #n (where #n is maximum). In the case of Intermediate state Border, these field should be updated at appropriate period. If this field contains 0, this field is invalid.

4.20.6.10 Format 3 RMD Field 4 to Field 12

Format 3 RMD Field 4 through Field 12 contains the Defect Status Bitmap.

1. The definition is an application specific.

Table 109 - Format 3 RMD Field 4 (Defect Status Bitmap)

Bit Byte	7	6	5	4	3	2	1	0	
0-3	(MSB) PSN of Previous Defect Status Bitmap RMD Set							(LSB)	
4-7	(MSB) Certification Start PSN							(LSB)	
8-11	(MSB) Certification End PSN							(LSB)	
12	DS #8	DS #7	DS #6	DS #5	DS #4	DS #3	DS #2	DS #1	
13	DS #16	DS #15	DS #14	DS #13	DS #12	DS #11	DS #10	DS #9	
14	DS #24	DS #23	DS #22	DS #21	DS #20	DS #19	DS #18	DS #17	
:	:	:	:	:	:	:	:	:	
2 045	DS #16272	DS #16271	DS #16270	DS #16269	DS #16268	DS #16267	DS #16266	DS #16265	
2 046	DS #16280	DS #16279	DS #16278	DS #16277	DS #16276	DS #16275	DS #16274	DS #16273	
2 047	DS #16288	DS #16287	DS #16286	DS #16285	DS #16284	DS #16283	DS #16282	DS #16281	

PSN of Previous Defect Status Bitmap RMD Set field contains start physical sector number of RMD Set that contains previously generated Defect Status Bitmap. If this field contains 0, this field is invalid.

Certification Start PSN field contains the start sector number of the ECC block where the following Defect Status Bitmap starts. If this field contains 0, this field and subsequent fields (Certification End PSN, DS #n) are invalid.

Certification End PSN field contains the end sector number of the ECC block where the following Defect Status Bitmap ends.

DS #n bit may contain certification result of the ECC block #n. When DS #n bit is set to 0, indicate that the ECC block has no defect and is able to read and write the block safely (no EDC error occurs in the ECC block). When DS #n bit is set to 1, indicates that the ECC block has defect and might not be able to read and write the block safely (an EDC error occurs in the ECC block).

Table 110 - Format 3 RMD Field 5 - Field 12 (Defect Status Bitmap)

Bit Byte	7	6	5	4	3	2	1	0
0	DS #(n+7)	DS #(n+6)	DS #(n+5)	DS #(n+4)	DS #(n+3)	DS #(n+2)	DS #(n+1)	DS #n
1	DS #(n+15)	DS #(n+14)	DS #(n+13)	DS #(n+12)	DS #(n+11)	DS #(n+10)	DS #(n+9)	DS #(n+8)
:	:	:	:	:	:	:	:	:
2 046	DS #(n+16375)	DS #(n+16374)	DS #(n+16373)	DS #(n+16372)	DS #(n+16371)	DS #(n+16370)	DS #(n+16369)	DS #(n+16368)
2 047	DS #(n+16383)	DS #(n+16382)	DS #(n+16381)	DS #(n+16380)	DS #(n+16379)	DS #(n+16378)	DS #(n+16377)	DS #(n+16376)

4.20.6.11 Format 3 RMD Field 13

The Format 3 RMD Field 13 contains drive specific information. The definition is the same as defined in 4.17.11.2.6, "Format 1 RMD Field 13" on page 154.

4.20.6.12 Format 3 RMD Field 14

Format 3 RMD Field 14 specifies versatile information of a disc and logical unit. The definition is the same as defined in 4.17.11.2.7, "Format 1 RMD Field 14" on page 155.

4.20.7 Reading/recording of RMD

4.20.7.1 RMD recording in Sequential recording mode

If no RMD blocks has been written on a medium and the medium is used as Sequential recording mode, when RMD is written at first time, the Format 2 RMD Set and one or more Format 1 RMD blocks *shall* be written at once. After that, the writing manner of RMD is same as the DVD-R sequential recording.

During Sequential recording mode, the Format 2 RMD Set is used to indicate a status of erase operation when the erasing is in progress.

4.20.7.2 RMD recording in Restricted overwrite mode

In the case of Restricted overwrite mode, all RMD blocks *shall* be recorded as an RMD Set. Each RMD Set consists of five RMD blocks that are all equivalent except RBG Information field. Two kinds of RMD (Format 2 RMD and Format 3 RMD) are used for this mode. When the RMD information is changed, the updated RMD Set *shall* be recorded in the RMA.

For Restricted overwrite mode, RMD is recorded in the current valid RMA Segment. The valid RMA Segment is only one at a certain time. The valid RMA Segment contains one pair of a valid Format 2 RMD and a valid Format 3 RMD. RMD blocks *shall* be written sequentially from the beginning of RMA.

The Format 2 RMD *shall* be recorded in the first RMD Set of an RMA Segment. The Format 3 RMD *shall* be recorded as an RMD Set other than the first RMD Set of the same RMA Segment.

Only the Format 2 RMD that has the largest Update Counter value is valid. The RMA Segment that has the valid Format 2 RMD is currently used and valid.

The valid Format 2 RMD contains pointer to the first ECC block of the current valid Format 3 RMD Set in the same RMA Segment.

The Format 3 RMD Set is written in a same location in the RMA Segment repeatedly until that ECC blocks of the RMD Set becomes defective. See Section 4.20.6.4. When the Format 3 RMD Set becomes defective, the RMD Set is written in non-defective area as a new RMD Set in the same RMA Segment until all RMD Sets of the RMA Segment become defective. Simultaneously, the Format 2 RMD Set is also re-written to indicate the new Format 3 RMD location and Update Counter field and RMA Segment Defect Status (RSDS #n) bit is updated.

When the Defect Status Bitmap (DS #n) field of the Format 3 RMD is updated, new Format 3 RMD Set is written in other non-defective location in the same RMA Segment to preserve history of the Defect Status Bitmap. The preserved RMD Set may be re-used later if the RMD Set is still non-defective.

When there are no non-defective areas to record new RMD Set in an RMA Segment, the RMA Segment *shall* be relinquished and other non-defective RMA Segment *shall* be used instead.

When ECC blocks of the Format 2 RMD Set become defective, the RMA Segment *shall* also be changed to non-defective one. In that case, all unrecorded areas in the unusable RMA Segment *shall* be recorded with 00h.

4.20.7.3 RMD read sequence in Restricted overwrite mode

For Restricted overwrite mode, read sequence of RMD blocks is as follows:

1. Logical Unit reads the Update Counter field of Format 2 RMD from each RMA Segment. The RMA Segment that contains the largest Update Counter value is selected as valid RMA Segment.
2. Obtain the start address of the valid Format 3 RMD Set by reading the Format 3 RMD Set Pointer field of Format 2 RMD from the valid RMA Segment.
3. Logical Unit reads the valid Format 3 RMD Set.

4.20.8 Border Zone

Border Zone is defined for DVD-RW SL media as well as DVD-R SL media. Border Zone prevents the optical pickup from over running when a DVD-RW SL disc is played back on a DVD read-only logical unit.

4.20.8.1 Structure

The Border Zone is constructed with the Border-out and Border-in. The structure of the Border Zone is shown in Figure 53 - *Border Zone structure* on page 160. However, the Next Border Marker that is defined for DVD-R media is not defined for DVD-RW SL media.

4.20.8.2 Border Zone size

The Border-out start address is located after PSN 3FF00h. If a CLOSE TRACK/SESSION command is issued when recorded user data end address is less than PSN 3FF00h, the logical unit *shall* pad with 00h data through PSN 3FEFFh.

Border Zone size is dependent on its starting address and order.

- First Border Zone length is approximately 0,5 mm in radial direction.
- The other Border Zone length is approximately 0,1 mm in radial direction.

The size of a Border Zone for DVD-RW SL media is shown in Table 111

Table 111 - Border Zone size for DVD-RW SL media

Physical sector number of beginning Border Zone	3FF00h-B25FFh	B2600h-1656FFh	165700h-
First Border Zone Size	1 792 ECC blocks 56MBytes	2 368 ECC blocks 74MBytes	2 944 ECC blocks 92MBytes
Second and above Border Zone Size	384 ECC blocks 12MBytes	480 ECC blocks 15MBytes	608 ECC blocks 19MBytes

4.20.9 Erasing

DVD-RW SL medium is erasable. To erase the written data on a DVD-RW SL media, the BLANK command is used. The Blanking Type field specifies the blanking type.

On DVD-RW SL media, the following Blanking Types are available. See Table 324 - *Blanking Types for DVD-RW SL* on page 541. The “Blank the disc” and “Minimally blank the disc” operations are available at any time in any recording mode. The other operations are only permitted during Sequential recording mode.

1. Blank the disc (Blanking Type = 000b)
2. Minimally blank the disc (Blanking Type = 001b)
3. Unreserve an RZone (Blanking Type = 011b)
4. Blank an RZone Tail (Blanking Type = 100b)
5. Unclose the last Border (Blanking Type = 101b)
6. Erase Border (Blanking Type = 110b)

Note: If the disc is blanked by “Minimally blank the disc” operation, incremental recording is not available for this disc.

4.20.9.1 Registration of erase operation in RMD

When a disc is erased, the status of erase operation is registered in RMD prior to start erasing.

To check if an erase operation is completely finished, the Marker ECC blocks are used. Before start erasing, Marker ECC blocks with all 00h data are recorded (if not recorded) where the erase operation should terminate. At completion of an erase operation, if the Marker ECC blocks are erased, the operation is considered as successfully done.

In the case of “Blank the disc” or “Minimally Blank the disc” operation, RMA Lead-in and one Format 2 RMD Set and a Format 1 RMD *shall* be recorded at the beginning of RMA.

The **Disc Status** field of Format 2 RMD is set to 00h and the **Disc Status** field of the Format 1 RMD is set to 05h to indicate the disc is in Sequential recording mode and an erase operation in progress. The **Erase Operation Code** and **Erase Information** fields of Format 2 RMD is set to the corresponded erase operation value prior to begin erasing.

To indicate an erase operation in progress even when a failure of the operation happens:

- when an erase operation is to be done for a Sequential recording mode disc, Format 1 RMD with **Disc Status** field of 05h *shall* be appended after the current valid Format 1 RMD.
- when erase operation is to be done for a Restricted overwrite mode disc, Format 1 RMD with **Disc Status** field of 05h *shall* be written at the end of RMA before erasing.

When the erase operation has been finished, Format 1 RMD with appropriate **Disc Status** field value is appended. The information fields of **Border Zone**, **RZone** *shall* be updated.

4.20.10 Formatting

For Restricted overwrite mode, format operation is required in advance to use. To avoid unwritten area remaining in Data Area, all ECC blocks are recorded on the formatted area.

Usually, a format operation takes considerable time to ready for writing user data. To solve this problem, new types of format operations are defined for DVD-RW SL in addition to the CD-RW format operation. They are called quick format; “Quick” and “Quick Grow the last Border”.

To start writing a disc with minimum patience, a quick format operation is used. When a disc is in Restricted overwrite mode, all types of quick format operation are available. When a disc is in Sequential recording mode, only a “Quick” type of format operation is available. See Figure 99 - *DVD-RW SL recording mode and Bordered Area state transition on page 229*.

The state of the last Bordered Area on a medium is changed to the intermediate state by using the quick format operation. In the case of single Border disc, only a part of Lead-in, user data blocks and 32 ECC blocks with Lead-out attribute are formatted. Otherwise, Border-in, user data blocks and 32 ECC blocks with Lead-out attribute are formatted when quick format is performed. See Figure 98 - *An example of Intermediate state Bordered Area on DVD-RW SL media on page 227*.

To change an intermediate state Bordered Area to a complete state, CLOSE TRACK/SESSION command (Close Function=010b) is used.

The format length is arbitrary length except for Format Type = 00h (‘Full Format’). The format length *shall* be multiple of ECC block size. If the format length is not an integral multiple of ECC block size, the logical unit *shall* round up the value of **Number of Blocks** field in the Format Descriptor up to an integral multiple of the ECC block size. The formatted area is expandable up to the full capacity of the disc.

At completion of formatting other than quick format, a Border-out is recorded after formatted user Data Area. When a disc is formatted up to full capacity of a disc, a Lead-out is recorded after Stop Blocks of a Border-out. To force the writing of Lead-out after the last Border-out, CLOSE TRACK/SESSION command (Close Function=011b) is used.

When a format operation is successfully done, the media is entered to Restricted overwrite mode and restricted overwrite method is available on the formatted ECC block(s). There are no unwritten ECC blocks on the formatted area.

The DVD-RW SL supports following format operations.

1. Full Format operation (Format Type = 00h, 10h)
2. Grow Session/Border operation (Format Type = 11h)
3. Quick Grow the last Border operation (Format Type = 13h)
4. Quick (Format Type = 15h)

4.20.10.1 Registration of format operation in RMD

When a disc is formatted, RMA Lead-in and one combination of valid Format 2 RMD Set and Format 3 RMD Set *shall* be recorded and the status of format operation is registered in RMD before start formatting.

When format operation is to be done for a Sequential recording mode disc, the recording mode is changed to Restricted overwrite mode.

The **Disc Status** field of Format 2 RMD is set to 10h and the **Disc Status** field of Format 3 RMD is set to 11h to indicate the disc is in Restricted overwrite mode and an format operation in progress. The **Format Operation Code** and **Format Information** fields of Format 3 RMD is set to the corresponded format operation value prior to begin formatting. The information fields of Border Zone and RZone **shall not** be changed.

From the beginning of RMA to the end of valid Format 3 RMD Set, unrecorded ECC blocks **shall not** remain. Therefore, when format operation is attempted to a blank disc, Format 2 RMD Set **shall** be recorded before the corresponding Format 3 RMD is recorded on the media.

When the format operation has been finished, the **Disc Status** field in the Format 3 RMD Set is set to 12h or 13h. The information fields of Border Zone, RZone and Defect Status Bitmap (if necessary) **shall** be updated. The **Format Operation Code** and **Format Information** fields of Format 3 RMD **shall not** be changed until next format operation will be started.

When format operation (Format Type = “Full Format” or “Quick”) is attempted to Sequential recording mode disc, the Format 1 RMD with **Disc Status** field value 11h **shall** be recorded prior to record Format 2 RMD Set and Format 3 RMD Set. When the format operation completes, this Format 1 RMD becomes invalid.

4.20.11 Recovery from the incomplete Blank/Format operation

4.20.11.1 The theory of the information reporting and read/write action behavior

The theory of the information reporting and read/write action behavior for the incomplete erasing/formatting Bordered Area are as follows.

No automatic repair is necessary on the incomplete erasing/formatting Bordered Area.

In the case of incomplete Erasing, the size of erased RZone is considered to be 0.

In the case of incomplete formatting, the size of the RZone in the damaged Bordered Area other than newly created is considered to be maintained.

The **Status of Last Session** field of READ DISC INFORMATION command data **shall** be set to 10b.

The **Damage** bit field of READ TRACK INFORMATION data **shall** be set to 1 for the RZone that is writable and is in the incomplete erasing/formatting Bordered Area and the posterior RZones on the medium. “Writable” of the RZone means that the **Free Blocks** field of the damaged RZone is not zero or the RZone is overwriteable.

When write action is required to the damaged Bordered Area and the subsequent RZones except to repair, the command **shall** be terminated with CHECK CONDITION Status.

When read action is applied to an RZone which is in the damaged Bordered Area and its size is not 0, the action **shall** be performed normally. Because of the incomplete erasing/formatting result, when the read action is failed, the command **shall** be terminated with CHECK CONDITION status.

If FORMAT UNIT command is failed, CHECK CONDITION Status, 3/31/00 MEDIUM FORMAT CORRUPTED **shall** be reported. If CLOSE TRACK/SESSION command is failed, 3/72/00-02 SESSION FIXATION ERROR **shall** be reported. If the BLANK command with **Blanking Type** = “Unclose the last Bordered Area” has been failed, CHECK CONDITION Status, 3/51/01 ERASE FAILURE - Incomplete erase operation detected **shall** be reported.

To repair the incomplete erasing/formatting Bordered Area, REPAIR RZONE command with the damaged RZone number can be used.

Table 112 - Information reporting in the case of the incomplete Blank operation

Incomplete Operation	Status of last Border	Number of RZone	Number of Borders	RZone number for REPAIR RZONE command
Blank the Disc Minimally Blank the Disc	10b	1	1	Last RZone Number in the last Border
Unreserved an RZone	00b/01b	No change/ Decreased by 1 ^a	No change	Last RZone Number in the last Border
Blank an RZone tail	00b/01b	No change	No change	Applied RZone number
Unclose the last Bordered Area	10b	No change	Decreased by 1	Last RZone Number in the last Border
Erase Border	10b	Decreased	No change/ Decreased by 1 ^b	Last RZone Number in the last Border

- a. If the last RZone is incomplete state, the number of RZone does not change. Otherwise, the number of RZone is decreased by one.
- b. If the last Bordered Area is incomplete state, the number of Border does not change. Otherwise, the number of Border is decreased by 1.

Table 113 - Information reporting in the case of the incomplete Format operation

Incomplete Operation	Status of last Border	Number of RZone	Number of Borders	RZone number for REPAIR RZONE command
Full Format Quick	10b	1	1	Last RZone Number in the last Border
Grow Border Quick Grow Border	10b	No change	No change	Last RZone Number in the last Border
Close Intermediate Border	10b	No change	No change	Last RZone Number in the last Border

4.20.11.2 Recovery from incomplete erase operation

It is not possible to return original state after erase operation has been started. When an erase operation is not finished successfully, RZone(s) that are affected by the erase operation are considered as damaged. (Damage = 1, NWA_V = 0) To recover the incomplete erase operation, the un-finished erase operation is performed again from the beginning or the REPAIR RZONE command is used instead. Automatic recovery should not be performed.

4.20.11.3 Recovery from incomplete format operation

In the case of incomplete “Full”/“Quick” format operation, it is not possible to return original state after these format operations have been started. The repair action is perform the previous requested format operation again.

In the case of incomplete format operation other than “Full”/“Quick” format, the repair action cancels the previous requested format operation. The disc *shall* be return to the original state.

4.21 Recording/reading for DVD-RW Dual Layer media

4.21.1 The basics for DVD-RW Dual Layer media

DVD-RW Dual Layer (DL) media is developed to provide a re-recordable DVD media with the same capacity as DVD-ROM and DVD-R DL media. The major physical characteristics of DVD-RW DL media are as follows.

- The physical structure of DVD-RW DL media is similar to the DVD-R DL media. Opposite Track Path (OTP) media is only defined.
- The reflectivity of a recording layer on DVD-RW DL media is relatively low in comparison with DVD-ROM media and DVD-R DL media. Therefore the backward read compatibility with legacy DVD logical units is worse than the case of DVD-R DL media.
- It is strongly recommended that the area on L1 should be recorded through the recorded area on L0 due to the same reason for DVD-R DL media. See 4.18.1.3, "Recording order" on page 169.
- The Control Data Zone is embossed by a disc manufacturer. Therefore the LBA and PSN has one-to-one relationship due to the same reason for DVD-R DL discs. See 4.18.1.4, "Fixed logical volume space" on page 169.

Table 114 shows the comparison chart of some physical parameters between different versions of DVD-RW media format and DVD-ROM DL media.

Table 114 - Several parameters of DVD-RW media format

DVD Version Characteristics	DVD-RW SL Ver. 1.2	DVD-RW DL Ver. 2.0	(DVD-ROM DL)
Capacity per side (120 mm)	4,7 gbytes ^a	8,54 gbytes ^a	max 8,54 gbytes ^a
Channel bit length (μm)	0,133	0,147	0,147
Track pitch (μm)	0,74	0,74	0,74
Number of Layers per side	1	2	2
Reflectivity	18 to 30%	5 to 10%	18 to 30%
Control Data Zone	embossed	embossed	embossed
Standard recording speed	1× to 6× ^b	2×	N/A

a. gbytes = 1 000 × 1 000 × 1 000 bytes

b. Typical media product specification in the market is 1× to 2× or 2× to 6×.

The major logical characteristics of the DVD-RW DL media are as follows.

- Blanking is not defined.
- Multi-session is not allowed.
- Reserved RZone is not allowed.
- Physically recorded area and logically recorded area are managed independently.
- Restricted Overwrite mode and Layer Jump Restricted Overwrite mode are defined, but DAO/Incremental Recording mode used for DVD-RW SL is not allowed.
- Lead-out is not allowed to be expanded into the Data Recordable Area.
- Intermediate Marker is used to find the real last recorded address.

4.21.1.1 Abbreviations for this section

In this section, the following abbreviations are used to represent the field names in Control Data Zone, RW-Physical Format Information and RMDs. See Table 115.

Table 115 - Abbreviations for this section

Field name	Abbr.	Field name	Abbr.
Fields in Control Data Zone, see Section 4.5.1		Fields in Format3 RMD Field3, see Section 4.21.7.6	
Starting PSN of Data Area	SDA	Start PSN of RZone	SRZ
End PSN of Data Area	EDA	End PSN of RZone	ERZ
End PSN of L0	ED0	Layer Jump PSN on Layer 0	LJA
Fields in RW-Physical Format Information, see Section 4.5.2		Last recorded PSN	LRA
Maximum recorded PSN of the Data Area	MDA	Previous Layer Jump PSN on Layer 0	PLJA
Maximum recorded PSN of the Data Area on Layer 0	MD0	Jump interval	JI
Start PSN of the Middle Area	SMAP	Outermost PSN of the recorded area with data area attribute on Layer 0	OR0
Fields in Format3 RMD Field0, see Section 4.21.7.1		Outermost PSN of the recorded area with data area attribute on Layer 1	OR1
Start PSN of the Middle Area	SMAR		

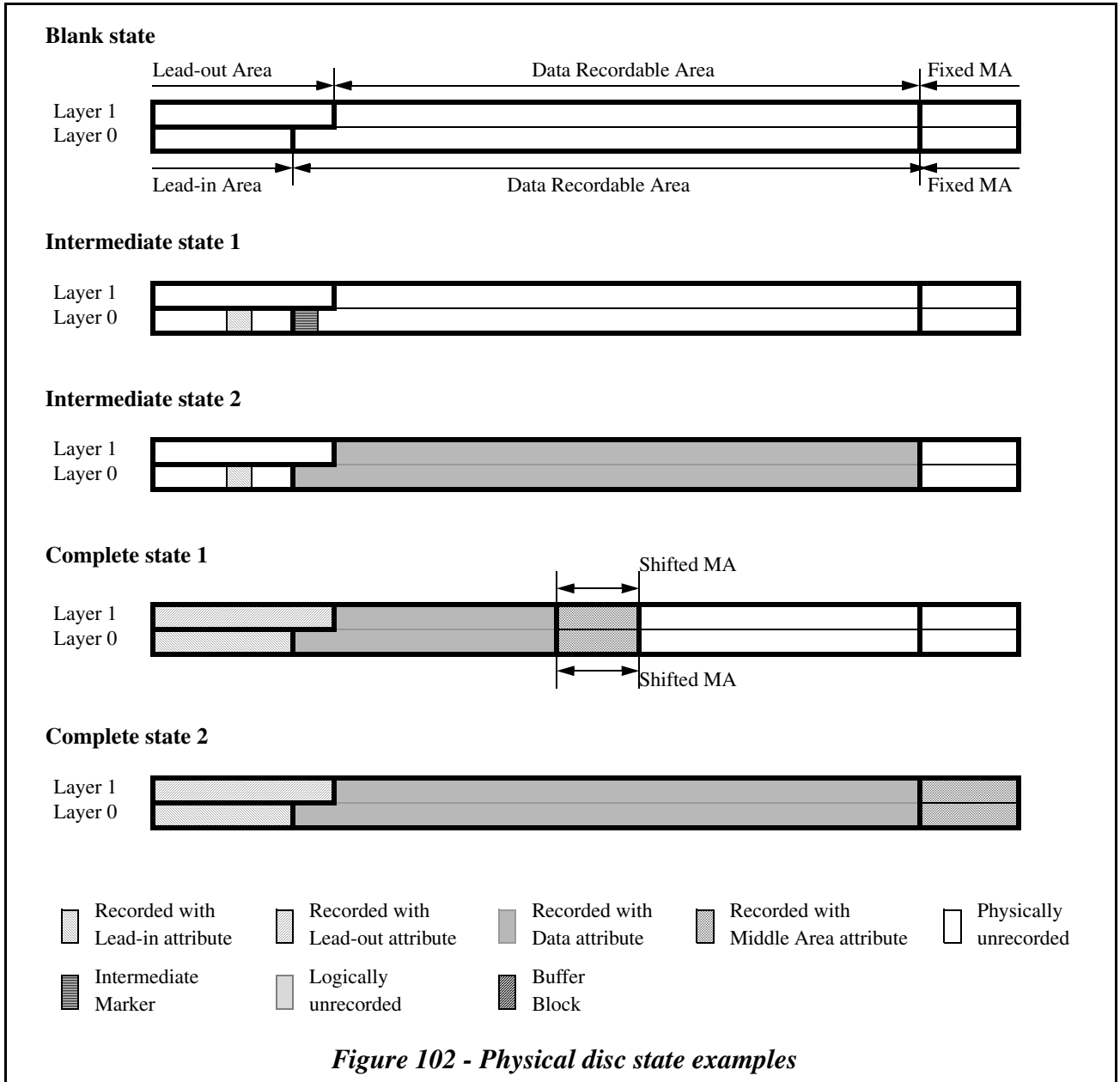
4.21.2 Physical disc structure

4.21.2.1 Physical disc state

Same as DVD-RW SL media, three physical disc states are defined on DVD-RW DL media as follows;

- Blank state
The **Disc Status** field of Format 3 RMD Field0 is set to 00h or 80h.
The disc has no written data in Data Recordable Area. PCA and/or RMDs may be written.
- Intermediate state
The **Disc Status** field of Format 3 RMD Field0 is set to 13h or 93h.
The disc is in this state when it is formatted by Quick format or Quick Grow format.
Specific part of the Lead-in Area and Intermediate Marker is recorded. The size of the Intermediate Marker may be reduced.
- Complete state
The **Disc Status** field of Format 3 RMD Field0 is set to 12h or 92h.
The disc is in this state when it is formatted by Full format, CD/DVD Full format, Grow format or Fast Re-format, or when it is closed.
Lead-in Area, Lead-out Area and Middle Area are recorded.
All the blocks in Data Area in between Lead-in/out Areas and Middle Area are recorded with **Area Type** field set to Data Area.

See Figure 103.



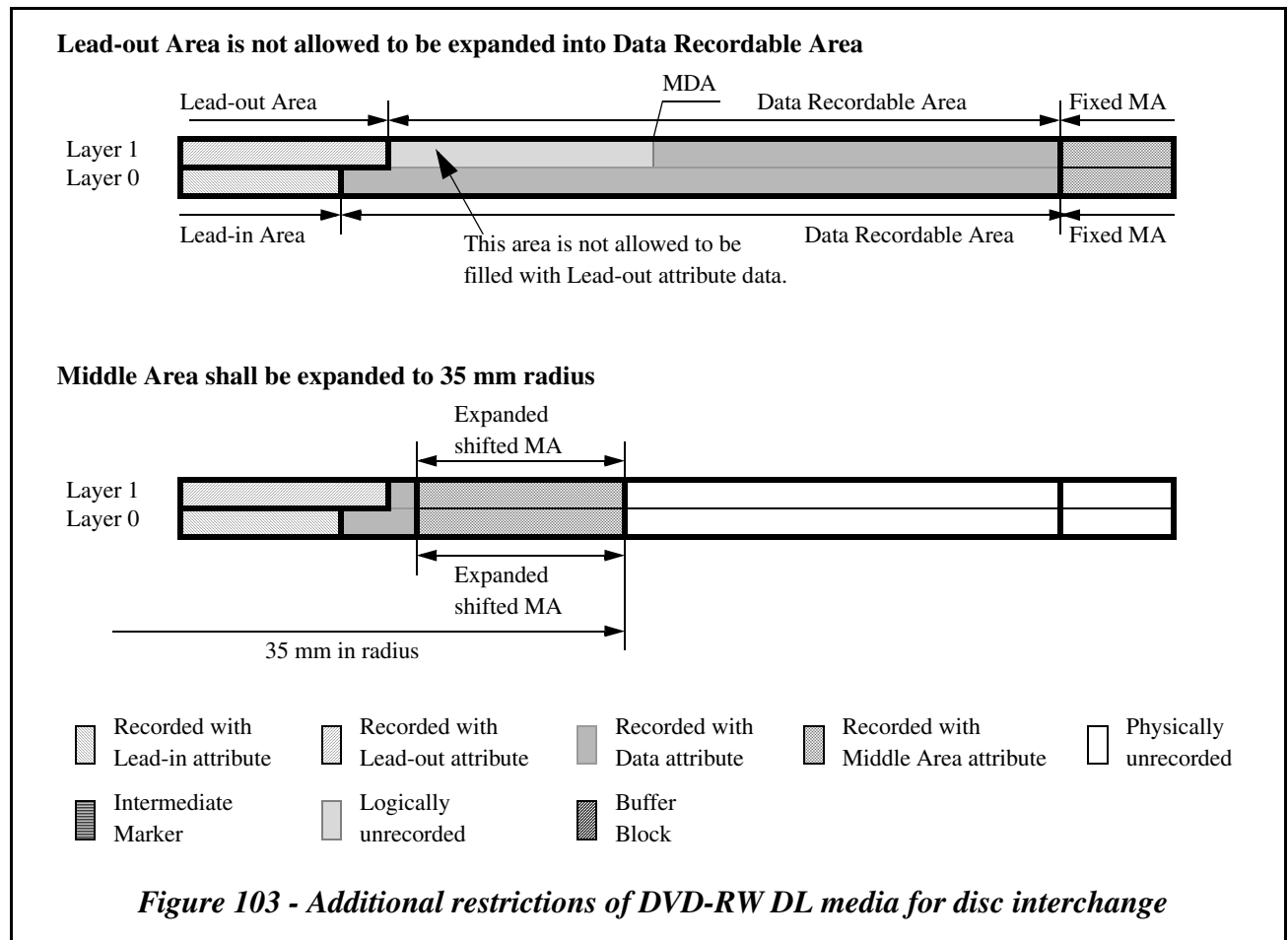
4.21.2.2 State of DVD-RW DL disc for interchange

To make the recorded user data on DVD-RW disc physically readable by DVD read-only logical units, at least similar condition as DVD-R DL is required. See 4.18.3, "State of DVD-R DL disc for interchange" on page 171.

In addition to the conditions described in Section 4.18.3, the following restraint is applied to DVD-RW DL discs.

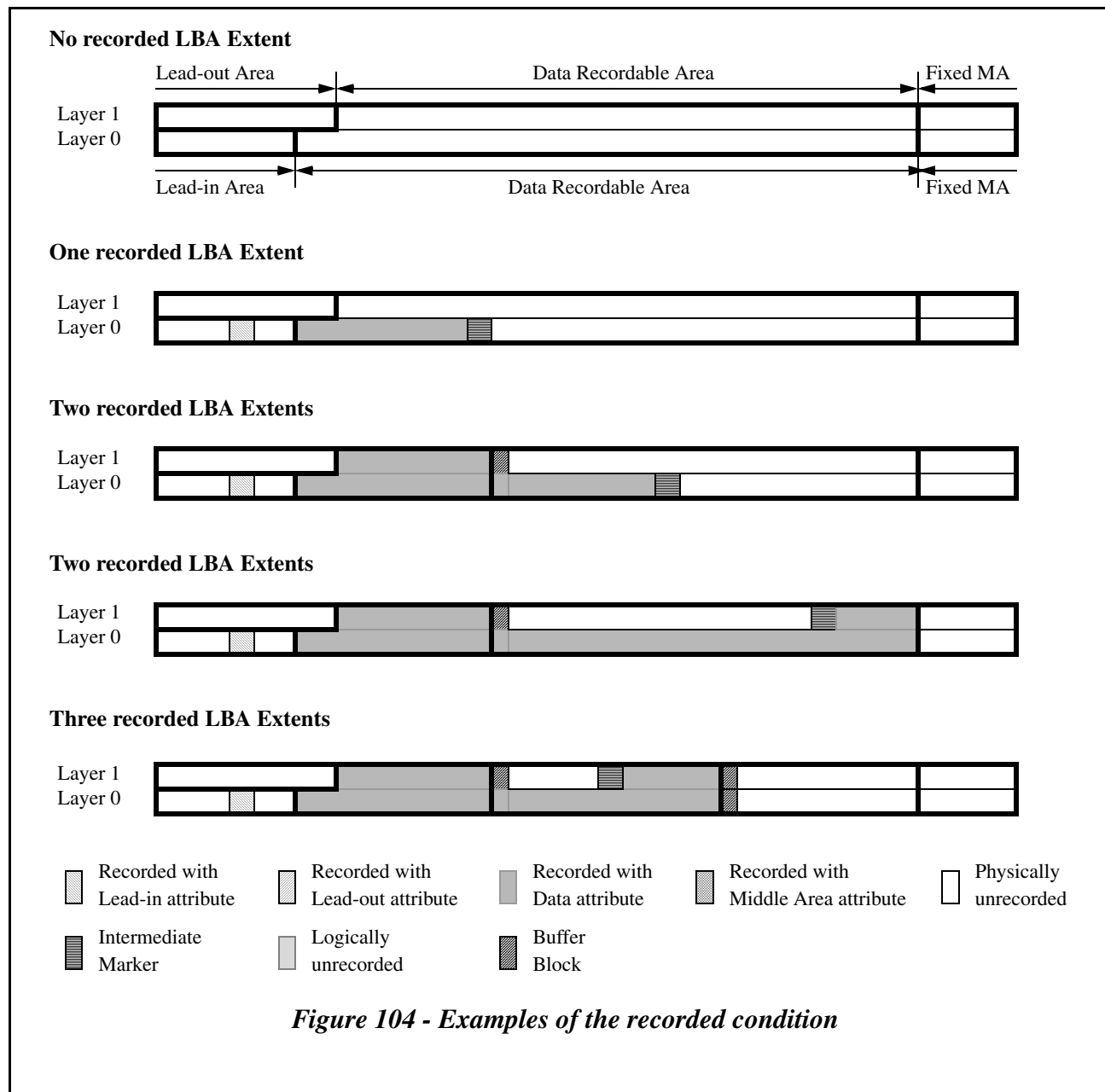
- Lead-out Area is not expanded into Data Recordable Area. See 4.21.1.
- Middle Area is expanded to 35 mm radius when the recorded User Data is very small.

See Figure 103.



4.21.2.3 RZone for DVD-RW DL media

On DVD-RW DL media, only one RZone is allowed to exist on a DVD-RW DL medium. RZone reservation is not possible. Zero or one recorded LBA Extent exists on the medium recorded in Rigid Restricted Overwrite recording mode. If a DVD-RW DL medium is in the Layer Jump Rigid Restricted Overwrite recording mode, refer to Section 4.21.2.5, the logically recorded area is fragmented into two or more recorded LBA Extents. See Figure 104.



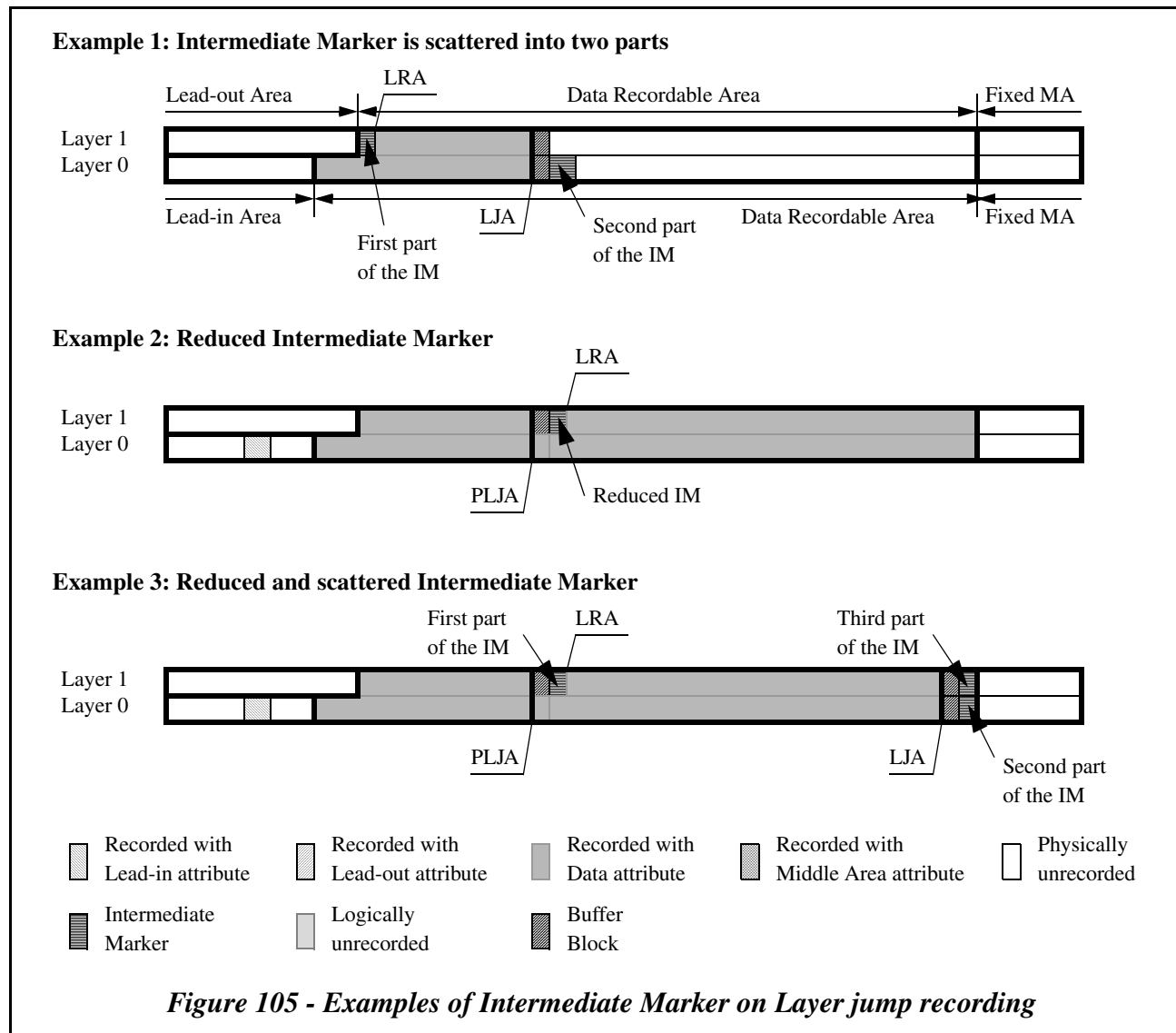
4.21.2.4 Intermediate Marker

When the medium is in Intermediate state, the Last Recorded Address indicates the LBA of the latest user data recorded block. But the LRA stored in the RMD of the medium may not be the latest information because the RMD is not updated so frequently. By this reason, the logical unit has to find the real Last Recorded Address when the medium is mounted. To find the location of the Last Recorded Address, the termination structure is used. In case of DVD-RW SL discs, the structure consists of contiguously recorded 32 ECC blocks with Area Type field set to Lead-out Area. In case of DVD-RW DL media, Intermediate Marker is used instead. The Intermediate Marker consists of 32 ECC blocks with Data attribute, see Table 14 - *Data Type bit definition* on page 93 and Table 116.

Table 116 - Difference of the termination structure between DVD-RW SL and DL

Media type	Termination structure	Area Type field value	Data Type bit value	Size
DVD-RW SL media	Temporary Lead-out	10b (Lead-out Area)	0b	32 ECC blocks
DVD-RW DL media	Intermediate Marker	00b (Data Area)	1b (at least 2nd - 15th sectors out of 16 sectors in each ECC block)	32 ECC blocks (can be shrunk if there is not enough space to record)

The Intermediate Marker is recorded at the logically unrecorded area and the recording sequence is the same as the user data recording. The Intermediate Marker may be fragmented into two or more parts, according to the rule of the NWA motion. The Intermediate Marker may be reduced if the logically unrecorded area remains less than 32 ECC blocks. When the LBA Space is fully recorded, the Intermediate Marker is not recorded. See Figure 105.



4.21.2.5 Recording mode for DVD-RW DL media

For DVD-RW DL media, two kinds of recording methods are defined. One is the Restricted Overwrite mode which is the same manner for DVD-RW SL media in Restricted Overwrite mode except multi-Session mechanism and blanking. The other is the Restricted Overwrite mode with Layer jump recording which is the similar manner of the Layer Jump recording mode for DVD-R DL media except multi-Session/multi-RZone mechanism, Remapping mechanism and overwritability. The former method is named Rigid Restricted Overwrite recording mode, abbreviated to RROW recording mode, and the latter method is named Layer Jump Rigid Restricted Overwrite recording mode, abbreviated to LJRROW recording mode. Since the DVD-RW DL media is overwritable, the Remapping mechanism defined for DVD-R DL media is not applied to LJRROW recording mode.

Both modes are managed by the same Format 3 RMD. The RROW recording mode can easily be changed to the LJRROW recording mode by specifying the layer jump location. So, the LJRROW recording mode can be assumed as an extended function of the RROW recording mode. See 4.21.4 for more detail.

4.21.2.6 Recorded state of a block

Unlike DVD-RW SL media, blanking is not defined for DVD-RW DL media. Once a block is physically recorded, the block will not become blank. To manage the outermost location of the physically recorded contiguous area on L0 and on L1, the OR0 field and the OR1 field are defined in RMD respectively.

4.21.2.6.1 Physical recorded state of a block

If a block in Data Recordable Area contains a correctable data with **Area Type** field set to Data Area, see *Section 4.4.3, "Data configuration of Data ID field"* on page 92, the block is physically recorded. If a block in Data Recordable Area is blank, contains an uncorrectable signal, or contains a correctable data with the **Area Type** field set to other than Data Area, the block is physically unrecorded.

The block indicated by the OR0 field, the block indicated by the OR1 field and all the blocks in the Data Recordable Area inner than those blocks are guaranteed to be physically recorded.

Final target of the recorded condition of the DVD-RW DL media is that all the blocks in the Data Recordable Area are physically recorded. In this condition, the Middle Area is recorded at ED0 + 1 as the Fixed Middle Area. Once a medium becomes this condition, the Shifted Middle Area is virtually allocated at the requested location by setting the SMAP field to the requested address, but Middle Area **shall not** be recorded at that location even if it is requested. In this case, the last accessible block on L0 is not at ED0 but at SMAP - 1.

Since the blanking is not defined for DVD-RW DL media and the data with the **Area Type** field set to Middle Area is not necessary to be recorded if the Middle Area has been recorded outer than the requested location, the OR0 and the OR1 move outward only.

By using those fields, it is not necessary to overwrite the physically recorded blocks within the requested area during the formatting process. even if the disc is requested to be formatted.

4.21.2.6.2 Logical recorded state of a block

The physically recorded blocks are not necessarily accessible by the host by specifying LBA. The host can access to the blocks only in the logically recorded area to read out the recorded data. The logical unit identifies the logically recorded areas by the rule described in Table 117. Maximum of three logically recorded areas exist on a medium. All the logically recorded blocks are overwritable by WRITE command.

Table 117 - Discrimination of the logically recorded areas

Recorded condition ^a		Logically recorded area on L0 ^a	Logically recorded area on L1 ^a	
Blank/Intermediate state	ERZ=0	No area	No area	
	LRA is on L0	ERZ is on L0	From SDA to LRA	No area
		ERZ is on L1	From SDA to LRA	From \overline{PLJA} to ERZ
	LRA is on L1	PLJA=0 & LJA=0 & (SMAR=0 or SMAR=ED0+1)	From SDA to ED0	From $\overline{ED0}$ to ERZ
		PLJA=0 & LJA=0 & SMAR≠0	From SDA to SMAR - 1	From $\overline{SMAR - 1}$ to LRA
		PLJA=0 & LJA≠0	From SDA to LJA	From \overline{LJA} to ERZ
		PLJA≠0 & LRA ≥ \overline{PLJA}	From SDA to PLJA	From \overline{PLJA} to ERZ
		PLJA≠0 & LRA < \overline{PLJA} & LJA=0 & (SMAR=0 or SMAR=ED0+1)	From SDA to ED0	From \overline{PLJA} to ERZ, and from $\overline{ED0}$ to LRA
		PLJA≠0 & LRA < \overline{PLJA} & LJA=0 & SMAR≠0	From SDA to SMAR - 1	From \overline{PLJA} to ERZ, and from $\overline{SMAR - 1}$ to LRA
PLJA≠0 & LRA < \overline{PLJA} & LJA≠0		From SDA to LJA	From \overline{PLJA} to ERZ, and from \overline{LJA} to LRA	
Complete state	MDA is on L0	From SDA to MDA	No area	
	MDA is on L1	From SDA to SMAP - 1	From $\overline{SMAP - 1}$ to MDA	

a. All the values must be the latest one. The values recorded on the disc may be different from the latest one.

4.21.2.7 Structure of the Complete state media

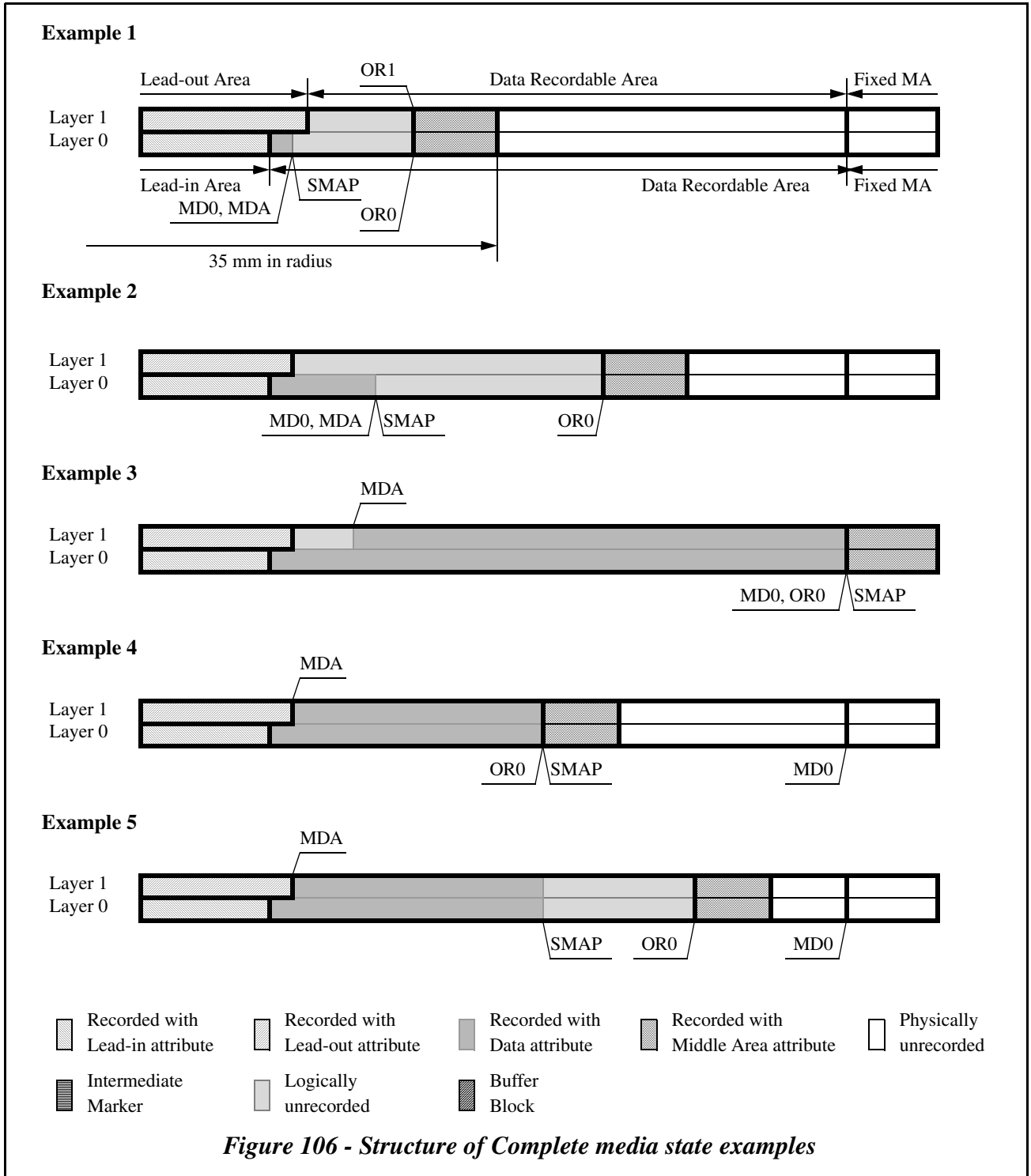
If the media is in Complete state. Lead-in Area, Lead-out Area and Middle Area are recorded appropriately. All the blocks of the Data Recordable Area in between Lead-in/Lead-out Areas and Middle Area are physically recorded. The last logically recorded block is specified by MDA.

One or two logically recorded LBA Extent(s) exist(s) on the medium.

If the block specified by MDA is on Layer 0, only one logically recorded LBA Extent exists on the medium. In this case, MDA and MD0 specify the same PSN. SMAP specifies the same location to MDA + 1. See example 1 and 2 in Figure 106.

If the block specified by MDA is on Layer 1 and SMAP specifies the Fixed Middle Area start PSN, only one recorded LBA Extent exists on the medium. In this case, MD0 specifies the ED0. SMAP specifies the same location to MD0 + 1. See example 3 in Figure 106.

If the block specified by MDA is on Layer 1 and SMAP specifies the location inner than the Fixed Middle Area start PSN, two recorded LBA Extents exist on the medium. In this case, MD0 specifies the ED0. But the blocks located from SMAP in RW-Physical format information to MD0 are logically unrecorded and not accessible by the host by specifying LBA. See example 4 and 5 in Figure 106.



4.21.2.8 Middle Area setting

As described in Section 4.21.2.7, DVD-RW DL media format can manage physical recorded condition and logical recorded condition independently. Same manner can also be applied to Middle Area.

When the medium becomes Intermediate state by formatting, SMAP and SMAR are reset to 00h.

When the medium is in Blank state or in Intermediate state and if the Shifted Middle Area is specified by the host, the specified PSN is stored in SMAR in Format3 RMD Field0. When the medium is closed, SMAP and SMAR are set to the next block of last logically recorded block on Layer 0 regardless of the location actual Middle Area is recorded. See Figure 106.

If the bit 4 of Pre-recorded/Embossed information code field is set to one, Middle Area has already been recorded correctly at OR0 + 1. In this case, if OR0 + 1 is outer than SMAP, it is prohibited to record Middle Area at SMAP when the medium is closed. See example 1, 2 and 5 in Figure 106.

At least upon finalizing the medium, OR0 *shall* be updated to the latest value. It is recommended that both OR0 and OR1 should be updated at every RMD updating. Refer to section 4.21.8.1 on page 279.

4.21.3 Logical disc structure

4.21.3.1 Associated Profile and Feature

In case of DVD-R DL media, three recording modes, Incremental Recording mode, DAO recording mode and Layer Jump Recording mode, are defined and each recording mode is independent from the others. Once recording to a medium is started in one recording mode, the recording mode can never be changed to the other mode.

In case of DVD-RW SL media, two recording modes, Sequential Recording mode and Restricted Overwrite mode, are defined and each recording mode is also independent from the other. Once recording to a medium is started in one recording mode, the only way to change the recording mode is blanking or formatting the medium.

For above media types, multiple Profiles are defined for one physical media type by these reasons. But in case of DVD-RW DL media, the LJRROW recording mode can be assumed as an extended function of the RROW recording mode. The RROW recording mode can be changed to the LJRROW recording mode easily to specify the layer jump location. This means that it is not necessary to consider the DVD-RW DL media in RROW recording mode and that in LJRROW recording mode are the different media types. By this reason, only one Profile, DVD-RW Dual Layer Profile is defined for DVD-RW DL media.

4.21.3.1.1 Read compatibility

A DVD logical unit other than DVD-RW DL logical unit can have the capability to read the recorded DVD-RW DL media. To claim the capability, the Dual-RW bit in DVD Read Feature Descriptor returned by GET CONFIGURATION command can be set. When this bit is set to one, at least the DVD-RW DL media in Complete state *shall* be able to read.

If the DVD logical unit other than DVD-RW DL logical unit does not have the capability to read the DVD-RW DL media in Intermediate state, any media access commands *shall* be rejected with CHECK CONDITION Status, 5/30/02 CANNOT READ MEDIUM - INCOMPATIBLE FORMAT if the mounted DVD-RW DL medium is in Blank state or in Intermediate state.

A DVD-RW DL logical unit, which does not support LJ Rigid Restricted Overwrite Feature, *shall* be able to read at least the Complete DVD-RW DL media and the Intermediate DVD-RW DL media in Contiguous condition. If the logical unit is not able to read the mounted medium which is in Intermediate state with Non-contiguous condition, LJ Rigid

Restricted Overwrite Feature **shall not** be reported or become current. All the following commands **shall** be rejected with CHECK CONDITION Status, 5/30/02 CANNOT READ MEDIUM - INCOMPATIBLE FORMAT.

- GET PERFORMANCE command
- READ (10) command/READ (12) command
- READ BUFFER CAPACITY command
- READ CAPACITY command
- READ DISC INFORMATION command
- READ DISC STRUCTURE command
- READ TOC/PMA/ATIP command
- READ TRACK INFORMATION command
- SEEK command

4.21.3.1.2 Write compatibility

For DVD-RW DL logical unit, the RROW recording mode is the mandatory recording mode and the LJRROW recording mode is the optional recording mode to be supported.

As explained in Section 4.21.3.1, only one Profile is defined for DVD-RW DL media recordable logical unit, DVD-RW Dual Layer Profile (0017h). The presence of the DVD-RW Dual Layer Profile indicates that the logical unit supports recording on DVD-RW DL media. Regardless of the applied recording mode, when a DVD-RW DL medium is inserted in that, the DVD-RW Dual Layer Profile becomes current.

The Rigid Restricted Overwrite Feature is one of the mandatory Feature for this Profile. If the DVD-RW DL logical unit supports the optional LJRROW recording mode, the LJ Rigid Restricted Overwrite Feature **shall** also be supported.

If a DVD-RW DL medium in Intermediate state with Non-contiguous condition is mounted on a DVD-RW DL logical unit without LJ Rigid Restricted Overwrite Feature, all the following commands **shall** be rejected with CHECK CONDITION Status, 5/30/05 CANNOT WRITE MEDIUM - INCOMPATIBLE FORMAT.

- CLOSE TRACK/SESSION command
- FORMAT UNIT command with Quick Grow format and Fast Re-format
- SEND DISC STRUCTURE command
- SYNCHRONIZE CACHE (10) command
- WRITE (10) command/WRITE (12) command/WRITE AND VERIFY (10) command

Table 118 - Profile and Feature

Mounted medium		DVD-RW DL logical unit with LJRROW					
RZone condition	Physical disc state	DVD-RW DL logical unit without LJRROW					
		DVD-RW DL Profile	RROW Feature	Formattable Feature	Random Readable Feature		
						LJRROW Feature	
Contiguous	Blank	Current	Current	Current	Not current		Current
	Intermediate				Current		
	Complete				Current		
Non-contiguous	Blank		Not current		Not current		
	Intermediate				May be Not current	Current	
	Complete				Current		

4.21.3.2 Logical Disc status

In case of DVD-RW SL media, the medium in Blank state can be recorded from LBA 0 without formatting, although the recording mode is DAO/Incremental recording mode. The formatting is required to change the recording mode from the DAO/Incremental recording mode to Restricted Overwrite mode. But in case of DVD-RW DL media, since the recording mode is only Restricted Overwrite mode, the medium in Blank state can be assumed as already in Restricted Overwrite mode and Intermediate state and has a valid NWA which indicates LBA 0.

From the host side point of view, there is no necessity to distinguish whether the medium is in Blank state or in Intermediate state. The logical unit *shall* report the Disc Status of the DVD-RW DL medium in Blank state as Incomplete disc, see Figure 107. All the received commands *shall* behave as if the medium is in Intermediate state with size zero. For example, the Descriptor Type field in the Current/Maximum Capacity Descriptor for READ FORMAT CAPACITIES command *shall not* be set to 01b, but *shall* be set to 11b. See Table 119.

Table 119 - Command handling on physical Blank state disc

Field name/Requested function	Response
READ DISC INFORMATION command	
Status of Last Session	01b (Incomplete Session)
Disc Status	01b (Incomplete disc)
READ FORMAT CAPACITIES command	
Descriptor Type in Current/Maximum Capacity Descriptor	11b (Unknown Capacity)
READ TRACK INFORMATION command	
LJRS	00b (Non-Layer jump recording)
Blank	1b (No written data and Last Recorded Address field is invalid)
LRA_V	0b (Invalid)
NWA_V	1b (Valid)
Next Writable Address	00h
Next Layer Jump Address	F(ED0) ^a
Last Layer Jump Address	00h
READ DISC STRUCTURE command	
Physical format information (Format Code=00h)	Fabricated
RMD in the last Border-out (Format Code=0Ch)	CEHCK CONDITION
RMD (Format Code=0Dh)	CEHCK CONDITION

a. F(X) is a formula to convert the PSN of X to the assigned Logical Block Address.

4.21.3.3 Implicit format operation

When the logical unit receives a WRITE command to a Blank state disc, the logical unit *shall* execute the implicit formatting action to change the disc state to Intermediate state at the logical unit's convenient timing but *shall* be before ejecting the medium.

If the logical unit executes the implicit formatting action upon receipt of the WRITE command and the formatting action including OPC is expected to finish in long time, or the request to set Shifted Middle Area, manual Layer jump address or Jump interval by SEND DISC STRUCTURE command, the command may be terminated with CHECK CONDITION Status, 2/04/07 LOGICAL UNIT NOT READY, OPERATION IN PROGRESS or CHECK CONDITION Status, 2/04/08 LOGICAL UNIT NOT READY, LONG WRITE IN PROGRESS. In case of WRITE command, the data *shall not* be received.

Once the logical unit is in these NOT READY conditions, READ DISC INFORMATION command and READ TRACK INFORMATION command may also be terminated with CHECK CONDITION Status, 2/04/07 LOGICAL UNIT NOT READY, OPERATION IN PROGRESS or CHECK CONDITION Status, 2/04/08 LOGICAL UNIT NOT READY, LONG WRITE IN PROGRESS until the implicit formatting will finish.

Table 120 - Relation of physical disc state, logical disc status

Physical disc state	READ DISC INFORMATION command		READ TRACK INFORMATION command		Remarks
	Disc Status	Status of Last Session	NWA_V	Next Writable Address	
Blank	Incomplete disc	Incomplete Session	1	00h	The medium is treated by the logical unit as if Quick format with size zero is applied.
Intermediate				≥00h	
Complete	Complete disc	Complete Session	0	Not valid	

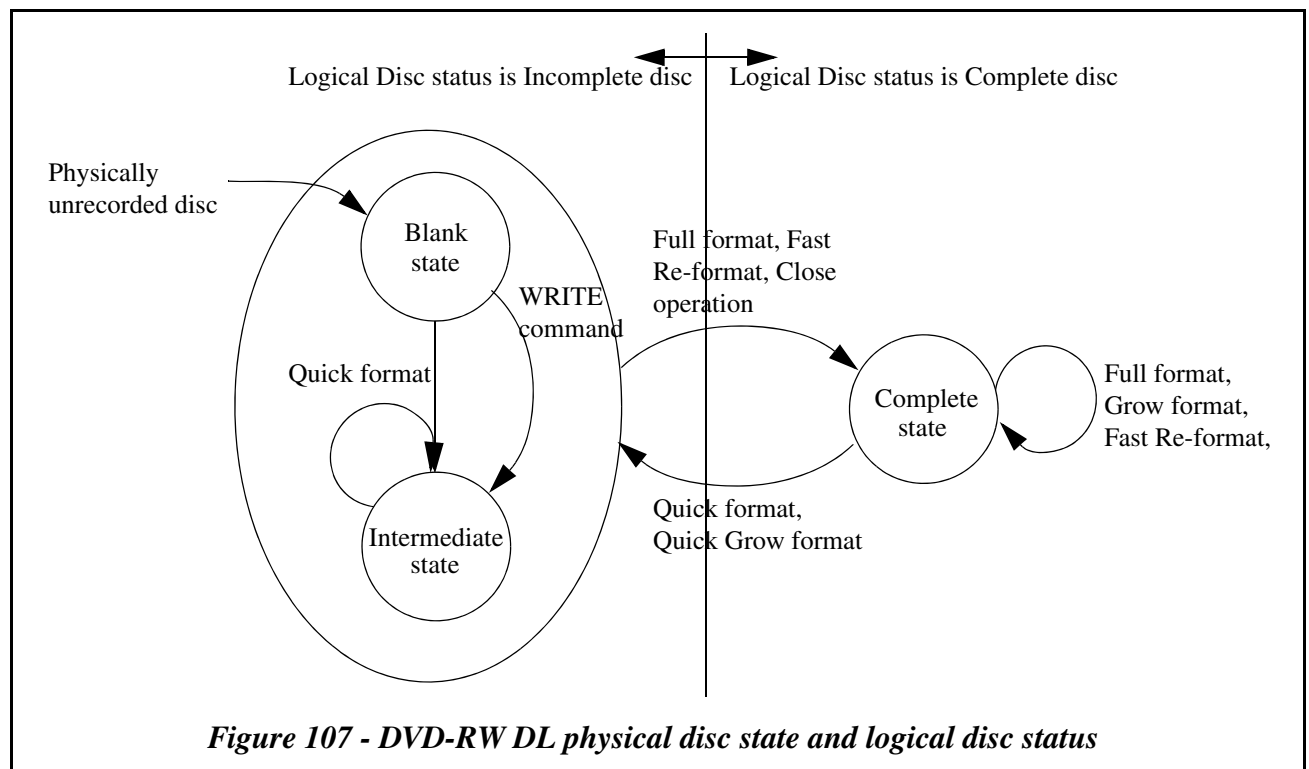


Figure 107 - DVD-RW DL physical disc state and logical disc status

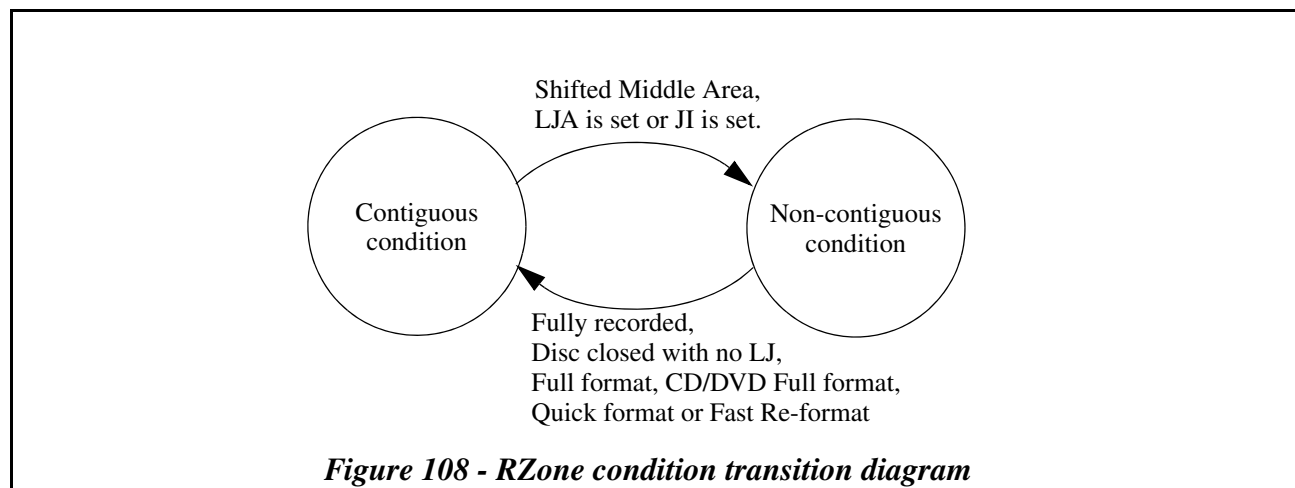
4.21.3.4 RZone conditions

The RZone may consist of zero, one, two or three recorded LBA Extents as described in Section 4.21.2.3. When the RZone consists of zero or one recorded LBA Extent and no Layer jump location is specified, the RZone is in Contiguous condition. and the RZone consists of zero or one recorded LBA Extent and a layer jump location is specified, or consists of two or more recorded LBA Extent, the RZone is in Non-contiguous condition.

According to the recorded condition, the RZone conditions are defined as follows.

- **Contiguous condition:** Zero or one recorded LBA Extent exists on the medium and the LJA is not specified. In this condition, the LJRS field in the Track Information Block of READ TRACK INFORMATION command is set to 00b.
- **Non-contiguous condition:** Two or more recorded LBA Extents exists on the medium, either the LJA or the JI is specified, or the medium is in Intermediate state and the SMAR is specified as the Shifted Middle Area. The Non-contiguous condition is classified into three LJ recording status.
 - **Unspecified:**
The Active LJB is blank and neither the LJA nor the JI is specified, or no Active LJB exists. In this status, the LJRS field in the Track Information Block of READ TRACK INFORMATION command is set to 01b.
 - **Manual:**
The JI is not specified and, the LJA is specified or the Active LJB is not blank. In this status, the LJRS field in the Track Information Block of READ TRACK INFORMATION command is set to 10b.
 - **Regular Interval:**
The JI is specified. In this status, the LJRS field in the Track Information Block of READ TRACK INFORMATION command is set to 11b.

If a DVD-RW DL medium is in Blank state, NWA of the medium is valid and zero, and no layer jump location is specified, the RZone is in Contiguous condition. The RZone can be changed to Non-contiguous condition when layer jump location or the Shifted Middle Area is specified. Once the RZone is in Non-contiguous condition, it is not changed to Contiguous condition until the medium is closed when no layer jump has not been happened, the medium is formatted with Full format, CD/DVD Full format, Quick format or Fast Re-format, or the medium is fully recorded without Shifted Middle Area. See Figure 108.



4.21.4 Recording mode

For DVD-RW DL media, the recording mode is simplified compared to DVD-RW SL media. DVD-RW DL media has Restricted Overwrite mode only. The recorded ECC blocks on the medium are physically overwritable by the logical unit.

The major differences between DVD-RW SL media are listed as follows.

- Sequential Recording mode is not defined
Consequently, a blank operation is not defined. Although the Sequential Recording mode is not defined, the similar recording manner is available without disabling the overwrite capability. Incremental Streaming Writable Feature never becomes current for DVD-RW DL media.
- Multi-Border structure is not defined (A Shifted Middle Area is used instead of the Border Zone).
Border Zone is not used on DVD-RW DL media. The number of RZones on a disc is one.
- Layer jump recording method is available. This enables host to record with the same manner as DVD-R DL.

Except for the above differences, other recording behaviors are basically taken over from DVD-RW SL media. See 4.20, "Recording/reading for DVD-RW Single Layer media" on page 225.

4.21.4.1 RROW recording mode

The RROW recording mode is defined for DVD-RW DL media to keep the compatible recording scheme with that for DVD-RW SL media in RROW recording mode with some exceptions as follows;

- Blanking is not available
- Multi-Border structure is not available

All the other functions defined for DVD-RW SL media in RROW recording mode can be applied.

4.21.4.2 LJRROW recording mode

The Layer jump recording enables to make the disc compatible structure with DVD-ROM DL media in a quicker manner than straight forward recording upon receiving a disc close request. The Layer jump recording functions defined for DVD-R DL media, e.g. manual Layer jump recording, regular interval Layer jump recording and setting of Shifted Middle Area, are also available for DVD-RW DL discs. However, DVD-RW DL media has only one RZone and RZone reservation is not allowed.

In case of DVD-R DL media, the ability of the Layer Jump recording is shown by the Layer Jump recording Feature. But in case of DVD-RW DL media, LJRROW Feature is used instead, because the Layer Jump recording Feature requires RESERVE TRACK command.

4.21.4.2.1 LJB and Buffer Block

LJB is defined as an unit of LJ recording. An LJB consists of an LBA Extent on L0 part and its corresponding LBA Extent on L1 part. The PSN of the outermost block in L1 part of an LJB is the bit inverted of the PSN of the outermost block in L0 part of that LJB, which is called LJ point.

If LJA is specified for the LJB, the LJA is the LJ point of the LJB. If no LJA is specified but SMAR is specified, the SMAR - 1 is the LJ point. If neither LJA nor SMAR is specified, the ED0 is the LJ point.

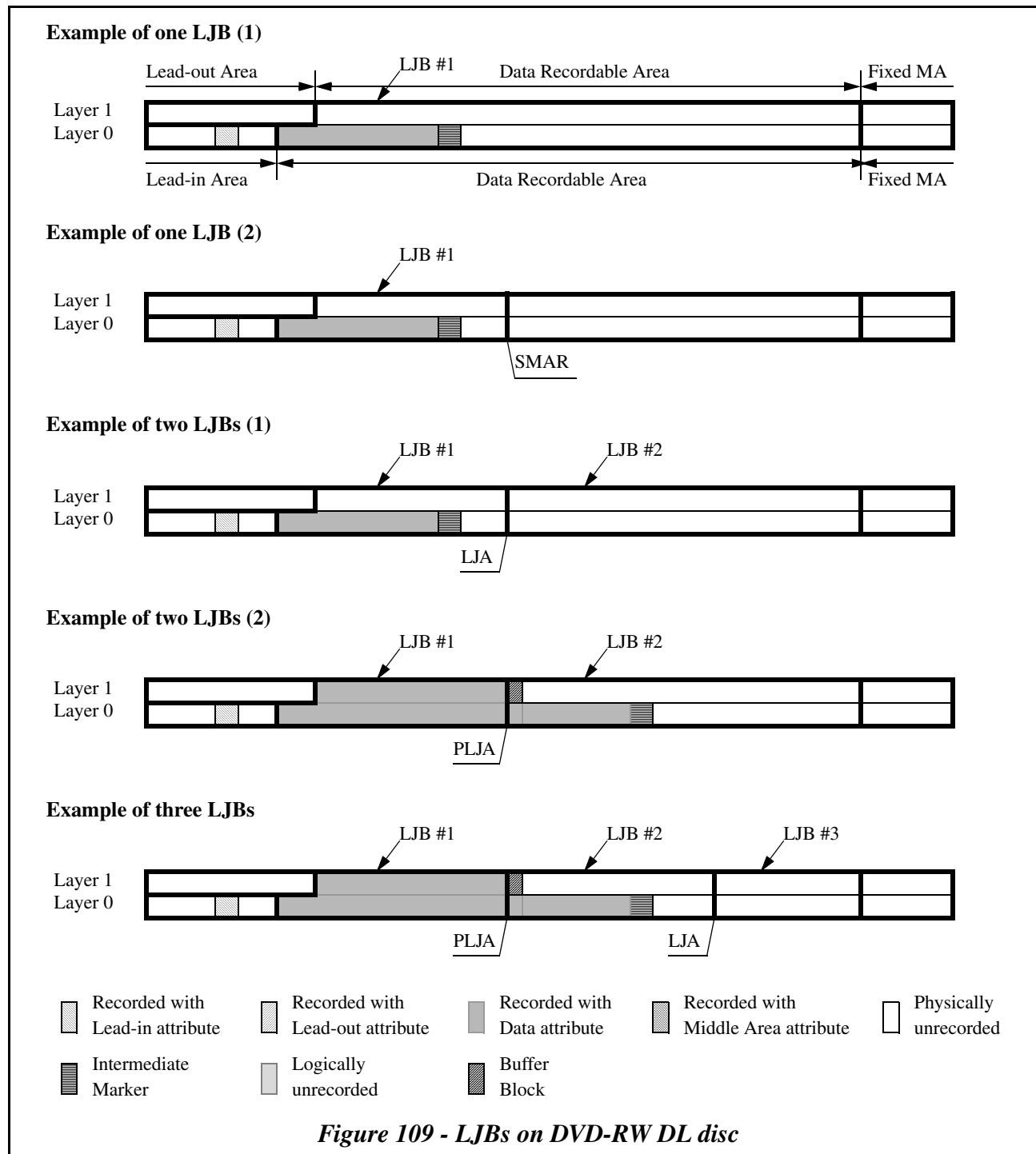
The LJA is specified by Manual Layer Jump Address function of SEND DISC STRUCTURE command. The LJA is also calculated from JI specified by Jump Interval size function of SEND DISC STRUCTURE command. The SMAR is specified by Shifted Middle Area Start Address function of SEND DISC STRUCTURE command.

If an LJB does not contain any logically recorded sector, the LJB is blank. A blank LJB may contain the NWA but never contain LRA.

An LJB which contains the NWA is called Active LJB. Within the Active LJB, NWA starts moving at the first block in the second ECC block on L0 part and moves toward the LJ point. When the NWA reaches to the LJ point of the LJB, NWA jumps to the outermost block in L1 part of the LJB.

DVD-RW DL disc consists of one, two or three LJBs.

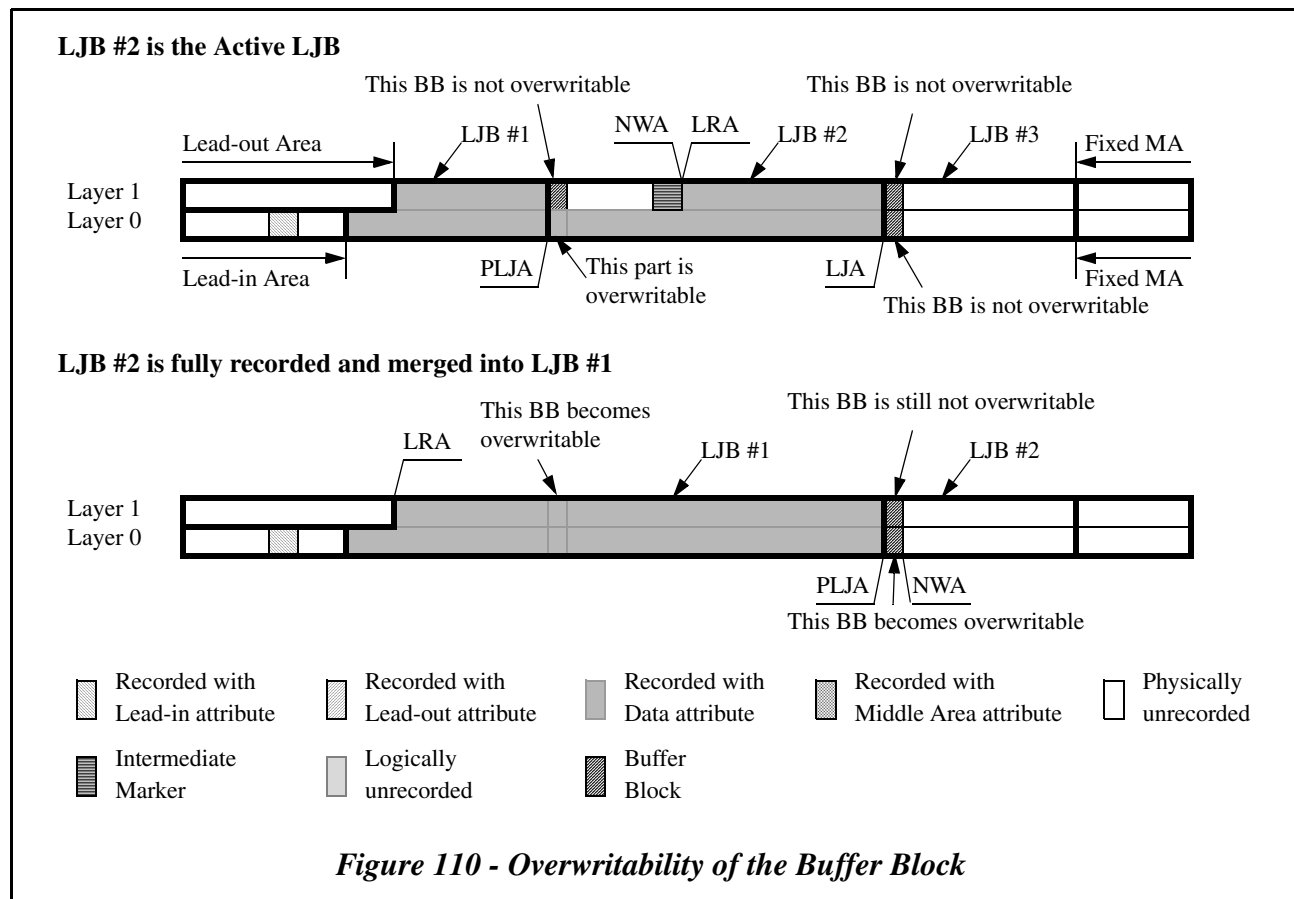
- If both LJA and PLJA are zero, the number of LJBs on the disc is one. If either LJA or PLJA is zero and the other is non-zero, it is two. If both LJA and PLJA are non-zero, it is three. See Figure 109.
- Between each LJBs, there is no blocks.
- When the NWA in the second LJB reaches to $\overline{PLJA + 17}$,
 - the LJB is merged into the first LJB and the third LJB becomes the second LJB and active, if exists,
 - the LJA *shall* move to $LJA + JI + 16$ if JI is set, otherwise the LJA *shall* move to EDA,
 - LJA is copied to PLJA and LJA is set to zero, and
 - the NWA *shall* move to $PLJA + 17$.
- Regarding the second and third LJBs, the L0 part of the LJB and the L1 part of it are the same size.



On DVD-R DL discs, BSGA and LLA are created at a Layer Jump address when Layer jump occurs. See Figure 65 - LJB structure of Invisible/Incomplete RZone on page 177. Although DVD-RW DL logical units do not utilize a Linking Loss area in Data Recordable Area, the same kind of structure is generated during Layer jump recording to keep consistency with DVD-R DL Layer jump recording. This structure is referred to as Buffer Block. The size of the Buffer Block on each Layer is 32 KB with all 00h data. The Buffer Block on L0 is created immediately after the Layer jump address on L0 and that on L1 is located immediately before the Layer jump destination address on L1 when a Layer

jump occurs. Unlike BSGA or LLA on DVD-R DL discs, the Data Type bit value of the sectors in a Buffer Block is set to 0b. These Buffer Blocks are included in the following LJB.

The Buffer Block on L0 in an LJB *shall* become overwriteable when the LJB becomes Active LJB. The Buffer Block on L1 in an LJB *shall* become overwriteable when the LJB is fully recorded. See Figure 110.



When the Buffer Block on L0 in the second LJB is overwritten, the LRA *shall* move to the address of NWA - 1.

4.21.4.2.2 NWA motion

The NWA motion of the DVD-RW DL Layer Jump recording is same as DVD-R DL Layer Jump recording. See 4.18.5.3.2, "Manual Layer Jump" on page 184 and 4.18.5.3.3, "Regular Interval Layer Jump" on page 187.

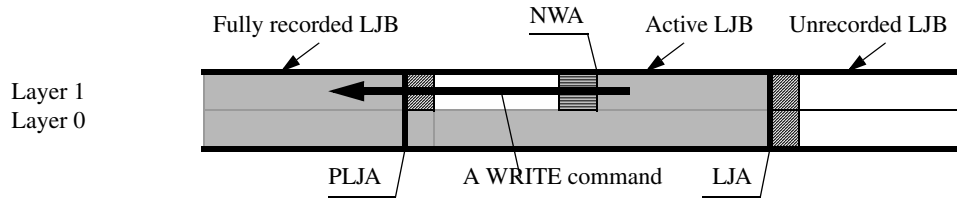
4.21.4.2.3 WRITE command over the Buffer Block

The LBA Extent requested by one WRITE command is allowed to include zero or more logically recorded area(s) and zero or one logically unrecorded area. If a logically unrecorded area is included in the LBA Extent, the first block of the area included in the LBA Extent *shall* be the NWA.

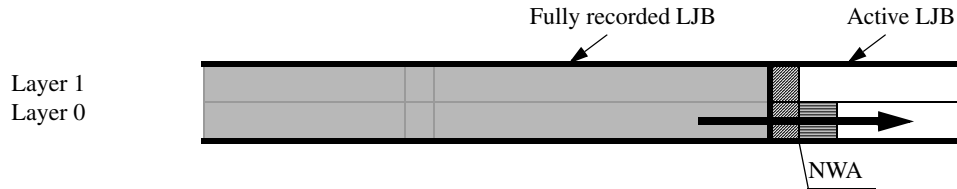
If the LBA Extent specified by a WRITE command starts at a logically unrecorded block except the block specified by NWA, the command *shall* be terminated with CHECK CONDITION Status, 5/21/02 INVALID ADDRESS FOR WRITE.

If the LBA Extent specified by a WRITE command includes the block specified by LJA + 1 or the first block of the Shifted Middle Area, the command *shall* be terminated with CHECK CONDITION Status, 5/21/03 INVALID WRITE CROSSING LAYER JUMP.

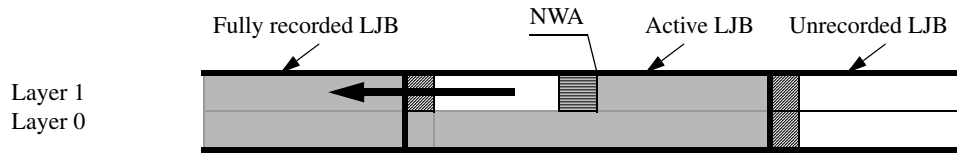
Example 1: Acceptable WRITE command



Example 2: Acceptable WRITE command

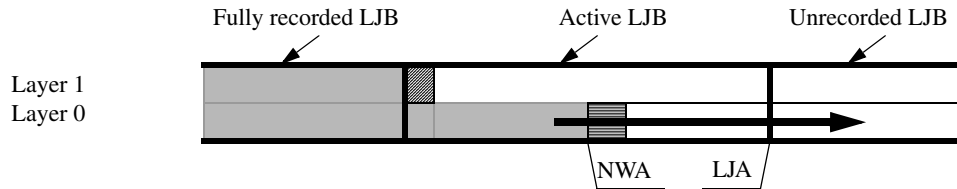


Example 3: Unacceptable WRITE command



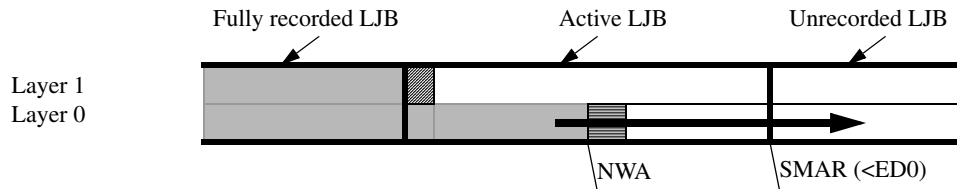
The requested LBA Extent status at the logically unrecorded block other than NWA.

Example 4: Unacceptable WRITE command



The requested LBA Extent includes the block specified by LJA + 1.

Example 5: Unacceptable WRITE command



The requested LBA Extent includes the first block of the Shifted Middle Area.

- Recorded with Lead-in attribute
- Recorded with Lead-out attribute
- Recorded with Data attribute
- Recorded with Middle Area attribute
- Physically unrecorded
- Intermediate Marker
- Logically unrecorded
- Buffer Block

Figure 111 - WRITE command

4.21.5 Command response on each RZone condition

All the abbreviations in Table 121, Table 122, Table 123 and Table 125 are the same one used in Table 117

Table 121 - Parameters for Contiguous condition

Field	Field value			
RMD				
Disc Status	00h	13h	13h	12h
End PSN of RZone	00h	<EDA	EDA	MDA MD0 (=MDA)
Last recorded PSN	ERZ			00h
Layer Jump PSN on Layer 0	00h			
Previous Layer Jump PSN on Layer 0	00h			
Jump interval	00h			
Start PSN of the Middle Area	00h		ED0 + 1	≤ED0 + 1
Disc Information Block of READ DISC INFORMATION command				
Disc Status	01b			10b
Status of Last Session	01b			11b
Track Information Block of READ TRACK INFORMATION command				
LJRS	00b			
Blank	1b	0b		0b
Next Writable Address	00h	F(LRA) ^a + 1	Invalid	Invalid
Track Size / RZone End Address	(ED0 - SDA + 1) + (EDA - ED0 + 1)		(MD0 - SDA + 1) + (MDA - MD0 + 1)	MDA - SDA + 1
Last Recorded Address	Invalid	F(LRA)		Invalid
Next Layer Jump Address	00h			
Last Layer Jump Address	00h			
READ DISC STRUCTURE command				
Jump Interval size	00h			
Shifted Middle Area Start Address	00h		F(SMAP)	

a. F(X) is a formula to convert the PSN of X to the assigned Logical Block Address.

Table 122 - Parameters for LJA unspecified state of Non-contiguous condition

Field	Field value				
RMD					
Disc Status	00h	13h	13h	13h	12h
End PSN of RZone	00h		EDA	EDA	>SMAP - 1
Last recorded PSN	ERZ		ERZ	ERZ	00h
Layer Jump PSN on Layer 0	00h				
Previous Layer Jump PSN on Layer 0	00h		X		00h
Jump interval	00h				
Start PSN of the Middle Area	<ED0 + 1	<ED0 + 1	00h or ED0 + 1	<ED0 + 1	
Disc Information Block of READ DISC INFORMATION command					
Disc Status	01b			01b	10b
Status of Last Session	01b			01b	11b
Track Information Block of READ TRACK INFORMATION command					
LJRS	01b				
Blank	1b	0b		0b	
Next Writable Address	00h	F(X) ^a + 17		Invalid	
Track Size / RZone End Address	F(EDA)				
Last Recorded Address	Invalid	F(LRA)		F(LRA)	Invalid
Next Layer Jump Address	F(SMAR) - 1	F(SMAR) - 1	F(ED0)	00h	
Last Layer Jump Address	00h	F(X)		00h	
READ DISC STRUCTURE command					
Jump Interval size	00h				
Shifted Middle Area Start Address	F(SMAR)	F(SMAR)	00h	F(SMAR)	F(SMAP)

a. F(X) is a formula to convert the PSN of X to the assigned Logical Block Address.

Table 123 - Parameters for Manual Layer Jump state of Non-contiguous condition (1)

Field	Field value							
RMD								
Disc Status	00h	13h	13h	13h	13h	13h		
End PSN of RZone	00h		<EDA		<EDA			EDA
Last recorded PSN	ERZ							<ERZ
Layer Jump PSN on Layer 0	X				00h			00h
Previous Layer Jump PSN on Layer 0	00h							Y
Jump interval	00h							
Start PSN of the Middle Area	\leq ED0 + 1				<ED0 + 1			00h or ED0 + 1
Disc Information Block of READ DISC INFORMATION command								
Disc Status	01b							
Status of Last Session	01b							
Track Information Block of READ TRACK INFORMATION command								
LJRS	10b							
Blank	1b		0b		0b			0b
Next Writable Address	00h		$F(LRA)^a + 1$		$F(LRA) + 1$			$F(LRA) + 1$
Track Size / RZone End Address	F(EDA)							
Last Recorded Address	Invalid		F(LRA)		F(LRA)			F(LRA)
Next Layer Jump Address	F(X)	F(X)	F(EDA)	$F(SMAR) - 1$	00h		F(ED0)	00h
Last Layer Jump Address	00h	00h	F(X)	00h	$F(SMAR) - 1$		F(Y)	F(ED0)
READ DISC STRUCTURE command								
Jump Interval size	00h							
Shifted Middle Area Start Address	00h or F(SMAR)				F(SMAR)			00h

a. F(X) is a formula to convert the PSN of X to the assigned Logical Block Address.

Table 124 - Parameters for Manual Layer Jump state of Non-contiguous condition (2)

Field	Field value			
RMD				
Disc Status	13h			
End PSN of RZone	EDA			
Last recorded PSN	<ERZ	<ERZ	ERZ	<ERZ
Layer Jump PSN on Layer 0	00h	X		X
Previous Layer Jump PSN on Layer 0	Y			
Jump interval	00h			
Start PSN of the Middle Area	<ED0 + 1	≤ED0 + 1		<ED0 + 1
Disc Information Block of READ DISC INFORMATION command				
Disc Status	01b			
Status of Last Session	01b			
Track Information Block of READ TRACK INFORMATION command				
LJRS	10b			
Blank	0b			
Next Writable Address	F(LRA) ^a + 1	F(LRA) + 1	F(Y) + 17	F(LRA) + 1
Track Size / RZone End Address	F(EDA)			
Last Recorded Address	F(LRA)			
Next Layer Jump Address	F(SMAR) - 1	00h	F(X)	F(Y - 17)
Last Layer Jump Address	F(Y)	F(SMAR) - 1	F(Y)	F(X)
READ DISC STRUCTURE command				
Jump Interval size	00h			
Shifted Middle Area Start Address	F(SMAR)	00h or F(SMAR)		F(SMAR)

a. F(X) is a formula to convert the PSN of X to the assigned Logical Block Address.

Table 125 - Parameters for Regular Interval state of Non-contiguous condition

Field	Field value					
RMD						
Disc Status	00h	13h	13h	13h	13h	
End PSN of RZone	00h	<EDA	EDA	EDA	EDA	
Last recorded PSN	ERZ	ERZ	<ERZ	ERZ	ERZ	
Layer Jump PSN on Layer 0	X					
Previous Layer Jump PSN on Layer 0	00h	00h	Y	Y	Y	
Jump interval	Z					
Start PSN of the Middle Area	$\leq \text{ED0} + 1$					
Disc Information Block of READ DISC INFORMATION command						
Disc Status	01b					
Status of Last Session	01b					
Track Information Block of READ TRACK INFORMATION command						
LJRS	11b					
Blank	1b	0b	0b	0b	0b	
Next Writable Address	00h	$F(\text{LRA})^a + 1$	$F(\text{LRA}) + 1$	$F(\text{Y}) + 17$	$F(\text{Y}) + 17$	
Track Size / RZone End Address	$F(\text{EDA})$					
Last Recorded Address	Invalid	$F(\text{LRA})$	$F(\text{LRA})$	$F(\text{LRA})$	$F(\text{LRA})$	
Next Layer Jump Address	$F(\text{X})$	$F(\text{X})$	$F(\text{EDA})$	$F(\text{X})$	$F(\text{Y} - 17)$	$F(\text{X})$
Last Layer Jump Address	00h	00h	$F(\text{X})$	$F(\text{Y})$	$F(\text{X})$	$F(\text{Y})$
READ DISC STRUCTURE command						
Jump Interval size	$F(\text{Z})$					
Shifted Middle Area Start Address	00h or $F(\text{SMAR})$					

a. $F(\text{X})$ is a formula to convert the PSN of X to the assigned Logical Block Address.

4.21.6 RMA structure

On DVD-RW DL discs, Format1 RMD is not defined due to removal of the Sequential Recording mode. Only Format2 and Format 3 RMDs are used.

The RMA logical structure and its usage are same as that of DVD-RW SL media. See Figure 101 - *RMA structure for Restricted overwrite mode* on page 231.

4.21.7 RMD contents for DVD-RW DL media

All the initial value of RMD is 0. The RMD structures described in this section are defined by DVD-RW DL Ver.2.0. For the other versions of DVD-RW discs, see applicable DVD-RW Book.

4.21.7.1 RMD - Field0 (RMD Header)

The RMD Field0 shows the general disc information and is recorded as shown in Table 126.

Table 126 - RMD - Field0

Bit Byte	7	6	5	4	3	2	1	0
0-1	RMD Format							
2	Disc Status							
3	Reserved							
4-21	Unique Disc ID							
22-85	Copy of Pre-pit Information							
86-89	Start PSN of the Middle Area (Reserved for Format2 RMD Field0)							
90	Pre-recorded/Embossed information code (Reserved for Format2 RMD Field0)							
91	Reserved							
92-95	End ECC block address of pre-recorded/embossed Lead-in Area (Reserved for Format2 RMD Field0)							
96-99	End ECC block address of pre-recorded/embossed Middle Area on Layer 0 (Reserved for Format2 RMD Field0)							
100-103	Start ECC block address of pre-recorded/embossed Middle Area on Layer 1 (Reserved for Format2 RMD Field0)							
104-107	Start ECC block address of pre-recorded/embossed Lead-out Area (Reserved for Format2 RMD Field0)							
108-127	Reserved							
128	RBG Information							
129-2 047	Reserved							

The RMD Format field specifies the format of the following RMD Field1- Field14 of this RMD block. The RMD Format field is defined in Table 127.

Table 127 - RMD Format field definition

Value	Definition
0	Reserved
1	Restricted (See RMD format for DVD-R and DVD-RW SL)
2	The RMD Field1 through Field14 are recorded as Format 2 RMD specified in DVD-RW DL Ver. 2.0
3	The RMD Field1 through Field14 are recorded as Format 3 RMD specified in DVD-RW DL Ver. 2.0
4	Restricted (See RMD format for DVD-R DL)
5-65 535	Reserved

The **Disc Status** field indicates the disc status as defined in Table 128.

The most significant bit of the **Disc Status** field indicates whether the disc is write protected or not. If the most significant bit of the **Disc Status** field is set to 1, the disc is write protected. Otherwise, the disc is not write protected. When the **Disc Status** is 10h or 11h, the most significant bit *shall not* be set.

Table 128 - Disc Status field definition

Value	Definition	Available RMD Format
Not Write Protected		
00h	The disc has no written data in Data Recordable Area (only RMDs are written)	Format3
01h-0Fh	Reserved	-
10h	The current disc status is specified by Disc Status field of valid Format 3 RMD block	Format2
11h	A formatting is in progress on the disc	Format3
12h	The disc is in the Complete state	Format3
13h	The disc is in the Intermediate state	Format3
14h-7Fh	Reserved	-
Write Protected		
80h	The disc has no written data in Data Recordable Area (only RMDs are written) and write protected except R-Information area	Format3
81h-91h	Reserved	-
92h	The disc is in the Complete state and write protected except R-Information area	Format3
93h	The disc is in Intermediate state and write protected except R-Information area	Format3
94h-FFh	Reserved	-

Unique Disc ID field is structured as shown in Table 53 - *Unique Disc ID* on page 148.

Copy of Pre-pit Information field contains the copy of Pre-pit Information data that is recorded as LPP (Land Pre-Pit) on the DVD-RW DL medium. Copy of Pre-pit Information structure is shown in Table 129. Pre-pit information data is specified by DVD-RW DL Ver. 2.0.

Table 129 - Copy of Pre-pit Information

Bit Byte	7	6	5	4	3	2	1	0
22	Field ID (= 01h)							
23	Application code							
24	Disc Physical code							
25-27	Last address of Data Recordable Area on Layer 0							
28	LPP Part Version				Extension code			
29	Reserved							
30	Field ID (= 02h)							
31-32	Reserved							
33-35	Last address of Data recordable Area on Layer 1							
36-37	Reserved							
38	Field ID (= 03h)							
39-44	1 st field of Manufacturer ID							
45	Reserved							
46	Field ID (= 04h)							
47-52	2 nd field of Manufacturer ID							
53	Reserved							
54	Field ID (= 05h)							
55-60	Reserved							
61-85	Reserved							

The Start PSN of the Middle Area field indicates the start PSN of the logical Middle Area that may be same address of the physically recorded Middle Area. In the case of logical Shifted Middle Area, the actual Shifted Middle Area may not be recorded at the address if Middle Area is recorded at outer side. When Fixed Middle Area is recorded and is valid (i.e., user data is recorded at the end PSN of L0), this field indicates the start PSN of the Fixed Middle Area. If there is no valid Middle Area on the disc, this field is set to 00h. In Format2 RMD Field0, this field is reserved.

The Pre-recorded/Embossed information code field identifies the recorded status of Initial zone in the Lead-in Area, Lead-out Area and Middle Area.

Table 130 - Pre-recorded/Embossed information code field definition

Bit	Definition
0	This bit is set to zero to indicate that the Control Data Zone is embossed
1	When set to zero, the Initial zone in Lead-in is not pre-recorded/embossed. When set to one, the Initial zone in Lead-in is pre-recorded/embossed.
2	When set to zero, the Fixed Middle Area is not pre-recorded/embossed. When set to one, the Fixed Middle Area is pre-recorded/embossed.
3	When set to zero, the Lead-out is not pre-recorded/embossed. When set to one, the Lead-out is pre-recorded/embossed.
4	When set to zero, a Middle Area does not exist. When set to one, a Middle Area exists from just after the sector pointed by OR0 field.
5-7	Reserved

The End ECC block address of pre-recorded/embossed Lead-in Area field indicates the end ECC block address of pre-recorded/embossed Lead-in. When the bit 1 of Pre-recorded/Embossed information code field in embossed CDZ is set to one, this field value is FFD1E0h. In this case, the bit 1 of the Pre-recorded/Embossed information code field in Format 3 RMD Field0 is also set to one.

The End ECC block address of pre-recorded/embossed Middle Area on Layer 0 field indicates the end ECC block address of pre-recorded/embossed Fixed Middle Area on L0. When the bit 2 of Pre-recorded/Embossed information code field is set to one, this field value is FDCF6Dh (120 mm disc) or FF2F22h (80 mm disc). In this case, the bit 2 of the Pre-recorded/Embossed information code field in Format3 RMD Field0 is also set to one.

The Start ECC block address of pre-recorded/embossed Middle Area on Layer 1 field indicates the start ECC block address of pre-recorded/embossed Fixed Middle Area on L1. When the bit 2 of Pre-recorded/Embossed information code field is set to one, this field value is 023573h (for 120 mm disc) or 00D4D6h (for 80 mm disc). In this case, the bit 2 of the Pre-recorded/Embossed information code field in Format3 RMD Field0 is also set to one.

The Start ECC block address of pre-recorded/embossed Lead-out Area field indicates the start ECC block address of pre-recorded/embossed Lead-out. When the bit 3 of Pre-recorded/Embossed information code field is set to one, this field is Y-1, where Y is the Last address of Data Recordable Area on L1 specified in Pre-pit information. In this case, the bit 3 of the Pre-recorded/Embossed information code field in Format3 RMD Field0 is also set to one.

The RMD Block Group Information (RBG Information) field is structured as Table 131. This field *shall* be used when RMD blocks are recorded sequentially with same contents. The RMD blocks that are recorded sequentially with the same contents (except RBG Number field) is referred to as RMD Block Group. The RMD blocks of RMD Block Group have the same RBG Length value. The RBG Number value starts from 1 and is increased by 1 up to RBG Length value in the RMD blocks of RMD Block Group. On DVD-RW DL media, an RMD is recorded as RMD Set that consists of five RMD blocks. Therefore the RBG Length field is set to 5 and the RBG Number field is incremented from 1 to 5 in an RMD Set.

Table 131 - RBG Information field definition

Bit	7	6	5	4	3	2	1	0
Byte	RBG Number				RBG Length			
128								

4.21.7.2 Format 2 RMD Field1

The Format 2 RMD Field1 contains pointer to the start address of the Format 3 RMD Set in the same RMA Segment.

Table 132 - Format 2 RMD Field1

Bit Byte	7	6	5	4	3	2	1	0
0-3	Update Counter							
4-7	Format 3 RMD Set pointer							
8-15	Reserved							
16	RSDS #8	RSDS #7	RSDS #6	RSDS #5	RSDS #4	RSDS #3	RSDS #2	Reserved
17	RSDS #16	RSDS #15	RSDS #14	RSDS #13	RSDS #12	RSDS #11	RSDS #10	RSDS #9
18	RSDS #24	RSDS #23	RSDS #22	RSDS #21	RSDS #20	RSDS #19	RSDS #18	RSDS #17
19	Reserved				RSDS #28	RSDS #27	RSDS #26	RSDS #25
20-2 047	Reserved							

The Update Counter field contains the number of times to which this RMD Set is rewritten. The initial value of this field is 0. The value of this field *shall* be incremented by 1 when this field is rewritten. The value is taken over and is also incremented when the RMA Segment that is used to record RMD Set is changed. This value is used to determine which RMA Segment is current.

The Format 3 RMD Set pointer field contains pointer to start address of the latest Format 3 RMD Set in this RMA Segment. The indicated RMD Set contains Format 3 RMD blocks.

The RMA Segment Defect Status (RSDS #n) bit indicates whether the Format 3 RMD Set in the RMA Segment is defective or not. If set to 1, the RMD Set #n of the RMA Segment is defective (EDC error occur in at least 3 RMD blocks of an RMD Set). Otherwise the RMD Set #n of the RMA Segment is non-defective.

4.21.7.3 Format 2 RMD Field2 to Field14

The Format 2 RMD Field2 through Field14 are reserved and set to all 00h.

4.21.7.4 Format 3 RMD Field1

The Format 3 RMD Field1 contains some logical units and OPC related information as defined in Table 133.

Table 133 - Format3 RMD - Field1

Bit Byte	7	6	5	4	3	2	1	0
0-31	Drive manufacturer ID #1							
32-47	Serial Number #1							
48-63	Model Number #1							
64-71	2×-speed Write Strategy code for Layer 0 #1							
72-79	Reserved							
80-83	Recording power #1							
84-91	Timestamp #1							
92-95	Power Calibration Address #1							
96-107	Running OPC Information #1							
108-117	2×-speed Write Strategy code for Layer 1 with 2T-multi-pulse #1							
118-125	2×-speed Write Strategy code for Layer 1 #1							
126-127	Reserved							
:	:							
384-415	Drive manufacturer ID #4							
416-431	Serial Number #4							
432-447	Model Number #4							
448-455	2×-speed Write Strategy code for Layer 0 #4							
456-463	Reserved							
464-467	Recording power #4							
468-475	Timestamp #1							
476-479	Power Calibration Address #4							
480-491	Running OPC Information #4							
492-501	2×-speed Write Strategy code for Layer 1 with 2T-multi-pulse #4							
502-509	2×-speed Write Strategy code for Layer 1 #4							
510-511	Reserved							
512-2 047	Reserved							

4.21.7.5 Format 3 RMD Field2

The Format 3 RMD Field2 contains user specific data as defined in Table 56 - *Format 1 RMD - Field 2 (User specific data)* on page 151.

4.21.7.6 Format 3 RMD Field3

The Format 3 RMD Field3 contains RZone and Layer jump recording related information and *shall* be recorded as shown in Table 134. There is only one RZone on a disc. This Field also contains the information of the format operation.

Table 134 - Format 3 RMD Field3

Bit Byte	7	6	5	4	3	2	1	0
0	Format Operation Code							
1	Reserved							
2-5	Format Information1							
6-9	Format Information2							
10-255	Reserved							
256-257	Last RZone Number							
258-261	Start PSN of RZone							
262-265	End PSN of RZone							
266-511	Reserved							
512-515	Layer Jump PSN on Layer 0							
516-519	Last recorded PSN							
520-523	Previous Layer Jump PSN on Layer 0							
524-525	Jump interval							
526-527	Reserved							
528-531	Outermost PSN of the recorded area with data area attribute on Layer 0							
532-535	Outermost PSN of the recorded area with data area attribute on Layer 1							
536-2 047	Reserved							

The Format Operation Code field contains the format operation code as defined in Table 135.

The Format Information1 and the Format Information2 fields contain the information related with the Format Operation Code as defined in Table 135.

Table 135 - Format Operation Code, Format Information1 and Format Information2 fields definition

Format Operation Code ^a	Format Information1 field ^a	Format Information2 field ^a	Format operation
00h	Reserved	Reserved	No format operation is in progress.
01h	Start PSN ^{bc}	Number of ECC blocks ^d	Full Format
02h	Start PSN ^b	Number of ECC blocks	Grow Format
03h	Reserved	Reserved	Reserved
04h	Start PSN ^b	Number of ECC blocks	Quick Grow Format
05h	Start PSN ^{be}	Number of ECC blocks	Quick Format
06h	Start PSN ^b	Marker PSN ^f	Close Intermediate state
07h	Start PSN ^b	End PSN ^g	Fast Re-format
others	Reserved	Reserved	Reserved

a. At the completion of the format operation, these field *shall* be set to 00h.

b. Start PSN contains the PSN of the first sector of the ECC block where the specified format operation is started.

- c. In case of Full Format operation, this field is set to 024440h when NBCA is not allocated or 02D5B0h when NBCA is allocated.
- d. Number of ECC blocks contains the value that is the number of user data ECC blocks to be formatted by the specified format operation.
- e. In case of Quick Format operation, this field is set to the first PSN of RW-Physical format information zone and is set to 2E400h.
- f. Marker PSN contains the PSN of the last sector of the ECC block where the close operation on L0 is finished (Outermost PSN of Shifted Middle Area or Fixed Middle Area on L0).
- g. End PSN contains the end PSN of the specified format area for this format operation.

The Last RZone Number field contains the last RZone number of the medium. This field *shall* be set to 1h.

The Start PSN of RZone field contains the PSN of the start block of the RZone. This field is set to 30000h.

The End PSN of RZone field contains the PSN of the last block of the RZone. When a disc is in Intermediate state, this field should be updated at appropriate period. If this field contains 0, this field is invalid.

The Layer Jump PSN on Layer 0 field contains the PSN of the Layer Jump Address on L0. When Jump interval is specified, this field contains a PSN that is calculated from the Jump interval field. Neither the End PSN of L0 nor the Start PSN of the Middle Area - 1 is set to this field as a Layer Jump Address. If no Layer Jump Address is specified, this field is set to 00h. When the Active LJB has been fully recorded, this field is set to 00h.

The Last recorded PSN contains the last recorded PSN of the host supplied data. The first byte of this field specifies whether the address is located on L0 or L1. See Table 136. The following 3 bytes contains the PSN. If these 3 bytes contains 00h, this field is not valid. This field may not be correct due to the update condition of RMD.

Table 136 - The first byte of the Last recorded PSN field

Value	Definition
00h	LRA is located on L0
FFh	LRA is located on L1
Others	Reserved

The Previous Layer Jump PSN on Layer 0 field indicates the previous Layer Jump Address that is copied from the Layer Jump PSN on Layer 0 field. The copy occurs when the Active LJB has been fully recorded.

The Jump interval field contains the Jump interval width that is specified by the number of ECC blocks on L1. The Buffer Block is not counted as an interval.

The Outermost PSN of the recorded area with data area attribute on Layer 0 field indicates the outermost PSN of the physically recorded area in the Data Recordable Area on L0. All blocks in the Data Recordable Area on L0 located inner radius than this PSN is recorded with Area Type field set to Data Area. Outermost PSN of the recorded area with data area attribute on Layer 0 may not be updated to the latest value. If a logically recorded block exist outer than Outermost PSN of the recorded area with data area attribute on Layer 0, the outermost logically recorded block on Layer 0 *shall* be considered as Outermost PSN of the recorded area with data area attribute on Layer 0.

The Outermost PSN of the recorded area with data area attribute on Layer 1 field indicates the outermost PSN of the physically recorded area in the Data Recordable Area on L1. All blocks in the Data Recordable Area on L1 located inner radius than this PSN is recorded with Area Type field set to Data Area. If one or more logically recorded blocks exist outer adjacent to Outermost PSN of the recorded area with data area attribute on Layer 1, the outermost block of the recorded LBA Extent which include Outermost PSN of the recorded area with data area attribute on Layer 1 *shall* be considered as Outermost PSN of the recorded area with data area attribute on Layer 1.

4.21.7.7 Format 3 RMD Field4 to Field12

Format 3 RMD Field4 through Field12 contains the Defect Status Bitmap.

Table 137 - Format 3 RMD Field4

Bit Byte	7	6	5	4	3	2	1	0
0-3	PSN of previous Defect Status Bitmap RMD Set							
4-7	Certification Start PSN							
8-11	Certification End PSN							
12	DS #8	DS #7	DS #6	DS #5	DS #4	DS #3	DS #2	DS #1
13	DS #16	DS #15	DS #14	DS #13	DS #12	DS #11	DS #10	DS #9
14	DS #24	DS #23	DS #22	DS #21	DS #20	DS #19	DS #18	DS #17
:	:	:	:	:	:	:	:	:
2 045	DS #16 272	DS #16 271	DS #16 270	DS #16 269	DS #16 268	DS #16 267	DS #16 266	DS #16 265
2 046	DS #16 280	DS #16 279	DS #16 278	DS #16 277	DS #16 276	DS #16 275	DS #16 274	DS #16 273
2 047	DS #16 288	DS #16 287	DS #16 286	DS #16 285	DS #16 284	DS #16 283	DS #16 282	DS #16 281

The PSN of previous Defect Status Bitmap RMD Set field contains start physical sector number of RMD Set that contains previously generated Defect Status Bitmap. If this field contains 0, this field is invalid.

Note: When areas on different address range are certified, plural Format3 RMD Sets may be recorded with different range of Defect Status Bitmap. On DVD-RW DL discs, when an address range more than Single Layer capacity is requested to be certified, two or more Format3 RMD Sets need to be recorded to store the Defect Status Bitmap of certified ECC blocks on the disc.

Certification Start PSN field contains the start sector number of the ECC block where the following Defect Status Bitmap starts. If this field contains 0, this field and subsequent fields (Certification End PSN, DS #n) are invalid.

Certification End PSN field contains the end sector number of the ECC block where the following Defect Status Bitmap ends.

DS #n bit may contain certification result of the ECC block #n. When DS #n bit is set to 0, indicate that the ECC block has no defect and is able to read and write the block safely (no EDC error occurs in the ECC block). When DS #n bit is set to 1, indicates that the ECC block has defect and might not be able to read and write the block safely (an EDC error occurs in the ECC block).

Table 138 - Format 3 RMD Field5 - Field12

Bit Byte	7	6	5	4	3	2	1	0
0	DS #(n+7)	DS #(n+6)	DS #(n+5)	DS #(n+4)	DS #(n+3)	DS #(n+2)	DS #(n+1)	DS #n
1	DS #(n+15)	DS #(n+14)	DS #(n+13)	DS #(n+12)	DS #(n+11)	DS #(n+10)	DS #(n+9)	DS #(n+8)
:	:	:	:	:	:	:	:	:
2 046	DS #(n+16 375)	DS #(n+16 374)	DS #(n+16 373)	DS #(n+16 372)	DS #(n+16 371)	DS #(n+16 370)	DS #(n+16 369)	DS #(n+16 368)
2 047	DS #(n+16 383)	DS #(n+16 382)	DS #(n+16 381)	DS #(n+16 380)	DS #(n+16 379)	DS #(n+16 378)	DS #(n+16 377)	DS #(n+16 376)

4.21.7.8 Format 3 RMD Field13

The Format 3 RMD Field13 contains drive specific information. The definition is the same as defined in 4.18.6.2.6, "Format 1 RMD Field 13" on page 213.

4.21.7.9 Format 3 RMD Field14

Format 3 RMD Field14 specifies versatile information of a disc and logical unit. The definition is the same as defined in Table 139.

Table 139 - Format3 RMD - Field14

Bit Byte	7	6	5	4	3	2	1	0
0-8	Reserved							
9-12	Testing address of Inner Disc Testing Area on Layer 0							
13-16	Testing address of Inner Disc Testing Area on Layer 1							
17-20	Testing address of Outer Disc Testing Area on Layer 0							
21-24	Testing address of Outer Disc Testing Area on Layer 1							
25-28	Testing address of optional Inner Disc Testing Area on Layer 1							
29-2 047	Reserved							

4.21.8 Formatting

The Blank state DVD-RW DL medium is treated as Incomplete disc with NWA=0 as described in Section 4.21.3.3. But if the host needs to format the medium in the other format type, FORMAT UNIT command is required to be issued in advance to start recording.

DVD-RW DL media do not support Multi-border structure. Therefore format operation of Add Session/Border format and Quick Add Border format are not supported. The DVD-RW DL supports following format operations.

1. Full format operation (Format Type = 00h, 10h)
2. Grow format operation (Format Type = 11h)
3. Quick Grow format operation (Format Type = 13h)
4. Quick format operation (Format Type = 15h)
5. DVD-RW Fast Re-format operation (Format Type = 18h)

4.21.8.1 Faster formatting mechanism

Faster formatting is defined as a formatting method to make the disc be usable as randomly writable.

Formatting for some types of media is to write data to all the blocks within the requested region to be formatted in Data Area to make the region be readable by the read-only devices. For such a media type, making all blocks on L0 and the corresponding area on L1, in case of Dual layer disc, be recorded may be the minimum and enough required action to the formatting. If a block has already been physically recorded before formatting, the block is not necessary to be written again during formatting. To do so, a mechanism to recognize where has been recorded by the user data is necessary.

DVD-RW DL physical specification achieves this Faster formatting mechanism by adopting the information of OR0 field and the OR1 field in RMD. The area between the address specified by the OR0 field and the start address of Data Recordable Area is guaranteed to be physically recorded with Area Type field set to Data Area. The area between the address specified by the OR1 field and the end address of Data Recordable Area is guaranteed to be physically recorded with Area Type field set to Data Area. These address information may be registered in the Format3 RMD Field3 when RMD is updated. A formatting process can be shortened because the writing operation during formatting is not necessary on the area that is inner radius indicated by OR0 field and OR1 field.

As an additional effect of Faster formatting method, the recorded data in Data Recordable Area with Area Type field set to Data Area before formatting can be preserved. This mechanism may be useful for some kinds of application.

All the other usage of FORMAT UNIT command except Fast Re-format (Format Type = 18h) is same as DVD-RW SL disc. See 4.20.10, "Formatting" on page 242.

Since updating of OR0 field and OR1 field is optional, the logical unit *shall* ensure these field values are correct by the time when those are used. Also it is recommended that the logical unit should update these field values when RMD is updated.

4.21.8.2 Full format

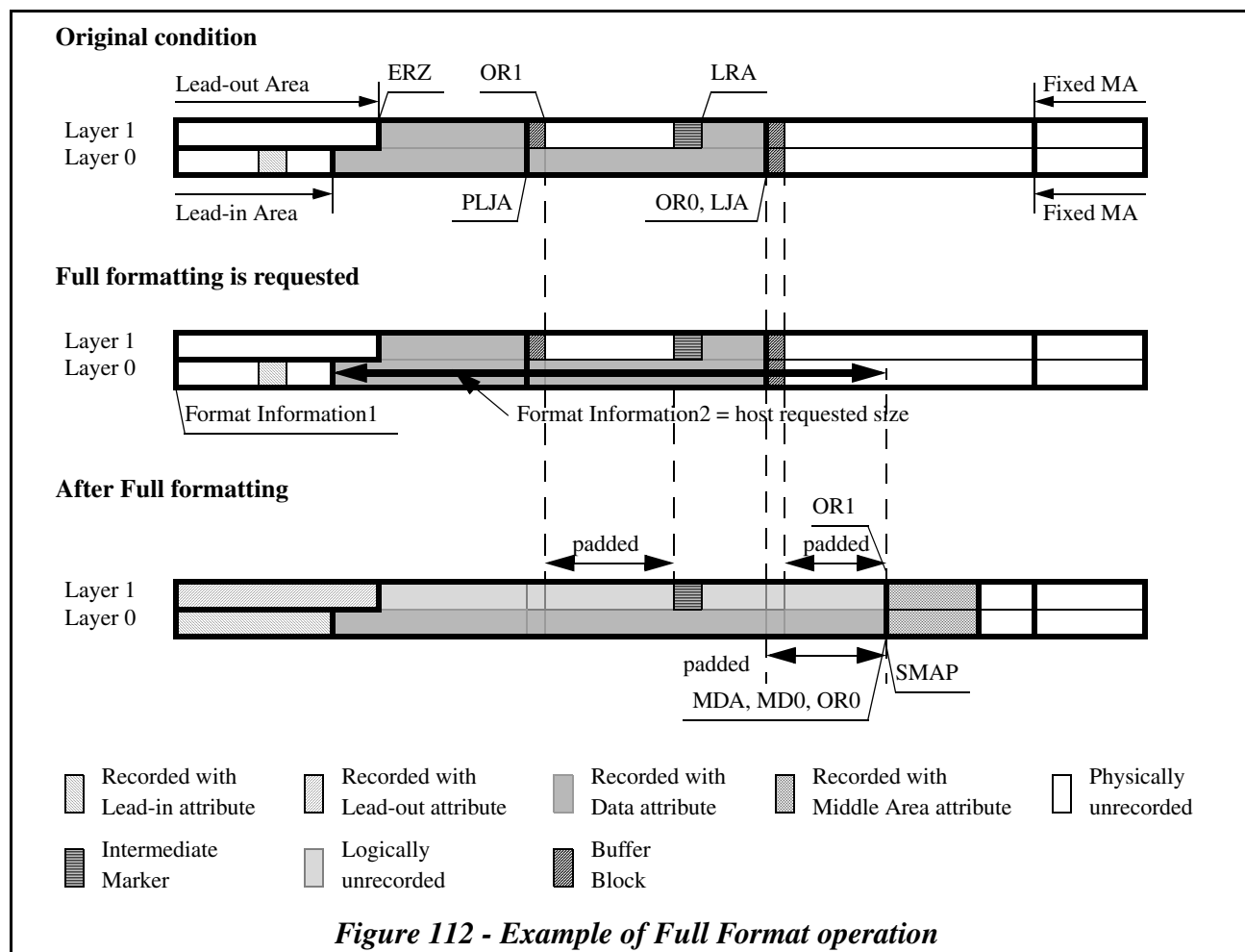
This function is applicable to any RZone conditions and any physical disc states.

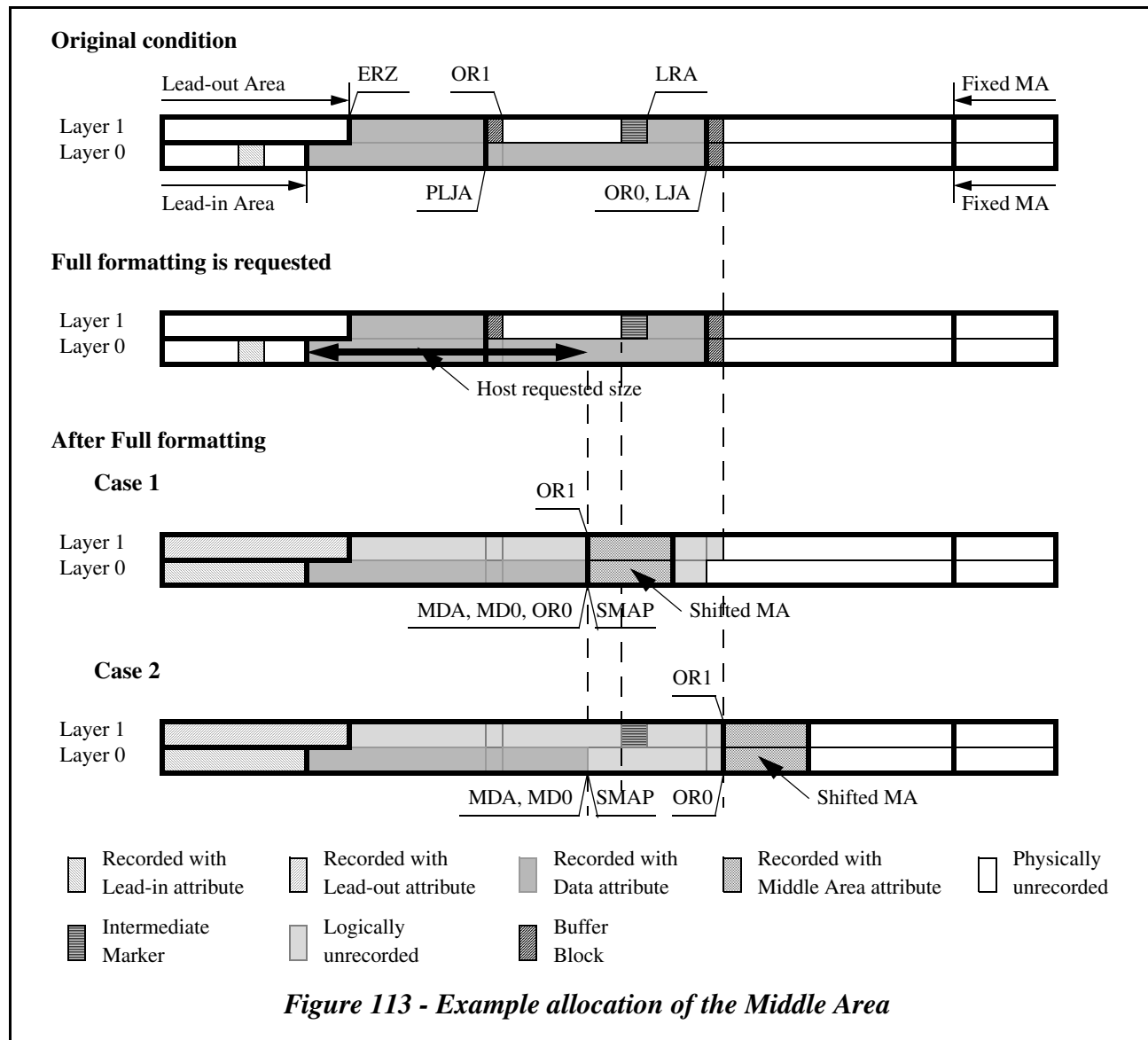
This function is used to generate an RZone in Contiguous condition and to make the physical disc state be in Complete state.

The logical unit *shall* apply Faster formatting mechanism to this function by using OR0 field and OR1 field. Before using those fields, the value *shall* be updated to the current values. All the physically unrecorded blocks included in the area to be formatted and in the corresponding area on Layer 1 *shall* be padded during the format process. Areas between Lead-in and OR0 and between Lead-out and OR1, and Intermediate Marker are not necessary to be padded. See Figure 112.

The Middle Area *shall* be recorded at or outer than the outer end of the formatted area. The location may be vary according to the implementation. See Figure 113.

When this function is started, Format Operation Code field in Format 3 RMD *shall* be set to 01h. Format Information1 field *shall* be set to 024440h when NBCA is not allocated or 02D5B0h when NBCA is allocated. Format Information2 field *shall* be set to the number of ECC blocks in Data Recordable Area to be formatted. Upon completion of this format operation, all those fields *shall* be set to zero.





4.21.8.3 CD-RW DVD-RW Full format

In case of DVD-RW DL media, Faster formatting mechanism is defined as a default formatting method because it is the most useful formatting method. But from the data security point of view, the recorded user data must be overwritten through a formatting. For such a purpose, this function is used as the full overwrite formatting.

The logical unit *shall* pad all the blocks within the area to be formatted during this format operation.

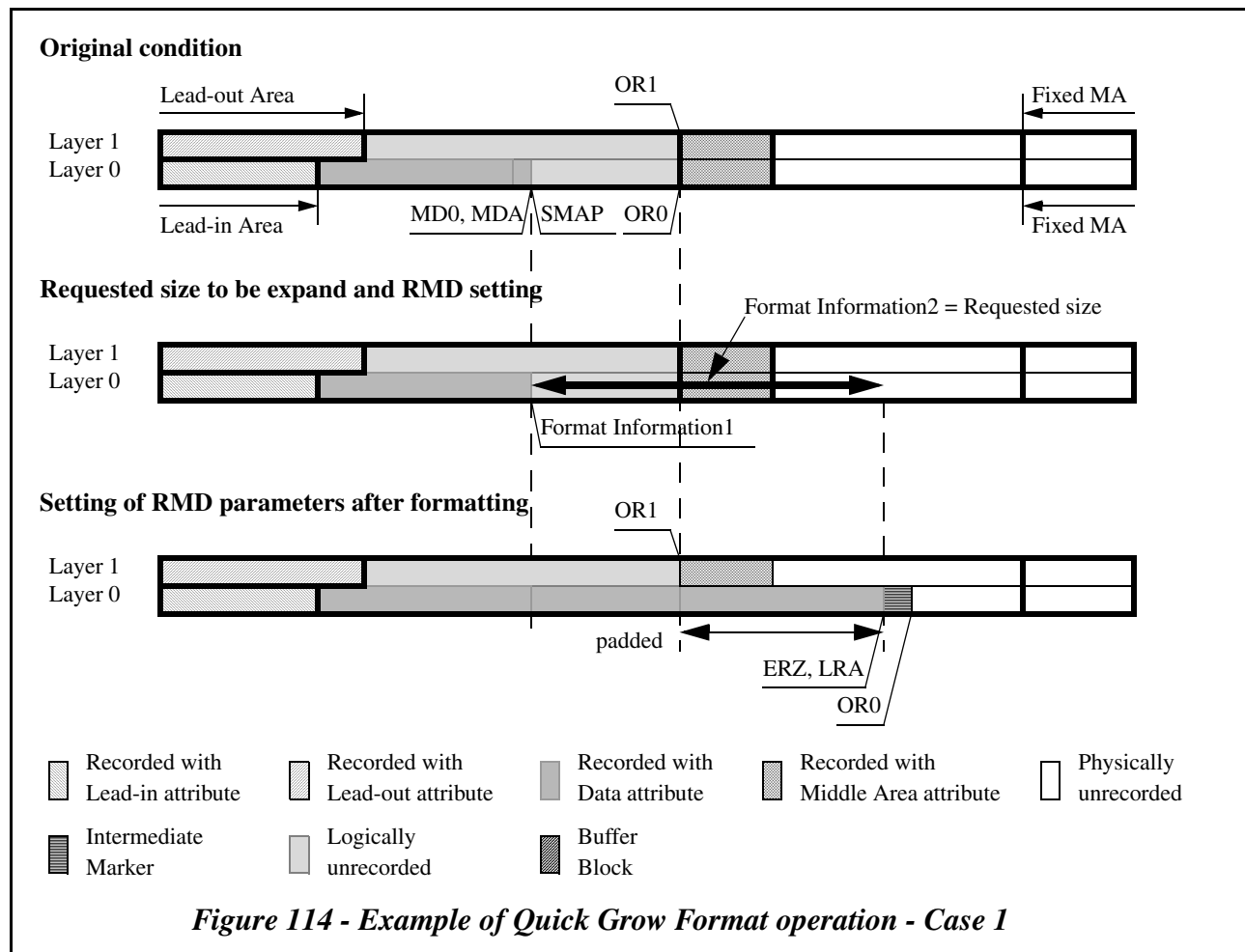
When this function is started, Format Operation Code field in Format 3 RMD *shall* be set to 01h. Format Information1 field *shall* be set to 024440h when NBCA is not allocated or 02D5B0h when NBCA is allocated. Format Information2 field *shall* be set to the number of ECC blocks in Data Recordable Area to be formatted. Upon completion of this format operation, all those fields *shall* be set to zero.

4.21.8.4 Quick Grow format

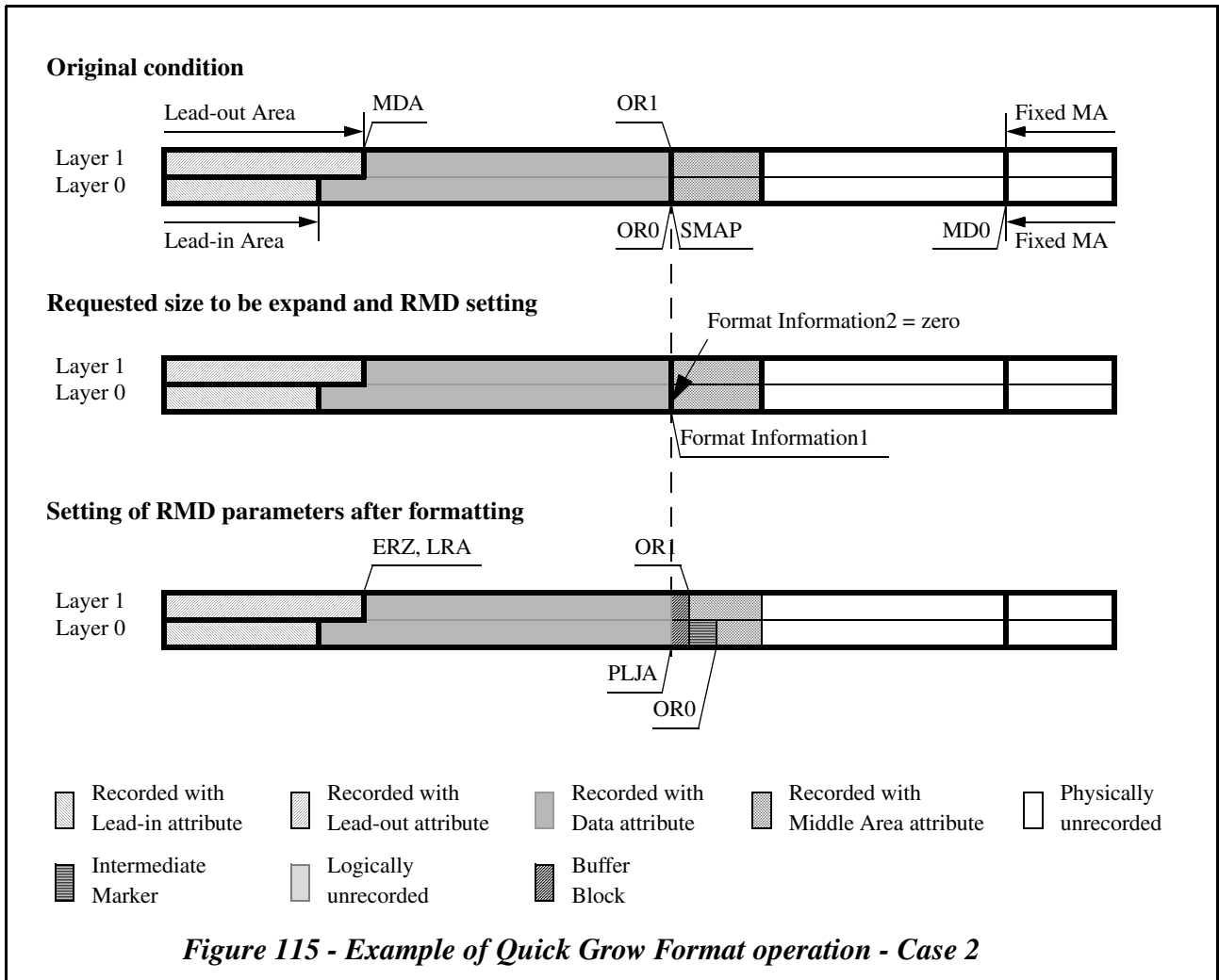
Quick Grow format is used to change the disc stated from Complete disc state to Intermediate disc state.

If the RZone is in Contiguous condition, the logically recorded area can be expanded by this format operation by padding the requested size.

If the padding operation is necessary, Format Operation Code field in Format 3 RMD *shall* be set to 04h, when the padding is started. Format Information1 field *shall* be set to MDA + 1. Format Information2 field *shall* be set to the number of ECC blocks in Data Recordable Area to be expanded. Upon completion of this format operation, all those fields *shall* be set to zero. See Figure 114.



If the RZone is in Non-contiguous condition, the logically recorded area is not allowed to be expanded. Padding is not necessary to the physically recorded blocks. The shape of the logically recorded area(s) *shall not* be changed through this operation. See Figure 115.



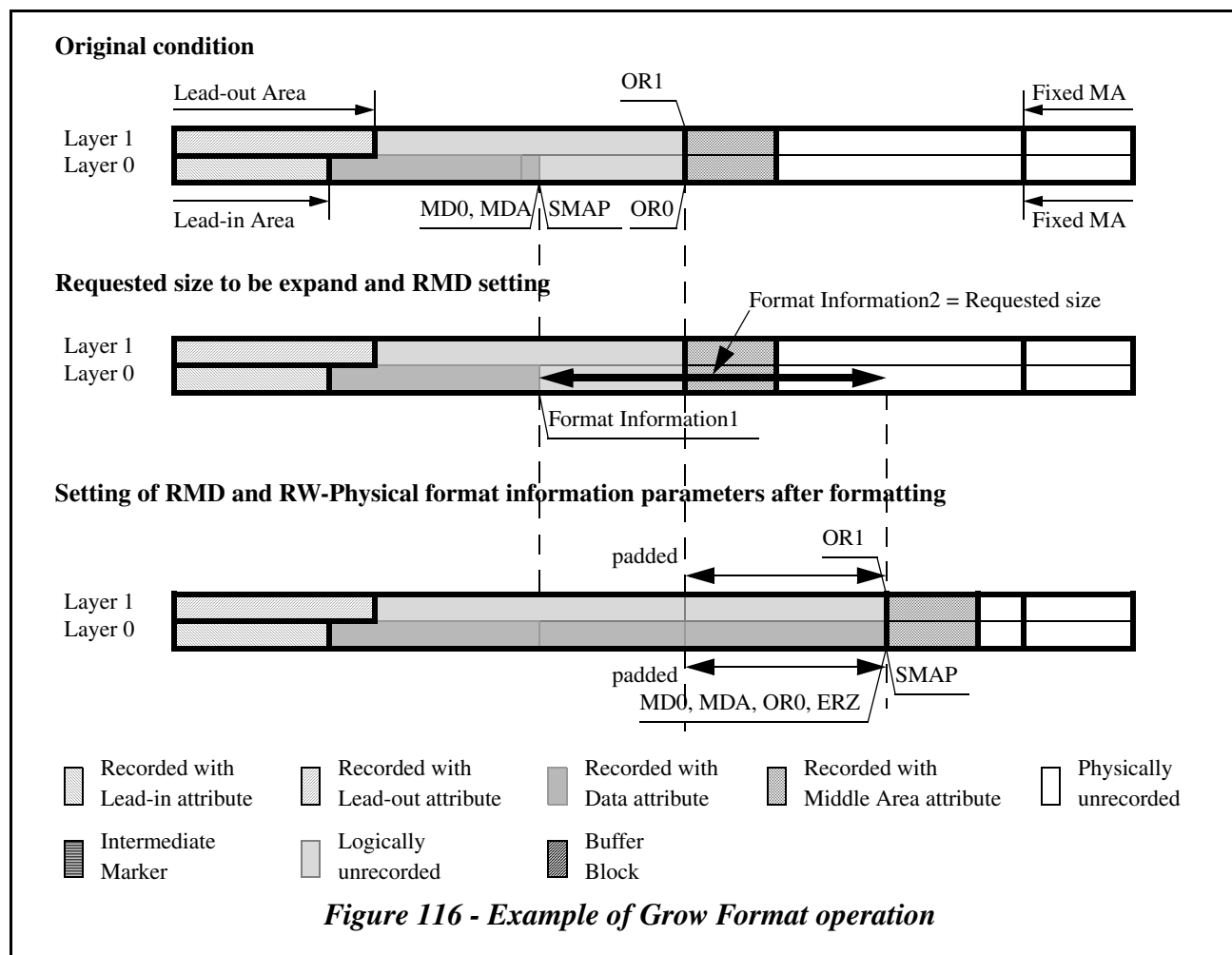
4.21.8.5 Grow format

Grow format is used to expand the logically recorded area of the disc in Complete state. The formatted disc *shall* still be in Complete state.

If the RZone is in Non-contiguous condition, this operation is not applicable.

The logically recorded area can be expanded by this format operation by padding the requested size. Padding is not necessary to the physically recorded blocks.

If the padding operation is necessary, Format Operation Code field in Format 3 RMD *shall* be set to 02h, when the padding is started. Format Information1 field *shall* be set to MDA + 1. Format Information2 field *shall* be set to the number of ECC blocks in Data Recordable Area to be expanded. Upon completion of this format operation, all those fields *shall* be set to zero.



4.21.8.6 Fast Re-format

Fast Re-format method is newly defined for DVD-RW DL media.

This function is applicable to any RZone conditions and any physical disc states.

This function is used to generate an RZone in Contiguous condition and to make the physical disc state be in Complete state. The difference from the Full format function is that the logical unit *shall* guarantee to preserve the preciously logically recorded user data with is the area to be formatted.

The logical unit *shall* apply Faster formatting mechanism to this function by using OR0 field and OR1 field. Before using those fields, the value *shall* be updated to the current values. All the physically unrecorded blocks included in the area to be formatted and in the corresponding area on Layer 1 *shall* be padded during the format process. Areas between Lead-in and OR0, between Lead-out and OR1 *shall* not be padded. If logically recorded area on Layer 1 exists outer than OR1, see Table 117, and a part of or all of the blocks in the area is included in the area to be formatted, the blocks *shall* not be padded, too. Intermediate Marker is not necessary to be padded. See Figure 112.

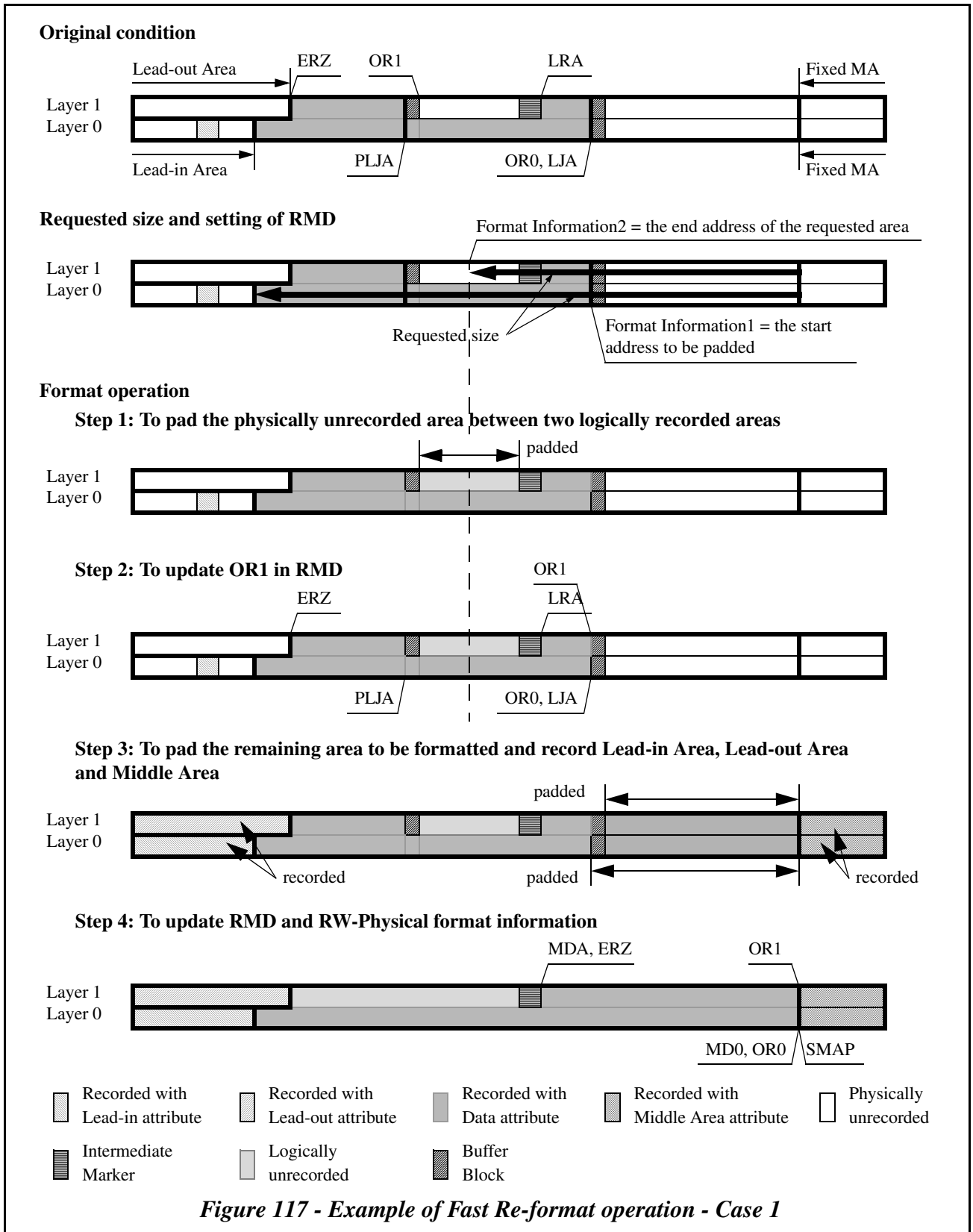
The Middle Area *shall* be recorded at or outer than the outer end of the formatted area. The location may be vary according to the implementation. See Figure 113.

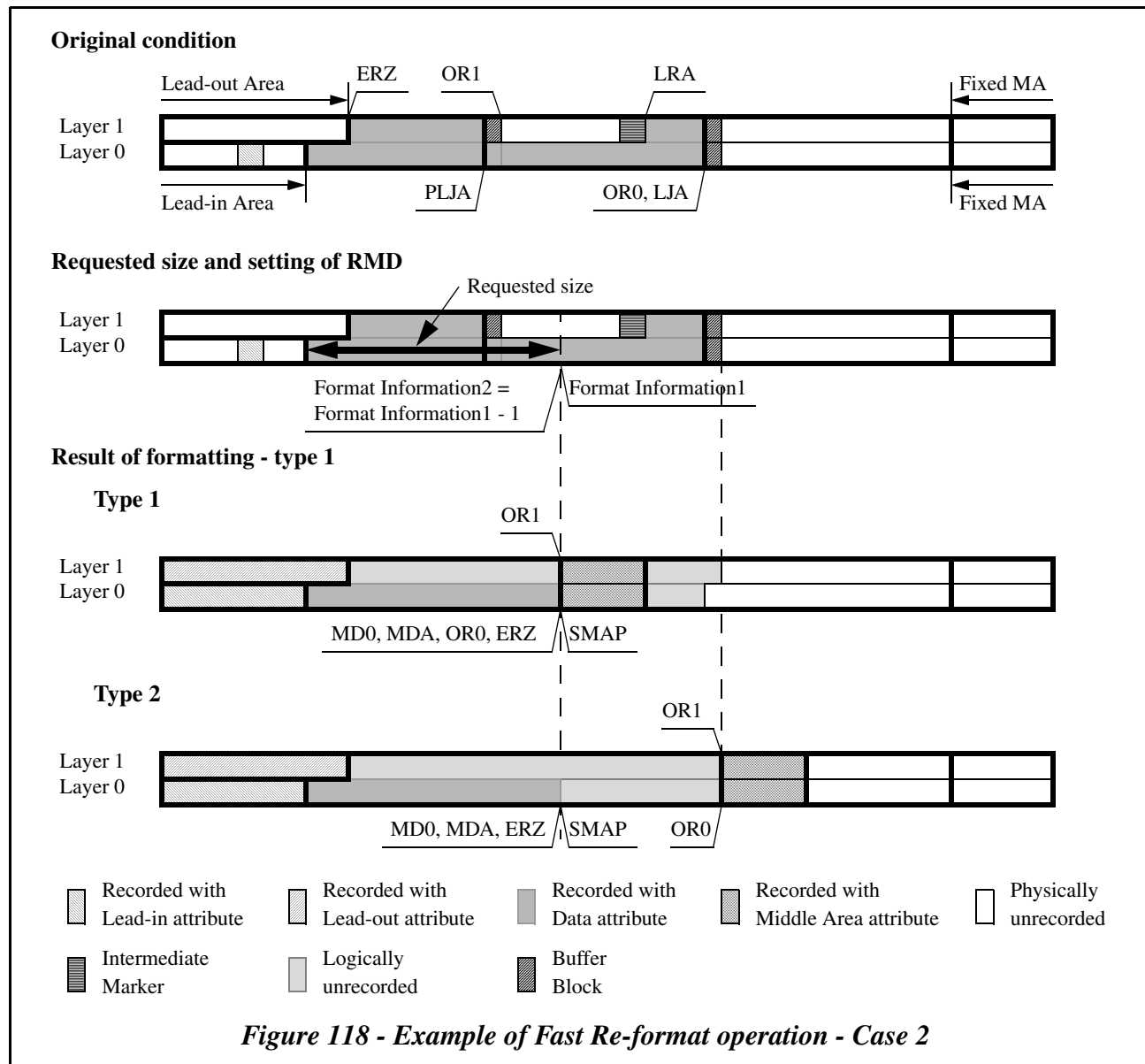
When this function is started, Format Operation Code field in Format 3 RMD *shall* be set to 07h. Format Information1 field *shall* be set to the next PSN of the end of the first logically recorded area of the disc. Format Information2 field *shall* be set to the end PSN of the area to be formatted. Upon completion of this format operation, all those fields *shall* be set to zero.

The recommended formatting procedure of the Fast Re-format is as follows;

- Step 1: To make sure the recorded OR0 field and OR1 field point the correct location. If those are not the correct location, those fields *shall* be updated.
- Step 2: To pad the area between two logically recorded areas on Layer 1, if those exist and outer one of the areas is located outer than OR1.
- Step 3: To pad from OR0 to ED0, then to pad from ED0 to OR1. To record Lead-in Area, Lead-out Area and Middle Area in this step.
- Step 4: To update the RMD and RW-Physical format information.

This is one of the procedure to achieve the stopping function for this format operation. See Section 4.21.8.7.





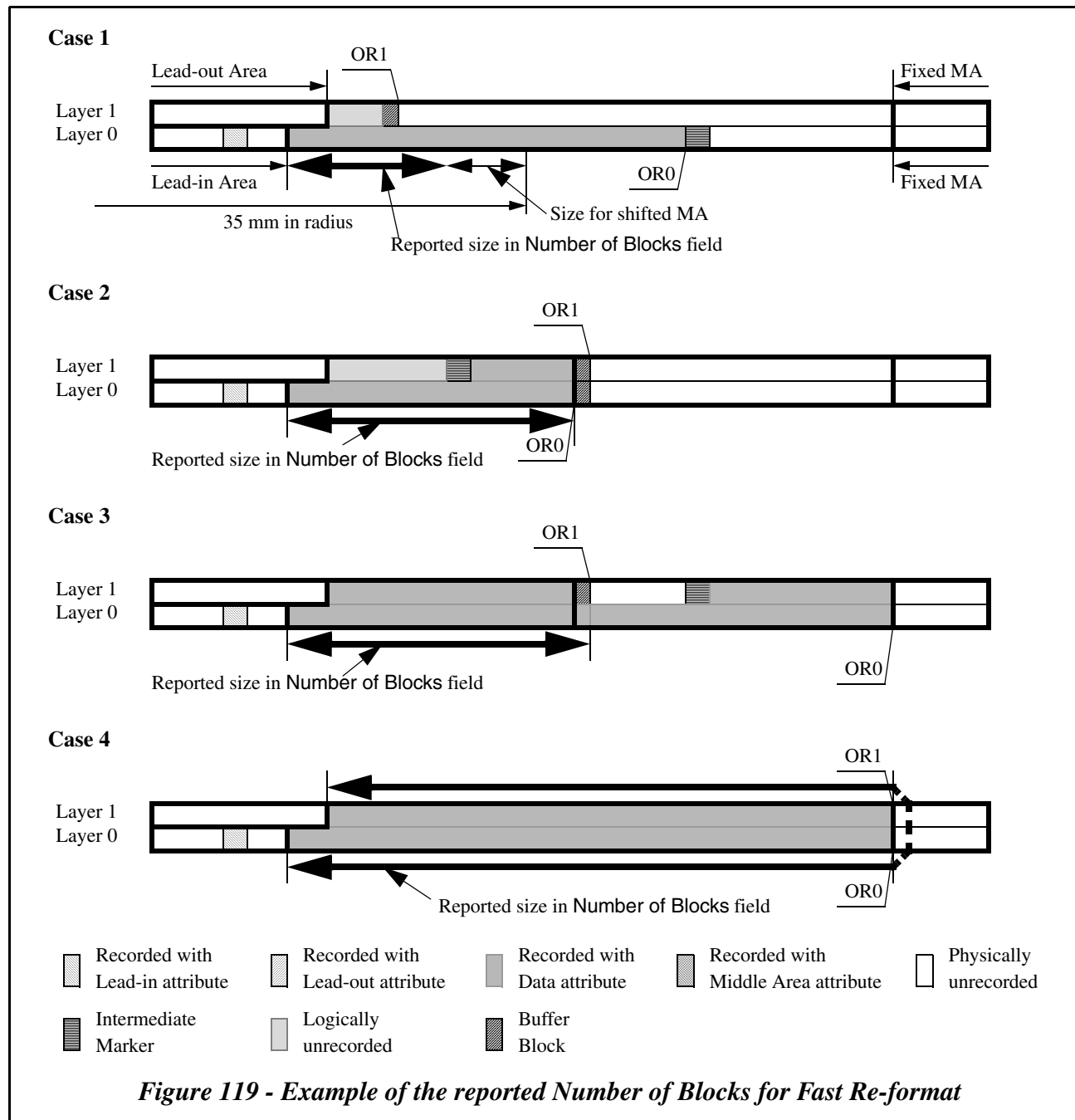
4.21.8.6.1 Reported Formattable Capacity

The Number of Blocks field of the first DVD-RW Fast Re-format Formattable Capacity Descriptor reported by READ FORMAT CAPACITIES command shows the capacity of the quickest formatting of the mounted disc. The capacity *shall* be reported according to the following formula with one exception;

$$\text{Number of Blocks} = \text{Capacity of the Max}(35\text{mm} - \text{Middle Area size}, \text{Min}(\text{OR0}, \text{OR1})).$$

When both OR0 and $\overline{\text{OR1}}$ indicate ED0, in other word, all the blocks in Data Recordable Area on both layers are physically recorded, the Number of Blocks field *shall* be set to the maximum capacity of the disc. See Figure 119.

The Number of Blocks field of the second DVD-RW Fast Re-format Formattable Capacity Descriptor reported by READ FORMAT CAPACITIES command shows the maximum capacity of the mounted disc. If all the blocks on both layers are physically recorded, Number of Blocks fields of the first Descriptor and the second Descriptor report the same value.



The host can select the Number of Blocks field value in the Format Descriptor of FORMAT UNIT command to its desired value. But it is recommended to set to the value reported by the Number of Blocks field in the first descriptor of this Format Type returned by READ FORMAT CAPACITIES command to minimize the formatting time.

4.21.8.7 Stop Format operation

The format operation of the DVD-RW DL disc may take a long time. In the case of the Blank state disc, Full Format operation takes about 1 hour in 2x-speed writing. To stop the operation, the CLOSE TRACK/SESSION command with Close Function = 000b is newly defined. The logical unit *shall* stop the format operation if the stop function is supported for the executing format operation.

If the executing format operation requires the data preservation, i.e. Grow format Quick Grow format and Fast Re-format, some post-processing, e.g. recording Intermediate Marker, updating RMD, is necessary. The disc may become Intermediate state. Disc Status field *shall* be set to 12h or 13h appropriately. Format Operation Code field, Format Information1 field and Format Information2 field *shall* be set to zero. The parameters to specify the RZone shape should be updated to reflect the finished format operation. The recorded user data outside the area to be formatted may become inaccessible. If the logical unit fails to update the post-processing, the logical unit *shall* terminate the command with the CHECK CONDITION Status. 3/31/01 FORMAT COMMAND FAILED error may be reported.

If the executing format operation does not require the data preservation, i.e. Full format, CD/RW DVD/RW Full format and Quick format, post-processing is not necessary. But in this case, the disc may be inaccessible unless the disc is formatted again.

If the logical unit cannot stop the executing format operation according to the above rules, the logical unit *shall* terminate the command with CHECK CONDITION Status, 5/24/00 INVALID FIELD IN CDB.

4.21.9 Closing on DVD-RW DL discs

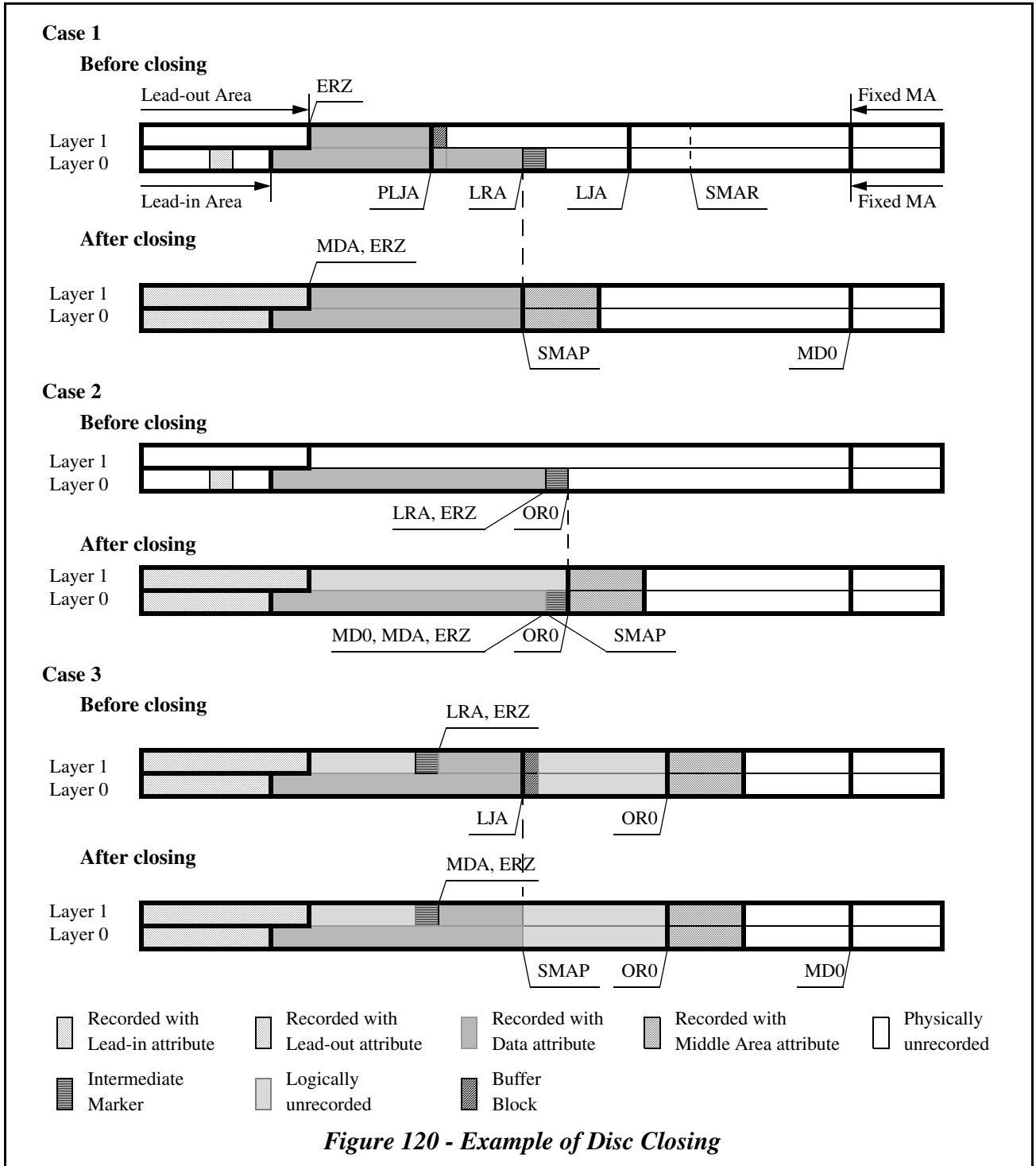
4.21.9.1 Disc closing

To change the disc state from the Intermediate state to the Complete state, CLOSE TRACK/SESSION command with Close Function = 010b is used. This operation is a kind of disc closing for DVD-R. A Lead-in Area, Lead-out Area and Middle Area *shall* be recorded if they are not recorded yet. See Figure 120.

By closing the disc, ERZ field in RMD *shall* not be changed and *shall* be copied to SMAP field in RW-Physical format information. If ERZ does not reach to EDA, the area between those is logically unrecorded area. See case 3 in Figure 120.

All the Layer jump recording related fields, i.e. LJA field, PLJA field and JI field, *shall* be reset to zero. See case 1 in Figure 120. If no layer jump has occurred, the RZone become Contiguous condition. See case 2 in Figure 120.

It is possible to close the disc in non time-consuming way. For example, if all areas of a disc are already recorded and the disc is Quick formatted with user data size = 0, the NWA appears at LBA 0. When a host writes some amount of data on this medium from the NWA and then the host requests to close the medium, the logical unit needs not write an actual Shifted Middle Area just after the written host data. In this case, the logical unit may check the existence of Middle Area at OR0 by referring the bit 4 of the Pre-recorded/Embossed information code in the Format 3 RMD Field0. If there is a Middle Area at OR0 and the OR0 is located outer than the area where the Shifted Middle Area is to be located, new Middle Area inner than the recorded Middle Area *shall* not be recorded. See case 3 in Figure 120. If there is no Middle Area at OR0 and the OR0 is located outer than the area where the Shifted Middle Area is to be located, then Middle Area may be recorded from the OR0 + 1. In both cases, the logical unit *shall* store the original Shifted Middle Area start address into the SMAR field of Format 3 RMD Field0 and the SMAP field of Table 40 - DVD-RW DL Ver. 2.0 unique part of RW-Physical format information on page 106.



4.21.9.2 LJB closing

LJB closing is used to reset the set LJA and/or JI fields. The CLOSE TRACK/SESSION command with Close Function = 001b is newly defined for this purpose.

If the RZone is in Contiguous condition and LRA is on L0, the logical unit *shall* pad all the physically unrecorded blocks exist between $\overline{\text{LRA}}$ and EDA, and *shall* keep them logically unrecorded. If the RZone is in Contiguous condition and LRA is on L1, the logical unit *shall* pad all the physically unrecorded blocks exist between LRA and EDA, and *shall* keep them logically unrecorded. LRA, ERZ, MD0 and MDA *shall* never be changed.

If the RZone is in Non-contiguous condition but LRA is inner than $\overline{\text{EDA}}$, the logical unit *shall* terminate the command with CHECK CONDITION Status, 5/24/00 INVALID FIELD IN CDB.

If the RZone is in Non-contiguous condition, LRA is on L0 and is outer than or equal to $\overline{\text{EDA}}$, the logical unit *shall* make all the blocks between Lead-in Area and LRA, and between $\overline{\text{LRA}}$ and Lead-out Area be logically recorded. If physically unrecorded blocks exists in that regions, the logical unit *shall* pad all of that blocks. LRA field value *shall* be copied to PLJA. LRA, ERZ and MDA fields *shall* point the location of EDA, LJA and JI fields *shall* be set to zero. NWA *shall* point the location pointed by PLJA field + 17 if PLJA is not zero, otherwise, NWA is not valid.

If the RZone is in Non-contiguous condition and LRA is on L1, the logical unit *shall* make all the blocks between Lead-in Area and LJA (if LJA is zero, then ED0 instead), and between $\overline{\text{LJA}}$ or $\overline{\text{ED0}}$ and Lead-out Area be logically recorded. If physically unrecorded blocks exists in that regions, the logical unit *shall* pad all of that blocks. LJA field value *shall* be copied to PLJA. LRA, ERZ and MDA fields *shall* point the location of EDA, LJA and JI fields *shall* be set to zero. NWA *shall* point the location pointed by PLJA field + 17 if PLJA is not zero, otherwise, NWA is not valid.

4.21.9.3 Stop Close operation

The disc close and LJB closing operation of the DVD-RW DL disc may take long time. In the case that the Layer 0 is fully logically recorded and Layer 1 is fully physically unrecorded, the Close operation takes about 30 minutes in 2x-speed writing. To stop the operation, the CLOSE TRACK/SESSION command with Close Function = 000b is newly defined. The logical unit *shall* stop the Close operation if the stop function is supported for the executing Close operation. When the Close operation is stopped, RMD *shall* be updated.

When the Close operation is stopped, the physical disc state may be in Intermediate state, all Format Operation Code field, Format Information1 field, and Format Information2 field in Format 3 RMD *shall* be reset to 00h, and all the logically recorded data *shall* still be readable. The Intermediate Marker *shall* be re-recorded at the original location if the physical disc state is in Intermediate state and the Intermediate Marker has been overwritten during the Closing operation. In this case, all the fields in Format 3 RMD to specify the RZone structure, i.e. SRZ field, ERZ field, LJA field, LRA field and PLJA field *shall* be preserved.

4.22 Recording for DVD-Download disc

The concepts of recording media with CSS encryption are designed to be identical to the methods used by the drive and host for non-CSS media, with a minimal set of commands inserted to modify the encryption status of the sectors which are to be recorded.

4.22.1 The basics for DVD Download Disc for CSS Managed Recording

DVD-Download disc is developed to provide CSS Managed Recording with the same capacity as DVD-ROM/-R Single Layer disc. The major characteristics of DVD-Download disc are as follows.

- The physical structure of DVD-Download disc is similar to the DVD-R SL media.
- Lead-in area except Buffer Zone 2 is pre-recorded. See Figure 15 - *Data structure of Lead-in Area* on page 94. The first sector of the Buffer zone 2 is Linking sector.
- There is no RMA and no R Physical Format Information zone.

Table 140 shows the comparison chart of some parameters between different versions of DVD-Download disc format and DVD-ROM/-R SL media.

Table 140 - Comparison of DVD media format

DVD Version Characteristics	DVD-Download	DVD-R for General SL	DVD-ROM SL
Capacity per side (120 mm)	4,7 gbytes ^a	4,7 gbytes ^a	max. 4,7 gbytes ^a
Channel bit length (μm)	0,133	0,133	0,133
Track pitch (μm)	0,74	0,74	0,74
Number of Layers per side	1	1	1
Data Type bit	always 0	0/1 ^b	always 0
Lead-in area	pre-recorded till Buffer Zone 2	Control Data zone is pre- recorded	embossed
R Physical Information zone	not defined	defined	-
RMA	not defined	defined	-
Standard recording speed	2× to 8× ^c	1× to 16× ^c	-

a. gbytes = 1000 × 1000 × 1000 bytes

b. Refer to Table 14 - *Data Type bit definition* on page 93

c. Specified by Optional Specification.

4.22.2 Associated Profile and Feature

When a recordable DVD-Download disc is installed in a logical unit, the logical unit reports the DVD-Download disc recording Profile (0018h) in the Current Profile field of Table 339 - *Feature Header* on page 560.

4.22.3 Recording model

Disc-at-once recording of DVD Download Disc for CSS Managed Recording media follows the same restrictions and basic write methods as Disc-at-once recording of previous DVD-R SL media, including the 35mm minimum recorded

radius requirements. Sample sequence of disc-at-once recording for DVD Download Disc for CSS Managed Recording is as follows;

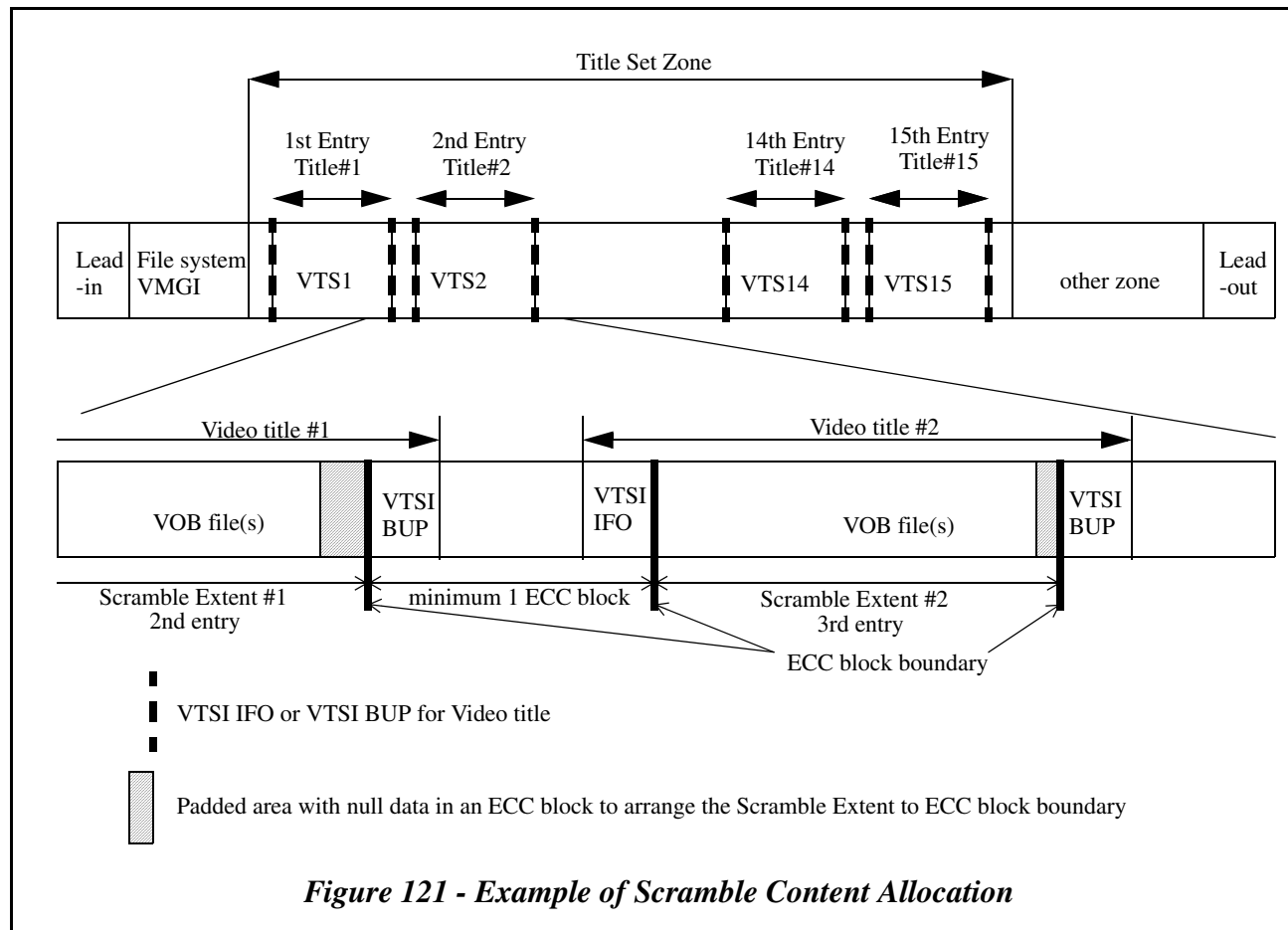
1. Host may check for presence of DVD-Download disc recording Profile (0018h) and DVD CSS Managed recording Feature support via GET CONFIGURATION command.
2. Host sets the Write Type field in the Write Parameters mode page to disc-at-once.
3. Host authenticates and obtains BUS KEY via normal CSS methods.
4. Host reads Disc Key by normal CSS methods.
5. Host authenticates and obtains BUS KEY via normal CSS methods.
6. Host sends the Scramble Content Allocation information (Title Set Zone information and array of **Start LBA / LBA Count / CSS scrambled Title Key** data by using the SEND DISC STRUCTURE command with **Format Code = 17h**). The Scramble Content Allocation information *shall* be protected by the BUS KEY.
7. Host specifies user data size by using the RESERVE TRACK command.
8. Host issues WRITE (10) command starting from logical sector number 0.
The logical unit shall perform Optimum Power Calibration (OPC).
The logical unit shall start writing from the Lead-in through Data Recordable Area at this time.
9. Host issues WRITE (10) for remaining user sectors
If any sectors in WRITE (10) command exist in the LBA Extents with a Title Key the drive shall apply appropriate CPR_MAI and title key settings for the sectors by checking user data.
10. The logical unit shall detect the final reserved user data has been recorded and begin writing the lead-out data immediately without requiring further commands from the host.
 - The logical unit shall accept and immediately complete any of the following commands if the IMMED bit is set to one during the writing of the Lead-out:
 - SYNCHRONIZE_CACHE
 - CLOSE_TRACK (Track Number == 1)
 - CLOSE_SESSION (Session Number == 1)
 - If the host sends these commands at this time, the logical unit shall continue the process of writing the lead-out data without interruption.

4.22.4 CPR_MAI handling

Audiovisual data to be written on the DVD-Download disc is usually scrambled by CSS. Host sends scrambled audiovisual data that is formatted into Pack(s) of DVD Video format. See *Section 4.14, "DVD Video format information for CSS Managed Recording"* on page 111. Some data in Packs are scrambled. Some data in Packs are not scrambled. Those Packs are formatted into VOB file(s). Host specifies the Scramble Content Allocation information that contains the Title Set Zone information and the set of scrambled VOB file data location (**Start LBA** field, **LBA Count** field) and the CSS scrambled Title Key (**CSS scrambled Title Key** field) to be written in sector header to logical unit by SEND DISC STRUCTURE command with **Media Type = 0000b**, **Format Code = 17h**. Only one Title Set Zone can exist on a disc. All the Scramble Extents *shall* be allocated within the specified Title Set Zone without overlap.

The first 16-byte of the Scramble Content Allocation information specifies Title Set Zone information. One or more Scramble Extent information entry may follow the Title Set Zone information. The logical unit *shall* accept minimum 15 locations data of the Scramble Extent information. The Scramble Content Allocation information (Title Set Zone and Scramble Extent) *shall* be arranged to ECC boundary. Minimum one ECC block *shall* be located between two Scramble Extents. See Figure 121.

Only one SEND DISC STRUCTURE command with **Format Code = 17h** is available before start of a Disc-at-Once recording. The Scramble Content Allocation information sent by a SEND DISC STRUCTURE command with **Format Code = 17h** will be replaced by the next SEND DISC STRUCTURE command with **Format Code = 17h**.



The logical unit *shall* write the sector with appropriate values of CPM bit, CGMS field and bytes for Title Key in sector header by referring the Scramble Content Allocation information and CP_SEC bit by referring the PES_scrambling_control field in the user data. Table 141 explains the sector header value setting. See Section 4.14.2, "Scrambled data indicators" on page 112 about field descriptions.

Table 141 - Sector header value setting

Field in sector header	Outside of Title Set Zone	Inside of Title Set Zone		
		Outside of Scramble Extent	Inside of Scramble Extent	
			PES_scrambling_control = 00b	PES_scrambling_control = 01b
CPM	0b	1b		
CP_SEC	0b	0b	0b	1b
CGMS	00b	11b		
Title Key	00 00 00 00 00h	00 00 00 00 00h	Specified value	Specified value

5.0 HD DVD model

The HD DVD model is the description for the HD DVD media (HD DVD-ROM/-R/-RW/-RAM). See 2.2.80, "*HD DVD Standard*" on page 62.

The HD DVD has many advantages over the existing CD and DVD technology. HD DVD Format is based on the current DVD Format.

- HD DVD-ROM is based on DVD-ROM.
- HD DVD-R is based on DVD-R.
- HD DVD-RW is based on DVD-RW
- HD DVD-RAM is based on DVD-RAM.

5.1 HD DVD media description

- HD DVD media can contain information on one side (Single Sided) or on both sides (Double Sided).
- HD DVD-ROM/-R/-RW disc has two types of layer structure: Single Layer (SL) and Dual Layer (DL).
- Each Layer on either side contains a spiral track. This track contains a Lead-in, Data Area, and a Middle Area or a Lead-out. Layer on HD DVD-RAM contains a Double spiral track.
- HD DVD-ROM DL discs have two types of track path: Parallel Track Path and Opposite Track Path. HD DVD-R DL and HD DVD-RW DL discs have only Opposite Track Path.
- One ECC block, having 75 712 bytes, consists of 32 sectors.
- Addressing from the host is LBA (Logical Block Address) only.
- When reading from LBA space, only user data is sent to the host after error correction from the logical unit.
- Some data on HD DVD media is used only inside of the HD DVD logical unit and is not transferred to the host computer. This is due in part because the Physical Addresses (PSN) that the HD DVD uses are not allowed across the Interface.
- The host Read & Write unit (User Data) is 2 Kilobytes (2 048 Bytes).

5.1.1 HD DVD specifications

Table 142 specifies some HD DVD parameters.

Table 142 - General Parameters of HD DVD Discs

	Capacity (120 mm disc) [Gbytes]	Capacity (80 mm disc) [Gbytes]	Wavelength for read [nm]	Wavelength for write [nm]	Data Bit Length [μm]	Channel bit length [μm]	Min Pit/Mark length [μm]	Max Pit/Mark length [μm]	Track Pitch [μm]	User data per sector [bytes]	Error Correction Code	ECC Constraint Length	correctable burst error length [nm]	scan velocity (Ref.) [m/s]	channel bit rate [Mbps]	user data bit rate [Mbps]			
HD DVD-ROM SL	15	4,7	405	N/A	(A) ^a	(A)	(A)	(A)	(A)	2 048	RS (208,192,17) \times RS (182,172,11)	32 Physical sectors	7,1	6,61	(A)	(A)			
HD DVD-ROM DL	30	9,4			0,306	0,204	0,408	2,652	0,68										
HD DVD-R SL	15	4,7			(B) ^b	(B)	(B)	(B)	(B)										
HD DVD-R DL	30	9,0		405	0,153	0,102	0,204	1,326	0,40				(A)	(A)	(A)	(A)	(A)	(A)	(A)
HD DVD-RW SL	15	4,7			0,306	0,204	0,408	2,652	(A)				0,68	(B)	(B)	(B)	(B)	(B)	(B)
HD DVD-RW DL	30	9,0			0,130	0,087	0,173	1,126	(B)				0,34	(B)	(B)	(B)	(B)	(B)	(B)
HD DVD-RAM SL	20	6,1			~	~	~	~					6,0	~	6,03				

a. (A): the System Lead-in Area, and the System Lead-out Area in Opposite Track Path (OTP) mode of DL discs.

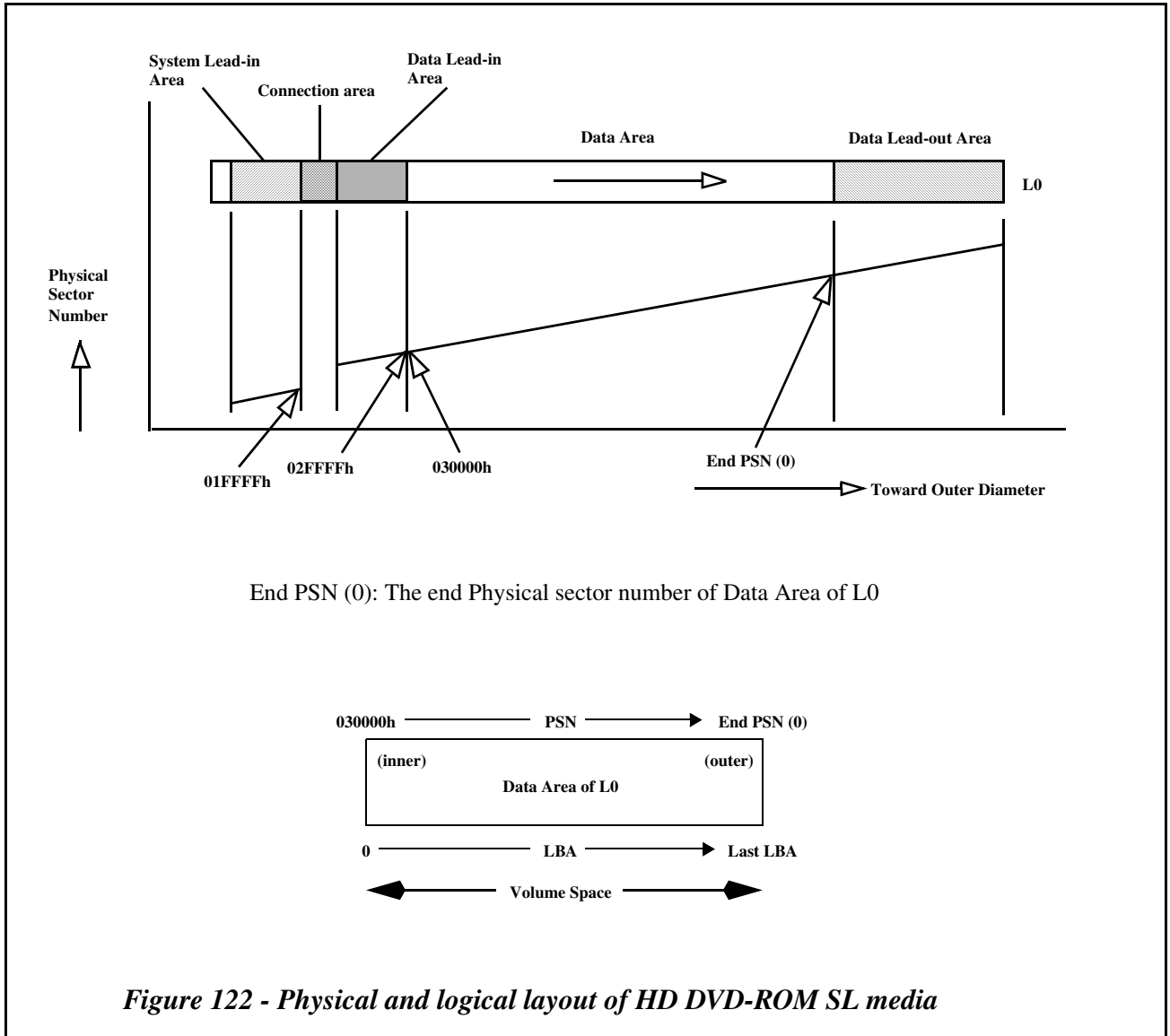
b. (B): the Data Lead-in Area, Data Area, Data Lead-out Area, and Middle Area in Opposite Track Path (OTP) mode of DL discs.

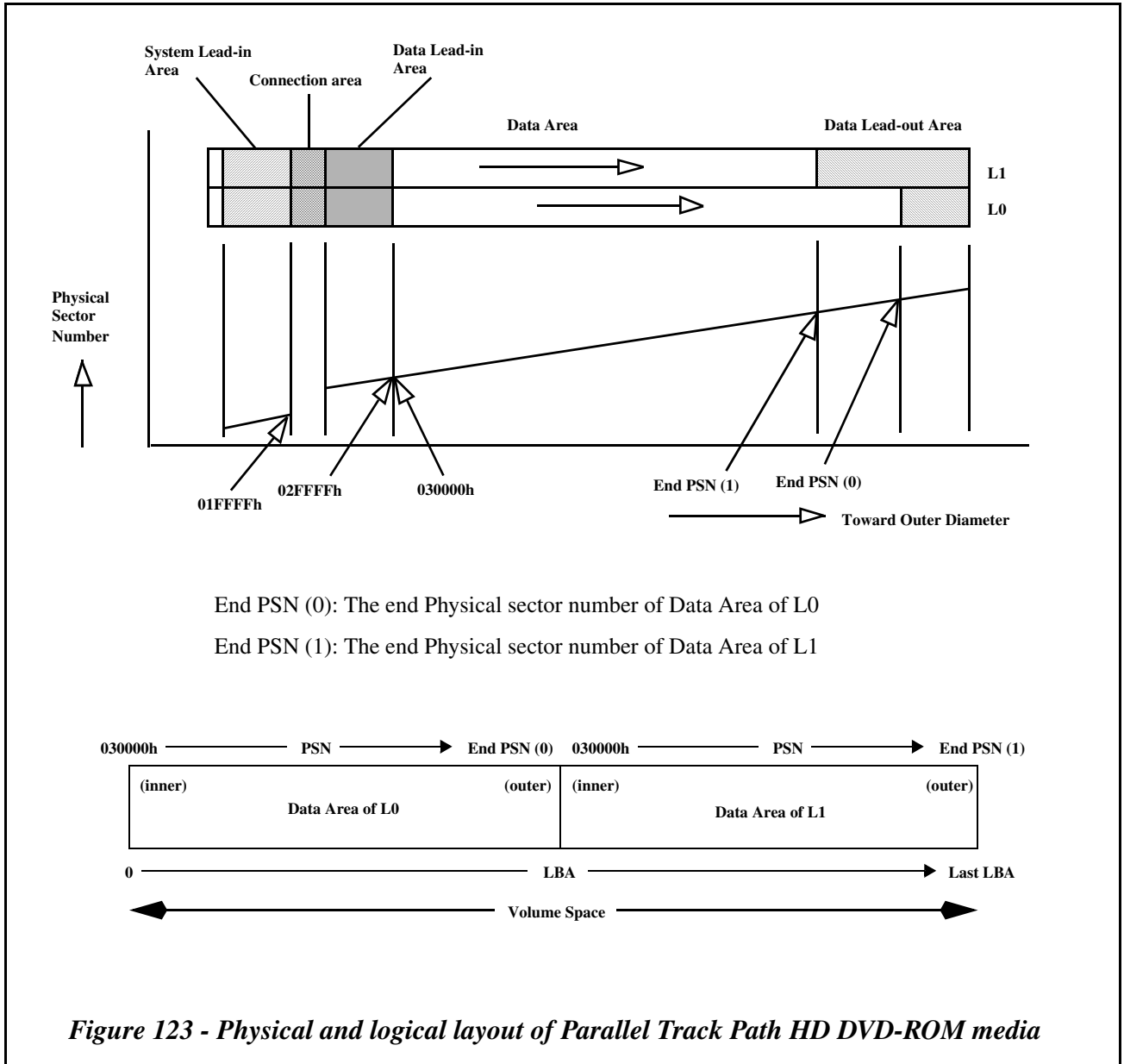
5.2 Track structure

There are two types of track path for HD DVD-ROM DL discs, either parallel or opposite. When the path is parallel each track has its own Lead-in and Lead-out.

There are two addresses used in the HD DVD system, the Block address contained in the sector headers (Physical Sector Number), and the address used to reference the blocks from the host system (LBA). The address used from the host starts at 0 and progresses up through the end of the recorded information on the disc. LBA 0 corresponds with the sector address of 030000h on HD DVD-ROM media. Only Data Area is generally addressable using an LBA.

Figure 122 through Figure 130 show examples of LBA to Physical Sector Number translations for HD DVD media.





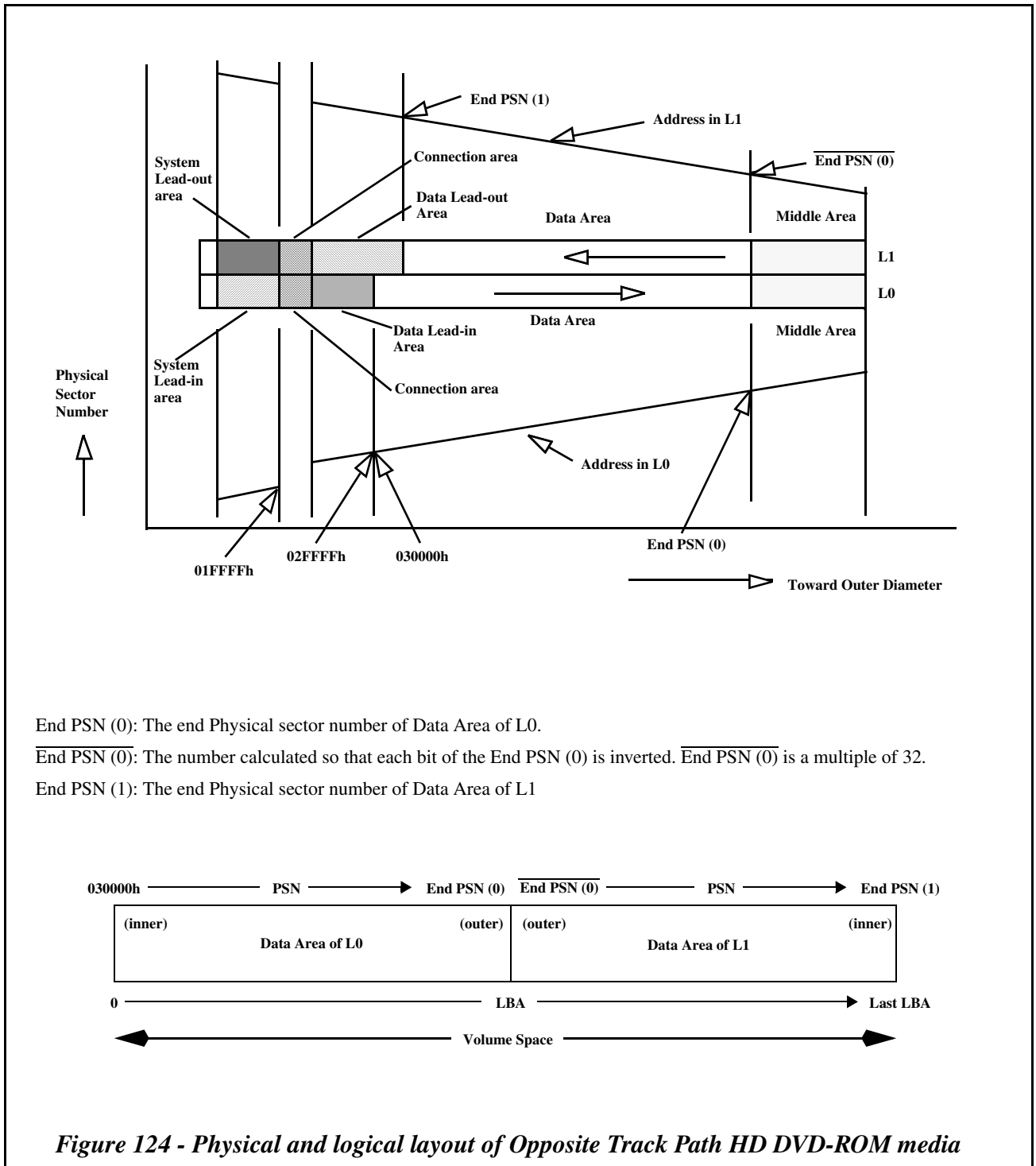
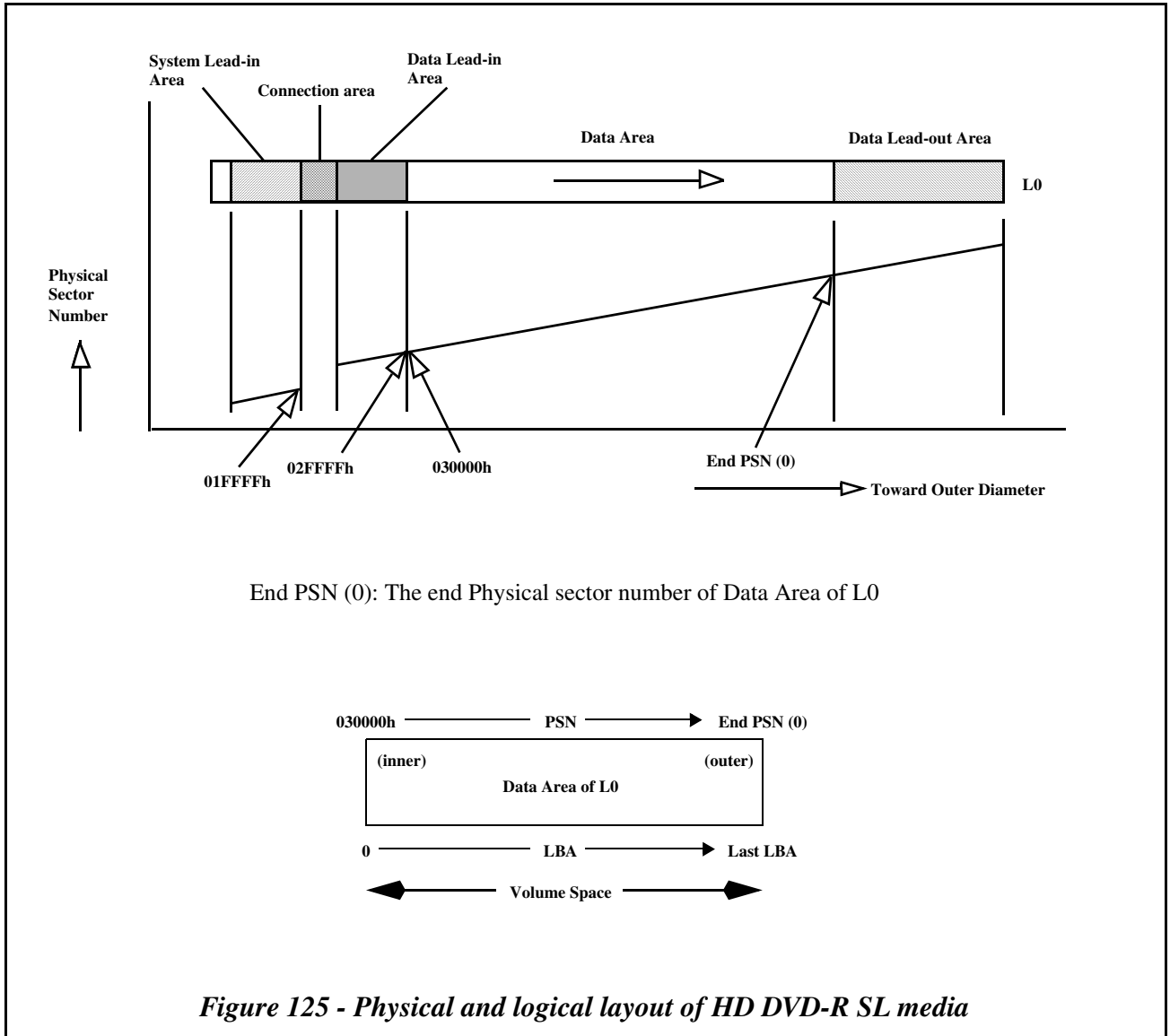
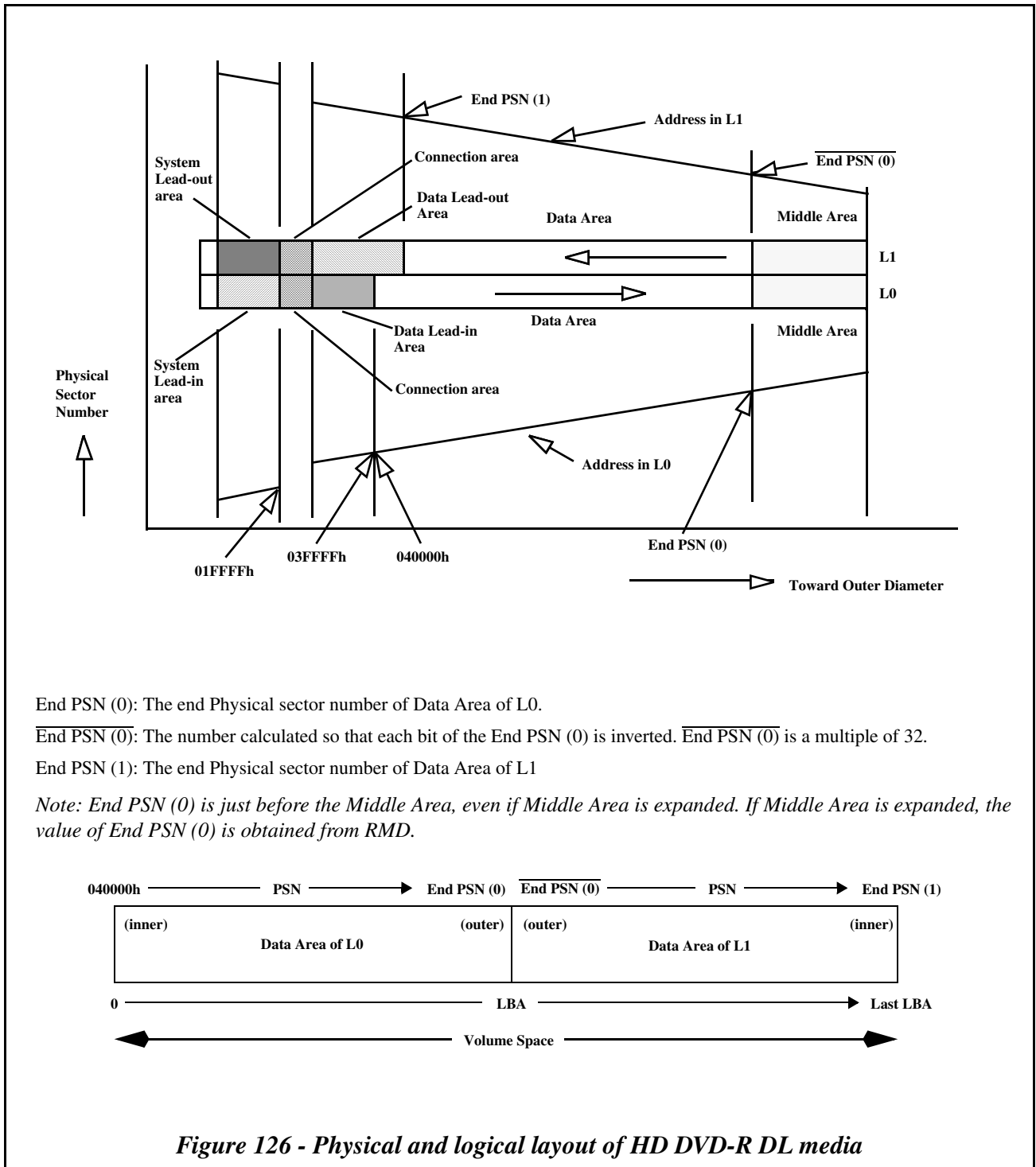
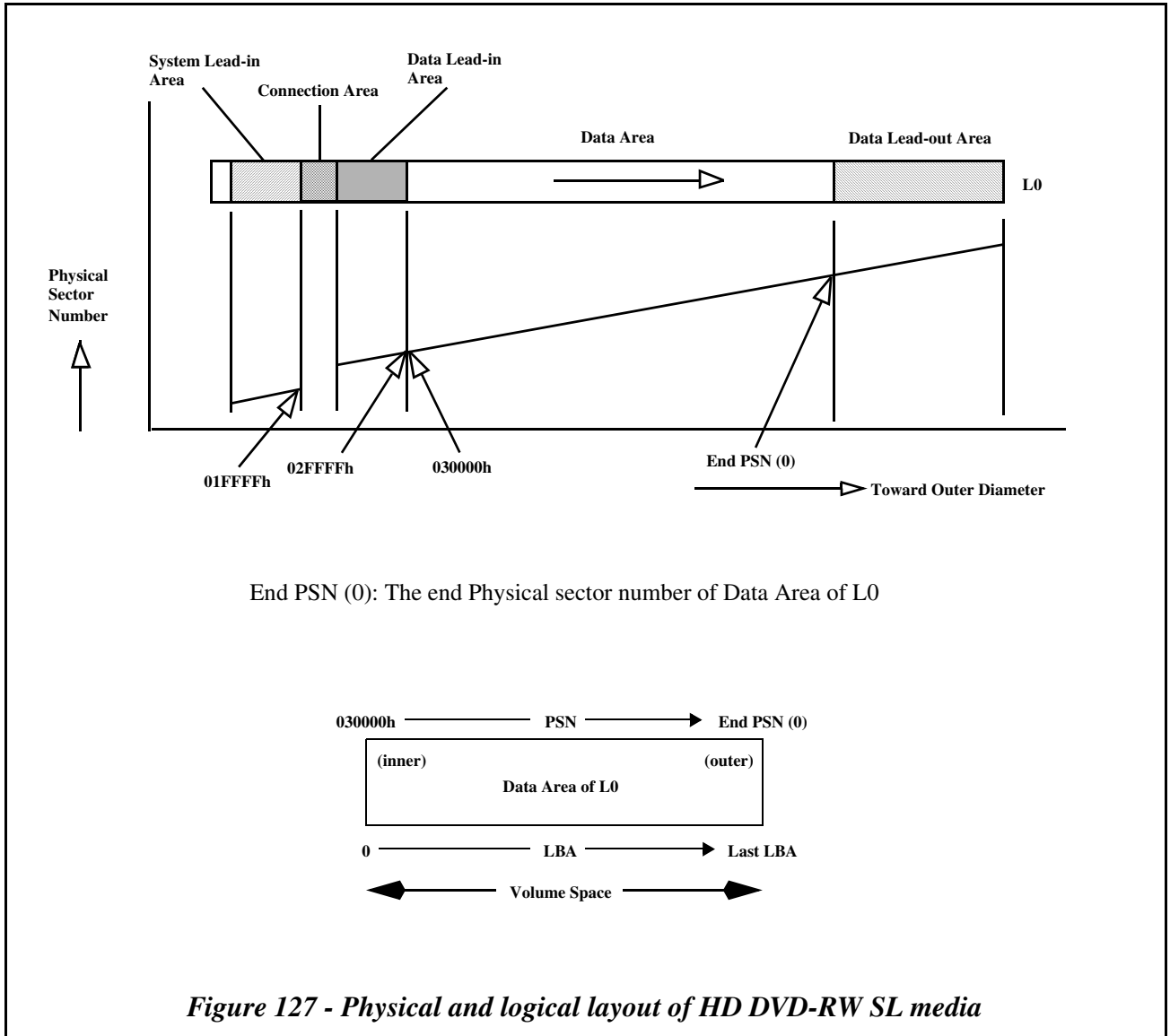
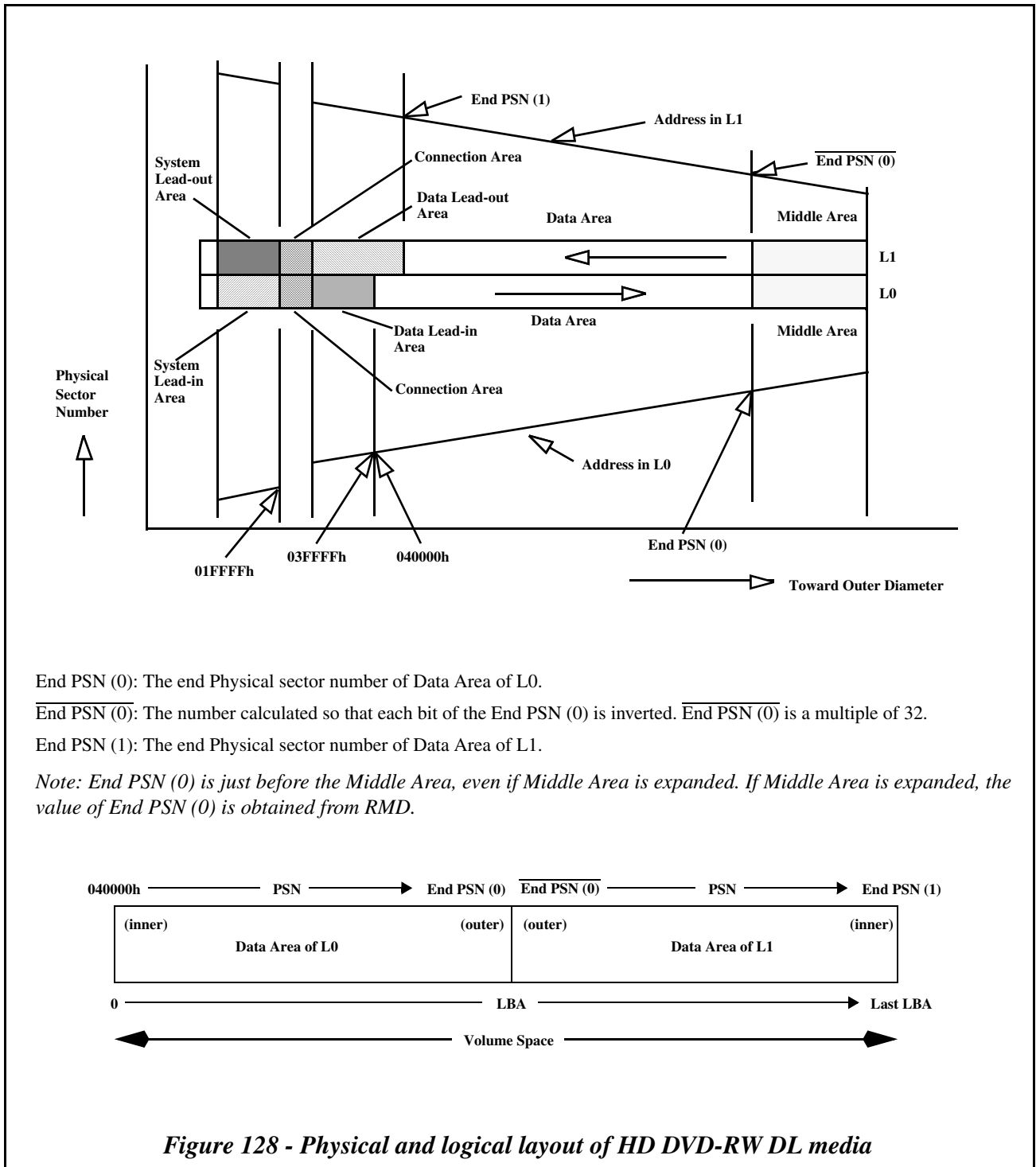


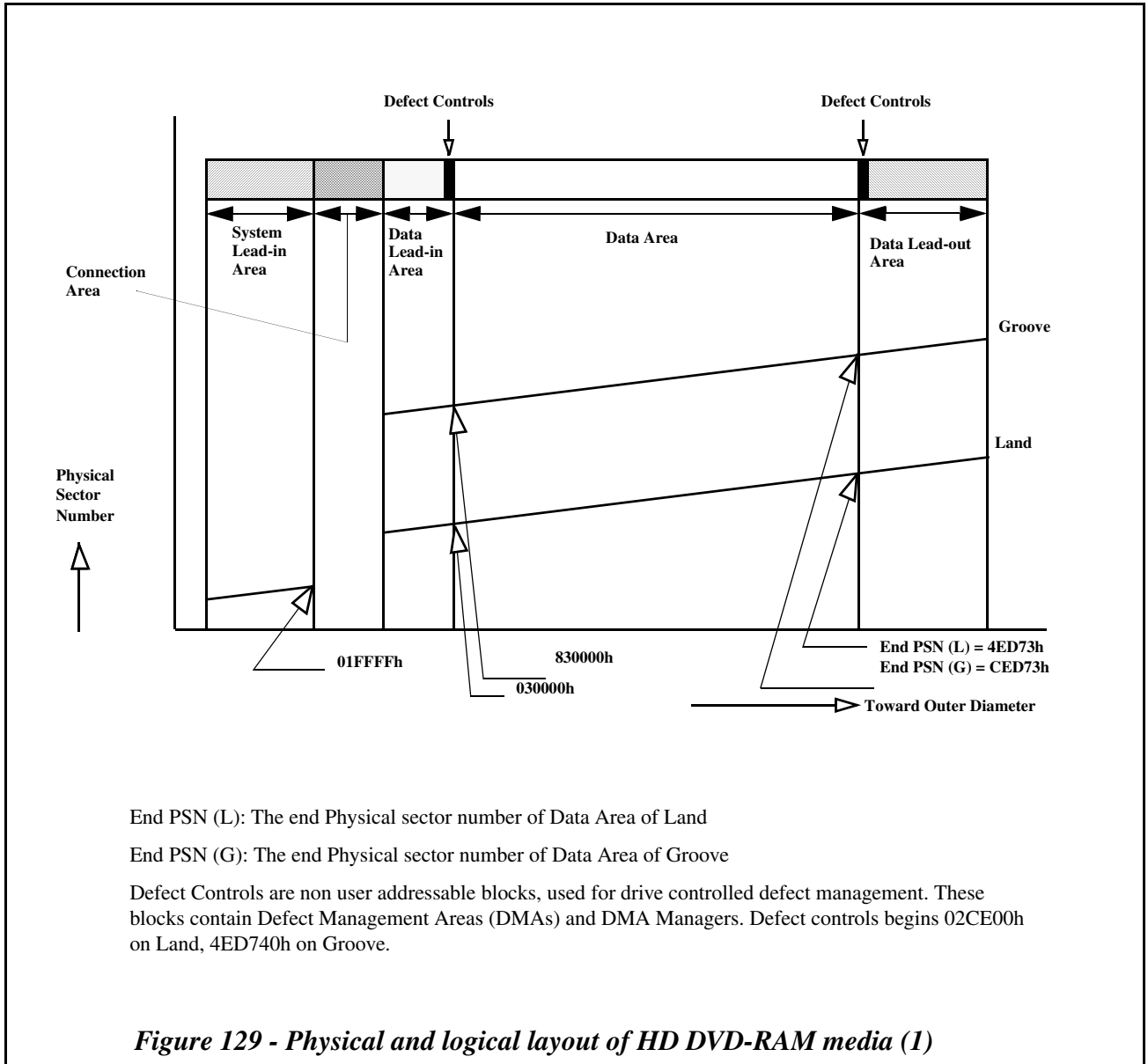
Figure 124 - Physical and logical layout of Opposite Track Path HD DVD-ROM media

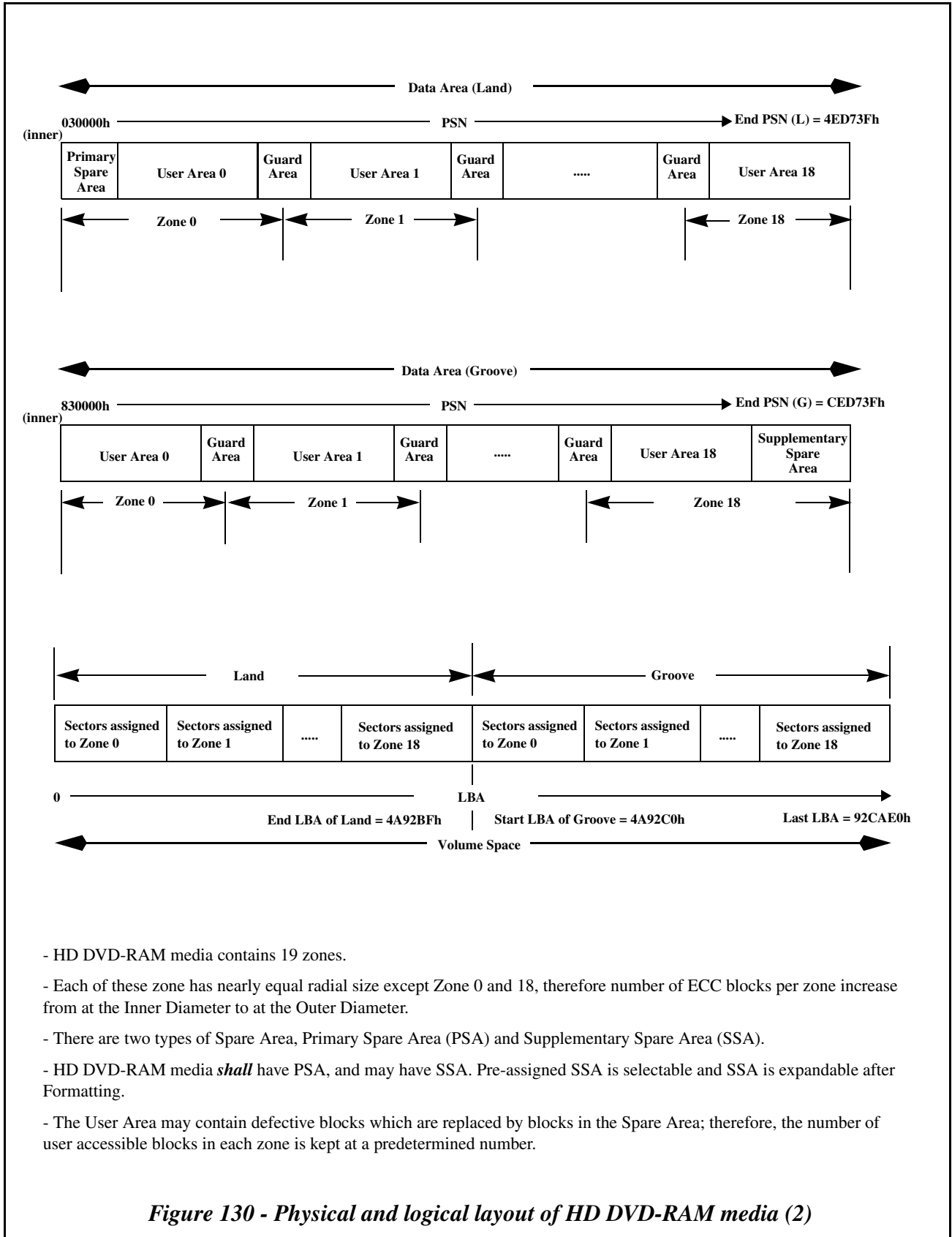












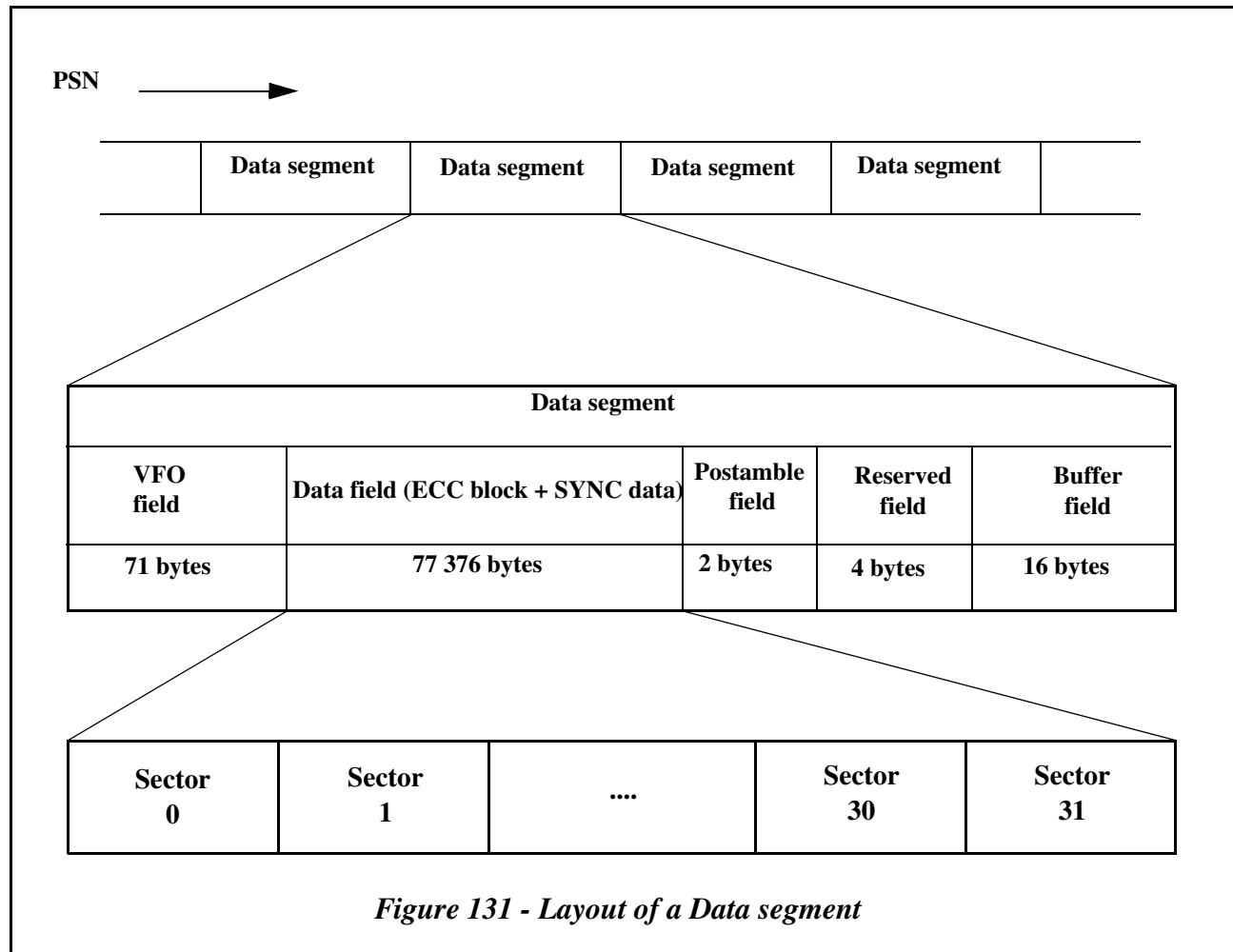
- HD DVD-RAM media contains 19 zones.
- Each of these zone has nearly equal radial size except Zone 0 and 18, therefore number of ECC blocks per zone increase from at the Inner Diameter to at the Outer Diameter.
- There are two types of Spare Area, Primary Spare Area (PSA) and Supplementary Spare Area (SSA).
- HD DVD-RAM media *shall* have PSA, and may have SSA. Pre-assigned SSA is selectable and SSA is expandable after Formatting.
- The User Area may contain defective blocks which are replaced by blocks in the Spare Area; therefore, the number of user accessible blocks in each zone is kept at a predetermined number.

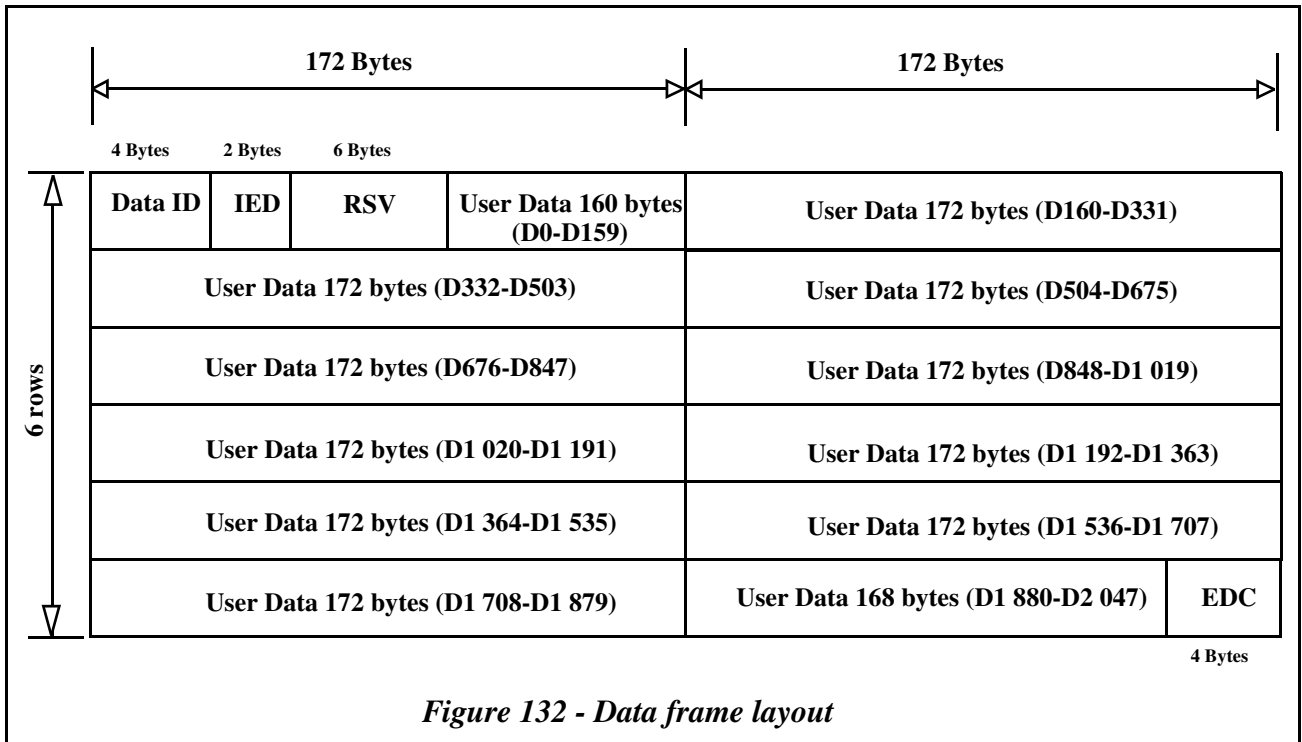
Figure 130 - Physical and logical layout of HD DVD-RAM media (2)

5.3 Data segment structure

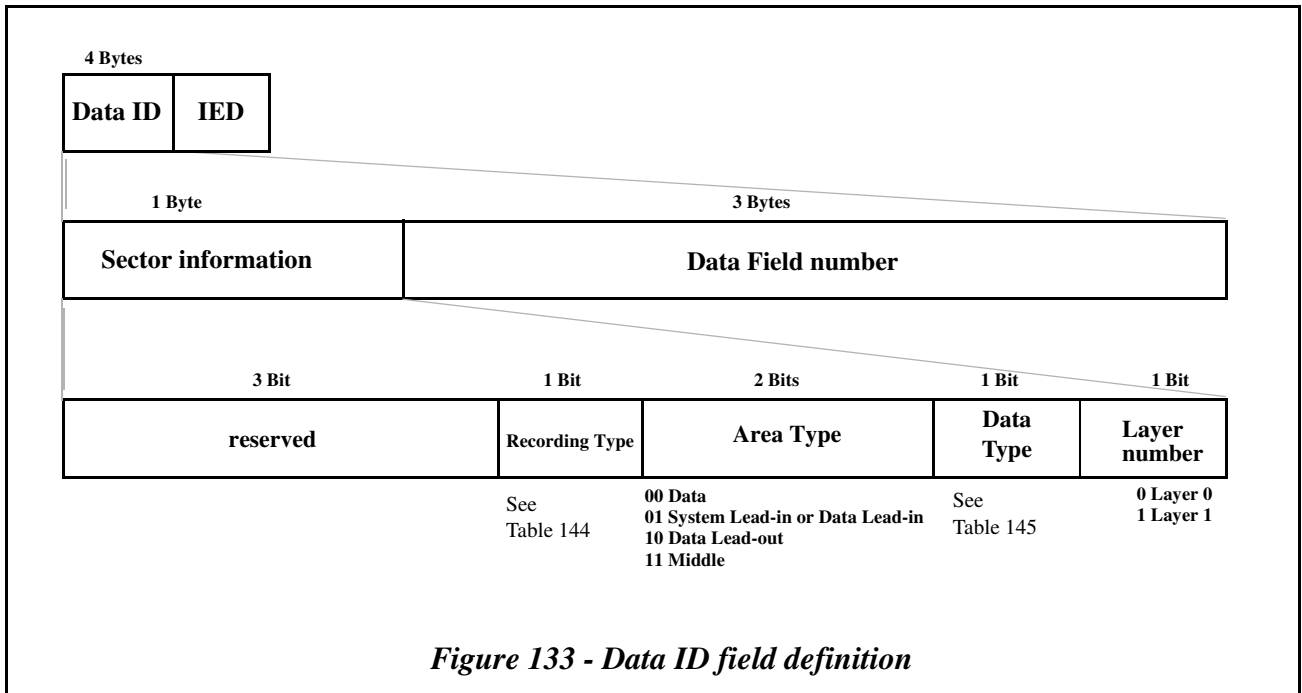
5.3.1 Data segment layout

The Data is physically recorded and read as a Data segment unit on disc by the logical unit. User data included in one ECC is recorded in the Data field of the Data segment. The layout of a Data segment is shown in Figure 131. According to this layout, lossless linking scheme is used especially for the HD DVD-R. The Data field consists of 32 sectors. A sector is created by using a Data frame which consists of Data ID, IED, RSV, User Data and EDC. The Data frame layout is shown in Figure 132.





5.3.2 Data configuration of Data ID field



The Data ID is located at the beginning of each sector and consists of 4 bytes. The Data Field number comprises PSN for HD DVD-ROM, HD DVD-R and HD DVD-RW. In the case of HD DVD-RAM, see Table 143.

Table 143 - Data Field Number for HD DVD-RAM media

Area	Contents
System Lead-in Area	PSN
Defect Management Area	PSN
Disc Identification Zones	PSN
Used ECC block ^a in Data Area	LBA + 030000h
Unused ECC block ^b in Data Area	One of the three conditions ^c (1) bit 0 to bit 4 in the first Physical sector: 0 the following Physical sectors: numbers serially increment from the first Physical sector (2) between 000000h to 00001Fh (3) unwritten

- a. Used ECC block: ECC block which contains user data.
- b. Unused ECC block: ECC block which contains no user data.
- c. All the Physical sectors in a ECC block are in the same condition.

Table 144 - Recording Type bit definition for HD DVD-RAM media ^a

Area	Definition
System Lead-in Area	0b
Data Lead-in Area, Data Lead-out Area	0b
Data Area	0b: General data ^b 1b: Real-time data ^c

- a. The definition of the bit for other than HD DVD-RAM media is Reserved.
- b. General data: Linear replacement algorithm is applied to an ECC block containing the corresponding sector if the ECC block is defective.
- c. Real-time data: Linear replacement algorithm is not applied to an ECC block containing the corresponding sector even if the ECC block is defective.

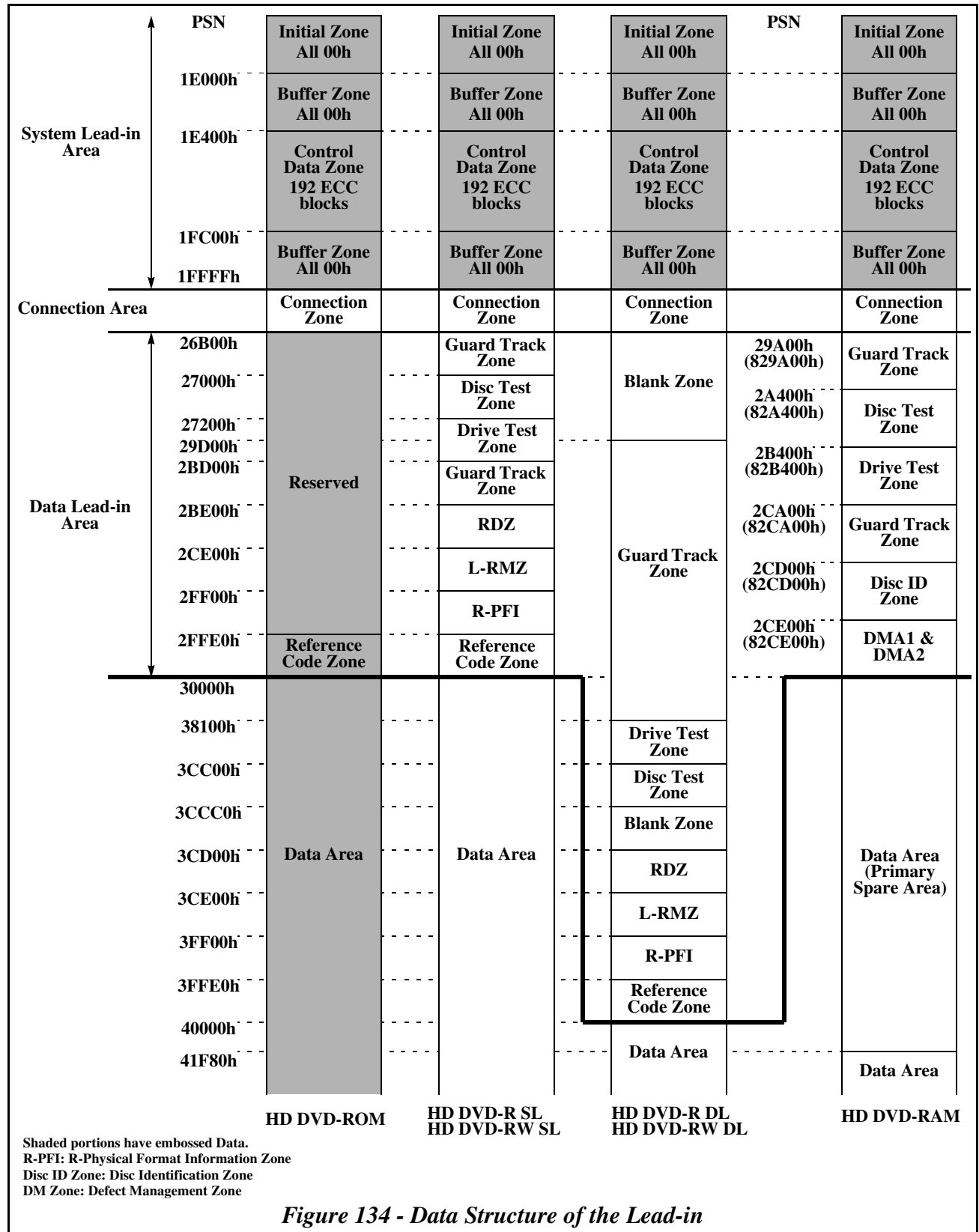
The Data Type bit specifies the data type of a sector as defined in Table 145.

Table 145 - Data Type bit definition

Media Type	Data Type bit	
	0	1
HD DVD-ROM	Read-only data	N/A
HD DVD-RAM	Read-only data	Rewritable data
HD DVD-R	Read-only data	Padding data ^a
HD DVD-RW	Read-only data/Re-recordable data	N/A

- a. Padding data is the data which does not include user data which is indicated by the host by using the command for writing, such as WRITE (10) command.

5.4 Data structure of Lead-in Area



5.4.1 Structure of Lead-in Area

The structure of Lead-in Area is shown in Figure 134. The Lead-in Area consists of System Lead-in Area, Connection Area and Data Lead-in Area.

5.4.2 System Lead-in Area

5.4.2.1 Control Data Zone

The Control Data Zone comprise 192 ECC blocks.

Figure 134 shows structure of a Control Data Zone.

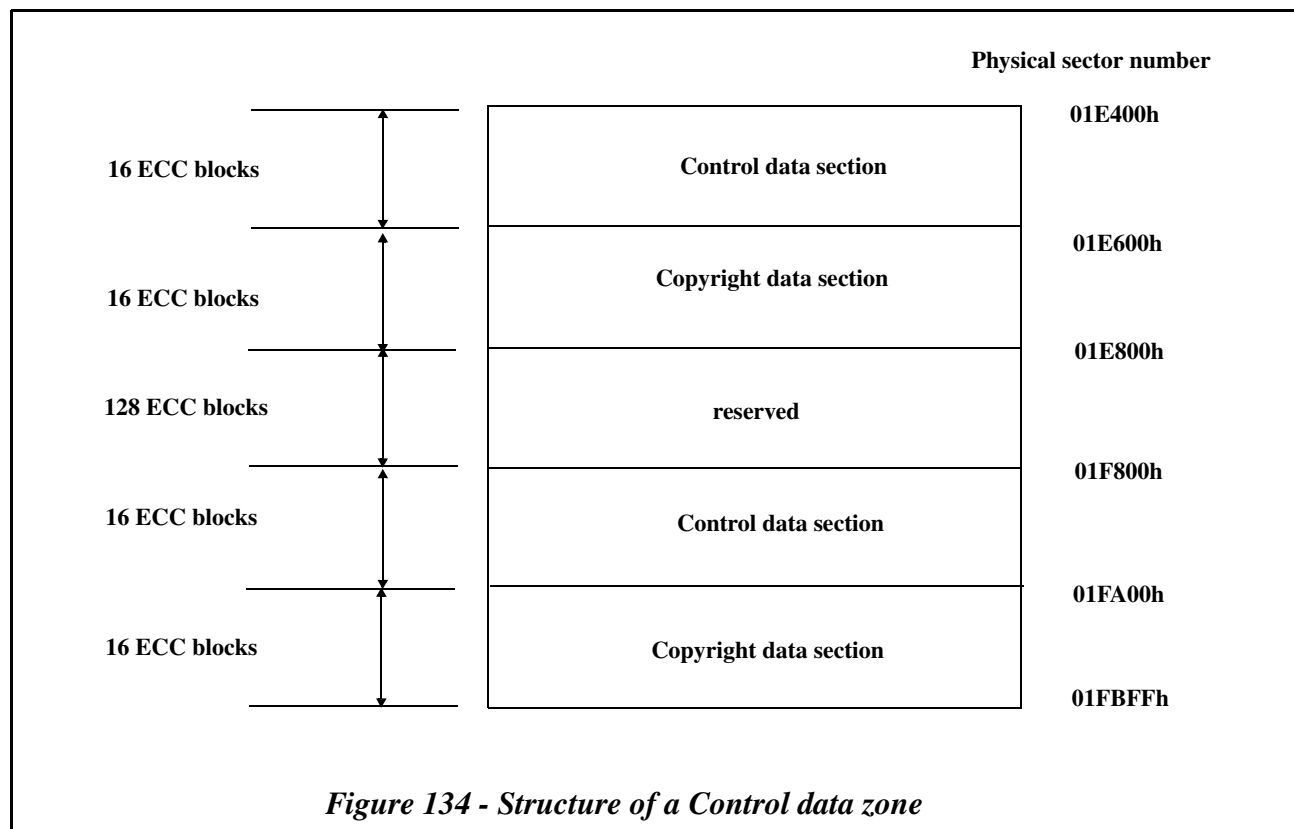


Figure 134 - Structure of a Control data zone

5.4.2.1.1 Control data section

The structure of a Control data section is shown in Table 146.

Table 146 - Structure of a Control data section

Sector Number	Description
0	Physical format information
1	Disc manufacturing information
2	Copyright protection information
3	Unplayable Drive manufacturer ID information
4-31	Reserved

5.4.2.1.1.1 Control Data Zone sector descriptions

Table 147 shows the format of the Physical Format descriptor.

Table 147 - Common part of Physical Format Information

Bit Byte	7	6	5	4	3	2	1	0
0	Book Type				Part Version			
1	Disc Size				Maximum Transfer Rate			
2	Reserved	Number of Layers		Track Path	Layer Type			
3	Linear Density				Track Density			
4-15	Data Area Allocation							
16	BCA Flag	Reserved						
17	Revision number of maximum recording speed ^a							
18	Revision number of minimum recording speed ^a							
19-25	Revision number table of recording speed ^a							
26	Class ^a							
27	Extended Part Version							
28-31	Reserved							
32-2 047	Medium Unique Data							

a. For HD DVD-ROM, these fields are reserved.

The Book Type field is described in Table 148.

Table 148 - Book Type field definition

Book Type Value	Definition
0000b	DVD-ROM
0001b	DVD-RAM
0010b	DVD-R
0011b	DVD-RW
0100b	HD DVD-ROM
0101b	HD DVD-RAM
0110b	HD DVD-R
0111b	HD DVD-RW
others	Reserved

The Part Version field identifies the version number within a Book Type. Table 149 shows the definition of the field.

Table 149 - Part Version field definition

Part Version Value	Definition
0011b	Version is specified at byte 27
others	Reserved

The Disc Size field, when set to 0000b, indicates a 120 mm disc. When set to 0001b, indicates an 80 mm disc. All other values are reserved.

The Maximum Transfer Rate field identifies the maximum data transfer rate found in the contents (e.g., video data) on the medium. See Table 150.

Table 150 - Maximum Transfer Rate field definition

Value	Definition
0000b	2,52 Mbps
0001b	5,04 Mbps
0010b	10,08 Mbps
0011b	20,16 Mbps
0100b	30,24 Mbps
1111b	Not specified (Only for the writable medium)
Others	Reserved

The Number of Layers field identifies the number of Layers on the current side. 00b indicates one Layer, 01b indicates two Layers, and other values are reserved.

The Track Path field, when set to 0b, indicates a PTP or Single Layer disc. When set to 1b, indicates an OTP disc.

The Layer Type field identifies the Layer according to Table 151.

Table 151 - Layer Type field definition

Bit	Definition
0	When set to one, the Layer contains embossed user Data Area
1	When set to one, the Layer contains recordable user Data Area
2	When set to one, the Layer contains re-writable user Data Area
3	Reserved

The Linear Density field identifies the bit density according to Table 152.

Table 152 - Linear Density field definition

Value	Definition
0000b	0,267 $\mu\text{m}/\text{bit}$
0001b	0,293 $\mu\text{m}/\text{bit}$
0010b	0,409-0,435 $\mu\text{m}/\text{bit}$
0100b	0,280-0,295 $\mu\text{m}/\text{bit}$
0101b	0,153 $\mu\text{m}/\text{bit}$
0110b	0,130-0,140 $\mu\text{m}/\text{bit}$
others	Reserved

The Track Density field identifies the track density according to Table 153.

Table 153 - Track Density field definition

Value	Definition
0000b	0,74 μm/track
0001b	0,80 μm/track
0010b	0,615 μm/track
0011b	0,40 μm/track
0100b	0,34 μm/track
others	Reserved

Table 154 describes the contents of the Data Area Allocation field.

Table 154 - Data Area Allocation field definition

Byte	HD DVD-ROM SL, HD DVD-ROM DL (PTP)	HD DVD-ROM DL (OTP)	HD DVD-R SL, HD DVD-RW SL	HD DVD-R DL, HD DVD-RW DL	HD DVD-RAM
4	00h				
5	Starting PSN of Data Area (030000h)			Starting PSN of Data Area (040000h)	Starting PSN of Data Area in land track (030000h)
6					
7					
8	00h				
9	End PSN of Data Area		Outer limit of Data Recordable area	Maximum PSN of Data Recordable area	End PSN of Data Area in land track
10					
11					
12	00h				
13	000000h	End PSN in L0	000000h	End PSN in Layer 0	Offset value between start PSN of the Data Area in land track and start PSN of the Data Area in groove track
14					
15					

For HD DVD-RAM, the end PSN is the PSN for the last spare sector of the last zone. It should not be used for counting user capacity.

The BCA Flag identifies the existence of Burst Cutting Area (BCA) on the medium. 0b indicates non-existence of BCA, 1b indicates existence of BCA on the medium.

The Revision number of maximum recording speed indicates the Revision number of maximum applicable recording speed of this disc.

The Revision number of minimum recording speed indicates the Revision number of minimum applicable recording speed of this disc.

The Revision number table field indicates the supported Revision numbers. These bit assignment rule is same as Byte 17.

The Class field indicates all Basic recording speeds contained in applicable recording speeds that the disc supports.

The Extended Part Version field indicates the major and minor digits of the Book Part version respectively.

Table 155 and Table 156 show the format unique descriptors for each media type.

Table 155 - HD DVD-ROM unique part of Physical Format Information

Bit Byte	7	6	5	4	3	2	1	0
32	Actual number of maximum reading speed							
33	Layer format table							
	Reserved			Layer 1			Layer 0	
34-2 047	Reserved							

The Actual number of maximum reading speed field specifies the actual number of maximum reading speed that is allowable for this disc.

The Layer format table field specifies the format of each layer for Twin format disc (Hybrid disc) which has both DVD-ROM and HD DVD-ROM. The Layer 0 field is set to 100b and the Layer 1 field is set to 000b.

Table 156 - HD DVD-RAM/-R/-RW unique part of Physical Format Information

Bit Byte	7	6	5	4	3	2	1	0
32	Actual number of maximum reading speed							
33-34	Reserved							
35	Lowest compatible Part version							
36-127	Reserved							
128	Mark polarity	Reserved						
129	Velocity							
130	Rim intensity in tangential direction							
131	Rim intensity in radial direction							
132	Read power							
133	Real number of 1st recording speed ^a							
134	Real number of 2nd recording speed ^a							
:	:							
147	Real number of 15th recording speed ^a							
148	Real number of 16th recording speed ^a							
149	Reflectivity of Data Area for Layer 0 ^a							
150	Track Shape for Layer 0 ^a	Amplitude of Push - Pull signal for Layer 0 ^a						
151	On track signal for Layer 0 ^a							
152	Reflectivity of Data area for Layer 1 ^b							
153	Track Shape for Layer 1 ^b	Amplitude of Push - Pull signal for Layer 1 ^b						
154	On track signal for Layer 1 ^b							
155-2 047	Reserved							

a. For HD DVD-RAM, these fields are reserved.

b. For HD DVD-RAM, HD DVD-R SL and HD DVD-RW SL, these fields are reserved.

The **Actual number of maximum reading speed** field specifies the actual number of maximum reading speed that is allowable for this disc.

The **Lowest compatible Part version** specifies the lowest number of the Book Part version which the disc complies with.

The **Mark polarity** bit, when set to 0b, indicates that signal from mark is larger than signal from space, Low-to-High disc. When set to 1b, indicates that signal from mark is smaller than signal from space, High-to-Low disc.

The **Velocity** field defines linear velocity for the disc.

The **Rim intensity in tangential direction** field specifies the Rim intensity in tangential direction of the reference Optical Head that Read power field is defined.

The **Rim intensity in radial direction** field specifies the Rim intensity in radial direction of the reference Optical Head that Read power field is defined.

The **Read power** field specifies the Read power on the read-out surface of the disc for playback.

The **Real number of 1st recording speed** field specifies the real number of 1st recording speed. The actual 1st recording speed is one tenth of the field value. For example, 0000 1010b indicates 1×.

The **Reflectivity of Data Area** field specifies the Reflectivity of Data Area. The actual Reflectivity of Data Area is one second of the field value. For example, 0010 1000b indicates 20%.

The **Track Shape** bit specifies the track shape of the disc. This bit, when set to 0b, indicates that the track is on groove. When set to 1b, indicates that the track is on land.

The **Amplitude of Push - Pull signal** field specifies the Amplitude of Push - Pull signal. The actual Amplitude of Push - Pull signal is one hundredth of the field value.

The **On track signal** field specifies the amplitude of On track signal.

5.4.3 Connection Area

The Connection Area is located between System Lead-in Area and Data Lead-in Area. This area does not have any embossed pits or grooves.

5.4.4 Data Lead-in Area

The structure of Data Lead-in Area for each media is different.

5.4.4.1 Data Lead-in Area for HD DVD-ROM

5.4.4.1.1 Reference Code Zone

This zone contains repetition of the Data Symbol "164" with added scrambled data.

5.4.4.2 Data Lead-in Area for HD DVD-RAM

5.4.4.2.1 Guard Track Zone

The ECC blocks of Guard Track Zone do not contain data.

5.4.4.2.2 Disc Test Zone

This zone is intended for quality tests by the disc manufacturer.

5.4.4.2.3 Drive Test Zone

This zone is intended for tests by a drive.

5.4.4.2.4 Disc Identification Zone

This zone contains Drive information and a reserved area.

5.4.4.2.5 Defect Management Zone

This zone contains DMA (Defect Management Area) manager sets and DMA (Defect Management Area). See 5.17.6 "Defect management for HD DVD-RAM media" on page 448.

5.4.4.3 Data Lead-in Area for HD DVD-R SL

5.4.4.3.1 Guard Track Zone

The ECC blocks of Guard Track Zone do not contain data.

5.4.4.3.2 Disc Test Zone

This zone is intended for quality tests by the disc manufacturer

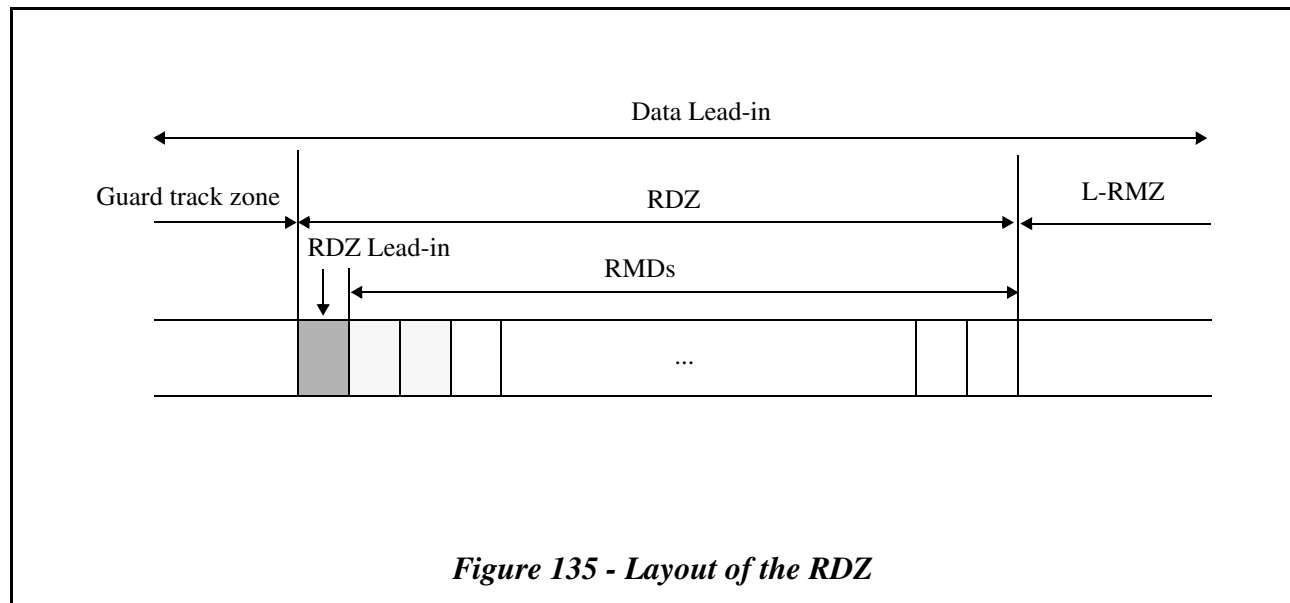
5.4.4.3.3 Drive Test Zone

This zone is intended for tests by a drive.

5.4.4.3.4 Recording Management Data Duplication Zone (RDZ)

When RMZ is extended, the latest RMD is recorded in this zone. For more explanation of RMZ and RMD, see 5.13.2.1 "RMZ (Recording Management Zone)" on page 333 and 5.13.3 "Recording model for HD DVD-R media" on page 346.

The size of RDZ is 128 ECC blocks. The first ECC block of RDZ is used as RDZ Lead-in. The rest of the RDZ is used to store up to 127 RMDs.



5.4.4.3.5 Recording Management Zone (L-RMZ)

This zone consists of RMD. The size of L-RMZ is 392 ECC blocks. See 5.13.3 "Recording model for HD DVD-R media" on page 346.

5.4.4.3.6 R-Physical format information

This zone is comprised of 7 ECC blocks. The content of the first ECC block in this zone is repeated 7 times. The structure of R-Physical format information is shown in Table 157. The format of the Physical Format descriptor is same as the format of the Physical Format descriptor in System Lead-in Area (Table 147, Table 156) except the Data Area allocation field and the Start PSN of Border Zone field. The definition of the Data Area allocation field is shown in Table 158, the definition of the Start PSN of Border Zone field is shown in Table 159.

Table 157 - Structure of the R-Physical Format Information Zone

Sector number	Description
0	Reserved
1	Disc manufacturing information
2	Physical format information
3-31	Reserved

Table 158 - Data Area allocation field definition

Byte	definition
4	00h
5-7	Start PSN of the Data Area (30000h)
8	00h
9-11	Last recorded PSN of last RZone in the User data zone
12	00h
13-15	000000h

Table 159 - Start PSN of Border Zone field definition

Byte	definition
256-259	Start PSN of the current Border-out
260-263	Start PSN of the next Border-in

5.4.4.3.7 Reference Code Zone

This zone contains repetition of the Data Symbol “164” with added scrambled data.

5.4.4.4 Data Lead-in Area for HD DVD-R DL**5.4.4.4.1 Blank Zone**

The ECC blocks of Blank Zone do not contain data.

5.4.4.4.2 Guard Track Zone

The ECC blocks of Guard Track Zone are filled with 00h before recording on L1.

5.4.4.4.3 Disc Test Zone

This zone is intended for quality tests by the disc manufacturer

5.4.4.4.4 Drive Test Zone

This zone is intended for tests by a drive.

5.4.4.4.5 Recording Management Data Duplication Zone (RDZ)

This zone contains RDZ Lead-in. The size of RDZ is 8 ECC blocks. The first ECC block of the RDZ is used as RDZ Lead-in. The rest of the RDZ is reserved.

5.4.4.4.6 Recording Management Zone (L-RMZ)

This zone consists of RMD. The size of L-RMZ is 392 ECC blocks.

5.4.4.4.7 R-Physical Format Information

This zone is comprised of 7 ECC blocks. The content of the first ECC block in this zone is repeated 7 times. The structure of R-Physical format information is shown in Table 160. The format of the Physical Format descriptor is same as the format of the Physical Format descriptor in System Lead-in Area (Table 147, Table 156) except the Data Area allocation field. The definition of the Data Area allocation field is shown in Table 161.

Table 160 - Structure of the R-Physical format information Zone

Sector number	Description
0	Reserved
1	Disc manufacturing information
2	Physical format information
3-31	Reserved

Table 161 - Data area allocation filed definition

Byte	definition
4	00h
5-7	Start PSN of the Data area (40000h)
8	00h
9-11	Last recorded PSN of last RZone
12	00h
13-15	End PSN in Layer 0

5.4.4.4.8 Reference Code Zone

This zone contains repetition of the Data Symbol “164” with added scrambled data.

5.4.4.5 Data Lead-in Area for HD DVD-RW SL

5.4.4.5.1 Guard Track Zone

The ECC blocks of Guard Track Zone do not contain data.

5.4.4.5.2 Disc Test Zone

This zone is intended for quality tests by the disc manufacturer

5.4.4.5.3 Drive Test Zone

This zone is intended for tests by a logical unit.

5.4.4.5.4 Recording Management Data Duplication Zone (RDZ)

The size of RDZ is 128 ECC blocks. The first ECC block of RDZ is used as RDZ Lead-in. The next 7 ECC blocks are used to record RMD. The rest of RDZ is blank. The layout of RDZ is shown in Table 136.

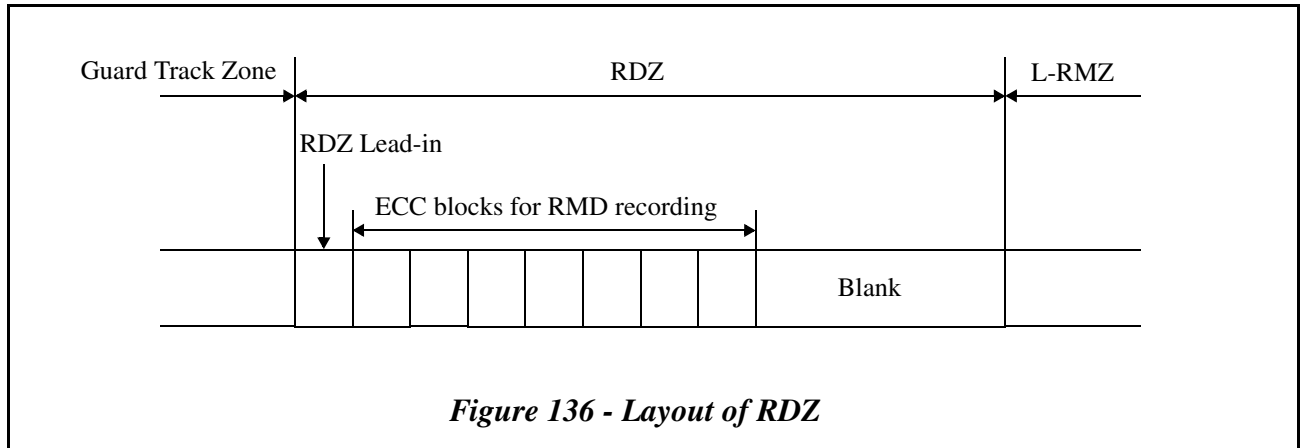
RDZ Lead-in is recorded before recording the first RMD in L-RMZ.

The latest RMD is recorded from inner ECC block to outer ECC block one by one. When the outermost ECC block is recorded, the next RMD is recorded at the innermost ECC block. This recording order continues cyclically in 7 ECC blocks.

If an ECC block has EDC error at the latest RMD recording, the defect status of RDZ is renewed and the latest RMD with the renewed defect status is recorded in the next ECC block.

RMD which has the largest order number in the latest RMD set is copied in RDZ when at least one of the following conditions are satisfied.

- A disc state becomes Finalized or Full-finalized state
- A disc is to be ejected and the latest RMD is not copied.



5.4.4.5.5 Recording Management Zone (L-RMZ)

This zone consists of 98 RMD sets which are identified by the RMD set number from 0 to 97. Each RMD set consists of 4 RMD orders which are identified by the RMD order number from 0 to 3.

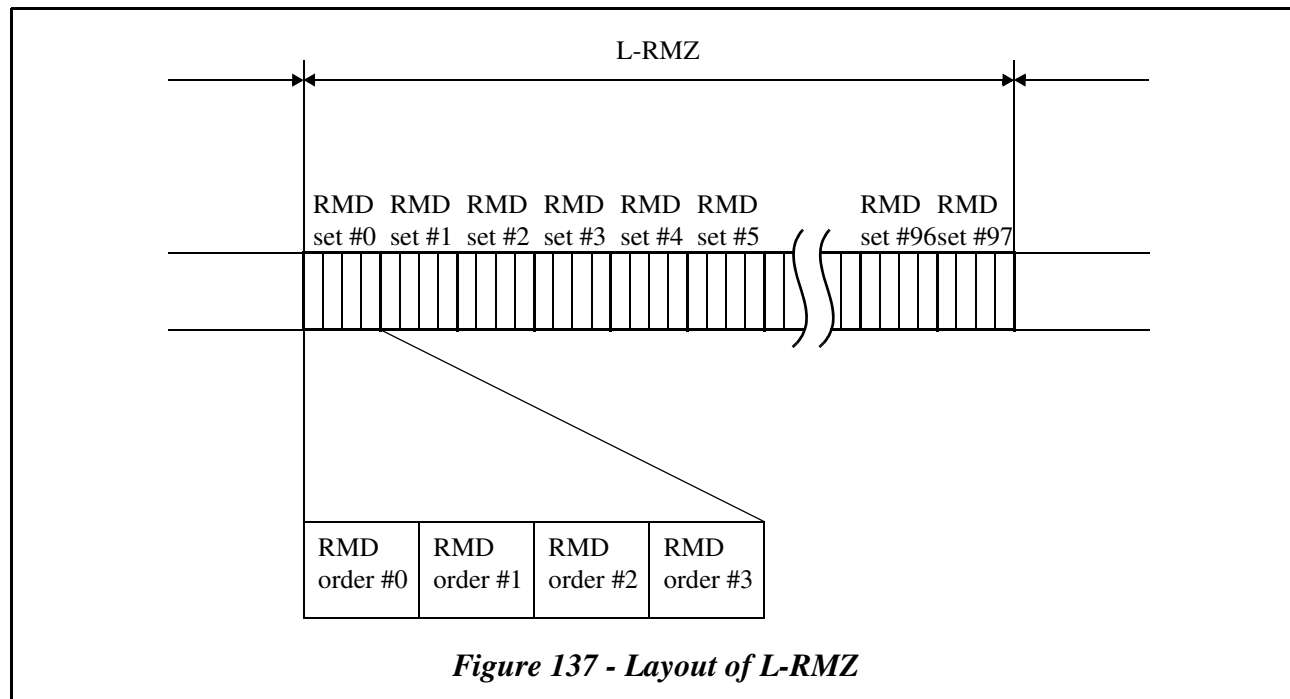
RMD is recorded in a RMD set from inner to outer one by one. 4 ECC blocks in an RMD set are recorded the same RMD except for the RMD order number.

When the outermost RMD set #97 is recorded, the next RMD is recorded at the innermost RMD set #0. This recording order continues cyclically in 98 RMD sets.

When the renewed RMD is recorded in a RMD set, the RMD serial number is incremented by 1. The initial value of the RMD serial number is 0.

If a RMD set has 2 or more ECC blocks with EDC error at the latest RMD recording, the defect status of RMZ is renewed and the latest RMD with the renewed defect status is recorded in the next RMD set without increasing the RMD serial number.

If blank RMD sets are remained at Finalization, the latest RMD is recorded in the blank RMD sets without increasing the RMD serial number.



5.4.4.5.6 R-Physical Format Information Zone

This zone is comprised of 7 ECC blocks. The content of the first ECC block in this zone is repeated 7 times. The structure of R-Physical Format Information Zone is shown in Table 162. The format of the Physical Format descriptor is same as the format of the Physical Format descriptor in System Lead-in Area (Table 147, Table 156) except the Data Area allocation field. The definition of the Data Area allocation field is shown in Table 163.

If a ECC block has EDC error at the recording, the Defect status of R-PFI Zone is renewed.

Table 162 - Structure of R-Physical Format Information Zone

Sector number	Description
0	Reserved
1	Disc manufacturing information
2	Physical format information
3-31	Reserved

Table 163 - Data Area allocation filed definition

Byte	definition
4	00h
5-7	Start PSN of the Data Area (30000h)
8	00h
9-11	Last PSN of RZone
12	00h
13-15	000000h

5.4.4.5.7 Reference Code Zone

This zone contains repetition of the Data Symbol “164” with added scrambled data.

5.4.4.6 Data Lead-in Area for HD DVD-RW DL**5.4.4.6.1 Blank Zone**

The ECC blocks of Blank Zone do not contain data.

5.4.4.6.2 Guard Track Zone

The ECC blocks of Guard Track Zone are filled with 00h before recording on L1.

5.4.4.6.3 Disc Test Zone

This zone is intended for quality tests by the disc manufacturer.

5.4.4.6.4 Drive Test Zone

This zone is intended for tests by a drive.

5.4.4.6.5 Recording Management Data Duplication Zone (RDZ)

The size of RDZ is 8 ECC blocks. The first ECC block of RDZ is used as RDZ Lead-in. The next 7 ECC blocks are used to record RMD. The layout of RDZ is shown in Table 138.

The rules of RDZ recording is the same as that of HD DVD-RW SL except at finalization. See *Section 5.4.4.5.4, "Recording Management Data Duplication Zone (RDZ)"* on page 320. If blank ECC blocks are remained at Finalization, the latest RMD is recorded in the remaining ECC blocks of RDZ.

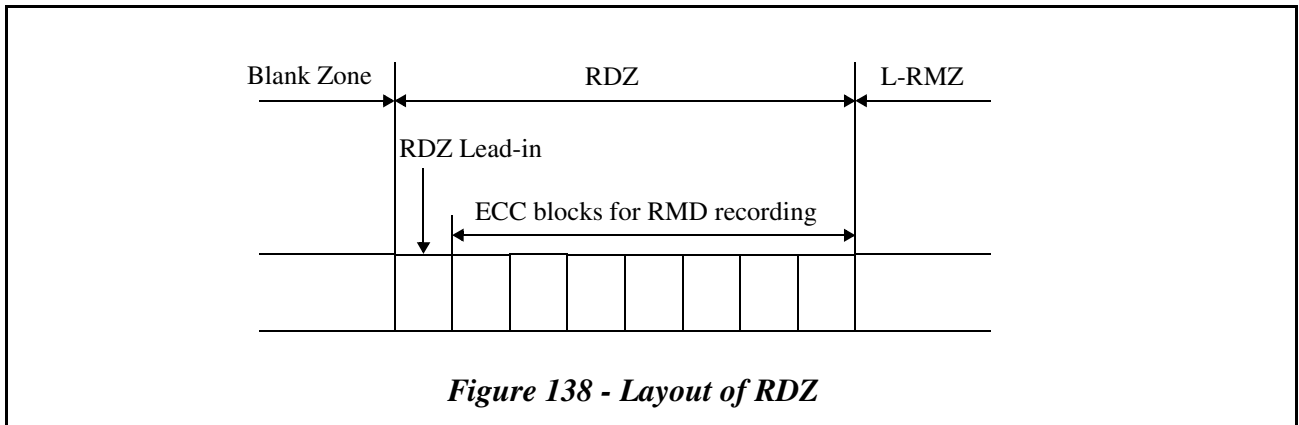


Figure 138 - Layout of RDZ

5.4.4.6.6 Recording Management Zone (L-RMZ)

This zone consists of 98 RMD sets which are identified by the RMD set number from 0 to 97. Each RMD set consists of 4 RMD orders which are identified by the RMD order number from 0 to 3.

The rules of RDZ recording is the same as that of HD DVD-RW SL. See *Section 5.4.4.5.5, "Recording Management Zone (L-RMZ)"* on page 321.

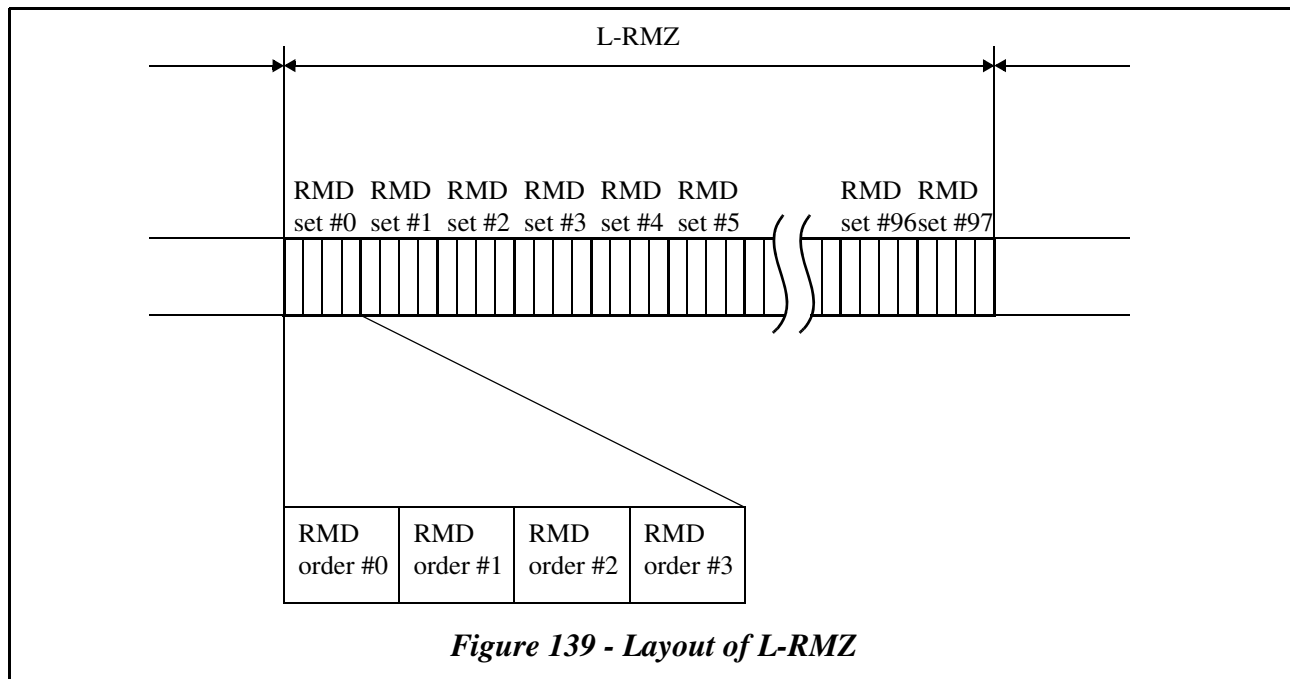


Figure 139 - Layout of L-RMZ

5.4.4.6.7 R-Physical Format Information Zone

This zone is comprised of 7 ECC blocks. The content of the first ECC block in this zone is repeated 7 times. The structure of R-Physical Format Information Zone is shown in Table 164. The format of the Physical Format descriptor is same as the format of the Physical Format descriptor in System Lead-in Area (Table 147, Table 156) except the Data Area allocation field. The definition of the Data Area allocation field is shown in Table 165.

The R-PFI Zone is recorded at Finalization.

If a ECC block has EDC error at the recording, the Defect status of R-PFI Zone is renewed.

Table 164 - Structure of the R-Physical format information

Sector number	Description
0	Reserved
1	Disc manufacturing information
2	Physical format information
3-31	Reserved

Table 165 - Data area allocation filed definition

Byte	definition
4	00h
5-7	Start PSN of the Data area (40000h)
8	00h
9-11	Last PSN of RZone
12	00h
13-15	End PSN of RZone in Layer 0

5.4.4.6.8 Reference Code Zone

This zone contains repetition of the Data Symbol “164” with added scrambled data.

5.5 Data structure of Lead-out Area

5.5.1 System Lead-out Area

The System Lead-out Area is located Layer 1 in Opposite Track Path HD DVD-ROM/-R/-RW DL media. See Figure 124. This area is set to 00h.

5.5.2 Data Lead-out Area

The Data Lead-out Area is located in all HD DVD media. The structure of the Data Lead-out Area in each HD DVD media refer to below.

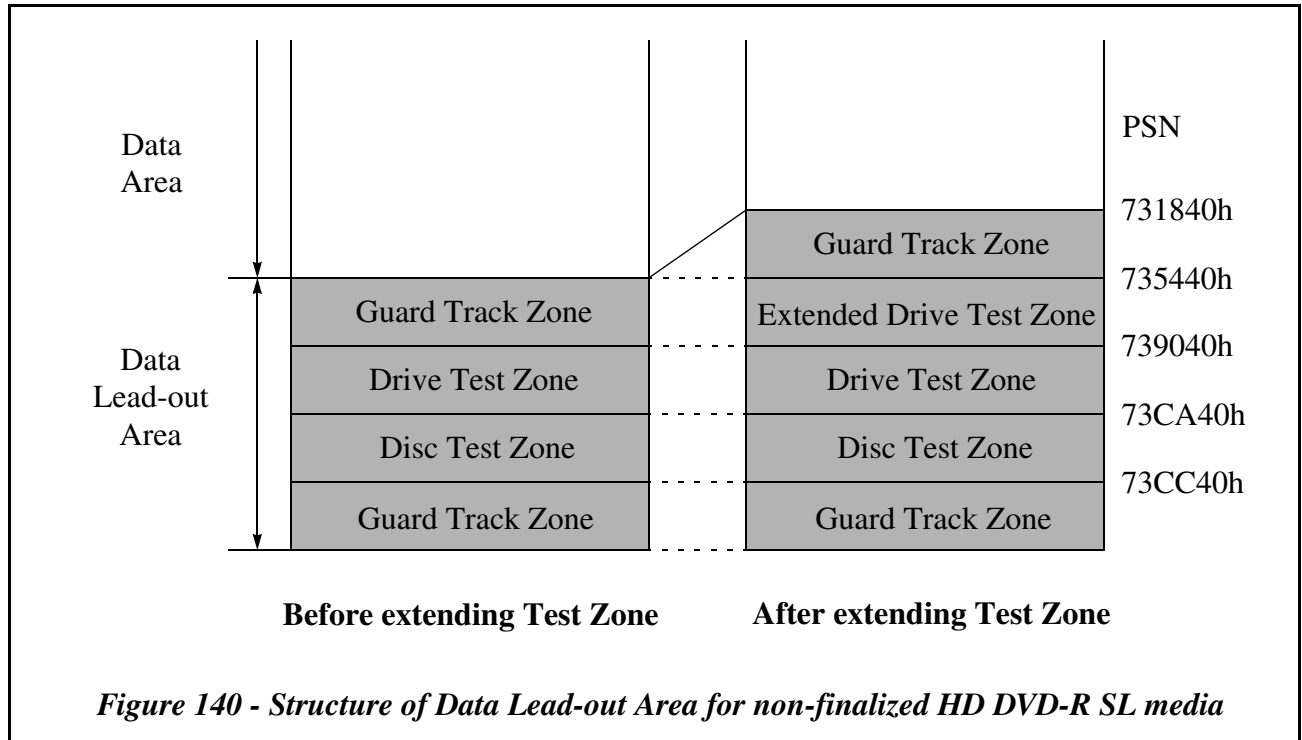
5.5.2.1 Data Lead-out Area for HD DVD-ROM

The Data Lead-out Area for HD DVD-ROM is located in all kind of HD DVD-ROM media. See Figure 122, Figure 123, Figure 124. This area is set to 00h.

5.5.2.2 Data Lead-out Area for HD DVD-R SL

The Data Lead-out Area for HD DVD-R SL discs is located outer area. The structure of Data Lead-out Area is different between finalized disc and non-finalized disc.

For non-finalized disc, Data Lead-out Area consists of Guard Track Zone, Drive Test Zone and Disc Test Zone. This area size is variable. There are two kinds of the Data Lead-out Area structure, shown in Figure 140. One is the original structure, the other is the structure after extending test zone.



For finalized disc, Data Lead-out Area is located from Border-out (Area type 10h) or Terminator to outer of the disc. See 5.13.10 "Disc Final Closure" on page 356.

5.5.2.3 Data Lead-out Area for HD DVD-R DL

The original Data Lead-out Area for HD DVD-R DL is located inner area on L1. The original Data Lead-out Area consists of Guard Track Zone, Drive Test Zone, Disc Test Zone and Blank Zone. See Figure 141.

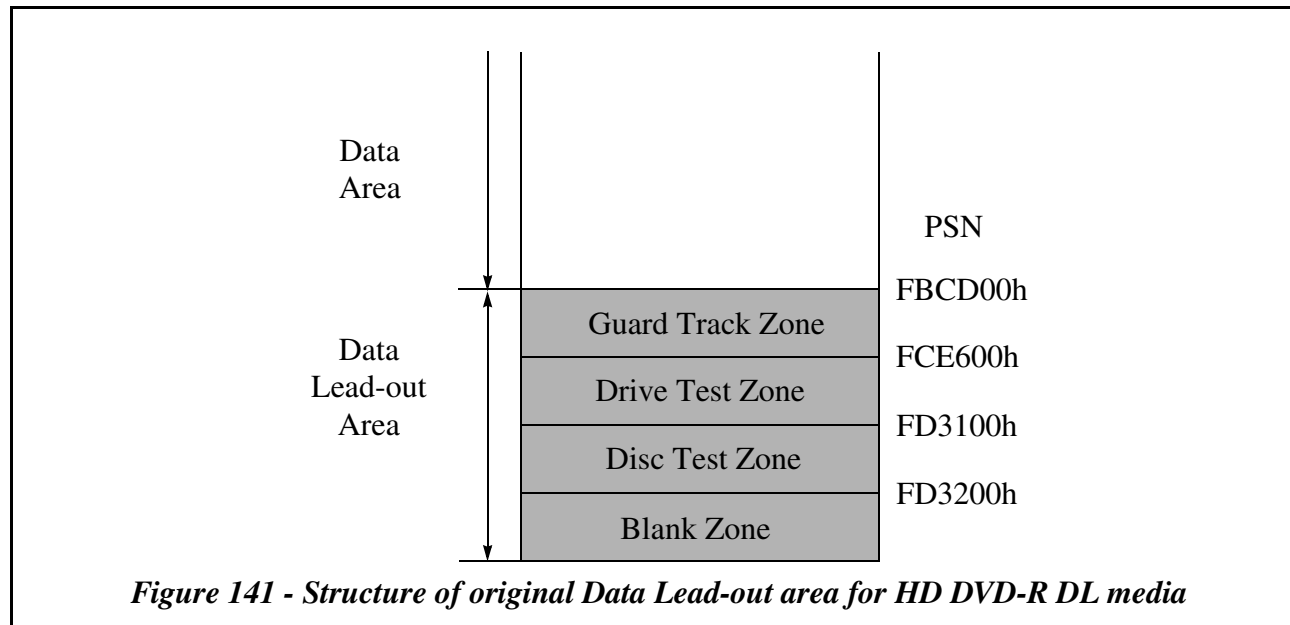


Figure 141 - Structure of original Data Lead-out area for HD DVD-R DL media

5.5.2.4 Data Lead-out Area for HD DVD-RW SL

The original Data Lead-out Area for HD DVD-RW SL is located outer area. The structure of the original Data Lead-out Area is the same as that of HD DVD-R SL¹. See Figure 140.

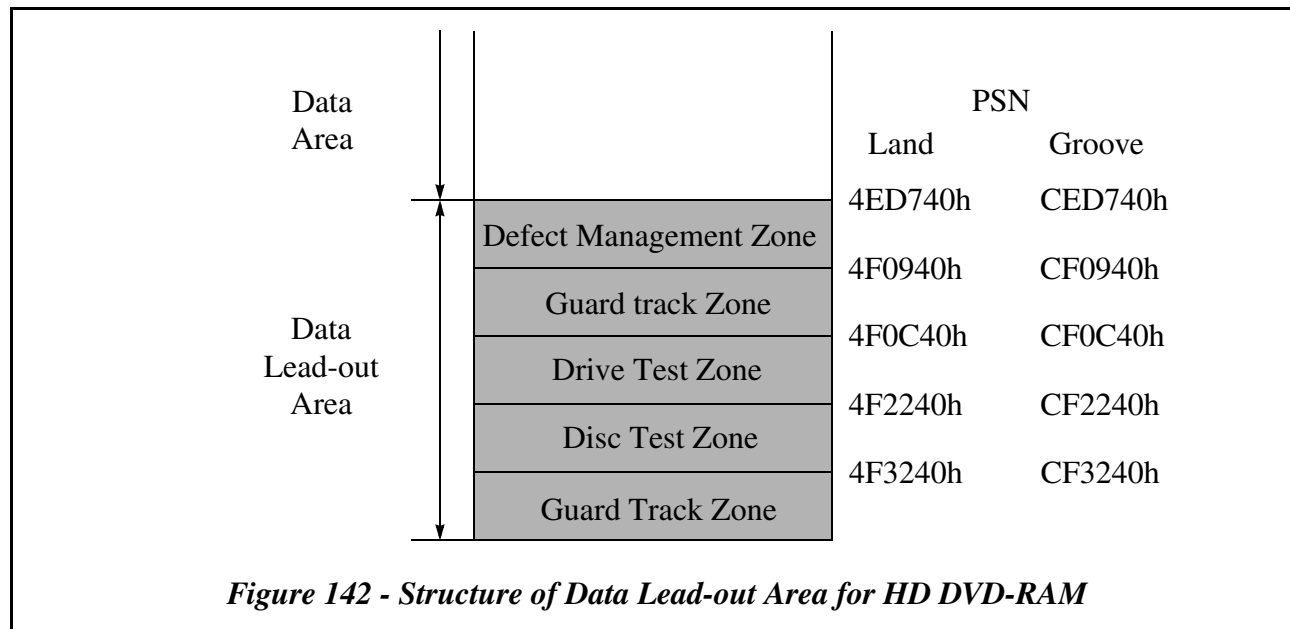
5.5.2.5 Data Lead-out Area for HD DVD-RW DL

The original Data Lead-out Area for HD DVD-RW DL is located inner area on L1. The structure of the original Data Lead-out Area is the same as that of HD DVD-R DL. See Figure 141.

5.5.2.6 Data Lead-out Area for HD DVD-RAM

The Data Lead-out Area for HD DVD-RAM is located outer area, both land and groove. This area consists of Defect Management Zone, Guard Track Zone, Drive Test Zone and Disc Test Zone. They are shown in Figure 142.

1. Drive Test Zone extension is not defined for HD DVD-RW SL.



5.6 HD DVD READY condition/NOT READY condition

The READY condition occurs after a disc is inserted and the logical unit has performed its initialization tasks. These may include reading the Lead-in information from the media. This “READY” is different from and should not be confused with the ATA READY status. A CHECK CONDITION status *shall* be returned for the NOT READY condition only for commands that require or imply a disc access.

A NOT READY condition may occur for the following reasons:

1. There is no disc mounted, see 5.8, "Removable medium" on page 328
2. The logical unit is unable to load or unload the disc.
3. The logical unit is performing an extended operation as the result of an Immediate mode command such as FORMAT UNIT. The logical unit *shall* attempt to spin up and make the disc ready for media accesses when a new disc is detected.

After the logical unit becomes ready, the logical unit may enter the power state in which the logical unit was when the previous medium was removed.

Any media access that occurs when the logical unit is in the IDLE or STANDBY state *shall* spin the media up and not generate an error. Any media access that is requested while a deferred operation is in progress (i.e. writing from a write cache) *shall not* generate an error. Any media access that is requested while the logical unit is processing an Immediate command, e.g., FORMAT UNIT with the Immediate bit set, may result in a NOT READY condition.

Note: Accesses to the media can be satisfied from the logical unit’s cache and may not require the media to be spinning.

5.7 Error reporting

If any of the following conditions occur during the execution of a command, the logical unit *shall* return CHECK CONDITION status. The appropriate Sense Key and additional sense code *shall* be set. The following list illustrates some error conditions and the applicable Sense Keys. The list does not provide an exhaustive enumeration of all conditions that may cause the CHECK CONDITION status.

Table 166 - Error conditions and Sense Keys

Condition	Sense Key
Invalid logical block address	ILLEGAL REQUEST
Unsupported option requested	ILLEGAL REQUEST
Attempt to read a blank block (where illegal)	ILLEGAL REQUEST
Attempt to play a data block as audio	ILLEGAL REQUEST
Logical unit reset or medium change since last command	UNIT ATTENTION
Self diagnostic failed	HARDWARE ERROR
Unrecovered read error	MEDIUM ERROR / HARDWARE ERROR
Recovered read error	RECOVERED ERROR
Overrun or other error that might be resolved by repeating the command	ABORTED COMMAND

In the case of an invalid logical block address, the sense data information field *shall* be set to the logical block address of the first invalid address.

In the case of an attempt to read a blank or previously unwritten block, the sense data information field *shall* be set to the logical block address of the first blank block encountered. The data read up to that block *shall* be transferred.

5.8 Removable medium

HD DVD medium is sometimes contained within a cartridge to prevent damage to the recording surfaces. The combination of medium and optional cartridge is often called a volume.

A disc has an attribute of being mounted or de-mounted on a suitable transport mechanism. A disc is mounted when the logical unit is capable of performing read operations to the medium or is able to format it. A mounted disc may not be accessible by a host if it has been reserved by another host. A disc is de-mounted at any other time (e.g., during loading, unloading, or storage).

A host may check whether a disc is mounted by issuing a TEST UNIT READY command. In addition, there now exists the Removable Medium Feature. This Feature allows the host to prevent the removal of any media, as well as sensing requests from the user to remove media.

The PREVENT ALLOW MEDIUM REMOVAL command allows a host to restrict the demounting of the disc. This is useful in maintaining system integrity. If the logical unit implements cache memory, it *shall* ensure that all logical blocks of the medium contain the most recent data prior to permitting demounting of the disc. If the host issues a START STOP UNIT command to eject the disc, and is prevented from demounting by the PREVENT ALLOW MEDIUM REMOVAL command, the START STOP UNIT command is rejected by the logical unit.

5.9 Logical blocks

Blocks of data are stored on the medium along with additional information that the controller uses to manage the storage and retrieval. The format of the additional information is unique and is hidden from the host during normal read or write operations. This additional information is often used to identify the physical location of the blocks of data and the address of the logical block, and to provide protection against the loss of the user data.

The address of the first logical block is zero. The address of the last logical block is [n-1], where [n] is the number of logical blocks available on the medium. A READ FORMAT CAPACITIES command may be issued to determine the value of [n-1]. If a command is issued that requests access to a logical block not within the capacity of the medium, the command is terminated with CHECK CONDITION Status, 5/21/00 LOGICAL BLOCK ADDRESS OUT OF RANGE.

The number of bytes of data contained in a logical block is known as the block length. Each logical block has a block length associated with it. The block length *shall not* be different for each logical block on the medium. The block descriptor in the MODE SENSE (10) data describes the block length that is used on the medium. The block descriptor

shall not be present for an ATAPI Multi-Media logical unit. In addition, the Block Descriptor has been made Obsolete in this specification.

The location of a logical block on the medium is not required to have a specific relationship to the location of any other logical block. However, in a typical logical unit the logical blocks are located in an ascending order. The time to access the logical block at address [x] and then the logical block at address [x+1] need not be less than time to access [x] and then [x+100].

5.10 Data cache

Some logical units implement cache memory. A cache memory is usually an area of temporary storage in the logical unit with a fast access time that is used to enhance performance. It exists separately from the blocks of data stored and is normally not directly accessible by the host. Use of cache memory for write or read operations typically reduces the access time to a logical block and can increase the overall data throughput.

During read operations, the logical unit uses the cache memory to store blocks of data that the host may request at some future time. The algorithm used to manage the cache memory is not part of this specification. However, parameters are provided to advise the logical unit about future requests, or to restrict the use of cache memory for a particular request.

Sometimes the host may wish to have the blocks of data read from the medium instead of from the cache memory. The force unit access (FUA) bit is used to indicate that the logical unit *shall* access the physical medium. For a write operation, setting FUA to one causes the logical unit to complete the data write to the physical medium before completing the command. For a read operation, setting FUA to one causes the logical blocks to be retrieved from the physical medium.

Commands may be implemented by the logical unit that allow the host to control other behavior of the cache memory:

- The MODE SENSE (10) command defines a page for the control of cache behavior and handles certain basic elements of cache replacement algorithms.
- The SYNCHRONIZE CACHE (10) command is used by the host to guarantee that data in the cache has been moved to the media.

5.11 Seek

The SEEK command provides a way for the host to position the logical unit in preparation for access to a particular logical block at some later time. Since this positioning action is implicit in other commands, the SEEK command may not be useful with some logical units.

5.12 Difference between HD DVD and DVD

Table 167 shows Profile for HD DVD.

Table 167 - Profile for HD DVD

Profile
0050h: HD DVD-ROM
0051h: HD DVD-R
0052h: HD DVD-RAM

5.12.1 HD DVD-ROM vs. DVD-ROM

- AACS Authentication
- retrieving Copyright data section from the Lead-in Area

Table 168 - Mandatory Features for HD DVD-ROM, DVD-ROM

Feature	HD DVD-ROM	DVD-ROM
0000h Profile List	Mandatory	Mandatory
0001h Core	Mandatory	Mandatory
0002h Morphing	Mandatory	Mandatory
0003h Removable Medium	Mandatory	Mandatory
0010h Random Readable, PP = 1	Mandatory	Mandatory
0050h HD DVD Read	Mandatory	-
001Fh DVD Read	-	Mandatory
0100h Power Management	Mandatory	Mandatory
0105h Timeout	Mandatory	Mandatory
0107h Real-Time Streaming	Mandatory	Mandatory

5.12.2 HD DVD-R vs. DVD-R

- AACS Authentication
- retrieving Copyright data section from the Lead-in Area
- RMZ extension
- Drive Test Zone extension
- Finalization method

Table 169 - Mandatory Features for HD DVD-R, DVD-R

Feature	HD DVD-R	DVD-R
0000h Profile List	Mandatory	Mandatory
0001h Core	Mandatory	Mandatory
0002h Morphing	Mandatory	Mandatory
0003h Removable Medium	Mandatory	Mandatory
0010h Random Readable, PP = 1	Mandatory	Mandatory
001Fh DVD Read	-	Mandatory
0021h Incremental Streaming Writable	Mandatory	Mandatory
002Fh DVD-R/-RW Write	-	Mandatory
0050h HD DVD Read	Mandatory	-
0051h HD DVD Write	Mandatory	-
0100h Power Management	Mandatory	Mandatory
0105h Timeout	Mandatory	Mandatory
0107h Real-Time Streaming	Mandatory	Mandatory
0108h Logical unit Serial Number	Mandatory	Mandatory

5.12.3 HD DVD-RAM vs. DVD-RAM

- AACS Authentication
- retrieving Copyright data section from the Lead-in Area

Table 170 - Mandatory Features for HD DVD-RAM, DVD-RAM

Feature	HD DVD-RAM	DVD-RAM
0000h Profile List	Mandatory	Mandatory
0001h Core	Mandatory	Mandatory
0002h Morphing	Mandatory	Mandatory
0003h Removable Medium	Mandatory	Mandatory
0010h Random Readable, PP = 1	Mandatory	Mandatory
001Fh DVD Read	-	Mandatory
0020h Random Writable	Mandatory	Mandatory
0023h Formattable	Mandatory	Mandatory
0024h Hardware Defect Management	Mandatory	Mandatory
0050h HD DVD Read	Mandatory	-
0051h HD DVD Write	Mandatory	-
0100h Power Management	Mandatory	Mandatory
0105h Timeout	Mandatory	Mandatory
0107h Real-Time Streaming	Mandatory	Mandatory

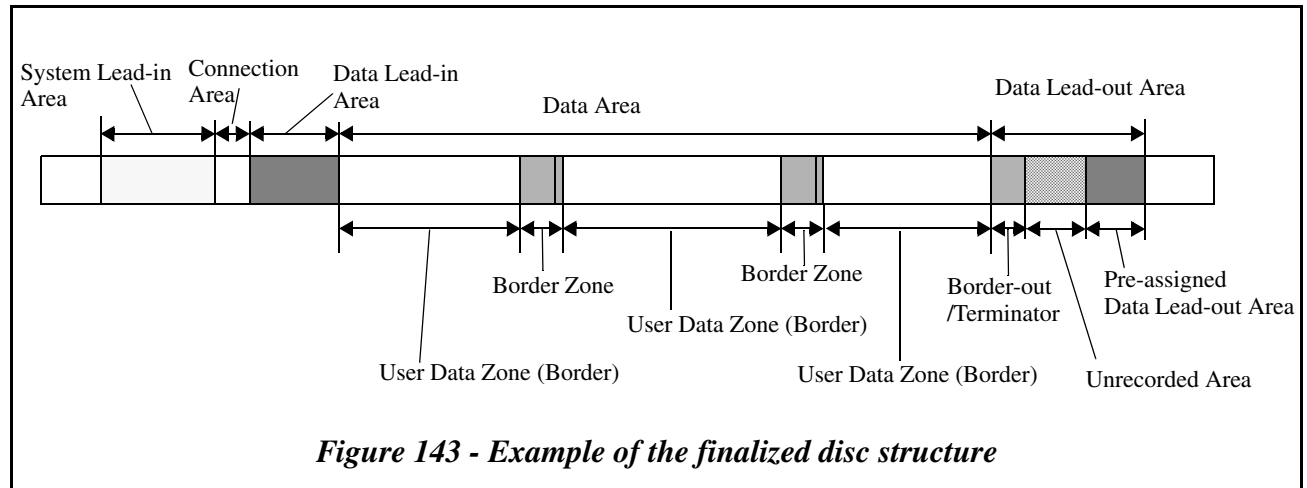
5.13 Recording for HD DVD-R Single Layer media

5.13.1 Basics for HD DVD-R vs. DVD-R

HD DVD-R is similar to DVD-R. It is a write-once media that in most cases will be readable by a HD DVD read-only logical unit.

5.13.2 HD DVD-R media Structure

Example of HD DVD-R media structure is shown in Figure 143.



5.13.2.1 RMZ (Recording Management Zone)

The RMZ consists of RMDs. There are three kinds of RMZs as follows:

1. RMZ in the Lead-in Area (L-RMZ)
This RMZ is used from the beginning of use of the disc.
2. Extended RMZ in the Border-in (B-RMZ)
This RMZ is an extension of the RMZ. The B-RMZ is used when an HD DVD-R disc has multi Border structure. The B-RMZ is created by CLOSE TRACK/SESSION Command.
3. Extended RMZ in the User Data Zone (U-RMZ)
This RMZ is an extension of the RMZ. The U-RMZ is created without closing Border by RESERVE TRACK Command.

5.13.2.1.1 RMD (Recording Management Data)

The RMD is 64 KBytes in length and is recorded as an ECC block. The RMD is recorded in L-RMZ, B-RMZ and U-RMZ. The L-RMZ size allows for 392 RMD updates. The B-RMZ size allows for 200 (inner), 150 (middle) or 100 (outer) RMD updates depending on the radial location of the Border Zone. The B-RMZ size is shown in Table 171. The U-RMZ size allows for 128 RMD updates.

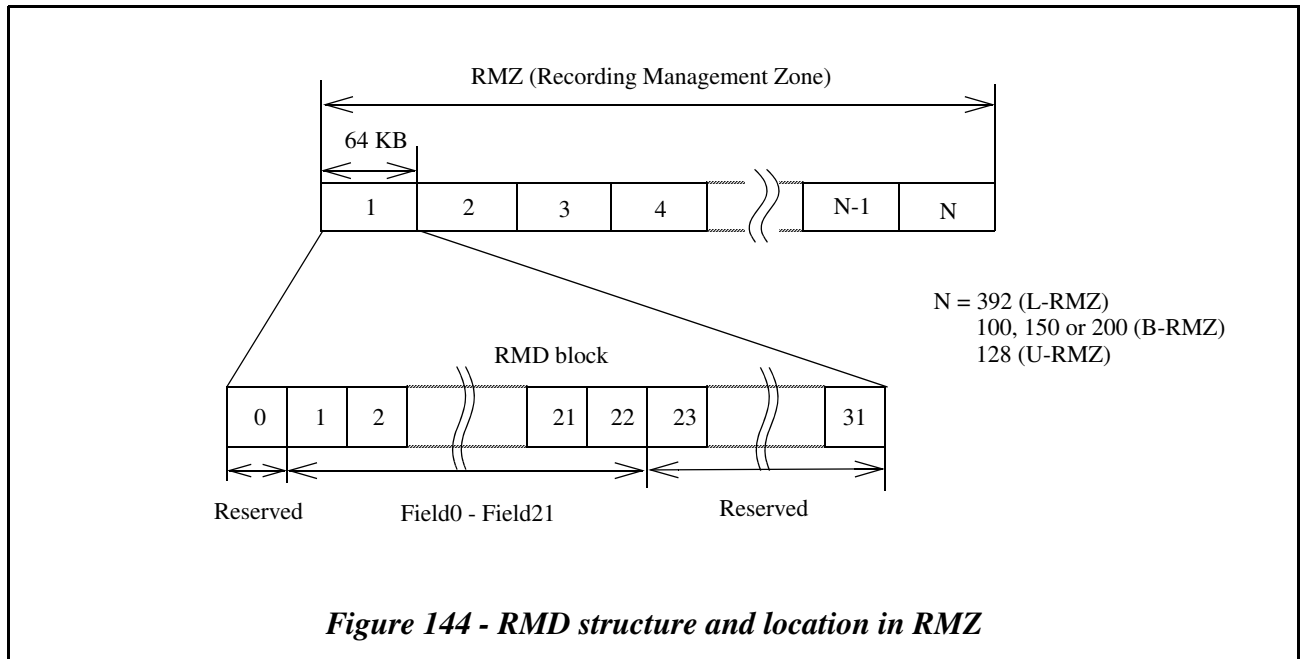


Table 171 - B-RMZ size for HD DVD-R media

The first PSN of a Border-zone	04FE00h to 1D0DFh	1D0E00h to 411BFFh	411C00h to -
Size (ECC block)	200	150	100

5.13.2.1.1.1 The contents of RMD

RMD contains 22 RMD Fields. The other sectors are reserved. Each RMD Field is 2 048 bytes in length.

5.13.2.1.1.2 RMD Field 0 (RMD Header)

RMD Field 0 specifies general information of the disc and is recorded as follows.

Table 172 - RMD - Field 0

Bit Byte	7	6	5	4	3	2	1	0
0-1	(MSB) RMD Format							(LSB)
2	Disc Status							
3	Reserved							
4-21	(MSB) Unique Disc ID							(LSB)
22-33	(MSB) Data Area allocation							(LSB)
34-45	(MSB) Renewed Data Area allocation							(LSB)
46-2 047	Reserved							

The RMD Format field specifies the RMD Format Code. The RMD Format Code indicates the recording format of the RMD.

These bytes are set to 0001h.

The Disc Status field indicates the disc status. Disc Status field is defined in Table 173.

Table 173 - Disc Status field definition

Value	Interpretation
0	To indicate that the disc has no written data in Data Recordable Area (only RMD is written)
1	Reserved
2	To indicate that the disc is recorded user data and not finalized
3	To indicate that the disc is finalized
4-255	Reserved

The Unique Disc ID field is recorded and structured as defined in Table 174. The Unique Disc Identifier contains time stamp fields. The time format should be UTC 24 hour clock¹. This field *shall* be set by the SEND DISC STRUCTURE command. This time stamp data sent by the SEND DISC STRUCTURE command may also be used in the OPC related field in RMD field 1 and may help the judgement to do OPC. The logical unit *shall* update the time stamp during power on. Strict accuracy of time is not required.

Table 174 - Unique Disc ID

Bit Byte	7	6	5	4	3	2	1	0
0-1	Reserved							
2-3	(MSB)	Random Data						(LSB)
4-7	(MSB)	Year						(LSB)
8-9	(MSB)	Month						(LSB)
10-11	(MSB)	Day						(LSB)
12-13	(MSB)	Hour						(LSB)
14-15	(MSB)	Minute						(LSB)
16-17	(MSB)	Second						(LSB)

The Random Data field is a random number.

The Year field specifies the year coded in ASCII in the range “0001” to “9999”.

The Month field specifies the month of the year coded in ASCII in the range “01” to “12”.

The Day field specifies the day of the month coded in ASCII in the range “01” to “31”.

The Hour field specifies the hour of the day coded in ASCII in the range “00” to “23”.

The Minute field specifies the minute of the hour coded in ASCII in the range “00” to “59”.

The Second field specifies the second of the minute coded in ASCII in the range “00” to “59”.

The Data Area allocation field is recorded and structured as defined in Table 175.

1. UTC = universal time coordinated

Table 175 - Data Area allocation

Bit Byte	7	6	5	4	3	2	1	0
22	00h							
23 -25	Start PSN of the Data Area (PSN = 30000h)							
26	00h							
27 - 29	Outer limit of Data Recordable area (PSN = 73543Fh)							
30	00h							
31 - 33	000000h							

The Renewed Data Area allocation field is recorded and structured as defined in Table 176.

Table 176 - Renewed Data Area allocation

Bit Byte	7	6	5	4	3	2	1	0
34	Renewal descriptor							
35-37	Start PSN of the Data Area (PSN = 30000h)							
38	00h							
39-41	Renewed outer limit of Data Recordable area (PSN = 73183Fh)							
42	00h							
43-45	000000h							

Renewal descriptor field specifies the existence of the Extended drive test zone, defined in Table 177.

Table 177 - Renewal descriptor

Value	Interpretation
0	The Extended drive test zone does not exist
1	The Extended drive test zone exists
2-255	Reserved

5.13.2.1.1.3 RMD Field 1

RMD Field 1 contains some logical unit and OPC related information and is recorded as defined in Table 178. There are four sets of OPC data blocks. The OPC related information of the present logical unit is always recorded in the field #1. If the field #1 of the current RMD does not contain the present logical unit information, which consists of Drive manufacturer ID, Serial number and Model number, the information in the field #1 to #3 of the current RMD is copied to the field #2 to #4 of the new RMD and the information in the field #4 of the current RMD is discarded. If the field #1 of the current RMD contains the present drive information, the information of the field #2 to #4 of the new RMD. In every case, the unused fields of the RMD Field1 is set to 00h.

Table 178 - RMD - Field 1 (logical unit and OPC information)

Bit Byte	7	6	5	4	3	2	1	0
0-31	Drive manufacturer ID#1							
32-47	Serial Number #1							
48-63	Model Number #1							
64-71	Time stamp #1							
72-75	Inner Drive test zone address #1							
76-79	Outer Drive test zone address #1							
80-103	Running OPC Information #1							
104-105	DSV #1							
106-127	Reserved #1							
128-191	Drive specific data #1							
192-255	Reserved #1							
256-287	Drive manufacturer ID #2							
288-303	Serial Number #2							
304-319	Model Number #2							
320-327	Time stamp #2							
328-331	Inner Drive test zone address #2							
332-335	Outer Drive test zone address #2							
336-359	Running OPC Information #2							
360-361	DSV #2							
361-383	Reserved #2							
384-447	Drive specific data #2							
448-511	Reserved #2							
:	:							
768-799	Drive manufacturer ID#4							
800-815	Serial Number #4							
816-831	Model Number #4							
832-839	Time stamp #4							
840-843	Inner Drive test zone address #4							
844-847	Outer Drive test zone address #4							
848-871	Running OPC Information #4							
872-873	DSV #4							
874-895	Reserved #4							
896-959	Drive specific data #4							
960-1 023	Reserved #4							
1 024-1 279	Drive specific data #1							
1 280-1 535	Drive specific data #2							
1 536-1 791	Drive specific data #3							
1 792-2 047	Drive specific data #4							

The Drive manufacturer ID #n field is recorded in binary and specifies unique drive manufacturer identifier of the logical unit.

The Serial Number #n field is recorded as ASCII code and specifies serial number of the logical unit.

The Model Number #n field is recorded as ASCII code and specifies the recorder model number.

The **Timestamp #n** field may be used to store date and time when OPC is performed. This field, if used, is recorded in binary. If this field is set to 0, this field is invalid.

The **Inner Drive test zone #n** field is recorded in binary and specifies the start ECC block address of the Drive test zone in the Data Lead-in Area where the last power calibration is performed. If these fields are set to 00h, then they are invalid.

The **Outer Drive test zone #n** field is recorded in binary and specifies the start ECC block address of the Drive test zone in the Data Lead-out Area where the last power calibration is performed. If these fields are set to 00h, then they are invalid.

The **Running OPC Information #n** field may be used to specify values concerning running OPC. The format is vendor-specific. If this field is set to 0, this field is invalid.

If the disc is incrementally recorded and when RMD is updated, the **DSV** field is recorded. This field is used to specify the last DSV (Digital Sum Value) in binary notation. If this field is set to 0, this field is invalid.

The **Drive specific data #n** field may be used to store the drive specific data. If these fields are set to 00h, then they are invalid.

5.13.2.1.1.4 RMD Field 2

RMD Field 2 can be used freely and format of this field is user-specific.

Table 179 - RMD - Field 2 (User Specific Data)

Bit Byte	7	6	5	4	3	2	1	0
0-2 047	(MSB) User Specific Data							(LSB)

The User Specific Data field is available for user specific data. This field may be used, otherwise this field is set to 0.

5.13.2.1.1.5 RMD Field 3

RMD Field 3 may contains Border Zone information and is recorded as follows.

Table 180 - RMD - Field 3 (Border Zone Information)

Bit Byte	7	6	5	4	3	2	1	0
0-3	(MSB)	Start PSN of Border-out #1						(LSB)
4-7	(MSB)	Start PSN of Border-out #2						(LSB)
:		:						
508-511	(MSB)	Start PSN of Border-out #128						(LSB)
512-513	(MSB)	Open RMZ number						(LSB)
514-527	Reserved							
528-531	(MSB)	Start PSN of B/U-RMZ #1						(LSB)
532-535	(MSB)	Size of B/U-RMZ #1						(LSB)
536-539	(MSB)	Start PSN of B/U-RMZ #2						(LSB)
540-543	(MSB)	Size of B/U-RMZ #2						(LSB)
:		:						
1 536-1 539	(MSB)	Start PSN of B/U-RMZ #127						(LSB)
1 540-1 543	(MSB)	Size of B/U-RMZ #127						(LSB)
1 544-2 047	(MSB)	Reserved						(LSB)

The Start PSN of Border-out #n field, if it contains other than 0, indicates that the start PSN of the Border-out.

The Open B/U-RMZ number field indicates B-RMZ number or U-RMZ number where the latest RMD is recorded.

The Start PSN of B/U-RMZ #n field, if it contains other than 0, indicates that the start PSN of the B-RMZ or U-RMZ.

The Size of B/U-RMZ #n field, if it contains other than 0, indicates that the size of the B-RMZ or U-RMZ.

Note: (1) The maximum number of Border-out is prescribed by the times which RMD is updated in RDZ, because RMD shall be updated in RDZ when the Border-out is newly created. The maximum number which RMD is updated in RDZ is 127. In addition, when the disc is finalized, Border-out is created without updating RMD in RDZ. Therefore, 128 of the total number is the maximum number of Border-out. B-RMZ is also created when Border-out is created without disc finalization. And also RMD shall be updated in RDZ when U-RMZ is newly assigned. Therefore, the maximum number of U-RMZ is 127. Because RDZ is commonly used within those updates, each upper limit of RMD updates is changed by the other RMD updates in RDZ. After a new RMZ is created, RMZ which is used till then become not available. The pointer for the RMD update shall be only one in the disc.

(2) When Border-out is created, the position of the next Border-in is decided without the finalization. Therefore, the available address for B-RMZ in the next Border-in is decided.

5.13.2.1.1.6 RMD Field 4

RMD Field 4 contains RZone related information and is recorded as follows.

Table 181 - RMD - Field 4 (RZone Information)

Bit Byte	7	6	5	4	3	2	1	0
0-1	(MSB)	Invisible/Incomplete RZone Number (last RZone number)						(LSB)
2-3	(MSB)	First Open RZone number						(LSB)
4-5	(MSB)	Second Open RZone number						(LSB)
6-15	Reserved							
16-19	(MSB)	Start PSN of RZone #1						(LSB)
20-23	(MSB)	Last Recorded PSN of RZone #1						(LSB)
24-27	(MSB)	Start PSN of RZone #2						(LSB)
28-31	(MSB)	Last Recorded PSN of RZone #2						(LSB)
:	:							
2 032-2 035	(MSB)	Start PSN of RZone #253						(LSB)
2 036-2 039	(MSB)	Last Recorded PSN of RZone #253						(LSB)
2 040-2 043	(MSB)	Start PSN of RZone #254						(LSB)
2 044-2 047	(MSB)	Last Recorded PSN of RZone #254						(LSB)

The Invisible/Incomplete RZone Number field contains the Invisible/Incomplete RZone number of the medium. If the last RZone state is neither Invisible nor Incomplete due to disc finalization, this field contains the last Complete RZone number.

The First Open RZone Number field, if recorded with value other than 0, contains the current appendable Reserved RZone number and the value is different from the Second Open RZone Number field. If this field is set to 0, there is no Empty reserved RZone or Partially recorded reserved RZone corresponding to this field.

The Second Open RZone Number field, if recorded with value other than 0, contains the current appendable Reserved RZone number and the value is different from the First Open RZone Number field. If this field is set to 0, there is no Empty reserved RZone or Partially recorded reserved RZone corresponding to this field.

When the Incomplete RZone is closed, the Invisible/Incomplete RZone Number field contains the number of the new Invisible RZone number (N+1). When Reserved RZone is closed, the corresponding First (Second) Open RZone number field shall be set to 0.

The Start PSN of RZone #n field contains the start PSN of the RZone which has RZone number #n.

The Last Recorded PSN of RZone #n field contains the last recorded PSN of the RZone which has RZone number #n. If this field is set to 0, this field is not valid. If RZone #n is not closed, the value of this field may not be correct and logical unit *shall* search the correct LRA by the other method.

When RZone is closed, this field contains the last PSN of the data except the padding data in the RZone.

Note: The LRA information in the latest RMD may not be correct. Host is able to get the correct LRA by the READ TRACK INFORMATION command. In this case, logical unit reports the correct LRA not by using the latest RMD. See number 7 in Table 183 - Mandatory RMD update condition in RMZ on page 341.

5.13.2.1.1.7 RMD Field 5-Field 21

RMD Field 5 through Field 21 may contain RZone related information continued from RMD Field 4.

Table 182 - RMD - Field 5-Field 21 (RZone Information ... continued)

Bit Byte	7	6	5	4	3	2	1	0
0-3	(MSB) Start PSN of RZone #n							(LSB)
4-7	(MSB) Last Recorded PSN of RZone #n							(LSB)
8-11	(MSB) Start PSN of RZone #(n+1)							(LSB)
12-15	(MSB) Last Recorded PSN of RZone #(n+1)							(LSB)
:	:							
2 032-2 035	(MSB) Start PSN of RZone #(n+254)							(LSB)
2 036-2 039	(MSB) Last Recorded PSN of RZone #(n+254)							(LSB)
2 040-2 043	(MSB) Start PSN of RZone #(n+255)							(LSB)
2 044-2 047	(MSB) Last Recorded PSN of RZone #(n+255)							(LSB)

The Start PSN of RZone #n field contains start PSN of the RZone which has RZone number #n.

The Last Recorded PSN of RZone #n field contains the last recorded PSN of the RZone which has RZone number #n. If this field is set to 0, this field is not valid. If RZone #n is not closed, the value of this field may not be correct and logical unit *shall* search the correct LRA by the other method.

When the RZone is not closed, even if the Last Recorded PSN of RZone #n field contains a value, the logical unit determines the current LRA of the RZone. When RZone is closed, this field contains the last PSN of the data except the padding data in the RZone.

Note: The LRA information in the latest RMD may not be correct. Host can get the correct LRA by the READ TRACK INFORMATION command. In this case, logical unit reports the correct LRA not by using the latest RMD. See number 7 in Table 183 - Mandatory RMD update condition in RMZ on page 341.

5.13.2.1.2 Update timing of RMD in RMZ

To keep the disc interchangeability, information related to RZone, Border Zone, RMZ and Test Zone structures *shall* be updated in cached RMD. The cached RMD *shall* be written on the disc in the conditions described in Table 183.

Table 183 - Mandatory RMD update condition in RMZ

Condition
Condition 1. When a RESERVE TRACK command with RMZ bit =0 is issued, RMD <i>shall</i> be written in RMZ.
Condition 2. When a CLOSE TRACK/SESSION command with Close Function field = 001b or 010b is issued, RMD <i>shall</i> be written in RMZ. Then when the command indicates to close Border, all unrecorded ECC blocks in RMZ <i>shall</i> be padded with the latest RMD.
Condition 3. When a CLOSE TRACK/SESSION command with Close Function field = 110b is issued (except indicating to record Terminator), RMD <i>shall</i> be written in RMZ. All unrecorded ECC blocks in RMZ <i>shall</i> be padded with the latest RMD.
Condition 4. When a RESERVE TRACK command with RMZ bit =1 is issued, RMD <i>shall</i> be written in RMZ. All unrecorded ECC blocks in RMZ <i>shall</i> be padded with the latest RMD.
Condition 5. When a FORMAT UNIT command with format type = 16h is issued, RMD <i>shall</i> be written in RMZ.
Condition 6. When an OPC operation is done, RMD <i>shall</i> be updated prior to medium ejection or entering the sleep state.
Condition 7. When the difference between the last recorded sector number in fact and “Last Recorded Address of RZone #n” recorded in the latest RMD is larger than 16 MB (2000h sectors) ^a , RMD <i>shall</i> be written in RMZ. However if the logical unit is busy (e.g., writing is in progress), the update may be done at a later time.

- a. To force updating the RMD, the host should close the Incomplete RZone.

By using RMD caching, the logical unit can avoid waste of RMZ. The latest RMD *shall* be written in RMZ prior to removing the disc from the logical unit, when the contents of the cached RMD is different from the contents of the latest RMD on the disc. But when the difference between the last recorded sector number in fact and “Last Recorded Address of RZone #n” recorded in the latest RMD is less than 16 MB (2000h sectors), there is no need for writing the cached RMD on the disc.

In the case of condition 6 and condition 7 in Table 183, when the number of the unrecorded ECC blocks in Current RMZ is less than or equal to 8, RMD *shall not* be written except for the disc removal.

The error reporting for RMZ exhaustion by each command that may change the RMD in each condition of the media is shown in Table 189 through Table 199.

5.13.2.1.3 Update timing of RMD in RDZ

When U-RMZ or B-RMZ is newly created, logical unit *shall* write the latest RMD into RDZ. RDZ Lead-in *shall* be written before writing the first RMD in L-RMZ.

Table 184 - Mandatory RMD update condition in RDZ

condition
When a CLOSE TRACK/SESSION command with Close Function field = 010b is issued, RMD <i>shall</i> be written in RDZ.
When a RESERVE TRACK command with RMZ bit =1 is issued, RMD <i>shall</i> be written in RDZ.

5.13.2.1.4 Example of write sequence

This section explains one example of a write sequence. See Table 185 and Table 186.

Table 185 - Example of write sequence (blank disc)

Sequence	user/host	logical unit action
1	Insert blank disc	check RMD
2	Unique Disc Identifier (SEND DISC STRUCTURE commands)	cache (RMD Field 0)
3	Specify other Identifier field. (SEND DISC STRUCTURE command)	cache (RMD Field 1)
4	Specify User Specific Data field of RMD if needed. (SEND DISC STRUCTURE command)	cache (RMD Field 2)
5	Reserve RZones (RESERVE TRACK command)	1. do OPC. 2. write RDZ Lead-in 3. write RMD in RMZ
6	get NWA (READ TRACK INFORMATION command)	calculate and send to host
7	start writing from NWA (WRITE (10) command or WRITE (12) com- mand)	start writing
8	close RZone or Border (CLOSE TRACK/SESSION command)	in case of closing RZone - write RMD in RMZ - pad RZone in case of closing Border - write RMD in RMZ - pad with latest RMD until the end of RMZ - write RMD in RDZ - write Border-in/Data Lead-in and Border-out

Table 186 - Example of write sequence (non-blank disc)

	user/host	logical unit action
1	Insert non-blank disc	check RMD
2	Specify User Specific Data field of RMD if needed. (SEND DISC STRUCTURE command)	cache (RMD Field 2)
3	Reserve RZones. (RESERVE TRACK command)	1. do OPC. 2. write RMD in RMZ
4	get NWA (READ TRACK INFORMATION command)	search and send to host
5	start writing from NWA (WRITE (10) command or WRITE (12) command)	start writing
6	close RZone or Border (CLOSE TRACK/SESSION command)	in case of closing RZone - write RMD in RMZ - pad RZone in case of closing Border - write RMD in RMZ - pad with latest RMD until the end of RMZ - write RMD in RDZ - write Border-in/Data Lead-in and Border-out

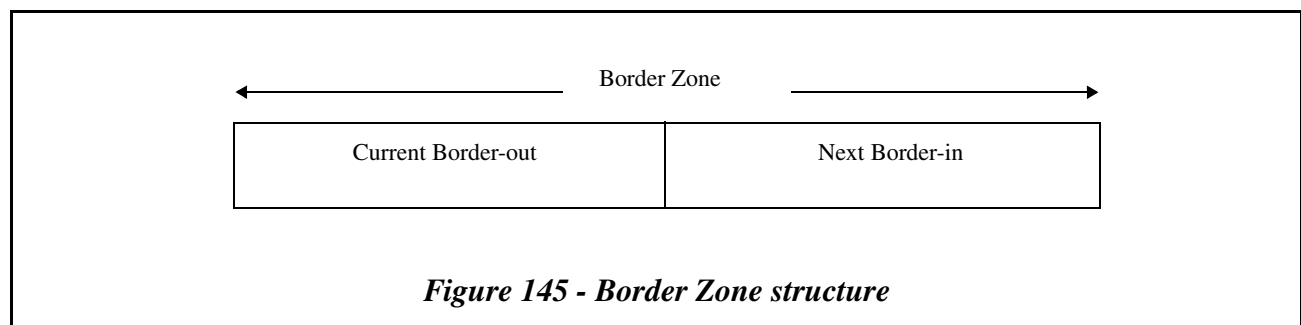
5.13.2.2 Border zone

A Border zone consists of a Border-out and a Border-in.

The purpose of the Border Zone is for the HD DVD read-only logical unit to be able to read HD DVD-R media by providing Border-in and Border-out to prevent pickup overrun.

Once Border is closed, there are no unrecorded areas between Data Lead-in/Border-in and Border-out.

Border Zone structure is shown in Figure 145



5.13.2.2.1 Border size and length

The first Border-out start address *shall* be located after LBA 01FE00h. If a CLOSE TRACK/SESSION command with Close Function field = 010b, 110b is issued when recorded user data end address is less than PSN 04FE00h, the logical unit *shall* pad with 00h data through PSN 04FDFFh.

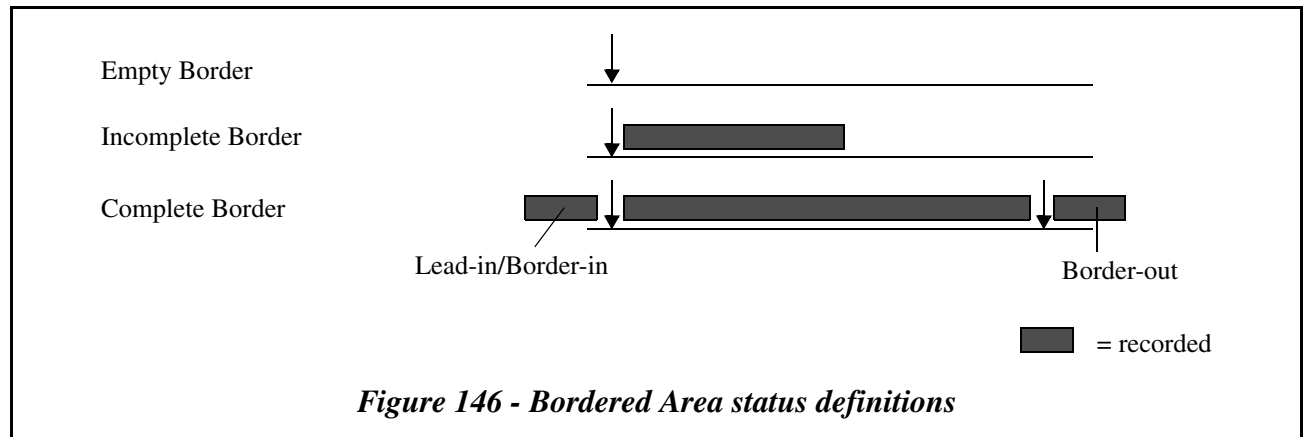
Border Zone size is dependent on its starting address and order. See Table 187.

Table 187 - Border Zone size for HD DVD-R media

The first LBA of a Border-out	01FE00h to 1A0DFFh	1A0E00h to 3E1BFFh	3E1C00h to -
Border-out size	290 ECC blocks	380 ECC blocks	480 ECC blocks
Border-in size	207 ECC blocks	157 ECC blocks	107 ECC blocks

5.13.2.2.2 Border Zone status

Bordered Area status changes according to its recording stage.

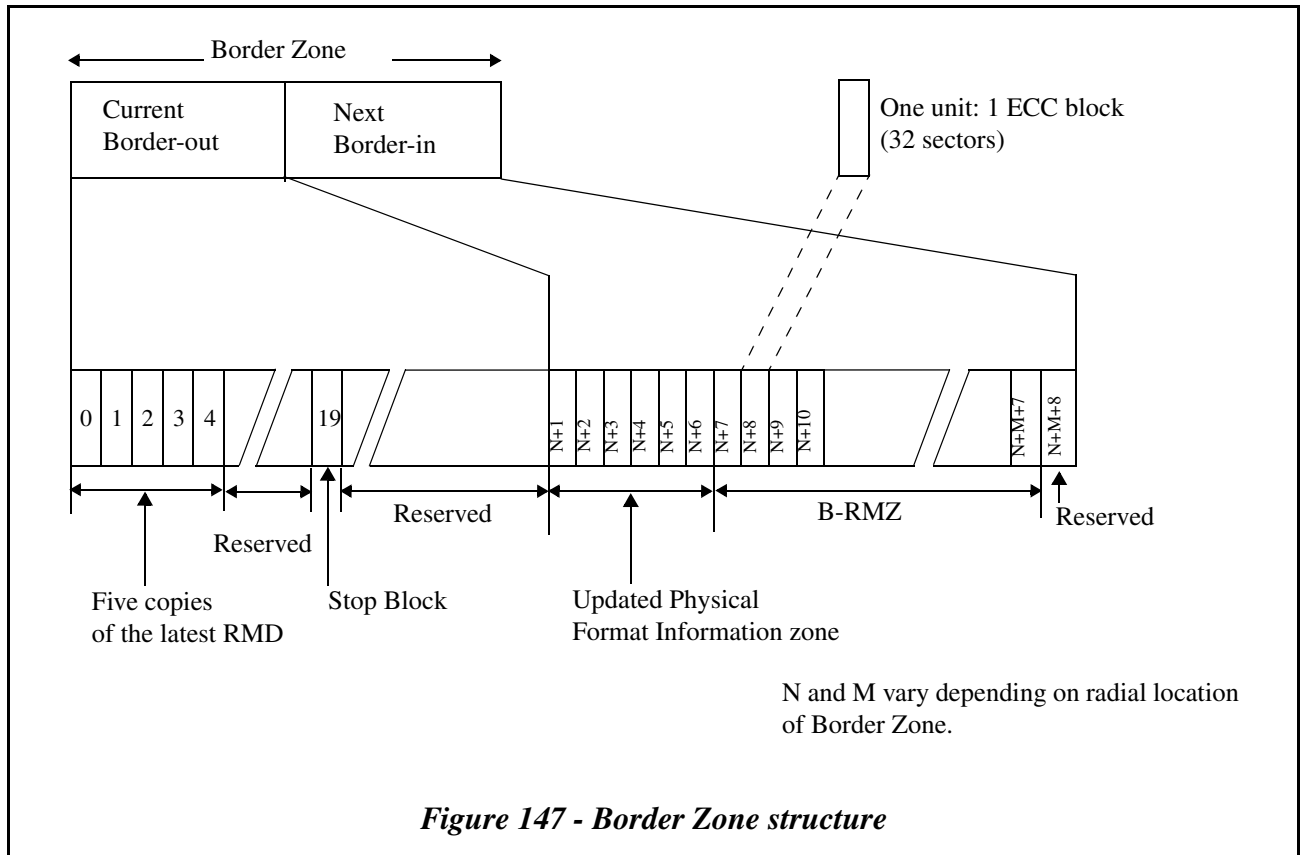


5.13.2.2.3 Border-in contents

Border-in consists of Updated Physical Format Information, B-RMZ and a reserved ECC block. The Updated Physical Format Information is an update of the R-Physical Format Information that contains start address of the next Border at that time and is recorded in six ECC blocks repeatedly. B-RMZ contains ECC blocks for RMDs. The size of B-RMZ depends on its radial location. The last ECC block of Border-in is reserved to separate the B-RMZ from the following RZone.

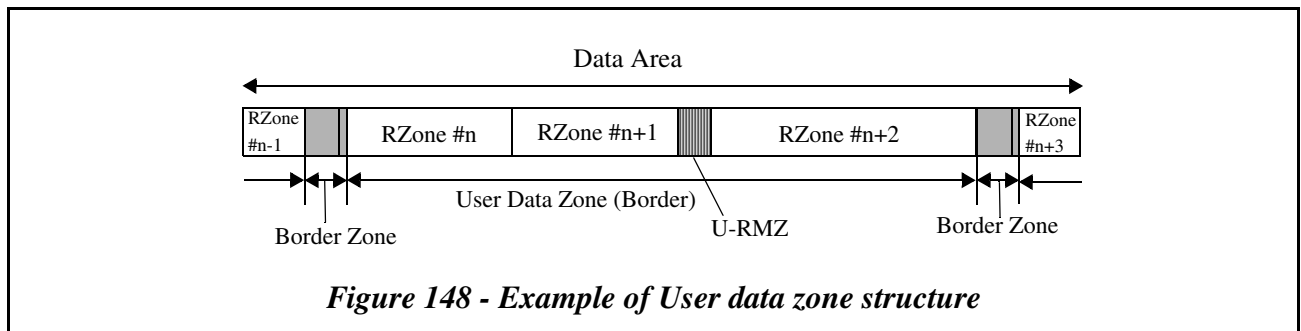
5.13.2.2.4 Border-out contents

Border-out consists of five copies of the latest RMD, a Stop Block and reserved ECC blocks. The Stop Block is an ECC block to provide means for detection of the Border-out. It is located at the 20th ECC block from the beginning of the Border-out. The reserved ECC blocks are placed to make the Border-out size appropriate to prevent the optical pick up over-run. The whole structure of Border Zone is shown in Figure 147.



5.13.2.3 User Data Zone

User Data Zone is allocated between Data Lead-in/Border-in and Data Lead-out/Border-out. User Data Zone consists of RZone and U-RMZ, if it exists.



5.13.2.3.1 RZone

The RZone is a limited area to record user data. The RZone status is changed according to its recording stage. These status are named as shown in Figure 149 below.

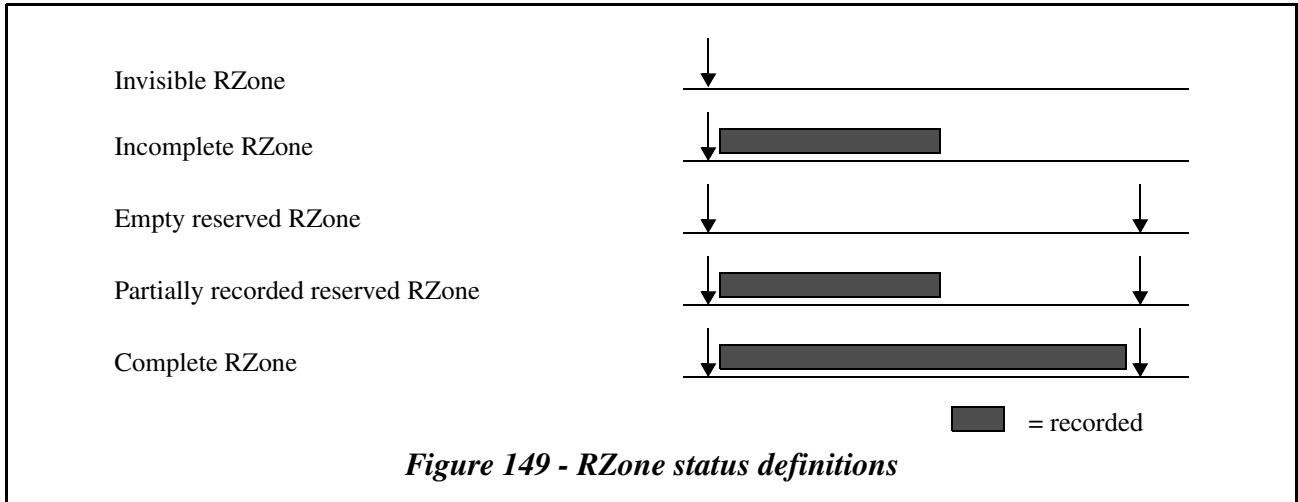


Figure 149 - RZone status definitions

Invisible/Incomplete RZone: These RZones only have a start address. End address is not defined. These kinds of RZones are always located on the outermost portion of the media and are data appendable.

Empty reserved RZone/Partially recorded reserved RZone: These RZones have a start address and end address. These kinds of RZones are always data appendable.

Complete RZone: The RZone is closed or completely filled with data. This kind of RZone has no NWA and is not data appendable.

5.13.2.3.2 U-RMZ

The size of U-RMZ is 128 ECC blocks. The method of creating U-RMZ is described in 5.13.7, "RMZ extension" on page 352.

5.13.2.4 Additional Zones for the disc finalization

Border-out with Area Type of Data Lead-out or Terminator is recorded just after the Data Area for the disc finalization. By recording either Border-out with Area Type of Data Lead-out or Terminator, Data Lead-out Area begins.

5.13.2.4.1 Border-out with Area Type of Data Lead-out

This Border-out is recorded with an intention of finalizing. The Area type is 10b (Data Lead-out). The size of this Border-out is equivalent to other Border-out and varies depending on its radial location. See Table 187 - "Border Zone size for HD DVD-R media" on page 344. The minimum LBA of the Border-out *shall* be larger than 01FE00h.

5.13.2.4.2 Terminator

Terminator is recorded immediately after Border-out with Area Type of Data Area. The Area type is 10b (Data Lead-out). The size of Terminator is equivalent to Border-out and varies depending on its radial location. See Table 188.

Table 188 - Terminator size for HD DVD-R media

The first PSN of a Terminator	04FE00h to 1D0DFFh	1D0E00h to 411BFFh	411C00h to -
Size	290 ECC blocks	380 ECC blocks	480 ECC blocks

5.13.3 Recording model for HD DVD-R media

Recording mode for HD DVD-R is only incremental. Disc at once recording mode is not defined in the physical specification. In case of DVD-R, linking sector is necessary. But in case of recording HD DVD-R, linking sector is not necessary (lossless linking).

5.13.3.1 Sequential recording

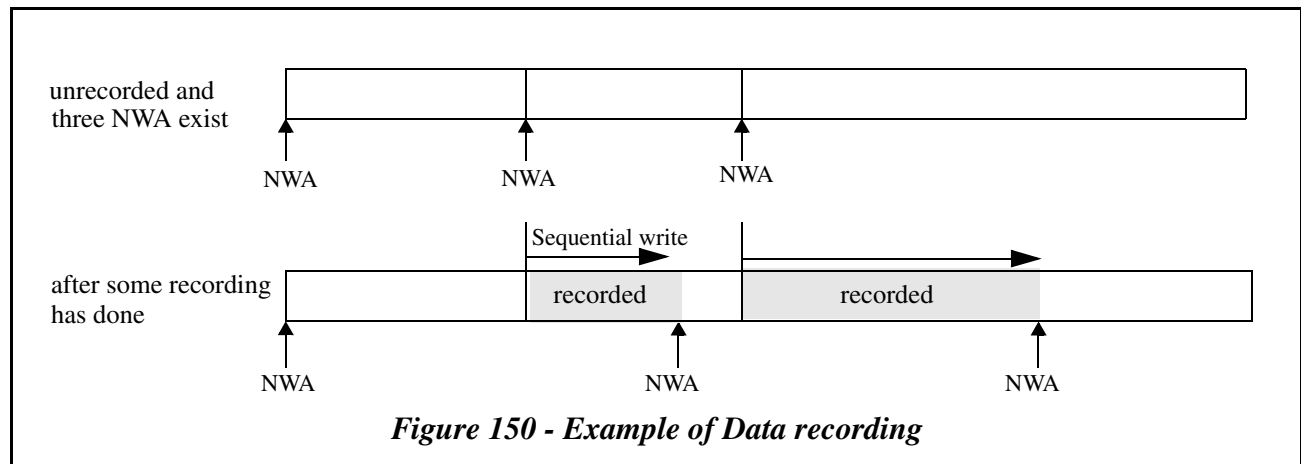
HD DVD-R media makes use of sequential recording. This type of recording does not permit random access for recording purposes. Recording may only occur at predefined recording (appendable) points.

Multiple Appendable points may exist within management areas for sequential recording. The data *shall* be written sequentially from each appendable point.

5.13.4 Data recording

In case of Data recording, user data is written sequentially from each NWA. A variable amount of user data is written at several distinct times. An overwriting is inhibited.

For HD DVD-R media to be readable by HD DVD read-only logical units, the media *shall* contain a Lead-in and a Lead-out or Border-out.



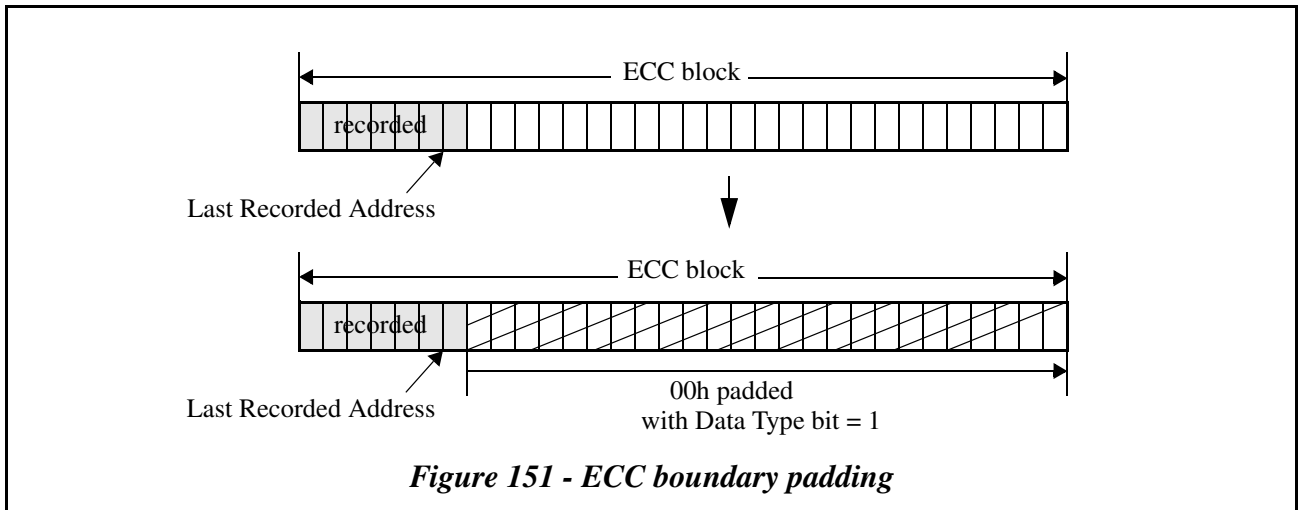
5.13.4.1 ECC boundary padding and Data Type bit in ID field

The logical unit writes data to the medium only when multiple ECC data blocks are received or the SYNCHRONIZE CACHE (10) command is issued. When the SYNCHRONIZE CACHE (10) operation has been done and the last recorded data address is not an address of the last sector of an ECC block, the logical unit *shall* pad to the ECC block boundary with value 00h with Data Type bit = 1. See Figure 151.

The Last Recorded Address is the address of the last block of user data. The ECC padding *shall not* affect the Last Recorded Address.

Note: The READ TRACK INFORMATION command is used to get the Last Recorded Address of the RZone.

A SYNCHRONIZE CACHE (10) command may be used to mark the end of the Write data stream.



5.13.5 RZone recording

5.13.5.1 RZone reservation

5.13.5.1.1 Limitation for number of reserved RZones

A part of the disc space can be reserved as an RZone. For HD DVD-R, the maximum number of RZones which can be reserved at the same time is two. In other words, the maximum number of data appendable RZones is three (2 Reserved RZone + 1 Invisible/Incomplete RZone). If two RZones are already reserved, no more RZones can be reserved. To reserve a new RZone, either one or both of the current reserved RZones *shall* be closed. Once closed, a new RZone can be reserved.

The RESERVE TRACK command is used to reserve RZones. If attempting to reserve an RZone when two RZones are already reserved, the command *shall* be terminated with CHECK CONDITION Status, 5/72/05 NO MORE RZONE RESERVATIONS ARE ALLOWED.

Attempting to reserve an RZone when ECC blocks in the RMZ remain less than certain values, the command may be terminated with several errors depending on how many ECC blocks remain in the current RMZ and RDZ. See *Table 191 - "Error reporting for "RZone reservation" by using RESERVE TRACK command"* on page 361.

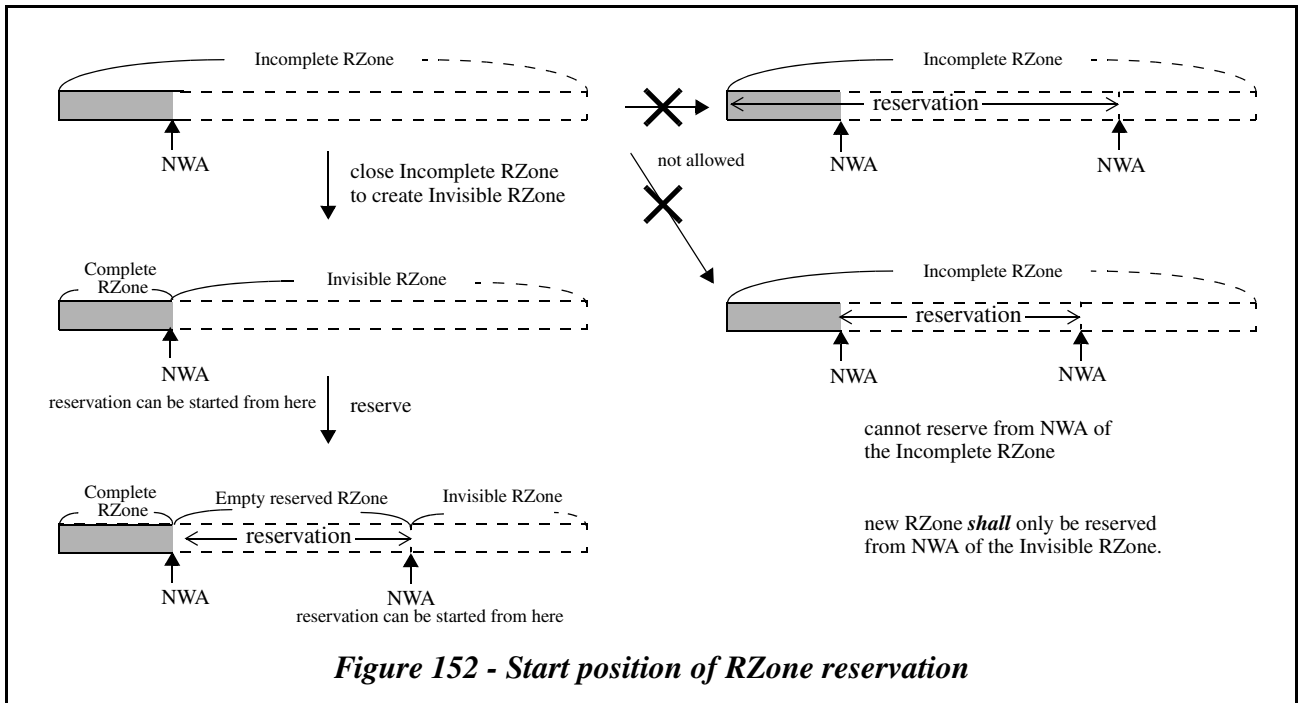
5.13.5.1.2 RZone numbering

The RZone numbers *shall* start from 1. The number of the Invisible RZone is increased by one following a reservation. After the reservation is done, the RZone number given to the new reserved RZone is the RZone number of the old Invisible RZone that existed before the reservation.

5.13.5.1.3 RZone reservation scheme

RZone *shall* only be reserved from the NWA of the Invisible RZone. If an Incomplete RZone exists, the Incomplete RZone *shall* be closed prior to reserving a new RZone. The start address of the new Invisible RZone is the NWA of the previous Incomplete RZone.

When reservation is required, the logical unit *shall* allocate the RZone in the Data Recordable Area. The allocated reserved length is rounded up the length to ECC block unit.

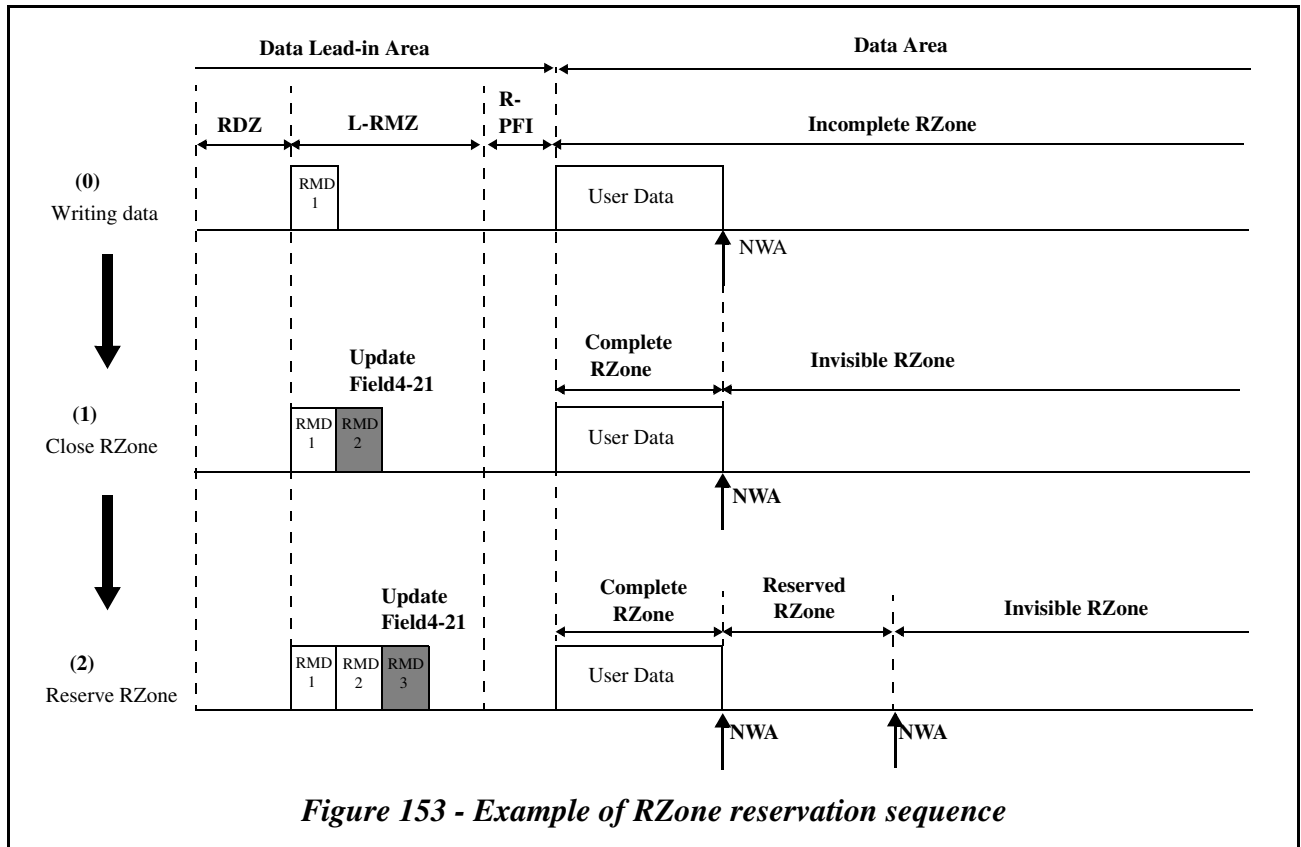


5.13.5.1.4 Sample sequence for RZone reservation

An example of RZone reservation sequence is shown in Figure 153. Initially, a blank medium has only an Invisible RZone. NWA is LBA 0. When a write operation has begun without a reservation, the NWA is proportionally incremented by written data length (reference 0).

If reservation is required, then the Incomplete RZone **shall** be closed and RMD is updated (reference 1). Then a new Invisible RZone is created. The new reserved RZone is allocated from the NWA of the Invisible RZone and RMD is updated (reference 2).

Note: RDZ Lead-in shall be written before writing the first RMD in L-RMZ.



5.13.5.2 RZone closing

This section explains what *shall* be done by a logical unit when an RZone is closed.

When a Reserved RZone is closed:

- Logical unit *shall* write RMD in the current RMZ.
- The logical unit *shall* pad 00h data until the end of the Reserved RZone with Data Type bit = 1.

When an Incomplete RZone is closed:

- Logical unit *shall* write RMD in the current RMZ.

There are four purposes of closing an Incomplete RZone:

- To reserve a new RZone
- To create a new U-RMZ
- To close Border
- To make the logical unit write an RMD in RMZ for backup against error.

When an Invisible RZone is closed, nothing is done by the logical unit.

5.13.6 Border zone recording

After Border zone is recorded, the Bordered Area in the HD DVD-R media can be read by the HD DVD read-only logical unit.

Each logical sector in Border Zone *shall* be assigned to a LBA. Each logical sector of Data Recordable Area *shall* be identified by a unique logical sector number. LBAs *shall* be integers assigned in ascending sequence, starting with 0 from the PSN 30000h.

A Border Zone consists of a Border-out and a Border-in. Border-out/in is written when a CLOSE TRACK/SESSION command is issued with Close Function field = 010b.

Border Zone is recorded with following sequence.

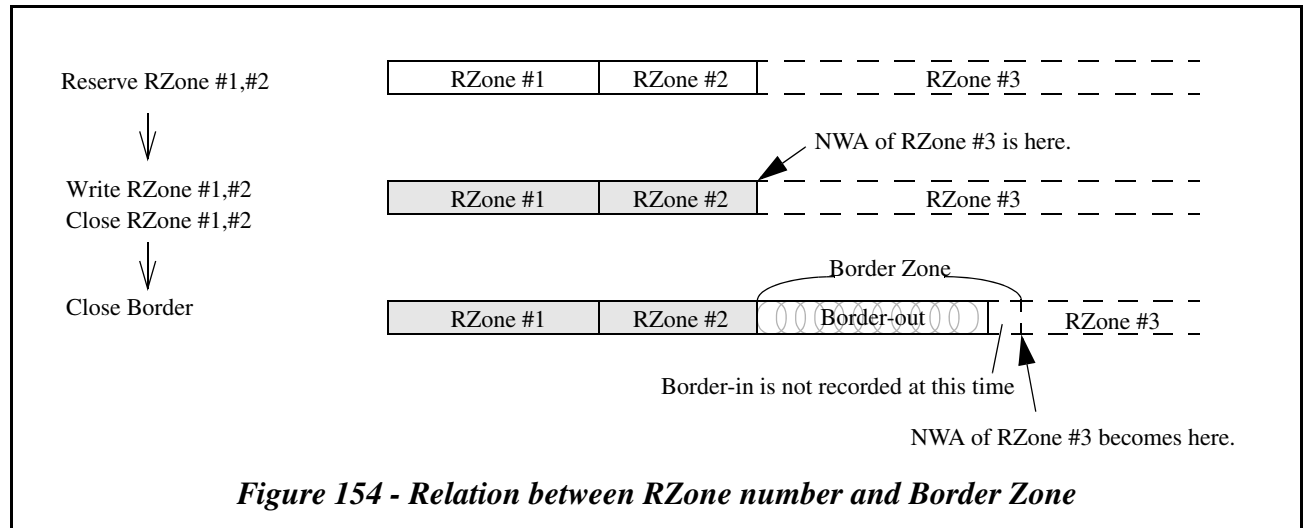
1. Close all opened (Empty reserved/Partially recorded reserved/Incomplete) RZones by using a CLOSE TRACK/SESSION command with the Close Function field = 001b.
2. Issue CLOSE TRACK/SESSION command to close Bordered Area (Close Function = 010b).
3. Border-out is recorded from NWA of the Invisible RZone. Border-in of this Border Zone is still unrecorded at this time. The Border-in will be completely recorded when next CLOSE TRACK/SESSION command is issued.
4. If Data Lead-in is still unwritten, Data Lead-in is recorded on the medium. If Lead-in is already written, Border-in is recorded after the previously written Border-out.

When a CLOSE TRACK/SESSION command with Close Function field = 010b is issued, Border Zone *shall* be written from ECC block boundary.

If Border Zone start LBA is less than 1FE00h, logical unit *shall* pad with 00h data up to LBA 1FDFFh. RZone numbers are not assigned to Border Zone. The Invisible RZone number is not incremented due to Border Zone writing.

After Border Zone writing, NWA of the Invisible RZone is moved to the following written Border Zone. Figure 154 shows an example of the write sequence and relationship between RZone number and Border Zone.

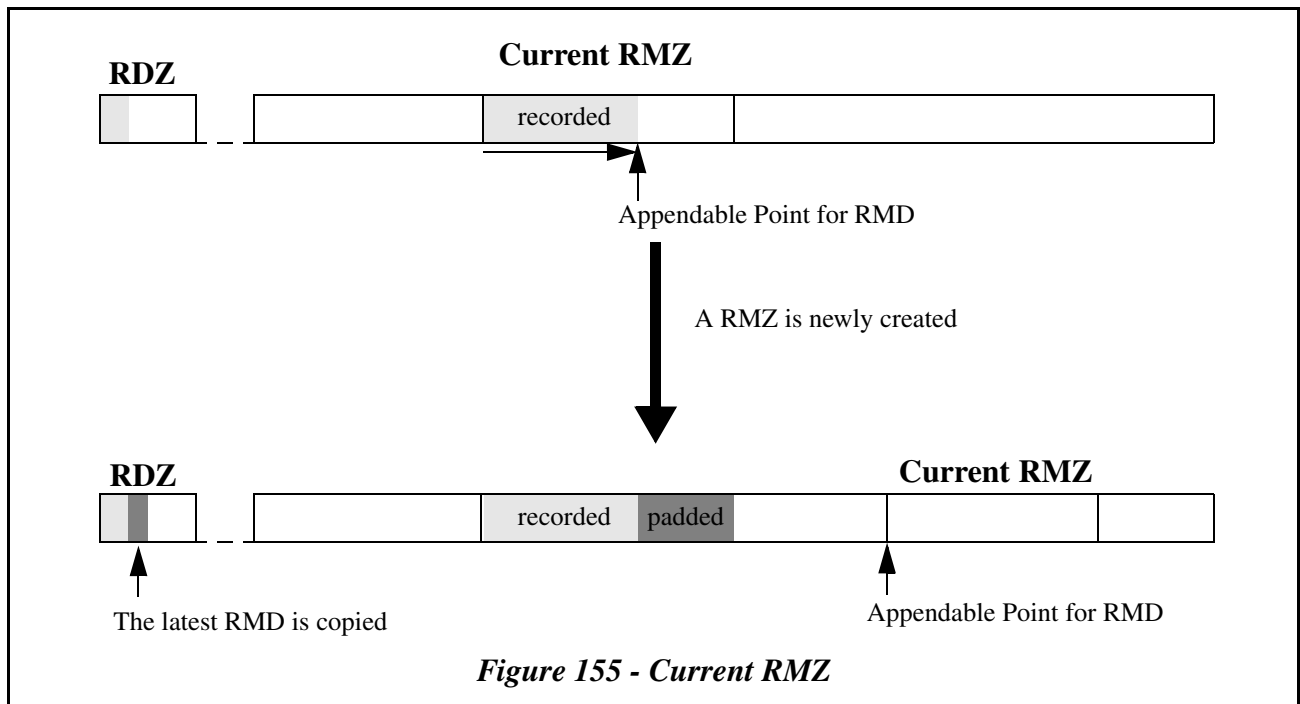
The Border-in which immediately follows last Border-out *shall* remain unrecorded when the Border Zone is written. This unrecorded Border-in will be used for next Border. The unrecorded Border-in will be recorded when the next Border is closed.



5.13.7 RMZ extension

5.13.7.1 RMZ Extension scheme

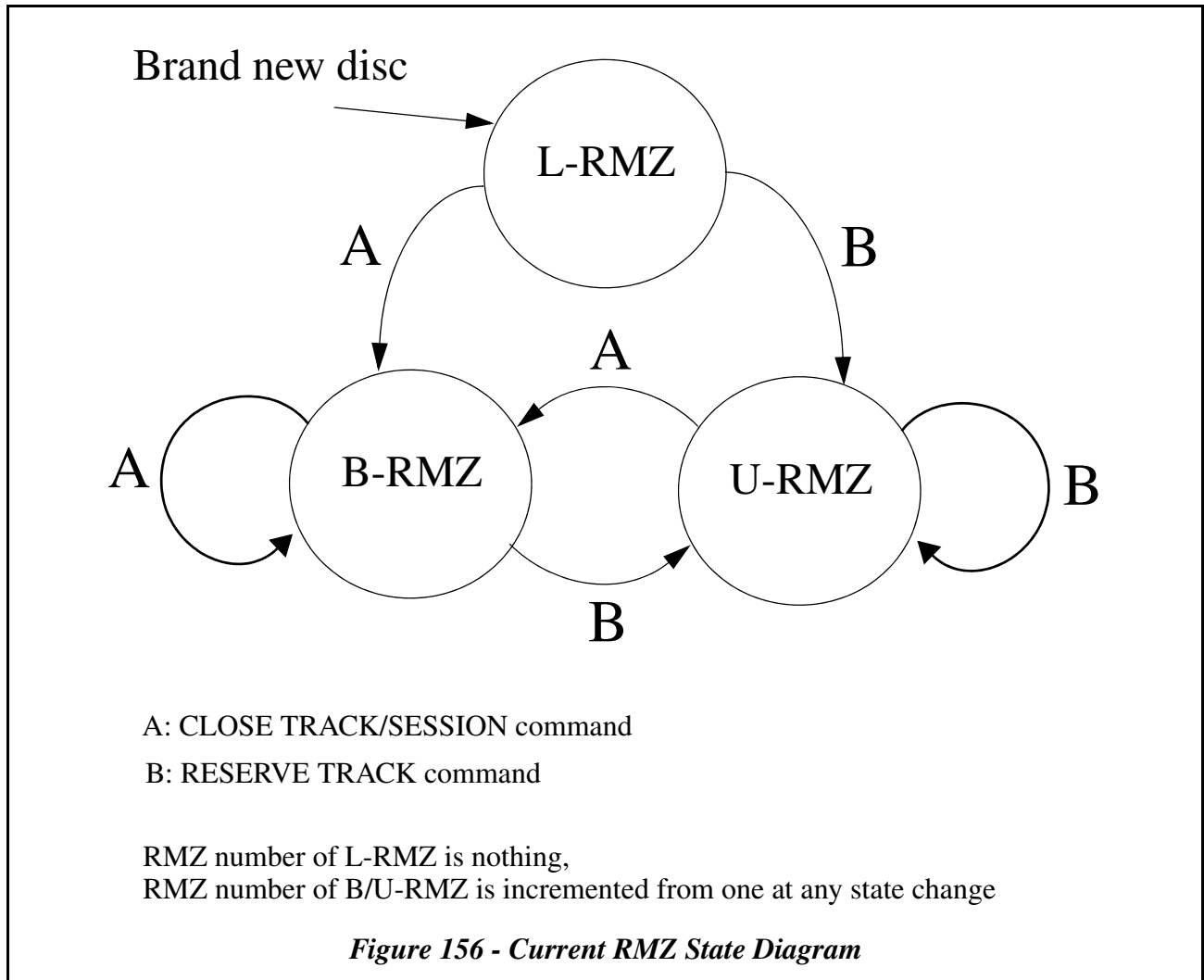
There are three kinds of RMZs. See 5.13.2.1 "RMZ (Recording Management Zone)" on page 333. Then the RMZ that can be used is always one. This RMZ is called Current RMZ. When a RMZ is newly created, the unrecorded ECC block in the RMZ that is used until the time is padded with the latest RMD and the latest RMD is copied in RDZ. See Figure 155.



There are two kinds of the RMZ extension methods. One is the creation of RMZ in the next Border-in (B-RMZ). The other is the creation of RMZ in the User Data Zone (U-RMZ).

1. B-RMZ **shall** be assigned when the Border is closed by using CLOSE TRACK/SESSION command with Close Function field = 010b.
2. U-RMZ **shall** be assigned by using RESERVE TRACK command with RMZ bit = 1, when the unrecorded part of a Current RMZ become equal to or less than 15 ECC blocks.

The Current RMZ state diagram is shown in Figure 156.



5.13.7.2 Extended RMZ numbering

The RMZ numbers *shall* start from 1 and be increased by one following a RMZ extension. RMZ number *shall* be assigned commonly within B-RMZ and U-RMZ. L-RMZ *shall* not have a RMZ number.

5.13.7.3 RMZ Extension by B-RMZ

B-RMZ *shall* be assigned in the next Border-in when Border is closed. See 5.13.6 "Border zone recording" on page 350.

5.13.7.4 RMZ Extension by U-RMZ

U-RMZ *shall* only be assigned from the NWA of the Invisible RZone. If an Incomplete RZone exists, the Incomplete RZone *shall* be closed prior to reserving a new U-RMZ.

U-RMZ can be assigned only under the following conditions;

- The number of the unrecorded ECC Blocks in RDZ is more than or equal to 1 and
- The number of the unrecorded ECC Blocks in the current RMZ is more than or equal to 1 and equal to or less than 15.

If the condition is not satisfied, then Error code *shall* be reported to the host. See 5.13.12.5 "Error reporting for "RMZ extension by U-RMZ" by using RESERVE TRACK command" on page 362.

5.13.7.5 Sample sequence for RMZ extension by U-RMZ

Initially, a blank medium has only Invisible RZone. NWA is LBA 0. When a write operation has begun without or with reservation, the NWA is proportionally incremented by written data length (reference 0).

If a RMZ extension by U-RMZ is required, the Incomplete RZone *shall* be closed and the RMD is updated. Then a new Invisible RZone is created (reference 1).

The new assigned U-RMZ is allocated from the NWA of the Invisible RZone with 128 ECC blocks and the RMD is updated. The unrecorded area in the current RMZ is padded with the updated RMD and the copied RMD is located in the RDZ (reference 2).

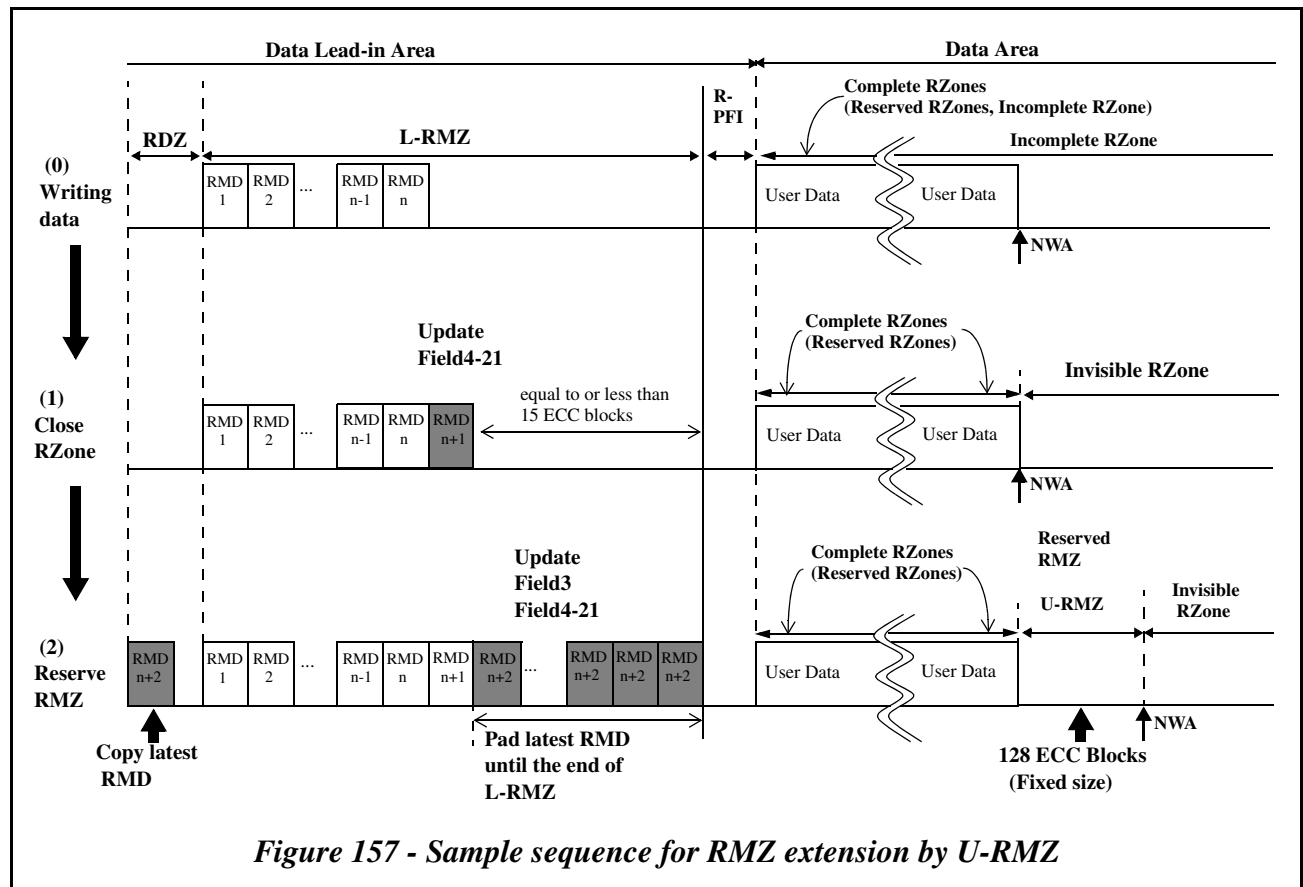


Figure 157 - Sample sequence for RMZ extension by U-RMZ

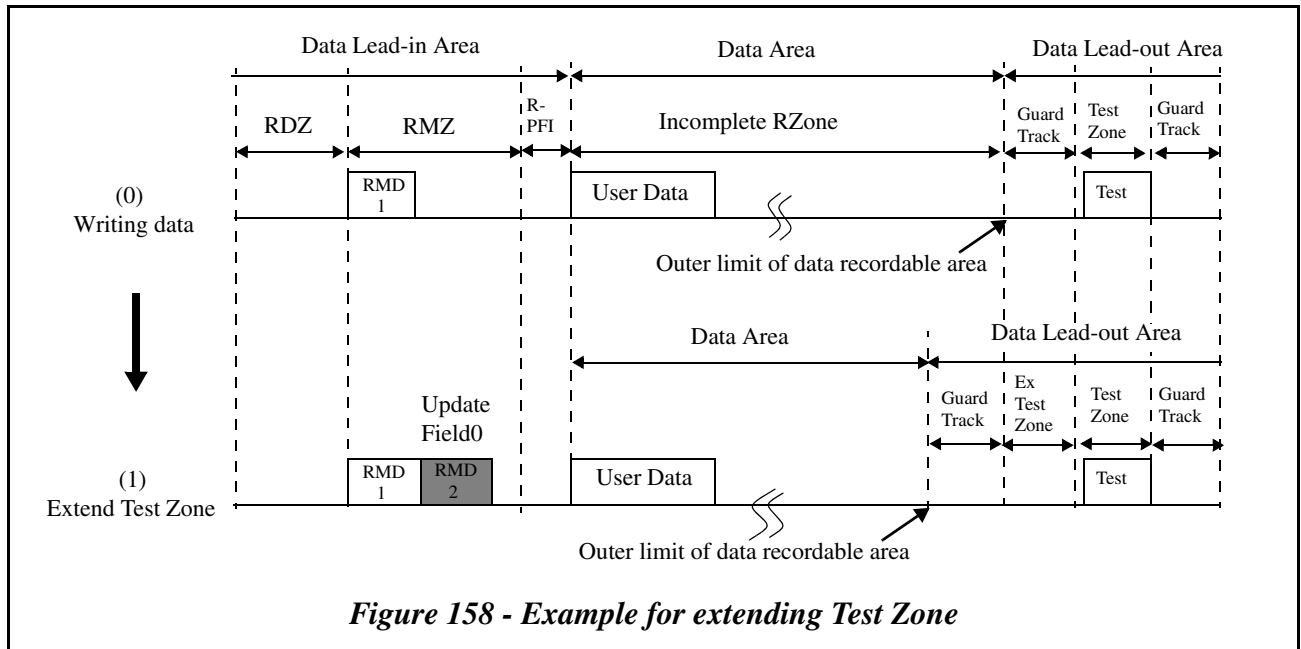
5.13.8 Test Zone extension

When the host issues FORMAT UNIT Command (Format Type16h), logical unit *shall* extend the Test zone and *shall* update the RMD. Figure 158 shows an example for extending Test zone.

Initially, a blank medium has no Extended Test Zone (reference 0).

If a extension of the Test zone is required, the inner Guard track zone in the Data Lead-out Area can be used for Extended Test zone and the outermost Data Area is reassigned as the Guard track zone. The RMD is updated (reference 1).

Attempting to extend the Test Zone when the Test Zone is already extended or NWA is larger than 431840h, the command *shall* be terminated with CHECK CONDITION Status, 5/72/07 NO MORE TEST ZONE EXTENSIONS ARE ALLOWED.



5.13.9 Optimum Power Calibration (OPC)

Optimum power calibration (OPC) is required to determine the optimum recording laser power for the mounted HD DVD-R media. If necessary, OPC operation may be performed automatically when the medium has been first inserted into the logical unit and the first WRITE (10) command is issued. When OPC operation is done, RMD *shall* be cached or written in RMZ by the logical unit. When the unrecorded ECC blocks in Current RMZ are equal to or less than 8 ECC blocks, OPC operation *shall not* be performed except for the host request (e.g., WRITE (10) command, RESERVE TRACK command) for avoiding waste of RMZ.

The Test zone is located from Physical Sector Numbers (PSN) 27200h to 2BCFFh and 739040h to 73CA3Fh. If the Test zone is extended, the Extended Test zone is also located from PSN 735440h to 73903Fh. The OPC start address is in descending order within the Test zone. As an example, the first power calibration is in PSN 2BCFFh and the second power calibration is in PSN 2BCEf h. Power calibration *shall* end on a ECC block boundary. If a host requires OPC at desired timing, the SEND OPC INFORMATION command *shall* be used.

5.13.10 Disc Final Closure

When CLOSE TRACK/SESSION command with Close Function field = 110b is issued, the final closure operation *shall* be started for the disc. After this operation, data cannot be appended to the disc any more.

Final closure operation is done in the following sequence:

1. If opened RZone(s) exist, close all opened RZone(s).
2. Issue CLOSE TRACK/SESSION command with Close Function field = 110b.

If current Border is not Empty status (See Figure 159)

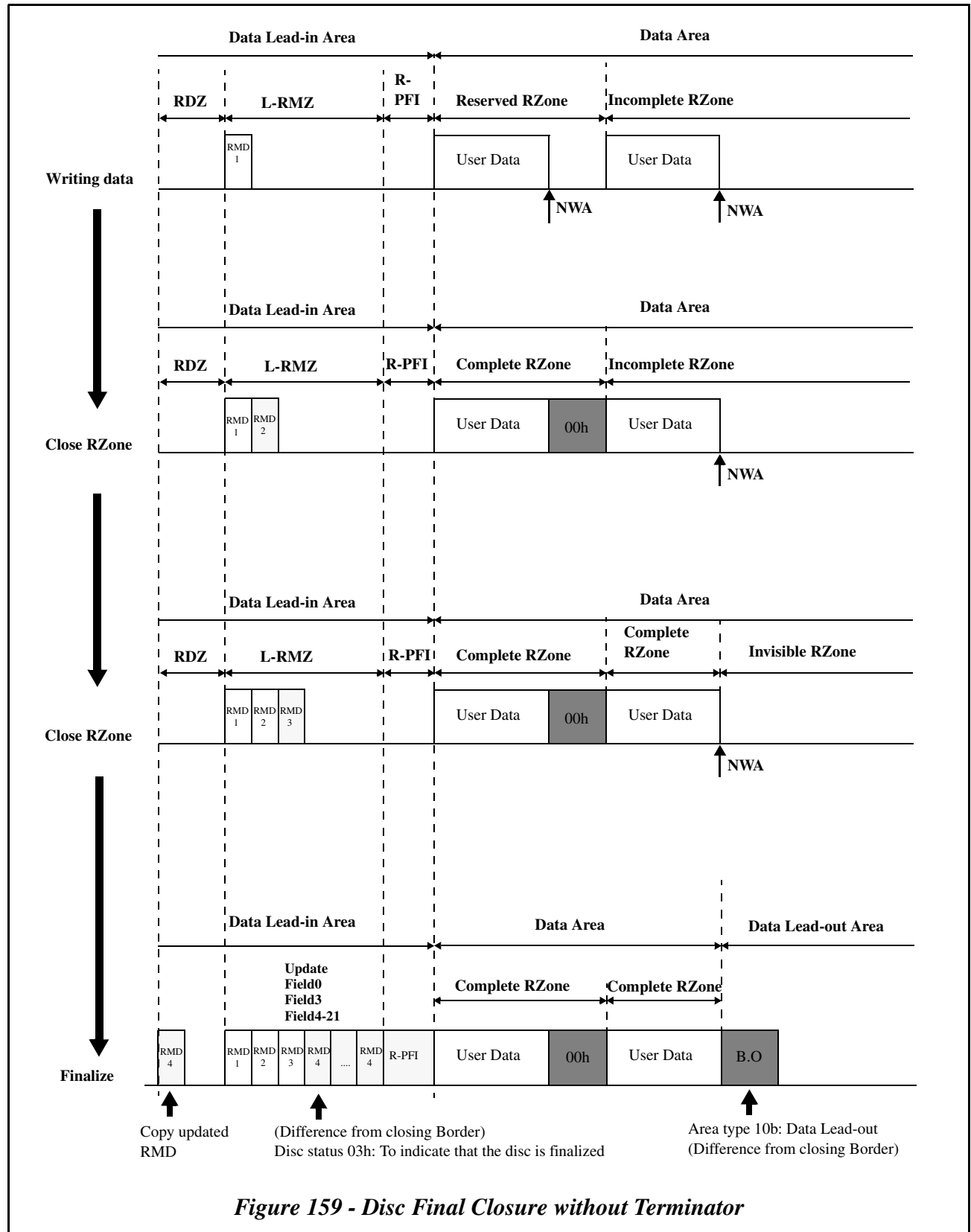
3. Border-out which attributes Data Lead-out (Area Type 10b) *shall* be recorded.
4. The Start PSN of the next Border-in field in the Data Lead-in or the current Border-in *shall* be set to 0.
5. Updated RMD *shall* be written in Current RMZ with Disc Status field “Complete (03h)”.
6. The unrecorded ECC blocks in Current RMZ *shall* be padded with the Updated RMD.
7. The updated RMD shall be copied in RDZ if RDZ is not full.

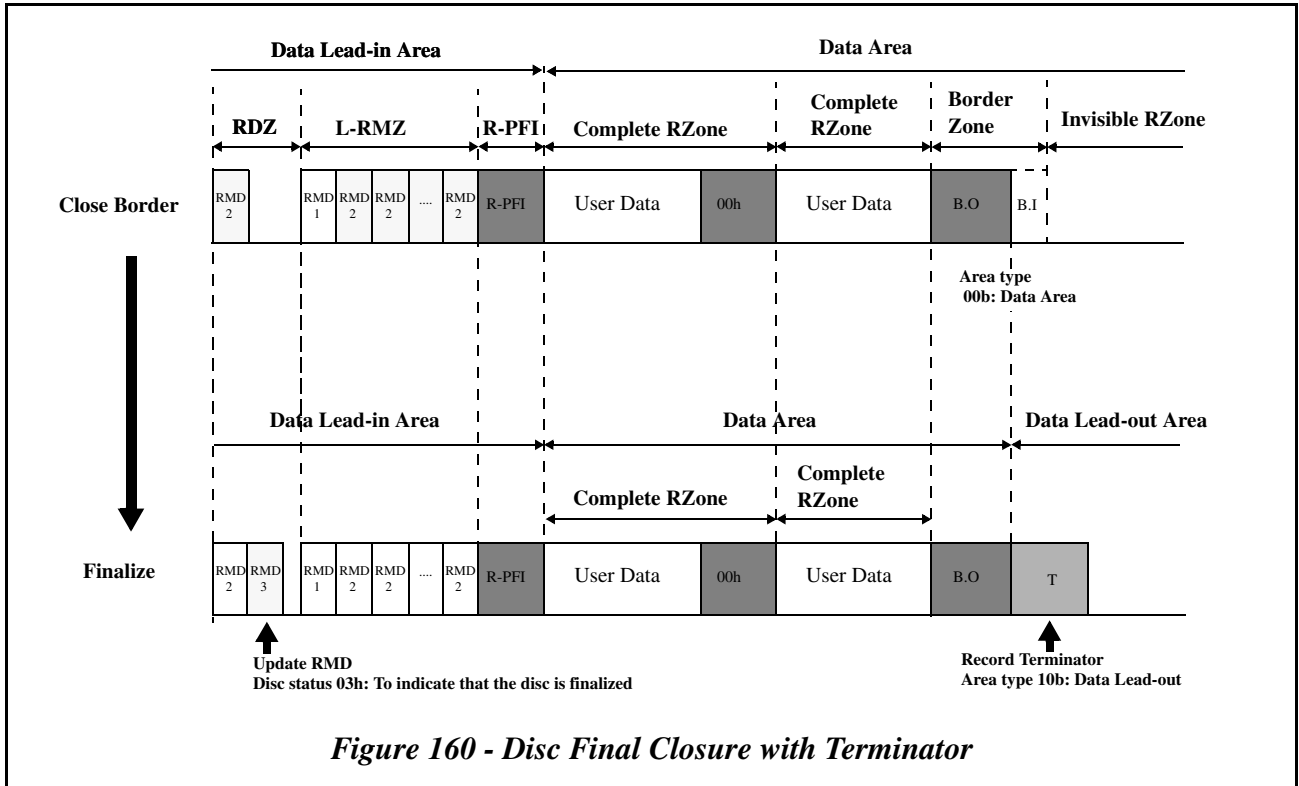
If current Border is Empty status (See Figure 160)

3. Terminator which attributes Data Lead-out (Area Type 10b) *shall* be recorded just behind Border-out zone.
4. Updated RMD shall be written in RDZ if RDZ is not full.

To recognize whether the disc is finalized or not, the following conditions are checked. If one of the following condition is met, the disc *shall* be considered a finalized disc and is not appendable.

- Start PSN of the next Border-in field of Lead-in/Border-in contains 0.
- Disc Status field of RMD contains “Complete (03h)” status.
- Terminator or Data Lead-out that has a Data Lead-out attribute exists.





5.13.11 Example for multi-border recognition

When a recorded disc is inserted into an HD DVD-R logical unit, the logical unit searches LRA. An example of searching LRA is shown in Figure 161 and Figure 162.

The HD DVD-R logical unit access to RDZ after reading the information in the System Lead-in Area. The logical unit searches the latest RMD in RDZ. The start LBA of the last Extended RMZ can be gotten from the latest RMD in RDZ. Next, the logical unit accesses to the last Extended RMZ and searches the latest RMD in the last Extended RMZ. The logical unit certifies the value of LRA, then a real LRA is fixed.

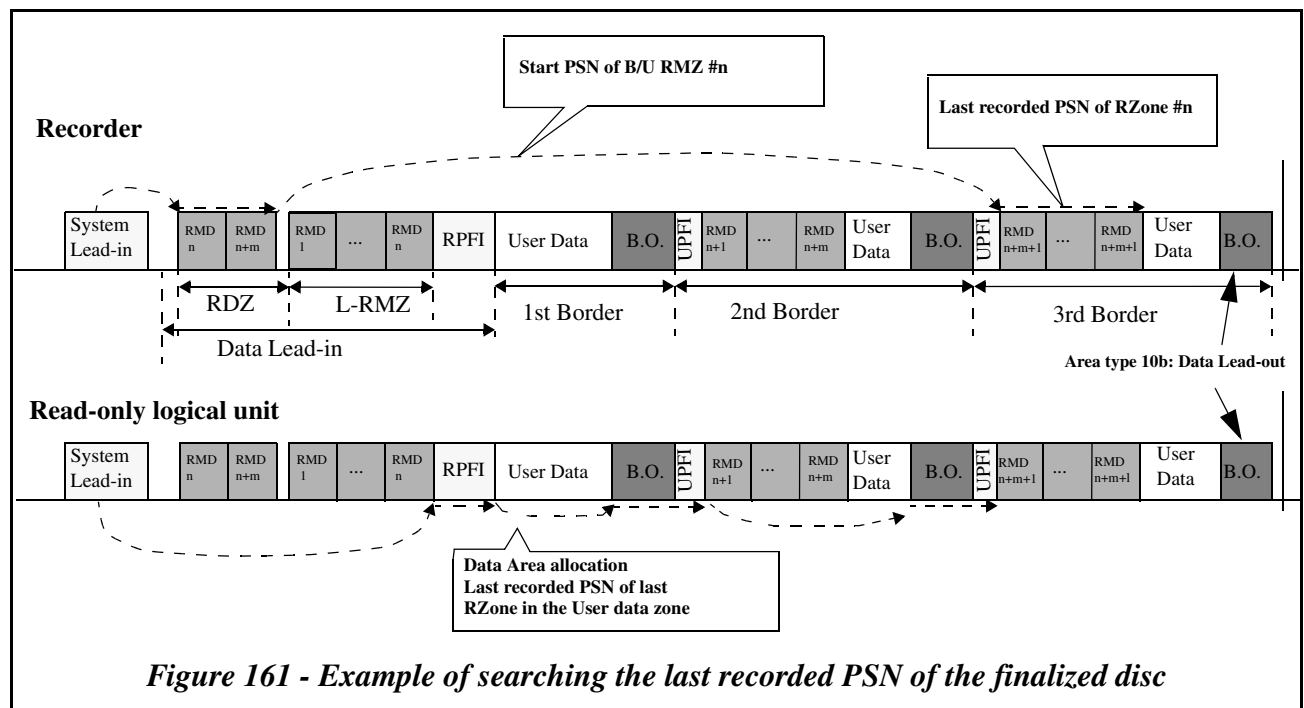
When a recorded disc is inserted into an HD DVD read-only logical unit, the logical unit searches LRA. An example of searching LRA is shown in Figure 161 and Figure 162.

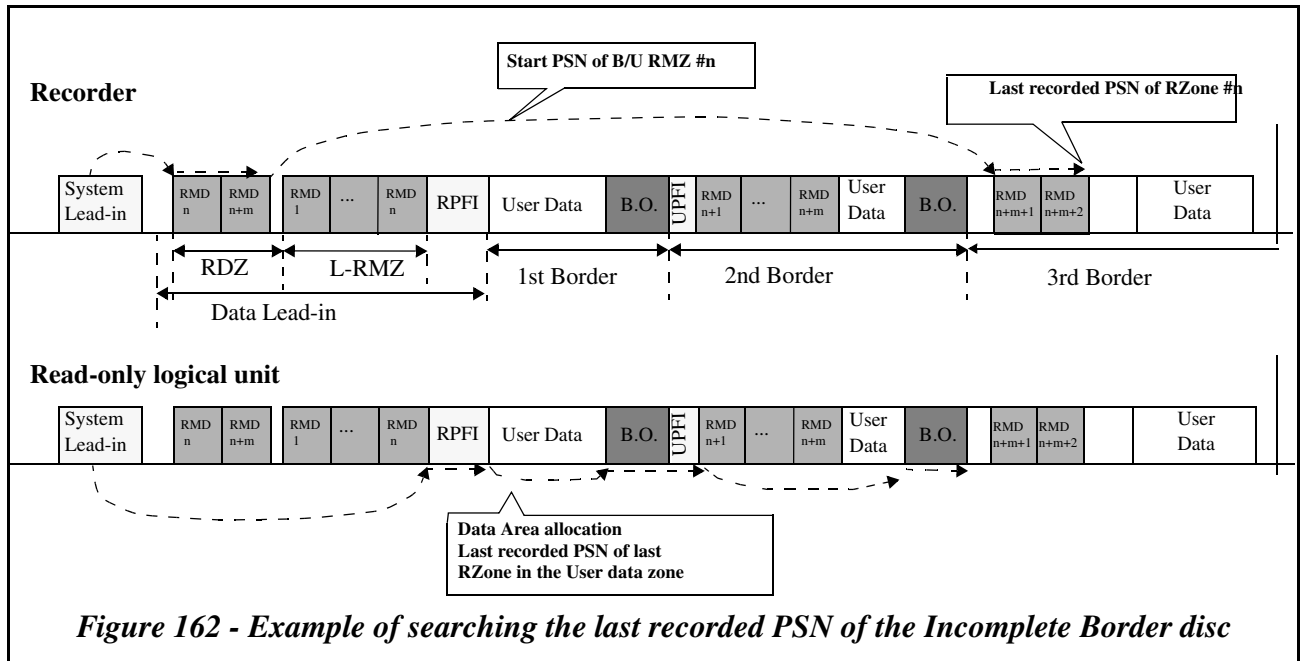
The HD DVD ROM logical unit cannot access to the unrecorded part of a disc. In consequence, the logical unit cannot access to RDZ and cannot use the method for searching LRA that the HD DVD-R logical unit uses. In addition, the HD DVD-ROM logical unit can not interpret RMD. The logical unit can interpret Physical Format Information (PFI) in PFI Zone, R-PFI Zone and U-PFI Zone. An example of searching LRA on the logical unit is as follows.

The HD DVD read-only logical unit accesses to the R-PFI Zone after reading the information in the System Lead-in Area. The logical unit can get Start LBA of the second Border Zone from R-PFI. Next, the logical unit accesses to the Border-in of the second Border and can get Start LBA of the third Border Zone from U-PFI. The action is repeated until the logical unit accesses to the last closed Border. The last Border is a Border as follows;

- Start PSN of the next Border-in field of PFI contains 00h.
- Terminator or Data Lead-out that has a Data Lead-out attribute exists.

The HD DVD-ROM logical unit can get the Last Recorded Address of the last closed Border from Last recorded PSN of last RZone in the User data zone field of PFI. When the last Border is not closed, the logical unit may not be able to get a real LRA.





5.13.12 Error reporting for RMZ exhaustion

5.13.12.1 Error reporting for WRITE (10) command and WRITE (12) command

The error reporting for the command in each condition of the media is shown in Table 189.

Table 189 - Error reporting for WRITE (10) command and WRITE (12) command

Condition of the RDZ	The number of the unrecorded ECC blocks in the current RMZ	Error code
The unrecorded ECC blocks exists	More than 15	-
	Less than or equal to 15, and more than 4	-
	Less than or equal to 4, and more than 0	5/73/15 CURRENT PROGRAM MEMORY AREA/RMZ IS FULL
	0	3/73/04 PROGRAM MEMORY AREA/RMA UPDATE FAILURE
The unrecorded ECC blocks do not exist	More than 15	-
	Less than or equal to 15, and more than 4	-
	Less than or equal to 4, and more than 0	3/73/05 PROGRAM MEMORY AREA/RMA IS FULL
	0	3/73/05 PROGRAM MEMORY AREA/RMA IS FULL

5.13.12.2 Error reporting for SYNCHRONIZE CACHE (10) command

The error reporting for the command in each condition of the media is shown in Table 190.

Table 190 - Error reporting for SYNCHRONIZE CACHE (10) command

Condition of the RDZ	The number of the unrecorded ECC blocks in the current RMZ	Error code
The unrecorded ECC blocks exists	More than 15	-
	Less than or equal to 15, and more than 4	1/73/16 CURRENT PROGRAM MEMORY AREA/RMZ IS (almost) FULL
	Less than or equal to 4, and more than 0	5/73/15 CURRENT PROGRAM MEMORY AREA/RMZ IS FULL
	0	3/73/04 PROGRAM MEMORY AREA/RMA UPDATE FAILURE
The unrecorded ECC blocks do not exist	More than 15	-
	Less than or equal to 15, and more than 4	1/73/06 PROGRAM MEMORY AREA/RMA IS (almost) FULL
	Less than or equal to 4, and more than 0	3/73/05 PROGRAM MEMORY AREA/RMA IS FULL
	0	3/73/05 PROGRAM MEMORY AREA/RMA IS FULL

5.13.12.3 Error reporting for “RZone reservation” by using RESERVE TRACK command

The error reporting for the command in each condition of the media is shown in Table 191.

Table 191 - Error reporting for “RZone reservation” by using RESERVE TRACK command

Condition of the RDZ	The number of the unrecorded ECC blocks in the current RMZ	Error code
The unrecorded ECC blocks exists	More than 15	-
	Less than or equal to 15, and more than 4	1/73/16 CURRENT PROGRAM MEMORY AREA/RMZ IS (almost) FULL
	Less than or equal to 4, and more than 0	5/73/15 CURRENT PROGRAM MEMORY AREA/RMZ IS FULL
	0	3/73/04 PROGRAM MEMORY AREA/RMA UPDATE FAILURE
The unrecorded ECC blocks do not exist	More than 15	-
	Less than or equal to 15, and more than 4	1/73/06 PROGRAM MEMORY AREA/RMA IS (almost) FULL
	Less than or equal to 4, and more than 0	3/73/05 PROGRAM MEMORY AREA/RMA IS FULL
	0	3/73/05 PROGRAM MEMORY AREA/RMA IS FULL

5.13.12.4 Error reporting for “RZone closure” by using CLOSE TRACK/SESSION command

The error reporting for the command in each condition of the media is shown in Table 192.

Table 192 - Error reporting for “RZone closure” by using CLOSE TRACK/SESSION command

Condition of the RDZ	The number of the unrecorded ECC blocks in the current RMZ	Error code
The unrecorded ECC blocks exists	More than 15	-
	Less than or equal to 15, and more than 4	-
	Less than or equal to 4, and more than 0	-
	0	3/73/04 PROGRAM MEMORY AREA/RMA UPDATE FAILURE
The unrecorded ECC blocks do not exist	More than 15	-
	Less than or equal to 15, and more than 4	-
	Less than or equal to 4, and more than 0	-
	0	3/73/05 PROGRAM MEMORY AREA/RMA IS FULL

5.13.12.5 Error reporting for “RMZ extension by U-RMZ” by using RESERVE TRACK command

The error reporting for the command in each condition of the media is shown in Table 193 and Table 194.

Table 193 - Error reporting for “RMZ extension by U-RMZ” by using RESERVE TRACK command (1)

Condition of the RDZ	The number of the unrecorded ECC blocks in the current RMZ	Error code
The unrecorded ECC blocks exists	More than 15	5/72/06 RMZ EXTENSION IS NOT ALLOWED
	Less than or equal to 15, and more than 4	-
	Less than or equal to 4, and more than 0	-
	0	3/73/04 PROGRAM MEMORY AREA/RMA UPDATE FAILURE
The unrecorded ECC blocks do not exist	More than 15	5/73/17 RDZ IS FULL
	Less than or equal to 15, and more than 4	5/73/17 RDZ IS FULL
	Less than or equal to 4, and more than 0	5/73/17 RDZ IS FULL
	0	3/73/05 PROGRAM MEMORY AREA/RMA IS FULL

Table 194 - Error reporting for “RMZ extension by U-RMZ” by using RESERVE TRACK command (2)

Condition of the media	Error code
The number of the free blocks are smaller than 128 ECC blocks	5/72/06 RMZ EXTENSION IS NOT ALLOWED

5.13.12.6 Error reporting for “Border closure” by using CLOSE TRACK/SESSION command

The error reporting for the command in each condition of the media is shown in Table 195 and Table 196.

Table 195 - Error reporting for “Border closure” by using CLOSE TRACK/SESSION command

Condition of the RDZ	The number of the unrecorded ECC blocks in the current RMZ	Error code
The unrecorded ECC blocks exists	More than 15	-
	Less than or equal to 15, and more than 4	-
	Less than or equal to 4, and more than 0	-
	0	3/73/04 PROGRAM MEMORY AREA/RMA UPDATE FAILURE
The unrecorded ECC blocks do not exist	More than 15	5/73/17 RDZ IS FULL
	Less than or equal to 15, and more than 4	5/73/17 RDZ IS FULL
	Less than or equal to 4, and more than 0	5/73/17 RDZ IS FULL
	0	3/73/05 PROGRAM MEMORY AREA/RMA IS FULL

Table 196 - Error reporting for “Border closure” by using CLOSE TRACK/SESSION command (2)

Condition of the media	Error code
The number of the free blocks are smaller than Border-out Area size	5/2C/00 COMMAND SEQUENCE ERROR

5.13.12.7 Error reporting for “finalization” by using CLOSE TRACK/SESSION command

The error reporting for the command in each condition of the media is shown in Table 197.

Table 197 - Error reporting for “finalization” by using CLOSE TRACK/SESSION command

Condition of the RDZ	The number of the unrecorded ECC blocks	Error code
The unrecorded ECC blocks exists	More than 15	-
	Less than or equal to 15, and more than 4	-
	Less than or equal to 4, and more than 0	-
	0	3/73/04 PROGRAM MEMORY AREA/RMA UPDATE FAILURE ^a
The unrecorded ECC blocks do not exist	More than 15	-
	Less than or equal to 15, and more than 4	-
	Less than or equal to 4, and more than 0	-
	0	3/73/05 PROGRAM MEMORY AREA/RMA IS FULL ^a

a. When the disc is finalized with Terminator, no error is returned as an exception.

5.13.12.8 Error reporting for “Test Zone extension” by using FORMAT UNIT command

The error reporting for the command in each condition of the media is shown in Table 198 and Table 199.

Table 198 - Error reporting for “Test Zone extension” by using FORMAT UNIT command (1)

Condition of the RDZ	The number of the unrecorded ECC blocks	Error code
The unrecorded ECC blocks exists	More than 15	-
	Less than or equal to 15, and more than 4	1/73/16 CURRENT PROGRAM MEMORY AREA/RMZ IS (almost) FULL
	Less than or equal to 4, and more than 0	5/73/15 CURRENT PROGRAM MEMORY AREA/RMZ IS FULL
	0	3/73/04 PROGRAM MEMORY AREA/RMA UPDATE FAILURE
The unrecorded ECC blocks do not exist	More than 15	-
	Less than or equal to 15, and more than 4	1/73/06 PROGRAM MEMORY AREA/RMA IS ALMOST FULL
	Less than or equal to 4, and more than 0	3/73/05 PROGRAM MEMORY AREA/RMA IS FULL
	0	3/73/05 PROGRAM MEMORY AREA/RMA IS FULL

Table 199 - Error reporting for “Test Zone extension” by using FORMAT UNIT command (2)

Condition of the media	Error code
The extended Test zone already exists	5/72/07 NO MORE TEST ZONE EXTENSIONS ARE ALLOWED
The number of the free blocks are smaller than extended Test zone size	5/72/07 NO MORE TEST ZONE EXTENSIONS ARE ALLOWED

5.13.12.9 Error reporting for SEND OPC INFORMATION command

The error reporting for the command in each condition of the media is shown in Table 200.

Table 200 - Error reporting for SEND OPC INFORMATION command

Condition of the RDZ	The number of the unrecorded ECC blocks in the current RMZ	Error code
The unrecorded ECC blocks exists	More than 15	-
	Less than or equal to 15, and more than 4	1/73/16 CURRENT PROGRAM MEMORY AREA/RMZ IS (almost) FULL
	Less than or equal to 4, and more than 0	5/73/15 CURRENT PROGRAM MEMORY AREA/RMZ IS FULL
	0	3/73/04 PROGRAM MEMORY AREA/RMA UPDATE FAILURE
The unrecorded ECC blocks do not exist	More than 15	-
	Less than or equal to 15, and more than 4	1/73/06 PROGRAM MEMORY AREA/RMA IS ALMOST FULL
	Less than or equal to 4, and more than 0	3/73/05 PROGRAM MEMORY AREA/RMA IS FULL
	0	3/73/05 PROGRAM MEMORY AREA/RMA IS FULL

5.14 Recording for HD DVD-R Dual Layer media

The HD DVD-R Dual Layer (DL) media have an outer diameter of 120 mm and a capacity of 60 Gbytes per disc, double-sided Dual Layer disc, or 30 Gbytes per disc, single-sided Dual Layer disc. HD DVD-R DL media have only Opposite Track Path (OTP).

5.14.1 Profile and Feature

When a blank HD DVD-R DL medium is installed in a logical unit, the logical unit reports HD DVD-R Dual Layer Profile in the **Current Profile** field of Table 339 - *Feature Header* on page 560. If the logical unit supports the HD DVD-R DL reading, the logical unit *shall* support HD DVD Read Feature with the HD DVD-R DL bit. If the logical unit supports the HD DVD-R DL recording, the logical unit *shall* support HD DVD Write Feature with the HD DVD-R DL bit.

5.14.2 Restriction for recording

HD DVD-R DL only supports incremental recording mode. Some restrictions are newly introduced for DL.

Characteristics of HD DVD-R DL recording are as follows;

1. The number of Bordered Area is limited to one.
2. RMZ extension is not supported. Only L-RMZ is used for HD DVD-R DL.
3. Test Zone extension is not supported. FORMAT UNIT command (**Format Type** = 16h) is not supported.
4. RZone reservation has some specific restrictions for HD DVD-R DL. See 5.14.2.3 "RZone reservation" on page 372.
5. Middle Area expansion is supported. See 5.14.2.2 "Middle Area expansion" on page 368.
6. The recording on L1 is restricted by the recording condition on L0. See 5.14.2.1 "Preparation for recording L1" on page 367.
7. The suspension of finalization is defined. See 5.14.3.1 "Disc Final Closure Suspension and Restart" on page 376.

5.14.2.1 Preparation for recording L1

Before recording on L1, the corresponding area on L0 *shall* be recorded. Reading and recording of a layer are affected by the influence of the beam that is reflected at the other layer of the disc. To mitigate this influence, the status of the other layer of the disc should be uniform in terms of existence of recorded marks. Before recording user data in Data Area on L1, Guard Track Zone in Middle Area on L0 and in Data Lead-in *shall* be recorded to use Drive Test Zone for performing OPC for L1. See Figure 163. After both of the Guard Track Zones are recorded, the logical unit *shall* set Instant Recording Setup for L1 (IRSL1) bit to one.

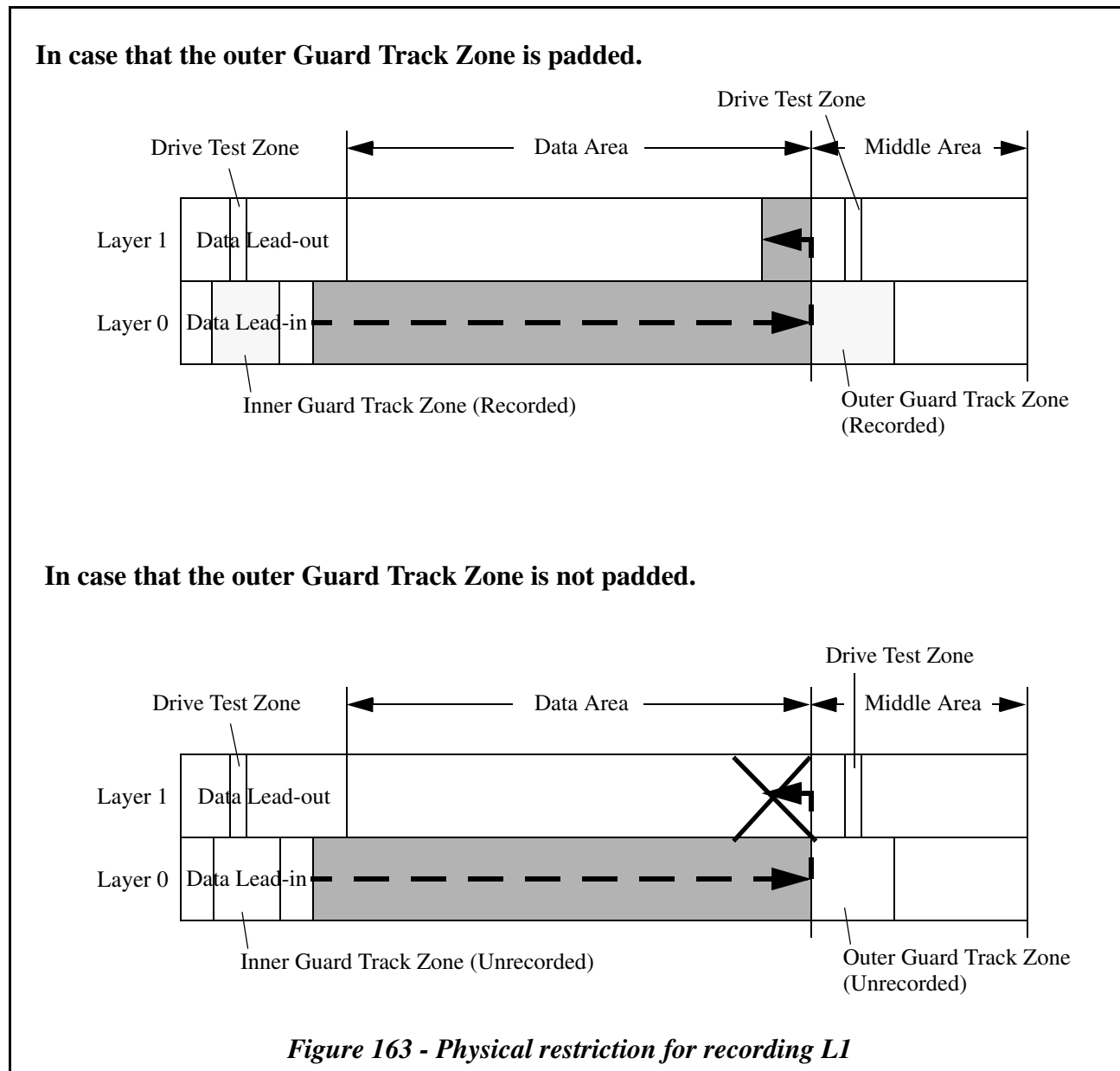
Recording of Guard Track Zones spends about one minute with 1x recording speed¹. To get the long seamless recording condition such as real-time recording, Guard Track Zones should be recorded at the initialization of the disc by FORMAT UNIT command (**Format Type** = 17h).

When a WRITE command with the address L0 through L1 is issued, the WRITE command *shall* be terminated with CHECK CONDITION status, 5/21/03 INVALID WRITE CROSSING LAYER JUMP.

Note: this section describes on the assumption that Middle Area is not expanded. If Middle Area is expanded, Extra Guard Track Zone is newly allocated. And before the recording user data in Data Area on L1, Extra Guard Track Zone shall be recorded. According to the size of the expanded Middle Area, Guard Track Zone is not necessary to be recorded. 5.14.2.2.1 "Guard Track Zone allocation by Middle Area expansion" on page 370.

*Note: For non real-time recording, it is not necessary to record the Guard Track Zones initially by FORMAT UNIT command with **Format Type** = 17h. If the Guard Track Zones are not recorded, a WRITE command may take a certain time for recording the Guard Track Zones.*

1. 1x speed: 36,55 Mbps



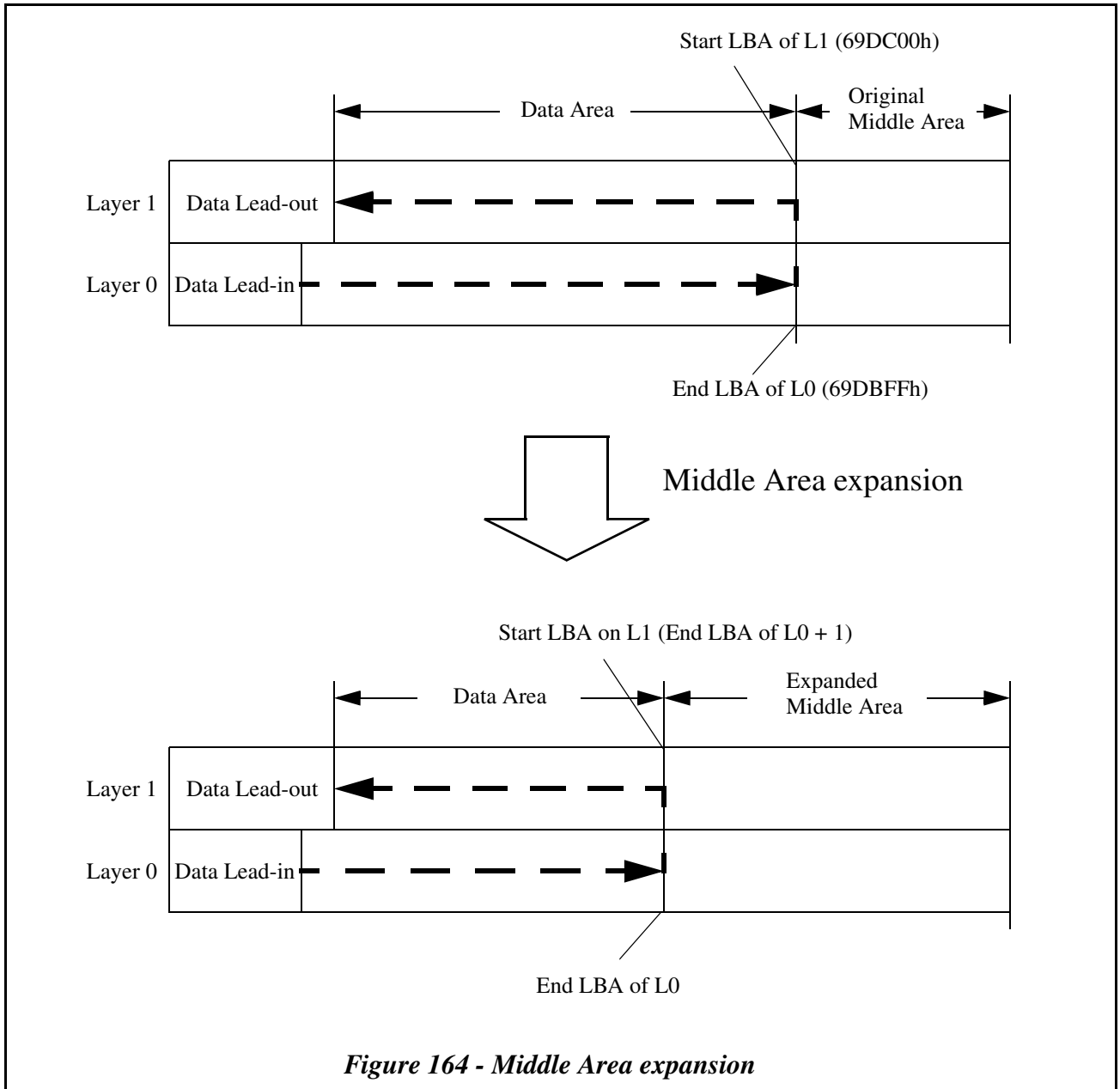
5.14.2.2 Middle Area expansion

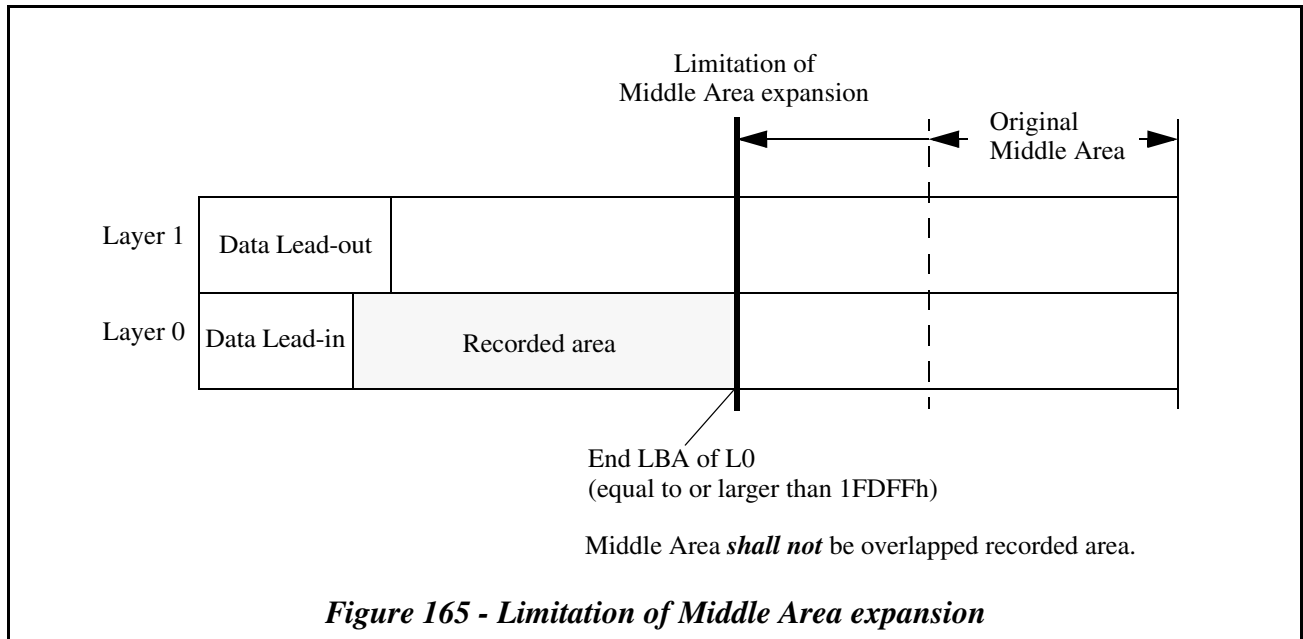
When the total data size to be recorded is known, Middle Area expansion is a better way to reduce the time required for finalizing. Before Data Area on L1 is recorded, Middle Area can be expanded in unrecorded Data Area of Invisible/Incomplete RZone just once. In order to expand Middle Area, a host *shall* specify the Data Area capacity on L0 in logical block by SEND DISC STRUCTURE command (Format Code = 20h). The value is an integral multiple of 32 and equal to or larger than 1FE00h. See Figure 164. Middle Area *shall* not be overlapped recorded area. See Figure 165. When Middle Area expansion is not available at the value, the SEND DISC STRUCTURE command (Format Code = 20h) *shall* be terminated with CHECK CONDITION status, 5/26/00 INVALID FIELD IN PARAMETER LIST. If a host tries to specify the value when data remain in the logical unit's write buffer, the command *shall* be terminated with CHECK CONDITION status, 5/2C/00 COMMAND SEQUENCE ERROR.

Once Middle Area expansion is done, the outer radius area beyond the Middle Area becomes unusable for user data and no more Middle Area expansion is allowed. Therefore the number of free blocks becomes to be decreased.

Even if Middle Area is expanded, the end LBA of Data Area on L0 and the start LBA of Data Area on L1 are continuous.

The capacity of Data Area is reported by READ TRACK INFORMATION command.





5.14.2.2.1 Guard Track Zone allocation by Middle Area expansion

After the Middle Area expansion, Extra Guard Track Zone is allocated in Middle Area. According to the size of the expanded Middle Area, the Middle Area allocation is different as shown in Figure 166. Table 201 shows the number of physical sectors in inner/outer Guard Track Zone on L0 and Extra Guard Track Zone on L0. In both cases, before recording user data in Data Area on L1, Extra Guard Track Zone in expanded Middle Area on L0 *shall* be recorded even if the original Guard Track Zone in original Middle Area on L0 was recorded by FORMAT UNIT command (Format Type = 17h).

In case of the small expanded Middle Area that the start PSN of Middle Area on L0 is equal to or larger than 726C00h, the original Guard Track Zone in Middle Area on L0 *shall* be recorded before recording user data in Data Area on L1.

In case of the large expanded Middle Area that the start PSN of Middle Area on L0 is smaller than 726C00h, the original Guard Track Zone in Middle Area on L0 is not necessary to be recorded before the recording user data in Data Area on L1. In this case, the recording the original Guard Track Zone is vender specific. The use of original Drive Test Zone in Middle Area on L1 is also vender specific.

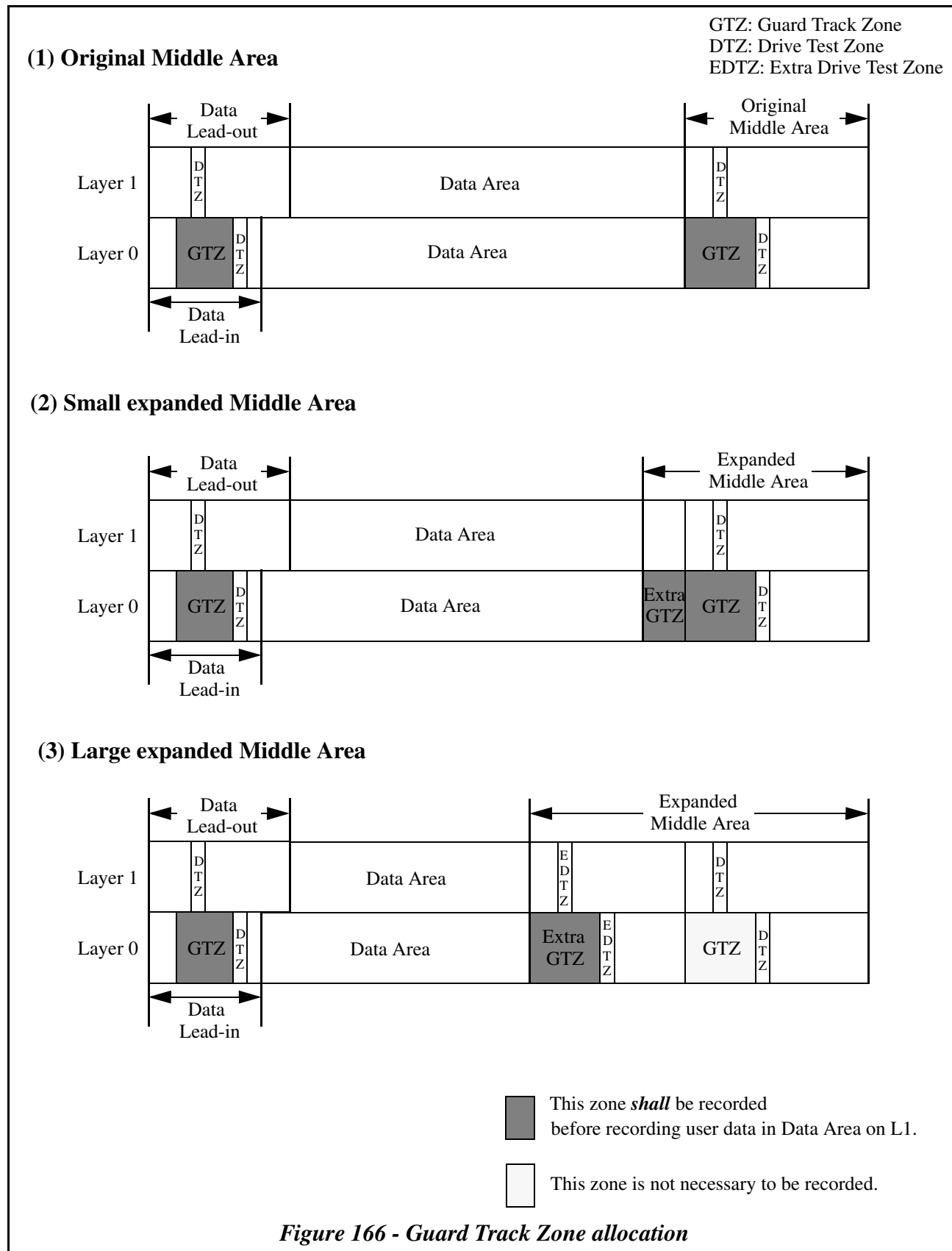


Table 201 - Inner/outer Guard Track Zone on L0 and Extra Guard Track Zone on L0

Expansion type	Start PSN of Middle Area on L0	Inner Guard Track Zone size (physical sectors)	Outer Guard Track Zone size (physical sectors)	Extra Guard Track Zone size (physical sectors)
Large	5FE00h to 1E0E00h	E400h	13400h	D300h
	1E0E01h to 421C00h	E400h	13400h	10100h
	421C01h to 726BFFh	E400h	13400h	13400h
Small	726C00h to 73DC00h	E400h	13400h	73DC00h - Start PSN of Middle Area on L0 (0 to 17000h)

5.14.2.3 RZone reservation

The rule of RZone reservation is similar to that of HD DVD-R SL. By the specific restriction for HD DVD-R DL, RZone reservation should be executed carefully not to reduce usable storage capacity unintentionally. The following restrictions are applied to HD DVD-R DL.

- RZone reservation can be executed only on L0.
- The capacity of Data Area is reduced by RZone reservation.

See Figure 167 and Table 202.

The capacity of Data Area is reported by READ TRACK INFORMATION command.

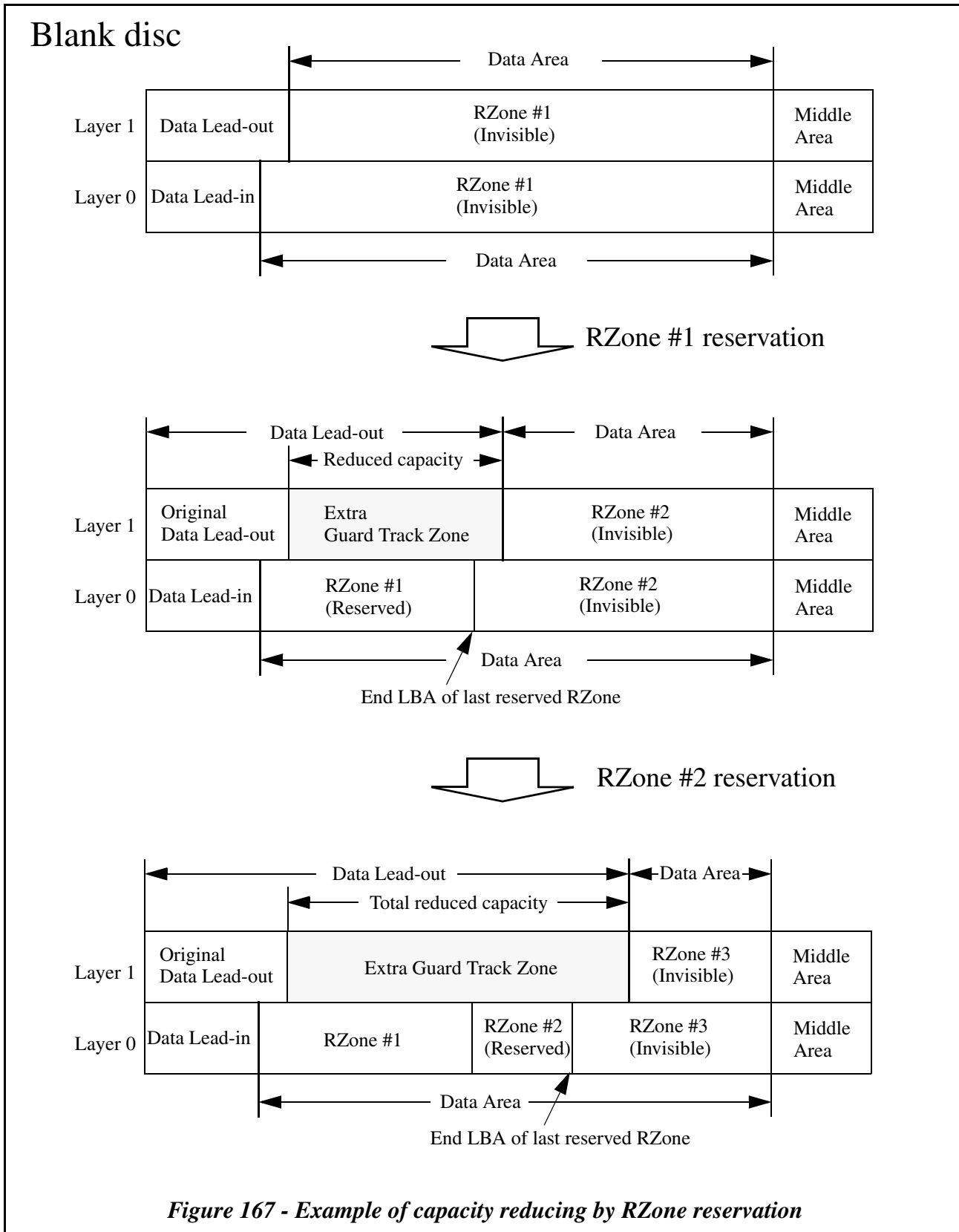


Table 202 - Total reduced capacity by RZone reservation

End LBA of last reserved RZone	Total reduced capacity (Number of sectors)
0 to 309FFh	End LBA of reserved RZone + 401h
30A00h to 1384FFh	End LBA of reserved RZone + 1101h
128500h to 256FFFh	End LBA of reserved RZone + 1F01h
257000h to 3BCAFFh	End LBA of reserved RZone + 2C01h
3BCB00h to 5595FFh	End LBA of reserved RZone + 3A01h
559600h to 6F62FFh	End LBA of reserved RZone + 4601h
6F6300h to 6FDBFFh	6FA900h (Full capacity of L1)

5.14.3 Disc Final Closure

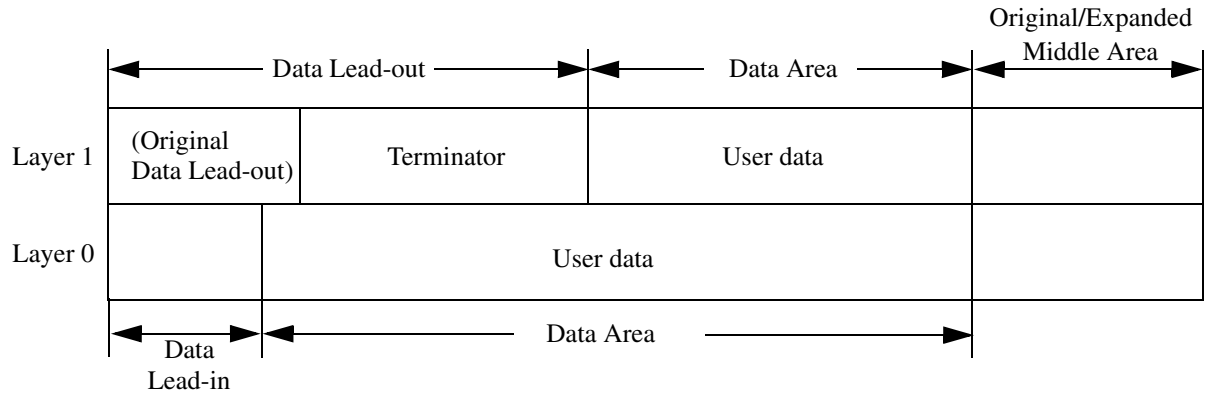
When CLOSE TRACK/SESSION command with Close Function field = 110b is issued, the finalization *shall* be started for the disc. After this operation, data cannot be appended to the disc any more.

Final closure operation is done in the following sequence:

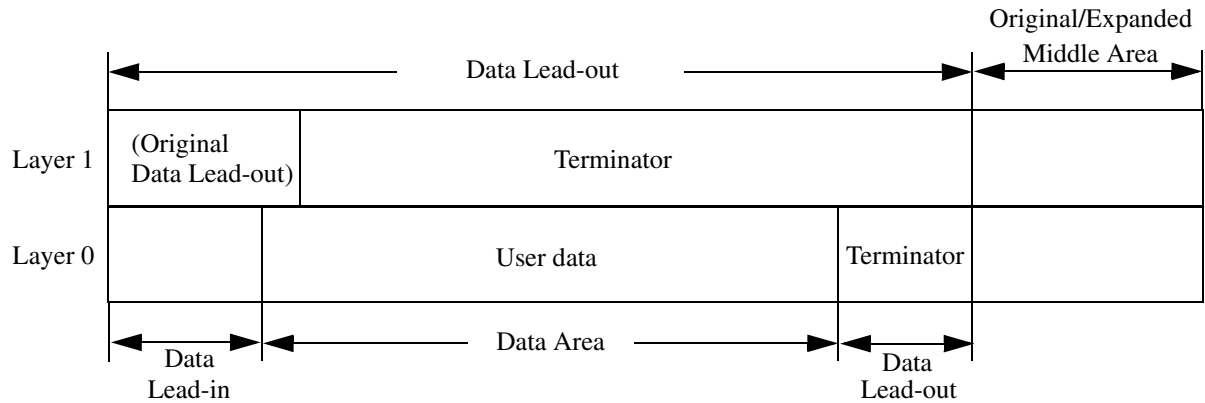
1. If opened RZone(s) exist, close all of the opened RZone(s).
2. Issue CLOSE TRACK/SESSION command with Close Function field = 110b.

The finalized disc structure is shown in Figure 168. Terminator is recorded on the rest of Data Area as shown in Figure 168 (1) or (2). Terminator is filled with 00h and the area type is set to the Data Lead-out area attribute. Data Lead-in, Middle Area and Data Lead-out are also recorded. If the size of the recorded user data is small, the size of Terminator can be shortened and Middle Area cannot be recorded to minimize the finalization time as shown in Figure 168 (3).

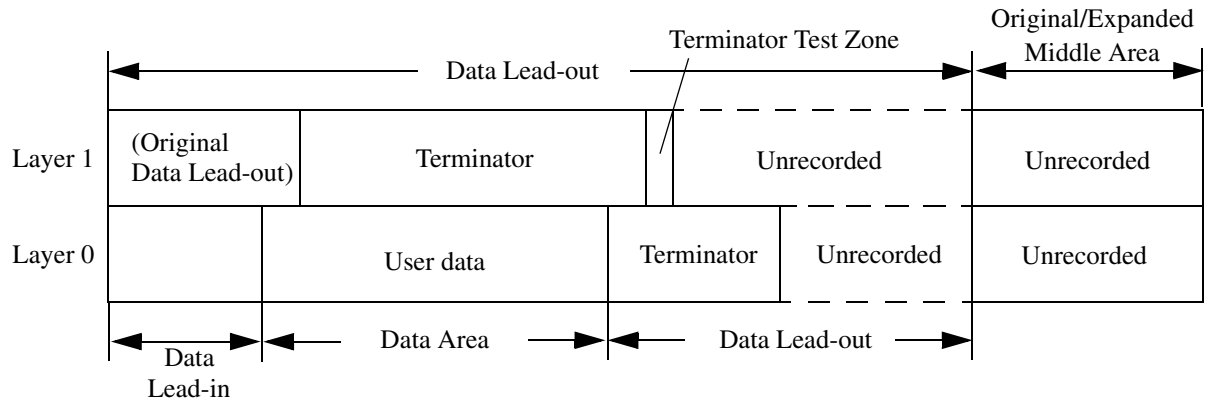
(1) Data is recorded in the whole Data Area on L0 and a part of Data Area on L1



(2) Data is recorded in a large part of Data Area on L0



(3) Data is recorded in a small part of Data Area on L0

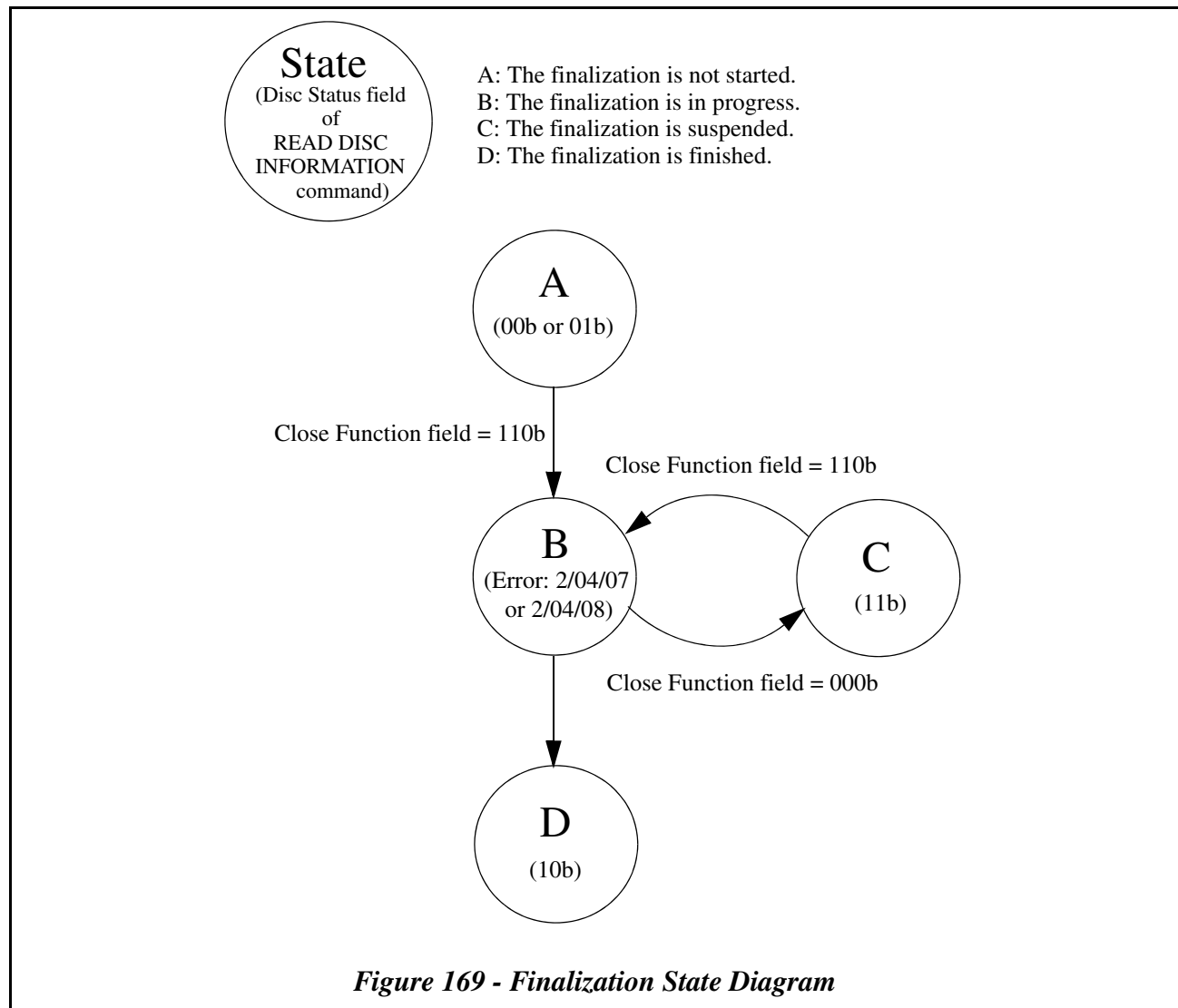


Terminator Test Zone is used for OPC.

Figure 168 - Example of final area structure

5.14.3.1 Disc Final Closure Suspension and Restart

It may take a long time to finalize the disc. For example, when the disc that only has the user data on L0 is finalized, it is necessary for compatibility with HD DVD-ROM to write the area on L1 about the same size as Terminator. Thus the disc final closure suspension is defined. If the host wants to suspend the finalization, it is required to issue CLOSE TRACK/SESSION command with Close Function field = 000b. It may take a certain time¹ before suspending the finalization. If the host restarts the finalization, then issues CLOSE TRACK/SESSION command with Close Function field = 110b. See Figure 169. To check whether the finalization has been completed or not, the host should issue READ DISC INFORMATION command and check Disc Status field. The values of Profile, current bit in Feature, Disc Status in RMD Field 0 and Disc Information Block data are shown in Table 203 to Table 206.



1. about up to 1 minute

Table 203 - Profile

A (Not started)	B (In progress)	C (Suspended)	D (Finished)
0058h (HD DVD-R Dual Layer)	0058h (HD DVD-R Dual Layer)	0058h (HD DVD-R Dual Layer)	0058h (HD DVD-R Dual Layer)

Table 204 - Current bit condition in Features

Feature	A (Not started)	B (In progress)	C (Suspended)	D (Finished)
HD DVD Read Feature	0b ^a or 1b	1b	1b	1b
HD DVD Write Feature/Incremental Streaming Writable Feature	1b	0b	0b	0b

a. When the disc is blank, HD DVD Read Feature is not current.

Table 205 - Disc Status in RMD Field 0

A (Not started)	B (In progress)	C (Suspended)	D (Finished)
00h or 02h	11h	11h	03h

Table 206 - Disc Information Block data

Field/Bit	A (Not started)	B (In progress)	C (Suspended)	D (Finished)
Status of Last Session	00b or 01b	- (2/04/07 ^a or	10b	11b
Disc Status	00b or 01b	2/04/08 ^b)	11b	10b

a. 2/04/07 LOGICAL UNIT NOT READY, OPERATION IN PROGRESS

b. 2/04/08 LOGICAL UNIT NOT READY, LONG WRITE IN PROGRESS

5.14.4 Example of write sequence

This section explains one example of a write sequence. See Table 207, Table 208 and Table 209.

Table 207 - Example of write sequence (blank disc)

Sequence	user/host	logical unit action
1	Insert blank disc	Check RMD in RDZ and RMZ
2	Expand Middle Area if needed (SEND DISC STRUCTURE command)	Write RMD in RMZ
3	Write Guard Track Zone on L0 ^a if needed (FORMAT UNIT command)	1. Write Guard Track Zone in Data Lead-in and Middle Area on L0 2. Write RMD in RMZ
4	Get NWA (READ TRACK INFORMATION command)	Calculate and send to host
7	Start writing from NWA (WRITE (10) command or WRITE (12) command)	Start writing
8	Start finalization (CLOSE TRACK/SESSION command)	1. Write RMD in RMZ (RMD Field 0: Disc Status field = 11h, Bit 5-6 of Padding Status field = 01b) 2. Start finalization

- a. For real-time recording, the host should issue FORMAT UNIT command (Format Type = 17h) before writing data. See 5.14.2.1 "Preparation for recording L1" on page 367.

Table 208 - Example of write sequence (non-blank disc)

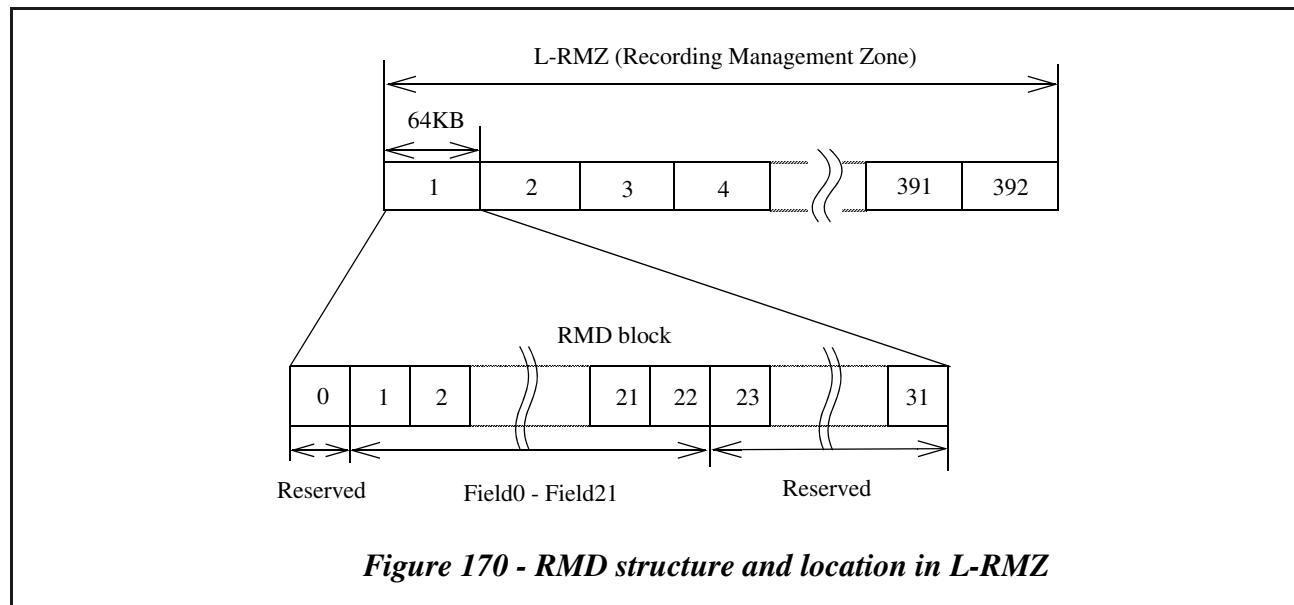
Sequence	user/host	logical unit action
1	Insert blank disc	Check RMD in RDZ and RMZ
2	Check status of Guard Track Zone on L0 (READ DISC STRUCTURE command)	Calculate and send to host
3	Write Guard Track Zone on L0 if needed (FORMAT UNIT command)	1. Write Guard Track Zone in Data Lead-in and Middle Area on L0 2. Write RMD in RMZ
4	Get NWA (READ TRACK INFORMATION command)	Calculate and send to host
5	Start writing from NWA (WRITE (10) command or WRITE (12) command)	Start writing
6	Start finalization (CLOSE TRACK/SESSION command)	1. Write RMD in RMZ (RMD Field 0: Disc Status field = 11h, Bit 5-6 of Padding Status field = 01b) 2. Start finalization

Table 209 - Example of write sequence (finalization suspended disc)

Sequence	user/host	logical unit action
1	Insert blank disc	Check RMD in RDZ and RMZ
2	Check disc status (READ DISC INFORMATION command)	Send to host
3	Restart finalization if needed (CLOSE TRACK/SESSION command)	1. Restart finalization

5.14.5 RMD (Recording Management Data)

The RMD is 64KBytes in length and is recorded as an ECC block. The RMD is recorded in L-RMZ. The L-RMZ size allows for 392 RMD updates. When the remaining L-RMZ is less than 15 ECC blocks and an RMD update is required by any command, the logical unit *shall* terminate the command with CHECK CONDITION status, 1/73/06 PROGRAM MEMORY AREA/RMA IS ALMOST FULL. When the remaining L-RMZ is less than 4 ECC blocks and an RMD update is required by any command¹, the logical unit *shall* terminate the command with CHECK CONDITION status, 3/73/05 PROGRAM MEMORY AREA/RMA IS FULL.



5.14.5.1 The contents of RMD

RMD contains 22 RMD Fields. The other sectors are reserved. Each RMD Field is 2048 bytes in length.

5.14.5.2 RMD Field 0 (RMD Header)

RMD Field 0 specifies general information of the disc and is recorded as follows.

Table 210 - RMD - Field 0

Bit Byte	7	6	5	4	3	2	1	0
0-1	(MSB) RMD Format							(LSB)
2	Disc Status							
3	Reserved							
4-21	(MSB) Unique Disc ID							(LSB)
22-33	(MSB) Data area allocation							(LSB)
34-45	(MSB) Renewed Data area allocation							(LSB)
46-47	(MSB) Padding Status							(LSB)
48-51	(MSB) Last recorded PSN of Terminator							(LSB)
52-99	(MSB) Drive test zone allocation							(LSB)
100-2 047	Reserved							

1. Except for CLOSE TRACK/SESSION command with Close Function field = 001b or 110b.

The RMD Format field specifies the RMD Format Code. The RMD Format Code indicates the recording format of the RMD. These bytes are set to 0001h.

The Disc Status field indicates the disc status. Disc Status field is defined in Table 210.

Table 211 - Disc Status field definition

Value	Interpretation
00h	To indicate that the disc has no written data in Data Recordable Area (only RMD is written)
02h	To indicate that the disc is recorded and not finalized
03h	To indicate that the disc is finalized
08h	To indicate that the disc is in recording mode U ^a
11h	To indicate that format operation is in progress ^b
Others	Reserved

- a. Mode U is prepared for a drive specific recording. If the disc which is recorded by mode U is incompatible with a disc which is recorded by incremental recording, this value is set. After finalizing the disc, the disc is compatible with a disc which is finalized after incremental recording.
- b. Finalization was started and is not completed.

The Unique Disc ID field is recorded and structured as defined in Table 212. The Unique Disc Identifier contains time stamp fields. The time format should be UTC 24 hour clock¹. This field *shall* be set by the SEND DISC STRUCTURE command. This time stamp data sent by the SEND DISC STRUCTURE command may also be used in the OPC related field in RMD field 1 and may help the judgement to do OPC. The logical unit *shall* update the time stamp during power on. Strict accuracy of time is not required.

Table 212 - Unique Disc ID

Bit Byte	7	6	5	4	3	2	1	0
0-1	Reserved							
2-3	(MSB) Random Data							(LSB)
4-7	(MSB) Year							(LSB)
8-9	(MSB) Month							(LSB)
10-11	(MSB) Day							(LSB)
12-13	(MSB) Hour							(LSB)
14-15	(MSB) Minute							(LSB)
16-17	(MSB) Second							(LSB)

The Random Data field is a random number.

The Year field specifies the year coded in ASCII in the range “0001” to “9999”.

The Month field specifies the month of the year coded in ASCII in the range “01” to “12”.

The Day field specifies the day of the month coded in ASCII in the range “01” to “31”.

The Hour field specifies the hour of the day coded in ASCII in the range “00” to “23”.

The Minute field specifies the minute of the hour coded in ASCII in the range “00” to “59”.

1. UTC = universal time coordinated

The **Second** field specifies the second of the minute coded in ASCII in the range “00” to “59”.

The **Data area allocation** field is recorded and structured as defined in Table 213.

Table 213 - Data area allocation

Bit Byte	7	6	5	4	3	2	1	0
22	00h							
23-25	Start PSN of the Data area (PSN = 40000h)							
26	00h							
27-29	Maximum PSN of Data Recordable area (PSN = FBCCFFh)							
30	00h							
31-33	End PSN on Layer 0 (PSN = 73DBFFh)							

The **Renewed Data area allocation** field is recorded and structured as defined in Table 214.

Table 214 - Renewed data area allocation

Bit Byte	7	6	5	4	3	2	1	0
34	Renewal descriptor							
35-37	Start PSN of the Data area (PSN = 40000h)							
38	00h							
39-41	Maximum PSN of Data Recordable area							
42	00h							
43-45	End PSN on Layer 0							

The **Renewal descriptor** field specifies the relocation of the Data Area, defined in Table 215.

Table 215 - Renewal descriptor

Bit	Definition
7-2	Reserved
1	0b: Maximum PSN of data recordable area has not been changed. 1b: Maximum PSN of data recordable area has been changed.
0	0b: Middle Area expansion has not been executed. 1b: Middle Area expansion has been executed.

The **Maximum PSN of Data Recordable area** field specifies the end PSN of data recordable area. In the case of reserving RZone, the PSN is changed.

The **End PSN on Layer 0** field specifies the end PSN of the Data Area on L0. In the case that the Middle Area expansion is executed, the PSN is changed.

The **Padding Status** field indicates the disc status. **Padding Status** field is defined in Table 216.

Table 216 - Padding Status

Bit	Definition
15	0b: The inner Guard Track Zone on Layer 0 is not padded. 1b: The inner Guard Track Zone on Layer 0 is padded.
14	0b: The inner Drive Test Zone on Layer 0 is not padded. 1b: The inner Drive Test Zone on Layer 0 is padded.
13	0b: The RDZ is not padded. 1b: The RDZ is padded.
12	0b: The Reference Code Zone is not padded. 1b: The Reference Code Zone is padded.
11	0b: The outer Guard Track Zone on Layer 0 is not padded. 1b: The outer Guard Track Zone on Layer 0 is padded.
10	0b: The outer Drive Test Zone on Layer 0 is not padded. 1b: The outer Drive Test Zone on Layer 0 is padded.
9	0b: The Extra Guard Track Zone is not padded or not assigned. 1b: The Extra Guard Track Zone is padded.
8	0b: The Extra Drive Test Zone on Layer 0 is not padded or not assigned. 1b: The Extra Drive Test Zone on Layer 0 is padded.
7	0b: The outer Guard Track Zone on Layer 1 is not padded. 1b: The outer Guard Track Zone on Layer 1 is padded.
6-5	00b: The recording of Terminator is not started. 01b: The recording of Terminator is in progress. 10b: Reserved 11b: The recording of Terminator is finished.
Others	Reserved

Last recorded PSN of Terminator field specifies the PSN of the last recorded physical sectors of the Terminator. If this field is set to 0, this field is invalid.

Drive test zone allocation field is structured as defined in Table 217.

Table 217 - Test zone allocation

Bit Byte	7	6	5	4	3	2	1	0
52-55	Start PSN of the inner Drive Test Zone on Layer 0							
56-59	Size of the inner Drive Test Zone on Layer 0							
60-63	Start PSN of the inner Drive Test Zone on Layer 1							
64-67	Size of the inner Drive Test Zone on Layer 1							
68-71	Start PSN of the outer Drive Test Zone on Layer 0							
72-75	Size of the outer Drive Test Zone on Layer 0							
76-79	Start PSN of the outer Drive Test Zone on Layer 1							
80-83	Size of the outer Drive Test Zone on Layer 1							
84-87	Start PSN of the Extra Drive Test Zone on Layer 0							
88-91	Size of the Extra Drive Test Zone on Layer 0							
92-95	Start PSN of the Extra Drive Test Zone on Layer 1							
96-99	Size of the Extra Drive Test Zone on Layer 1							

5.14.5.3 RMD Field 1

RMD Field 1 contains some logical unit and OPC related information and is recorded as defined in Table 218. There are four sets of OPC data blocks. The OPC related information of the present drive is always recorded in the field #1. If the field #1 of the current RMD does not contain the present drive information, which consists of Drive manufacturer ID, Serial number and Model number, the information in the field #1 to #3 of the current RMD is copied to the field #2 to #4 of the new RMD and the information in the field #4 of the current RMD is discarded. If the field #1 of the current RMD contains the present drive information, the information of the field #2 to #4 of the new RMD. In every case, the unused fields of the RMD Field1 is set to 00h.

Table 218 - RMD - Field 1 (logical unit & OPC information)

Bit Byte	7	6	5	4	3	2	1	0
0-31	Drive manufacturer ID#1							
32-47	Serial Number #1							
48-63	Model Number #1							
64-71	Time stamp #1							
72-75	Inner Drive Test Zone address for Layer 0 #1							
76-79	Outer Drive Test Zone address for Layer 0 #1							
80-103	Running OPC Information #1							
104-105	DSV #1							
106	Test zone usage descriptor #1							
107	Reserved #1							
108-112	Inner Drive Test Zone address for Layer 1 #1							
113-115	Outer Drive Test Zone address for Layer 1 #1							
116-119	Extra Drive Test Zone address for Layer 0 #1							
120-123	Extra Drive Test Zone address for Layer 1 #1							
124-127	Reserved #1							
128-191	Drive specific data #1							
192-255	Reserved #1							
256-287	Drive manufacturer ID #2							
288-303	Serial Number #2							
304-319	Model Number #2							
320-327	Time stamp #2							
328-331	Inner Drive Test Zone address for Layer 0 #2							
332-335	Outer Drive Test Zone address for Layer 0 #2							
336-359	Running OPC Information #2							
360-361	DSV #2							
362	Test zone usage descriptor #2							
363	Reserved #2							
364-367	Inner Drive Test Zone address for Layer 1 #2							
368-371	Outer Drive Test Zone address for Layer 1 #2							
372-375	Extra Drive Test Zone address for Layer 0 #2							
376-379	Extra Drive Test Zone address for Layer 1 #2							
380-383	Reserved #2							
384-447	Drive specific data #2							
448-511	Reserved #2							
:	:							
768-799	Drive manufacturer ID#4							

Table 218 - RMD - Field 1 (logical unit & OPC information) (continued)

Bit Byte	7	6	5	4	3	2	1	0
800-815	Serial Number #4							
816-831	Model Number #4							
832-839	Time stamp #4							
840-843	Inner Drive Test Zone address for Layer 0 #4							
844-847	Outer Drive Test Zone address for Layer 0 #4							
848-871	Running OPC Information #4							
872-873	DSV #4							
874	Test zone usage descriptor #4							
875	Reserved #4							
876-879	Inner Drive Test Zone address for Layer 1 #4							
880-883	Outer Drive Test Zone address for Layer 1 #4							
884-887	Extra Drive Test Zone address for Layer 0 #4							
888-891	Extra Drive Test Zone address for Layer 1 #4							
892-895	Reserved #4							
896-959	Drive specific data #4							
960-1 023	Reserved #4							
1 024-1 279	Drive specific data #1							
1 280-1 535	Drive specific data #2							
1 536-1 791	Drive specific data #3							
1 792-2 047	Drive specific data #4							

The Drive manufacturer ID #n field is recorded in binary and specifies unique drive manufacturer identifier of the logical unit.

The Serial Number #n field is recorded as ASCII code and specifies serial number of the logical unit.

The Model Number #n field is recorded as ASCII code and specifies the recorder model number.

The Timestamp #n field may be used to store date and time when OPC is performed. This field, if used, is recorded in binary. If this field is set to 0, this field is invalid.

The Inner Drive Test Zone address for Layer 0 #n field is recorded in binary and specifies the smallest ECC block address of the Drive Test Zone in the Data Lead-in area where the last power calibration is performed. If these fields are set to 00h, then they are invalid.

The Outer Drive Test Zone address for Layer 0 #n field is recorded in binary and specifies the smallest ECC block address of the Drive Test Zone in the Middle Area where the last power calibration is performed. If these fields are set to 00h, then they are invalid.

The Running OPC Information field may be used to specify values concerning running OPC. The format is vendor-specific. If this field is set to 0, this field is invalid.

If the disc is incrementally recorded and when RMD is updated, the DSV field is recorded. This field is used to specify the last DSV (Digital Sum Value) in binary notation. If this field is set to 0, this field is invalid.

The Test zone usage descriptor #n field specifies the usage for the 4 test zones.

Table 219 - Test zone usage descriptor

Bit	Definition
6 - 7	Reserved
5	0b: The drive did not use the Extra Drive Test Zone on Layer 0. 1b: The drive used the Extra Drive Test Zone on Layer 0.
4	0b: The drive did not use the Extra Drive Test Zone on Layer 1. 1b: The drive used the Extra Drive Test Zone on Layer 1.
3	0b: The drive did not use the inner Drive Test Zone on Layer 0. 1b: The drive used the inner Drive Test Zone on Layer 0.
2	0b: The drive did not use the outer Drive Test Zone on Layer 0. 1b: The drive used the outer Drive Test Zone on Layer 0.
1	0b: The drive did not use the inner Drive Test Zone on Layer 1. 1b: The drive used the inner Drive Test Zone on Layer 1.
0	0b: The drive did not use the outer Drive Test Zone on Layer 1. 1b: The drive used the outer Drive Test Zone on Layer 1.

The Inner Drive Test Zone address for Layer 1 #n field is recorded in binary and specifies the start ECC block address of the Drive Test Zone in the Data Lead-out area where the last power calibration is performed. If these fields are set to 00h, then they are invalid.

The Outer Drive Test Zone address for Layer 1 #n field is recorded in binary and specifies the start ECC block address of the Drive Test Zone in the Middle Area where the last power calibration is performed. If these fields are set to 00h, then they are invalid.

The Extra Drive Test Zone address for Layer 0 #n field is recorded in binary and specifies the start ECC block address of the Drive Test Zone in the Middle Area where the last power calibration is performed. If these fields are set to 00h, then they are invalid.

The Extra Drive Test Zone address for Layer 1 #n field is recorded in binary and specifies the start ECC block address of the Drive Test Zone in the Middle Area where the last power calibration is performed. If these fields are set to 00h, then they are invalid.

5.14.5.4 RMD Field 2

RMD Field 2 can be used freely and format of this field is user-specific.

Table 220 - RMD - Field 2 (User Specific Data)

Bit	7	6	5	4	3	2	1	0
Byte								
0-2 047	User Specific Data							(LSB)

The User Specific Data field is available for user specific data. This field may be used, otherwise this field is set to 0.

5.14.5.5 RMD Field 3

RMD Field 3 is reserved.

5.14.5.6 RMD Field 4

RMD Field 4 contains RZone related information and is recorded as follows.

Table 221 - RMD - Field 4 (RZone Information)

Bit Byte	7	6	5	4	3	2	1	0
0-1	(MSB) Invisible/Incomplete RZone Number (last RZone number)							(LSB)
2-3	(MSB) First Open RZone number							(LSB)
4-5	(MSB) Second Open RZone number							(LSB)
6-15	Reserved							
16-19	(MSB) Start PSN of RZone #1							(LSB)
20-23	(MSB) Last Recorded PSN of RZone #1							(LSB)
24-27	(MSB) Start PSN of RZone #2							(LSB)
28-31	(MSB) Last Recorded PSN of RZone #2							(LSB)
:	:							
2 032-2 035	(MSB) Start PSN of RZone #253							(LSB)
2 036-2 039	(MSB) Last Recorded PSN of RZone #253							(LSB)
2 040-2 043	(MSB) Start PSN of RZone #254							(LSB)
2 044-2 047	(MSB) Last Recorded PSN of RZone #254							(LSB)

The Invisible/Incomplete RZone Number field contains the Invisible/Incomplete RZone number of the medium. If the last RZone state is neither Invisible nor Incomplete due to disc finalization, this field contains the last complete RZone number.

The First Open RZone Number field, if recorded with value other than 0, contains the current appendable Reserved RZone number and the value is different from the Second Open RZone Number field. If this field is set to 0, there is no Empty Reserved RZone or Partially Recorded Reserved RZone corresponding to this field.

The Second Open RZone Number field, if recorded with value other than 0, contains the current appendable Reserved RZone number and the value is different from the First Open RZone Number field. If this field is set to 0, there is no Empty Reserved RZone or Partially Recorded Reserved RZone corresponding to this field.

When the Incomplete RZone is closed, the Invisible/Incomplete RZone Number field contains the number of the new invisible RZone number (N+1). When Reserved RZone is closed, the corresponding Current Appendable Reserved RZone Number field shall be set to 0.

The Start PSN of RZone #n field contains the start PSN of the RZone which has RZone number #n.

The Last Recorded PSN of RZone #n field contains the last recorded PSN of the RZone which has RZone number #n. If this field is set to 0, this field is not valid. If RZone #n is not closed, the value of this field may not be correct and logical unit *shall* search the correct LRA (Last Recorded Address) by other method. When RZone is closed, this field contains the last PSN of the data except the padding data in the RZone.

Note: The LRA information in the latest RMD may not be correct. Host can get the correct LRA by the READ TRACK INFORMATION command. In this case, logical unit reports the correct LRA not by using the latest RMD. See condition 5 in Table 223 - Mandatory RMD update condition in RMZ on page 388.

5.14.5.7 RMD Field 5 - Field 21

RMD Field 5 through Field 21 may contain RZone related information continued from RMD Field 4.

Table 222 - RMD - Field 5 - Field 21 (RZone Information ... continued)

Bit Byte	7	6	5	4	3	2	1	0
0-3	(MSB) Start PSN of RZone #n							(LSB)
4-7	(MSB) Last Recorded PSN of RZone #n							(LSB)
8-11	(MSB) Start PSN of RZone #(n+1)							(LSB)
12-15	(MSB) Last Recorded PSN of RZone #(n+1)							(LSB)
:	:							
2 032-2 035	(MSB) Start PSN of RZone #(n+254)							(LSB)
2 036-2 039	(MSB) Last Recorded PSN of RZone #(n+254)							(LSB)
2 040-2 043	(MSB) Start PSN of RZone #(n+255)							(LSB)
2 044-2 047	(MSB) Last Recorded PSN of RZone #(n+255)							(LSB)

The Start PSN of RZone #n field contains start PSN of the RZone which has RZone number #n.

The Last Recorded PSN of RZone #n field contains the last recorded PSN of the RZone which has RZone number #n. If this field is set to 0, this field is not valid. If RZone #n is not closed, the value of this field may not be correct and logical unit *shall* search the correct LRA (Last Recorded Address) by other method.

When the RZone is not closed, even if the Last Recorded PSN of RZone #n field contains a value, the logical unit determines the current LRA of the RZone. When RZone is closed, this field contains the last PSN of the data except the padding data in the RZone.

Note: The LRA information in the latest RMD may not be correct. Host can get the correct LRA by the READ TRACK INFORMATION command. In this case, logical unit reports the correct LRA not by using the latest RMD. See condition 5 in Table 223 - Mandatory RMD update condition in RMZ on page 388.

5.14.5.8 Update timing of RMD in RMZ

The RMD *shall* be written on the disc in the conditions described in Table 223.

Table 223 - Mandatory RMD update condition in RMZ

	Condition	Update timing
1	RZone reservation	When RESERVE TRACK command is issued.
2	RZone closure/Finalization/Finalization suspension	When a CLOSE TRACK/SESSION command with Close Function field = 000b, 001b or 110b is issued.
3	Guard Track Zone on L0 recording	When a FORMAT UNIT command (Format Type = 17h) is issued.
4	Middle Area expansion	When a SEND DISC STRUCTURE command (Format Code = 20h) is issued.
5	OPC	When an OPC operation is done, RMD <i>shall</i> be updated prior to medium ejection or entering the sleep state.
6	Threshold of data size	When the difference between the last recorded sector number in fact and “Last Recorded Address of RZone #n” recorded in the latest RMD is larger than 77 MB (9400h sectors) ^a . However if the logical unit is busy (e.g., writing is in progress), the update may be done at a later time.

a. To force updating the RMD, the host should close the Incomplete RZone.

By using RMD caching, the logical unit can avoid waste of RMZ. The latest RMD *shall* be written in RMZ prior to removing the disc from the logical unit, when the contents of the cached RMD is different from the contents of the latest RMD on the disc. But when the difference between the last recorded sector number in fact and “Last Recorded Address of RZone #n” recorded in the latest RMD is less than 77 MB (9400h sectors), there is no need for writing the cached RMD on the disc.

In the case of condition 5 and condition 6 in Table 223, when the number of the unrecorded ECC blocks in L-RMZ is less than or equal to 8, RMD *shall not* be written except for the disc removal.

5.15 Recording for HD DVD-RW Single Layer media

HD DVD-RW SL media consist of Lead-in Area, Data Area and Lead-out Area which are based on HD DVD-R SL media.

5.15.1 Recording mode

HD DVD-RW SL media support two different recording modes that are Sequential formatting mode and Fragment recording mode. The recording mode setting by FORMAT UNIT command is required in advance to use the disc as available for writing of user data. According to write protection, see *Section 12.0, "Write protection model"* on page 497.

5.15.1.1 Sequential formatting mode

When a disc is in Sequential formatting mode, the logical unit is able to overwrite randomly within the addressable area on the disc. However, there are some restrictions. See Section 5.15.4.3. The recorded area information is managed by using RMD Field 4. If the disc is in Intermediate state (Section 5.15.2.2), the logical unit is able to append data from NWA that appears during Intermediate state.

5.15.1.2 Fragment recording mode¹

When a disc is in Fragment recording mode, the logical unit is able to overwrite randomly¹ within the original Data Area on the disc. The addressable area information is managed by using ECC block pair status bit map (RMD Field 6 to RMD Field 13). See Section 5.15.4.3.

5.15.2 Disc state

A disc state is classified into five different states. These states are called Empty state, Intermediate state in Sequential formatting mode, Finalized state in Sequential formatting mode, Intermediate state in Fragment recording mode and Full-finalized state.

5.15.2.1 Empty state

In Empty state, the disc is not formatted. A physically blank disc *shall* be in Empty state. And after blanking logically by BLANK command, the disc *shall* enter Empty state.

R-PFI Zone is unrecorded or is recorded with the physical format information in which Last PSN of RZone field is set to 0.

5.15.2.2 Intermediate state in Sequential formatting mode

After formatting by "Quick format" or "Quick Grow format", the disc *shall* be in Intermediate state in Sequential formatting mode.

The addressable area is formed from the start PSN of Data Area. The addressable area is filled with any data whose Area type is Data Area. Example of the disc structure is shown in Figure 171. R-PFI Zone is unrecorded or is recorded with the physical format information in which Last PSN of RZone field is set to 0.

1. Read and write operations for Intermediate state disc are not required in physical specification.

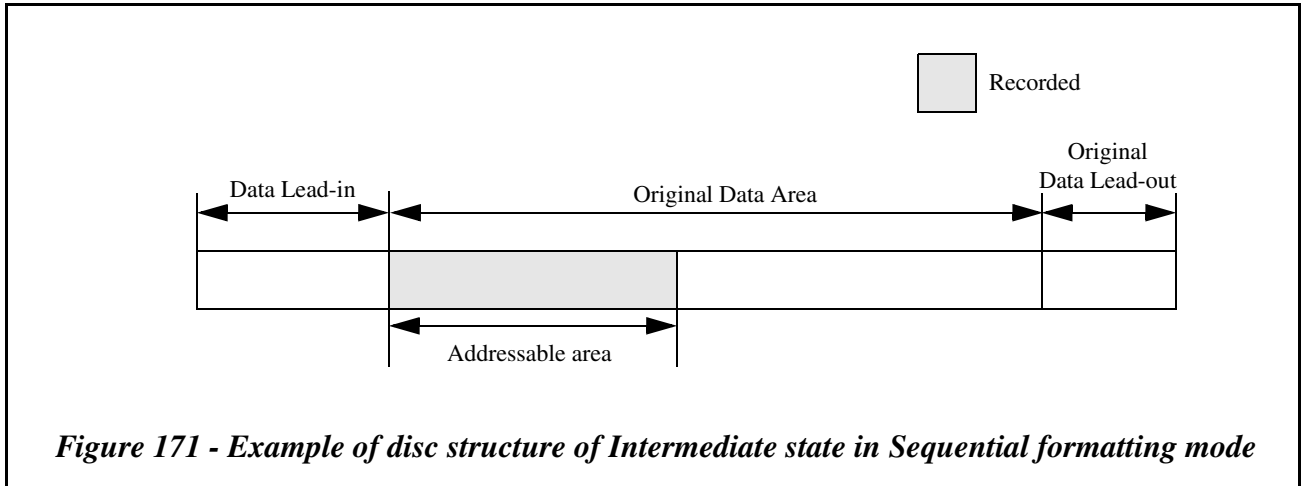


Figure 171 - Example of disc structure of Intermediate state in Sequential formatting mode

5.15.2.3 Finalized state in Sequential formatting mode

After formatting by “Full format”, “HD DVD-RW full format” or “Grow format”, or Finalization, the disc *shall* be in Finalized state in Sequential formatting mode and has ROM compatibility.

Terminator is recorded in the adjacent part to RZone. The start PSN of Terminator is equal to or larger than PSN 4FE00h and smaller than PSN 735440h. Terminator is started at an ECC block boundary. The size of Terminator depends on its location. See Table 224. RZone is filled with any data whose Area type is Data Area. Terminator data is set to 00h, and its Area type is Data Lead-out. In Data Lead-in Area, the latest RMD is copied in RDZ, L-RMZ is fully recorded, R-PFI Zone is recorded with the physical format information in which Last PSN of RZone field is set and Reference Code Zone is recorded.

Table 224 - Terminator size in Sequential mode

The start PSN of Terminator	4FE00h to 1D0DFh	1D0E00h to 411BFFh	411C00h to 735440h
Terminator size (ECC blocks)	290	380	480

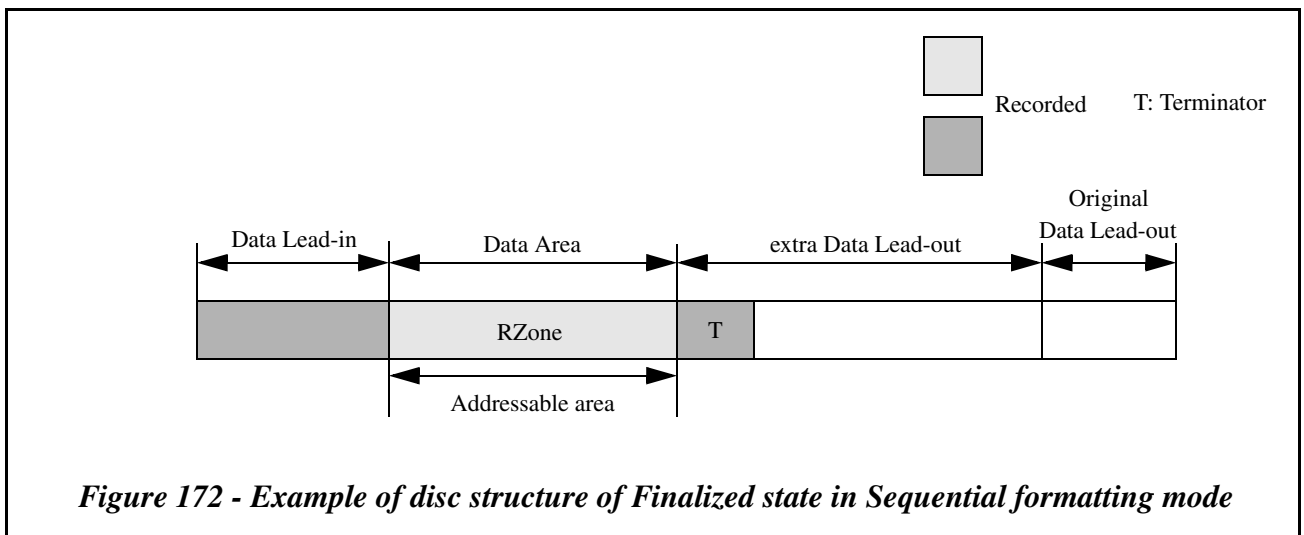
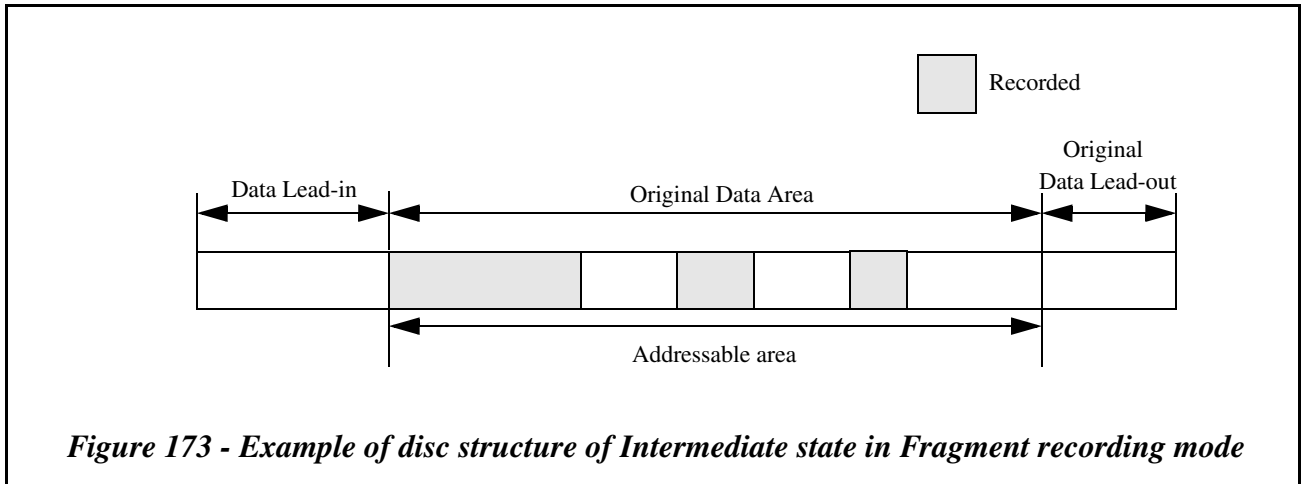


Figure 172 - Example of disc structure of Finalized state in Sequential formatting mode

5.15.2.4 Intermediate state in Fragment recording mode

After formatting by “Fragment recording format”, the disc *shall* be in Intermediate state in Fragment recording mode.

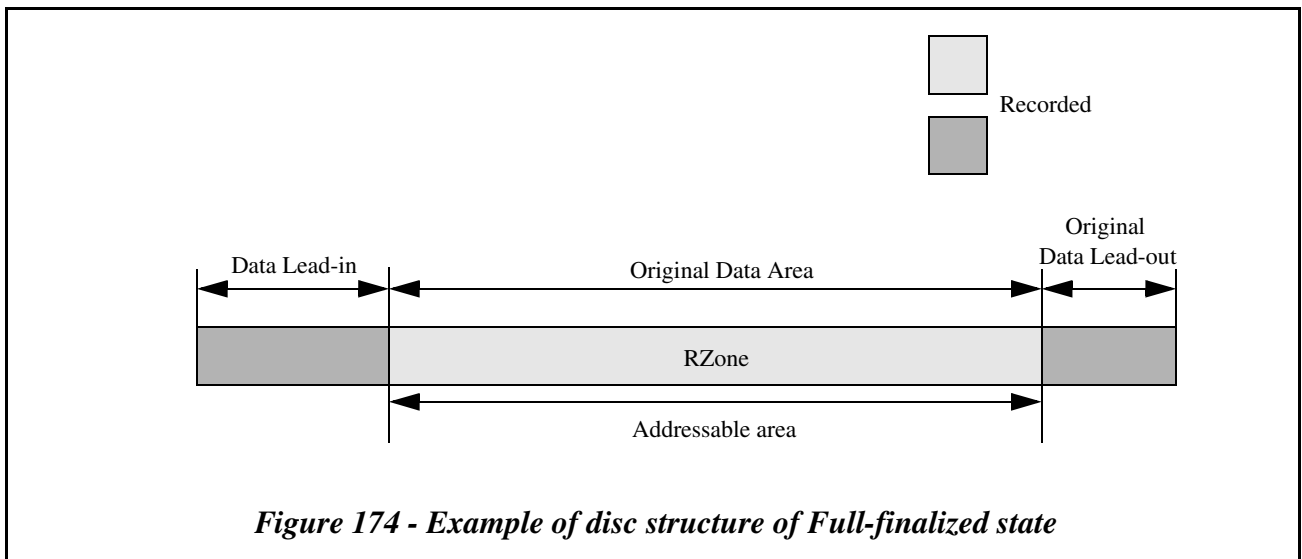
The recorded part can be created at any portion of the original Data Area in units of ECC block pair. All original Data Area is addressable. R-PFI Zone is unrecorded or is recorded with the physical format information in which Last PSN of RZone field is set to 0.



5.15.2.5 Full-finalized state

After completing the formatting by “Full format” with full capacity, “HD DVD-RW full format” with full capacity, Full-finalization¹ or Background Padding of “Fragment recording format”, the disc *shall* be in Full-finalized state and has ROM compatibility.

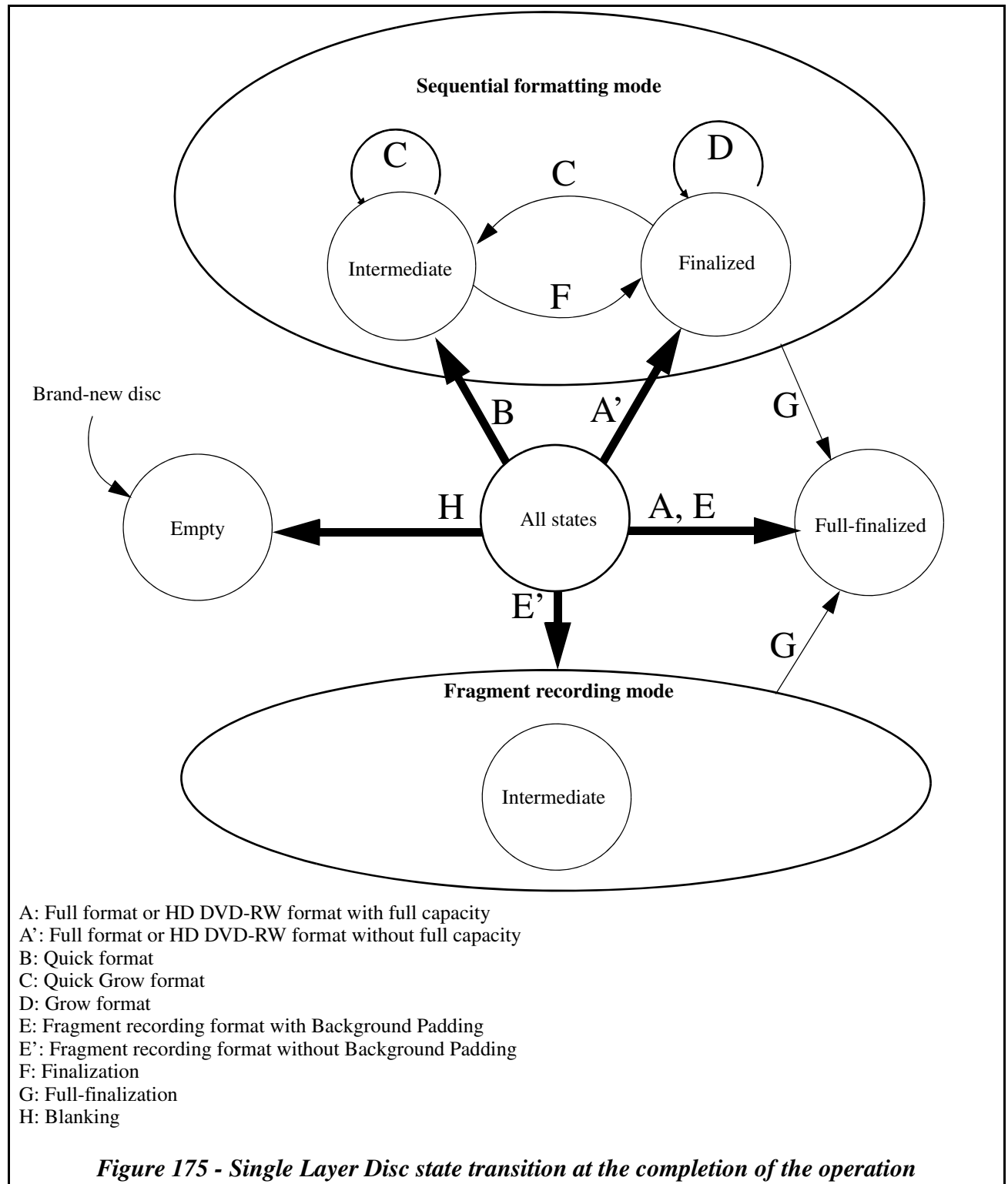
The original Data Area is fully recorded with any data whose Area type is Data Area. All original Data Area is addressable. In Data Lead-in Area, the latest RMD is copied in RDZ, L-RMZ is fully recorded, R-PFI Zone is recorded with the physical format information in which Last PSN of RZone field is set and Reference Code Zone is recorded. Guard Track Zone in the original Lead-out Area is recorded.



1. After Finalization for the disc which the addressable area size equals to the original Data Area size, the disc *shall* be Full-finalized state.

5.15.2.6 Disc state transition

Figure 175 shows the disc state transition at the completion of the operation. In case of the disc state transition at the interruption of the operation, see section 5.15.5.7 on page 397, section 5.15.6.3 on page 400 or section 5.15.7.3 on page 402.



5.15.3 ECC block pair status bit map

Two contiguous ECC blocks is called ECC block pair. The bit which is called ECC block pair status bit is assigned to the recorded condition of each ECC block pair. When an ECC block pair is recorded with whose Area type is Data Area, the corresponding ECC block pair status bit *shall* be set to 1b. Otherwise the bit *shall* be set to 0b. The ECC block pair status bit map *shall* be described through RMD Field 6 to Field 13. See Section 5.15.9.8 and Section 5.15.9.9.

When the bit is set to 0, an ECC block pair is not recorded physically or logically regardless of Area type.

When the bit is set to 1, an ECC block pair is recorded with whose Area type is Data Area.

In Sequential formatting mode, logical unit cannot obtain the size of the addressable area from ECC block pair status bit map and can obtain it from RZone information in RMD Field 4.

5.15.4 Data writing and reading

5.15.4.1 Data writing and reading on an Intermediate state in Sequential formatting mode

When a disc is in Intermediate state in Sequential formatting mode, the logical unit reports the NWA where the last addressable block plus 1 of RZone. The disc can be overwritten within the addressable area less than the NWA and data is sequentially appendable from the NWA to the full capacity of a disc. The NWA is reported by READ TRACK INFORMATION command.

To change Intermediate state to Finalized state, CLOSE TRACK/SESSION command (Close Function=010b)¹ is used. To change Intermediate state to Full-finalized state, CLOSE TRACK/SESSION command (Close Function=110b) is used.

When a WRITE is applied on the NWA, and then SYNCHRONIZE CACHE (10) command is issued, the logical unit *shall* update RMD to reflect the addressable area size. When RMD is recorded, the ECC block pair status bit map² *shall* be renewed.

Attempting to read a portion which is beyond the addressable area *shall* be caused CHECK CONDITION Status, 8/00/00 BLANK CHECK.

5.15.4.2 Data writing and reading on an Intermediate state in Fragment recording mode

When a disc is in Intermediate state in Fragment recording mode, the logical unit *shall not* report a NWA. The disc can be overwritten within the original Data Area.

When only one of ECC block of a ECC block pair is requested to record user data by a host and the ECC block pair status bit is 0b, the other ECC block of the ECC block pair *shall* be padded with 00h data whose Area type is Data Area.

To change Intermediate state to Full-finalized state, CLOSE TRACK/SESSION command (Close Function=110b) is used. If the logical unit support Background Padding, the host may restart Background Padding. See 5.15.5.6.1 "Background Padding" on page 396.

The logical unit *shall* update RMD by receiving SYNCHRONIZE CACHE (10) command if it is necessary to change the ECC block pair status bit map.

Note: If a power-off is occurred when the disc is in Intermediate state, the recording condition may not be updated and the recorded user data may be lost. Therefore to update RMD, the host should issue SYNCHRONIZE CACHE (10) command. When the disc state is Full-finalized state the logical unit need not update RMD by receiving SYNCHRONIZE CACHE (10) command.

5.15.4.3 Restriction of writing

There are some restrictions when overwriting is performed on HD DVD-RW SL media. The logical unit is able to record data only by the multiple of ECC block length. Host *shall* write data in integral multiple of 32 sectors starting at a logical block address that is an integral multiple of 32. If a WRITE command does not start at the integral multiple of 32 logical block address, the command *shall* be terminated with CHECK CONDITION Status, 5/21/02 INVALID ADDRESS FOR

1. For the disc which the addressable area size equals to the original Data Area size, the disc *shall* be in Full-finalized state.
2. See Section 5.15.3.

WRITE. If Transfer Length field value of WRITE command is not an integral multiple of 32 sectors, the command *shall* be terminated with CHECK CONDITION Status, 5/24/00 INVALID FIELD IN CDB. The logical unit does not perform hardware defect management, Read Modify Write, and Verify after Write.

5.15.5 Formatting

The format operation is required in advance to use a disc. Six format operations are defined. They are called “Full format”, “HD DVD-RW Full format”, “Grow format”, “Quick format”, “Quick Grow format” and “Fragment recording format”. These format operations except for “Fragment recording format” are similar to DVD-RW’s format operations. The format length *shall* be multiple of ECC block size. If the format length is not an integral multiple of ECC block size, the logical unit *shall* round up the value of Number of Blocks field in the Format Descriptor up to an integral multiple of the ECC block size. The addressable area is expandable up to the full capacity of the disc.

In all format operation, to minimize formatting time logical unit does not need to overwrite a previous written ECC block whose Area type is Data Area. The logical unit can obtain the recording status of the original Data Area from Last PSN of RZone field in RMD Field 4 and ECC block pair status bit map in RMD Field 6 to 13.

5.15.5.1 Full format

“Full format” *shall* be available for any state. The addressable area *shall* be created from the beginning of the original Data Area with a specified size. The disc state *shall* become Finalized state. In case that the specified size equals to the original Data Area size, the disc state *shall* become Full-finalized state.

5.15.5.2 HD DVD-RW Full format

“HD DVD-RW Full format” is identical to “Full format”.

5.15.5.3 Grow format

“Grow format” *shall* be available for Finalized state in Sequential formatting mode. The addressable area *shall* be expanded with a specified size. The disc state remains in Finalized state in Sequential formatting mode. If the addressable area size equals to original Data Area size by the formatting, the disc state *shall* be changed to Full-finalized state.

5.15.5.4 Quick format

“Quick format” *shall* be available for any state. The addressable area *shall* be created from the beginning of original Data Area with a specified size. The disc state *shall* become Intermediate state in Sequential formatting mode.

5.15.5.5 Quick Grow format

“Quick Grow format” *shall* be available for Intermediate state in Sequential formatting mode and Finalized state in Sequential formatting mode. The addressable area *shall* be expanded with a specified size. The disc state *shall* become Intermediate state in Sequential formatting mode.

5.15.5.6 Fragment recording format

“Fragment recording format” *shall* be available for any state. The disc state *shall* become Intermediate state in Fragment recording mode and HD DVD-RW Fragment Recording Feature *shall* be current. If Background Padding is completed, the disc state *shall* become Full-finalized state. See Section 5.15.5.6.1, “Background Padding” on page 396 about Background Padding.

If a logical unit does not support Background Padding operation, the logical unit *shall* set BGP bit to 0 in the HD DVD-RW Fragment Recording Feature Descriptor. If FORMAT UNIT command with Format Type 19h is issued, the logical unit *shall* record RMD and R-PFI if needed.

If a logical unit supports Background Padding operation, the logical unit *shall* set BGP bit to 1. If FORMAT UNIT command with Format Type 19h is issued, the logical unit *shall* perform Background Padding.

5.15.5.6.1 Background Padding

Background Padding operation is to make Full-finalized state disc automatically by the logical unit. At the beginning of Background Padding the logical unit *shall* record RMD in foreground. After recording RMD the logical unit *shall* pad

00h data on all of the parts whose ECC block pair status bit map values are 0 and record the original Lead-out Area and Lead-in Area in background.

If a host requests to read or write data on the disc during Background Padding, the logical unit *shall* stop Background Padding and *shall* execute a host requested operation. When the host requested operation is finished, Background Padding *shall* be started again.

5.15.5.7 Formatting Stop

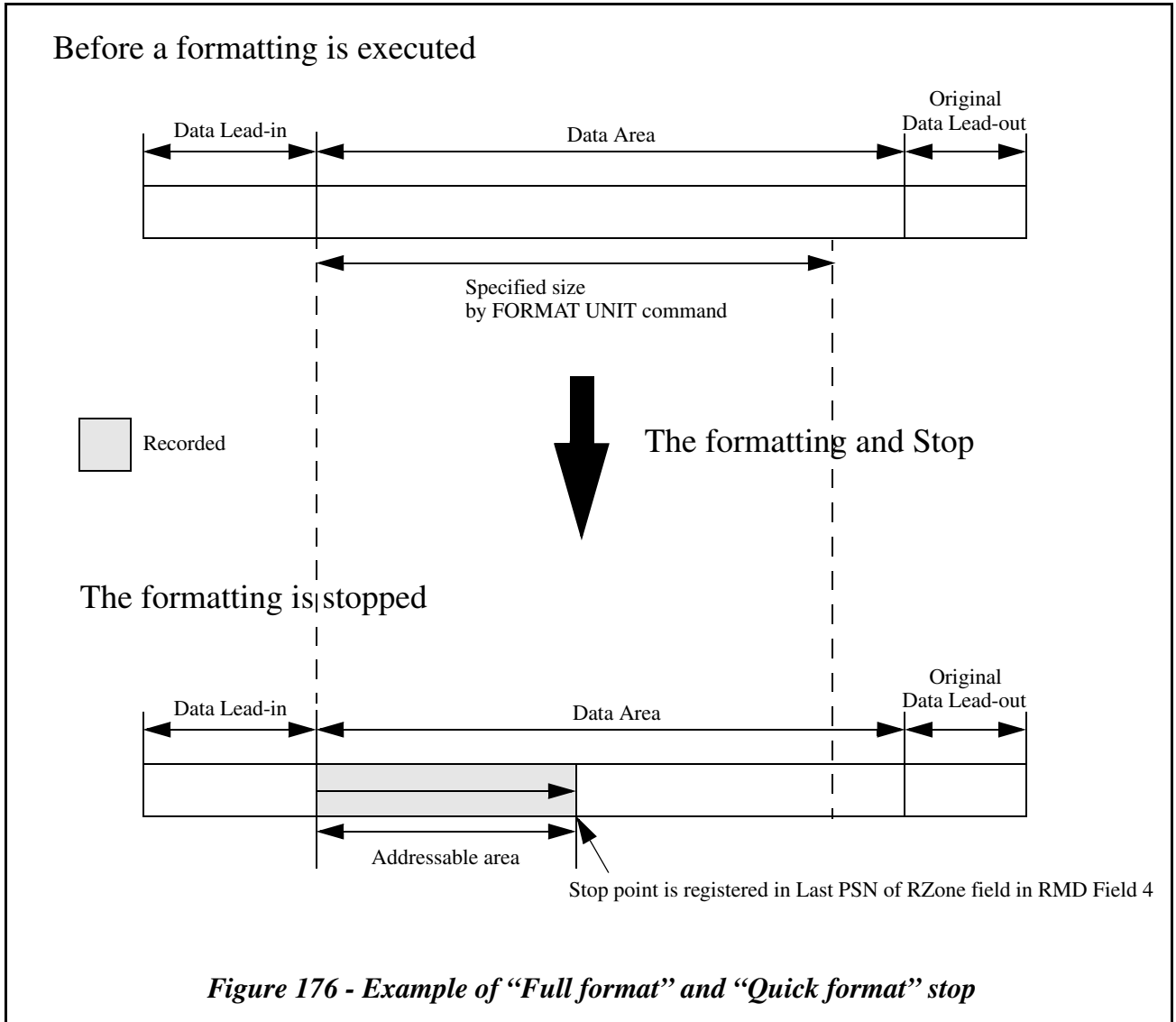
The capability of stopping a formatting is provided, because it may take a long time for the formatting. To stop formatting, CLOSE TRACK/SESSION command with Close Function field = 000b is used. After the “Fragment recording format” is stopped, the disc state is Intermediate state in Fragment recording mode. After all the other formatting is stopped, the disc state is Intermediate state in Sequential formatting mode. The logical unit *shall* stop the formatting and then *shall* update RMD. ECC block pair status bit map *shall* be updated.

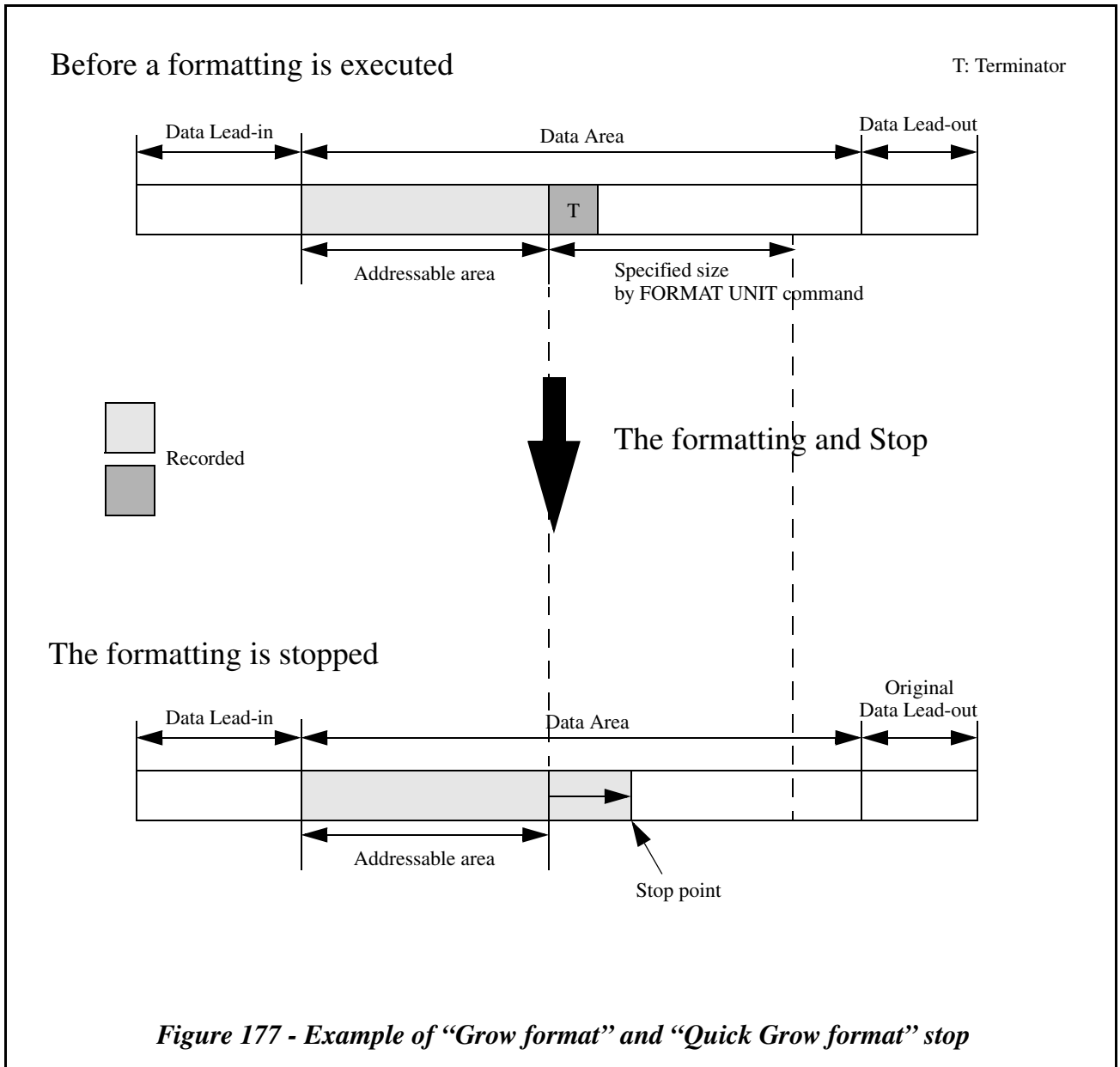
When the interruption of “Full format” or “Quick format” occurs, Last PSN of RZone field *shall* be the last PSN of the formatted area up to this time. The previous user data need not be preserved. Figure 176 shows an example of “Full format” and “Quick format” stop.

When the interruption of “Grow format” or “Quick Grow format” occurs, Last PSN of RZone field *shall* not be changed and the previous user data *shall* be preserved. Figure 177 shows an example of “Grow format” and “Quick Grow format” stop.

When “Fragment recording format” with Background Padding is performed for the disc which is in Intermediate state in Fragment recording mode and the interruption occurs, the previous user data *shall* be preserved. Otherwise, when the interruption of “Fragment recording format” with Background Padding occurs, the previous user data need not be preserved.

Stopping the operation may not be completed immediately.





5.15.6 Disc closure

When CLOSE TRACK/SESSION command with Close Function field = 010b or 110b is issued, the disc closure operation *shall* be started for the disc.

5.15.6.1 Finalization in Sequential formatting mode

To change Intermediate state in Sequential formatting mode to Finalized state in Sequential formatting mode, disc closure operation is used¹. When CLOSE TRACK/SESSION command with Close Function field = 010b is issued, the operation *shall* be started for the disc.

1. If Finalization is executed for the disc which the addressable area size equals to the original Data Area size, the logical unit *shall* change the disc state to Full-finalized state.

If the end LBA of the addressable area is smaller than 1FDFFh, Terminator *shall* start PSN 4FE00h. The logical unit *shall* pad the unrecorded parts between the addressable area and Terminator with 00h data. The size of the addressable area *shall* not be changed.

If the unformatted Data Area is less than 480 ECC blocks before creating Terminator, a part of Guard Track Zone of Data Lead-out Area *shall* be recorded as a part of Terminator.

After the operation, the ECC block pair status bit map *shall* be renewed. If only one ECC block of an ECC block pair is recorded with data whose Area type is Data Area, the status of the ECC block pair *shall* be set to 0b. The end PSN of Data Area *shall* be stored in Last PSN of RZone field of RMD Field 4.

5.15.6.2 Full-finalization

To change Intermediate state in Sequential formatting mode, Intermediate state in Fragment recording mode and Finalized state in Sequential formatting mode to Full-finalized state, this disc closure operation is used. When CLOSE TRACK/SESSION command with Close Function field = 110b is issued, this disc closure operation *shall* be started for the disc. If the disc is Intermediate state in Fragment recording mode and when CLOSE TRACK/SESSION command with Close Function field = 010b is issued, this disc closure operation *shall* be started for the disc.

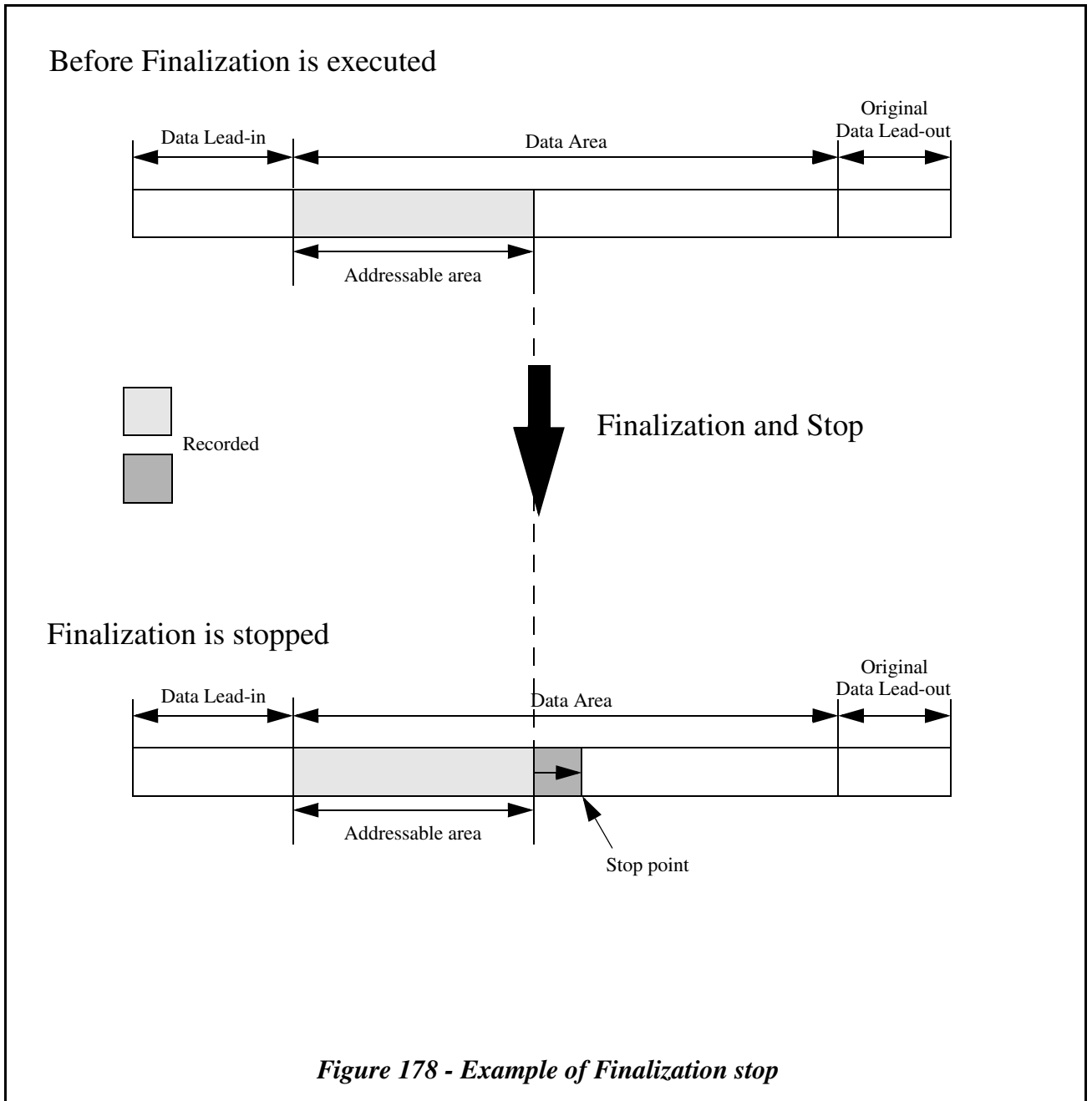
To minimize finalization time logical unit does not to overwrite a previous written ECC block whose Area type is Data Area. The logical unit can obtain the status of the original Data Area from Last PSN of RZone field in RMD Field 4 and ECC block pair status bit map in RMD Field 6 to 13.

5.15.6.3 Disc closure stop

The capability of stopping a disc closure is provided, because it may take a long time for the disc closure. To stop the disc closure, CLOSE TRACK/SESSION command with Close Function field = 000b is used. After the disc closure is stopped, the disc state is Intermediate state in each mode. The logical unit *shall* stop the disc closure and then *shall* update RMD. ECC block pair status bit map *shall* be updated.

When the interruption of Finalization or Full-finalization occurs, Last PSN of RZone field *shall* not be changed. The previous user data *shall* be preserved. Figure 176 shows an example of Finalization stop.

Stopping the operation may not be completed immediately.



5.15.7 Blanking

5.15.7.1 Blank the disc (Full blank)

This blank operation *shall* overwrite user data and set disc state as Empty. The parts whose ECC block pair status bit map values are 1 *shall* be overwritten at least. This blanking operation can be applied to the disc with any state. When BLANK command with Blanking Type = 000b is issued, this blanking operation *shall* be started for the disc. After this blanking operation, the disc *shall* be in Empty state.

RZone information of RMD *shall* be set to initial values and the related information such as the Disc status is renewed.

If R-PFI Zone is recorded, the physical format information in which the Last PSN of RZone field is set to 0 *shall* be recorded in the R-PFI Zone.

“Blank the disc” operation procedure is as follows;

1. Write 00h data
 - If a logical unit reads ECC block pair status bit map, the logical unit *shall* write 00h data only on the ECC blocks whose ECC block pair status bit map values are 1b. Otherwise, the logical unit *shall* write 00h data on whole Data Area.
2. Write RMD as Empty state

5.15.7.2 Minimally blank the disc

“Minimally blank the disc” operation differs from “Blank the disc” operation in that Data Area is not overwritten.

“Minimally blank the disc” operation can be applied to the disc with any state. The logical unit *shall* write a RMD as Empty state. When BLANK command with Blanking Type = 001b is issued, “Minimally blank the disc” operation *shall* be started for the disc. After “Minimally blank the disc” operation the disc *shall* be in Empty state.

5.15.7.3 Blanking stop

The capability of stopping a “Blank the disc” is provided, because it may take a long time for “Blank the disc”. To stop “Blank the disc”, CLOSE TRACK/SESSION command with Close Function field = 000b is used. Disc Status field and Last PSN of RZone field *shall* not be changed. However, in case that the logical unit writes 00h data on whole original Data Area regardless of the ECC block status bit map setting, if the disc state is Finalized state in Sequential formatting mode, the disc state may change into Intermediate state in Sequential formatting mode. If it is necessary to change the ECC block pair status bit map, the logical unit *shall* update RMD.

Stopping the operation may not be completed immediately.

5.15.8 Reported data for each disc state

The reported data for each disc state is shown in Table 225 to Table 229.

Table 225 - Reported data for Empty state

Feature/Command	Bit/Field	Bit/Field value
HD DVD Write, Enhanced Defect Reporting	Current bit	0b
Rigid Restricted Overwrite	Current bit	0b
HD DVD-RW Fragment Recording	Current bit	0b
Formattable	Current bit	1b

Table 225 - Reported data for Empty state

Feature/Command	Bit/Field	Bit/Field value
READ DISC INFORMATION	Status of Last Session	00b
	Disc Status	00b
	BG Format Status	00b
READ TRACK INFORMATION	NWA_V	0b
	Next Writable Address	0
	Free Blocks	Disc capacity
	Track Size/RZone End Address	Disc capacity
	LRA_V	0b
	Last Recorded Address	0

Table 226 - Reported data for Intermediate state in Sequential formatting mode

Feature/Command	Bit/Field	Bit/Field value
HD DVD Write, Enhanced Defect Reporting	Current bit	1b
Rigid Restricted Overwrite	Current bit	1b
HD DVD-RW Fragment Recording	Current bit	0b
Formattable	Current bit	1b
READ DISC INFORMATION	Status of Last Session	01b
	Disc Status	01b
	BG Format Status	00b
READ TRACK INFORMATION	NWA_V	1b
	Next Writable Address	Last LBA of addressable area +1
	Free Blocks	Disc capacity - Addressable area size
	Track Size/RZone End Address	Disc capacity
	LRA_V	0b
	Last Recorded Address	0

Table 227 - Reported data for Finalized state in Sequential formatting mode

Feature/Command	Bit/Field	Bit/Field value
HD DVD Write, Enhanced Defect Reporting	Current bit	1b
Rigid Restricted Overwrite	Current bit	1b
HD DVD-RW Fragment Recording	Current bit	0b
Formattable	Current bit	1b

Table 227 - Reported data for Finalized state in Sequential formatting mode

Feature/Command	Bit/Field	Bit/Field value
READ DISC INFORMATION	Status of Last Session	11b
	Disc Status	10b
	BG Format Status	00b
READ TRACK INFORMATION	NWA_V	0b
	Next Writable Address	0
	Free Blocks	0
	Track Size/RZone End Address	Addressable area size
	LRA_V	0b
	Last Recorded Address	0

Table 228 - Reported data for Intermediate state in Fragment recording mode^a

Feature/Command	Bit/Field	Bit/Field value
HD DVD Write, Enhanced Defect Reporting	Current bit	1b
Rigid Restricted Overwrite	Current bit	1b
HD DVD-RW Fragment Recording	Current bit	1b
Formattable	Current bit	1b
READ DISC INFORMATION	Status of Last Session	11b
	Disc Status	10b
	BG Format Status	01b/10b ^b
READ TRACK INFORMATION	NWA_V	0b
	Next Writable Address	0
	Free Blocks	0
	Track Size/RZone End Address	Addressable area size (Disc capacity)
	LRA_V	0b
	Last Recorded Address	0

a. READ CAPACITY command *shall* report full capacity.

b. If a logical unit does not support Background Padding operation, this field *shall* be set to 01b.

Table 229 - Reported data for Full-finalized state

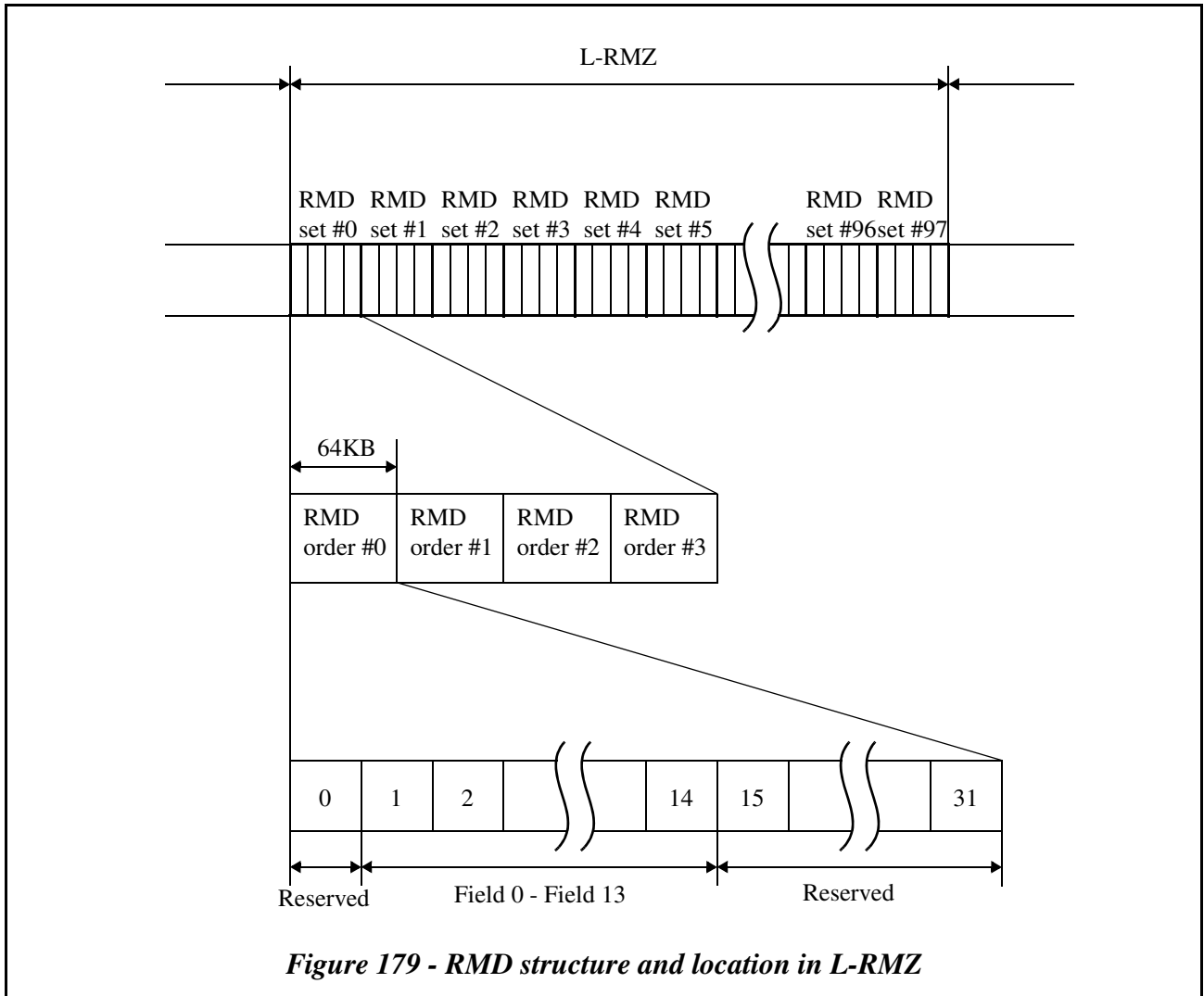
Feature/Command	Bit/Field	Bit/Field value
HD DVD Write, Enhanced Defect Reporting	Current bit	1b
Rigid Restricted Overwrite	Current bit	1b
HD DVD-RW Fragment Recording	Current bit	1b
Formattable	Current bit	1b

Table 229 - Reported data for Full-finalized state

Feature/Command	Bit/Field	Bit/Field value
READ DISC INFORMATION	Status of Last Session	11b
	Disc Status	10b
	BG Format Status	11b
READ TRACK INFORMATION	NWA_V	0b
	Next Writable Address	0
	Free Blocks	0
	Track Size/RZone End Address	Addressable area size (Disc capacity)
	LRA_V	0b
	Last Recorded Address	0

5.15.9 RMD (Recording Management Data)

L-RMZ consists of 98 RMD sets which are identified by RMD set number from 0 to 97. Each RMD set consists of 4 RMD orders which are identified by RMD order number from 0 to 3. RMD structure and location in L-RMZ is shown in Figure 179.



5.15.9.1 The contents of RMD

RMD contains 14 RMD Fields. The other sectors are reserved. Each RMD Field is 2 048 bytes in length.

5.15.9.2 RMD Field 0 (RMD Header)

RMD Field 0 specifies general information of the disc and is recorded as follows.

Table 230 - RMD - Field 0

Bit Byte	7	6	5	4	3	2	1	0
0~1	(MSB) RMD Format							(LSB)
2	Disc Status							
3	Reserved							
4~21	(MSB) Unique Disc ID							(LSB)
22~33	(MSB) Data area allocation							(LSB)
34~45	Reserved							
46~47	(MSB) Padding Status							(LSB)
48	Indicator of RMD initialization							
49~127	Reserved							
128~131	(MSB) RMD set information							(LSB)
132~2047	Reserved							

The RMD Format field specifies the RMD Format Code. The RMD Format Code indicates the recording format of the RMD. These bytes are set to 0002h.

The Disc Status field indicates the disc status. Disc Status field is defined in Table 231.

Table 231 - Disc Status field definition

Value	Interpretation
00h	To indicate that the disc is Empty.
08h	To indicate that the disc is in Recording Mode U
11h	To indicate that format operation of Sequential formatting mode is in progress
12h	To indicate that the disc is Finalized in Sequential formatting mode
13h	To indicate that the disc is Intermediate in Sequential formatting mode
21h	To indicate that format operation of Fragment recording mode is in progress
22h	To indicate that the disc is Full-finalized
23h	To indicate that the disc is Intermediate in Fragment recording mode
92h	To indicate that the disc is Finalized in Sequential formatting mode and Write-protected
93h	To indicate that the disc is Intermediate in Sequential formatting mode and Write-protected
A2h	To indicate that the disc is Full-finalized and Write-protected
A3h	To indicate that the disc is Intermediate in Fragment recording mode and Write-protected
Others	Reserved

The Unique Disc ID field is recorded and structured as defined in Table 232. The Unique Disc Identifier contains time stamp fields. The time format should be UTC 24 hour clock¹. This field *shall* be set by the SEND DISC STRUCTURE command. This time stamp data sent by the SEND DISC STRUCTURE command may also be used in the OPC related field in RMD field 1 and may help the judgement to do OPC. The logical unit *shall* update the time stamp during power on. Strict accuracy of time is not required.

1. UTC = universal time coordinated

Table 232 - Unique Disc ID

Bit Byte	7	6	5	4	3	2	1	0
0-1	Reserved							
2-3	(MSB) Random Data							(LSB)
4-7	(MSB) Year							(LSB)
8-9	(MSB) Month							(LSB)
10-11	(MSB) Day							(LSB)
12-13	(MSB) Hour							(LSB)
14-15	(MSB) Minute							(LSB)
16-17	(MSB) Second							(LSB)

The Random Data field is a random number.

The Year field specifies the year coded in ASCII in the range “0001” to “9999”.

The Month field specifies the month of the year coded in ASCII in the range “01” to “12”.

The Day field specifies the day of the month coded in ASCII in the range “01” to “31”.

The Hour field specifies the hour of the day coded in ASCII in the range “00” to “23”.

The Minute field specifies the minute of the hour coded in ASCII in the range “00” to “59”.

The Second field specifies the second of the minute coded in ASCII in the range “00” to “59”.

The Data area allocation field is recorded and structured as defined in Table 233.

Table 233 - Data area allocation

Bit Byte	7	6	5	4	3	2	1	0
22	00h							
23 - 25	Start PSN of the Data area (PSN = 30000h)							
26	00h							
27 - 29	Outer limit PSN of Data Recordable area (PSN = 73543Fh)							
30	00h							
31 - 33	000000h							

The Padding Status field indicates the disc status. Padding Status field is defined in Table 234.

Table 234 - Padding Status field definition

Bit	Definition
12	0b: The Reference Code Zone is not padded. 1b: The Reference Code Zone is padded.
3	0b: The R-Physical Format Information Zone is not padded. 1b: The R-Physical Format Information Zone is padded.
Others	Reserved

Indicator of RMD initialization field specifies the indicator of RMD initialization. Indicator of RMD initialization field is defined in Table 234.

Table 235 - Indicator of RMD initialization field definition

Bit	Definition
0	0b: RMD initialization has not been executed. 1b: RMD initialization has been executed.
Others	Reserved

RMD set information field specifies the numbers of RMD. RMD set information field is defined in Table 236.

Table 236 - RMD set information

Bit Byte	7	6	5	4	3	2	1	0
0	Reserved	RMD set number						
1	(MSB)							
2	RMD serial number							
3						(LSB)	RMD order number	

5.15.9.3 RMD Field 1

RMD Field 1 contains some logical unit and OPC related information and is recorded as defined in Table 237. There are four sets of OPC data blocks. The OPC related information of the present drive is always recorded in the field #1. If the field #1 of the current RMD does not contain the present drive information, which consists of Drive manufacturer ID, Serial number and Model number, the information in the field #1 to #3 of the current RMD is copied to the field #2 to #4 of the new RMD and the information in the field #4 of the current RMD is discarded. If the field #1 of the current RMD contains the present drive information, the information of the field #2 to #4 of the new RMD. In every case, the unused fields of the RMD Field1 is set to 00h.

Table 237 - RMD - Field 1 (logical unit & OPC information)

Bit Byte	7	6	5	4	3	2	1	0
0-31	Drive manufacturer ID#1							
32-47	Serial Number #1							
48-63	Model Number #1							
64-71	Time stamp #1							
72-75	Inner Drive Test Zone address #1							
76-79	Outer Drive Test Zone address #1							
80-103	Running OPC Information #1							
104-105	DSV #1							
106	Test Zone usage descriptor #1							
107-127	Reserved #1							
128-191	Drive specific data #1							
192-255	Reserved #1							
256-287	Drive manufacturer ID #2							
288-303	Serial Number #2							
304-319	Model Number #2							
320-327	Time stamp #2							
328-331	Inner Drive Test Zone address #2							
332-335	Outer Drive Test Zone address #2							
336-359	Running OPC Information #2							
360-361	DSV #2							
362	Test Zone usage descriptor #2							
363-383	Reserved #2							
384-447	Drive specific data #2							
448-511	Reserved #2							
:	:							
768-799	Drive manufacturer ID#4							
800-815	Serial Number #4							
816-831	Model Number #4							
832-839	Time stamp #4							
840-843	Inner Drive Test Zone address #4							
844-847	Outer Drive Test Zone address #4							
848-871	Running OPC Information #4							
872-873	DSV #4							
874	Test Zone usage descriptor #4							
875	Reserved #4							
876-895	Reserved #4							
896-959	Drive specific data #4							
960-1 023	Reserved #4							
1 024-1 279	Drive specific data #1							
1 280-1 535	Drive specific data #2							
1 536-1 791	Drive specific data #3							
1 792-2 047	Drive specific data #4							

The Drive manufacturer ID #n field is recorded in ASCII code and specifies unique drive manufacturer identifier of the logical unit.

The Serial Number #n field is recorded as ASCII code and specifies serial number of the logical unit.

The Model Number #n field is recorded as ASCII code and specifies the recorder model number.

The Timestamp #n field may be used to store date and time when OPC is performed. This field, if used, is recorded in binary. If this field is set to 0, this field is invalid.

The Inner Drive Test Zone address #n field is recorded in binary and specifies the start ECC block address of the Drive Test Zone in the Data Lead-in Area where the last power calibration is performed. If these fields are set to 00h, then they are invalid.

The Outer Drive Test Zone address #n field is recorded in binary and specifies the start ECC block address of the Drive Test Zone in the Middle Area where the last power calibration is performed. If these fields are set to 00h, then they are invalid.

The Running OPC Information field may be used to specify values concerning running OPC. The format is vendor-specific. If this field is set to 0, this field is invalid.

If the disc is incrementally recorded and when RMD is updated, the DSV field is recorded. This field is used to specify the last DSV (Digital Sum Value) in binary notation. If this field is set to 0, this field is invalid.

The Test Zone usage descriptor #n field specifies the usage for the 2 Test Zones.

Table 238 - Test zone usage descriptor

Bit	Definition
4-7	Reserved
3	0b: The drive did not use the inner Drive Test Zone. 1b: The drive used the inner Drive Test Zone.
2	0b: The drive did not use the outer Drive Test Zone. 1b: The drive used the outer Drive Test Zone.
0-1	Reserved

5.15.9.4 RMD Field 2

RMD Field 2 can be used freely and format of this field is user-specific.

Table 239 - RMD - Field 2 (User Specific Data)

Bit	7	6	5	4	3	2	1	0
Byte	User Specific Data							
0-2 047	(MSB)							(LSB)

The User Specific Data field is available for user specific data. This field may be used, otherwise this field is set to 0.

5.15.9.5 RMD Field 3

RMD Field 3 specifies the format operation information of the disc and is recorded as defined in Table 240.

Table 240 - RMD - Field 3 (Format operation information)

Bit Byte	7	6	5	4	3	2	1	0
0	Format operation code							
1	Reserved							
2-5	(MSB)	Format information 1						(LSB)
6	Format information 2							
7-2 047	Reserved							

Format operation code field specifies the Format operation code as shown in Table 241.

Format information 1 and Format information 2 field specify the information data related with format operation code and the contents of these field are shown in Table 241.

Table 241 - Format operation code and the contents of Format information 1 to 2

Format operation code		Format information 1	Format information 2
Value	Definition		
0	No format operation is in progress	Reserved	Reserved
1	Sequential padding	Reserved	Reserved
2	Finalization	Current PSN of formatted area	Current formatted area ^a
3	Clear user data	Reserved	Reserved
4	RMD initialization	Reserved	Reserved
Others	Reserved	Reserved	Reserved

a. "Current formatted area" is the zone or the area where the progressing Format operation is being executed. This field specifies the zone or the area as follows;

- 01h: RZone
- 03h: Terminator
- 20h: Data Lead-in Area
- Others: Reserved

5.15.9.6 RMD Field 4

RMD Field 4 contains RZone related information and is recorded as follows.

Table 242 - RMD - Field 4 (RZone Information)

Bit Byte	7	6	5	4	3	2	1	0
0~1	(MSB)	RZone Number						(LSB)
2~15	Reserved							
16~19	(MSB)	Start PSN of RZone						(LSB)
20~23	(MSB)	Last PSN of RZone						(LSB)
24~2 047	Reserved							

The RZone Number field contains the RZone number of the disc. This field is zero or one.

The Start PSN of RZone field contains the start PSN of the RZone. If the RZone exists on the disc, this field is 30000h. If this field is set to zero, then there is no RZone on the disc.

The Last PSN of RZone field contains the last PSN of the RZone. If the disc is in Fragment recording mode, this field is 73543Fh. If this field is set to zero, then there is no RZone on the disc.

5.15.9.7 RMD Field 5

RMD Field 5 contains the information of the defect status and the contents of this field is shown in Table 243.

Table 243 - RMD - Field 5 (Defect status Information)

Bit Byte	7	6	5	4	3	2	1	0
0~3	Reserved							
4	Defect status of RMD duplication zone							
5~17	(MSB)	Defect status of RMZ						(LSB)
18	Defect status of R-PFI zone							
19~2047	Reserved							

The Defect status of RMD duplication zone field specifies the defect status of RDZ. This field is defined in Table 245.

Table 244 - Defect status of RMD duplication zone

Bit Byte	7	6	5	4	3	2	1	0
4	Reserved	#6	#5	#4	#3	#2	#1	#0

Table 245 - Defect status of RMD duplication zone definition

Bit	Definition
7	Reserved
0-6	0b: To indicate that the ECC block #n is non-defective. 1b: To indicate that the ECC block #n is defective.

The Defect status of RMZ field specifies the defect status of RMZ. This field is defined in Table 247.

Table 246 - Defect status of RMZ

Bit Byte	7	6	5	4	3	2	1	0
5	Reserved						#97	#96
6	#95	#94	#93	#92	#91	#90	#89	#88
:	:							
16	#15	#14	#13	#12	#11	#10	#9	#8
17	#7	#6	#5	#4	#3	#2	#1	#0

Table 247 - Defect status of RMZ definition

Bit	Definition
98 - 103	Reserved
0 - 97	0b: To indicate that the ECC block #n is non-defective. 1b: To indicate that the ECC block #n is defective.

The Defect status of R-PFI zone field specifies the defect status of R-Physical Format Information zone. This field is defined in Table 249.

Table 248 - Defect status of R-PFI zone

Bit Byte	7	6	5	4	3	2	1	0
4	Reserved	#6	#5	#4	#3	#2	#1	#0

Table 249 - Defect status of R-PFI zone definition

Bit	Definition
7	Reserved
0-6	0b: To indicate that the ECC block #n is non-defective. 1b: To indicate that the ECC block #n is defective.

5.15.9.8 RMD Field 6

RMD Field 6 contains the ECC block pair status bit map of each ECC block pair status information and is recorded as follows. The ECC block pair contains two continuous ECC blocks. Each ECC block pairs are identified by a serial number J which starts from 0 to 16383. The serial number is assigned from the first ECC block pair at the start PSN of Data Area in the ascending order.

Bit 0 of Byte 0 indicates the status of the ECC block pair having the first serial number 0.

Table 250 - RMD - Field 6 (ECC block pair status information)

Bit Byte	7	6	5	4	3	2	1	0
0	#7	#6	#5	#4	#3	#2	#1	#0
1	#15	#14	#13	#12	#11	#10	#9	#8
2	#23	#22	#21	#20	#19	#18	#17	#16
:	:							
2 046	#16 375	#16 374	#16 373	#16 372	#16 371	#16 370	#16 369	#16 368
2 047	#16 383	#16 382	#16 381	#16 380	#16 379	#16 378	#16 377	#16 376

Each bit specifies the status of the ECC block pair according to the following rule.

Table 251 - Bit definition

Value	Definition
0b	To indicate that the ECC block pair isn't recorded with data whose Area type is Data Area.
1b	To indicate that the ECC block pair is recorded with data whose Area type is Data Area.

5.15.9.9 RMD Field 7 ~ Field 13

RMD Field 7 through Field 13 contain the ECC block pair status bit map of each ECC block pair status information continued from RMD Field 6.

Table 252 - RMD - Field 7 ~Field 13 (ECC block pair status information ... continued)

Bit Byte	7	6	5	4	3	2	1	0
0	#n+7	#n+6	#n+5	#n+4	#n+3	#n+2	#n+1	#n
1	#n+15	#n+14	#n+13	#n+12	#n+11	#n+10	#n+9	#n+8
2	#n+23	#n+22	#n+21	#n+20	#n+19	#n+18	#n+17	#n+16
:	:							
2 046	#n+16 375	#n+16 374	#n+16 373	#n+16 372	#n+16 371	#n+16 370	#n+16 369	#n+16 368
2 047	#n+16 383	#n+16 382	#n+16 381	#n+16 380	#n+16 379	#n+16 378	#n+16 377	#n+16 376

Each ECC block pairs are identified by a serial number J which starts from 0 to 115 024. Bit 1 to Bit 7 of Byte 42 in Field13 are set to 0b. Byte 43 to 2 047 in Field13 are set to 00h.

5.15.10 Reading/recording of RMD

5.15.10.1 RMD recording in RDZ

In RDZ, RMD which has the largest order number in the latest RMD set **shall** be copied when a disc state becomes Finalized or Full-finalized state, or a disc is to be ejected and the latest RMD is not copied.

The latest RMD in RDZ is pointer to the current valid RMD Set in L-RMZ. The latest RMD **shall** be recorded from inner ECC block to outer ECC block one by one. When the outermost ECC block is recorded, the next RMD **shall** be recorded at the innermost ECC block. This recording order **shall** continue cyclically in 7 ECC blocks. See 5.4.4.5.4, "Recording Management Data Duplication Zone (RDZ)" on page 320.

5.15.10.2 RMD recording in L-RMZ

In L-RMZ, all RMD blocks **shall** be recorded as an RMD Set. Each RMD Set **shall** consist of 4 RMD blocks that are all equivalent except RMD order number field. See 5.4.4.5.5, "Recording Management Zone (L-RMZ)" on page 321. When the RMD information is changed, the updated RMD Set **shall** be recorded in L-RMZ. RMD **shall** be recorded in a RMD set from inner to outer one by one. When the outermost RMD set #97 is recorded, the next RMD **shall** be recorded at the innermost RMD set #0. This recording order **shall** continue cyclically in 98 RMD sets. When the renewed RMD is recorded in a RMD set, the RMD serial number **shall** be incremented by 1. The initial value of the RMD serial number **shall** be 0.

If a RMD set has 2 or more ECC blocks with EDC error at the latest RMD recording, the defect status of RMZ **shall** be renewed and the latest RMD with the renewed defect status **shall** be recorded in the next RMD set without increasing the RMD serial number.

If blank RMD sets are remained when a disc state becomes Finalized or Full-finalized state, the latest RMD **shall** be recorded in the blank RMD sets without increasing the RMD serial number.

5.15.10.3 RMD read sequence

Read sequence of RMD is as follows:

1. Find the latest RMD in RDZ
Logical unit reads the RMD serial number field of RMDs in RDZ and finds the latest RMD in RDZ which has the largest RMD serial number.
2. Find the latest RMD set in L-RMZ
Logical unit obtains the RMD set number of the latest RMD set in L-RMZ by reading the RMD set number field of the latest RMD in RDZ.
3. Logical Unit reads the latest RMD set.

5.16 Recording for HD DVD-RW Dual Layer media

HD DVD-RW DL media consist of Lead-in Area, Data Area, Middle Area and Lead-out Area which is based on HD DVD-R DL media.

5.16.1 Recording mode

HD DVD-RW DL media support Sequential formatting mode. The formatting by FORMAT UNIT command is required in advance to use the disc as available for writing of user data. According to write protection, see *Section 12.0, "Write protection model"* on page 497.

5.16.1.1 Sequential formatting mode

When a disc is in Sequential formatting mode, the logical unit is able to overwrite randomly within the addressable area on the disc. However, there are some restrictions. See Section 5.16.4.2. If the disc is Intermediate state (Section 5.16.2.2), the logical unit is able to append data from NWA that appears during Intermediate state.

5.16.2 Disc state

A disc state is classified into four different states. These states are called Empty state, Intermediate state in Sequential formatting mode, Finalized state in Sequential formatting mode and Full-finalized state.

5.16.2.1 Empty state

In Empty state, the disc is not formatted. A physically blank disc *shall* be in Empty state. And after blanking logically by BLANK command, the disc *shall* enter Empty state.

In the Empty state, Middle Area expansion is not executed. R-PFI Zone is unrecorded or is recorded with the physical format information in which Last PSN of RZone field is set to 0.

5.16.2.2 Intermediate state in Sequential formatting mode

After formatting by "Quick format" or "Quick Grow format", the disc *shall* be in Intermediate state in Sequential formatting mode.

The addressable area is formed from the start PSN of Data Area. The addressable area is filled with any data whose Area type is Data Area. Example of the disc structure is shown in Figure 180. R-PFI Zone is unrecorded or is recorded with the physical format information in which Last PSN of RZone field is set to 0.

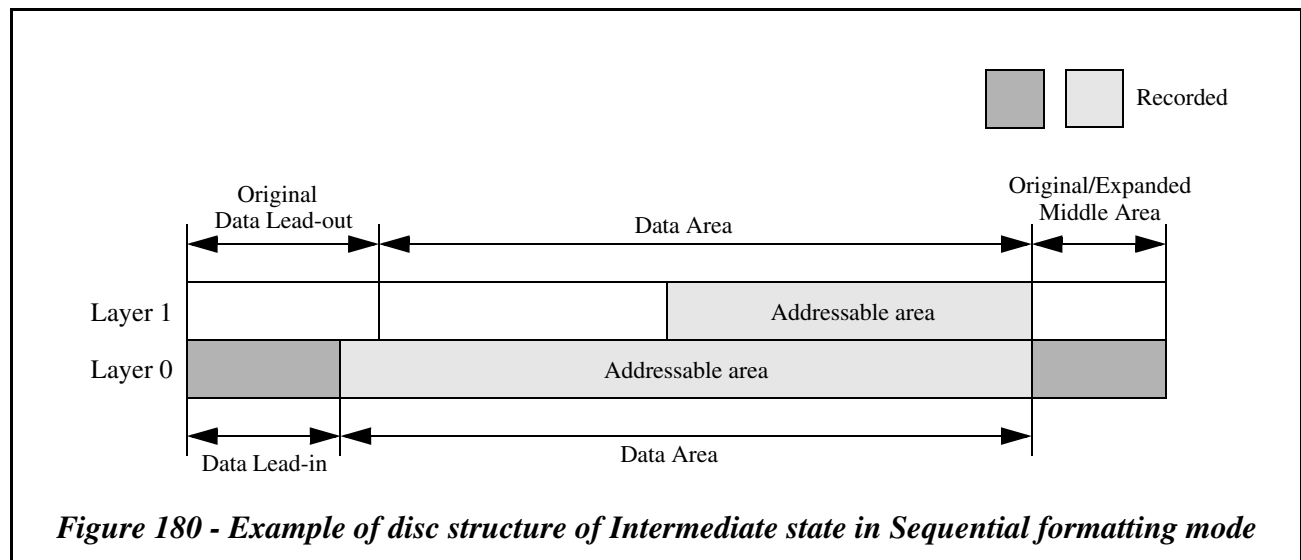


Figure 180 - Example of disc structure of Intermediate state in Sequential formatting mode

5.16.2.3 Finalized state in Sequential formatting mode

After formatting by “Full format”, “HD DVD-RW format” or “Grow format”, or Finalization, the disc *shall* be in Finalized state in Sequential formatting mode and has ROM compatibility.

The finalized data structure depends on the relationship between the addressable area size and Middle Area location. There are two main types of finalized data structure. The one is the disc structure that the addressable area exists on L0 and L1. The other is the disc structure that the addressable area exists on only L0. In the both types, the addressable area is filled with any data whose Area type is Data Area. In Data Lead-in Area, Guard Track Zone, Drive Test Zone, RDZ, L-RMZ, R-PFI and Reference Code Zone are fully recorded. In Data Lead-out, Guard Track Zone is recorded. In Middle Area, the recorded zone is different among the finalized data structures.

In the case that the addressable area exists on L0 and L1, Terminator is contiguously recorded from the end of the addressable area. Terminator location depends on the end PSN of Data Area and is shown in Table 253. The zone between Terminator on L1 and original Data Lead-out Area is Padding Zone. The Padding Zone is also recorded. Data Lead-in Area, original Data Lead-out Area and Middle Area are also recorded. Figure 181 shows example of this data structure.

In the case that the addressable area exists on only L0, Terminator on L0 is contiguously located from the end of the addressable area. Terminator on L1 is located in the corresponding position. Padding Zone exists. These areas are recorded. Data Lead-in and the original Data Lead-out Area are recorded. In the case that Terminator borders Middle Area, Middle Area is recorded (Type 1). In the case that Terminator does not border Middle Area, Middle Area may not recorded (Type 2). Blank Zone may be unrecorded. If Middle Area is expanded, the other area in the original Data Area may be unrecorded. Terminator location is shown in Table 254. Example of each case is shown in Figure 182.

The start PSN of Terminator is equal to or larger than PSN 5FE00h. Terminator is started at an ECC block boundary.

Table 253 - Terminator location for RZone on both L0 and L1 in Sequential formatting mode

End PSN of Data Area	FB8300h to FBCCFFh	E1F200h to FB82FFh	BDE400h to E1F1FFh	8C2400h to BDE3FFh
End PSN of Terminator on L1	FBCCFFh	End PSN of Data Area + 4A00h	End PSN of Data Area + 6000h	End PSN of Data Area + 7900h

Note: If “End PSN of Data Area” = FBCCFFh, Terminator does not exist.

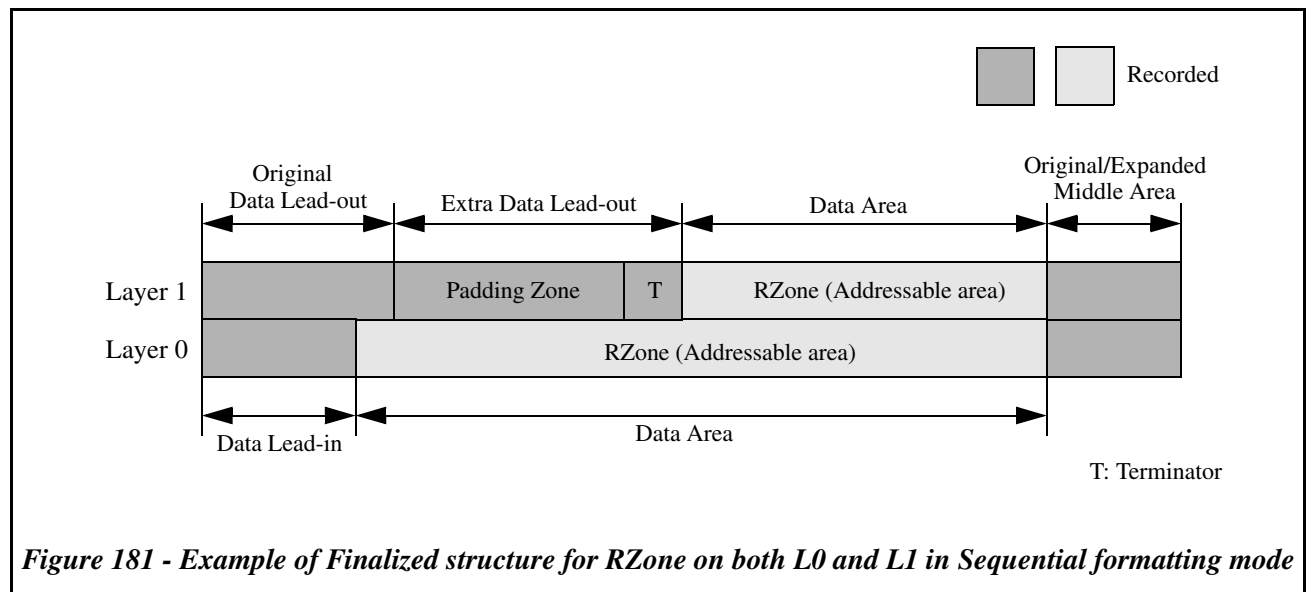


Figure 181 - Example of Finalized structure for RZone on both L0 and L1 in Sequential formatting mode

Table 254 - Terminator location for RZone on only L0 in Sequential formatting mode

Start PSN of Middle Area on L0 (X+1)	5FE00h to 1E0DFFh		1E0E00h to 421BFFh		421C00h to 73DBFFh	
	< X-9400h	>= X-9400h	< X-C00h	>= X-C000h	< X-F200h	>= X-F200h
End PSN of Terminator on L0	Y+9400h	X	Y+C000h	X	Y+F200h	X
Start PSN of Terminator on L1	$\overline{Y+4A00h}$	\overline{X}	$\overline{Y+6000h}$	\overline{X}	$\overline{Y+7900h}$	\overline{X}

Note: If “End PSN of Data Area on L0” (Y) = “Start PSN of Middle Area on L0 - 1” (X), Terminators on L0 and L1 does not exist.

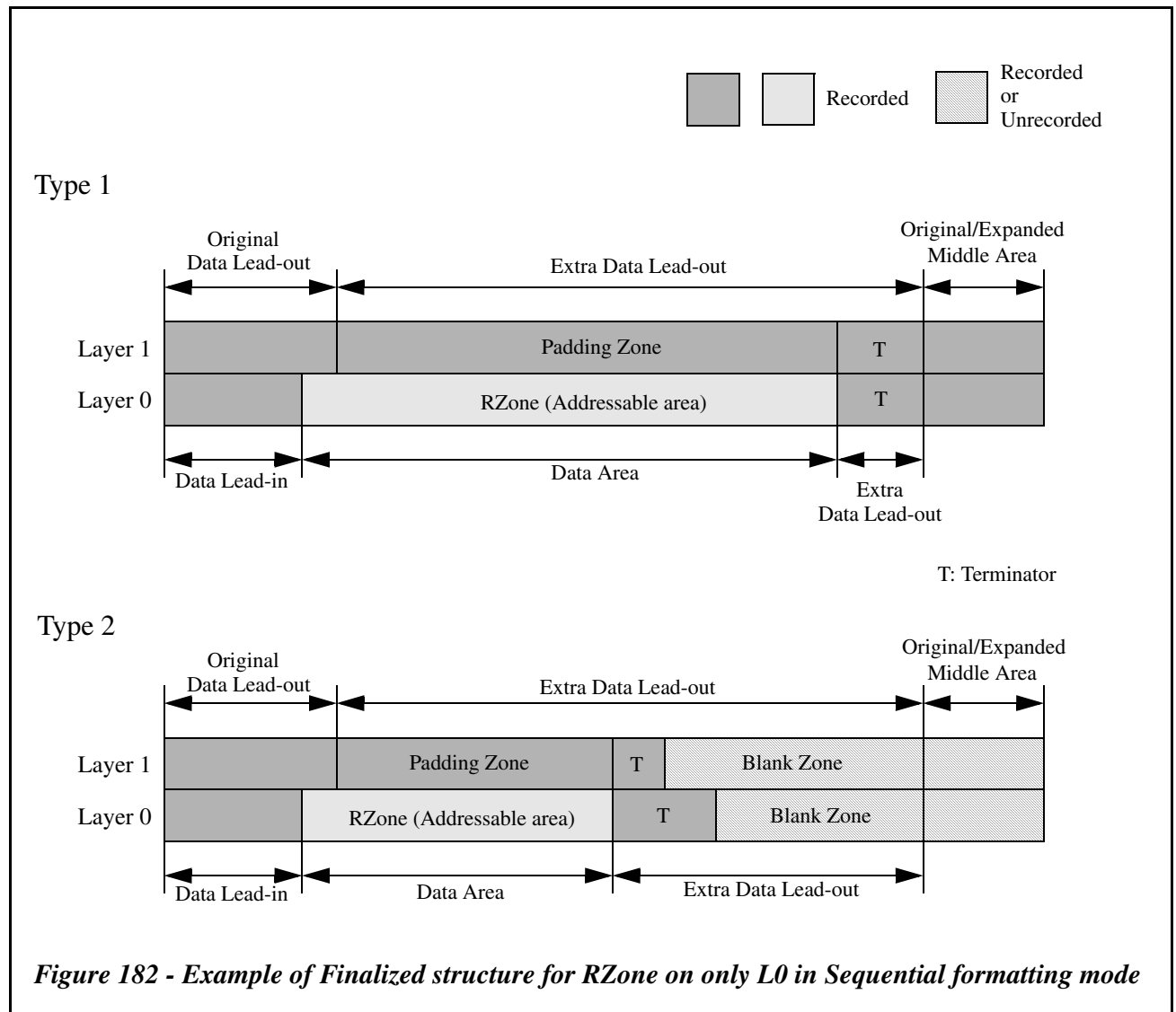
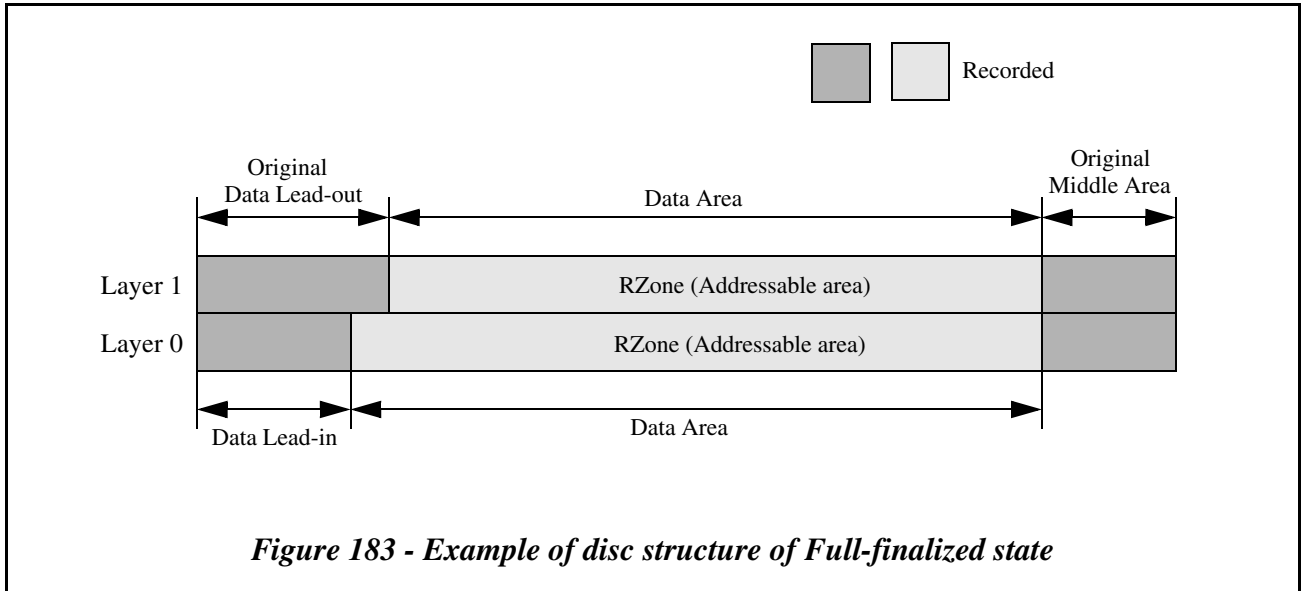


Figure 182 - Example of Finalized structure for RZone on only L0 in Sequential formatting mode

5.16.2.4 Full-finalized state

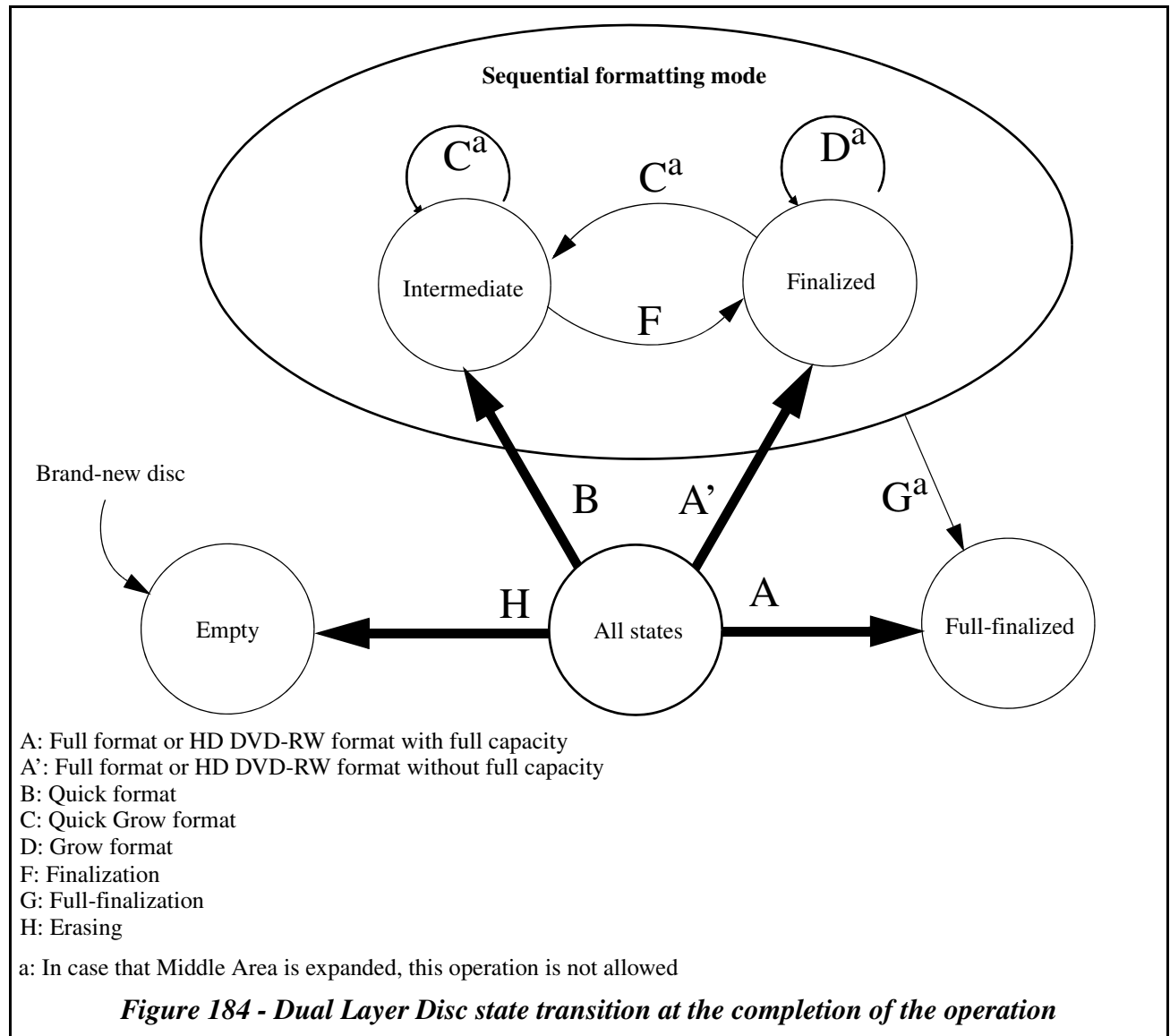
After formatting by “Full format” with full capacity, “HD DVD-RW full format” with full capacity or Full-finalization, the disc *shall* be in Full-finalized state and has ROM compatibility.

The original Data Area is fully recorded with any data whose Area type is Data Area. All original Data Area is addressable. Data Lead-in Area and original Data Lead-out are recorded. In Data Lead-in Area, Guard Track Zone, Drive Test Zone, RDZ, L-RMZ, R-PFI and Reference Code Zone are fully recorded. In Data Lead-out Area, Guard Track Zone is recorded. In the original Middle Area, Guard Track Zones on L0 and L1 are padded.



5.16.2.5 Disc state transition

Figure 184 shows the relationship between Recording mode and disc state transition at the completion of the operation. In case of the disc state transition at the interruption of the operation, see section 5.16.5.6 on page 423, section 5.16.7.3 on page 427 or section 5.16.8.3 on page 429.



5.16.3 ECC block pair status bit map

Two contiguous ECC blocks is called ECC block pair. The bit which is called ECC block pair status bit is assigned to the recorded condition of each ECC block pair. When an ECC block pair is recorded with whose Area type is Data Area, the corresponding ECC block pair status bit *shall* be set to 1b. Otherwise the bit *shall* be set to 0b. The ECC block pair status bit map *shall* be described through RMD Field 6 to Field 19. See Section 5.16.9.8 to Section 5.16.9.11.

When the bit is set to 0, an ECC block pair is not recorded physically or logically regardless of Area type.

When the bit is set to 1, an ECC block pair is recorded with whose Area type is Data Area.

In Sequential formatting mode, logical unit cannot obtain the size of the addressable area from ECC block pair status bit map and can obtain it from RZone information in RMD Field 4.

5.16.4 Data writing and reading

5.16.4.1 Data writing and reading on an Intermediate state in Sequential formatting mode

When a disc is in an Intermediate state in Sequential formatting mode, the logical unit reports the NWA where the last addressable block plus 1 of the RZone. The disc can be overwritten within the addressable area less than the NWA and data is sequentially appendable from the NWA to the full capacity of a disc. The NWA is reported by READ TRACK INFORMATION command.

To change Intermediate state to Finalized state, CLOSE TRACK/SESSION command (Close Function=010b)¹ is used.

To change Intermediate state to Full-finalized state, CLOSE TRACK/SESSION command (Close Function=110b) is used.

When a WRITE is applied on the NWA, and then SYNCHRONIZE CACHE (10) command is issued, the logical unit *shall* update RMD to reflect the addressable area size. When RMD is recorded, the ECC block pair status bit map² *shall* be renewed.

Attempting to read a portion beyond the addressable area *shall* be caused CHECK CONDITION Status, 8/00/00 BLANK CHECK.

5.16.4.2 Restriction of writing

There are some restrictions when overwriting is performed on HD DVD-RW DL media. The logical unit is able to record data only by the multiple of ECC block length. Host *shall* write data in integral multiple of 32 sectors starting at a logical block address that is an integral multiple of 32. If a WRITE command does not start at the integral multiple of 32 logical block address, the command *shall* be terminated with CHECK CONDITION Status, 5/21/02 INVALID ADDRESS FOR WRITE. If Transfer Length field value of WRITE command is not an integral multiple of 32 sectors, the command *shall* be terminated with CHECK CONDITION Status, 5/24/00 INVALID FIELD IN CDB. The logical unit does not perform hardware defect management, Read Modify Write, and Verify after Write.

According to recording on L1, there are also some restrictions just like HD DVD-R DL media. See 5.14.2.1 "Preparation for recording L1" on page 367. To get the long seamless recording condition such as real-time recording, before data writing a host should issue FORMAT UNIT command (Format Type = 17h) if IRSL1 bit of READ DISC STRUCTURE command is set to 0. When WRITE command with the address L0 through L1 is issued, the WRITE command *shall* be terminated with CHECK CONDITION Status, 5/21/03 INVALID WRITE CROSSING LAYER JUMP.

5.16.5 Formatting

The format operation is required in advance to use a disc. Five format operations are defined. They are called "Full format", "HD DVD-RW Full format", "Grow format", "Quick format" and "Quick Grow format". The format length *shall* be multiple of ECC block size. If the format length is not an integral multiple of ECC block size, the logical unit *shall* round up the value of Number of Blocks field in the Format Descriptor up to an integral multiple of the ECC block size. The addressable area is expandable up to the full capacity of the disc.

When Middle Area is not located in the original area, "Grow format" and "Quick Grow format" is not available. See Section 5.16.6.

In all format operation, to minimize formatting time logical unit does not need to overwrite a previous written ECC block whose Area type is Data Area. The logical unit can obtain the status of the original Data Area from Last PSN of RZone in RMD Field 4 and ECC block pair status bit map in RMD Field 6 to 19.

1. For the disc which the RZone size equals to the original Data Area size and RZone is filled with data whose Area type is Data Area, the disc *shall* be in Full-finalized state.
2. See Section 5.16.3.

5.16.5.1 Full format

“Full format” *shall* be available for any state. The addressable area *shall* be created from the beginning of original Data Area with a specified size. The disc state *shall* become Finalized state. In case that the specified size equals to original Data Area size, the disc state *shall* become Full-finalized state.

5.16.5.2 HD DVD-RW Full format

“HD DVD-RW Full format” is identical to “Full format”.

5.16.5.3 Grow format

“Grow format” *shall* be available for Finalized state in Sequential formatting mode. The addressable area *shall* be expanded with a specified size. The disc state remains in Finalized state in Sequential formatting mode. If the addressable area size equals to original Data Area size by the formatting, the disc state *shall* be changed to Full-finalized state. Middle Area location *shall* not be changed. When the Middle Area is not located in the original area, “Grow format” is not available.

5.16.5.4 Quick format

“Quick format” *shall* be available for any state. The addressable area *shall* be created from the beginning of original Data Area with a specified size. The disc state *shall* become Intermediate state in Sequential formatting mode.

5.16.5.5 Quick Grow format

“Quick Grow format” *shall* be available for Intermediate state in Sequential formatting mode and Finalized state in Sequential formatting mode. The addressable area *shall* be expanded with a specified size. The disc state *shall* become Intermediate state in Sequential formatting mode. When the Middle Area is not located in the original area, “Grow format” is not available.

5.16.5.6 Formatting Stop

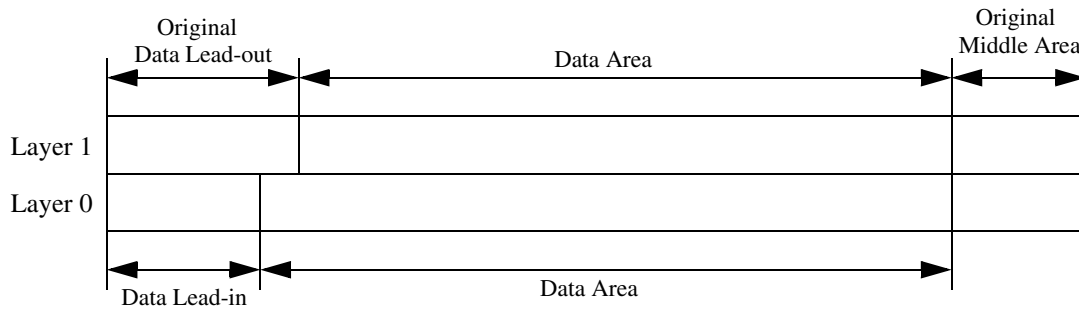
The capability of stopping a formatting is provided, because it may take a long time for the formatting. To stop formatting, CLOSE TRACK/SESSION command with Close Function field = 000b is used. After the formatting is stopped, the disc state is Intermediate state in Sequential formatting mode. The logical unit *shall* stop the formatting and then *shall* update RMD. ECC block pair status bit map *shall* be updated.

When the interruption of “Full format” or “Quick format” occurs, Last PSN of RZone field *shall* be the last PSN of the formatted area up to this time. The previous user data need not be preserved. Figure 185 shows an example of “Full format” and “Quick format” stop.

When the interruption of “Grow format” or “Quick Grow format” occurs, Last PSN of RZone field *shall* not be changed and the previous user data *shall* be preserved. Figure 186 shows an example of “Grow format” and “Quick Grow format” stop.

Stopping the operation may not be completed immediately.

Before a formatting is executed



 Recorded



The formatting and Stop

The formatting is stopped

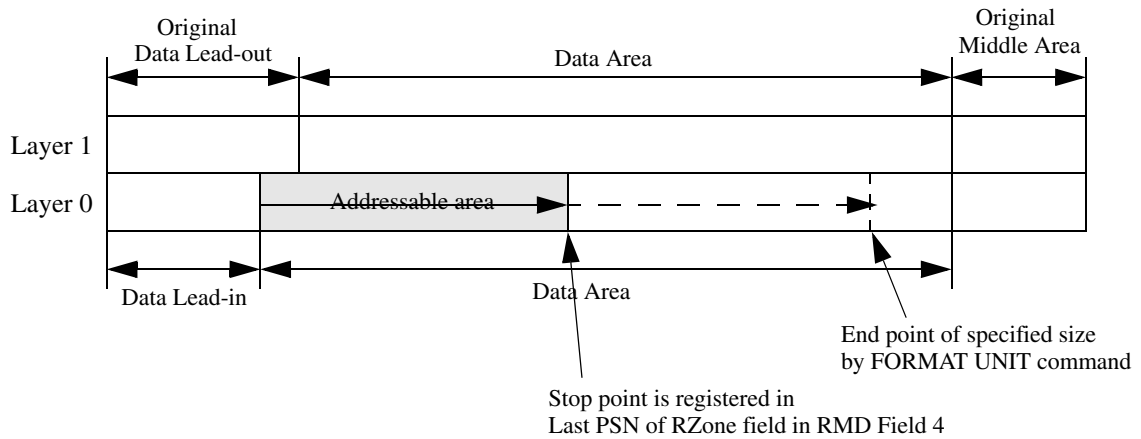
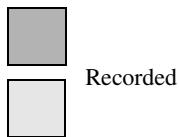
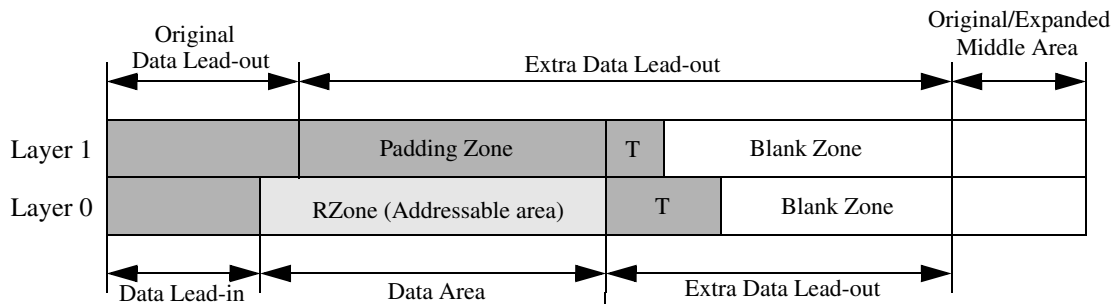


Figure 185 - Example of "Full format" and "Quick format" stop

Before a formatting is executed



The formatting and Stop

The formatting is stopped

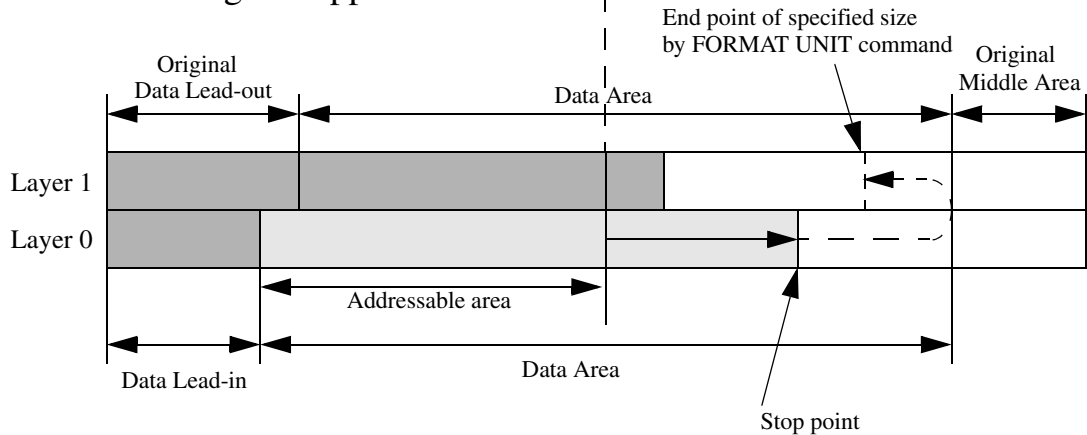


Figure 186 - Example of "Grow format" and "Quick Grow format" stop

5.16.6 Middle Area location change

When the total data size to be recorded is known, Middle Area expansion is a better way to reduce the time required for finalizing. Before expanding the addressable area on L1, Middle Area location can be changed. In order to change Middle Area location, a host *shall* specify the Data Area capacity on L0 in logical block by SEND DISC STRUCTURE command (Format Code = 20h). The value is an integral multiple of 32 and equal to or larger than 1FE00h. Middle Area *shall* not be overlapped the addressable area. When Middle Area location change is not available at the value, the SEND DISC STRUCTURE command (Format code = 20h) *shall* be terminated with CHECK CONDITION Status, 5/26/00 INVALID FIELD IN PARAMETER LIST. If a host tries to specify the value when data remain in the logical unit's write buffer, the command *shall* be terminated with CHECK CONDITION Status, 5/2C/00 COMMAND SEQUENCE ERROR.

Middle Area location change is done, the outer radius area beyond the Middle Area becomes unusable for user data¹.

Even if Middle Area is changed, the end LBA of Data Area on L0 and the start LBA of Data Area on L1 are continuous.

The erasing *shall* reset the Middle Area location. The FORMAT UNIT command except for Format Type 17h *shall* reset the Middle Area location.

If Middle Area location is changed, Number of Blocks field of Formattable Capacity Descriptor indicates the number of sectors in the original Data Area on the disc and Number of Blocks field of Current/Maximum Capacity Descriptor indicates the number of sectors in Data Area on the disc which Middle Area location is changed.

5.16.7 Disc closure

When CLOSE TRACK/SESSION command with Close Function field = 010b or 110b is issued, the disc closure operation *shall* be started for the disc.

5.16.7.1 Finalization in Sequential formatting mode

To change Intermediate state in Sequential formatting mode to Finalized state in Sequential formatting mode, this operation is used². When CLOSE TRACK/SESSION command with Close Function field = 010b is issued, the operation *shall* be started for the disc.

The data structure of Finalized state is different by the relationship between the addressable area size and Middle Area location. See Section 5.16.2.3, "Finalized state in Sequential formatting mode" on page 418. Middle Area location *shall* not be changed.

If the end LBA of the addressable area is smaller than 1FDFFh, Terminator on L0 *shall* start PSN 5FE00h. The logical unit *shall* pad the unrecorded parts between the addressable area and Terminator on L0 with 00h data. The size of the addressable area *shall* not be changed.

All or a part of Padding Zone may be already recorded with data whose Area type is Data Area. In this case, the recording of Padding Zone can skip such a recorded part and then *shall* fill the other part of Padding Zone with 00h data whose Area type is Data Area. The recording status *shall* be referred to the ECC block pair status bit map.

After the operation, the ECC block pair status bit map *shall* be renewed. If only one ECC block of a ECC block pair is recorded with data whose Area type is Data Area, the status of the ECC block pair *shall* be set to 0b. The end PSN of Data Area *shall* be stored in Last PSN of RZone field of RMD Field 4.

5.16.7.2 Full-finalization

To change Intermediate state in Sequential formatting mode and Finalized state in Sequential formatting mode to Full-finalized state, this disc closure operation is used. When CLOSE TRACK/SESSION command with Close Function field = 110b is issued, this disc closure operation *shall* be started for the disc. If Middle Area is expanded, the command *shall* be terminated with CHECK CONDITION Status, 5/24/00 INVALID FIELD IN CDB.

1. Middle Area expansion with the original Data Area capacity on L0 (6FDC00h) *shall* reset Middle Area location.

2. If Finalization is executed for the disc which the addressable area size equals to the original Data Area size, the logical unit *shall* change the disc state to Full-finalized state.

To minimize finalization time logical unit does not need to overwrite a previous written ECC block whose Area type is Data Area. The logical unit can obtain the status of the original Data Area from Last PSN of RZone in RMD Field 4 and ECC block pair status bit map in RMD Field 6 to 19.

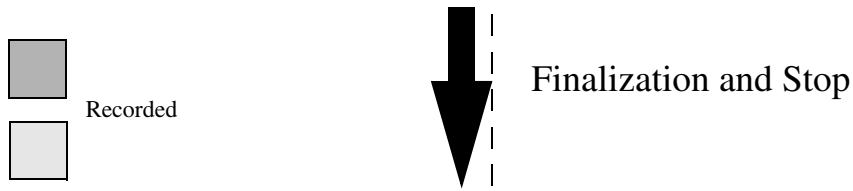
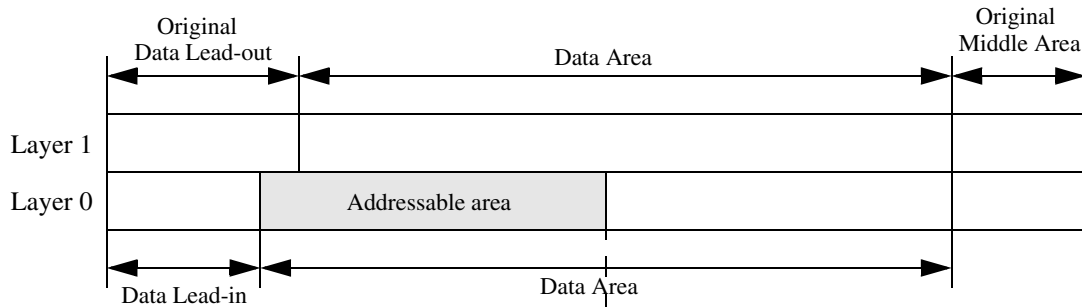
5.16.7.3 Disc closure stop

The capability of stopping a disc closure is provided, because it may take a long time for the disc closure. To stop the disc closure, CLOSE TRACK/SESSION command with Close Function field = 000b is used. After the disc closure is stopped, the disc state is Intermediate state. The logical unit *shall* stop the disc closure and then *shall* update RMD. ECC block pair status bit map *shall* be updated.

When the interruption of Finalization or Full-finalization occurs, Last PSN of RZone field *shall* not be changed. The previous user data *shall* be preserved. Figure 185 shows an example of Finalization stop.

Stopping the operation may not be completed immediately.

Before Finalization is executed



Finalization is stopped

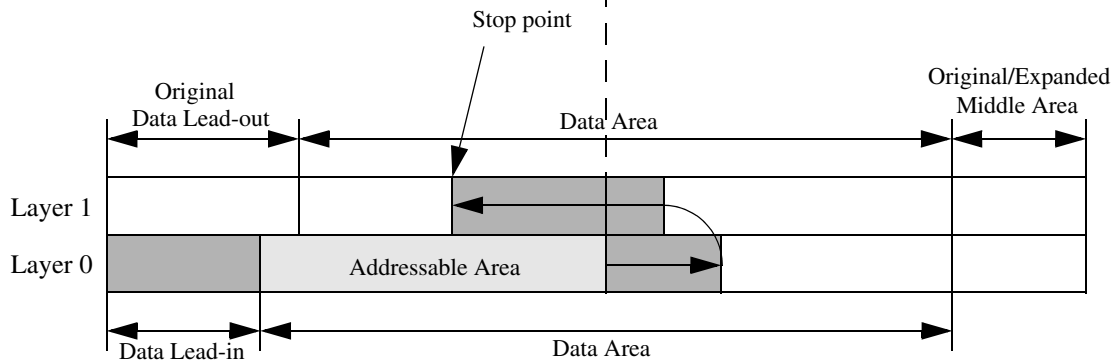


Figure 187 - Example of "Finalization" stop

5.16.8 *Blanking*

5.16.8.1 *Blank the disc (Full blank)*

This blank operation *shall* overwrite user data and set disc state as Empty. The parts whose ECC block pair status bit map values are 1 *shall* be overwritten at least. This erasing operation can be applied to the disc with any state. When BLANK command with Blanking Type = 000b is issued, this erasing operation *shall* be started for the disc. After this erasing operation, the disc *shall* be in Empty state.

RZone information of RMD *shall* be set to initial values and the related information such as the Disc status is renewed.

If R-PFI Zone is recorded, the physical format information in which the Last PSN of RZone field is set to 0 *shall* be recorded in the R-PFI Zone.

“Blank the disc” operation procedure is as follows;

1. Write 00h data
 - If a logical unit reads ECC block pair status bit map, the logical unit *shall* write 00h data only on the ECC blocks whose ECC block pair status bit map values are 1b. Otherwise, the logical unit *shall* write 00h data on whole Data Area.
2. Write RMD as Empty state

5.16.8.2 *Minimally blank the disc*

“Minimally blank the disc” operation differs from “Blank the disc” operation in that Data Area is not overwritten.

“Minimally blank the disc” operation can be applied to the disc with any state. The logical unit *shall* write a RMD as Empty state. When BLANK command with Blanking Type = 001b is issued, “Minimally blank the disc” operation *shall* be started for the disc. After “Minimally blank the disc” operation, the disc *shall* be in Empty state.

5.16.8.3 *Erasing stop*

The capability of stopping a “Blank the disc” is provided, because it may take a long time for “Blank the disc”. To stop “Blank the disc”, CLOSE TRACK/SESSION command with Close Function field = 000b is used. Disc Status field and Last PSN of RZone field *shall* not be changed. However, in case that the logical unit writes 00h data on whole original Data Area regardless of the ECC block status bit map setting, if the disc state is Finalized state in Sequential formatting mode, the disc state may change into Intermediate state in Sequential formatting mode. If it is necessary to change the ECC block pair status bit map, the logical unit *shall* update RMD.

Stopping the operation may not be completed immediately.

5.16.9 RMD (Recording Management Data)

The RMD is 64KBytes in length and is recorded as an ECC block. The RMD is recorded in L-RMZ. RMD structure and location in L-RMZ is shown in Figure 188.

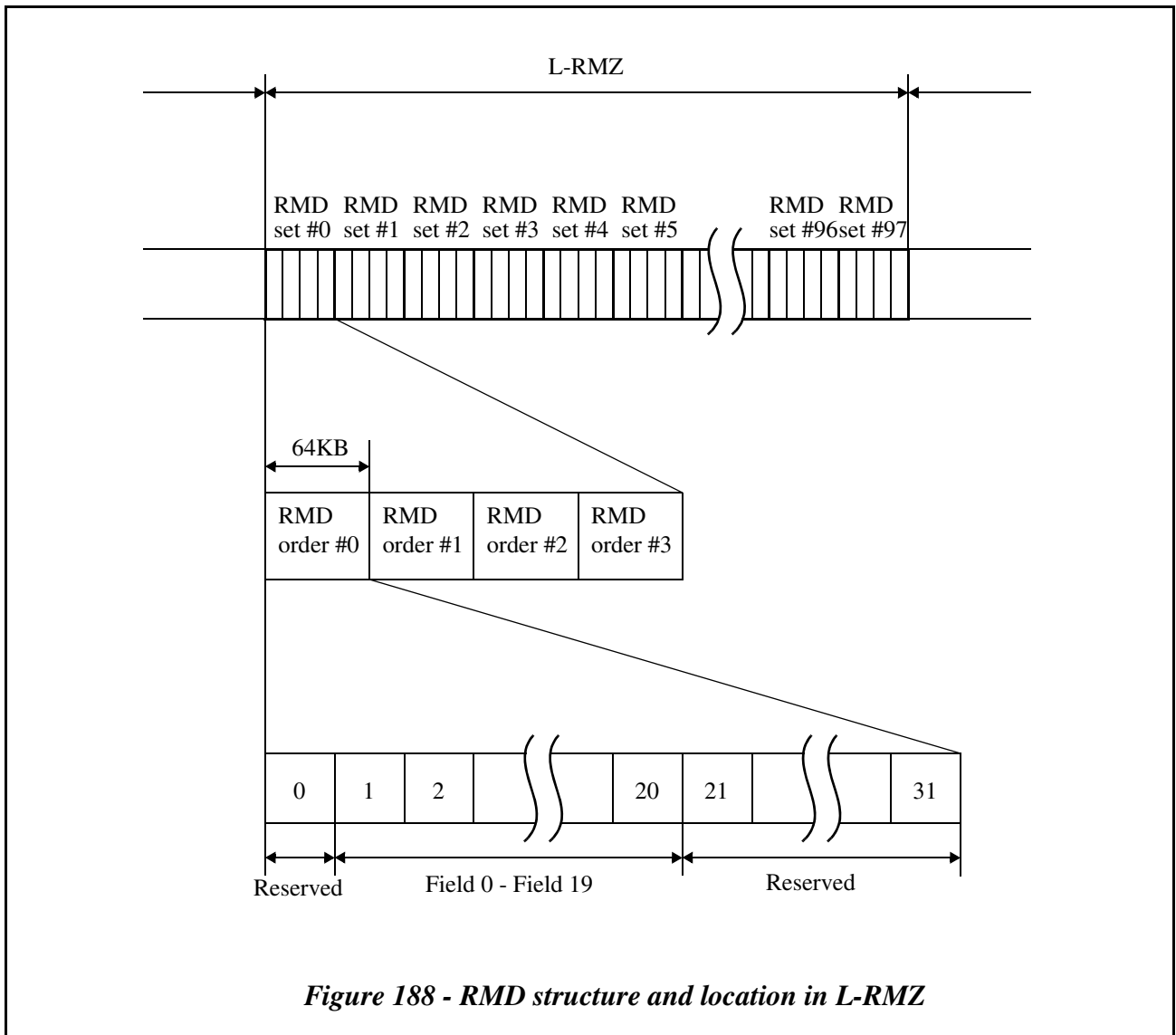


Figure 188 - RMD structure and location in L-RMZ

5.16.9.1 The contents of RMD

RMD contains 20 RMD Fields. The other sectors are reserved. Each RMD Field is 2 048 bytes in length.

5.16.9.2 RMD Field 0 (RMD Header)

RMD Field 0 specifies general information of the disc and is recorded as follows.

Table 255 - RMD - Field 0

Bit Byte	7	6	5	4	3	2	1	0
0-1	(MSB) RMD Format							(LSB)
2	Disc Status							
3	Reserved							
4-21	(MSB) Unique Disc ID							(LSB)
22-33	(MSB) Data area allocation							(LSB)
34-45	(MSB) Renewed Data area allocation							(LSB)
46-47	(MSB) Padding Status							(LSB)
48	Indicator of RMD initialization							
49-127	Reserved							
128-131	(MSB) RMD set information							(LSB)
132-2 047	Reserved							

The RMD Format field specifies the RMD Format Code. The RMD Format Code indicates the recording format of the RMD. These bytes are set to 0002h.

The Disc Status field indicates the disc status. Disc Status field is defined in Table 256.

Table 256 - Disc Status field definition

Value	Interpretation
00h	To indicate that the disc has no written data in Data Recordable Area (only RMD is written)
08h	To indicate that the disc is in recording mode U
11h	To indicate that format operation of Sequential formatting mode is in progress
12h	To indicate that the disc is Finalized in Sequential formatting mode
13h	To indicate that the disc is Intermediate in Sequential formatting mode
22h	To indicate that the disc is Full-finalized
92h	To indicate that the disc is Finalized in Sequential formatting mode and Write-protected
93h	To indicate that the disc is Intermediate in Sequential formatting mode and Write-protected
A2h	To indicate that the disc is Full-finalized and Write-protected
Others	Reserved

The Unique Disc ID field is recorded and structured as defined in Table 257. The Unique Disc Identifier contains time stamp fields. The time format should be UTC 24 hour clock¹. This field *shall* be set by the SEND DISC STRUCTURE command. This time stamp data sent by the SEND DISC STRUCTURE command may also be used in the OPC related field in RMD field 1 and may help the judgement to do OPC. The logical unit *shall* update the time stamp during power on. Strict accuracy of time is not required.

1. UTC = universal time coordinated

Table 257 - Unique Disc ID

Bit Byte	7	6	5	4	3	2	1	0
0-1	Reserved							
2-3	(MSB) Random Data							(LSB)
4-7	(MSB) Year							(LSB)
8-9	(MSB) Month							(LSB)
10-11	(MSB) Day							(LSB)
12-13	(MSB) Hour							(LSB)
14-15	(MSB) Minute							(LSB)
16-17	(MSB) Second							(LSB)

The Random Data field is a random number.

The Year field specifies the year coded in ASCII in the range “0001” to “9999”.

The Month field specifies the month of the year coded in ASCII in the range “01” to “12”.

The Day field specifies the day of the month coded in ASCII in the range “01” to “31”.

The Hour field specifies the hour of the day coded in ASCII in the range “00” to “23”.

The Minute field specifies the minute of the hour coded in ASCII in the range “00” to “59”.

The Second field specifies the second of the minute coded in ASCII in the range “00” to “59”.

The Data area allocation field is recorded and structured as defined in Table 258.

Table 258 - Data area allocation

Bit Byte	7	6	5	4	3	2	1	0
22	00h							
23 - 25	Start PSN of the Data area (PSN = 40000h)							
26	00h							
27 - 29	Outer limit PSN of Data Recordable area (PSN = FBCCFFh)							
30	00h							
31 - 33	End PSN on Layer 0 (PSN = 73DBFFh)							

The Renewed Data area allocation field is recorded and structured as defined in Table 259.

Table 259 - Renewed Data area allocation

Bit Byte	7	6	5	4	3	2	1	0
22	Renewal descriptor							
23 - 25	Start PSN of the Data area (PSN = 40000h)							
26	00h							
27 - 29	Outer limit PSN of Data Recordable area (PSN = FBCCFFh)							
30	00h							
31 - 33	End PSN on Layer 0							

The Renewal descriptor field indicates the disc status. This field is defined in Table 260.

Table 260 - Renewal descriptor field definition

Bit	Definition
0	0b: Middle Area is the original position. 1b: Middle Area is changed from the original position.
Others	Reserved

The End PSN on Layer 0 field specifies the end PSN of the Data Area on L0. In the case that the Middle Area expansion is executed, the PSN is changed.

The Padding Status field indicates the disc status. Padding Status field is defined in Table 261.

Table 261 - Padding Status

Bit	Definition
15	0b: The inner Guard Track Zone on Layer 0 is not padded. 1b: The inner Guard Track Zone on Layer 0 is padded.
14	0b: The inner Drive Test Zone on Layer 0 is not padded. 1b: The inner Drive Test Zone on Layer 0 is padded.
12	0b: The Reference Code Zone is not padded. 1b: The Reference Code Zone is padded.

Table 261 - Padding Status (continued)

Bit	Definition
11	0b: The outer Guard Track Zone on Layer 0 is not padded. 1b: The outer Guard Track Zone on Layer 0 is padded.
10	0b: The outer Drive Test Zone on Layer 0 is not padded. 1b: The outer Drive Test Zone on Layer 0 is padded.
9-8	00b: The Extra Guard Track Zone on Layer 0 is not padded, or not assigned. 01b: The Extra Guard Track Zone on Layer 0 is padded with data whose Area type is unknown or different from Middle Area. 10b: The Extra Guard Track Zone on Layer 0 is padded with Middle Area type data. 11b: reserved.
7	0b: The outer Guard Track Zone on Layer 1 is not padded. 1b: The outer Guard Track Zone on Layer 1 is padded.
4	0b: The outer Guard Track Zone on Layer 1 with Middle Area expansion is not padded or not assigned. 1b: The outer Guard Track Zone on Layer 1 with Middle Area expansion is padded.
3	0b: The R-PFI Zone is not padded. 1b: The R-PFI Zone is padded.
2	0b: The inner Guard Track Zone on Layer 1 is not padded. 1b: The inner Guard Track Zone on Layer 1 is padded.
Others	Reserved

Indicator of RMD initialization field specifies the indicator of RMD initialization. Indicator of RMD initialization field is defined in Table 262.

Table 262 - Indicator of RMD initialization field definition

Bit	Definition
0	0b: RMD initialization has not been executed. 1b: RMD initialization has been executed.
Others	Reserved

RMD set information field specifies the numbers of RMD. RMD set information field is defined in Table 263.

Table 263 - RMD set information

Bit Byte	7	6	5	4	3	2	1	0
0	Reserved	RMD set number						
1	(MSB)							
2	RMD serial number							
3						(LSB)	RMD order number	

5.16.9.3 RMD Field 1

RMD Field 1 contains some logical unit and OPC related information and is recorded as defined in Table 264. There are four sets of OPC data blocks. The OPC related information of the present drive is always recorded in the field #1. If the field #1 of the current RMD does not contain the present drive information, which consists of Drive manufacturer ID, Serial number and Model number, the information in the field #1 to #3 of the current RMD is copied to the field #2 to #4 of the new RMD and the information in the field #4 of the current RMD is discarded. If the field #1 of the current RMD

contains the present drive information, the information of the field #2 to #4 of the new RMD. In every case, the unused fields of the RMD Field1 is set to 00h.

Table 264 - RMD - Field 1 (logical unit & OPC information)

Bit Byte	7	6	5	4	3	2	1	0
0-31	Drive manufacturer ID#1							
32-47	Serial Number #1							
48-63	Model Number #1							
64-71	Time stamp #1							
72-75	Inner Drive Test Zone address for Layer 0 #1							
76-79	Outer Drive Test Zone address for Layer 0 #1							
80-103	Running OPC Information #1							
104-105	DSV #1							
106	Test Zone usage descriptor #1							
107	Reserved #1							
108-112	Inner Drive Test Zone address for Layer 1 #1							
113-115	Outer Drive Test Zone address for Layer 1 #1							
116-127	Reserved #1							
128-191	Drive specific data #1							
192-255	Reserved #1							
256-287	Drive manufacturer ID #2							
288-303	Serial Number #2							
304-319	Model Number #2							
320-327	Time stamp #2							
328-331	Inner Drive Test Zone address for Layer 0 #2							
332-335	Outer Drive Test Zone address for Layer 0 #2							
336-359	Running OPC Information #2							
360-361	DSV #2							
362	Test Zone usage descriptor #2							
363	Reserved #2							
364-367	Inner Drive Test Zone address for Layer 1 #2							
368-371	Outer Drive Test Zone address for Layer 1 #2							
372-383	Reserved #2							
384-447	Drive specific data #2							
448-511	Reserved #2							
:	:							
768-799	Drive manufacturer ID#4							
800-815	Serial Number #4							
816-831	Model Number #4							
832-839	Time stamp #4							
840-843	Inner Drive Test Zone address for Layer 0 #4							
844-847	Outer Drive Test Zone address for Layer 0 #4							
848-871	Running OPC Information #4							
872-873	DSV #4							
874	Test Zone usage descriptor #4							
875	Reserved #4							
876-879	Inner Drive Test Zone address for Layer 1 #4							

Table 264 - RMD - Field 1 (logical unit & OPC information) (continued)

Bit Byte	7	6	5	4	3	2	1	0
880-883	Outer Drive Test Zone address for Layer 1 #4							
884-895	Reserved #4							
896-959	Drive specific data #4							
960-1023	Reserved #4							
1 024-1 279	Drive specific data #1							
1 280-1 535	Drive specific data #2							
1 536-1 791	Drive specific data #3							
1 792-2 047	Drive specific data #4							

The Drive manufacturer ID #n field is recorded in binary and specifies unique drive manufacturer identifier of the logical unit.

The Serial Number #n field is recorded as ASCII code and specifies serial number of the logical unit.

The Model Number #n field is recorded as ASCII code and specifies the recorder model number.

The Timestamp #n field may be used to store date and time when OPC is performed. This field, if used, is recorded in binary. If this field is set to 0, this field is invalid.

The Inner Drive Test Zone address for Layer 0 #n field is recorded in binary and specifies the smallest ECC block address of the Drive Test Zone in the Data Lead-in Area where the last power calibration is performed. If these fields are set to 00h, then they are invalid.

The Outer Drive Test Zone address for Layer 0 #n field is recorded in binary and specifies the smallest ECC block address of the Drive Test Zone in the Middle Area where the last power calibration is performed. If these fields are set to 00h, then they are invalid.

The Running OPC Information field may be used to specify values concerning running OPC. The format is vendor-specific. If this field is set to 0, this field is invalid.

If the disc is incrementally recorded and when RMD is updated, the DSV field is recorded. This field is used to specify the last DSV (Digital Sum Value) in binary notation. If this field is set to 0, this field is invalid.

The Test Zone usage descriptor #n field specifies the usage for the 4 test zones.

Table 265 - Test Zone usage descriptor

Bit	Definition
4 - 7	Reserved
3	0b: The drive did not use the inner Drive Test Zone on Layer 0. 1b: The drive used the inner Drive Test Zone on Layer 0.
2	0b: The drive did not use the outer Drive Test Zone on Layer 0. 1b: The drive used the outer Drive Test Zone on Layer 0.
1	0b: The drive did not use the inner Drive Test Zone on Layer 1. 1b: The drive used the inner Drive Test Zone on Layer 1.
0	0b: The drive did not use the outer Drive Test Zone on Layer 1. 1b: The drive used the outer Drive Test Zone on Layer 1.

The Inner Drive Test Zone address for Layer 1 #n field is recorded in binary and specifies the start ECC block address of the Drive Test Zone in the Data Lead-out Area where the last power calibration is performed. If these fields are set to 00h, then they are invalid.

The Outer Drive Test Zone address for Layer 1 #n field is recorded in binary and specifies the start ECC block address of the Drive Test Zone in the Middle Area where the last power calibration is performed. If these fields are set to 00h, then they are invalid.

5.16.9.4 RMD Field 2

RMD Field 2 can be used freely and format of this field is user-specific.

Table 266 - RMD - Field 2 (User Specific Data)

Bit	7	6	5	4	3	2	1	0
Byte								
0-2 047	(MSB) User Specific Data							(LSB)

The User Specific Data field is available for user specific data. This field may be used, otherwise this field is set to 0.

5.16.9.5 RMD Field 3

RMD Field 3 specifies the format operation information of the disc and is recorded as defined in Table 267.

Table 267 - RMD - Field 3 (Format operation information)

Bit	7	6	5	4	3	2	1	0
Byte								
0	Format operation code							
1	Reserved							
2-5	(MSB)	Format information 1					(LSB)	
6	Format information 2							
7-2 047	Reserved							

Format operation code field specifies the Format operation code as shown in Table 268.

Format information 1 and Format information 2 field specify the information data related with format operation code and the contents of these field are shown in Table 268.

Table 268 - Format operation code and the contents of Format information 1 to 2

Format operation code		Format information 1	Format information 2
Value	Definition		
0	No format operation is in progress	Reserved	Reserved
1	Sequential padding	Reserved	Reserved
2	Finalization	Current PSN of formatted area	Current formatted area ^a
3	Clear user data	Reserved	Reserved
4	RMD initialization	Reserved	Reserved
Others	Reserved	Reserved	Reserved

- a. "Current formatted area" is the zone or the area where the progressing Format operation is being executed. This field specifies the zone or the area as follows;
- 01h: RZone
 - 03h: Terminator
 - 04h: Padding Zone
 - 10h: Middle Area
 - 20h: Data Lead-in Area
 - 30h: Original Data Lead-out Area
 - Others: Reserved

5.16.9.6 RMD Field 4

RMD Field 4 contains RZone related information and is recorded as follows.

Table 269 - RMD - Field 4 (RZone Information)

Bit Byte	7	6	5	4	3	2	1	0
0-1	(MSB) RZone Number							(LSB)
2-15	Reserved							
16-19	(MSB) Start PSN of RZone							(LSB)
20-23	(MSB) Last PSN of RZone							(LSB)
24-2 047	Reserved							

The RZone Number field contains the RZone number of the disc This field is zero or one.

The Start PSN of RZone field contains the start PSN of the RZone. If the RZone exists on the disc, this field is 40000h. If this field is set to zero, then there is no RZone on the disc.

The Last PSN of RZone field contains the last PSN of the RZone. If this field is set to zero, then there is no RZone on the disc.

5.16.9.7 RMD Field 5

RMD Field 5 contains the information of the defect status and the contents of this field is shown in Table 270.

Table 270 - RMD - Field 5 (Defect status Information)

Bit Byte	7	6	5	4	3	2	1	0
0-3	Reserved							
4	Defect status of RMD duplication zone							
5-17	(MSB) Defect status of RMZ							(LSB)
18	Defect status of R-PFI Zone							
19-2 047	Reserved							

The Defect status of RMD duplication zone field specifies the defect status of RDZ. This field is defined in Table 271.

Table 271 - Defect status of RMD duplication zone definition

Bit	Definition
7	Reserved
0 - 6	0b: To indicate that the ECC block #n is non-defective. 1b: To indicate that the ECC block #n is defective.

The Defect status of RMZ field specifies the defect status of RMZ. This field is defined in Table 272.

Table 272 - Defect status of RMZ definition

Bit	Definition
98 - 103	Reserved
0 - 97	0b: To indicate that the ECC block #n is non-defective. 1b: To indicate that the ECC block #n is defective.

The Defect status of R-PFI Zone field specifies the defect status of R-Physical Format Information Zone. This field is defined in Table 273.

Table 273 - Defect status of R-PFI Zone definition

Bit	Definition
7	Reserved
0 - 6	0b: To indicate that the ECC block #n is non-defective. 1b: To indicate that the ECC block #n is defective.

5.16.9.8 RMD Field 6

RMD Field 6 contains the Bit map of each ECC block pair status in L0 information and is recorded as follows. The ECC block pair contains two continuous ECC blocks. Each ECC block pairs are identified by a serial number J which starts from 0 to 16383. The serial number is assigned from the first ECC block pair at the start PSN of Data Area in the ascending order.

Bit 0 of Byte 0 indicates the status of the ECC block pair having the first serial number 0.

Table 274 - RMD - Field 6 (ECC block pair status in Layer 0 information)

Bit Byte	7	6	5	4	3	2	1	0
0	#7	#6	#5	#4	#3	#2	#1	#0
1	#15	#14	#13	#12	#11	#10	#9	#8
2	#23	#22	#21	#20	#19	#18	#17	#16
:	:							
2 046	#16 375	#16 374	#16 373	#16 372	#16 371	#16 370	#16 369	#16 368
2 047	#16 383	#16 382	#16 381	#16 380	#16 379	#16 378	#16 377	#16 376

Each bit specifies the status of the ECC block pair according to the following rule.

Table 275 - Bit definition

Value	Definition
0b	To indicate that the ECC block pair isn't recorded with data whose Area type is Data Area.
1b	To indicate that the ECC block pair is recorded with data whose Area type is Data Area.

5.16.9.9 RMD Field 7 ~ Field 12

RMD Field 7 through Field 12 contain the Bit map of each ECC block pair status in L0 information continued from RMD Field 6.

Table 276 - RMD - Field 7 ~Field 12 (ECC block pair status in Layer 0 information ... continued)

Bit Byte	7	6	5	4	3	2	1	0
0	#n+7	#n+6	#n+5	#n+4	#n+3	#n+2	#n+1	#n
1	#n+15	#n+14	#n+13	#n+12	#n+11	#n+10	#n+9	#n+8
2	#n+23	#n+22	#n+21	#n+20	#n+19	#n+18	#n+17	#n+16
:	:							
2 046	#n+16 375	#n+16 374	#n+16 373	#n+16 372	#n+16 371	#n+16 370	#n+16 369	#n+16 368
2 047	#n+16 383	#n+16 382	#n+16 381	#n+16 380	#n+16 379	#n+16 378	#n+16 377	#n+16 376

Each ECC block pairs are identified by a serial number J which starts from 16384 to 114543. Byte 2030 to 2047 in Field12 are set to 00h.

5.16.9.10 RMD Field 13

RMD Field 13 contains the Bit map of each ECC block pair status in L1 information and is recorded as follows. The ECC block pair contains two continuous ECC blocks. Each ECC block pairs are identified by a serial number J which starts from 0 to 16383. The serial number is assigned from the first ECC block pair at the start PSN of Data Area in the ascending order.

Bit 0 of Byte 0 indicates the status of the ECC block pair having the first serial number 0.

Table 277 - RMD - Field 13 (ECC block pair status in Layer 1 information)

Bit Byte	7	6	5	4	3	2	1	0
0	#7	#6	#5	#4	#3	#2	#1	#0
1	#15	#14	#13	#12	#11	#10	#9	#8
2	#23	#22	#21	#20	#19	#18	#17	#16
:	:							
2 046	#16 375	#16 374	#16 373	#16 372	#16 371	#16 370	#16 369	#16 368
2 047	#16 383	#16 382	#16 381	#16 380	#16 379	#16 378	#16 377	#16 376

Each bit specifies the status of the ECC block pair according to the following rule.

Table 278 - Bit definition

Value	Definition
0b	To indicate that the ECC block pair isn't recorded with data whose Area type is Data Area.
1b	To indicate that the ECC block pair is recorded with data whose Area type is Data Area.

5.16.9.11 RMD Field 14 ~ Field 19

RMD Field 14 through Field 19 contain the Bit map of each ECC block pair status in L1 information continued from RMD Field 13.

Table 279 - RMD - Field 14 ~Field 19 (ECC block pair status in L1 information ... continued)

Bit Byte	7	6	5	4	3	2	1	0
0	#n+7	#n+6	#n+5	#n+4	#n+3	#n+2	#n+1	#n
1	#n+15	#n+14	#n+13	#n+12	#n+11	#n+10	#n+9	#n+8
2	#n+23	#n+22	#n+21	#n+20	#n+19	#n+18	#n+17	#n+16
:	:							
2 046	#n+16 375	#n+16 374	#n+16 373	#n+16 372	#n+16 371	#n+16 370	#n+16 369	#n+16 368
2 047	#n+16 383	#n+16 382	#n+16 381	#n+16 380	#n+16 379	#n+16 378	#n+16 377	#n+16 376

Each ECC block pairs are identified by a serial number J which starts from 16 384 to 114 349.

Bit 4 to Bit 7 of Byte 2 004 in Field 19 are set to 0b. Byte 2 030 to 2 047 in Field12 are set to 00h.

5.16.10 Reading/recording of RMD

5.16.10.1 RMD recording in RDZ

In RDZ, RMD which has the largest order number in the latest RMD set *shall* be copied when a disc state becomes Finalized or Full-finalized state, or a disc is to be ejected and the latest RMD is not copied.

The latest RMD in RDZ is pointer to the current valid RMD Set in L-RMZ. The latest RMD *shall* be recorded from inner ECC block to outer ECC block one by one. When the outermost ECC block is recorded, the next RMD *shall* be recorded at the innermost ECC block. This recording order *shall* continue cyclically in 7 ECC blocks. If unrecorded ECC blocks are remained when a disc state becomes Finalized or Full-finalized state, the latest RMD *shall* be recorded in the remaining ECC blocks of the RDZ. See 5.4.4.6.5, "Recording Management Data Duplication Zone (RDZ)" on page 323.

5.16.10.2 RMD recording in L-RMZ

In L-RMZ, all RMD blocks *shall* be recorded as an RMD Set. Each RMD Set *shall* consist of 4 RMD blocks that are all equivalent except RMD order number field. See 5.4.4.6.6, "Recording Management Zone (L-RMZ)" on page 323.

When the RMD information is changed, the updated RMD Set *shall* be recorded in L-RMZ. RMD *shall* be recorded in a RMD set from inner to outer one by one. When the outermost RMD set #97 is recorded, the next RMD *shall* be recorded at the innermost RMD set #0. This recording order *shall* continue cyclically in 98 RMD sets. When the renewed RMD is recorded in a RMD set, the RMD serial number *shall* be incremented by 1. The initial value of the RMD serial number *shall* be 0.

If a RMD set has 2 or more ECC blocks with EDC error at the latest RMD recording, the defect status of RMZ *shall* be renewed and the latest RMD with the renewed defect status *shall* be recorded in the next RMD set without increasing the RMD serial number.

If blank RMD sets are remained when a disc state becomes Finalized or Full-finalized state, the latest RMD *shall* be recorded in the blank RMD sets without increasing the RMD serial number.

The recorded RMD in each ECC block *shall* contain the correct RMD set number and RMD order number in accordance with the ECC block location.

5.16.10.3 RMD read sequence

Read sequence of RMD is as follows:

1. Find the latest RMD in RDZ
Logical unit reads the RMD serial number field of RMDs in RDZ and finds the latest RMD in RDZ which has the largest RMD serial number.
2. Find the latest RMD set in L-RMZ
Logical unit obtains the RMD set number of the latest RMD set in L-RMZ by reading the RMD set number field of the latest RMD in RDZ.
3. Logical Unit reads the latest RMD set.

5.17 Recording and reading for HD DVD-RAM media

HD DVD-RAM media is directly addressable by a logical block address and permits reading and writing from any of the consecutively numbered logical blocks. Though the Logical Block Addresses are consecutive, the actual data may not be stored in a consecutive manner because of defect management and the existence of physical sectors which do not directly correspond to logical blocks. Such physical sectors comprise spare sectors and unused sectors.

5.17.1 Logical layout of HD DVD-RAM media

In the case of HD DVD-RAM, the LBA numbering increases from the inner land area to the outer land area, then increase from the inner groove area to the outer groove area. The last LBA of land area adjoins the first LBA of groove area. Then LBA continues from 0 to last LBA.

HD DVD-RAM media is divided into multiple Zones. The first sector of each revolution in these Zones always align. The data is recorded using a constant angular velocity within each Zone, thus the actual size of the “bits” within a zone increase from the beginning of a zone toward the end of the zone. This keeps the data rate constant for reading and writing within each Zone with constant rotational speed. Each Zone has a fixed radius in width and as such each contains a different number of sectors.

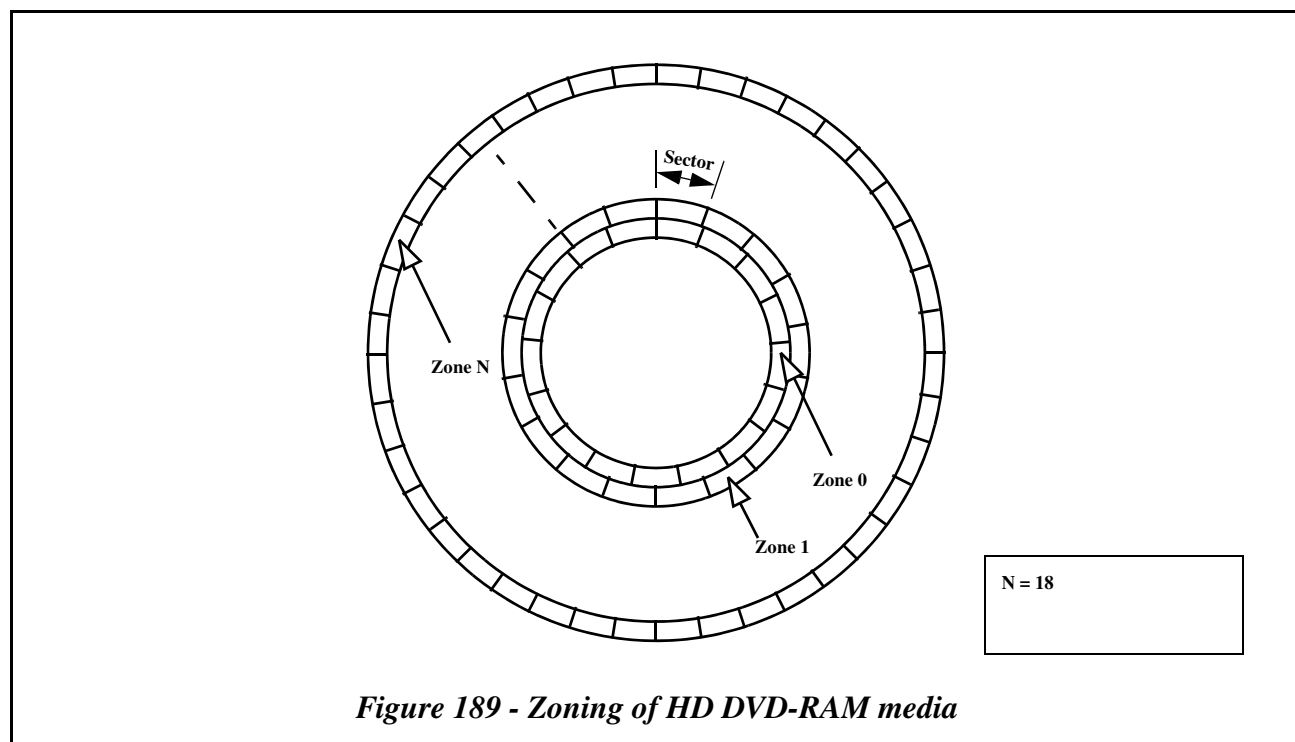


Figure 189 - Zoning of HD DVD-RAM media

The Data Area begins at 030000h for HD DVD-RAM, like HD DVD-ROM and HD DVD-R, where Data Areas begin at 030000h. This is caused by the existence of Defect Controls. There are two Defect Controls: one is located immediately before the Data Area and starts at 02CE00h, and the other is located immediately after the Data Area. The Defect Controls are non-user addressable areas. These blocks contain Defect Management Areas (DMAs) and DMA managers.

The DMA contains Disc Definition Structure (DDS) for the recording method used for formatting of the disc, a Primary Defect List (PDL) for recording defective sectors identified at formatting of the disc, and a Secondary Defect List (SDL) for recording defective ECC blocks identified during writing/reading user data.

1. HD DVD-RAM Ver. 1.0

The Data Area has one or two Spare Areas. There are two types of Spare area, Primary Spare Area (PSA) and Supplementary Spare Area (SSA). Primary Spare Area is always pre-assigned at Initialization/Re-initialization. Pre-assigned Supplementary Spare Area is selectable at Initialization/Re-initialization. And Supplementary Spare

Area is expandable after Initialization/Re-initialization. The User Area and Spare Areas contain user accessible sectors addressed by an LBA. The LBAs increase toward the Outer Diameter within each of land/groove. Defective sectors are replaced by sectors in the Spare Area. In the case of without SSA, the last LBA is 9644FFh. The location of Primary Spare Area is written in the DDS and the location of Supplementary Spare Area is written in the SDL. The total number of sectors in Primary Spare Area is 73 600. HD DVD-RAM Ver. 1.0 has only one group. The total number of sectors in Supplementary Spare Area is from 0 to 227 328. The Guard Area is located at the boundary to prevent signal crosstalk between Zones (See Figure 281). LBA of first Sector in the Group in Figure 281 is the case of no defects in the media.

5.17.2 Supplementary Spare Area

As long as a disc is used with a cartridge, PSA has enough size to ensure user data. PSA is allocated in inner area of the Data Area regardless of formatting type. A block in the PSA is used as a replacement block of a defective block in the user Data Area according to Slipping Replacement Algorithm or Linear Replacement Algorithm.

When a disc is used without a cartridge, defective blocks caused by contamination may increase unexpectedly. In order to supplement insufficiency of spare blocks, SSA can be allocated on formatting or after formatting. SSA is allocated in the most outer area of the Data Area and may grow toward inner radius.

On formatting of a disc, the host can allocate SSA with FORMAT UNIT command with Format Type field of 00h in the Format Descriptor. See Figure 190. The number of blocks to be used for user data recording is specified with Number of Blocks field in the Format Descriptor, and the rest of Data Area is assigned for SSA. All allocatable number of blocks **shall** be returned in Formattable Descriptors with Format Type field of 00h in response to READ FORMAT CAPACITIES command. On the formatting with Format Type with 00h, defect management information may be changed and user data written before the formatting is not guaranteed.

If the number of available spare blocks decreases because of many replacement operation, SSA is expandable after formatting of a disc. The logical unit **shall** report CHECK CONDITION status, 1/5D/03 FAILURE PREDICTION THRESHOLD EXCEEDED - Predicted Spare Area Exhaustion in response to the command after detecting consumption of available spare blocks. If the host receives the Recovered Error for consumption of spare area, the host should issue FORMAT UNIT command with Format Descriptor that contains Format Type field of 01h and the Number of Blocks field. The Format Descriptor, that is sent with FORMAT UNIT command **shall** be one of the Formattable Descriptors returned by READ FORMAT CAPACITIES command. All allocatable number of blocks **shall** be returned in Formattable Descriptors with Format Type field of 01h in response to READ FORMAT CAPACITIES command, but Formattable Descriptors that contain the Number of Blocks larger than or equal to the current Number of Blocks **shall not** be returned. If the area that is newly allocated to the SSA includes user data, the host should move the user data and update file management information. On expansion operation of SSA, user data that is included in the LBA Space after expansion **shall** be retained and defect management information **shall not** be changed.

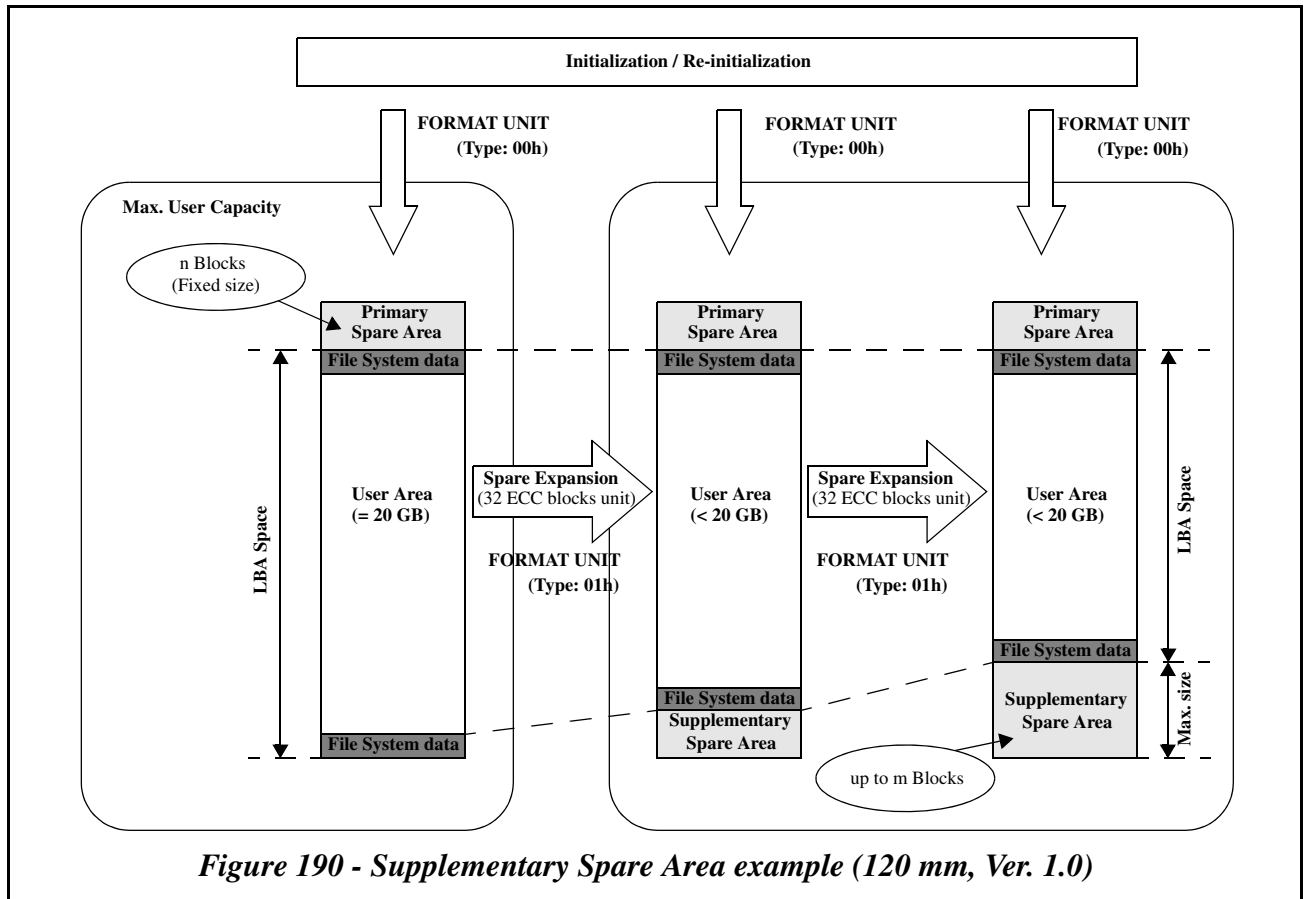
SSA **shall** be used after PSA exhaustion. See Figure 191. The Spare Area is used in descending Block order in each of Spare Areas, and the defective sectors in the Spare Area and the corresponding replacement sectors, which have been already registered in the PDL or the SDL, **shall not** be used as spare sectors.

Generally the proper default size of spare area should be determined by the main purpose. If the main purpose is non Real-Time data recording, then the default spare area size should be maximum. Because the linear replacement algorithm is usually applied to the non Real-Time data by using spare area. If the main purpose is Real-Time data recording, then the default spare area size should be minimum. Because the linear replacement algorithm **shall not** be applied to the Real-Time data (object file) recording. See the following matrix.

If the purpose is unclear at the formatting, then maximum SSA may be recommended because of the fail safe. To extend SSA, the special application software for the re-partitioning the physical volume is necessary.

Table 280 - Recommendation default size of Spare Area

	Main purpose	
	Non Real-Time data	Real-Time data
PSA (fixed size)	Fixed	Fixed
SSA (Min - Max)	Max	Min



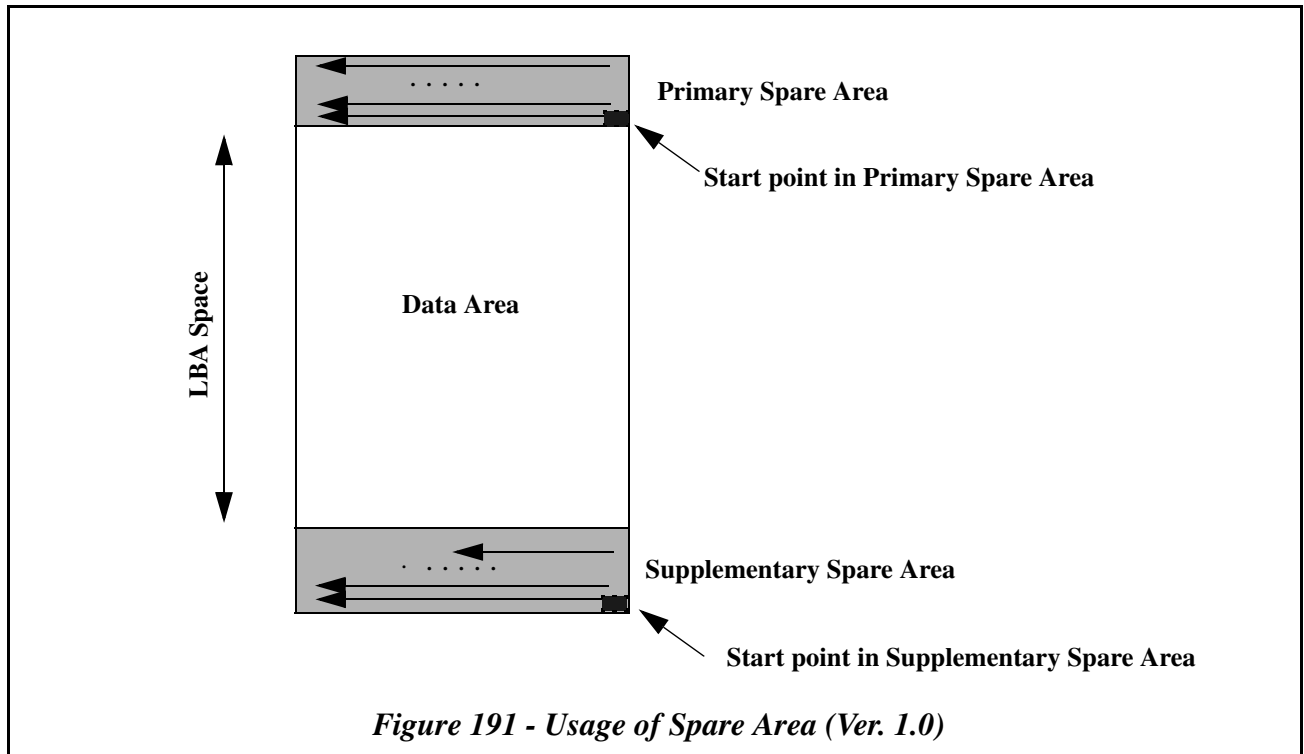


Table 281 - Allocation of Data Area of HD DVD-RAM Ver. 1.0 media

L/G	Zone No.	No. of Physical Sectors			LBA of first Sector in the Group	
		Guard Area	User Area	Spare Area		
L ^a	0		60 672	73 600	192	0
L	1	128	172 160	0	192	60 672
L	2	160	184 416	0	224	232 832
L	3	160	196 736	0	224	417 248
L	4	160	209 024	0	256	613 984
L	5	192	221 312	0	256	823 008
L	6	192	233 600	0	288	1 044 320
L	7	192	245 920	0	288	1 277 920
L	8	192	258 240	0	288	1 523 840
L	9	224	270 496	0	320	1 782 080
L	10	224	282 816	0	320	2 052 576
L	11	224	295 104	0	352	2 335 392
L	12	256	307 392	0	352	2 630 496
L	13	256	319 680	0	384	2 937 888
L	14	256	332 000	0	384	3 257 568
L	15	256	344 320	0	384	3 589 568
L	16	288	356 576	0	416	3 933 888
L	17	288	368 896	0	416	4 290 464
L	18	288	227 872	0	0	4 659 360

Table 281 - Allocation of Data Area of HD DVD-RAM Ver. 1.0 media

L/G	Zone No.	No. of Physical Sectors				LBA of first Sector in the Group
		Guard Area	User Area	Spare Area	Guard Area	
G ^b	0	0	134 272	0	192	4 887 232
G	1	128	172 160	0	192	5 021 504
G	2	160	184 416	0	224	5 193 664
G	3	160	196 736	0	224	5 378 080
G	4	160	209 024	0	256	5 574 816
G	5	192	221 312	0	256	5 783 840
G	6	192	233 600	0	288	6 005 152
G	7	192	245 920	0	288	6 238 752
G	8	192	258 240	0	288	6 484 672
G	9	224	270 496	0	320	6 742 912
G	10	224	282 816	0	320	7 013 408
G	11	224	295 104	0	352	7 296 224
G	12	256	307 392	0	352	7 591 328
G	13	256	319 680	0	384	7 898 720
G	14	256	332 000	0	384	8 218 400
G	15	256	344 320	0	384	8 550 400
G	16	288	356 576	0	416	8 894 720
G	17	288	368 896	0	416	9 251 296
G	18	288	227 872-M	M	0	9 620 192
Total	N/A	7872	9 848 064-M	73 600+M ^c	11 072	N/A

a. L: Land

b. G: Groove

c. M is the number of sectors of the Supplementary spare area.

5.17.3 Unrecorded ECC blocks

A HD DVD-RAM disc which has not been certified may contain unrecorded ECC blocks to which user data has not been written. The logical unit *shall* return all zero data in response to an attempt to read logical blocks from such unrecorded ECC blocks. Further, a logical block may contain an initialization pattern used at certification which can be discriminated by the Data ID of the logical block. The logical unit also returns all zero data in response to an attempt to read such Logical Blocks containing the initialization pattern.

5.17.4 Read Modify Write

Any attempt to write data less than one ECC block causes a read-modify-write operation in the logical unit, which requires more than one rotation to write the data, if data is not cached.

1. Reading an ECC block containing the designated logical blocks (First path)
2. Overlay the data to be written onto the read out ECC block data
3. Writing the modified ECC block data back to the same addresses (Second path)

When an ECC block designated for Read-Modify-Write operation is physically unwritten or contains the initialization pattern used at certification, which can be discriminated by the Data ID of the Logical Block, the logical unit writes all zero data to the logical blocks in the ECC block other than the designated Logical Blocks from the host.

A technique to provide better performance with HD DVD-RAM media is to write data in sizes that are a multiple of 65 536 bytes starting at a logical block address that is a multiple of 32, which results in a one path direct overwrite

operation. These values can be determined from the Random Readable Feature Descriptor (see 17.4.2.6, "Feature 0010h: Random Readable" on page 573).

5.17.5 Data ID

HD DVD-RAM has same Data ID structure that HD DVD-ROM and HD DVD-R have.

5.17.6 Defect management for HD DVD-RAM media

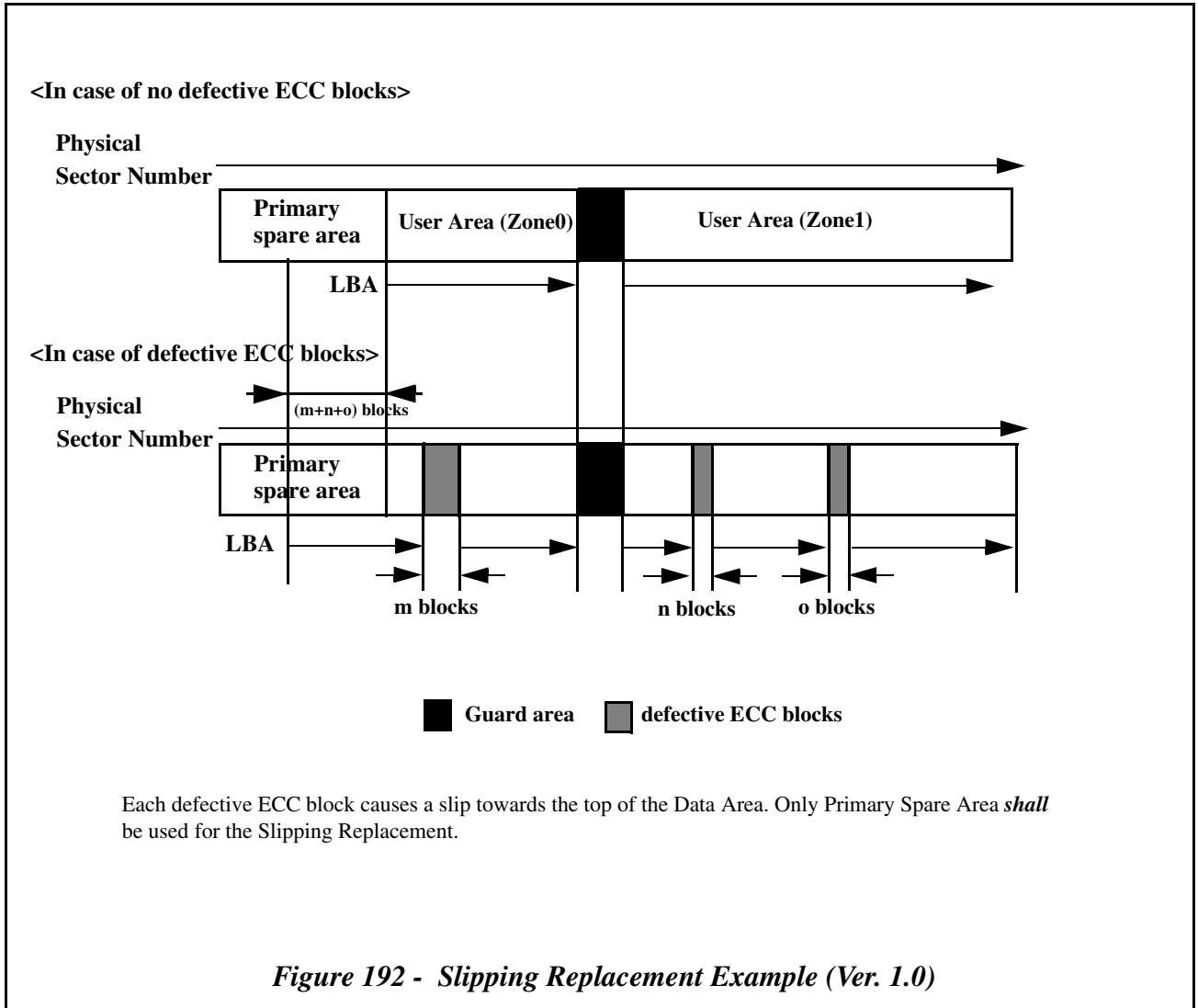
Defective physical sectors in the Data Area of HD DVD-RAM media are managed by the logical unit according to the defect management scheme specified in the HD DVD Book for Rewritable Disc, Part 1: Physical Specifications.

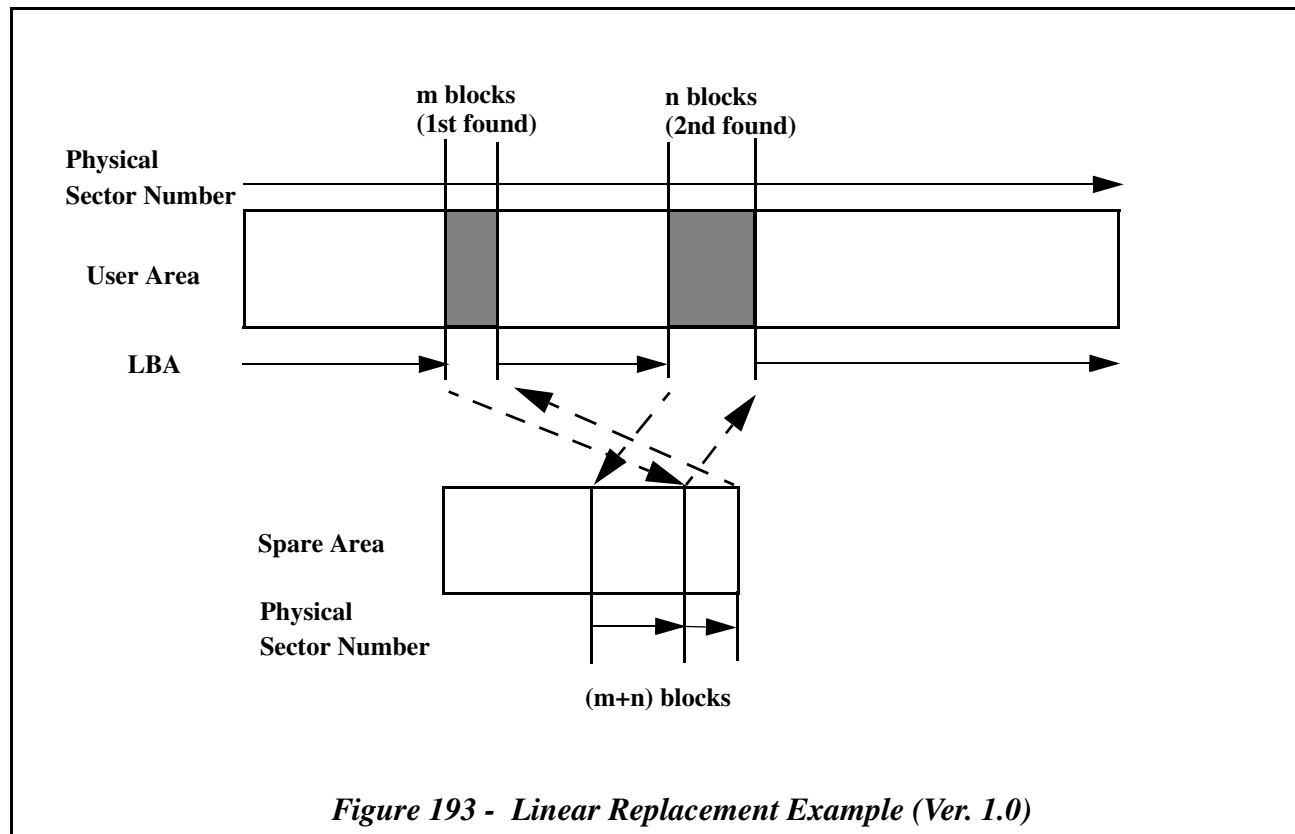
Two replacement methods are defined for defective physical sectors:

Slipping replacement is the first method in which a defective ECC block is replaced by the first non-defective ECC block following the defective ECC block. The slipping replacement is performed in units of an ECC block. Defective ECC blocks replaced by the slipping replacement are listed in Primary Defect List (PDL) recorded on the HD DVD-RAM media during formatting. Contents of the PDL on HD DVD-RAM media can be changed only by formatting. The number of ECC blocks to be listed in the PDL *shall not* exceed the number of ECC blocks in the Spare Area. Entries of the PDL consist of three categories: P-list, G₁-list and G₂-list.

- Defective physical ECC blocks encountered by media manufacturer before shipment of the HD DVD-RAM media are listed in the P-list. A defect is registered to the P-list in a unit of 1 ECC block. Time to perform the slipping replacement for a defective ECC block listed in the P-list is minimal, because it requires time only to pass the defective ECC block. The P-list *shall* be preserved during any formatting and *shall* be always used in order to avoid possible change of ECC block framing by formatting.
- Defective ECC blocks encountered by certification after shipment of the HD DVD-RAM media are listed in the G₁-list. A defect is registered to the G₁-list in a unit of 1 ECC block. Time to perform the slipping replacement for a defective ECC block listed in the G₁-list is minimal as in the P-list. The G₁-list *shall* be always used and *shall* only be changed with certification in order to avoid possible change of ECC block framing by formatting.
- Defective ECC blocks transformed from the SDL by formatting are listed in the G₂-list. A defect registered to the G₂-list consumes 32 entries at once. Time to perform the Slipping Replacement for defective ECC block listed in the G₂-list is longer than the time for P-list or G₁-list, because it requires time to pass 32 consecutive ECC block. However, it is still much faster than Linear Replacement because it does not require a Seek operation to the Spare Area. The G₂-list can be changed without certification, however, the G₂-list *shall* be disposed at certification in order to avoid possible change of ECC block framing by formatting

Linear Replacement is the second method in which a defective ECC block is replaced by the first available ECC block out of spare sectors. The linear replacement is performed in a unit of an ECC block. An ECC block found to be defective is replaced by the first available good spare ECC block. If there is no spare ECC block left, the first available good spare ECC block is used. Defective ECC blocks replaced by the Linear Replacement are listed in the Secondary Defect List (SDL) recorded on the HD DVD-RAM media. Contents of the SDL on HD DVD-RAM media are updated whenever an ECC block is found to be defective. When a replacement ECC block is found to be defective, a new replacement ECC block will be substituted and the SDL will be updated on the media. Chaining of replacement will not be performed, direct pointer method will be applied. Time to perform the Linear Replacement is longer than Slipping Replacement because it requires seek operation to the Spare Area and writing/reading the replacement ECC block. However, this is the only method to register a new defect without formatting the media.





5.17.7 DMA information

The Defect Management Area (DMA) consists of two ECC blocks. The first ECC block contains the Disc Definition Structure (DDS) for the recording method used for formatting of the disc, and the Primary Defect List (PDL) for recording defective sectors identified at formatting of the disc. The DDS contains the following information.

- In-progress flag indicating formatting operation is completed or not. This flag enables to recover a suspended formatting operation.
- A flag indicating the media has been certified by media manufacturer or not.
- A flag indicating the media has been certified by the logical unit or not.

The PDL contains information of ECC blocks to be replaced by the slipping replacement. Though the PDL has a capacity to hold defective ECC block information for up to 15871 ECC blocks in the case of 120mm, there is another limitation of the maximum number. See Figure 195 - *Limitation of maximum number of sectors for PDL and SDL* on page 452.

The second ECC block contains the Secondary Defect List (SDL) for recording defective ECC blocks identified during writing/reading user data. Though the SDL has a capacity to hold the defective ECC block information up to 8189 ECC blocks, there is another limitation of the maximum number. See Figure 195 - *Limitation of maximum number of sectors for PDL and SDL* on page 452.

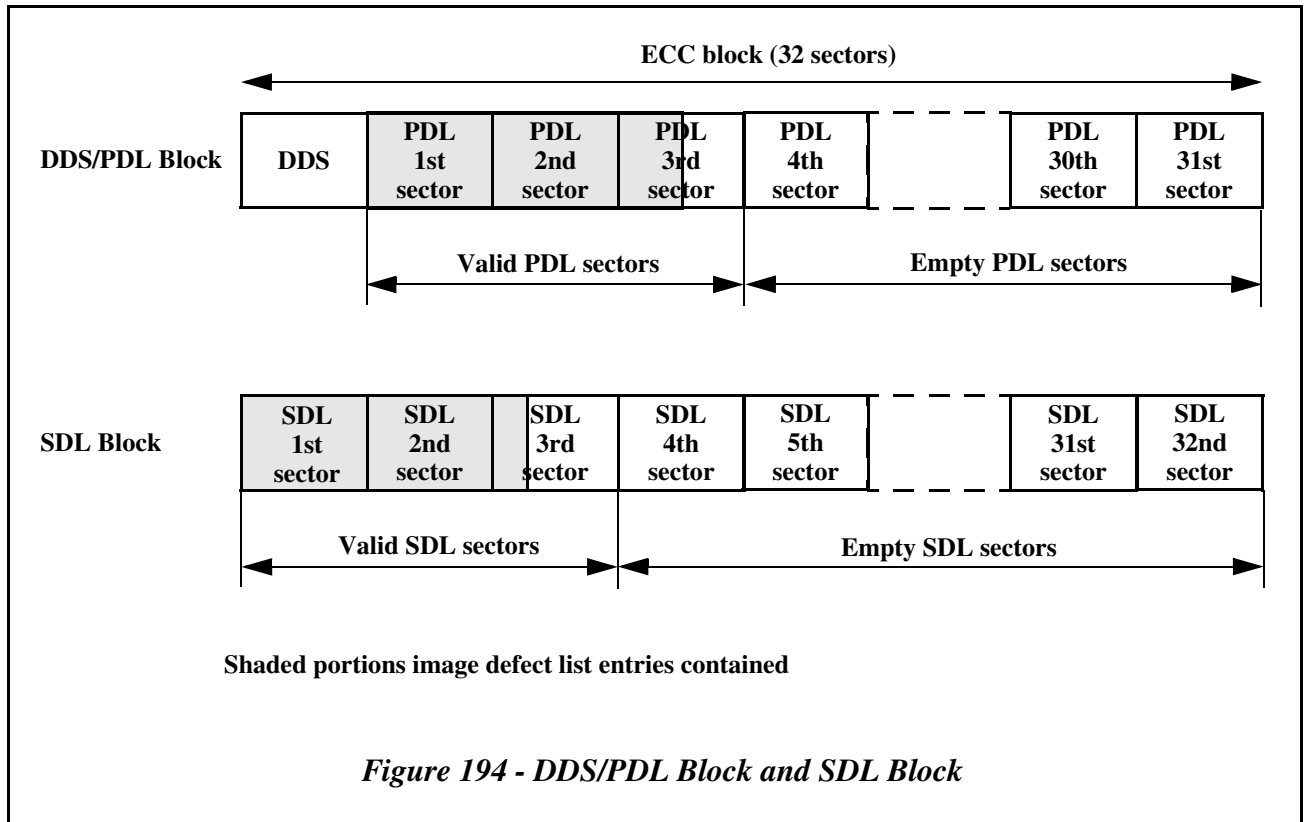


Table 282 - DDS information (Ver. 1.0)

Bit Byte	7	6	5	4	3	2	1	0
0 - 1	DDS Identifier (0A0Ah)							
2	Reserved							
3	Disc Certification Flag							
4 - 7	DDS/PDL Update Counter							
8 - 9	Number of Groups (0001H)							
10 - 11	Number of zones							
12 - 79	Reserved							
80 - 87	Location of Primary spare area							
88 - 91	Location of LSN0							
92 - 255	Reserved							
256 - 259	Start LSN for Zone0 in land							
260 - 263	Start LSN for Zone1 in land							
:	:							
328 - 331	Start LSN for Zone18 in land							
332 - 335	Start LSN for Zone0 in groove							
336 - 339	Start LSN for Zone1 in groove							
:	:							
404 - 407	Start LSN for Zone18 in groove							
408 - 2 047	Reserved							

Table 283 - Disc Certification Flag format (Ver. 1.0)

Bit							
7	6	5	4	3	2	1	0
Formatting in-progress	Reserved					The whole disc has been certified by user	The disc has been certified by disc manufacturer

The size of the defect lists will be limited by several factors. As the information about all defects in the PDL and the SDL *shall* be used to access LBAs, the defect lists would normally be kept in the logical unit's memory.

$$(1 \leq S_{PDL} \leq 31, 1 \leq S_{SDL} \leq 32)$$

$$S_{PDL} = INT \left[\frac{(E_{PDL} \times 4 + 4) + 2047}{2048} \right]$$

$$S_{SDL} = INT \left[\frac{(E_{SDL} \times 8 + 24) + 2047}{2048} \right]$$

S_{PDL} is the number of sectors used to hold PDL entries

S_{SDL} is the number of sectors used to hold SDL entries

E_{PDL} is the number of PDL entries

E_{SDL} is the number of SDL entries

Figure 195 - Limitation of maximum number of sectors for PDL and SDL

5.17.8 Scheduling of Linear Replacement

The HD DVD-RAM format is designed to enable the following Linear Replacement methods, with some consideration for issues of real-time data recording, where for example the reassignments are disabled during some operations.

- When recording data with verification by the WRITE AND VERIFY (10) command, the logical unit has an opportunity to evaluate the written data and if the data is found defective, the logical unit may perform a Linear Replacement.
- For data recorded without verification, the logical unit has an opportunity to evaluate the written data when the host attempts to read the data from that LBA and if the data is found defective but correctable by ECC, the logical unit may perform the Linear Replacement operation, if read reassignment is enabled.

5.17.9 Formatting

Formatting is required at the beginning of use of HD DVD-RAM media. During formatting, the logical unit defines correspondence between LBAs and physical addresses and records relevant information in the Defect Management Areas. All the user data in the formatted extent is lost during the formatting. Media certification may be included as a part of the formatting. No defect list *shall* be transferred from the host, i.e. there *shall* be no D-list for HD DVD-RAM media.

The certification process included in the formatting should not be confused with media certification from a media manufacturer. The logical unit controlled “certification” allows the logical unit to write and verify all the sectors on the media. This operation allows some defects to be registered in the G₁-list for the Slipping Replacement. These are not the same as certification defects from the media manufacture which is recorded in the P-list. The result of the “certification” process of the FORMAT UNIT command is to leave every sector with a special ID content called the “Initialization pattern.” This type of ECC block *shall* be treated as though all zero data has been written. This is the same as an unwritten ECC block.

If the total number of spare sectors are exhausted during a FORMAT UNIT command, the format operation will not stop, but will ignore those defects that cannot be replaced and a RECOVERED ERROR *shall* be reported at the completion.

If the size of the PDL and SDL are going to exceed the limit in Figure 195, the logical unit *shall* discard defect entries until the size does not exceed that limit.

There can be considered four kinds of formatting depending on how the certification performed and how the old defect list (G₁-list and G₂-list) is treated:

5.17.9.1 Formatting Type 1 - Slow Initialization

The purpose of Formatting Type 1 is to initialize the medium using the media manufacturer’s defect list (P-list), assuming that the media has defects not in the P-list. The logical unit performs its own certification. The execution time is long, at least one hour or more. Every physical sector should be written with initialization pattern and verified.

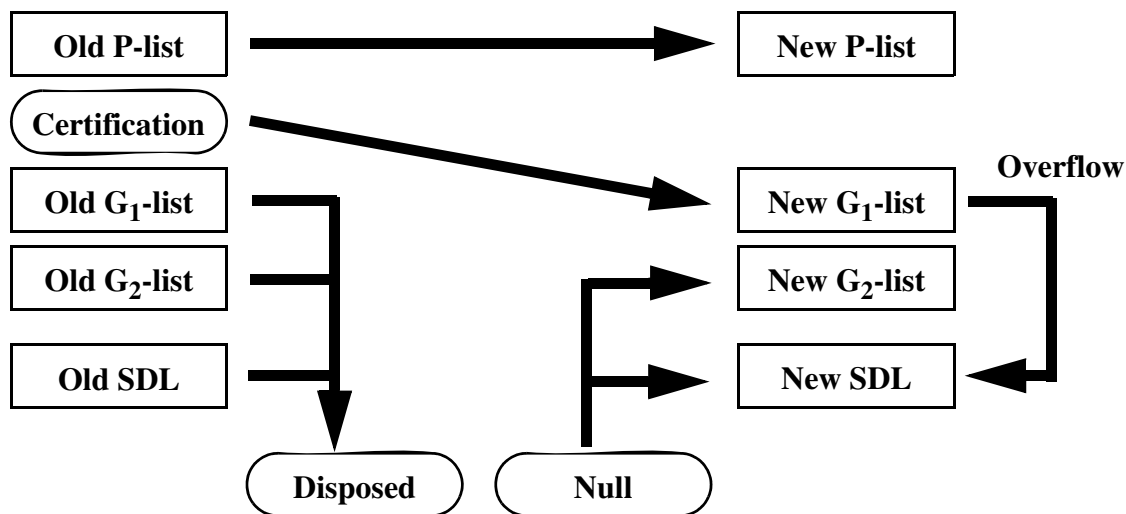


Figure 196 - Formatting Type 1 - Slow Initialization

5.17.9.2 Formatting Type 2 - Quick Improvement

The purpose of Formatting Type 2 is to remove reassigned sectors for Linear Replacement and change them to Slipping Replacement. The total number of Spare sectors available remains the same. The execution time is very little, only several seconds is expected.

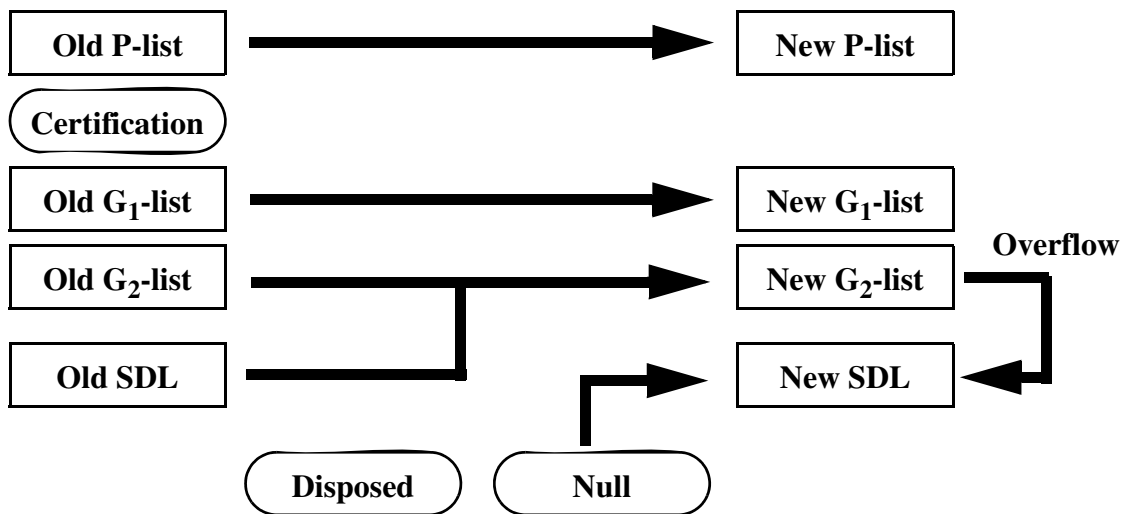


Figure 197 - Formatting Type 2 - Quick Improvement

5.17.9.3 Formatting Type 4 - Quick Clearing

The purpose of Formatting Type 4 is to initialize the media for use, using only media manufacturer defect information. Another purpose is to return the media to the latest certified state by removing reassigned sectors for Linear Replacement and the G₂-list. The execution time is very little; only several seconds is expected.

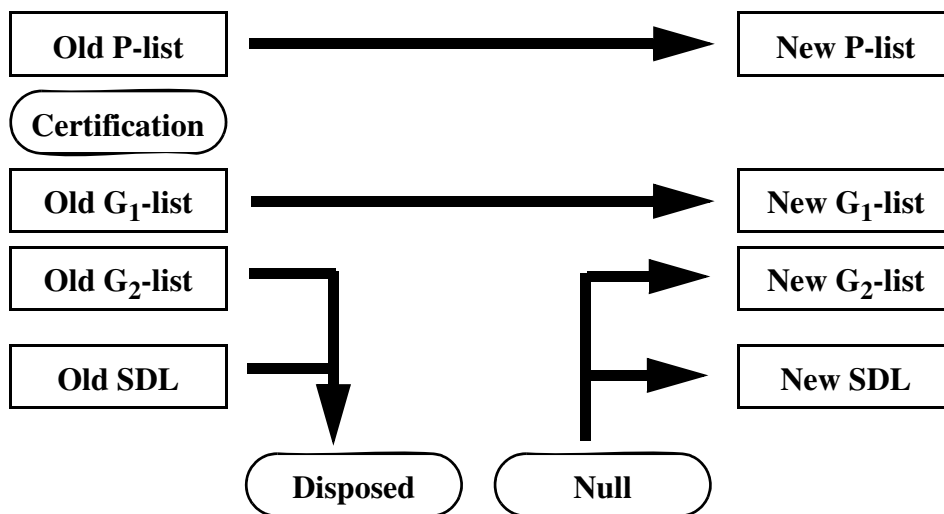


Figure 198 - Formatting Type 4 - Quick Clearing

5.17.10 Interruption of formatting

An interruption of formatting by reset, or power off may cause the media to be unusable without another formatting operation. In any case, all the user data in the formatting extent *shall* be assumed to be lost, because correspondence between the LBAs and physical addresses may have been changed.

- An interruption of formatting Type 1 may cause the media to be unusable because of uncompleted change of the assignment for the LBA. Any access to the media in this condition other than a proper FORMAT UNIT command

shall be terminated with CHECK CONDITION status, 3/31/00 MEDIUM FORMAT CORRUPTED. The only recovery operation to this case is another formatting by formatting Type 1 only.

- An interruption of formatting Type 2 causes the media to be usable as there is no media certify operation.
- An interruption of formatting Type 4 causes the media to be usable as there is no certification operation.

5.17.11 Cartridge and Disc Type

The definition of Cartridge and Disc Type for HD DVD is the same definition for DVD. See 4.16.12 "Cartridge and Disc Type" on page 129.

5.17.12 Write protection of a disc

5.17.12.1 Write-inhibit hole

This hole is the mechanical switch/tab for write protection on a cartridge. When this hole is closed, the logical unit may write/modify information according to the other write protection conditions. When this hole on a cartridge is open, the logical unit *shall not* write/modify/initialize any information (including user data, defect management information and Write-inhibit flag) on the disc.

Host is able to get the Write-inhibit hole condition as a CWP bit value using READ DISC STRUCTURE command with Format Code = C0h or 09h.

5.17.12.2 Sensor hole A1

The Sensor hole A1 indicates whether the disc had been taken out from a cartridge or not. The Sensor hole A1 is closed when the disc had never been taken out from the cartridge. The Sensor hole A1 is open when once the disc had been taken out from the cartridge. In the case of the Sensor hole A1 open, verify after write is recommended. A logical unit may reject certain write operations without verification. In this case, the command *shall* be terminated with CHECK CONDITION status, 7/27/06 CONDITIONAL WRITE PROTECT. These differences depend on the drive implementation for keeping data integrity.

Note: WRITE (12) command with Streaming bit set to one may not be affected by the Sensor hole A1 status. If logical unit does not permit execution of the command when Sensor hole A1 is open, the command is terminated with CHECK CONDITION status, 7/27/06 CONDITIONAL WRITE PROTECT.

Host is able to get the sensor hole A1 condition as a Out bit value using READ DISC STRUCTURE command with Format Code = 09h.

6.0 Hybrid disc model

A Hybrid disc is a media type consisting of at least two independent types of recording layers. This section describes the physical structure and logical structure of the Hybrid disc and behavior of a logical unit that supports Hybrid discs.

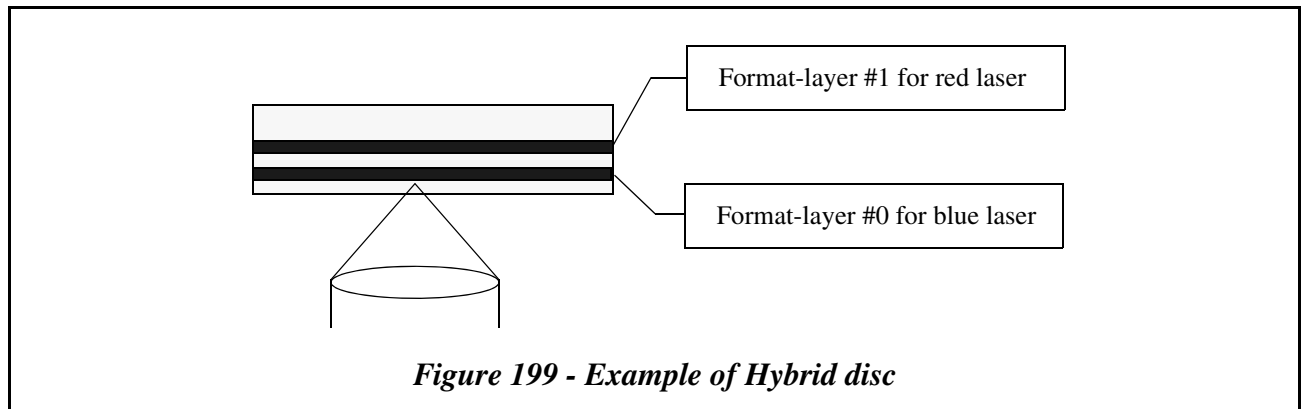
6.1 Background

So far, several standardization bodies have defined many kinds of optical disc physical format specifications. Some of these physical formats adopt the same shape of the disc, e.g. its radius, thickness, radius of the center hole, rotational direction and spiral direction. Consequently, it is possible to construct one disc with two or more types of recording layers, each of which conforms to an independent physical format specification.

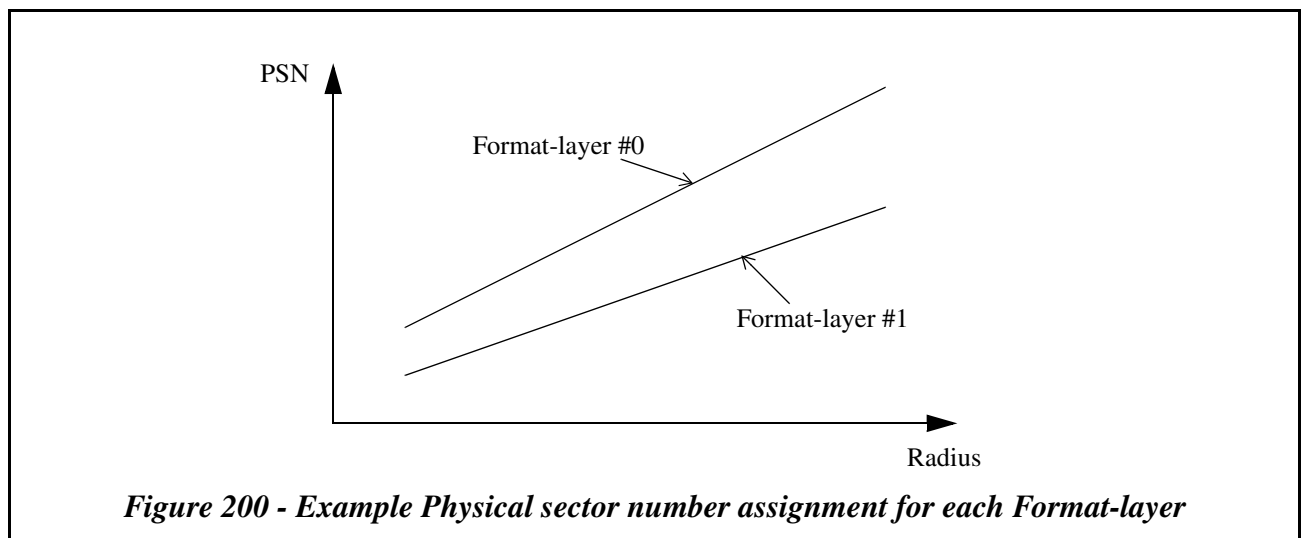
This type of the disc is called a Hybrid disc. Each type of recording layer included in a Hybrid disc is called a Format-layer in this specification. A Format-layer consists of one or more Layers (e.g., DVD Dual Layer disc).

6.2 Physical and logical structure of the Hybrid disc

Typically, the depth of each Format-layer and the wavelength of the corresponding laser diode in the optical pickup are different. A Format-layer conforms to its physical format specification, e.g. CD, DVD or HD DVD.



Since each Format-layer conforms to its own physical format specification, there is no change in the numbering of its physical sectors. Consequently, physical sector numbers assigned to the Format-layers may overlap partially or completely.

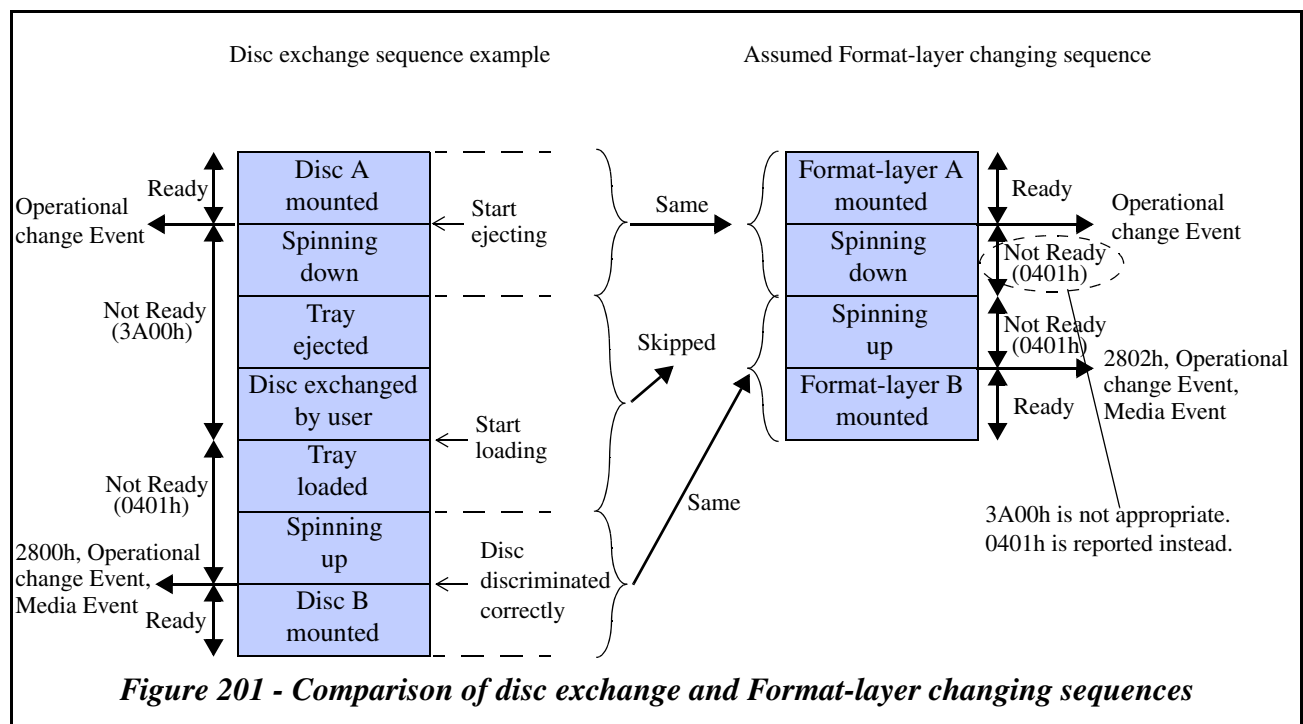


To support two or more Format-layers, the logical unit has an optical pickup with the appropriate laser diodes and objective lenses for each supported Format-layer. But only one of the Format-layers can be accessed at any given time because only one of the laser diodes and its associated objective lens can access the inserted disc at that time. The Format-layer currently accessed by the optical pick up is called the online Format-layer. If the logical unit is requested to access another Format-layer instead of the online Format-layer, it may take very long time, e.g. 10 seconds, because power calibration and other servo and signal calibrations are necessary to access the newly selected Format-layer. The Format-layer that becomes online when the disc is inserted is called the default Format-layer.

To access a user data recorded sector on a Format-layer specified by the host, the logical unit must assign physical sector numbers to Logical Block Addresses. The online Format-layer consists of an LBA space that starts from zero and is incremented by one toward the end sector of the online Format-layer. If a different Format-layer becomes the online Format-layer, the logical unit assigns the LBA space to the new online Format-layer, and the previous online Format-layer cannot be accessed until it is selected as the online Format-layer again.

6.3 Format-layer selection mechanism using the START STOP UNIT command

Format-layers are treated as if they are individual discs. From the user's point of view, changing the online Format-layer appears the same as a disc exchange. See Figure 201.



Support for Hybrid discs in a logical unit is indicated by a Hybrid disc Feature. This Feature exists when and only when the logical unit supports Hybrid discs. This Feature becomes current when the logical unit identifies two or more Format-layers in the mounted disc.

Format-layers are numbered from zero and incremented by one. The assignment rule of numbers to Format-layers is vendor-specific. The READ DISC STRUCTURE command with Format Code = 90h returns the relationship between the type of the identified Format-layers and their assigned numbers. The Format-layers that are not supported by the logical unit are not reported in Hybrid disc structure of the READ DISC STRUCTURE command.

When the Hybrid disc Feature is current, the host is able to select the online Format-layer with the START STOP UNIT command with FL bit set to one and the Destination Format-layer # field is set to the number of the desired Format-layer. If the Hybrid disc Feature is not current and either the FL bit or the Destination Format-layer # field in START

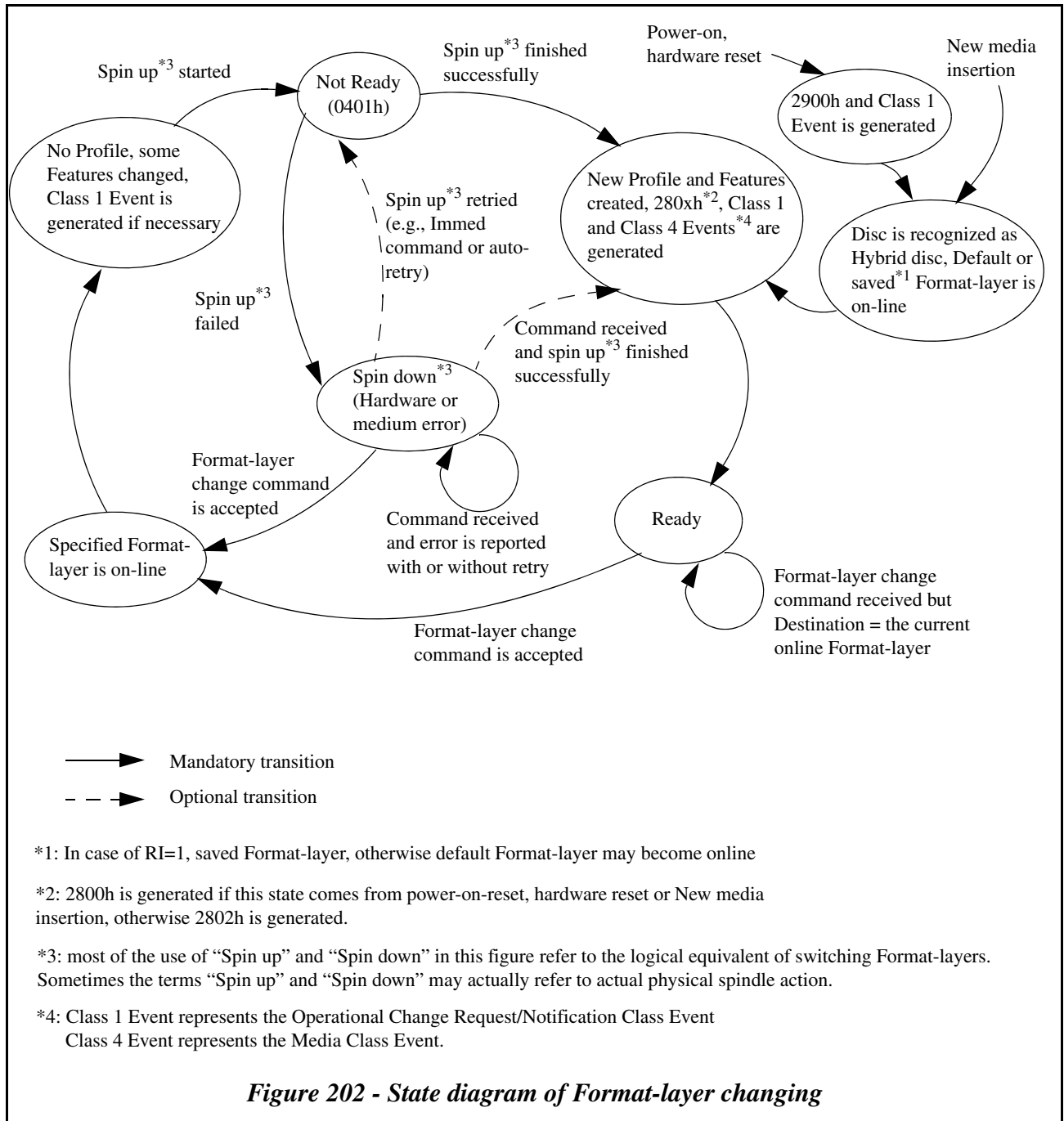
STOP UNIT command is not set to zero, the logical unit *shall* terminate the command with CHECK CONDITION Status, 5/24/00 INVALID FIELD IN CDB.

The logical unit treats this command as an immediate command and returns GOOD status as soon as the CDB is validated and the logical unit starts changing the online Format-layer. The logical unit generates a Operational Change Request/Notification Class Event and the destination Format-layer becomes online but no Profile is current. If the disc is prevented from being ejected with non-Persistent mode, the command is terminated with CHECK CONDITION Status, 5/53/02 MEDIUM REMOVAL PREVENTED.

While the logical unit is changing the online Format-layer, it is in the NOT READY state and sets the ASC/ASCQ to 04/01 LOGICAL UNIT IS IN PROCESS OF BECOMING READY.

After successfully switching to a new online Format-layer, the logical unit generates the UNIT ATTENTION condition with 28/02h NOT READY TO READY CHANGE, FORMAT-LAYER MAY HAVE CHANGED, Operational Change Request/Notification Class Event and Media Class Event. The Profile(s) associated with the new online Format-layer become(s) current. If the logical unit fails to change the online Format-layer, the logical unit reports the error as a deferred error. In this case, all Profiles are still not current and the Current Profile field of GET CONFIGURATION command is set to 00h.

Upon receiving a hardware reset, the default Format-layer may become online if the RI bit in the Hybrid disc Feature is zero. If the RI bit is one, the logical unit preserves the online Format-layer via the hardware reset. See Figure 202.



7.0 AACs content protection

Advanced Access Content System (AACs) is used to protect audiovisual content on such as HD DVD discs and DVD discs in HD DVD-Video or HD DVD-VR format. AACs Content Protection is made up of two basic concepts. The first is to encrypt the content of the data such that it *shall* be decrypted before it can be used. The capability of encrypting and/or decrypting the content is provided only under conditions that require products to be compliant with rules governing the playback, recording, copying, moving and output of the content. The second basic concept is to use an "Authentication" process to verify legitimacy of a host and a logical unit and to ensure the integrity of information transfer between the logical unit and the host. AACs uses its proprietary authentication process (AACs Authentication). The following parameters are transferred from the logical unit to the host by using the AACs Authentication.

- For read-only disc

- AACs uses a "Volume Identifier (Volume ID)" to encrypt content recorded on a set of read-only discs produced from the same glass master. Before decrypting such content the host reads the Volume ID using the READ DISC STRUCTURE command with Format Code = 80h.
- AACs may use a "Pre-recorded Media Serial Number" to identify each piece of read-only disc for an advanced feature. It is read by the host using the READ DISC STRUCTURE command with Format Code = 81h, when necessary.

- For writable discs

- AACs uses a "Media Identifier (Media ID)" to bind protected content to the disc on which it is recorded. Before encrypting or decrypting such content the host reads the Media ID using the READ DISC STRUCTURE command with Format Code = 82h.
- AACs uses a "Binding Nonce" to delete the content securely that is moved to another storage medium. Another purpose of the Binding Nonce is to bind keys that are used to encrypt contents to the disc. The Binding Nonce is generated and reported by a logical unit by using the REPORT KEY command with Key Class 02h and KEY Format 100000b. The generated Binding Nonce is memorized by the logical unit with associated LBA Extent provided by the REPORT KEY command and Authentication Grant ID for AACs (AGID for AACs) used for the REPORT KEY command. The stored Binding Nonce is recorded onto the disc together with user data by using the WRITE (10), WRITE (12) or WRITE AND VERIFY (10) command for a LBA that is included in the LBA Extent provided by the REPORT KEY command in such a way that the Binding Nonce is recorded in a number of logical blocks specified by the Block Count for Binding Nonce field of AACs Feature Descriptor, in the case of HD DVD this value is 4, starting from the LBA provided by the REPORT KEY command. If logical blocks are reallocated by logical unit, the Binding Nonce recorded or to be recorded to the original logical blocks *shall* be recorded to corresponding spare blocks. The stored Binding Nonce is invalidated by invalidating the AGID for AACs. When writing user data to logical blocks designated by a write command and when a Binding Nonce is not generated for these logical blocks, the logical unit *shall* initialize the field for Binding Nonce. A Binding Nonce recorded in the logical blocks other than designated by a write command *shall* be preserved through the read-modify-write operation. The host may read the Binding Nonce recorded by using the REPORT KEY command with Key Class 02h and KEY Format 100001b.
- AACs defines further protection of AACs-protected content called "Bus Encryption", in which the content is further encrypted on-the-fly when it is transferred between the logical unit and the host. When the Bus Encryption is introduced, the Data Keys are transferred by using the AACs Authentication by using the READ DISC STRUCTURE command with Format Code = 84h and the Write Data Key is transferred by using the AACs Authentication by using the SEND DISC STRUCTURE command with Format Code = 84h. For more detail, see 7.2, "AACs Bus Encryption" on page 465.
- AACs uses a Media Key Block of CPRM when recording content onto CPRM-capable DVD writable media, i.e., DVD-RAM, DVD-R and DVD-RW with AACs content protection, in order to ensure the current media is a correct CPRM-capable media. Because the Media Key Block of CPRM is not self-protected, the AACs Authentication is required for reading the first pack of Media Key Block of CPRM by using the READ DISC STRUCTURE command with Format Code = 86h.

AACS also uses “Media Key Block (MKB) of AACS”. In contrast to CPRM, the MKB of AACS is self-protected and does not require protection by an authentication. The MKB is read by the host using the READ DISC STRUCTURE command with Format Code = 83h, when it is recorded in the Lead-in Area.

Note: AACS does not use the Authentication Success Flag (ASF) or the Region Playback Control (RPC) which are used in the CSS.

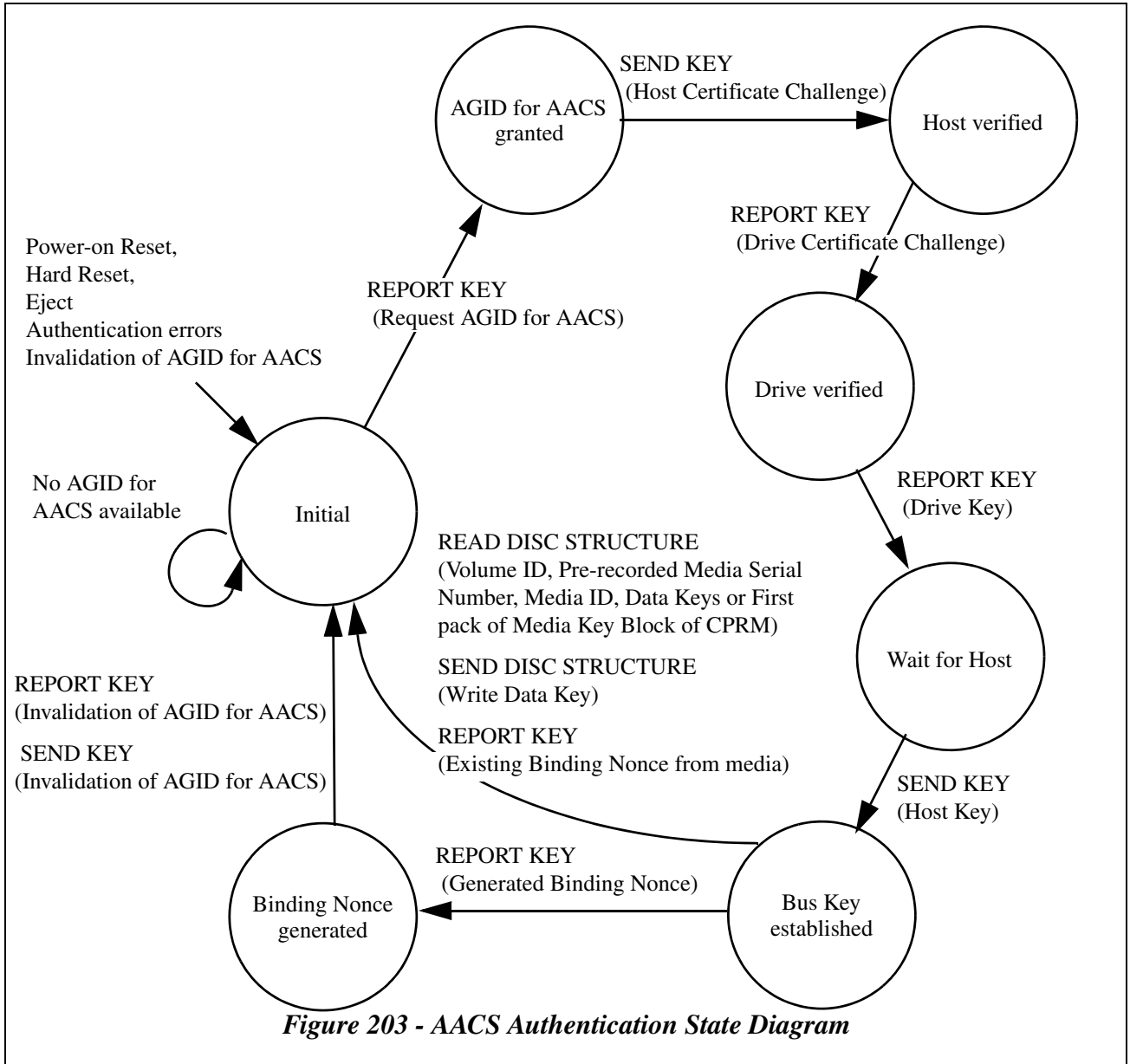
7.1 AACS Authentication process

The AACS Authentication is processed in a stateful manner. The process consists of 7 states as shown in Figure 203. This state diagram assumes an appropriate AACS-capable disc including CPRM-capable DVD writable medium is loaded. It may be possible to perform four processes concurrently.

1. “Initial” state: An AACS Authentication process starts from this state. The logical unit *shall* manage that all the processes are in this state after Power-on Reset, Hard Reset and the disc is ejected. When starting a process, the host requests an AGID for AACS by using the REPORT KEY command with Key Class 02h and KEY Format 000000b. The logical unit, when ready to begin an AACS Authentication process, *shall* grant the request by returning an AGID for AACS and enters “AGID for AACS granted” state. If there is no available AGID for AACS, the REPORT KEY command *shall* be terminated with CHECK CONDITION status, 5/55/00 SYSTEM RESOURCE FAILURE. If the host acknowledges that there is hung AACS Authentication processes initiated by itself, the host *shall* reset the hung authentication processes prior to the request by invalidating the corresponding AGIDs for AACS by using the REPORT KEY command with Key Class 02h and KEY Format 111111b or the SEND KEY command with Key Class 02h and KEY Format 111111b
2. “AGID for AACS granted” state: The host sends a Host Certificate Challenge to the logical unit by using the SEND KEY command with Key Class 02h and KEY Format 000001b. The logical unit verifies legitimacy of the Host Certificate Challenge and, if it is verified, enters “Host verified” state. When the Host Certificate Challenge is verified as it is not legitimate or is revoked, the command *shall* be terminated with CHECK CONDITION status, 5/6F/00 COPY PROTECTION KEY EXCHANGE FAILURE - AUTHENTICATION FAILURE and the logical unit *shall* return to the “Initial” state.
3. “Host verified” state: The host requests a Drive Certificate Challenge from the logical unit by using the REPORT KEY command with Key Class 02h and KEY Format 000001b. The host verifies legitimacy of the Drive Certificate Challenge and, if it is verified, enters “Drive verified” state. When the Drive Certificate Challenge is verified as it is not legitimate or is revoked, the host *shall* abort the authentication process by invalidating the AGID for AACS in use by using the REPORT KEY command with Key Class 02h and KEY Format 111111b or the SEND KEY command with Key Class 02h and KEY Format 111111b.
4. “Drive verified” state: The host requests the logical unit to return a Drive Key by using the REPORT KEY command with Key Class 02h and KEY Format 000010b.
5. “Wait for Host” state: The host sends a Host Key to the logical unit by using the SEND KEY command with Key Class 02h and KEY Format 000010b. The host and the logical unit calculate a Bus Key from the Drive Key and the Host Key independently and enters “Bus Key established” state.
6. “Bus Key established” state: The host performs one of the following operations with an associated command. The logical unit returns the requested value in a protected manner with using the Bus Key. For the first four and the last three operations, the logical unit *shall* invalidate the AGID for AACS being used for the process upon completing the command and *shall* return to the “Initial” state. For reading existing Binding Nonce, the Binding Nonce *shall* be always read from the disc. It is recommended to issue SYNCHRONIZE CACHE (10) command before reading the Binding Nonce. For generating a value of the Binding Nonce, the logical unit *shall* store the generated value of the Binding Nonce together with LBA Extent designated by the REPORT KEY command and with the AGID for AACS for later recording and enters the “Binding Nonce generated” state. The length of LBA Extent *shall* be no less than the value in the Block Count for Binding Nonce field of AACS Feature Descriptor, in the case of HD DVD this value is 4. If the length of LBA Extent designated by the REPORT KEY command is less than this value, the command *shall* be terminated with CHECK CONDITION status, 5/6F/06 INSUFFICIENT BLOCK COUNT FOR BINDING NONCE RECORDING and the logical unit *shall* return to

the “Initial” state. The logical unit may be capable of storing 4 sets of generated Binding Nonce value and its associated LBA Extent and AGID for AACS at a time. If the designated LBA Extent is overlapped with other LBA Extent being stored, the command *shall* be terminated with CHECK CONDITION status, 5/6F/07 CONFLICT IN BINDING NONCE RECORDING and the logical unit *shall* return to the “Initial” state.

- Reading the Volume ID using the READ DISC STRUCTURE command with Format Code 80h.
 - Reading the Pre-recorded Media Serial Number using the READ DISC STRUCTURE command with Format Code 81h.
 - Reading the Media ID using the READ DISC STRUCTURE command with Format Code 82h.
 - Reading existing value of the Binding Nonce by using the REPORT KEY command with Key Class 02h and KEY Format 100001b
 - Generating a value of the Binding Nonce to be recorded onto the disc by using the REPORT KEY command with Key Class 02h and KEY Format 100000b
 - Reading the Data Keys using the READ DISC STRUCTURE command with Format Code 84h.
 - Sending the Write Data Key using the SEND DISC STRUCTURE command with Format Code 84h.
 - Reading the first pack of Media Key Block of CPRM using the READ DISC STRUCTURE command with Format Code 86h.
7. “Binding Nonce generated” state: The generated Binding Nonce value is ready to be recorded onto the disc together with user data by using the WRITE (10), WRITE (12) or WRITE AND VERIFY (10) command until the Binding Nonce is invalidated by invalidating the AGID for AACS. The recording of stored Binding Nonce *shall* be made for a LBA that is included in the LBA Extent provided by the REPORT KEY command in such a way that the Binding Nonce *shall* be recorded in a number of logical blocks specified by the Block Count for Binding Nonce field of AACS Feature Descriptor, starting from the LBA provided by the REPORT KEY command. When the AGID for AACS is invalidated, the logical unit *shall* discard the generated Binding Nonce and *shall* return to the “Initial” state.



7.2 ACS Bus Encryption

ACS defines further protection of ACS-protected content called “Bus Encryption”, in which the content is further encrypted on-the-fly when it is transferred between the logical unit and the host. For the Bus Encryption, encryption keys called “Read Data Key” and “Write Data Key” are used for reading a sector and writing a sector, respectively. The Read Data Key is calculated from drive-oriented information called “Drive Seed” and the Volume ID if the disc is a pre-recorded disc or the Media ID if the disc is a writable disc. The Write Data Key is set to the same value with the Read Data Key by the logical unit after Power-on Reset, Hard Reset and when the disc is inserted. The host could change the Write Data Key to any value, however, for most applications, it is strongly recommended to use the same value with the Read Data Key in order to avoid file cache inconsistency.

- During the ACS Authentication process, if the logical unit is capable of Bus Encryption and if the logical unit finds from the Host Certificate Challenge that the host is not capable of Bus Encryption, the SEND KEY command with Key Class 02h and KEY Format 00001b *shall* be terminated with CHECK CONDITION status, 5/6F/00 COPY PROTECTION KEY EXCHANGE FAILURE - AUTHENTICATION FAILURE and the logical unit *shall* return to the “Initial” state.
- When reading ACS-protected content with Bus Encryption enabled, by a logical unit that is capable of Bus Encryption, the Read Data Key is calculated by the logical unit using the Drive Seed and the Volume ID if the disc is a pre-recorded disc or the Media ID if the disc is a writable disc and is used to encrypt the ACS-protected content whenever it is read by using READ (10) or READ (12) command. The ACS-protected content from specific sectors to which a flag is set in the sector header that denotes the sector is subject to the Bus Encryption are encrypted. The host needs the Read Data Key to decrypt the Bus Encryption to get the original ACS-protected content. The Read Data Key can be read by the host as encrypted by the Bus Key by using the READ DISC STRUCTURE command with Format Code = 84h after a successful ACS Authentication.
- When writing ACS-protected content with Bus Encryption enabled, to an ACS-capable disc by a logical unit that is capable of Bus Encryption, if the host wants to use the default Write Data Key (the same as the Read Data Key), the Write Data Key can be read by the host as encrypted by the Bus Key by using the READ DISC STRUCTURE command with Format Code = 84h after a successful ACS Authentication. If the host wants to set the Write Data Key to a value different from the Read Data Key, the Write Data Key is sent from the host to the logical unit as encrypted by the Bus Key by using the SEND DISC STRUCTURE command with Format Code = 84h after a successful ACS Authentication. For most applications, it is strongly recommended to use the same value with the Read Data Key as the Write Data Key in order to avoid file cache inconsistency. Note that not all the ACS compliant software application are authorized to send the Write Data Key to the logical unit. If the host is not authorized to send the Write Data Key but does send it, the SEND DISC STRUCTURE command *shall* be terminated with CHECK CONDITION status, 5/6F/08 INSUFFICIENT PERMISSION. The host also needs to specify LBA Extents by using the SEND DISC STRUCTURE command with Format Code = 85h, to which the ACS-protected content is recorded by using the WRITE (10), WRITE (12) or WRITE AND VERIFY (10) command, and the recording is associated with a flag in the sector header that denotes the sector is subject to the Bus Encryption when it is read. The ACS-protected content to be recorded to the LBA Extents is encrypted by the host by using the Write Data Key and that Bus Encryption need to be decrypted by the logical unit by using the Write Data Key before the content is recorded. The LBA Extents that the logical unit currently has can be read by using the READ DISC STRUCTURE command with Format Code = 85h. The LBA Extents that the logical unit currently has *shall* be discarded by another issuance of SEND DISC STRUCTURE command with Format Code = 85h, Hard Reset or medium eject.

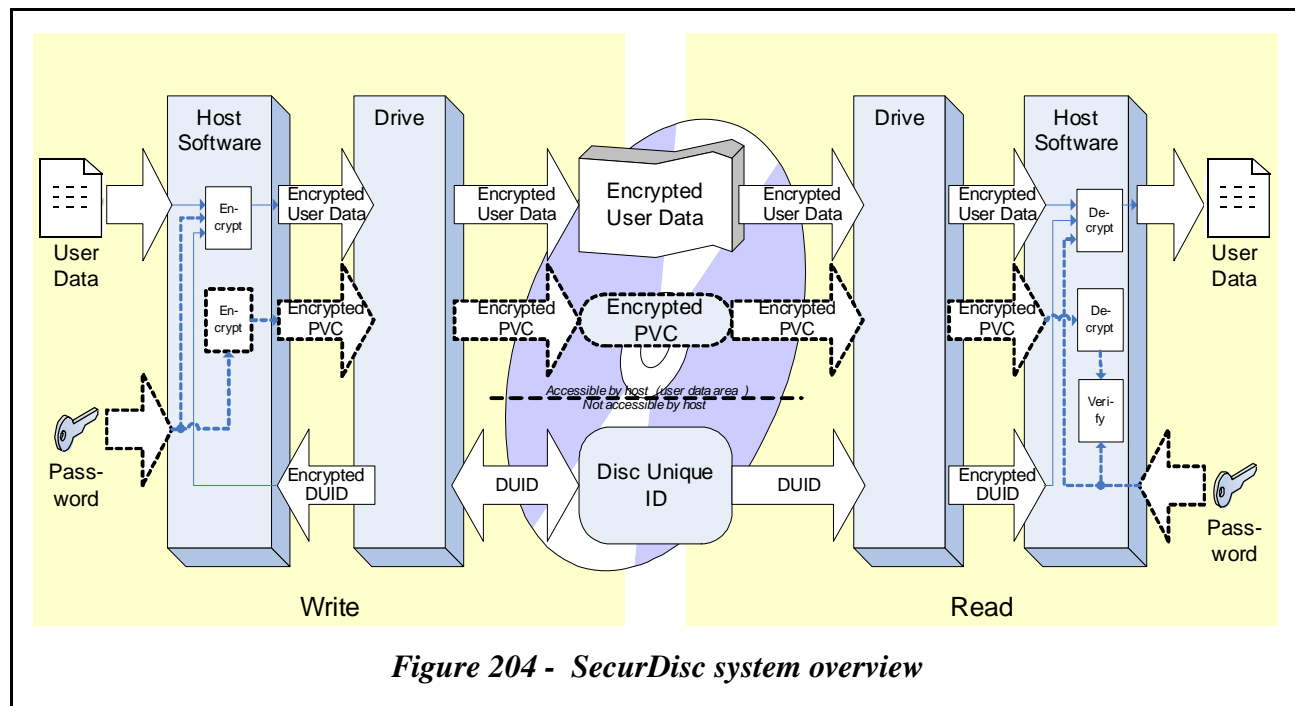
8.0 SecurDisc content protection

SecurDisc describes a system that allows to protect data from copying and accessing on recordable optical media by encrypting the user data with a key, the Disc Unique ID (DUID) which is accessible by the logical unit only and unique to each disc. The DUID bind the recorded encrypted user data to the physical media. Encrypting and decrypting is done by the host using the DUID which is retrieved from the logical unit. The host can only read the DUID from the logical unit after a successful authentication has been performed. In order to protect the privacy of the user data optionally the user data can be encrypted and decrypted by the host using a user entered password. Recording can be performed on standard optical media without any pre-recorded area and can be applied for general user data, not for audio visual content only.

8.1 System description

Writing and reading SecurDisc protected user data is performed using the methods described in the appropriated model sections of each optical media type. When writing SecurDisc encrypted user data each sector of the user data is encrypted by the host with a key created from the DUID, the logical sector number and optionally with a hash value created from a user entered password using AES-128¹ encryption. When reading SecurDisc encrypted user data each sector has to be decrypted with a key created from the DUID, the logical sector number and optionally with the hash value from the user requested password accordingly.

In order to verify the correctness of the password, an Encrypted Pass phrase Verification Checksum (EPVC) is written in the user data area of the disc.



The DUID is located outside the user data area of the disc and cannot be accessed by the host directly, only after a successful authentication has been performed (see 8.2, "SecurDisc Authentication process" on page 468). The exact location of the DUID is known to SecurDisc licensees only and depends on the used media type.

Logical unit and host each have a unique ID identifying a certain version and model of the logical unit and a certain version of the application. This unique ID can be used to revoke the logical unit by the application or the application by the logical unit.

1. AES with 128-bit cryptographic key

After a disc containing SecurDisc protected content is loaded, the SecurDisc Feature is current and the authentication has passed, the host can read the encrypted DUID from the loaded disc using the REPORT KEY command with Key Class = 21h and KEY Format = 000010b.

In case the loaded disc does not contain a DUID the DUID is created by the logical unit using a 128-bit random number when the host requests the DUID and written to the media when writing user data starts.

Once the Lead-in of a write once disc has been written without writing a DUID it is not possible to create and write a DUID when appending further sessions.

8.2 SecurDisc Authentication process

After the host has read the SecurDisc Feature Descriptor using the GET CONFIGURATION command with Feature Code 0113h, the host *shall* make sure that it is working with a licensed SecurDisc logical unit. Reading the SecurDisc Feature Descriptor is mandatory for logical unit-host authentication to work. During logical unit-host authentication, in addition to make sure that both the host application and the logical unit are licensed components, a bus key (KB) is established. This bus key is used later to exchange cryptographic data (DUID) for copy protection. The bus key is not cleared automatically until the host invalidate the AGID for SecurDisc. Logical unit-host authentication is mandatory before writing and reading any SecurDisc content.

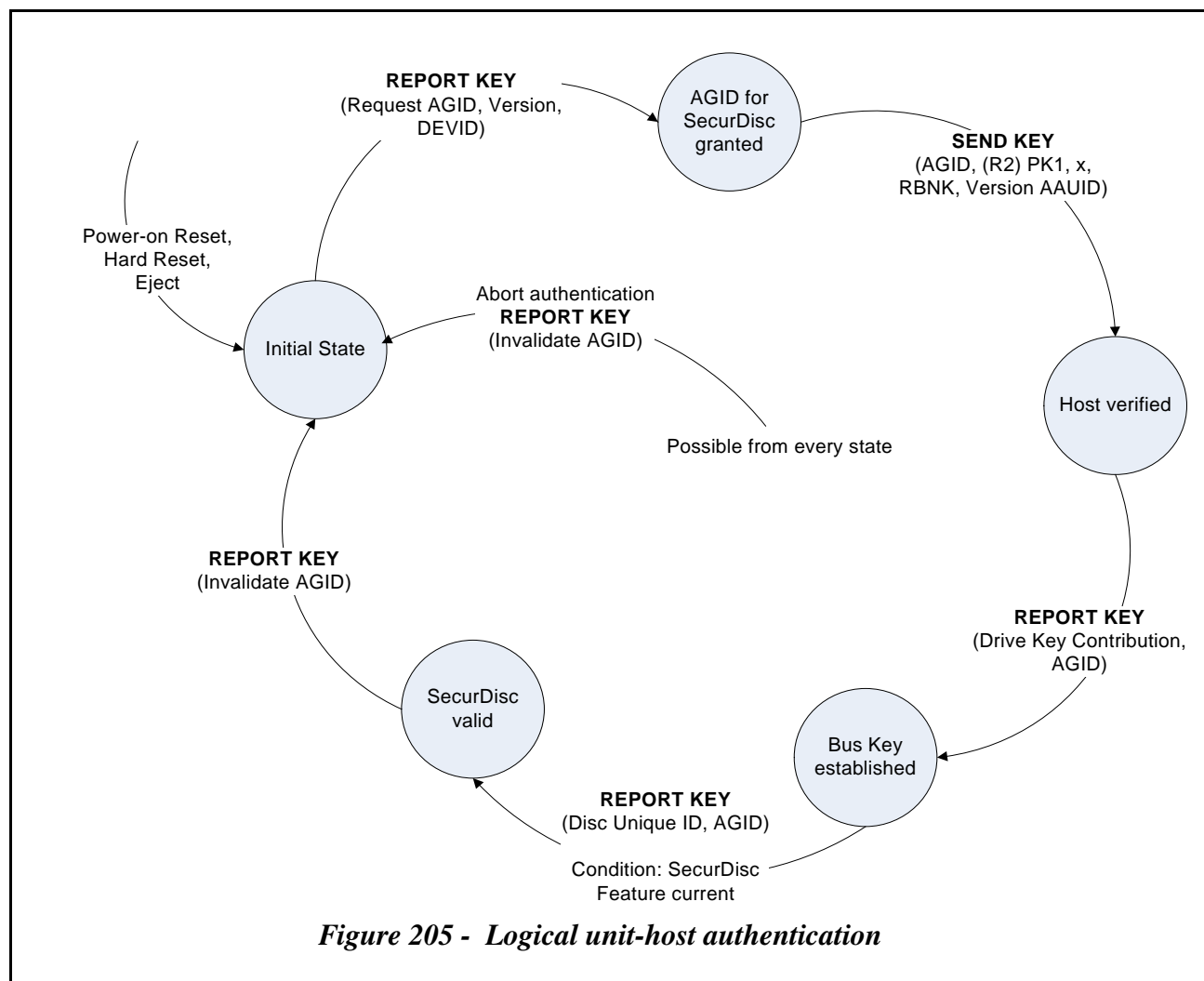


Figure 205 - Logical unit-host authentication

This is a step by step explanation of the logical unit-host authentication process:

1. During the authentication, both the logical unit and the host create a 128-bit random number (logical unit: R1, host: R2).
2. The host should request a 2-bit AGID from the logical unit. It is from here on passed to every REPORT KEY and SEND KEY command to allow the logical unit to distinguish up to four parallel authentication sequences. In addition to AGID and version number, the logical unit returns its Device Unique ID (DEVID). If the host chooses to abort authentication it must do so by issuing a REPORT KEY Invalidate AGID command.
3. The host should create a random number (R2) encrypt it and send it along with the protocol version, the bit position index value <x>, the Revocation Block Node Key (RBNK) and the own Application Authentication Unique ID (AAUID) to the logical unit where the logical unit verifies the legitimacy of the host.
4. The host should issue a REPORT KEY command, requesting Drive Key Contribution which includes the Application Authentication Revocation Block's Node key (AARBK) associated with bit position <x> which is also returned. <x> here relates to a different revocation block than <x> in 3.).
5. The logical unit calculates the bus key (KB).
6. From the data the host received from the logical unit with step 4 it calculates the bus key (KB).
7. If the media allows copy protection to be used (SecurDisc Feature is current), the host may issue a REPORT KEY Disc Unique ID command to receive the Disc Unique ID, encrypted with the bus key KB. It will decrypt and store the unique ID for use with encryption/decryption of file fragments. The REPORT KEY Disc Unique ID may only be issued as part of the logical unit-host authentication sequence if the Current bit of the SecurDisc Feature descriptor is set to one. Even if the Current bit is set to one, this REPORT KEY command may be omitted, in which case the logical unit will not generate or read a DUID.
8. The host must release the AGID acquired in step 2 by issuing a REPORT KEY INVALIDATE AGID as the last step of the authentication sequence. This can be performed at any state of the authentication process.

9.0 Real-Time Stream recording/playback model

Real-Time Stream recording/playback is one of the most important applications for recordable optical discs. It is also useful as a bridge between PC peripherals and consumer devices such as DVD players. However, optical disc drives, especially consumer players, have low access performance compared with hard disk drives from the viewpoint of data rate and seek delay. In addition, dispersion of recorded Streaming data on recordable optical discs may further degrade performance leading to the poor quality of data playback. In order to address the issue, Streaming data should be arranged continuously on a disc in order to guarantee the minimum bit rate for Real-Time Stream recording/playback.

Dispersion of Streaming data can be caused by disc defects. After a recordable optical disc has been handled outside a cartridge, for example in order to be inserted in a consumer players, more defects due to contamination may be encountered during subsequent Stream recording than would have been encountered if the disc had been kept in its cartridge. On the other hand, because of Real-Time requirement, a logical unit may not have as much time to handle defects encountered during Stream recording/playback as it has during conventional data recording/reading. The Real-Time Stream recording/playback model specifies new methods to handle defective sectors on a recordable optical disc.

9.1 Stream recording operation

A defect management scheme like Linear Replacement Algorithm is applied when a logical unit encounters defective blocks in a conventional WRITE operation. This is one of the solution to make the disc defect free, and it is applied to many optical discs. Figure 206 shows an example of data allocation when Linear Replacement is used.

But for Stream recording/playback operation, such a defect management may not meet the requirement of Real-Time performance. Because alternative good blocks are located physically remote from replaced defective ones, extra seek time is needed to access a spare good block during either reading or writing. If a defect management like Linear Replacement has to be applied to a Stream recording system, the system *shall* have a sufficiently large buffer memory to maintain the recording transfer rate. Otherwise, a recording operation may be interrupted, or playback picture may be jerky, if alternative good blocks in the Spare are have to be read. The problem is that a long distance seek operation is required to access the alternative block in the Spare Area.

To solve this problem, a logical unit commanded to write data using Stream recording *shall not* replace a defective block with another block even if the logical unit encounters a defective block during the Stream recording operation. In the case of DVD-VR¹ application, in recording real-time data, the Linear Replacement Algorithm *shall not* be applied regardless of software defect management or hardware defect management.

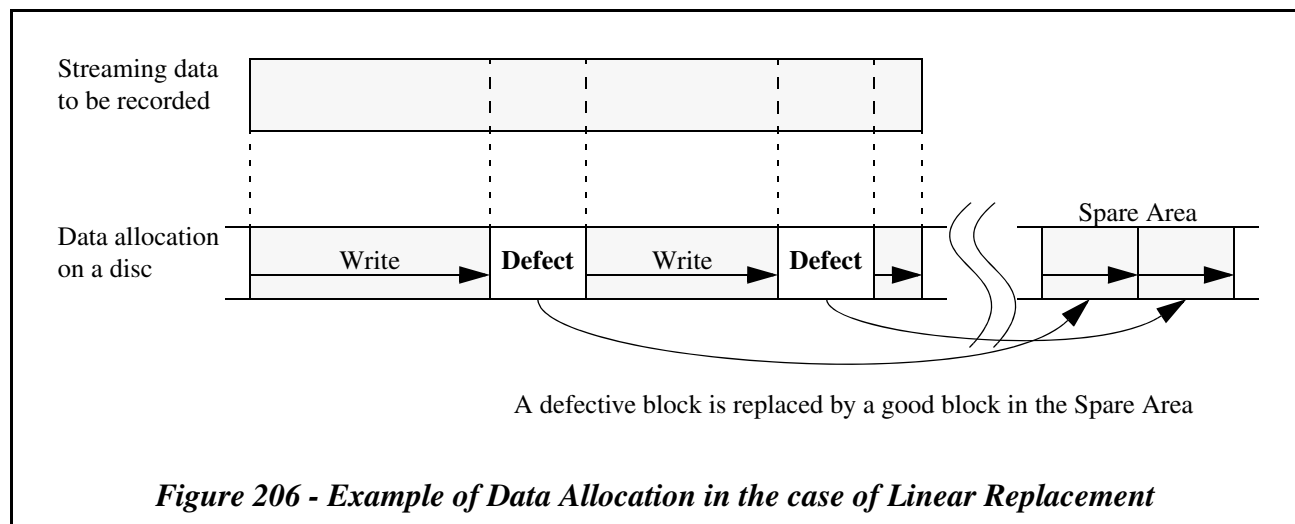


Figure 206 - Example of Data Allocation in the case of Linear Replacement

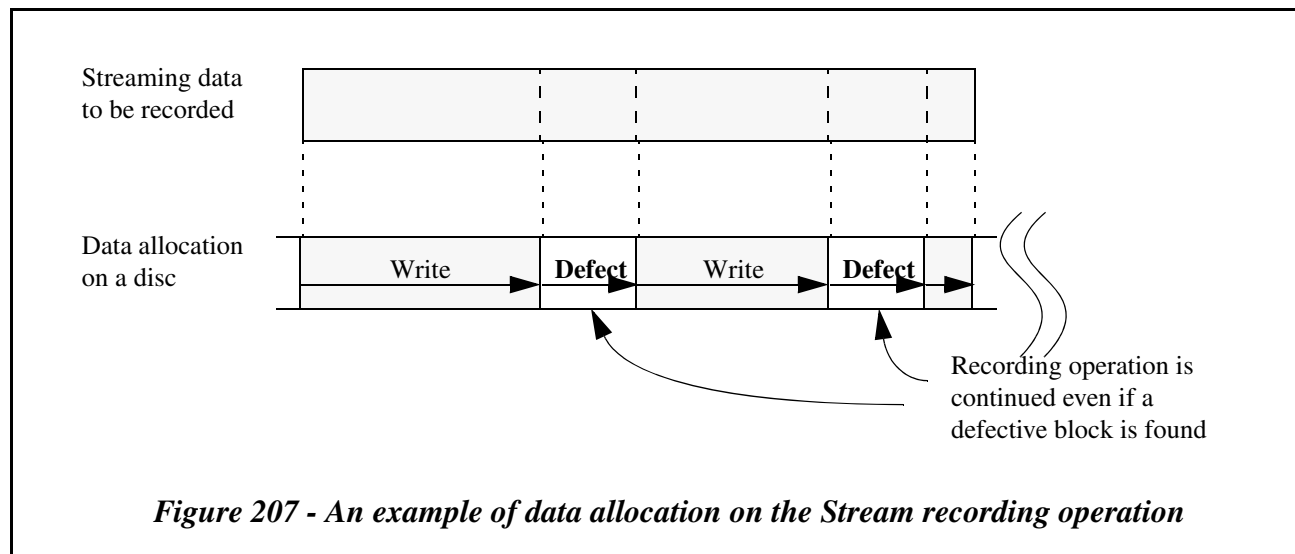
1. See 2.2.65 DVD Standard.

A logical unit that returns Real-Time Streaming Feature with **Version** field set to one and **SW** bit set to one *shall* support the following functions.

An example of data allocation on a disc is shown in Figure 207 when the Stream recording operation is performed. The logical unit *shall* continue recording without reporting an error, even if a defective block is encountered during a Stream recording operation. The Streaming data recorded to the defective block may not be read correctly.

The host *shall* use the WRITE (12) command, with the **Streaming** bit set to one, to perform the Stream recording operation. The logical unit *shall not* perform Linear Replacement operations for defective block. The logical unit's performance *shall* be at least 1× speed even if this may prevent the logical unit from retry or verify operations.

The logical unit *shall not* report CHECK CONDITION status, except for a fatal error, even if a defective block is encountered during a Stream recording operation. The logical unit *shall* return a fatal error when the Stream recording operation can not be continued because of critical errors such as a hardware error.



9.2 Stream playback operation

Using Real-Time Stream playback operation may result in erroneous data. If the data is not correctable, some error recovery operations will be performed by the logical unit as in a conventional READ operation. In the case of Stream playback operation, the highest priority should be given to continuity of data.

In order to distinguish between data attributes of Streaming data and normal data, **Streaming** bit is defined for the READ (12) command. If the logical unit receives the READ (12) command with **Streaming** bit set to one, the data should be read out continuously without reporting uncorrectable read errors, even if erroneous blocks or erroneous data are detected. When Enhanced Defect Reporting Feature (0029h) is current, reporting of recovered error is managed. See 9.3.3, "Fatal error recovery model with Group 3 timeout" on page 474.

The logical unit *shall* transfer the required size of data on the erroneous block without reporting errors, though the transferred data may contain errors. Read-Ahead operation should be applied on Stream playback operation in order to secure continuity.

Note: Cached data that contains an erroneous portion shall not be returned to the READ (12) command with the Streaming bit cleared. In such a case, cached data in a buffer memory will be thrown away, and an attempt should be made to read with the conventional READ operation.

9.3 Error handling during Stream recording/playback operation

9.3.1 Error handling with Hardware defect management

An erroneous block encountered on Stream recording/playback operation should be handled following Table 284. A defective block may be registered in the defect list, but the Linear Replacement algorithm **shall not** be applied in Stream recording/playback operation. In the case of DVD-RAM media, see 4.16, "Recording and reading for DVD-RAM media" on page 117.

Table 284 - Error handling on Stream recording/playback operation

Sector Status	Command	Description
Good block	Conventional READ	No Error
	Conventional WRITE	No Error
	READ (12) with Streaming bit is one	No Error
	WRITE (12) with Streaming bit is one	No Error
Defective block registered in defect list and replaced	Conventional READ	No Error
	Conventional WRITE	No Error
	READ (12) with Streaming bit is one	No Error (Defect list is ignored, Null (00h) data shall be returned for Blocks listed in a defect list ^a)
	WRITE (12) with Streaming bit is one	Ignore defect list and keep recording (The data written on the defective block is not guaranteed)
Defective block registered in defect list, but not replaced or Defective block with Recording Type bit set to 1	Conventional READ	No Error ^b (Null (00h) or partially corrected data may be returned) ^c
	Conventional WRITE	No Error (The defective block should be replaced and the data should be written to an alternative block)
	READ (12) with Streaming bit is one	No Error (Erroneous data may be returned)
	WRITE (12) with Streaming bit is one	No Error (The data should be written to the defective block without error reporting, and the defective block should still be registered in defect list) ^d
Defective block which is not registered in defect list	Conventional READ	Report Error ^e (Erroneous data shall not be returned in the case of TB = 0)
	Conventional WRITE	No Error (The defective block should be replaced and the data should be written to an alternative block)
	READ (12) with Streaming bit is one	No Error (Erroneous data may be returned)
	WRITE (12) with Streaming bit is one	No Error (The data should be written to the defective block without error reporting, and the defective block should be registered in defect list) ^d

a. Legacy logical unit that may not comply with this specification may return erroneous data and continue reading

b. In response to the VERIFY command, the logical unit **shall** report an error.

c. This is defined to be able to playback on a legacy system which uses the conventional READ command.

d. The defective block should be registered in defect list, but linear replacement **shall not** be applied.

e. Erroneous data may be returned according to the setting of TB bit in Read-Write Error Recovery mode page.

9.3.2 Error handling with Logical unit assisted software defect management

When Enhanced Defect Reporting Feature (0029h) is current, error reporting *shall* follow the setting of the PER bit and the EMCDR field in Read-Write Error Recovery mode page. When the logical unit transfers erroneous data to the host or when the logical unit writes data to defective blocks, and if error reporting is enabled by setting of the PER bit and/or the EMCDR field, the logical unit *shall* complete the READ (12) command with Streaming bit set to one/WRITE (12) command with Streaming bit set to one with CHECK CONDITION status, 1/18/05 RECOVERED DATA - RECOMMEND REASSIGNMENT at the command completion. See Section 10.0, "Logical unit assisted software defect management model" on page 477.

9.3.3 Fatal error recovery model with Group 3 timeout

Group 3 timeout and commands that are included in Group 3 timeout are used for fatal error recovery at real-time stream recording/playback.

When a fatal error occurs during real-time stream recording/playback operation, the host needs some recovery action to climb over or fix the fatal error. For example, in case of playback, an application user may want to see further story than the suspended scene. In case of recording, application user may want to use the disc for another recording. If the host did not perform any recovery action, the next recording may encounter the same fatal error again.

To recover from fatal error, there are two points to be taken care.

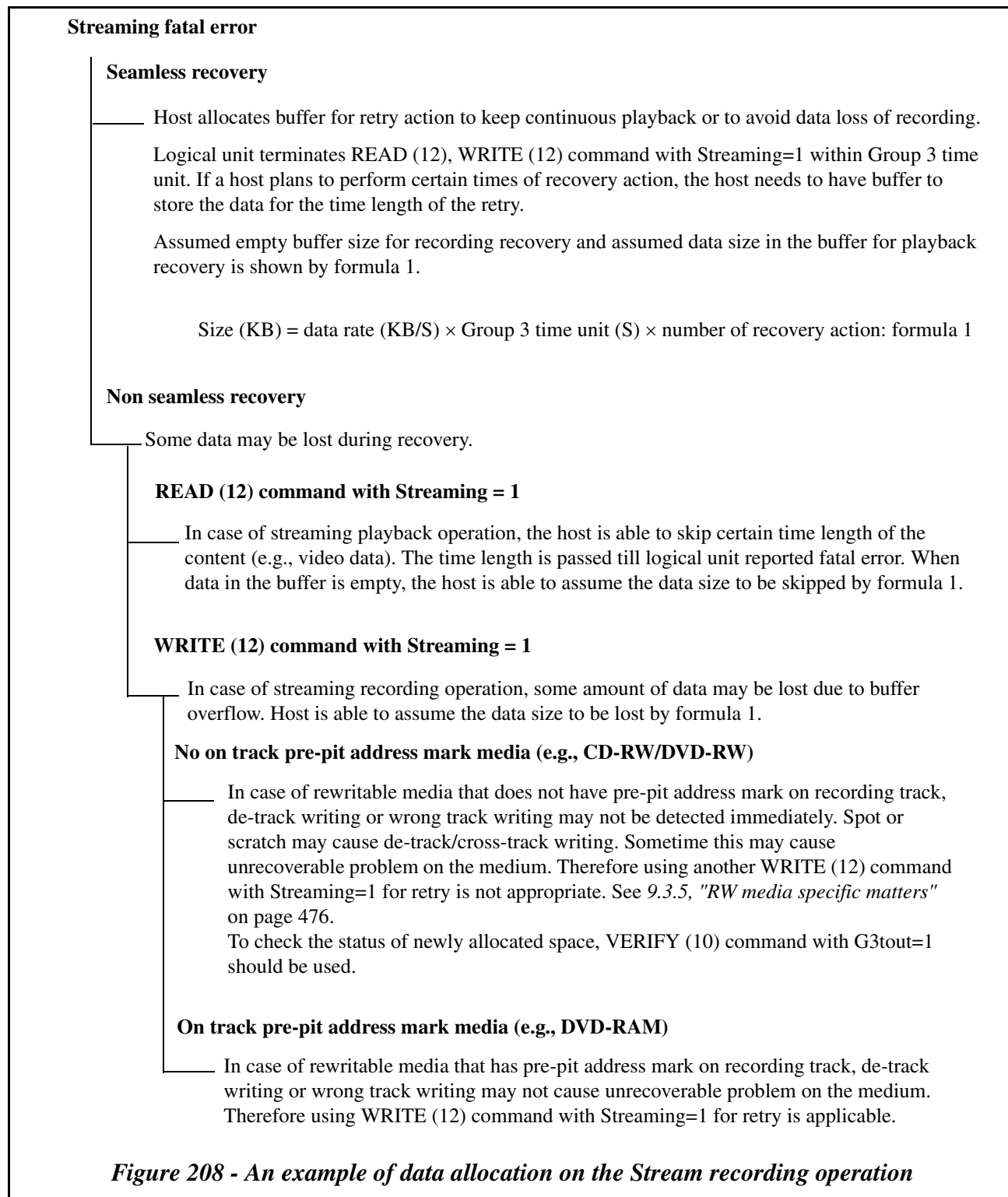
1. Reasonable response time
2. Defend from more damage

If recovery action takes very long time, in case of playback, application user may not wait such long time. In the worst case, user may be confused as system freeze. In case of recording, Streaming data may be lost. Hence the recovery action should be limited to be terminated within a reasonable time length.

A fatal error of Real-Time Stream recording/playback is usually the physical problem of the logical unit (e.g., to hinder the logical unit from positioning the optical pickup to the target track, focusing the laser beam to the disc surface or finding the target sector). Unnecessary overdoing of retry action may cause more physical damage of the logical unit or the medium. Then host needs to select appropriate method and retry times. The logical unit should not perform too much retry action internally.

9.3.4 Recovery from fatal error of streaming

Figure 208 shows a sample recovery sequence from fatal error of real-time stream recording/playback that uses Group 3 timeout.

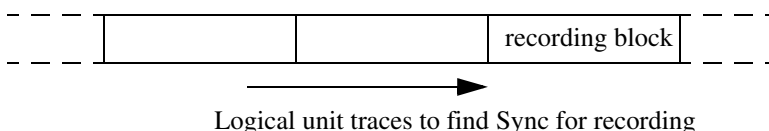


9.3.5 RW media specific matters

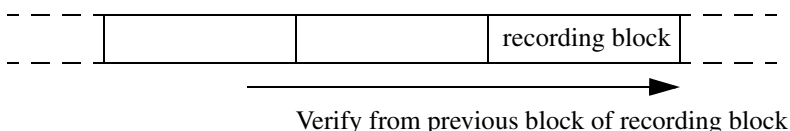
Figure 209 shows that RW media (e.g., CD-RW/DVD-RW) specific matters that requires attention. Improper recovery by the host may cause unexpected result. When a logical unit encounters a fatal error during WRITE (12) command with Streaming bit=1, host may try to write the streaming data to other location. To check the status of newly allocated space, WRITE (12) command with Streaming bit=1 and READ (12) command with Streaming bit=1 are not appropriate commands. For this purpose, VERIFY (10) command with G3tout bit = 1 should be used. If the G3tout bit of VERIFY (10) command is set to 1, the logical unit *shall* certify the specified area within Group 3 timeout duration. If the VERIFY (10) command is terminated with GOOD status, the area should be good for streaming data writing.

1. Checking the status of newly allocated space

To determine the start position of a recording block on CD-RW/DVD-RW media, CD-RW/DVD-RW logical unit uses signal that is ATIP Sync of wobble or Land pre-pit Sync in previous block of the recording block. Even if recording block does not have any problem, if previous block has problem and logical unit loses Sync signal, the logical unit may not be able to start recording correctly.



To check the status, certification from previous block of recording block is proper measures.



2. De-track/Cross-track problem

CD-RW/DVD-RW media uses Land as guard band and Groove as recording track. The write capable logical unit uses Groove signal for tracking servo. DVD read-only logical unit uses recorded mark signal for tracking servo. If recorded mark is created on Land, DVD read-only logical unit may not be able to follow correct track and may encounter read failure. The write capable logical unit is not able to erase the recorded mark on Land area. So this problem is unrecoverable.

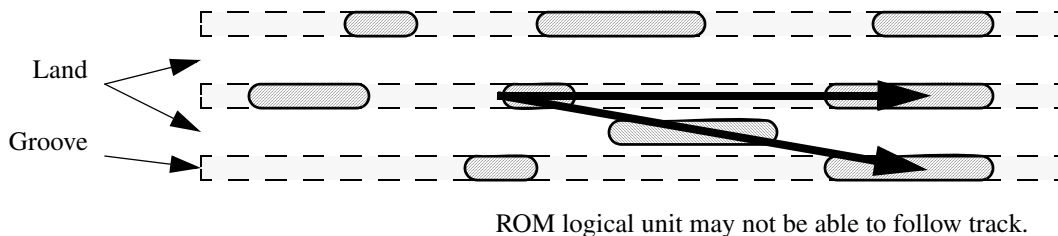


Figure 209 - An example of RW media characteristics

10.0 Logical unit assisted software defect management model

There are two types of defect management. The one is host-based defect management (software defect management) and the other is logical unit-based defect management (hardware defect management).

In the case of software defect management, a host retrieves defect information from the logical unit and performs defect management at host's desired timing. For example, the software defect management is being utilized for CD-RW media. In the case of hardware defect management, defect management is automatically performed by the logical unit itself like a DVD-RAM logical unit.

Though the capacity of media is dramatically increased in comparison to CD media, the life of RW media is relatively short. The number of acceptable overwrite cycles on a sector is usually one thousand or several thousand. Therefore some sectors of the Data Area may be worn-out by repeated writing over the life span of the media.

This section defines the Logical unit assisted software defect management method for any type of rewritable media (e.g., CD-RW, DVD-RW) with logical unit that supports Enhanced Defect Reporting Feature. The goal of this model is to provide a defect management mechanism to increase data reliability and media interchangeability after writing the data on a medium by the host and the logical unit. In addition, this model provides a sophisticated real-time defect management with collaboration between the host and the logical unit.

10.1 Basic actions for defect management

The Logical unit assisted software defect management consists of the following basic three actions:

1. Certification
Certify blocks on a medium
2. Detection
Detect the use of defective block
3. Management
Manage data on a defective block or manage data to be written on a defective block.
Usually, data on a defective block or data to be written on a defective block is relocated to healthy block.

10.2 Defect management modes

The Logical unit assisted software defect management model defines two defect management modes. The one is Persistent defect management (Persistent-DM) mode and the other is Distributed real-time defect management (DRT-DM) mode.

10.2.1 Persistent defect management (Persistent-DM) mode

In the Persistent-DM mode, the "Certification" and the "Detection" actions are taken by verify after write operation of a host. Then "Management" action is taken by the host.

A host *shall* verify any written data by enabling Certification and by using one of the following commands.

- READ (10), READ (12) with Streaming bit = 0, VERIFY (10), or WRITE AND VERIFY (10) commands.

The logical unit *shall* perform media certification when one of the above commands is issued to the logical unit. The certification result is stored in Defective Block Information (DBI) memory of the logical unit. In the case of Simple DBI memory model (see Section 10.3.4.1), the DBI data is cleared and updated by the above commands. The logical unit may not perform medium certification in response to READ (12) command with Streaming bit = 1.

By using DBI memory, multiple blocks are able to be certified by logical unit at one command.

10.2.2 Distributed real-time defect management (DRT-DM) mode

In addition to the functionality of the Persistent-DM mode, the DRT-DM mode provides functionality that is suitable for real-time streaming applications.

In recording real-time streaming data, recording applications usually suspend or delay the replacement of a defective block to avoid interruption of the real-time recording. In the DRT-DM mode, “Certification” action is taken during a read operation by the host. “Detection” action is taken during a write operation by the host. The host may take “Management” action after the recording operation is complete. Therefore, the DRT-DM mode is able to minimize the performance impact on the real-time operation.

The DRT-DM mode provides for certification before writing. A logical unit performs media certification in response to READ (10), READ (12), or VERIFY (10) command and the logical unit stores the certification result in DBI memory of the logical unit. During writing of a Packet, the logical unit may report a RECOVERED ERROR on WRITE (10) or WRITE (12) command by checking the DBI data that is stored during the certification. To keep compatibility with Persistent-DM mode (verify after write), the logical unit *shall* certify the block after the writing of the block and then should check the DBI memory in response to READ (10), READ (12), VERIFY (10) or WRITE AND VERIFY (10) command.

DBI data *shall* be cached in DBI memory. Once a block has been certified at a certain defect level, that block *shall not* be assigned a lower defect level in DBI memory upon subsequent certification. This ensures that the worst case certification is made available to the host. Regarding the defect level, see Section 10.3.2.

The host may retrieve the stored DBI data at a later time. To keep compatibility with read-only applications that access the disc directly, the host may suspend RECOVERED ERROR reporting on READ (10) or READ (12) command and the host may use RECOVERED ERROR reporting on WRITE (10) or WRITE (12) command instead.

The DRT-DM mode makes use of two types of DBI memory model. One is large DBI buffer model. Another is small DBI cache memory model. See *Section 10.3.4, "DBI memory management"* on page 482.

For the DRT-DM mode, logical unit and media *shall* follow the Defect Level Transition model described in Section 10.6.1. When a fatal error occurs during normal overwriting, a Type 1 or Type 2 defect level *shall* have been detected by the logical unit before the fatal error happens.

10.3 Enhanced defect reporting

Enhanced defect reporting provides media interchangeability by defect management and improves defect management performance by using DBI memory and provides host/application with appropriate logical unit behavior by DBI memory and various defect reporting control.

10.3.1 Standard playback model for DVD-RW media

To specify the interchangeable defect level between a write capable logical unit and DVD read-only logical unit, a standard playback model and defect level criteria are defined.

For DVD-RW media, ordinary Consumer Electronics DVD players that support playback of DVD-RW media are defined as standard player for the standard playback model. Error correction order of the standard player is assumed as:

1. PI error correction
2. PO erasure error correction
3. EDC error detection.

No additional error correction is performed by the standard player.

Note: Standard playback model for other media is not yet defined.

10.3.2 Four types of defect level

The Logical unit assisted software defect management model defines four types of defect level to handle appropriate operation according to each type of defect. The defect level increases from Type 1 to Type 4. Type 4 is the highest severity level.

- Type 1: Recovered light defect level
 The conceptual criterion is that after 50 - 100 overwrite cycles, the Packet may cause uncorrectable error on standard playback model and the number of retry seek operations is small. For DVD-RW media, the recommended error

threshold is that the number of PI uncorrectable line is 8 through 15. The number of seek retry times should be smaller than the number of seek retry times for Type 2 defect level. A Packet at or below this defect level should be good for data recording/playback with Consumer Electronics products.

- Type 2: Recovered heavy defect level
The conceptual criterion is that several seek retries are required to read the Packet correctly and reading of the Packet may become a fatal error on standard playback model. And after 50 - 100 overwrite cycles, reading of the Packet may become a fatal error even with the best error correction of the logical unit. For DVD-RW media, the recommended error threshold is that the number of PI uncorrectable line is 16 or higher. To read a Packet correctly many seek retry operations may be required. A Packet that has this defect level may not be good for data recording/playback with Consumer Electronics products.
- Type 3: Unrecovered read error defect level
An unrecovered read error happens or has happened.
- Type 4: Write error defect level
Write error has occurred. When RECOVERED ERROR is reported by WRITE (12) command with Streaming bit = 1, some of the specified sectors are not written correctly.

10.3.3 Error reporting control

Reporting of a RECOVERED ERROR is controlled by the PER bit in Read-Write Error Recovery mode page. A RECOVERED ERROR only reports the LBA in the Packet that cause the last recovered error during the data transfer in the INFORMATION field of the REQUEST SENSE data. The Logical unit assisted software defect management that uses DBI memory in the logical unit provides multiple Packet defect reporting capability to increase system performance.

A logical unit *shall* report a RECOVERED ERROR when

- a Type 1 or Type 2 defect is detected on the medium,
- and Enhanced Defect Reporting Feature is current,
- and RECOVERED ERROR reporting is enabled.

The Enhanced defect reporting capable logical unit uses only one error code for RECOVERED ERROR although there are various other ASC/ASCQs defined for RECOVERED ERRORs. Only the error code of 1/18/05 RECOVERED DATA - RECOMMEND REASSIGNMENT *shall* be reported when a Type 1 or Type 2 defect level is detected during media certification. When a some write operations are failed during streaming write operation by WRITE (12) command with Streaming bit = 1, the logical unit *shall* report 1/18/05 RECOVERED DATA - RECOMMEND REASSIGNMENT and *shall* store Type 4 defect level in the DBI memory.

In the case of DRT-DM mode,

- If a Type 1, Type 2, or Type 3 defect is found in DBI memory upon receiving a WRITE (10), WRITE (12), or WRITE AND VERIFY (10) command and if no write error happens, 1/18/05 RECOVERED DATA - RECOMMEND REASSIGNMENT *shall* be reported. The data sent by WRITE (10) or WRITE (12) command *shall* be written to the medium.
- If a Type 1, Type 2, or Type 3 defect is found in DBI memory upon receiving a WRITE (10), WRITE (12), or WRITE AND VERIFY (10) command and if write error happens, a deferred write error *shall* be reported. In this case RECOVERED ERROR is not returned to the host.
- If a Type 1, Type 2, or Type 3 defect is found in DBI memory upon receiving a VERIFY (10) command, 1/18/05 RECOVERED DATA - RECOMMEND REASSIGNMENT *shall* be reported.

Error codes to be reported and DBI update states in each case are defined in Table 285, Table 286, Table 287, Table 288, Table 289, and Table 290.

Note: The ASC/ASCQs for fatal errors are not specified in this model section.

Table 285 - Returned error code for commands under the Persistent-DM mode

Returned error code ^a					
READ			VERIFY / WRITE AND VERIFY		
no error ^b	Type 1/2	fatal error ^c	no error	Type 1/2	fatal error
Good	1/18/05	fatal	Good	1/18/05	fatal

- a. the case when RECOVERED ERROR reporting is allowed on the command. Returned error code is not affected by DBI data in DBI memory
- b. means that the defect level is lower than Type 1 defect level
- c. fatal error happens on this command, does not include a deferred error for previous command

Table 286 - Returned error code for READ and VERIFY commands under the DRT-DM mode

Defect Status in DBI memory	Returned error code ^a					
	READ			VERIFY		
	no error ^b	Type 1/2	fatal error ^c	no error	Type 1/2	fatal error
no defect	Good	1/18/05	fatal	Good	1/18/05	fatal
Type 1/2	Good	1/18/05	fatal	Good	1/18/05	fatal
Type 3	Good	1/18/05	fatal	Good	1/18/05	fatal
Type 4	Good	1/18/05	fatal	Good	1/18/05	fatal

- a. the case when RECOVERED ERROR reporting is allowed on the command
- b. means that the defect level is lower than Type 1 defect level
- c. fatal error happens on this command, does not include a deferred error for previous command

Table 287 - Returned error code for commands under the DRT-DM mode

Defect Status in DBI memory	Returned error code ^a					
	WRITE command			WRITE AND VERIFY command		
	no error ^b	fatal error ^c	fatal error on Streaming bit = 1 ^d	no error	Type 1/2	fatal error
no defect	Good	fatal	1/18/05	Good	1/18/05	fatal
Type 1/2	1/18/05	fatal	1/18/05	1/18/05	1/18/05	fatal
Type 3	1/18/05	fatal	1/18/05	1/18/05	1/18/05	fatal
Type 4	1/18/05	fatal	1/18/05	1/18/05	1/18/05	fatal

- a. the case when RECOVERED ERROR reporting is allowed on the command
- b. means that the defect level is lower than Type 1 defect level
- c. fatal error happens on this command, does not include a deferred error for previous command.
- d. This is the case when Streaming bit is set to one, and a block is not correctly written. This block is treated as Type 4 defect.

Table 288 - Returned Deferred error code

Defect Status in DBI memory	Returned deferred error code for previous Write command	
	Write command Streaming bit = 0	Write command Streaming bit = 1
no defect	fatal (not specified)	1/18/05
Type 1/2	fatal (not specified)	1/18/05
Type 3	fatal (not specified)	1/18/05
Type 4	fatal (not specified)	1/18/05

Table 289 - DBI update for READ and VERIFY command^a

Status in DBI memory	Update state of DBI data							
	READ				VERIFY			
	no error	Type 1	Type 2	Type 3	no error	Type 1	Type 2	Type 3
no defect	no defect	Type 1	Type 2	Type 3	no defect	Type 1	Type 2	Type 3
Type 1	Type 1	Type 1	Type 2	Type 3	Type 1	Type 1	Type 2	Type 3
Type 2	Type 2	Type 2	Type 2	Type 3	Type 2	Type 2	Type 2	Type 3
Type 3	Type 3	Type 3	Type 3	Type 3	Type 3	Type 3	Type 3	Type 3
Type 4	Type 4	Type 4	Type 4	Type 4	Type 4	Type 4	Type 4	Type 4

a. Only applicable for small DBI cache memory model and large DBI buffer memory model

Table 290 - DBI update for WRITE and WRITE AND VERIFY command^a

Status in DBI memory	Update state of DBI data						
	WRITE		WRITE AND VERIFY				
	no error	Type 4	no error	Type 1	Type 2	Type 3	Type 4
no defect	no defect	Type 4	no defect	Type 1	Type 2	Type 3	Type 4
Type 1	Type 1	Type 4	Type 1	Type 1	Type 2	Type 3	Type 4
Type 2	Type 2	Type 4	Type 2	Type 2	Type 2	Type 3	Type 4
Type 3	Type 3	Type 4	Type 3	Type 3	Type 3	Type 3	Type 4
Type 4	Type 4	Type 4	Type 4	Type 4	Type 4	Type 4	Type 4

a. Only applicable for small DBI cache memory model and large DBI buffer memory model

If the logical unit finds defective blocks during the verify operation of VERIFY (10) or WRITE AND VERIFY (10) command, the command *shall* be terminated with CHECK CONDITION status when all blocks specified by the command are certified or when DBI memory overflow occurs. If DBI memory overflow occurs, the DBI Full (DBIF) bit of DBI descriptor in GET PERFORMANCE command for the Packet that caused DBI buffer full *shall* be set to 1.

In the case of DRT-DM mode, fatal errors are registered in the DBI memory during the certification process. When the logical unit receives a WRITE command to be written to the fatal error Packet, the logical unit *shall* terminate the WRITE command with CHECK CONDITION status, 1/18/05 RECOVERED DATA - RECOMMEND REASSIGNMENT after completion of data transfer. The transferred data *shall* be written on the media normally.

When an error of 1/18/05 RECOVERED DATA - RECOMMEND REASSIGNMENT is reported the host should check the DBI data.

To keep compatibility with read-only applications (e.g., DVD-Video playback software), reporting of a RECOVERED ERROR on READ (10) or READ (12) command may be suspended by the EMCDR field setting in Read-Write Error Recovery mode page. DBI memory allows for polling of defective Packet information without using RECOVERED ERROR reporting. The EMCDR field controls media certification and error reporting on particular commands as shown in Table 292 - *Definition of PER bit and EMCDR field of Persistent-DM mode* on page 485 and Table 293 - *Definition of PER bit and EMCDR field of DRT-DM mode* on page 489.

When a medium is certified, the rotation speed of the logical unit may need to be adjusted to appropriate certification speed¹. If the certification speed is slower than the maximum reading speed of the logical unit, the host may disable media certification by setting the PER bit and the EMCDR field to 0 to use highest speed of the logical unit for reading operation.

At Power-on reset and hard reset, if the logical unit does not support saving of Read-Write Error Recovery mode page, the PER bit and the EMCDR field *shall* be set to 0.

The default values of the PER bit and the EMCDR field are 0.

10.3.4 DBI memory management

To avoid or minimize DBI data overflow with a small amount of logical unit's hardware resources, there are different memory models defined to store DBI data in a logical unit. They are simple DBI memory model, large DBI buffer memory model and small DBI cache memory model.

The DBI data may be cleared when the logical unit is reset by Hard reset.

The DBI data *shall* be cleared when the medium is ejected or logical unit is reset by Power on reset.

The DBI data *shall not* be cleared even if the PER bit and the EMCDR field are both set to 0.

10.3.4.1 Simple DBI memory model

The simple DBI memory model is permitted only for the Persistent-DM mode. All stored data in DBI memory is updated at the beginning of medium certification. To ensure that a simple DBI implementation gives a minimum level of usefulness and efficiency to the host, the DBI memory *shall* be capable of storing at least 10 DBI entries. This allows for the DBI entries to cover a minimum of 256 + 64 KB of defective data (in the case of DVD media) before overflow would occur. This implies that if this minimum is used, the host should not issue a READ, WRITE, or VERIFY command for more than 256 + 64 KB at a time, otherwise the command could overflow the DBI memory. The value of 10 DBI entries assumes half of Track Buffer size and information of VR playback model. The Number of entries field in Enhanced Defect Reporting Feature Descriptor indicates the number of entries that may be stored in DBI memory.

10.3.4.2 Large DBI buffer memory model

Some logical units (e.g., logical unit that supports hardware defect management) have enough memory to cover the whole medium for defect management purpose. In this case, the logical unit's memory may cover DBI data for all Packets on CD/DVD media. For the ideal case, logical unit may store DBI data into a DBI bitmap that may cover entire disc. For the practical case, the logical unit's memory may store 10% of the different Packet start addresses of the entire disc and length of consecutive defective Packets. Usually spare area size is less than 5% of the entire disc capacity. To cover the spare area, 10% of the entire disc capacity would be enough size for Large DBI buffer memory model.

10.3.4.3 Small DBI cache memory model

The logical unit may have small memory to store DBI data. To minimize the possibility of DBI data overflow and to allow effective host operation, small DBI cache memory model is defined. The DBI data remains in DBI cache even if the data is read by a host. To ensure that a small DBI implementation gives a minimum level of usefulness and efficiency to the host, the DBI cache *shall* be capable of storing at least 10 DBI entries.

1. The certification speed may be similar to the maximum writing speed and is usually slower than the maximum reading speed of the logical unit.

10.3.4.3.1 Three types of memory blocks in DBI memory

In the small DBI cache memory model, the DBI memory is divided into three memory blocks to minimize the possibility of DBI data overflow. Each memory block is referred to as Buffer DBI (BDBI), Read DBI (RDBI) cache, and Write DBI (WDBI) cache, respectively.

- Buffer DBI (BDBI) block: to store certification information of sectors in data buffer
- Read DBI (RDBI) cache memory block: to copy data from BDBI by a READ command
- Write DBI (WDBI) cache memory block: to copy data from RDBI by a WRITE command, copy data from BDBI by a VERIFY command

The certification result of READ (10) or READ (12) command is stored in RDBI cache. The certification result of VERIFY (10) command and WRITE AND VERIFY (10) command is stored in WDBI cache. A logical unit *shall* check RDBI cache by WRITE (10) or WRITE (12) command. If a defective Packet is found in RDBI cache, the DBI data in RDBI cache is copied to WDBI cache.

Note: In the case of large DBI buffer memory model, the DBI data is stored into a DBI buffer directly, then these three types of memory blocks are unified into single DBI buffer.

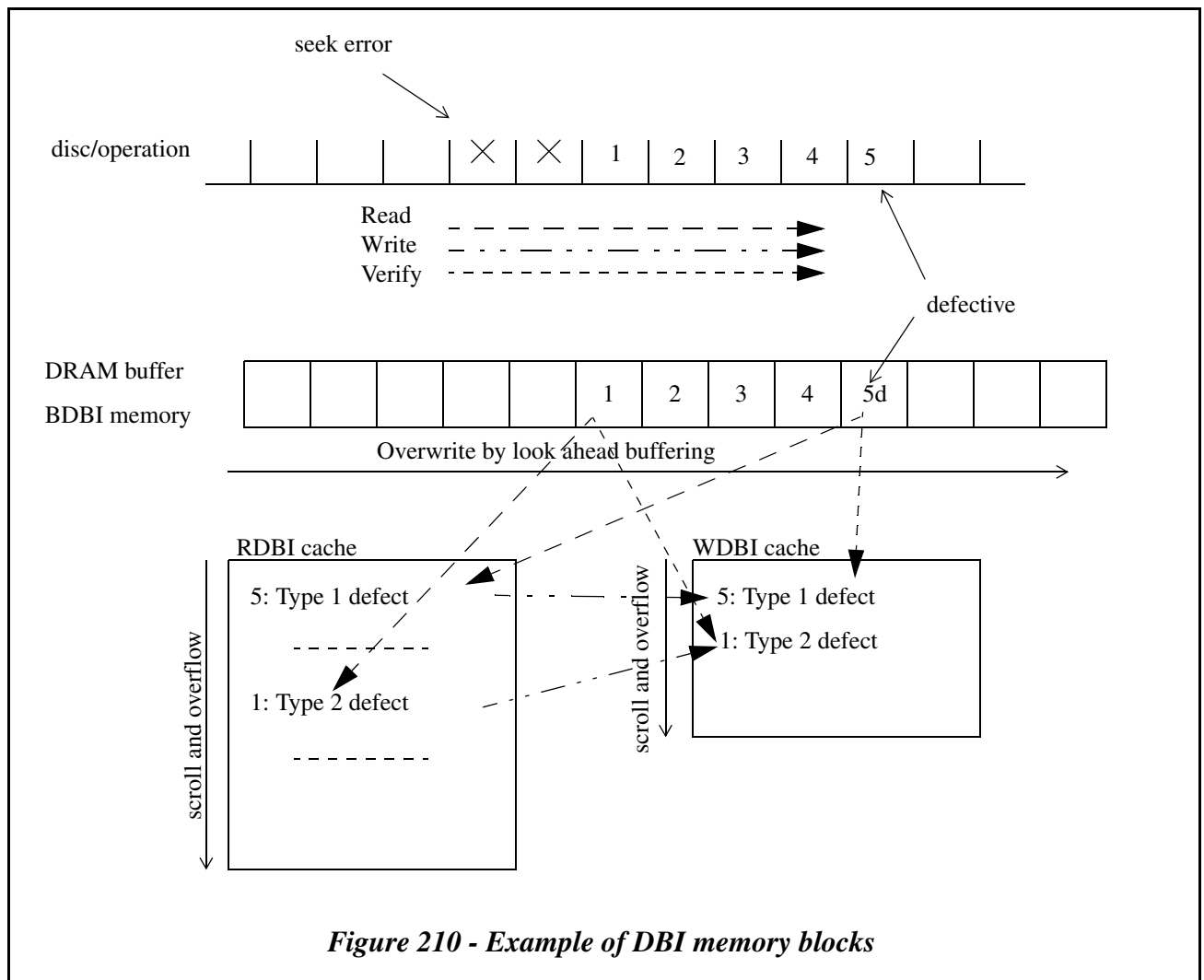


Figure 210 - Example of DBI memory blocks

10.3.4.3.2 Adjust DBI cache for a real-time application

The data in RDBI and WDBI cache memories may easily overflow due to accessing of multiple/large files. To protect DBI data against overflow, disc volume space may be divided into a few zones named DBI cache zone. The RDBI and WDBI caches are allocated for each DBI cache zones. For example, in the case of UDF file system version 2.00 and DVD-VR application, at least two DBI cache zones are required to be supported. Table 291 shows an example of the DBI cache zone image.

Table 291 - Example of DBI cache zone image

DBI cache Zone	Major contents	Remark	Sparing
0 ^a	VRS	from 10h	not covered by sparing of UDF very important many overwritten file system data
	AVDP	100h	
	main Volume Descriptor Sequence	by AVDP	
	reserve Volume Descriptor Sequence	by AVDP	
	Logical Volume Integrity Descriptor	by VDS	
	primary Sparing Table	by VDS	
	Spare Area	by VDS	
	secondary Sparing Table	by VDS	
	Beginning of Spareable Partition	by VDS	subject of sparing
	Free Space Bitmap	by VDS	
	root File Entry for root directory	by VDS	
	File Entry for DVD_RTAV	by root File Entry	
	VR_MANAGR.IFO	by VR File Entry	
	VR_MANAGR.BUP	by VR File Entry	
1 ^b	VR_MOVIE.VRO	by VR File Entry	subject of sparing but not suitable to spare
	VR_AUDIO.VRO	by VR File Entry	
	VR_STILL.VRO	by VR File Entry	

- a. 1st DBI cache zone: from LBA 0 to before VR object files. There are very important UDF descriptors and information that are not covered by Sparing of UDF. And there are important contents that are able to be replaced to Spare Area.
- b. 2nd DBI cache zone: from beginning of VR object files to the end of disc volume space. There are real-time contents that should not be replaced to the Spare Area.

10.4 Implicit synchronize cache

When a medium certification is enabled and READ or VERIFY command is issued, and if the data to be read by the command is still remaining in the write cache of the logical unit, the unwritten data *shall* be committed to a physical medium prior to the certification and then logical unit *shall* read from the medium and certify the data to perform medium certification correctly.

However, if there were an error during READ or VERIFY commands, there may be no way to know if such error occurred during writing the buffered data or an error occurred during the READ or VERIFY operation itself. In order for the host to distinguish such errors, the host should issue SYNCHRONIZE CACHE (10) command to ensure the buffered data be committed to a physical medium.

10.5 Persistent-DM mode behavior

In the Persistent-DM mode, the host *shall* check the defect level of the Packets after write. The logical unit stores the certification result corresponding to each READ (10)/READ (12) command with Streaming bit = 0/VERIFY (10)/

WRITE AND VERIFY (10) command in the DBI memory. One of three DBI memory models is used. As for DBI memory model, see 10.3.4, "DBI memory management" on page 482.

The host *shall* enable media certification by setting of PER bit or EMCDR field.

In Persistent-DM mode, media certification by READ (12) command with Streaming bit =1 is not required. Some logical units cannot guarantee real-time streaming playback on 1× CLV speed in PC environment. When READ (12) command with Streaming bit =1 is issued, the rotation speed is usually higher than the speed for certification. Thus, the certification may not be able to be performed. The Type 1 defect level is detected by using READ (10), READ (12) with Streaming bit = 0, or VERIFY (10) command. The Type 1 defect level means the Packet readability is good enough for real-time playback (i.e. READ (12) with Streaming bit = 1 should not have trouble on reading the Packet).

A host *shall* check the defect level of the Packet using READ (12) command with Streaming bit = 0 to keep the disc compatible with standard playback model.

10.5.1 RECOVERED ERROR reporting control for Persistent-DM mode

When the PER bit is set to one and/or EMCDR field is set to one or higher, the logical unit perform certification and report RECOVERED ERROR on READ (10)/READ (12) with Streaming bit =0, VERIFY (10), or WRITE AND VERIFY (10) command.

If PER bit is set to zero, the EMCDR field controls the RECOVERED ERROR for defect management as defined in Table 292. In this case, the returned error code *shall* be 1/18/05 RECOVERED DATA - RECOMMEND REASSIGNMENT.

If the PER bit is set to one, various kinds of RECOVERED ERROR will be returned for any type of command. And if the EMCDR field is set to zero, the reported RECOVERED ERROR for defect management is vendor specific. If the EMCDR field is set to a value other than zero, the reported RECOVERED ERROR for defect management *shall* be 1/18/05 RECOVERED DATA - RECOMMEND REASSIGNMENT.

Table 292 - Definition of PER bit and EMCDR field of Persistent-DM mode

PER bit	EMCDR field value	Media certification ^a	RECOVERED ERROR reporting ^b		
			READ ^c	VERIFY	Other commands
0	0	Disabled	N/A	N/A	No
	1	Enabled	No	No	No
	2	Enabled	No	Yes	No
	3	Enabled	Yes	Yes	No
1	0	Enabled	N/A	N/A	Yes ^d
	1	Enabled	Yes	Yes	Yes
	2	Enabled	Yes	Yes	Yes
	3	Enabled	Yes	Yes	Yes

a. on READ (10), READ (12) with Streaming = 0, VERIFY (10), or WRITE AND VERIFY (10) command

b. 1/18/05 *shall* be used for defect management purpose except for footnote <d> case.

c. on READ (10) or READ (12) command with Streaming=0. READ (12) with Streaming =1 is not included

d. logical unit is allowed to use any RECOVERED ERROR code to keep legacy compatibility

10.5.2 *Recommend host sequence of Persistent-DM mode*

At the time of disc mounting

1. Turn on media certification (EMCDR field in Read-Write Error Recovery mode page)
2. Try to recognize file system of the disc
3. If the host's File System driver does not support the file system on the disc, turn off media certification (EMCDR field in Read-Write Error Recovery mode page). Then pass the disc to the next possible file system driver.

At the time of disc writing

1. Write several Packets
2. Verify the written Packets
3. If a RECOVERED ERROR is reported, retrieve DBI information.

At the time of disc unmounting

1. Synchronize all cached data to the disc
2. Turn off media certification (EMCDR field in Read-Write Error Recovery mode page)
3. Un-mount the disc

10.6 *DRT-DM mode behavior*

The basic three actions of defect management are performed by different commands and timing. Certification and Detection are separated in READ command and WRITE command respectively, and are connected by DBI memory. Either small DBI cache model or large DBI buffer model *shall* be used.

The EMCDR field controls the reporting of RECOVERED ERRORS. The host is able to receive RECOVERED ERROR by use of certain commands (e.g., media access command). The host is able to retrieve DBI data at a time convenient to the host.

1. Certification is performed at READ (10), READ (12) or VERIFY (10) command. The result is stored in DBI memory.
2. Detection is performed at WRITE (10) or WRITE (12) command with checking of DBI memory. The result is reported as RECOVERED ERROR of WRITE (10) or WRITE (12) command.
3. Management is performed by the host. If the host receives a RECOVERED ERROR at completion of a WRITE command, the host *shall* perform necessary management of written data. The host is able to retrieve the DBI data from DBI buffer at any time.

There are two types of memory model for DBI memory. One is the large DBI buffer memory model that covers all Packets on the media. This memory model never cause DBI buffer overflow. Another is the small DBI cache memory model. This model has a special scheme to minimize cache overflow. But cache overflow is possible.

The EMCDR field controls DRT-DM behavior. When a logical unit reads medium and the EMCDR field is set to a value other than 0, the logical unit *shall* certify Packets on the medium and store the certification result into DBI memory regardless of **Streaming** bit setting of READ (12) command. In the case of DRT-DM mode, media certification by READ (12) command with **Streaming** bit = 1 *shall* be supported.

In the DRT-DM mode, when a write error happens at WRITE (12) command with **Streaming** bit = 1, the result *shall* be stored in DBI memory. Error reporting is dependent on the **PER** bit and the EMCDR field setting. If RECOVERED ERROR reporting is disabled, no RECOVERED ERROR *shall* be reported. In this case, the host should check DBI data after the writing operation of WRITE (12) command with **Streaming** =1, if necessary.

10.6.1 Defect Level Transition model

In the case of real-time stream recording, the host and logical unit are not able to perform verify after write operation and defect management. Because data allocation of the real-time stream (e.g., real-time Video data) *shall* be determined before writing on the medium to keep data format compatibility and playback compatibility. The real-time stream data flows from host to logical unit continuously. Usually there is no time for verify after write operation and defect management. To guarantee the readability of written Packet, the host needs to verify the Packet before write.

In the DRT-DM mode, the logical unit and media *shall* support Defect Level Transition model. If there is neither physical impact to media (e.g., scratch, finger print) nor physical impact to logical unit (e.g., shock, vibration), error level of a Packet *shall not* change from non-defect level to fatal defect level. Type 1 defect or Type 2 defect *shall* be reported before the Packet becomes unreadable by ordinary direct overwrite cycles.

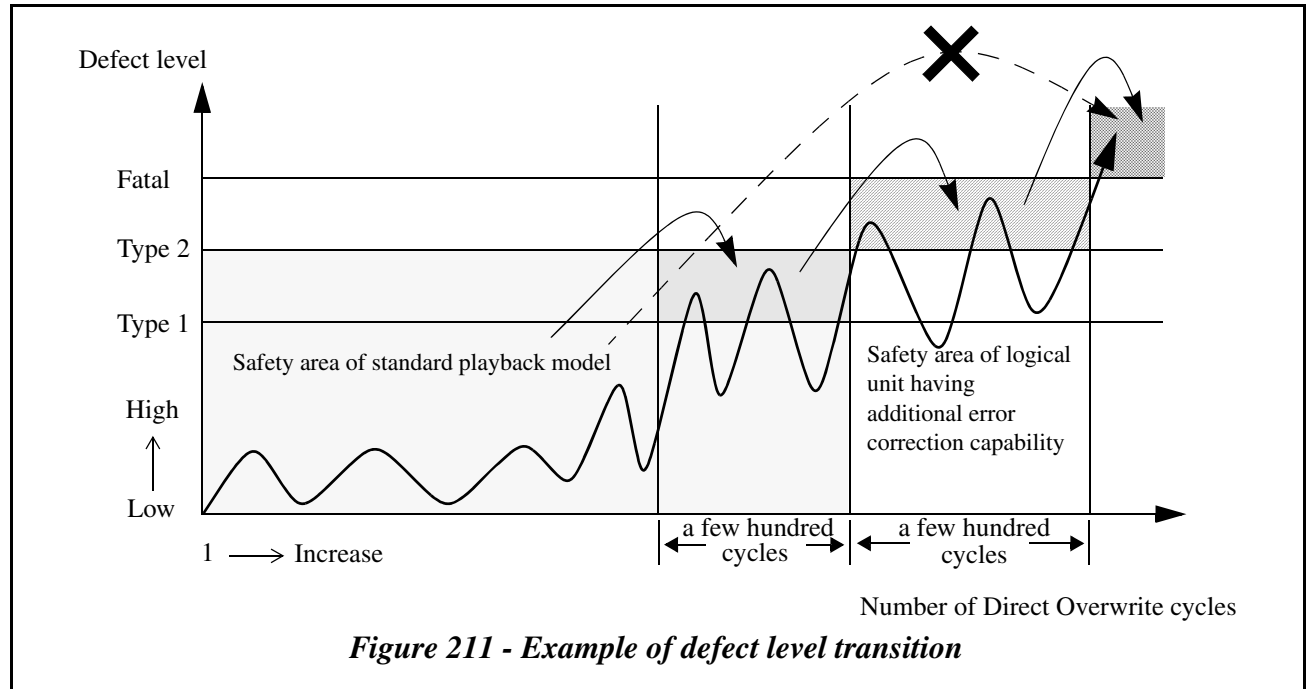


Figure 211 - Example of defect level transition

10.6.2 Certification

At READ command, the logical unit *shall* certify specified blocks to be read. The result is stored in DBI memory.

In the case of small DBI cache memory model, the information of actually transferred blocks *shall* be stored in RDBI cache. The information of the blocks those are out of range of the command (e.g., read by look ahead buffering but not transferred to host) *shall not* be stored in the RDBI cache because the blocks may already be replaced and no longer be used by the host.

If the logical unit finds defective blocks in VERIFY (10) or WRITE AND VERIFY (10) command, the command *shall* be terminated with CHECK CONDITION status when all blocks specified by command are certified or when DBI cache overflow occurs. The logical unit *shall* report RECOVERED ERROR to the host. The result is stored in DBI memory.

READ (10), READ (12), and VERIFY (10) command *shall* be performed normally regardless of certification. If a fatal error is detected, the logical unit *shall* report the error normally.

10.6.3 Detecting the use of a defective block

Detection is performed by WRITE (10) or WRITE (12) command. The logical unit *shall* check all written block addresses by RDBI cache or DBI buffer. When a defect information is found, the logical unit *shall* terminate the WRITE command with CHECK CONDITION status after all data is transferred. The logical unit *shall* report a RECOVERED

ERROR to the host. All buffered data *shall* be written on the media properly even if WRITE command is terminated with CHECK CONDITION status. In the case of small DBI cache memory model, when defective block is used by a WRITE command, the logical unit *shall* store the information in WDBI cache.

If a fatal error is detected, the logical unit *shall* report the error normally.

10.6.4 Management of defective block

When the host pauses current real-time operation, the host should perform defect management of used defective blocks, if necessary. Some of the information on defective blocks may have important data to be replaced. Some other may not be needed to replace. In the case of real-time streaming data (e.g., video stream), the data blocks are not allowed to be replaced. The host *shall* select suitable defect management method for such data.

If the host receives a RECOVERED ERROR at WRITE command, some of information had been written on defective blocks. The host *shall* read the DBI data by GET PERFORMANCE command with Type = 04h. The host *shall* determine which data on defective blocks *shall* be managed.

10.6.5 Delayed replacement of data on defective block

The RECOVERED ERROR reported by a logical unit means that some of the used sectors by WRITE command are not reliable. After hundred (it may be a few hundred initially, a few times finally) overwrite cycles on the same block, the block may become unreadable. Therefore, the host may read the written data from defective blocks, and may write them into spare area.

10.6.6 RECOVERED ERROR reporting control for DRT-DM mode

When the PER bit is set to one and/or the EMCDCR field is set to one or higher, the logical unit *shall* perform media certification and *shall* report RECOVERED ERROR on READ (10), READ (12), VERIFY (10), or WRITE AND VERIFY (10) command regardless of Streaming bit setting.

If the EMCDCR field is set to zero, the logical unit should not store the certification result in DBI memory to avoid overflow when the logical unit supports small DBI cache memory model.

If the PER bit is set to zero, the EMCDCR field controls the RECOVERED ERROR for defect management as defined in Table 293. In this case, the returned error code *shall* be 1/18/05 RECOVERED DATA - RECOMMEND REASSIGNMENT. See 10.3, "Enhanced defect reporting" on page 478.

When WRITE (10) or WRITE (12) command is terminated with a RECOVERED ERROR, the logical unit *shall* write the data to the medium.

The error code of the write failure on WRITE (10), WRITE (12), or WRITE AND VERIFY (10) command is not defined in this model section. See each media model section and WRITE (10), WRITE (12), or WRITE AND VERIFY (10) command sections.

The error code of the read failure on READ (10) or READ (12) command is not defined in this model section. See each media model section and READ (10) or READ (12) command sections.

If the PER bit is set to one, various kinds of a RECOVERED ERROR will be returned for any type of command. If the EMCDCR field is set to zero, the reported RECOVERED ERROR for defect management is vendor specific. If the EMCDCR field is set to a value other than zero, the reported RECOVERED ERROR for defect management *shall* be 1/18/05 RECOVERED DATA - RECOMMEND REASSIGNMENT.

Table 293 - Definition of PER bit and EMCDR field of DRT-DM mode

PER bit	EMCDR field value	Media certification ^a	RECOVERED ERROR reporting ^b			
			READ ^c	VERIFY	WRITE	Other commands
0	0	Disabled	N/A	N/A	N/A	No
	1	Enabled	No	No	No	No
	2	Enabled	No	Yes	Yes	No
	3	Enabled	Yes	Yes	Yes	No
1	0	Enabled	N/A	N/A	N/A	Yes ^d
	1	Enabled	Yes	Yes	No	Yes
	2	Enabled	Yes	Yes	Yes	Yes
	3	Enabled	Yes	Yes	Yes	Yes

- a. on READ (10)/READ (12), VERIFY (10), or WRITE AND VERIFY (10) command
- b. 1/18/05 *shall* be used for defect management purpose except for footnote <d> case.
- c. on READ (10) or READ (12) command
- d. logical unit is allowed to use any RECOVERED ERROR code to keep legacy compatibility

10.7 Host recovery action recommendation

From DVD-RW media characteristics, the relation of the Number of Direct Overwrite cycles and the defect level is wavy, see Figure 211 - *Example of defect level transition* on page 487. Even if the Direct Overwrite cycles is less than 50 cycles, the peak defect level may exceed Type 1 or Type 2 level which depends on the compatibility of the media product and the drive. But the defect level on the next overwrite may become very low again. So, it is recommended to re-write the user data to the same ECC block by the host again to avoid unnecessary replacement by the file system, even if the ECC block is reported as defective. If the re-writing is failed, then a reallocation operation by the file system should be done.

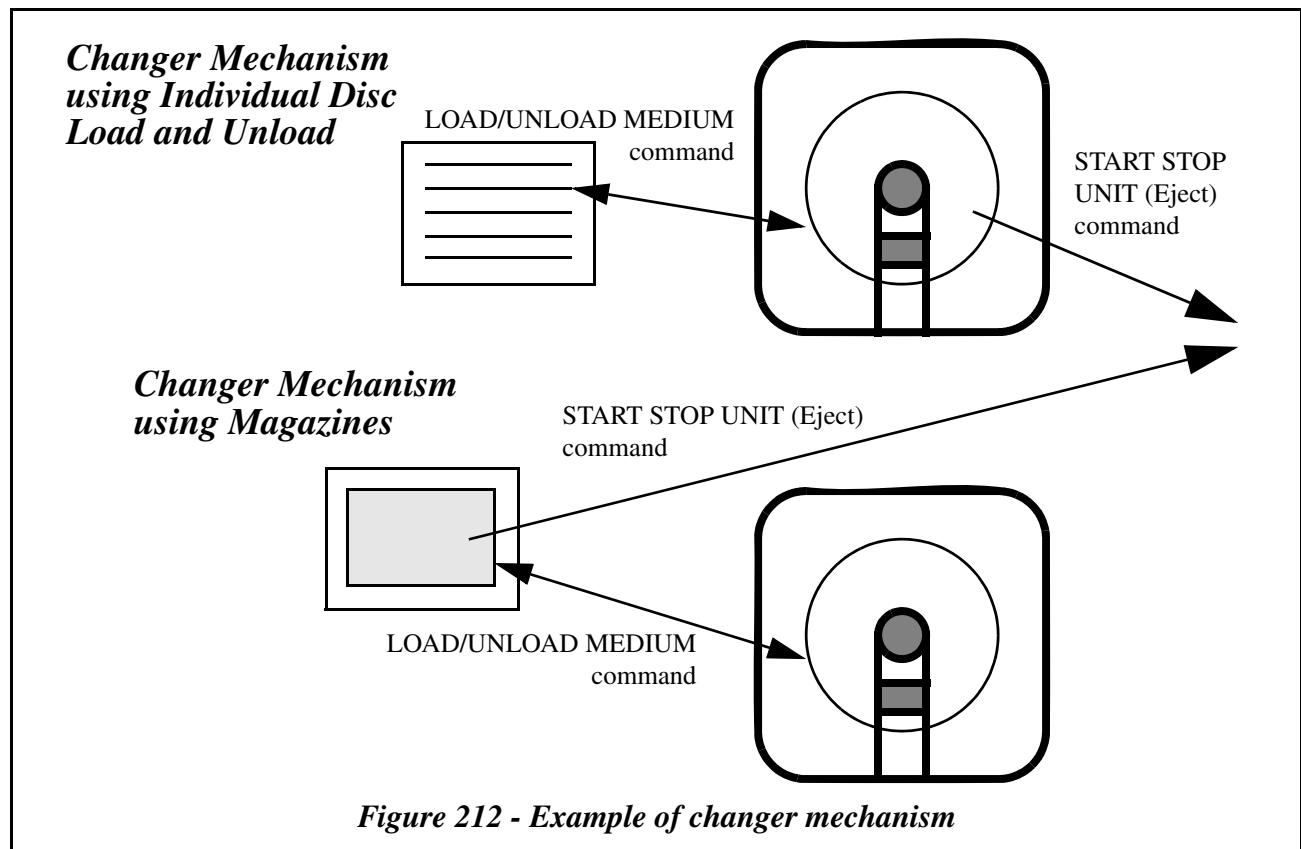
11.0 Changer Model

A changer logical unit will perform exactly like a single logical unit. However it *shall* support the commands MECHANISM STATUS and LOAD/UNLOAD MEDIUM.

A changer logical unit provides a storage area for more than one disc. This storage area contains multiple areas called slots. Each slot can contain just one Disc. Once a Disc has been placed in to a given slot, it becomes locked in that position. This specification provides no capability to move a Disc from one slot to another. Thus when a Disc has been moved from a given slot into the playing position, it can only be moved back into the slot that it came from. This *shall* be followed even if power is lost while a Disc is in the playing position or while it was being moved.

There are two basic types of changer mechanisms, one that has individually addressable eject and load capability and another that uses a Magazine to hold the discs. In the former, individual disc can be changed, while in the latter all the stored discs *shall* be changed at one time.

Any time a Disc/Cartridge is installed from the changer, the logical unit *shall* generate a UNIT ATTENTION condition. After the host detects the UNIT ATTENTION on a known changer logical unit, the host may issue a MECHANISM STATUS command. This will provide the host with information on what disc is present or was changed.



11.1 Sidedness

As part of the DVD specifications, there is a type of media supported that includes data on more than one side of the Disc. This will allow devices that can automatically change sides to come into existence. Thus for Multi-Media logical units, there is an optional capability to select each side of the disc. Although this would not normally be thought of as a changer type of operation, the two sides to the disc are independent and changer like functions are a good match for selecting sides. When the logical unit supports this functionality, each physical slot will have two logical slots. For example referencing slot 0 would be one side of the disc, and slot 1 would then be the other side.

There are two fundamental techniques used to select each side of DVD media. The first is the most space efficient. It simply moved the Pick Up (laser unit used to read the disc) to the other side. This does add complexity to the laser mechanism to be able to position it on either the bottom or top of the media. The second approach is to actually flip the media over. This type does not exist today, although it is possible. This type of logical unit will pose some problems making sure that the correct side is selected after a power on or hard reset condition. Some way to remember which side was selected when the power was removed would be needed.

For a logical unit that supports changing sides (see 17.4.2.42, "*Feature 0102h: Embedded Changer*" on page 614, "Side Change Capable"), the number of Slots reported *shall* be even, and every other slot *shall* be an alternating side.

11.1.1 Side Changing Only logical unit

There can exist a logical unit that is capable of changing the side of the Disc, but does not have separate Slots from the playing position. This type of logical unit reports that it has a Mechanism type that is not a changer, but also reports Side Change Capable. This style of logical unit will still make use of the LOAD/UNLOAD MEDIUM command to change the currently selected side. This style logical unit *shall* report two slots available (see Table 509 - *Mechanism Status Header* on page 664).

A side effect of a logical unit that only has the capability to change sides is that when unloading a Disc does not actually perform any action. This will appear to the host as a logical unit with Delayed Load type of operation (see 11.5, "*Delayed Disc load operation*" on page 493).

Note: A DVD logical unit that supports changing sides will not be able to report if there is actually data on both sides until each side has been read.

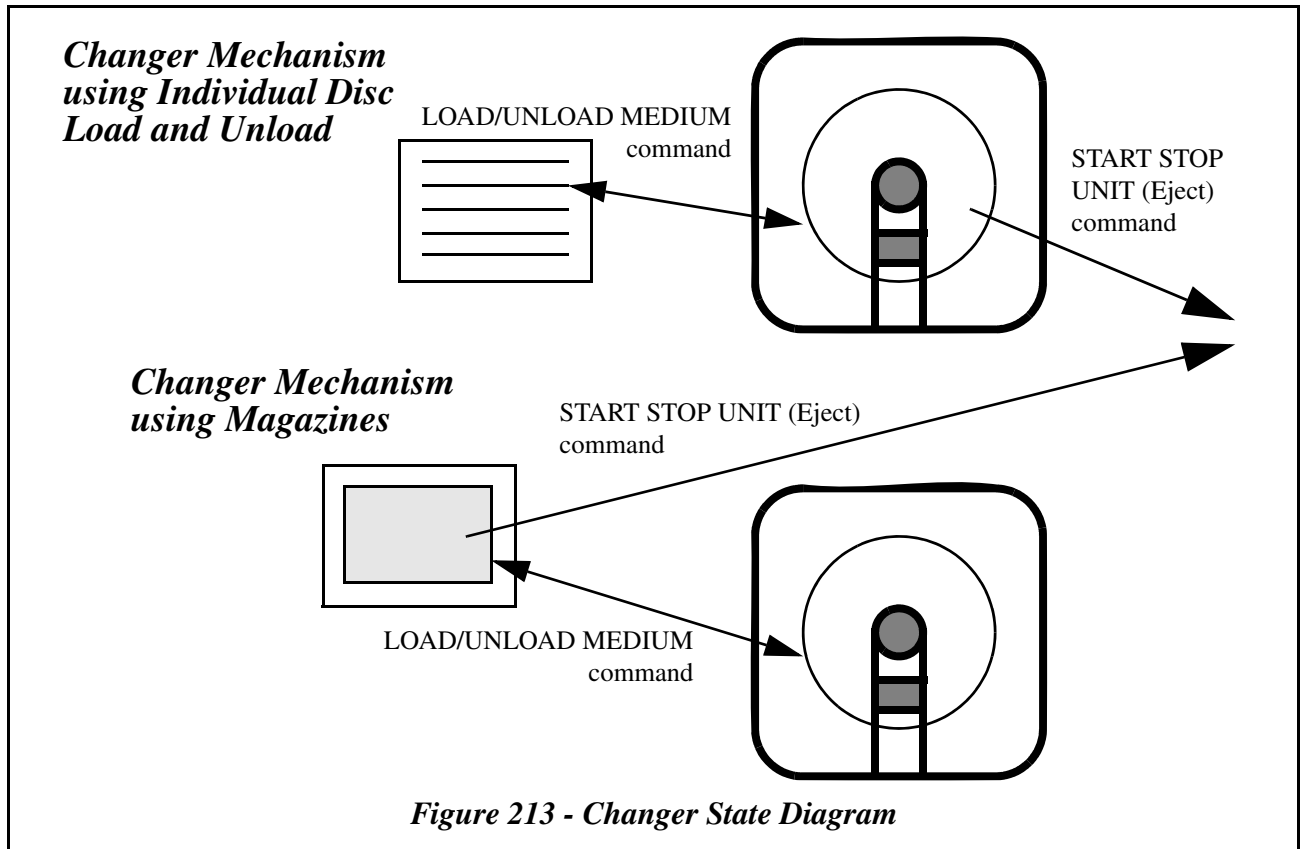
11.1.2 Error conditions for Sided Discs

Devices that support changing sides of a Disc *shall* use report CHECK CONDITION Status, 2/06/00 NO REFERENCE POSITION FOUND (medium may be upside down) when the currently selected side does not contain valid data.

11.2 Initialization

The Changer *shall* perform its initialization routine at power on or receipt of a hard reset from the host.

"Initializing Changer" is a process that refers to gathering the information that is necessary to respond to the MECHANISM STATUS command. If a changer is in the process of Initializing when it receives a MECHANISM STATUS command, it will respond immediately and provide no slot table information (Only the Header).



11.3 Changer Addressing

Several Changer specific commands use addresses called “Slots.”

To determine if a logical unit is a changer type logical unit the Embedded Changer Feature (0102h) *shall* be reported in response to an appropriate GET CONFIGURATION command. A logical unit that reports Side Change Capable *shall* implement all Changer commands.

11.4 Automatic Load and Unload Operations

After initialization is complete the changer *shall* have Slot 0 loaded into the play position. This enables drivers which are not changer aware to work with a changer logical unit as if it were a normal single disc logical unit. This also insures compatibility with Bootable discs. In support of this goal the changer *shall* also load and unload (Eject) default Disc 0 if the changer supports loading and unloading (Ejecting) individual Discs unless otherwise commanded by the use of one of the changer specific Load/Unload commands.

When a LOAD/UNLOAD MEDIUM command (Load) is received and a Disc is present in the Playing position, it *shall* be unloaded automatically before the specified Load operation is performed.

11.5 Delayed Disc load operation

Multi-Media Changer Devices may either move a disc into the playing position immediately upon receipt of a LOAD/UNLOAD MEDIUM command (Load), or delay the loading of the disc until a media access command is received. It is recommended that the logical unit not load discs into the playing position until data from a disc that is not cached is

requested from the host. The delayed operation extends to the LOAD/UNLOAD MEDIUM (Unload) operation as well. Both the Load and Unload operations may be delayed.

Note: Host drivers should expect to encounter load mechanism delays on media accesses in addition to the spin up and seek delays normally introduced with these commands.

If the logical unit supports delayed loading and the selected disc is not in the play position, then the following commands **shall** move the selected disc into the play position when data that has not been cached has been requested by the host:

Table 294 - Delayed Load Operation by command

Command	Allowed Action
BLANK	Delay in processing command is allowed
CHANGE DEFINITION	No extra delay for medium movement shall occur
CLOSE TRACK/SESSION	Delay in processing command is allowed
FORMAT UNIT	Delay in processing command is allowed
GET CONFIGURATION	No extra delay for medium movement shall occur
GET EVENT/STATUS NOTIFICATION	No extra delay for medium movement shall occur
GET PERFORMANCE	No extra delay for medium movement shall occur
INQUIRY	No extra delay for medium movement shall occur
LOAD/UNLOAD MEDIUM	Delay in processing command is allowed but is not recommended
LOCK/UNLOCK CACHE	Delay in processing command is allowed
LOG SELECT	No extra delay for medium movement shall occur
LOG SENSE	No extra delay for medium movement shall occur
MECHANISM STATUS	No extra delay for medium movement shall occur
MODE SELECT (10)	No extra delay for medium movement shall occur
MODE SENSE (10)	No extra delay for medium movement shall occur
PERSISTENT RESERVE IN/OUT	No extra delay for medium movement shall occur
PLAY AUDIO (10)	The current slot selected shall be moved into the play position
PLAY AUDIO MSF	The current slot selected shall be moved into the play position
PREFETCH	Delay in processing command is allowed
PREVENT ALLOW MEDIUM REMOVAL	No extra delay for medium movement shall occur
READ (10) and READ (12)	Delay in processing command is allowed
READ BUFFER	No extra delay for medium movement shall occur
READ BUFFER CAPACITY	No extra delay for medium movement shall occur
READ CAPACITY	No extra delay for medium movement shall occur
READ DISC INFORMATION	Delay in processing command is allowed
READ SUBCHANNEL	Delay in processing command is allowed
READ FORMAT CAPACITIES	No extra delay for medium movement shall occur
READ CD	Delay in processing command is allowed
READ CD MSF	Delay in processing command is allowed
READ DISC STRUCTURE	Delay in processing command is allowed
READ TOC/PMA/ATIP	Delay in processing command is allowed
READ TRACK INFORMATION	Delay in processing command is allowed
RECEIVE DIAGNOSTIC RESULTS	No extra delay for medium movement shall occur
RELEASE	No extra delay for medium movement shall occur
REPORT KEY	No extra delay for medium movement shall occur
REPORT LUNS	No extra delay for medium movement shall occur
REQUEST SENSE	No extra delay for medium movement shall occur
RESERVE	No extra delay for medium movement shall occur

Table 294 - Delayed Load Operation by command (continued)

Command	Allowed Action
RESERVE TRACK	Delay in processing command is allowed
SEEK	The current slot selected <i>shall</i> be moved into the play position
SEND DIAGNOSTIC	No extra delay for medium movement <i>shall</i> occur
SEND DISC STRUCTURE	Delay in processing command is allowed
SEND EVENT	Delay in processing command is allowed
SEND KEY	No extra delay for medium movement <i>shall</i> occur
SEND OPC INFORMATION	No extra delay for medium movement <i>shall</i> occur
SET CD SPEED	No extra delay for medium movement <i>shall</i> occur
SET READ AHEAD	No extra delay for medium movement <i>shall</i> occur
SET STREAMING	No extra delay for medium movement <i>shall</i> occur
STOP PLAY/SCAN	No extra delay for medium movement <i>shall</i> occur
START STOP UNIT	The current slot selected <i>shall</i> be moved into the play position
SYNCHRONIZE CACHE (10)	Delay in processing command is allowed
TEST UNIT READY	No extra delay for medium movement <i>shall</i> occur
VERIFY (10)	Delay in processing command is allowed
WRITE (10) and WRITE (12)	Delay in processing command is allowed
WRITE BUFFER	No extra delay for medium movement <i>shall</i> occur
WRITE AND VERIFY (10)	Delay in processing command is allowed

11.6 PREVENT ALLOW MEDIUM REMOVAL processing

There are two techniques for PREVENT ALLOW MEDIUM REMOVAL processing: either all the discs *shall* be prevented from being ejected by the user or each disc individually *shall* be prevented. If the logical unit reports support for Software Slot Selection, then each slot *shall* be individually controlled by the PREVENT ALLOW MEDIUM REMOVAL command.

Note: Changer devices that use a Magazine and not individually controlled slots should not report the Software Slot Selection capability.

11.7 Error Reporting

If any of the following conditions occur during the execution of a command, the Multi-Media Changer *shall* return CHECK CONDITION status. The appropriate sense key and additional sense code *shall* be set. The following list illustrates some error conditions and the applicable sense keys. The list does not provide an exhaustive enumeration of all conditions that may cause the CHECK CONDITION status.

Table 295 - Error conditions and Sense Keys for Changer Mechanisms

Condition	Sense Key
Invalid Slot Number	ILLEGAL REQUEST
Unsupported option requested	ILLEGAL REQUEST
Load or Unload to invalid slot or no Disc in source location	ILLEGAL REQUEST
Device reset or medium change since last command	UNIT ATTENTION
Self diagnostic failed	HARDWARE ERROR

In the case of an invalid Slot number, the sense data information field *shall* be set to the Slot number of the first invalid address.

When an error condition is reported to the host, the disc in the selected slot *shall* be moved into the play position.

Attempts to eject a Disc if the changer type is Magazine and there is a Disc in the playing position *shall* be rejected with CHECK CONDITION Status, 4/3B/16 MECHANICAL POSITIONING OR CHANGER ERROR.

12.0 Write protection model

Random Writable and Overwritable logical unit may be able to perform Write Protection. For example, DVD-RAM cartridge has Write Protection Switch/tabs. User can set or release the Write Protection Switch/tabs for user's purpose, e.g., to disable data modification on the media. In this section, User/host accessible Write Protection Methods and Media Specific Write Inhibition are described.

There are three methods of Write Protection for Device Type 5 logical unit, Software Write Protection until Power down (SWPP), Persistent Write Protection (PWP) and Media Cartridge Write Protection (CWP). SWPP is stored in the logical unit memory. See 17.11.3.5, "Timeout and Protect mode page" on page 685. PWP is a kind of Media write protection for example Write-inhibit flag of DVD-RAM Ver. 2.2 and Write Protected Disc Status of DVD-RW SL Ver. 1.2. This Write Protection status is recorded on a media surface. PWP is possible to be set or to be cleared by host via command. CWP is a kind of write protect switch/tab on the Media Cartridge or Magazine. CWP is possible to be set or released by user manually.

For example, DVD-RAM media has Media Specific Write Inhibition (MSWI). Combination of Disc Type Identification field value and cartridge status may set MSWI active. For more information, see 4.16.13, "Write protection of a disc" on page 129.

These three Write Protection status and MSWI status *shall* be applied as logical OR. If one of them is set to active status, a logical unit *shall not* report any erasable/formattable/writable Features as current.

12.1 Consideration for compatibility with other device type

In other device type, PWP is defined and its functionality is almost same as the PWP that is explained in this section. In some other device types (e.g., device type 1: Sequential-access device), PWP is defined to be controlled by MODE SENSE (10) and MODE SELECT (10) commands. PWP is included in device specific Mode Parameter. In this case, when the PWP status is changed by the media exchange, the logical unit *shall* generate UNIT ATTENTION and SK/ASC/ASCQ *shall* be set to 6/2A/01 MODE PARAMETERS CHANGED. Usually this kind of UNIT ATTENTION is not generated, even if the host Operating System supports multi-tasking. To eliminate this UNIT ATTENTION, this specification does not use any Mode Parameter to control and report the PWP status of the media.

12.2 Write Protect Feature and related commands

If logical unit supports one of these Write Protection Methods or Media Specific Write Inhibition, logical unit *shall* support Write Protect Feature (0004h) and READ DISC STRUCTURE command with Format Code code C0h and FFh. Reporting of these status *shall* be reflected by the current mounted media specification. If the specification of the mounted medium does not specify the Write Protection function, the corresponding bits should be set to zero. For example, if DVD-ROM disc is in a DVD-RAM cartridge, regardless of the Write Protection switch/tabs setting of the cartridge, MSWI, CWP and PWP bits of READ DISC STRUCTURE returned data should be set to zero. If there is no mounted medium in the logical unit, READ DISC STRUCTURE command with Format Code code C0h *shall* be terminated with CHECK CONDITION Status, 2/3A/00 MEDIUM NOT PRESENT.

If Supports PWP (SPWP) bit of the Write Protect Feature Descriptor is set to one, SEND DISC STRUCTURE command with Format Code code C0h *shall* be supported. In this case, Current bit of the Write Protect Feature Descriptor *shall* indicate whether the SEND DISC STRUCTURE command with Format Code code C0h can work on the mounted media. If Supports SWPP (SSWPP) bit of the Write Protect Feature Descriptor is set to one, logical unit *shall* support SWPP bit in the Timeout and Protect mode page. SSWPP bit does not affect the Current bit of the Write Protect Feature Descriptor. Because this Mode Parameter Page is always accepted by the logical unit.

If logical unit supports Embedded Changer Feature (0102h), logical unit *shall* support CWP_V, CWP bits in Table 510 - Slot Table Response format on page 665.

By the SEND DISC STRUCTURE command, the data sent from host may not be written on physical medium at the command completion. It will be applied at appropriate timing defined by the media specification and/or the Format Code code definition. In the case of DVD-RW, PWP status *shall* be set on the medium when:

- medium is going to be ejected
- SYNCHRONIZE CACHE (10) command is issued
- RMA is modified by another reason

12.3 Error reporting

When Write Protection status is set to active, logical unit *shall* terminate all the commands that cause erasing/formatting/writing on media except PWP status changing with CHECK CONDITION status. If SWPP is set to active, ASC/ASCQ of 7/27/02 LOGICAL UNIT SOFTWARE WRITE PROTECTED *shall* be reported via REQUEST SENSE command. If PWP is set to active, ASC/ASCQ of 7/27/04 PERSISTENT WRITE PROTECT *shall* be reported. If CWP is set to active, ASC/ASCQ of 7/27/01 HARDWARE WRITE PROTECTED *shall* be reported. If MSWI is set to active, ASC/ASCQ of 7/27/00 WRITE PROTECTED *shall* be reported. If more than one Write Protections are active, the following order *shall* be used for error reporting, SWPP, CWP and PWP. PWP has the lowest priority. Because other types are permanent during medium is mounted in a logical unit.

12.4 Event reporting

When Write Protection status of mounted medium and/or logical unit is changed (e.g., all of Write protections are cleared or one of them is set to active), any Features that allows erasing/formatting/writing on media except Write Protect Feature are changed, then logical unit *shall* generate Operational Change Request/Notification Class Event if logical unit supports the reporting of the Operational Change Request/Notification Class Event.

12.5 Persistent Write Protection exception

Even if PWP status is active, it may be possible to change the data on the media according to regulations of the media specification or some related specific specification. It depends on the specification.

13.0 Power management model

Four power states are defined. These are named Active, Idle, Standby, and Sleep with Active being the “Full-On” state, Sleep the “Off” state and “Idle, Standby and Sleep” progressively more aggressive power managed states. This model differs significantly from previous ATA and SCSI power management definitions. This new model defines power states in terms of the perceived impact on the end user, instead of absolute power levels. The Idle state is optimized for minimal end user performance impact. The Standby state is optimized for power savings.

To provide consistent behavior across logical units, standard definitions are used for the power states of logical units. These states are defined in terms of the following criteria.

- Power Consumption: How much power the logical unit uses.
- Logical unit Context: How much of internal state of the logical unit is retained by hardware and what *shall* be restored by the responsible software.
- Restore time: How long it takes to raise the power level to the active power state and to put the logical unit into operational condition (including mechanical operation such as spin up) required before entering into the Active power state. Restoring is vendor specific and any mechanism can be employed here to raise the power consumption and to put the logical unit in operation condition required in a higher power state. For example, “turning on or raising internal Vcc’s for power hungry circuits such as motors, laser sensors”, “raising internal Vcc or the clock frequency for the digital circuits”. A critical factor is how quickly restoring the logical unit to operation condition required in a higher power state (e.g., spin up).
- De-power time: How long it takes to reduce the power to the desired level in lower power state after entering the lower power state from higher power state. De-powering is vendor specific and any mechanism can be employed here to reduce the power consumption. For example, “turning off or lowering internal Vcc’s for power hungry circuits such as motors, laser sensors”, “lowering internal Vcc or reducing the clock frequency for the digital circuits”, “dynamic clock gating”, “cutting off the DC paths for unused circuits”, “turning off PLLs”.

Table 296 - Power management model states

Logical unit State	Power Consumption	Logical unit Context Retained	Restore Time
Active (D0)	As needed for operation.	All	None
Idle (D1)	Less than Active	All	The logical unit <i>shall</i> be restored to active state within 1 second on any request to enter active state, independent of the de-powering process.
Standby(D2)	Less than Idle	All buffers are empty before entering Standby state.	Vendor specific: Greater than or equal to Idle to Active
Sleep(D3)	Less than Standby	None, Buffer and all of command queues are empty before entering Sleep state.	Greater than or equal to Standby to Active. Vendor Specific. May Need full initialization. The host may remove Vcc.

Transitions between these power states may occur at the request of the host or the logical unit. Transitions to a higher power state from a lower power state *shall* occur after restoring the logical unit to the operating conditions (including mechanical operation if applicable, such as spin up) required in the higher power state. When the logical unit transitions from a higher power state to a lower power state, the logical unit *shall* be considered to be in the lower power state when the logical unit is assured of reaching the lower power condition. Actual de-powering occurs after the logical unit enters the lower power state. The logical unit *shall* generate a power Event when the logical unit is considered to have entered a power state.

In order to create a robust power management environment, logical units *shall* support the following:

- The Power Management Feature.
- Four power states: Active (D0), Idle (D1), Standby (D2) and Sleep (D3).
- IDLE CONDITION TIMER. Provides a method for the logical unit to enter Idle state from Active state, following a programmed period of inactivity.
- STANDBY CONDITION TIMER. Provides a method for the logical unit to enter Standby state from either Active or Idle state, following a programmed period of inactivity.
- START STOP UNIT command and the Power Condition field: Provides a method for the host to request the logical unit to enter a power state.
- GET EVENT/STATUS NOTIFICATION command: Notifies the host of power state changes and current power status.
- Power Condition mode page: Enables or disables timers and specifies the reload value of the IDLE CONDITION TIMER and STANDBY CONDITION TIMER.

13.1 Power state transitions

Active State (D0): The logical unit is completely active and responsive. The logical unit is consuming its highest level of power. During the execution of a media access command (commands that reload both timers) the logical unit *shall* be in active state.

The logical unit should minimize power consumption at all times, even when in the active state. Any mechanism can be employed, as long as it is transparent to software and does not prevent the logical unit from performing expected functions. For example, the logical unit may dynamically gate on/off internal clocks by monitoring bus activities and internal activities.

Idle State (D1): In Idle state, the logical unit is capable of responding to commands but may take up to one second longer to complete commands than the Active state. The logical unit is consuming less power than the Active state. Any mechanism can be employed as long as the restoring time is less than one second. The logical unit may, for example:

- Reduce internal clock frequency
- Lower the internal Vcc for digital circuits
- Dynamically gate internal clocks by monitoring bus/internal activities

Standby State (D2): In Standby state the logical unit *shall* only be required to accept commands from the host. All other mechanisms are in the power save condition. In Standby state, the logical unit is capable of responding to commands but the logical unit takes longer to complete commands than when in Idle state. Buffers *shall* be emptied before entering into Standby state. The logical unit context *shall* be preserved. The logical unit is consuming less power than when in Idle state.

Sleep State (D3): Maximum power saving state. Buffers and all command queues, including GET EVENT/STATUS NOTIFICATION commands, *shall* be emptied before entering into the Sleep state. When the logical unit enters the sleep state, any GET EVENT/STATUS NOTIFICATION commands present in the command queue, *shall* be removed from the command queue, without command completion. In this Sleep state, all functions are stopped and no commands, except for reset can be received. The unit is consuming less power than when in the Standby state. The logical unit context is invalid in the Sleep state.

The host software *shall* fully initialize the logical unit after exiting Sleep state, as all context may be lost in the Sleep state. Therefore, disc(s)/cassette may be manually ejected or inserted while in sleep state, independent of any lock/unlock mechanism employed. For the host to consistently rely on the logical unit Media Status Notifications, when the logical unit is unable to determine if media has been changed while the logical unit was in the sleep state, the logical unit *shall* report a New Media Event on the next GET EVENT/STATUS NOTIFICATION (Media Status) command.

In the Sleep state, the host may completely remove power from the device by turning off Vcc.

13.1.1 State diagram

The state diagram in Figure 214 - *State transition, events and status* on page 502 and Table 297 - *State transition, events and status* on page 503 define state transitions for the power management model.

A power-on or hard reset always returns the Power State to the Standby state. A Device Reset does not alter the current power state, unless the current power state is Sleep. A Device Reset received while in sleep state returns the power state to Standby.

The Sleep state is entered when the logical unit has been commanded to go to Sleep but Vcc is still applied to the device. Removing Vcc always takes the device to the Power Off state. Removing Vcc is recommended only when all logical units on a given bus are in sleep state.

Table 297 - *State transition, events and status* on page 503 shows transition conditions for this model, and shows the Initial state, the Resultant state, Notification Class, and Event class (Media or Power Management). Notification Class and Event class (Power Event/Media Event) fields specify the Events that **shall** be generated during the transitions as outlined in the GET EVENT/STATUS NOTIFICATION command.

In Idle or Standby states, the logical unit should attempt to maintain the minimal power level for that state at all times. However, the logical unit may create transitory, higher power level conditions as needed. The transitory power conditions **shall not** affect the reported power state, or generate power state Events. Example transitory conditions are: flushing the buffers, emptying command queues, media insertion spin up, or auto off-line. On insertion of new media, the logical unit may enter a transitory, higher power condition and stay in this condition for vendor specific time period. If the logical unit has not received a media access command (commands which reload both timers) during this period, the logical unit **shall** return to the normal power level for the current power state. This prevents excessive power consumption while the host is off-line.

It is permissible to enter intermediate states while in transition between states, however, the logical unit **shall not** report power change Events for the intermediate states. If the logical unit fails to enter the target power state, the logical unit **shall** return to the original power state. Simultaneous expiration of multiple timers, **shall** cause the logical unit to enter the lower power state, and **shall** only report the result of the transition to that state.

When no media is mounted, the logical unit should enter the Standby State.

If a power change Event has not been reported to the host, when a new Event is generated, the logical unit may choose only to report the most recent power Event.

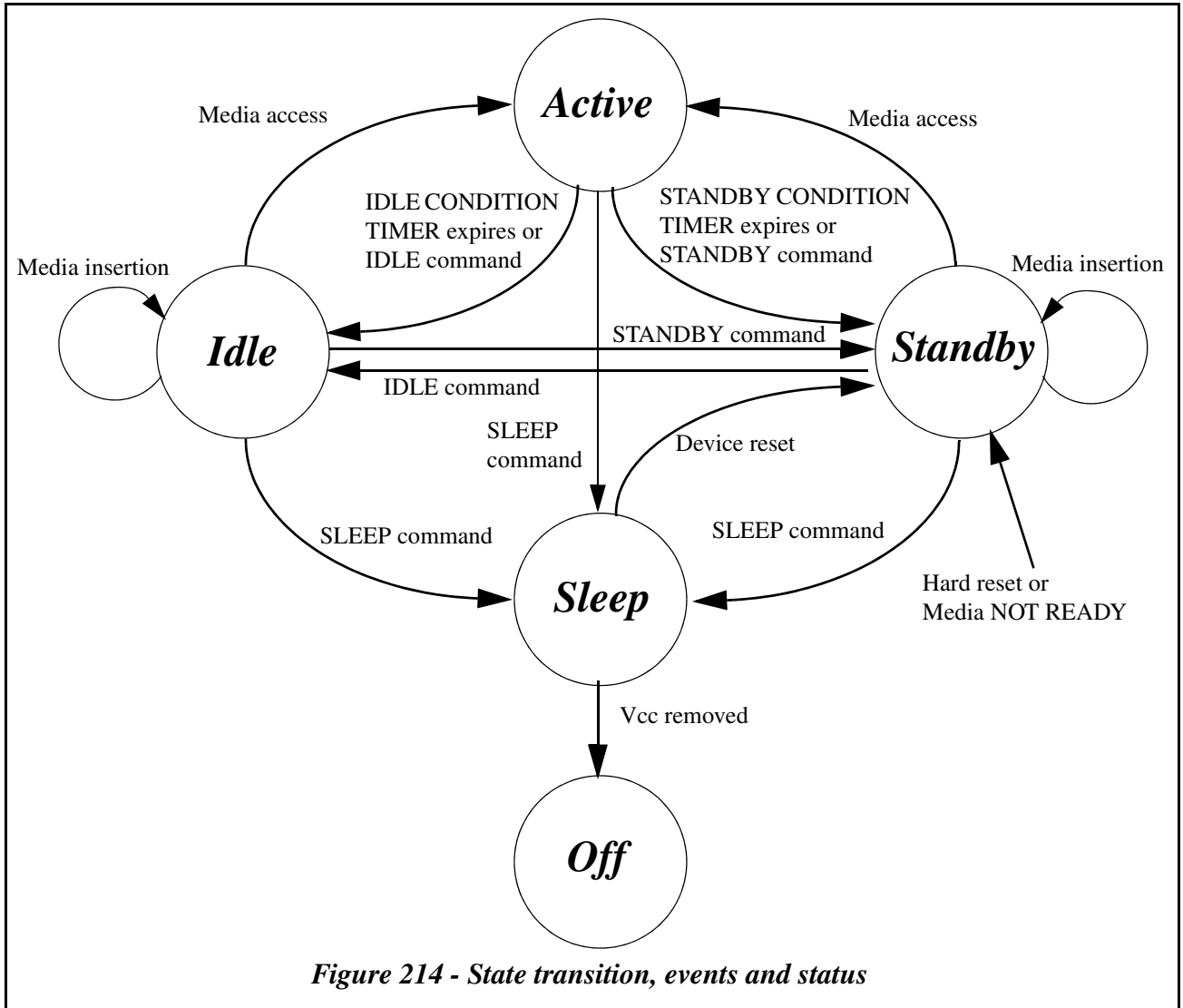


Table 297 - State transition, events and status

Initial State	Resultant State	Cause of Transition	Notification Class	Event
Active	Active	Unsuccessful IDLE, STANDBY, or SLEEP command	Power	PwrChg-Fail
	Idle	Successful completion of IDLE command	Power	PwrChg-Succ
	Idle	The expiration of IDLE CONDITION TIMER	Power	PwrChg-Succ
	Standby	Successful completion of STANDBY command	Power	PwrChg-Succ
	Standby	The expiration of STANDBY CONDITION TIMER, all buffers are empty	Power	PwrChg-Succ
	Sleep	Successful completion of SLEEP command	Power	PwrChg-Succ
Idle	Idle	Successful completion of an IDLE command	Power	PwrChg-Succ
	Idle	Insertion of media and ready to use	Media	NewMedia
	Standby	The expiration of STANDBY CONDITION TIMER, all buffers are empty	Power	PwrChg-Succ
	Standby	Successful completion of STANDBY command	Power	PwrChg-Succ
	Sleep	Successful completion of SLEEP command	Power	PwrChg-Succ
	Active	Reception of a command which reloads both timers	Power	PwrChg-Succ
Standby	Standby	Successful completion of STANDBY command	Power	PwrChg-Succ
	Standby	Insertion of media and ready to use	Media	NewMedia
	Idle	Successful completion of IDLE command	Power	PwrChg-Succ
	Sleep	Successful completion of SLEEP command	Power	PwrChg-Succ
	Active	Reception of a command which reloads both timers	Power	PwrChg-Succ
Any	Standby	A power-on, or hard reset occurred, or the logical unit becomes NOT READY	Power	PwrChg-Succ
Sleep	Standby	Device Reset	Power	PwrChg-Succ

13.1.2 Timers

The IDLE CONDITION TIMER and STANDBY CONDITION TIMER provide a method for the logical unit to enter lower power states after a host programmable period of inactivity, without direct host command.

A timer is deactivated (no longer used by the logical unit, regardless of Enable / Disable setting provided from the host) when the logical unit is in the associated power state or a lower power state.

A timer is both reactivated (the logical unit *shall* use the timer if enabled) and reloaded when a logical unit transitions to power state higher than the associated timer.

Timers *shall* be reloaded, as specified in Table 298, using the current timer value from the Power Condition mode page.

Timers *shall* be disabled/enabled as specified in the Power Condition mode page.

Timers *shall* be set to default conditions upon receiving a power-on, or hard reset. The default condition for the Timers *shall* be enabled with the values of the timers vendor specific.

13.1.2.1 STANDBY CONDITION TIMER

If the STANDBY CONDITION TIMER expires the logical unit *shall* attempt to flush all buffers.

If this operation fails, the logical unit *shall* remain in the current power state, and the STANDBY CONDITION TIMER is reloaded. If the flush succeeds, the logical unit *shall* enter the Standby State.

Table 298 - Effects of host actions on timers

host Action	Timer Effects	Comments
BLANK	Reload Both	Recordables only
CLOSE TRACK/SESSION	Reload Both	Recordables only
COMPARE	Reload Both	SCSI only
EXECUTE DRIVE DIAGNOSTIC	Reload Both	ATA command
FORMAT UNIT	Reload Both	Rewritable only
GET CONFIGURATION	None	
GET EVENT/STATUS NOTIFICATION	None	
GET PERFORMANCE	Reload Both	May need to access media
INQUIRY	None	
LOAD/UNLOAD MEDIUM	Reload Both	
LOCK/UNLOCK CACHE	None	SCSI only: A Lock Cache command <i>shall</i> prevent the logical unit from entering Standby or Sleep states.
LOG SELECT	None	SCSI only
LOG SENSE	None	SCSI only
MECHANISM STATUS	None	
MODE SELECT (10)	May reload timers	A MODE SELECT (10) command that changes the STANDBY CONDITION TIMER or IDLE CONDITION TIMER <i>shall</i> reload the timer.
MODE SENSE (10)	None	
PLAY AUDIO (10)	Reload Both	
PLAY AUDIO MSF	Reload Both	
PRE-FETCH	Reload Both	SCSI only
PREVENT ALLOW MEDIUM REMOVAL	Reload Standby	
READ (10) / READ (12)	Reload Both	
READ BUFFER	Reload Standby	
READ BUFFER CAPACITY	None	
READ CAPACITY	Reload Both	
READ CD	Reload Both	
READ CD MSF	Reload Both	
READ DISC INFORMATION	Reload Both	
READ DISC STRUCTURE	Reload Both	
READ FORMAT CAPACITIES	Reload Standby	
READ SUBCHANNEL	Reload Both	
READ TOC/PMA/ATIP	Reload Both	
READ TRACK INFORMATION	Reload Both	
RELEASE (10)	None	SCSI only
REPAIR RZONE	Reload Both	Sequential DVD Recordable
REPORT KEY	Reload Both	
REQUEST SENSE	None	
RESERVE (10)	None	SCSI only
RESERVE TRACK	Reload Both	Recordables only
SCAN	Reload Both	
SEEK	Reload Both	
SEND DISC STRUCTURE	Reload Both	Sequential DVD Recordable
SEND EVENT	Reload Both	May effect media access

Table 298 - Effects of host actions on timers (continued)

host Action	Timer Effects	Comments
SEND KEY	Reload Both	
SEND OPC INFORMATION	Reload Both	Recordables only
SET CD SPEED	Reload Both	
SET READ AHEAD	Reload Both	
SET STREAMING	Reload Both	
START STOP UNIT	See START STOP UNIT command	
STOP PLAY/SCAN	Reload Both	
SYNCHRONIZE CACHE (10)	Reload Both	
TEST UNIT READY	None	
VERIFY (10)	Reload Both	
WRITE (10) / WRITE (12)	Reload Both	Recordables only
WRITE AND VERIFY (10)	Reload Both	Recordables only
WRITE BUFFER	Reload Standby	
Device Reset	Reload Both	Reset operation, the logical unit <i>shall not</i> return to default timer conditions
Other commands	Vendor Specific	

13.1.3 Power management status reporting

The Power Status field of the GET EVENT/STATUS NOTIFICATION (Power Management Class) Event data *shall* report the current logical unit power state. This provides a mechanism for the host to query the current power state, irrespective of state transitions.

13.2 Interface Power management timer adjustment

The timer of Interface Power state transition may be adjusted according to the logical unit Power state. For example logical unit that is in the Active logical unit power state may use a longer time period to do the Interface Power state transition than others if Interface Power state transition from low power state to working state takes a long time.

14.0 Timeout and Reset models

14.1 Timeouts

Currently, it is difficult for an operating system to determine a correct timeout value to use when issuing commands to a logical unit. Specifically, in instances of commands that may take a long time complete, but usually complete in a relatively short time. An example would be a read command after the logical unit has entered a low power state, and the media *shall* spin up before completing the request. This model allows for a method for the logical unit to complete the request with an error that indicates to the host operating system that the request should be retried, but with a longer timeout.

The logical unit will specify up to three timeout parameters in the Timeout and Protect mode page. The first parameter is the minimum timeout that an operating system *shall* use for all commands in Group 1. The second parameter is the minimum timeout that an operating system *shall* use for all commands in Group 2. The third parameter is the maximum timeout for real-time stream recording/playback that the logical unit *shall* use for all commands in Group 3.

For commands in Group 1, the logical unit *shall* start an internal timer when the command is received. If the command is unable to complete before the time specified in the Group 1 Minimum Timeout field of the Timeout and Protect mode page, bytes 6 and 7, the logical unit may terminate the command, at any time before the Group 1 Timeout expires, with CHECK CONDITION status, 6/2E/00 INSUFFICIENT TIME FOR OPERATION. In addition, the logical unit *shall* set the command Specific Information sense bytes (Bytes 8-11) to the value in seconds that corresponds to the minimum timeout that the host should use when retrying this command. Upon receiving this CHECK CONDITION, the operating system *shall* retry the command with the requested timeout.

Note: A logical unit may return this CHECK CONDITION at any point after the command is received, it may even return prior to initiating command.

All commands in Group 2 are commands that may not be able to complete successfully if they are retried. Thus, the host *shall* ensure that it uses a timeout that is large enough to allow the command to complete under worst case scenarios. This timeout is specified by the logical unit in the Group 2 Minimum Timeout field of the Timeout and Protect mode page.

Group 3 is designed for real-time stream recording/playback. The logical unit *shall* terminate the command in Group 3 within specified Group 3 timeout duration. When timeout occurs, the logical unit *shall not* generate 6/2E/00 INSUFFICIENT TIME FOR OPERATION to expand working time. The logical unit *shall* terminate the command as defined by the command. The logical unit may terminate the command with CHECK CONDITION status and error code for a fatal error.

For a complete list of command groupings see Table 299.

Table 299 - NOT READY error and Timeout UNIT ATTENTION reporting (by command)

Command	Returns NOT READY status	Timeout	Comment
BLANK	Yes	Group 2	
CLOSE TRACK/SESSION	Yes	Group 2	Recordables only
COMPARE	Yes	Group 1	Not Defined in this specification
FORMAT UNIT	Yes	Group 2	
FORMAT UNIT (Immediate)	Yes	Not Allowed	
GET CONFIGURATION	No	Not Allowed	
GET EVENT/STATUS NOTIFICATION	No	Not Allowed	
GET PERFORMANCE	No	Group 1	
INQUIRY	No	Not Allowed	
LOAD/UNLOAD MEDIUM	No	Group 2	
LOG SELECT	No	Group 1	Not Defined in this specification
LOG SENSE	No	Group 1	Not Defined in this specification
MECHANISM STATUS	No	Group 1	
MODE SELECT (10)	No	Group 1	
MODE SENSE (10)	No	Group 1	
PAUSE/RESUME	Yes	Group 1	
PLAY AUDIO (10)	Yes	Group 1	
PLAY AUDIO MSF	Yes	Group 1	
PREVENT ALLOW MEDIUM REMOVAL	See Table 551 - <i>Actions for Lock/Unlock/Eject (Persistent bit = 0)</i> on page 706	Group 1	
READ (10)	Yes	Group 1	
READ (12) with Streaming = 0	Yes	Group 1	
READ (12) with Streaming = 1	Yes	Group 1 or Group 3 ^a	
READ BUFFER	No	Group 1	Not Defined in this specification
READ BUFFER CAPACITY	No	Group 1	
READ CAPACITY	Yes	Group 1	
READ CD	Yes	Group 1	
READ CD MSF	Yes	Group 1	
READ DISC INFORMATION	Yes	Group 1	
READ DISC STRUCTURE	Yes	Group 1	
READ FORMAT CAPACITIES	No	Group 1	
READ SUBCHANNEL	Yes	Group 1	
READ TOC/PMA/ATIP	Yes	Group 1	
READ TRACK INFORMATION	Yes	Group 1	
RECEIVE DIAGNOSTIC RESULTS	No	Not Allowed	Not Defined in this specification
RELEASE (10)	No	Not Allowed	Not Defined in this specification
REPAIR RZONE	Yes	Group 1	
REPORT KEY	Yes	Group 1	
REQUEST SENSE	No	Not Allowed	
RESERVE (10)	No	Not allowed	Not Defined in this specification
RESERVE TRACK	Yes	Group 2	Recordables only

Table 299 - NOT READY error and Timeout UNIT ATTENTION reporting (by command)

Command	Returns NOT READY status	Timeout	Comment
SCAN	Yes	Group 1	
SEEK	Yes	Group 1	
SEND DIAGNOSTIC	No	Not Allowed	Not Defined in this specification
SEND DISC STRUCTURE	No	Group 1	
SEND EVENT	Yes	Group 1	
SEND KEY	Yes	Group 1	
SEND OPC INFORMATION	No	Group 1	Recordables only
SET READ AHEAD	Yes	Group 1	
SET CD SPEED	No	Group 1	
SET STREAMING	Yes	Group 1	
START STOP UNIT	Yes	Group 1	
STOP PLAY/SCAN	Yes	Group 1	
SYNCHRONIZE CACHE (10)	Yes	Group 2	
TEST UNIT READY	Yes	Group 1	
VERIFY (10) with G3tout = 0	Yes	Group 2	
VERIFY (10) with G3tout = 1	Yes	Group 2 or Group 3 ^a	
WRITE (10)	Yes	Group 1	
WRITE (12) with Streaming = 0	Yes	Group 1	
WRITE (12) with Streaming = 1	Yes	Group 1 or Group 3 ^a	
WRITE AND VERIFY (10)	Yes	Group 1	
WRITE BUFFER	No	Group 1	

a. If the logical unit supports Group3 timeout and the G3Enable bit in Timeout and Protect mode page is set to 1, the command is categorized as Group 3 timeout. If the G3Enable bit is set to 0, this command is categorized as Group 1 timeout or Group 2 timeout.

Note: The references to “Not Defined in this specification” in the table are to indicate that these commands are currently defined in the SCSI SPC-2, SBC and MMC-2 standards. As these commands are not defined in this specification the usage and actual operation of these commands is specified elsewhere, their reference here are only recommendations to provide better compatibility.

Note: These recommendations are based on common transfer lengths. Long transfer lengths may affect timeouts.

14.1.1 Group 3 timeout for Real Time Stream recording/playback

To adjust application setting of real-time stream recording/playback to recover from fatal error, estimation of expected time length for the command is necessary. Section 9.3.3, "Fatal error recovery model with Group 3 timeout" on page 474. Group 3 timeout is assigned for this purpose. A logical unit *shall* terminate READ (12)/WRITE (12) command with Streaming = 1 and VERIFY (10) command with G3tout bit=1, within the expected time length defined as follows.

- Group 3 timeout duration = Group3 time unit × Ceil(Transfer length / Unit length) + trace time for requested sectors
Note: Ceil(x) returns the least integer value greater than or equal to x.
- Group 3 time unit: a unit for Group 3 timeout that correspond to read/write one sector
- Unit length: a unit of block length correspond to increase a unit of Group 3 time unit
- trace time: time to read/write blocks excluding access time and read/write time of the first sector.

Group 3 time unit value shows the maximum time of operation when the transfer length field is set to 1 and when Power state of the logical unit is Active state. In case of DVD-RAM, Group 3 time unit value should include Zone transition time.

The recommended value for Group 3 time unit is 1 to 5 seconds. The recommended value for Unit length is 256 sectors.

It is recommended that transfer length and verification length are set to smaller than the Unit length value. If the host uses transfer length less than the Unit length, the Group 3 timeout duration is almost same as the Group 3 time unit as follows: (in the case of DVD, 256 sectors is only 0.38 second at 1× speed.)

- Group 3 timeout duration = Group 3 time unit + trace time for requested sectors

Group 3 time unit *shall not* be changed by medium change. A logical unit may accept the value changed by the host. The host is able to find it from changeable value page of MODE SENSE (10) command.

Unit length is defined as media type specific. A logical unit may change the Unit length value according to the mounted media type.

Group 3 timeout duration of Group 3 timeout has following three exceptions.

- Exception 1: Initial OPC time
- Exception 2: Synchronize cache time
- Exception 3: Power state transition time to Active state

A host is able to control the occurrence of these exceptions by command (e.g., SEND OPC INFORMATION command, SYNCHRONIZE CACHE (10) command). The occurrence of these exceptions is rare case. The logical unit need not treat these exceptions as errors.

If Group 3 timeout is supported, G3tout bit of VERIFY (10) command *shall* be supported as described in 17.47, "VERIFY (10) command" on page 905.

14.1.2 Trace time for requested sectors

Group 3 time unit value shows the minimum time of operation when the transfer length field is set to 1. If transfer length is larger than 1, Group 3 timeout duration is increased to reflect the transfer length of the command. For example, in case of 1× CLV of DVD media, read operation takes 1,48 msec/sector. If Group 3 time value is 3 seconds and transfer length is 160, the Group 3 timeout duration is 3,24 second (= 3 + 0,001 48 × (160 - 1)).

The transfer length field value of usual READ (12)/WRITE (12) command is assumed 32 or less. The trace time for the requested sectors of usual READ (12)/WRITE (12) command is very small comparing with Group 3 time unit value.

14.1.3 Exception 1: Time for the initial OPC

Optimum Power Calibration before a write operation takes several seconds. When OPC is performed, a logical unit may expand the Group 3 timeout duration with extra time for the initial OPC. To avoid this exception, the host should issue SEND OPC INFORMATION command with DoOpc = 1.

- Group 3 timeout duration with OPC = time for the initial OPC + Group 3 timeout duration

A logical unit should not perform time consuming internal OPC (Subsequent OPC) except the initial OPC during real-time stream recording at the WRITE (12) command with Streaming=1. At WRITE (10)/WRITE (12) command with Streaming=0 and SEND OPC INFORMATION command with DoOpc = 1, the logical unit may perform the Subsequent OPC if necessary. The host may pause the real-time streaming recording and issue SEND OPC INFORMATION command with DoOpc = 1.

Reporting of CHECK CONDITION status, 2/04/08 LOGICAL UNIT NOT READY, LONG WRITE IN PROGRESS to avoid the timeout of WRITE (12) command with Streaming=1 due to insufficient buffer capacity may hide the Exception 1. However, it is not recommended to use this operation for the Subsequent OPC.

14.1.4 Exception 2: Synchronize cache time

If a logical unit has write data in buffer, when the logical unit receives READ (12) command with Streaming=1 or VERIFY (10) command with G3tout=1, the logical unit *shall* write the data in buffer. Then the logical unit *shall* read

the specified blocks. In this case, additional Group 3 timeout duration for synchronize cache is added to the Group 3 timeout duration for READ (12) command with Streaming=1 and VERIFY (10) command with G3tout=1.

- Expected time for synchronize cache = Group 3 time unit + time to synchronize the buffered data
- Group 3 timeout duration with synchronize cache = Expected time for synchronize cache + Group 3 timeout duration

A host is able to assume the Group 3 timeout duration for synchronize cache via READ BUFFER CAPACITY command. For example, if a logical unit has 2 Mbytes buffer, the logical unit may have about 60 ECC blocks of write data in buffer. In case of 1× CLV of DVD media, if Group 3 time value is 3 seconds, the expected time for synchronize cache is 4,42 seconds (= 3 + 0,001 48 × (960 - 1)).

To avoid this exception, a host should issue SYNCHRONIZE CACHE (10) command.

The logical unit *shall* report the buffer size by Length of Buffer field of Table 563 - *READ BUFFER CAPACITY data when Block bit of CDB = 0* on page 715 if Group3 bit in the Timeout Feature (0105h) is set to 1 and the Timeout Feature (0105h) is current.

14.1.5 Exception 3: Power state transition time to Active state

When a logical unit is in Idle state or Standby state, the logical unit needs a few seconds to be Active state before a operation. When Power state transition is performed, the logical unit may exceed Group 3 timeout duration with extra time for the Power state transition.

- Group 3 timeout duration with Power state transition = time for the Power state transition + Group 3 timeout duration

To avoid this exception, a host should issue START STOP UNIT command with Start = 1, LoEj = 0 and Power Condition = 0.

14.1.6 Relationship between Group 3 time unit and Unit length

The Group 3 timeout duration of the command termination is increased by Group 3 time unit when the transfer block length is increased by Unit length as shown in Figure 215. Because changing Group 3 time unit causes big direct impact to host software, the Group 3 time unit value *shall not* be changed by medium change. If adjustment of the Group 3 timeout duration of the command termination time on different media is necessary, different Unit length value for different media *shall* be used.

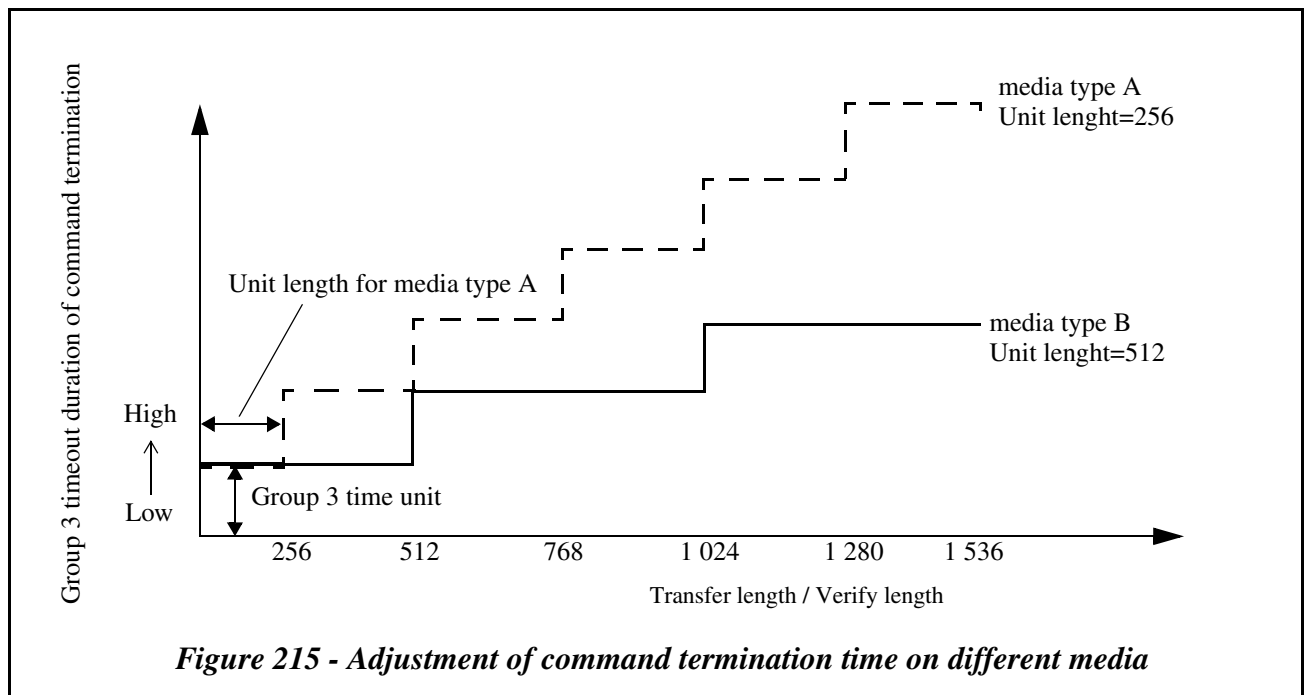


Figure 215 - Adjustment of command termination time on different media

14.1.7 Recommended Timeout value handling

The Group 1 Minimum Timeout field, the Group 2 Minimum Timeout field and the Group 3 Time unit field in the Timeout and Protect mode page may not be changeable. Even if the field is changeable, a logical unit may round up the host specified value, because the logical unit may have its own minimum time to perform retry in a command. The host should check whether these fields are changeable or not by issuing MODE SENSE (10) command with Changeable Value of PC field prior to issue MODE SELECT (10) command. Also the host should check whether the selected value is accepted by issuing MODE SENSE (10) command with Current value after the MODE SELECT (10) command.

14.2 Reset model

Within this specification there are three resets defined. These resets are named:

- Power On Reset
- Hard Reset
- Device Reset

These resets are used differently in each physical interface used. For more information on the use in ATA/ATAPI and SCSI see the sections on implementation notes.

14.2.1 Power On Reset

When power is applied, the logical unit performs a series of electrical circuitry diagnostics, resets logical unit specific parameters (mode pages) to default values, and if media is present, may spin up and make the logical unit ready for use. In addition, power management and key management are reset to their default states.

14.2.2 Hard Reset

For each physical interface the detection of Hard Reset is different. The detection of Hard Reset for ATA/ATAPI and SCSI is defined in the implementation sections of this specification. The logical unit performs a series of electrical circuitry diagnostics, resets logical unit specific parameters (mode pages) to default values, and if media is present, may spin up and make the logical unit ready for use. In addition, power management and key management are reset to their default states. The behavior of the logical unit when Hard Reset is received is the same as for Power On Reset.

Hard Reset is used to reset devices or even a whole interface bus, not individual logical units.

14.2.3 Device Reset

For each physical interface, the detection of Device Reset is different. The detection of Device Reset for ATA/ATAPI and SCSI is defined in the implementation sections of this specification. The Device Reset is used to bring a hung logical unit into a operable state. Device Reset is different from Power On or hard Reset. With the Device Reset the parameters being used by the logical unit are not set to the defaults. In some cases this may not be possible and the logical unit may need to reset to the default conditions. If a reset to default conditions occurs as a result of a Device Reset, a UNIT ATTENTION and Power Management Class Event Notification *shall* be generated. Logical unit should:

- Reset host interface circuitry.
- Perform hardware initialization and device-internal diagnostics only if necessary.
- Do not revert to default conditions, including ATAPI master/slave address, SCSI Device Number, logical unit Number or TOC information.
- If not in Sleep State, stay in the current Power State.
- Persistent Prevent state is unchanged.
- Key management *shall* be reset to the default state.

14.2.4 Mapping of reset functions

The Table 300 shows how the different reset functions specified in the various ATAPI and SCSI specifications are used in this specification.

Note: This table is not intended to show all possible resets or their mapping.

Table 300 - Example Reset Function Mapping in ATAPI and SCSI

Reset Type	ATAPI	SCSI
Power-On Reset	Same as Power-On Reset	Same as Power-On Reset
Hard Reset	Hard Reset, Reset-bus signal	TARGET RESET task management function
		SPI Reset Signal
Interface Reset	ATA SRST. This is a channel reset. The same behavior as Hard Reset is also possible. However the SRST <i>shall not</i> reset any mode parameters to the default state.	SAM Reset events. This is SCSI protocol dependent
Device Reset	Device Reset in ATA/ATAPI-4	ABORT TASK SET task management function
	ATAPI Soft Reset in SFF8020i (expired)	CLEAR TASK SET task management function

15.0 Features

Features are sets of commands, mode pages, and behaviors or operations specified for a logical unit. Each Feature *shall* be implemented entirely to its standard description in order to claim compliance with the Feature. Except as explicitly identified, all commands, mode pages, and behaviors within a Feature are mandatory.

Features were designed primarily to support multi-function logical units that could only function as one logical unit at a time, e.g., DVD-RAM logical units act as either a DVD-RAM or DVD-ROM depending on the medium. Virtually all removable medium logical units are in effect multi-function logical units: they can use their medium when present, but cannot perform any media operations when no medium is present.

Mode pages described and required by Features *shall* be present if the Feature is reported by the logical unit, regardless of whether or not the Feature is current. For example, the CD Audio Control mode page *shall* be available for reading and writing if the CD Audio analog play Feature is supported by the logical unit, even if no audio media is present. The current values and changeable masks *shall not* change, even across morphing. Default values may change when morphing occurs. Default values *shall* reflect a usable set of values for the loaded medium. Changes to the default values *shall not* generate a UNIT ATTENTION condition.

The use of Features allows generic host drivers to use logical units that have among their many Features some core functionality. For example, the Random Readable Feature may be reported by a very large variety of logical units: magnetic disk, CD, DVD, HD DVD or Magneto-Optical. A common driver to read data would be usable with all of these logical units; special code would be needed only to manage extensions unique to each technology.

Features implemented by a logical unit are reported to the host via the GET CONFIGURATION command. This command should be used to identify all possible Features, and those Features that are current. A Feature *shall not* be current if any of its mandatory commands or behaviors are not available. For example, a logical unit with writable media loaded and a mechanical write protect active *shall not* report any writable Features as available. A DVD read-only logical unit with a non-CSS/CPM-protected DVD-ROM loaded *shall not* report the DVD CSS Feature as being available. A logical unit with no medium present *shall* have no read or write or other medium dependent Features active. Commands within a Feature that is not current may still operate normally, especially when those commands are described in more than one Feature.

The introduction of Features are not intended to change logical unit behavior. The use of commands that are not current will generate the same errors as legacy logical units. Features simply provide a method for avoiding errors and avoids using errors to convey state information. When Features are used properly by the host, the host should see only true medium errors and not need to do any informational discovery through error codes.

This specification also specifies techniques for the logical unit to notify the host of changes in the list of current Features. In addition, a technique for preventing changes until host approval is granted is defined. The GET EVENT/STATUS NOTIFICATION command is used for notification of changes or change requests; the PREVENT ALLOW MEDIUM REMOVAL (Persistent) and SEND EVENT commands are used to notify the logical unit of a host control request and for the host to notify the logical unit of permission to change.

For a Feature to be considered current, all commands and behaviors described by that Feature should be available to the host. Even if a Feature is not current, its components should function if appropriate for the logical unit's state. Commands received by a logical unit that are a member of a supported Feature that is not current *shall* either perform normally or return an appropriate error (e.g., incompatible medium, medium not present). Logical units *shall not* terminate any command that is a member of any supported Feature with an INVALID COMMAND OPERATION CODE Error. For example, if the Formattable Feature is implemented, the READ FORMAT CAPACITIES command should return valid data regardless of whether or not the Formattable Feature is Current. An attempt to format a medium that cannot be formatted by the logical unit may return CHECK CONDITION status, 5/30/06 CANNOT FORMAT MEDIUM - INCOMPATIBLE MEDIUM.

Each Feature Descriptor may contain information specific to that Feature. The Feature specific information in the Feature Descriptor may not be valid if the Feature is not current.

Commands, Pages, and behavior not described by a Feature may exist in the logical unit.

See 17.4, "GET CONFIGURATION command" on page 559 for more information on the individual Features.

15.1 Implementation of Features

15.1.1 What's a Feature?

This specification introduces Features. Features were designed to be atomic units of functionality. On the first level, Features are only a description in a document. Traditional drivers work without modification with logical units that implement Features. Features were a part of the documentation in SFF-8020i (expired), SFF-8090 rev. 1.0 (expired), and MMC; however they were not comprehensive, typically documenting only optional behavior. This specification associates all normal functionality with Features. Detection of a whole group of functions (a “Feature”) was typically accomplished by the host by issuing a command unique to that Feature and examining the completion status of that command.

The SFFC and T10 (MMC) groups have been consciously trying to avoid using errors as a method for status detection. Error handling code is typically one of the more complex parts of implementing drivers; reducing the number of cases that need to be handled helps implementations by reserving error status for only true errors. Status information is reported via explicit status reporting commands such as GET EVENT/STATUS NOTIFICATION and GET CONFIGURATION.

The descriptions of Features in this specification appear complex, and they are. However, these descriptions describe almost nothing new; they are simply the descriptions of existing legacy behavior. The only new parts are the descriptors themselves, which are either static identification blocks or groups of information that the logical unit *shall* already have to operate, even in a legacy behavior. For example, a logical unit *shall* internally identify whether or not a PLAY AUDIO (10) command may succeed; Features are simply a way to let the host in on the secret.

Previously, new logical units had to make a choice: to look completely like an old logical unit with added functionality, or as a new logical unit not compatible with old drivers. Feature and Profiles, a host can first determine if the “right” driver is available by examining the profiles. If “the” right driver isn’t available, the host can identify operable subsets when multiple profiles are reported. Finally, the host can identify basic functions to use the logical unit via the Feature reporting.

15.1.2 History

The separation of status and error reporting is very important in multitasking environments. Typically, the operating system needs to constantly be aware of the status of the logical unit. Various applications, operating through a variety of OS interfaces, may also need to be aware of logical unit status. Reporting of status via errors breaks down in this environment; only one process is made aware of state changes via the error, while other processes cannot obtain the same state information because the error (status change) has already been reported to the host (according to the logical unit).

Features **do not** replace legacy behavior. Features, in most cases, define a subset of legacy behavior. Several Features, taken together, are generally equivalent to legacy logical units of the same type. Error and status reporting in legacy host environments is the same as legacy logical units, without any special mode setting.

The Features described in this specification add something new: reporting. Legacy logical units, while implementing the content of the Features, did not have any mechanism to report specifically the logical unit’s capabilities. The closest mechanism that has existed is a command that reported implemented commands. Implemented mode pages are also reportable via standard mechanisms. However, a command is more than an Operation Code (opcode). A whole set of commands, mode pages, and behavior needs to be grouped together to be useful. For example, write once MO, hard disk drives, and CD-R all use the WRITE (10) command, but it is impossible to use the same strategies for writing these three media. Typically, different drivers or fragments or drivers are used for each kind of media. The previous mechanism would only identify that the WRITE (10) command was implemented, but could not identify how to use it.

The capabilities of a particular logical unit may change at arbitrary times. The most common example of this is seen in a removable medium logical unit. Even a basic removable magnetic medium logical unit changes: from a random read/write logical unit to a virtually functionless logical unit when the medium is removed. Multi-function logical units can change their behavior even more radically when they accept a variety of physical and logical formats.

Before Features, hosts had to use a trial and error method for determining what would or would not function. Medium codes became outdated even before publication of the relevant standard, and still were not adequate to describe all media.

The Profiles, also introduced in this specification, provide an equivalent to the medium type. However, the profile does not indicate exact capabilities for the drive/medium system, only a generic identification of core capabilities.

Feature reporting is not completely new. Operating systems first identify a driver via the device type. The device type implied a core set of functions (e.g., a CD-ROM logical unit would support READ (10), READ TOC/PMA/ATIP). However, even these commands would not work if no medium were loaded. A driver would determine media status by trying a few commands and examining the error codes. After determining that media was present, a driver would have to probe to find out about additional Features such as audio or medium changers. Features were “reportable,” but each Feature had a different mechanism, and many of the mechanisms relied on the success or failure of special “key” commands.

15.1.3 Implementation of Features

There are only two requirements to fully implement Features. The first is the GET CONFIGURATION command. This command is a very basic reporting command that reports some very static information; only a few Features have any dynamic fields; most Features have only one bit that changes. The command is a form of Inquiry: a technique for the host to identify the logical unit on the bus. The GET CONFIGURATION command simply provides more detail, and the information reported is expected to be dynamic.

Implementation of Feature reporting via the GET CONFIGURATION command is simple: the image of the result data can be copied from logical unit ROM to its buffer, a few fields set with information already known to the logical unit (such as the block size), and a few bits set according to already existing flags in the firmware (e.g., DVD vs. CD, audio tracks present). Logical units with non-removable media may have a completely static image that is reported. If a starting point other than the beginning is requested, the logical unit walks the table to find the first requested Feature, subtracts the offset from the data length, and transfers data starting at the same offset.

The second part of Features is reporting when the Features change. As it is important for the host to know what operations will function with the logical unit at any given moment, pre-emptive reporting of Feature changes greatly eases host implementations by reducing the number of error conditions that *shall* be handled. The GET EVENT/STATUS NOTIFICATION command is used for status change reporting (an “Event.”) In many drives, implementation simply requires recording an event whenever a UNIT ATTENTION is generated.

As mentioned earlier, Features are not new; their reporting is. This reporting has become very important in modern environments. Multiple drivers are talking to the same logical unit, doing different tasks. For example, a DVD read-only logical unit may use the basic CD-ROM driver when a CD is installed, and another driver when a DVD is installed, and both a basic DVD driver and a separate copy protection process when copy protected media is mounted. All of these processes *shall* interact well to provide seamless and solid support. Feature reporting provides a method for clean interaction.

15.1.4 Compatibility

Logical units implementing Feature reporting are fully compatible with legacy systems.

The GET CONFIGURATION command changes no behavior of the logical unit; it simply reports existing state information. Repeated GET CONFIGURATION commands will report the same information (unless the user inserts or removes the medium, etc.). The GET CONFIGURATION command never changes any state information in the logical unit, including UNIT ATTENTION conditions.

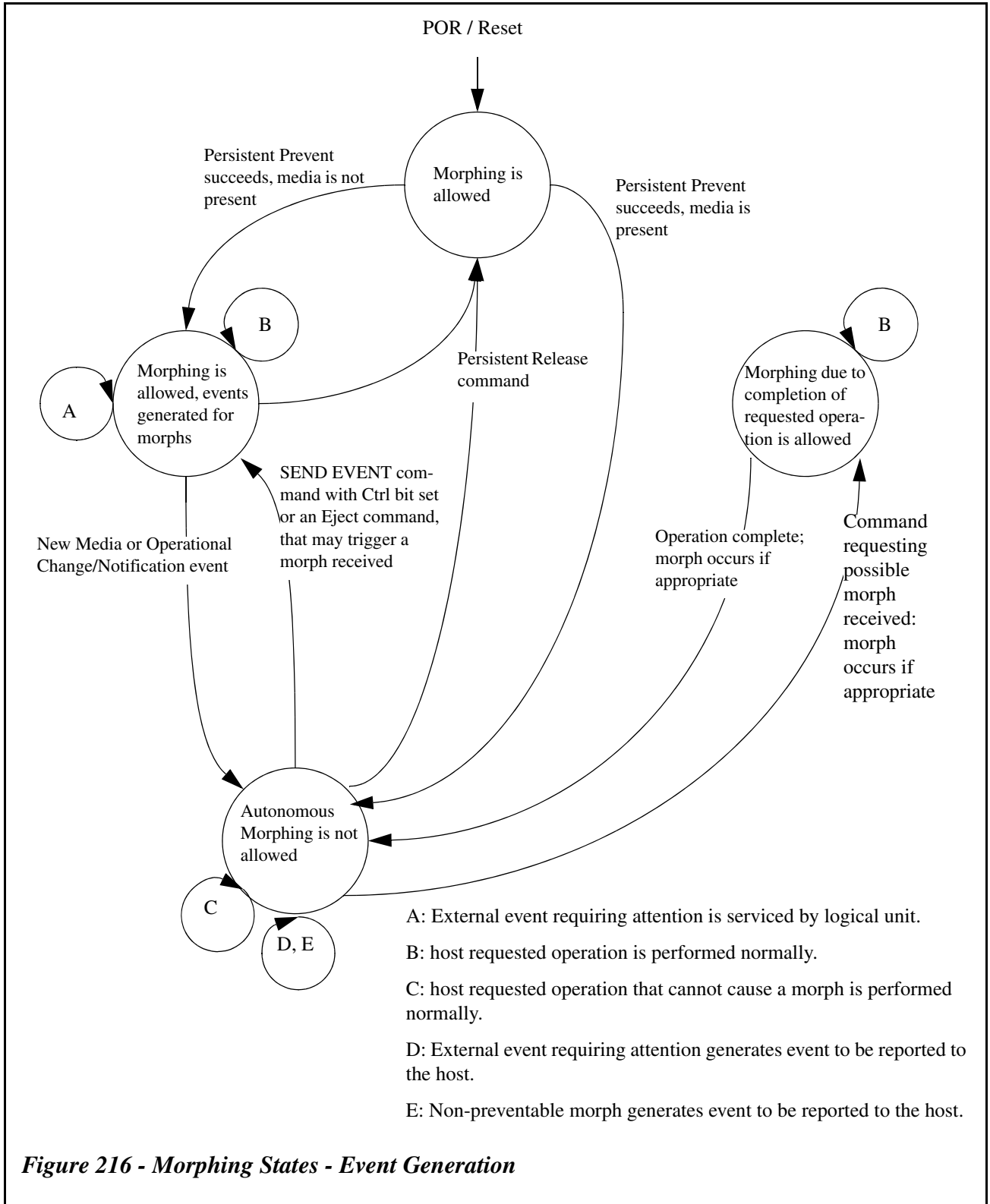
15.1.5 Summary

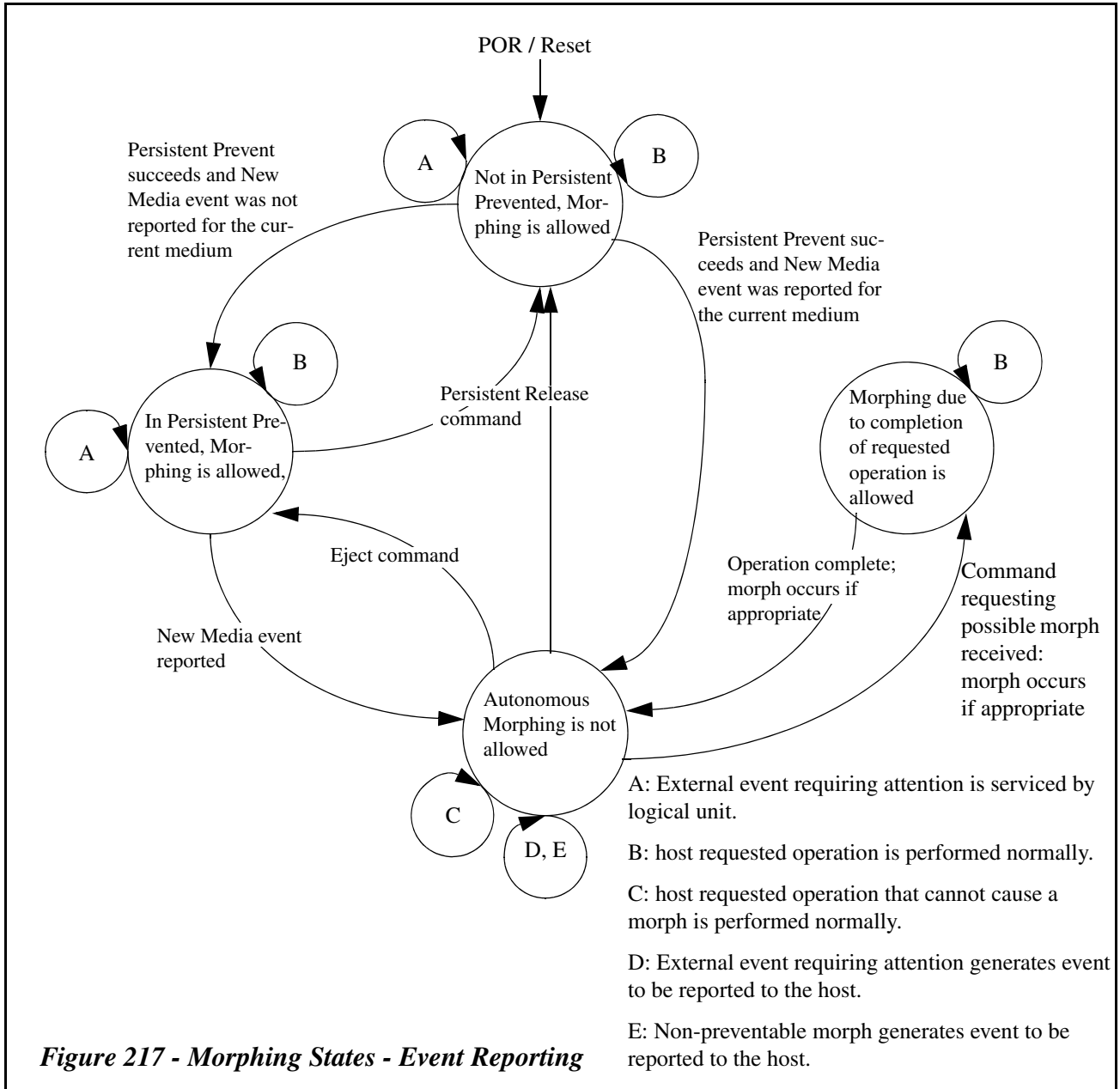
Features do not radically modify any legacy behavior or functionality. The only new parts involve reporting of behavior, and typically reflect state information already required of any firmware implementation, via two new commands. One command reports status, and the other notifies the host that the status may have changed.

The benefits include easier coding of highly robust drivers, fewer error conditions, and forward and backward compatibility with operating system drivers.

15.2 Morphing commands and functionality

The GET CONFIGURATION command is used to discover a logical unit's behavior. The result data of the GET CONFIGURATION command may be dynamic. A Morph occurs whenever the data that would be returned to a GET CONFIGURATION command changes. Figure 216 shows a state diagram for logical units that lock the tray when the NewMedia Event is generated. Figure 217 shows a state diagram for logical units that lock the tray when the NewMedia Event is reported.





15.2.1 Morphing operation

The host may issue a PREVENT ALLOW MEDIUM REMOVAL command with the Persistent, Prevent bit set to indicate to the logical unit that it **shall not** change its behavior without host notification for any preventable action. This will, for example, prevent any front panel buttons from causing an eject, play, or other operation that affects logical unit operation.

When the Persistent Prevent state is entered, the media **shall** remain locked in the logical unit and the logical unit **shall not** change its behavior, until the host issues an eject request, or a power on or hard reset condition occurs. The Persistent Prevent state **shall** be maintained after the eject request. New media that is inserted into the logical unit **shall** be locked in the logical unit after the logical unit generates or reports the NewMedia event. Prior to generating or reporting the NewMedia event, the logical unit may eject media without an explicit eject command from the host. This allows the user to remove incorrectly inserted media without having to wait for host intervention. In this condition neither the NewMedia

event nor the EjectRequest event should be reported by the logical unit. Locking the tray after generating the event allows for a simpler implementation; locking the tray after reporting the event allows a longer window of direct user intervention.

While in the Persistent Prevent state, the logical unit *shall* generate Events upon receipt of a User Eject request. The logical unit *shall not* eject the media on receipt of these requests, if the logical unit has already reported a NewMedia event for this media. If a logical unit allows an eject between generating and reporting the NewMedia event, the logical unit *shall* remove the NewMedia event(s) from the Event queue. When the host receives the Eject Request, and determines that it is safe to eject the medium, a START STOP UNIT command with the LoEj bit set will be issued, at which time the logical unit *shall* eject the medium. The Persistent Prevent state *shall* be retained.

While the logical unit is not in the Persistent Prevent state but the logical unit is locked state (Persistent=0 and Prevent=1), the logical unit should generate EjectRequest Events upon receipt of a User Eject request. Because this scheme was not described clearly in MMC-5 and Mt. Fuji Ver. 6, legacy logical unit may not generate EjectRequest Events upon receipt of a User Eject request. It is recommended that if a host wants to receive the EjectRequest event, the host sets the logical unit in the Persistent Prevent state.

In the Polling Mode of Event Notification, the host *shall* repeatedly issue GET EVENT/STATUS NOTIFICATION commands with an Immediate bit of 1. The interval should be sufficiently short to provide quick user feedback but long enough to avoid performance impacts within the system. The logical unit *shall* complete these commands upon receipt, supplying the host with information on the most recent event occurrences, as described in the GET EVENT/STATUS NOTIFICATION command.

If command queuing is supported, the host may issue a GET EVENT/STATUS NOTIFICATION command with an immediate (Immed) bit of 0. This is the Asynchronous mode of operation. The command *shall not* complete until an event occurrence of the class(es) requested is either in the event queue or occurs.

The logical unit *shall* maintain a separate queue for each class of Event Notification(s) supported. There *shall* be one set of queues per host. Events that are generated *shall* be placed at the tail of the event queue(s). The depth of the queue(s) is vendor specific, although it *shall* be at least one. If an overflow occurs, the logical unit *shall* maintain the most recent Events in the queue. All event classes other than External Request Class were designed such that a queue depth of 1 is sufficient.

Each GET EVENT/STATUS NOTIFICATION command *shall* report only one event. If multiple Event Classes are requested and multiple events are available, the logical unit *shall* report the Event in the Event Class with the lowest Notification Class ordinal.

15.2.2 Morphing compatibility considerations

To maintain compatibility with existing BIOS implementations and operating systems, the logical unit *shall* default to Persistent Prevent disabled. When the host enables the support using the PREVENT ALLOW MEDIUM REMOVAL command, the logical unit *shall* respond as described in this specification. When the host disables this Feature, the logical unit *shall* default to normal operating modes. A power on or hard reset *shall* cause the logical unit to clear the Persistent Prevent state.

If the logical unit is unable to maintain media status information across a reset or power cycle, the logical unit *shall* generate a NewMedia event.

Commands *shall* be processed exactly the same as they would be if Persistent Prevent was not enabled. For compatibility reasons, UNIT ATTENTION conditions *shall* still be returned. However, the logical unit *shall not* return the UNIT ATTENTION condition on a GET EVENT/STATUS NOTIFICATION command. For example, if the user inserts a new medium and the logical unit is accessed with a command, the CHECK CONDITION status with UNIT ATTENTION *shall* be reported, but the logical unit *shall* also report the NewMedia Event with the next available GET EVENT/STATUS NOTIFICATION (Media Status) command. If the GET EVENT/STATUS NOTIFICATION command is received after a UNIT ATTENTION condition is generated, and before it is reported to the host, the GET EVENT/STATUS NOTIFICATION command *shall* report the Event.

Regardless of the Persistent Prevent condition, if the logical unit is locked state, the logical unit should generate EjectRequest Events upon receipt of a User Eject request. The Event will be reported by the next GET EVENT/STATUS NOTIFICATION command.

15.3 Vendor Unique

All Vendor Unique Features *shall* be a multiple of 4 bytes in length. Use of Reserved fields in the Feature Descriptor Header is prohibited. Vendors are encouraged to take steps to choose a Feature number unique among all products.

The logical unit's Vendor ID and Product ID *shall* be used to qualify which set of Vendor Unique Features may be available.

15.4 Delayed Feature reporting

The Current bit status of the Features listed below may not be reported at medium insertion and may be reported later.

- Incremental Streaming Writable Feature (0021h)
- Restricted Overwrite Feature (0026h)
- CD Track at Once Feature (002Dh)

At the medium insertion, the logical unit *shall* check the Write Method of the Track field in the Track Descriptor Blocks of the first and last Tracks in the last Session. For possible Features of other Tracks are not reported unless READ TRACK INFORMATION command, READ (10)/READ (12) command or WRITE (10)/WRITE (12) command is issued to the Track.

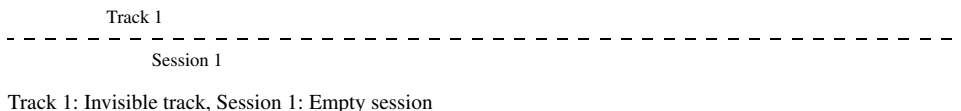
An ordinary writing software uses the last Invisible/Incomplete Track on the disc to record data. Fixed packet writing software uses only one Track and one Session on the CD-RW disc. Variable packet writing software uses Empty reserved Track at the first Track in the last Session. Therefore, checking of the first Track and the last Track in the last Session is enough to detect available recording Features (Incremental Streaming Writable Feature, Restricted Overwrite Feature or CD Track at Once Feature) on the CD-R/-RW disc correctly.

When a new Feature becomes current, if the logical unit supports Operational Change Request/Notification Class Event, the Operational Change Request/Notification Class Event *shall* be reported after the command is completed.

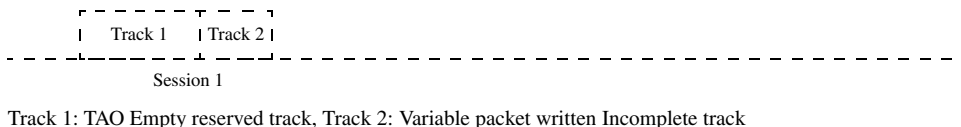
In the case of the other Features related to CD media, the delayed Feature reporting is not occurred. For example,

- CD Read Feature is determined by TOC information.
- CD Mastering Feature is determined by the last Session status.
- Audio Track is not allowed to reserve. So CD Audio analog play Feature is determined by reading of PMA.
- Random Readable Feature is determined by the checking of the disc status.

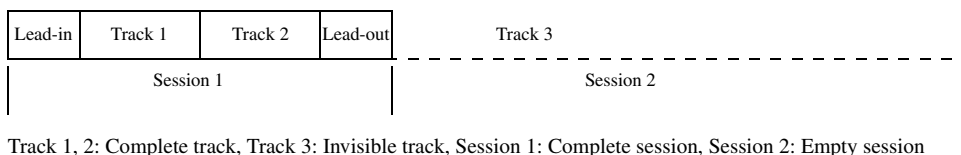
Case-(a) Insertion of Blank medium



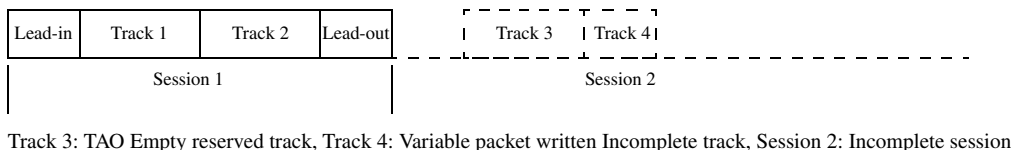
Case-(b) Track 2 is written



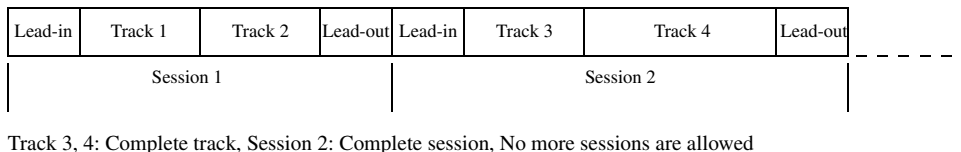
Case-(c) Session 1 is closed



Case-(d) Track 4 is written



Case-(e) Disc final close



Feature	Current bit status of the Feature for each Case					comment
	a	b	c	d	e	
Random Readable	0	1	1	1	1	If sector is written and readable, Current bit is set to 1.
CD Read	0	0	1	1	1	If disc is compatible with ROM media, Current bit is set to 1.
Incremental Streaming Writable	1	1	1	1	0	If Packet writing is available, Current bit is set to 1.
CD Track at Once	1	1	1	1	0	If TAO writing is available, Current bit is set to 1.
CD Mastering	1	0	1	0	0	If SAO writing is available, Current bit is set to 1.

	Case				
	a	b	c	d	e
First Track number of the last session	1	1	3	3	3
Last Track number of the last session	1	2	3	4	4

Figure 218 - Example of CD-R/-RW Feature reporting

16.0 Profiles

Profiles define a base set of functions for logical units. Logical units that list a Profile as current *shall* support all Features required by that Profile, but not all Features may be current. Logical units may support Features in addition to those required by the Profile. A single logical unit may implement more than one Profile, and more than one Profile may be active at any given time. All required Features may not be current, depending on the medium installed. If a NOT READY response would be given to a TEST UNIT READY command, no Profile should be current.

For example, a logical unit with unformatted media may not be able to read or write, and the corresponding Features would not be current, but the Profile corresponding to the logical unit/media system may be current. i.e. a DVD-RAM drive with unformatted media loaded may claim compliance to the DVD-RAM Profile; A DVD-RAM drive with no media loaded *shall* claim no Profile as current.

A Profile *shall* have Core Feature, Morphing Feature, Removable Medium Feature and Power Management Feature.

16.1 Profile 0001h: Obsolete (Non-removable disk)

The Non-removable disk Profile is obsolete.

16.2 Profile 0002h: Removable disk

Logical units identifying Profile 2 as current *shall* support the Features listed in Table 301:

Table 301 - Mandatory Features for Removable Disks

Feature Number	Feature Name	Description
0000h	Profile List	A list of all Profiles supported by the logical unit
0001h	Core	Mandatory behavior for all logical units
0002h	Morphing	Ability to notify host about operational changes and accept host requests to prevent operational changes.
0003h	Removable Medium	The medium may be removed from the logical unit
0010h	Random Readable, PP = 1	Read ability for storage logical units with random addressing.
0020h	Random Writable	Write support for randomly addressed writes
0023h	Formattable	Support for formatting of media
0024h	Hardware Defect Management	Ability of the drive/media system to provide an apparently defect-free space
0100h	Power Management	host and logical unit directed power management
0105h	Timeout	Ability to respond to all commands within a specific time

16.3 Profile 0003h: Obsolete (MO Erasable)

The MO Erasable Profile is obsolete.

16.4 Profile 0004h: Obsolete (MO Write Once)

The MO Write Once Profile is obsolete.

16.5 Profile 0005h: Obsolete (AS-MO)

The ASMO Profile is obsolete.

16.6 Profile 0008h: CD-ROM

Logical units identifying Profile 8 as current *shall* support the Features listed in Table 302:

Table 302 - Mandatory features for CD-ROM

Feature Number	Feature Name	Description
0000h	Profile List	A list of all Profiles supported by the logical unit
0001h	Core	Mandatory behavior for all logical units
0002h	Morphing	Ability to notify host about operational changes and accept host requests to prevent operational changes.
0003h	Removable Medium	The medium may be removed from the logical unit
0010h	Random Readable, PP = 1	Read ability for storage logical units with random addressing.
001Eh	CD Read	The ability to read CD-specific structures
0100h	Power Management	host and logical unit directed power management
0105h	Timeout	Ability to respond to all commands within a specific time

16.7 Profile 0009h: CD-R

Logical units identifying Profile 9 as current *shall* support the Features listed in Table 303:

Table 303 - Mandatory features for CD-R

Feature Number	Feature Name	Description
0000h	Profile List	A list of all Profiles supported by the logical unit
0001h	Core	Mandatory behavior for all logical units
0002h	Morphing	Ability to notify host about operational changes and accept host requests to prevent operational changes.
0003h	Removable Medium	The medium may be removed from the logical unit
0010h	Random Readable, PP = 1	Read ability for storage logical units with random addressing
001Eh	CD Read	The ability to read CD-specific structures
0021h	Incremental Streaming Writable	Write support for sequential recording
002Dh	CD Track at Once	Ability to write CD with Track at Once recording
0100h	Power Management	host and logical unit directed power management
0105h	Timeout	Ability to respond to all commands within a specific time
0107h	Real-Time Streaming	Ability to read and write using host requested performance parameters

16.8 Profile 000Ah: CD-RW

Logical units identifying Profile Ah as current *shall* support the Features listed in Table 304:

Table 304 - Mandatory features for CD-RW

Feature Number	Feature Name	Description
0000h	Profile List	A list of all Profiles supported by the logical unit
0001h	Core	Mandatory behavior for all logical units
0002h	Morphing	The logical unit changes its operational behavior due to events external to the host
0003h	Removable Medium	The medium may be removed from the logical unit
0010h	Random Readable, PP = 1	Read ability for storage logical units with random addressing
001Dh	MultiRead	The logical unit complies with OSTA MultiRead
001Eh	CD Read	The ability to read CD-specific structures
0021h	Incremental Streaming Writable	Write support for sequential recording
0023h	Formattable	Support for formatting of media
0026h	Restricted Overwrite	Write support for media that <i>shall</i> be written in multiples of logical blocks
002Dh	CD Track at Once	Ability to write CD with Track at Once recording
0100h	Power Management	host and logical unit directed power management
0105h	Timeout	Ability to respond to all commands within a specific time
0107h	Real-Time Streaming	Ability to read and write using host requested performance parameters

16.9 Profile 0010h: DVD-ROM

Logical units identifying Profile 10h as current *shall* support the Features listed in Table 305.

Table 305 - Mandatory Features for DVD-ROM

Feature Number	Feature Name	Description
0000h	Profile List	A list of all Profiles supported by the logical unit
0001h	Core	Mandatory behavior for all logical units
0002h	Morphing	The logical unit changes its operational behavior due to events external to the host
0003h	Removable Medium	The medium may be removed from the logical unit
0010h	Random Readable, PP = 1	Read ability for storage logical units with random addressing
001Fh	DVD Read	The ability to read DVD specific structures
0100h	Power Management	host and logical unit directed power management
0105h	Timeout	Ability to respond to all commands within a specific time
0107h	Real-Time Streaming	Ability to read using host requested performance parameters

16.10 Profile 0011h: DVD-R Sequential recording

Logical units identifying Profile 11h as current *shall* support the Features listed in Table 306:

Table 306 - Mandatory Features for DVD-R Sequential recording

Feature Number	Feature Name	Description
0000h	Profile List	A list of all Profiles supported by the logical unit
0001h	Core	Mandatory behavior for all logical units
0002h	Morphing	The logical unit changes its operational behavior due to events external to the host
0003h	Removable Medium	The medium may be removed from the logical unit
0010h	Random Readable, PP = 1	Read ability for storage logical units with random addressing
001Fh	DVD Read	The ability to read DVD specific structures
0021h	Incremental Streaming Writable	Write support for sequential recording
002Fh	DVD-R/-RW Write	The ability to write DVD specific structures
0100h	Power Management	host and logical unit directed power management
0105h	Timeout	Ability to respond to all commands within a specific time
0107h	Real-Time Streaming	Ability to read and write using host requested performance parameters
0108h	Logical unit Serial Number	The logical unit has a unique identifier

16.11 Profile 0012h: DVD-RAM

Logical units identifying Profile 12h as current *shall* support the Features listed in Table 307:

Table 307 - Mandatory Features for DVD-RAM

Feature Number	Feature Name	Description
0000h	Profile List	A list of all Profiles supported by the logical unit
0001h	Core	Mandatory behavior for all logical units
0002h	Morphing	The logical unit changes its operational behavior due to events external to the host
0003h	Removable Medium	The medium may be removed from the logical unit
0010h	Random Readable, PP = 1	Read ability for storage logical units with random addressing
001Fh	DVD Read	The ability to read DVD specific structures
0020h	Random Writable	Write support for randomly addressed writes
0023h	Formattable	Support for formatting of media
0024h	Hardware Defect Management	Ability of the drive/media system to provide an apparently defect-free space
0100h	Power Management	host and logical unit directed power management
0105h	Timeout	Ability to respond to all commands within a specific time
0107h	Real-Time Streaming	Ability to read and write using host requested performance parameters

16.12 Profile 0013h: DVD-RW Restricted Overwrite

Logical units identifying Profile 13h as current *shall* support the Features listed in Table 308:

Table 308 - Mandatory Features for DVD-RW Restricted Overwrite

Feature Number	Feature Name	Description
0000h	Profile List	A list of all Profiles supported by the logical unit
0001h	Core	Mandatory behavior for all logical units
0002h	Morphing	The logical unit changes its operational behavior due to events external to the host
0003h	Removable Medium	The medium may be removed from the logical unit
0010h	Random Readable, PP = 1	Read ability for storage logical units with random addressing
001Fh	DVD Read	The ability to read DVD specific structures
0023h	Formattable	Support for formatting of media
002Ch	Rigid Restricted Overwrite	Write support for media that <i>shall</i> be written from Blocking boundaries with length of integral multiple of Blocking size only
0100h	Power Management	host and logical unit directed power management
0105h	Timeout	Ability to respond to all commands within a specific time
0107h	Real-Time Streaming	Ability to read and write using host requested performance parameters
0108h	Logical unit Serial Number	The logical unit has a unique identifier.

16.13 Profile 0014h: DVD-RW Sequential recording

Logical units identifying Profile 14h as current *shall* support the Features listed in Table 309:

Table 309 - Mandatory Features for DVD-RW Sequential recording

Feature Number	Feature Name	Description
0000h	Profile List	A list of all Profiles supported by the logical unit
0001h	Core	Mandatory behavior for all logical units
0002h	Morphing	The logical unit changes its operational behavior due to events external to the host
0003h	Removable Medium	The medium may be removed from the logical unit
0010h	Random Readable, PP = 1	Read ability for storage logical units with random addressing
001Fh	DVD Read	The ability to read DVD specific structures
0021h	Incremental Streaming Writable	Write support for sequential recording
002Fh	DVD-R/-RW Write	The ability to write DVD specific structures
0100h	Power Management	host and logical unit directed power management
0105h	Timeout	Ability to respond to all commands within a specific time
0107h	Real-Time Streaming	Ability to read and write using host requested performance parameters
0108h	Logical unit Serial Number	The logical unit has a unique identifier

16.14 Profile 0015h: DVD-R Dual Layer Sequential recording

Logical units identifying Profile 15h as current *shall* support the Features listed in Table 310:

Table 310 - Mandatory Features for DVD-R Dual Layer Sequential recording

Feature Number	Feature Name	Description
0000h	Profile List	A list of all Profiles supported by the logical unit
0001h	Core	Mandatory behavior for all logical units
0002h	Morphing	The logical unit changes its operational behavior due to events external to the host
0003h	Removable Medium	The medium may be removed from the logical unit
0010h	Random Readable, PP = 1	Read ability for storage logical units with random addressing
001Fh	DVD Read	The ability to read DVD specific structures
0021h	Incremental Streaming Writable	Write support for sequential recording
002Fh	DVD-R/-RW Write	The ability to write DVD specific structures
0100h	Power Management	host and logical unit directed power management
0105h	Timeout	Ability to respond to all commands within a specific time
0107h	Real-Time Streaming	Ability to read and write using host requested performance parameters
0108h	Logical unit Serial Number	The logical unit has a unique identifier

16.15 Profile 0016h: DVD-R Dual Layer Jump recording

Logical units identifying Profile 16h as current *shall* support the Features listed in Table 311:

Table 311 - Mandatory Features for DVD-R Layer Jump recording

Feature Number	Feature Name	Description
0000h	Profile List	A list of all Profiles supported by the logical unit
0001h	Core	Mandatory behavior for all logical units
0002h	Morphing	The logical unit changes its operational behavior due to events external to the host
0003h	Removable Medium	The medium may be removed from the logical unit
0010h	Random Readable, PP = 1	Read ability for storage logical units with random addressing
001Fh	DVD Read	The ability to read DVD specific structures
0033h	Layer Jump recording	Write support for Layer Jump recording
0100h	Power Management	host and logical unit directed power management
0105h	Timeout	Ability to respond to all commands within a specific time
0107h	Real-Time Streaming	Ability to read and write using host requested performance parameters
0108h	Logical unit Serial Number	The logical unit has a unique identifier

16.16 Profile 0017h: DVD-RW Dual Layer

Logical units identifying Profile 17h as current *shall* support the Features listed in Table 312. The LJ Rigid Restricted Overwrite Feature and Enhanced Defect Reporting Feature are one of the optional Features for this Profile.

Table 312 - Mandatory Features for DVD-RW Dual Layer

Feature Number	Feature Name	Description
0000h	Profile List	A list of all Profiles supported by the logical unit
0001h	Core	Mandatory behavior for all logical units
0002h	Morphing	The logical unit changes its operational behavior due to events external to the host
0003h	Removable Medium	The medium may be removed from the logical unit
0010h	Random Readable, PP = 1	Read ability for storage logical units with random addressing
001Fh	DVD Read, Dual-RW = 1	The ability to read DVD specific structures
0023h	Formattable, FRF = 0 ^a	Support for formatting of media
002Ch	Rigid Restricted Overwrite ^b , Intermediate = 1	Write support for media that <i>shall</i> be written from Blocking boundaries with length of integral multiple of Blocking size only
0035h	Stop Long Operation	Ability to stop the long immediate operation by a command
0100h	Power Management	host and logical unit directed power management
0105h	Timeout	Ability to respond to all commands within a specific time
0107h	Real-Time Streaming	Ability to read and write using host requested performance parameters
0108h	Logical unit Serial Number	The logical unit has a unique identifier.

- a. When LJ Rigid Restricted Overwrite Feature is supported for this Profile, FRF bit *shall* be set to one. Otherwise, this bit is not necessary to be set to one.
- b. Blank bit is not necessary to be set to 1.

16.17 Profile 0018h: DVD-Download disc recording

Logical units identifying Profile 18h as current *shall* support the Features listed in Table 313:

Table 313 - Mandatory Features for DVD-Download disc recording

Feature Number	Feature Name	Description
0000h	Profile List	A list of all Profiles supported by the logical unit
0001h	Core	Mandatory behavior for all logical units
0002h	Morphing	The logical unit changes its operational behavior due to events external to the host
0003h	Removable Medium	The medium may be removed from the logical unit
0010h	Random Readable, PP = 1	Read ability for storage logical units with random addressing
001Fh	DVD Read	The ability to read DVD specific structures
002Fh	DVD-R/-RW Write, BUF=1	The ability to write DVD specific structures
0100h	Power Management	host and logical unit directed power management
0105h	Timeout	Ability to respond to all commands within a specific time
0106h	DVD CSS	The ability to perform DVD CSS/CPPM authentication and RPC
0107h	Real-Time Streaming	Ability to read and write using host requested performance parameters
0108h	Logical unit Serial Number	The logical unit has a unique identifier
010Eh	DVD CSS Managed recording	The ability to perform DVD CSS Managed recording

16.18 Profile 0050h: HD DVD-ROM

Logical units identifying Profile 50h as current *shall* support the Features listed in Table 314:

Table 314 - Mandatory Features for HD DVD-ROM

Feature Number	Feature Name	Description
0000h	Profile List	A list of all Profiles supported by the logical unit
0001h	Core	Mandatory behavior for all logical units
0002h	Morphing	The logical unit changes its operational behavior due to events external to the host
0003h	Removable Medium	The medium may be removed from the logical unit
0010h	Random Readable, PP = 1	Read ability for storage logical units with random addressing
0050h	HD DVD Read	The ability to read HD DVD specific structures
0100h	Power Management	host and logical unit directed power management
0105h	Timeout	Ability to respond to all commands within a specific time
0107h	Real-Time Streaming	Ability to read and write using host requested performance parameters

16.19 Profile 0051h: HD DVD-R

Logical units identifying Profile 51h as current *shall* support the Features listed in Table 315:

Table 315 - Mandatory Features for HD DVD-R

Feature Number	Feature Name	Description
0000h	Profile List	A list of all Profiles supported by the logical unit
0001h	Core	Mandatory behavior for all logical units
0002h	Morphing	The logical unit changes its operational behavior due to events external to the host
0003h	Removable Medium	The medium may be removed from the logical unit
0010h	Random Readable, PP = 1	Read ability for storage logical units with random addressing
0021h	Incremental Streaming Writable	Write support for sequential recording
0050h	HD DVD Read	The ability to read HD DVD specific structures
0051h	HD DVD Write	The ability to write HD DVD specific structures
0100h	Power Management	host and logical unit directed power management
0105h	Timeout	Ability to respond to all commands within a specific time
0107h	Real-Time Streaming	Ability to read and write using host requested performance parameters
0108h	Logical unit Serial Number	The logical unit has a unique identifier

16.20 Profile 0052h: HD DVD-RAM

Logical units identifying Profile 52h as current *shall* support the Features listed in Table 316:

Table 316 - Mandatory Features for HD DVD-RAM

Feature Number	Feature Name	Description
0000h	Profile List	A list of all Profiles supported by the logical unit
0001h	Core	Mandatory behavior for all logical units
0002h	Morphing	The logical unit changes its operational behavior due to events external to the host
0003h	Removable Medium	The medium may be removed from the logical unit
0010h	Random Readable, PP = 1	Read ability for storage logical units with random addressing
0020h	Random Writable	Write support for randomly addressed writes
0023h	Formattable	Support for formatting of media
0024h	Hardware Defect Management	Ability of the drive/media system to provide an apparently defect-free space
0050h	HD DVD Read	The ability to read HD DVD specific structures
0051h	HD DVD Write	The ability to write HD DVD specific structures
0100h	Power Management	host and logical unit directed power management
0105h	Timeout	Ability to respond to all commands within a specific time
0107h	Real-Time Streaming	Ability to read and write using host requested performance parameters

16.21 Profile 0053h: HD DVD-RW

Logical units identifying Profile 53h as current *shall* support the Features listed in Table 317:

Table 317 - Mandatory Features for HD DVD-RW

Feature Number	Feature Name	Description
0000h	Profile List	A list of all Profiles supported by the logical unit
0001h	Core	Mandatory behavior for all logical units
0002h	Morphing	The logical unit changes its operational behavior due to events external to the host
0003h	Removable Medium	The medium may be removed from the logical unit
0010h	Random Readable, PP = 1	Read ability for storage logical units with random addressing
0023h	Formattable	Support for formatting of media
0029h	Enhanced Defect Reporting	The ability to control RECOVERED ERROR reporting
002Ch	Rigid Restricted Overwrite, Intermediate =1 and Blank =1	Write support for media that <i>shall</i> be written from Blocking boundaries with length of integral multiple of Blocking size only
0050h	HD DVD Read	The ability to read HD DVD specific structures
0051h	HD DVD Write	The ability to write HD DVD specific structures
0052h	HD DVD-RW Fragment Recording	The ability to write HD DVD-RW media with Fragment recording mode
0100h	Power Management	host and logical unit directed power management
0105h	Timeout	Ability to respond to all commands within a specific time
0107h	Real-Time Streaming	Ability to read and write using host requested performance parameters
0108h	Logical unit Serial Number	The logical unit has a unique identifier.

16.22 Profile 0058h: HD DVD-R Dual Layer

Logical units identifying Profile 58h as current *shall* support the Features listed in Table 318:

Table 318 - Mandatory Features for HD DVD-R Dual Layer

Feature Number	Feature Name	Description
0000h	Profile List	A list of all Profiles supported by the logical unit
0001h	Core	Mandatory behavior for all logical units
0002h	Morphing	The logical unit changes its operational behavior due to events external to the host
0003h	Removable Medium	The medium may be removed from the logical unit
0010h	Random Readable, PP = 1	Read ability for storage logical units with random addressing
0021h	Incremental Streaming Writable	Write support for randomly addressed writes
0050h	HD DVD Read	The ability to read HD DVD specific structures
0051h	HD DVD Write	The ability to write HD DVD specific structures
0100h	Power Management	host and logical unit directed power management
0105h	Timeout	Ability to respond to all commands within a specific time
0107h	Real-Time Streaming	Ability to read and write using host requested performance parameters
0108h	Logical unit Serial Number	The logical unit has a unique identifier

16.23 Profile 005Ah: HD DVD-RW Dual Layer

Logical units identifying Profile 5Ah as current *shall* support the Features listed in Table 319:

Table 319 - Mandatory Features for HD DVD-RW Dual Layer

Feature Number	Feature Name	Description
0000h	Profile List	A list of all Profiles supported by the logical unit
0001h	Core	Mandatory behavior for all logical units
0002h	Morphing	The logical unit changes its operational behavior due to events external to the host
0003h	Removable Medium	The medium may be removed from the logical unit
0010h	Random Readable, PP = 1	Read ability for storage logical units with random addressing
0023h	Formattable	Support for formatting of media
0029h	Enhanced Defect Reporting	The ability to control RECOVERED ERROR reporting
002Ch	Rigid Restricted Overwrite, Intermediate =1 and Blank =1	Write support for media that <i>shall</i> be written from Blocking boundaries with length of integral multiple of Blocking size only
0050h	HD DVD Read	The ability to read HD DVD specific structures
0051h	HD DVD Write	The ability to write HD DVD specific structures
0100h	Power Management	host and logical unit directed power management
0105h	Timeout	Ability to respond to all commands within a specific time
0107h	Real-Time Streaming	Ability to read and write using host requested performance parameters
0108h	Logical unit Serial Number	The logical unit has a unique identifier.

16.24 Profile FFFFh: Logical units Not Conforming to a Standard Profile

Logical units identifying Profile FFFFh as current *shall* support the Features listed in Table 320:

Table 320 - Mandatory Features for logical units Not Conforming to a Standard Profile

Feature Number	Feature Name	Description
0000h	Profile List	A list of all Profiles supported by the logical unit
0001h	Core	Mandatory behavior for all logical units
0002h	Morphing	Ability to notify host about operational changes and accept host requests to prevent operational changes.
0003h	Removable Medium	The medium may be removed from the logical unit
0100h	Power Management	host and logical unit directed power management

17.0 Packet commands

The first byte of all Command Packets *shall* contain an Operation Code as defined in this specification. This specification is broken down into separate sections. This section describes all commands that are specified in this specification.

Table 321 - Packet commands for Multi-Media logical units

Opcode	Command Description	Reference
A1h	BLANK	section 17.1 on page 539
5Bh	CLOSE TRACK/SESSION	section 17.2 on page 543
39h	COMPARE	SPC-2
2Ch	ERASE (10)	SBC
04h	FORMAT UNIT	section 17.3 on page 549
46h	GET CONFIGURATION	section 17.4 on page 559
4Ah	GET EVENT/STATUS NOTIFICATION	section 17.5 on page 629
ACh	GET PERFORMANCE	section 17.6 on page 643
12h	INQUIRY	section 17.7 on page 655
A6h	LOAD/UNLOAD MEDIUM	section 17.8 on page 661
36h	LOCK/UNLOCK CACHE	SBC
4Ch	LOG SELECT	SPC-2
4Dh	LOG SENSE	SPC-2
BDh	MECHANISM STATUS	section 17.9 on page 663
55h	MODE SELECT (10)	section 17.10 on page 667
5Ah	MODE SENSE (10)	section 17.11 on page 669
4Bh	PAUSE/RESUME	section 17.12 on page 697
45h	PLAY AUDIO (10)	section 17.13 on page 699
47h	PLAY AUDIO MSF	section 17.14 on page 703
BCh	PLAY CD	Obsolete
34h	PRE-FETCH	SBC
1Eh	PREVENT ALLOW MEDIUM REMOVAL	section 17.15 on page 705
28h	READ (10)	section 17.16 on page 707
A8h	READ (12)	section 17.17 on page 709
3Ch	READ BUFFER	section 17.18 on page 711
5Ch	READ BUFFER CAPACITY	section 17.19 on page 715
25h	READ CAPACITY	section 17.20 on page 717
BEh	READ CD	section 17.21 on page 719
B9h	READ CD MSF	section 17.22 on page 729
51h	READ DISC INFORMATION	section 17.23 on page 731
ADh	READ DISC STRUCTURE	section 17.24 on page 741
23h	READ FORMAT CAPACITIES	section 17.25 on page 773
44h	READ HEADER	Obsolete
42h	READ SUBCHANNEL	section 17.26 on page 779
43h	READ TOC/PMA/ATIP	section 17.27 on page 787
52h	READ TRACK INFORMATION	section 17.28 on page 801
1C	RECEIVE DIAGNOSTIC RESULTS	SPC-2
17h	RELEASE (6)	SPC-2
57h	RELEASE (10)	SPC-2
58h	REPAIR RZONE	section 17.29 on page 815

Table 321 - Packet commands for Multi-Media logical units (continued)

Opcode	Command Description	Reference
A4h	REPORT KEY	section 17.30 on page 817
03h	REQUEST SENSE	section 17.31 on page 833
16h	RESERVE (6)	SPC-2
56h	RESERVE (10)	SPC-2
53h	RESERVE TRACK	section 17.32 on page 839
BAh	SCAN	section 17.33 on page 845
2Bh	SEEK	section 17.34 on page 849
5Dh	SEND CUE SHEET	section 17.35 on page 851
1Dh	SEND DIAGNOSTIC	SPC-2
BFh	SEND DISC STRUCTURE	section 17.36 on page 859
A2h	SEND EVENT	section 17.37 on page 873
A3h	SEND KEY	section 17.38 on page 875
54h	SEND OPC INFORMATION	section 17.39 on page 883
BBh	SET CD SPEED	section 17.40 on page 885
A7h	SET READ AHEAD	section 17.41 on page 887
B6h	SET STREAMING	section 17.42 on page 889
1Bh	START STOP UNIT	section 17.43 on page 895
4Eh	STOP PLAY/SCAN	section 17.44 on page 899
35h	SYNCHRONIZE CACHE (10)	section 17.45 on page 901
00h	TEST UNIT READY	section 17.46 on page 903
2Fh	VERIFY (10)	section 17.47 on page 905
2Ah	WRITE (10)	section 17.48 on page 907
AAh	WRITE (12)	section 17.49 on page 911
2Eh	WRITE AND VERIFY (10)	section 17.50 on page 913
3Bh	WRITE BUFFER	SPC-2

17.1 BLANK command

Some kinds of re-writable discs have two properties not available with write-once discs: direct-overwrite and the ability to erase. The BLANK command provides the ability to erase any part of a CD-RW/DVD-RW SL¹ disc. For HD DVD-RW discs, the BLANK command provides ability to perform logical blanking.

The SET STREAMING command may affect the speed at which the blanking operation is performed.

Table 322 - BLANK Command Descriptor Block

Bit Byte	7	6	5	4	3	2	1	0	
0	Operation Code (A1h)								
1	LUN (Obsolete)			Immed	Reserved	Blanking Type			
2	Start Address or Track/RZone Number								
3									(MSB)
4									
5									
									(LSB)
6	Reserved								
7	Reserved								
8	Reserved								
9	Reserved								
10	Reserved								
11	Vendor-Specific	Reserved			NACA	Flag	Link		

Note: The erasing action performed in this command is a Logical Erase, in that the data is overwritten with Mode 0 data on CD media.

The Immediate (Immed) bit, when set to zero, *shall* indicate that the command *shall* complete after the blank operation has been performed. When set to one, *shall* indicate that the command *shall* complete after validating the CDB.

Note: ATAPI logical units may require that the Immed bit be set to one.

Blanking Type identifies the method and coverage of blanking. The codes for Blanking Type are defined in Table 323 and Table 324.

1. An erase operation is not defined for DVD-RW DL discs.

Table 323 - Blanking Types for CD-RW

Code	Type	Name	Description
000b	Mandatory	Blank the disc	The entire disc is to be erased. The Start Address parameter is ignored. This is used for clearing a complete disc. The PCA may be excluded. At completion of the operation, the area from the start time of Lead-in through the last possible start time of Lead-out plus 6,750 blocks and the entire PMA <i>shall</i> be blank.
001b	Mandatory	Minimally blank the disc	Erases only the PMA, first session TOC and the pre-gap of the first track. The Start Address parameter is ignored. This is used for blanking a disc quickly. After completion of this command the disc is treated as a blank disc. Caution <i>shall</i> be exercised when using this command as the program area still contains user data.
010b	Optional	Blank a Track	Erases the track specified in the Start Address/Track Number field. This command erases the track only, it does not erase the TOC or the PMA. The track to be erased <i>shall</i> be in the incomplete session.
011b	Optional	Unreserve a Track	This is valid only when the last recorded track is incomplete, reserved, or is complete and in an incomplete session. If the last track is incomplete the track and PMA entry for incomplete track is erased. If the track is reserved or complete, the track and PMA entry of the track is erased. The Start Address/Track Number parameter is ignored.
100b	Mandatory	Blank a Track Tail	Erase the area between the LBA specified Start Address/Track Number field and the end of the track that includes the LBA specified. The LBA specified <i>shall</i> be the first user data block within a packet. This blank type is valid for only a Packet track. This may be used to prepare for writing a packet track to a CD-RW disc with the same write process as a CD-R. The track to be erased <i>shall</i> be in an incomplete session.
101b	Optional	Unclose the last session	Erases the Lead-in and Lead-out of the last session. The last session <i>shall</i> be complete when this command is issued.
110b	Optional	Erase Session	If the last session is complete, its Lead-in, program area, and Lead-out <i>shall</i> be erased. If the last session is incomplete, its program area <i>shall</i> be erased. If the last session is empty, the complete session immediately preceding the empty session <i>shall</i> be erased. If the empty session is the only session on the disc, erasing <i>shall not</i> be considered an error.
111b		Reserved	

Table 324 - Blanking Types for DVD-RW SL

Code	Type	Name	Description
000b	Mandatory	Blank the disc	The entire disc is to be erased. The area from the RMA through the end of Last address of Data Recordable Area ^a plus 3 ECC blocks except RMA Lead-in and six RMD blocks at the beginning of RMA <i>shall</i> be erased. The Start Address or Track/RZone Number parameter is ignored. If a disc is to be erased that is already fully blanked, no error <i>shall</i> be reported.
001b	Mandatory	Minimally blank the disc	This operation is used for blanking a disc quickly. Lead-in and the entire RMA except RMA Lead-in and six RMD blocks at the beginning of RMA <i>shall</i> be erased. The Start Address or Track/RZone Number parameter is ignored. Caution <i>shall</i> be exercised when using this command as the Data Area still contains user data. If a disc is to be erased that is already fully/minimally blanked, no error <i>shall</i> be reported.
010b		Reserved	
011b	Optional	Unreserve an RZone	This operation is valid only when the last Bordered Area is incomplete state. If the last RZone is invisible, the RZone that immediately preceding Invisible RZone and its RMD entry are erased. If the last RZone is incomplete, the Incomplete RZone is erased. The Start Address or Track/RZone Number parameter is ignored.
100b	Optional	Blank an RZone Tail	This blanking type is valid for only a incrementally recorded RZone. The RZone to be erased <i>shall</i> be in an incomplete Bordered Area. Erase the area between the LBA specified Start Address or Track/RZone Number field and the end of the RZone that includes the LBA specified. When the RZone that is to be erased is Complete RZone and if the next RZone is recorded, the last ECC block of the Complete RZone <i>shall</i> be remained as BSGA to guarantee next RZone readable. If attempting to erase an RZone that causes generation of fourth NWA, the command <i>shall</i> be terminated with CHECK CONDITION status, 5/72/05 NO MORE RZONE RESERVATIONS ARE ALLOWED. The LBA specified <i>shall</i> be the first user data block of an ECC block and <i>shall</i> be an existing linking point of an RZone. If the start address sector is not a linking point, the command <i>shall</i> be terminated with CHECK CONDITION status, 5/21/02 INVALID ADDRESS FOR WRITE.
101b	Optional	Unclose the last Border	This blanking type is valid for only a incrementally recorded disc. This operation is valid only when the last Bordered Area is complete state. Erases the Lead-in/Border-in and Lead-out/Border-out of the last Bordered Area. If the last Bordered Area is empty state, the complete Border immediately preceding the empty Bordered Area <i>shall</i> be erased.
110b	Optional	Erase Border	If the last Bordered Area is complete state, its Lead-in/Border-in through the end of the Lead-out/Border-out <i>shall</i> be erased. If the last Bordered Area is incomplete state, all RZone(s) in the incomplete Bordered Area <i>shall</i> be erased. If the last Bordered Area is empty state, the complete Border immediately preceding the empty Bordered Area <i>shall</i> be erased. If the disc is blank, erasing <i>shall not</i> be considered an error.
111b		Reserved	

a. This information is encoded as pre-pit information.

Table 325 - Blanking Types for HD DVD-RW

Code	Type	Name	Description
000b	Mandatory	Blank the disc	The entire disc is to be erased logically, then the disc enters Empty state. RZone information in RMD <i>shall</i> be modified. RZone information in R-PFI <i>shall</i> also be modified if needed. ECC block pair status bitmap <i>shall</i> be preserved. The Start Address or Track/RZone Number parameter is ignored. See 5.15.7.1, "Blank the disc (Full blank)" on page 402 or 5.16.8.1, "Blank the disc (Full blank)" on page 429.
001b	Mandatory	Minimally blank the disc	Set RMD and R-PFI as Empty state. See 5.15.7.2, "Minimally blank the disc" on page 402 or 5.16.8.2, "Minimally blank the disc" on page 429.
Others	-	Reserved	-

Start Address or Track/RZone Number is the address at which erasure *shall* begin:

1. When Blanking Type is Blank a Track/RZone Tail, this field indicates the start LBA.
2. When Blanking Type is Blank a Track, this field indicates the Track.

Morphing may occur when the BLANK operation is requested (to indicate changing to the NOT READY condition) and when the BLANK operation completes (to indicate the Restricted Overwrite Feature and/or others becoming Current).

During the blank operation, the logical unit *shall* respond to commands as follows:

1. In response to all commands that can return NOT READY status, the logical unit *shall* return CHECK CONDITION status, 2/04/07 LOGICAL UNIT NOT READY, OPERATION IN PROGRESS. INQUIRY, GET CONFIGURATION, GET EVENT/STATUS NOTIFICATION, and REQUEST SENSE are among the commands that *shall not* return a NOT READY error (Sense Key 2).
2. In response to the INQUIRY, GET CONFIGURATION, and GET EVENT/STATUS NOTIFICATION commands, the logical unit *shall* respond as commanded.
3. In response to the REQUEST SENSE command, unless an error within the command itself has occurred, the logical unit *shall* return GOOD status, 2/04/07 LOGICAL UNIT NOT READY, OPERATION IN PROGRESS indicated in the result data and the sense key specific bytes set for progress indication. See the description of deferred error handling that may occur during the blank operation.
4. In response to an ATA SRST, the logical unit *shall* provide the diagnostic results and the ATAPI signature. The blank operation *shall not* be affected.

Table 326 describes errors that may occur during the operation of the command or which may cause a CHECK CONDITION status to be reported.

Table 326 - BLANK command errors

Error Description
A-1.1, "Deferred Error Reporting" on page 919
Table 835 - Basic Error Codes on page 932
Table 836 - Media Access Error Codes on page 935
Table 837 - Write Error Codes on page 938

17.2 CLOSE TRACK/SESSION command

The CLOSE TRACK/SESSION command allows closure of a CD track, a DVD/HD DVD RZone, a CD Session or a DVD/HD DVD Border. For CD/DVD, if the Multisession/Border field in the Write Parameters mode page is set to 11b and there is not sufficient space for the next Session/Border, the Session/Border to be closed **shall** be closed and next Session/Border **shall not** be allowed. For CD, the Session is closed without the B0 pointer. For DVD, the Border is closed with Lead-out and the Start PSN of the next Border-in field of Lead-in/Border-in set to 0. For HD DVD, the Write Parameters mode page is not used.

Note: In the case of insufficient space for the next Session, legacy CD-R/-RW logical units may generate an error in the above case. In this case, the host should change the Multisession/Border field in the Write Parameters mode page and retry the command.

Table 327 - CLOSE TRACK/SESSION Command Descriptor Block

Bit Byte	7	6	5	4	3	2	1	0
0	Operation Code (5Bh)							
1	LUN (Obsolete)			Reserved				Immed
2	Reserved				Close Function			
3	Reserved							
4	(MSB) Track Number (LSB)							
5								
6	Reserved							
7	Reserved							
8	Reserved							
9	Vendor-Specific		Reserved			NACA	Flag	Link
10	PAD							
11								

The Immediate (Immed) bit allows execution of the CLOSE TRACK/SESSION function as an immediate operation. If Immed is set to 0, then the requested Close operation is performed to completion prior to returning status. If Immed is set to 1, then status is returned once the Command Packet has been validated.

For DVD-R/HD DVD-R, a logical units may write cached RMD into the RMA/RMZ immediately upon receipt of a CLOSE TRACK/SESSION command. DVD-R/HD DVD-R logical units may delay the Close operation and writing of cached RMD into RMA/RMZ to allow multiple CLOSE TRACK/SESSION commands to be issued quickly. In this case, it is recommended that the logical unit not write RMD into the RMA/RMZ until the last CLOSE TRACK/SESSION command in a sequence has been received.

Note: Determining the end of a sequence of CLOSE TRACK/SESSION commands is vendor specific.

The Close Function field is defined in Table 328.

Table 328 - Close Function field definition^a

Close Function value	Media Types	Close Actions
000b	CD-R, CD-RW, DVD-R, DVD-RW SL, HD DVD-R SL	Reserved: This condition is reserved and not valid. The logical unit <i>shall</i> report CHECK CONDITION status, 5/24/00 INVALID FIELD IN CDB.
	DVD-RW DL	<p>Stop the long immediate operation.</p> <p>If a background operation due to an immediate command, i.e. FORMAT UNIT command with <i>Immed</i>=1 and CLOSE TRACK/SESSION command with <i>Immed</i>=1, is in progress, the logical unit <i>shall</i> terminate the current background operation and become READY condition. If Stop Long Operation Feature is not current, the logical unit <i>shall</i> terminate this command with CHECK CONDITION status, 5/24/00 INVALID FIELD IN CDB. If no background operation exists, the request is not considered as an error.</p> <p>The recorded user data on the disc after this operation is completed <i>shall</i> be readable if the background operation is required to preserve the user data, i.e. Grow formatting, Quick Grow formatting, Fast Re-formatting and Disc closing. In these cases, the physical disc state <i>shall</i> be either Complete state or Intermediate state. To guarantee the recorded user data is readable for the above operations, post processing is necessary, e.g. recording the Intermediate Marker and updating the RMD.</p> <p>For other background operations, the disc may become unreadable. But the logical unit <i>shall</i> return GOOD condition for TEST UNIT READY command on the disc.</p> <p>If <i>Immed</i> bit in the CDB of this command is set to zero, the logical unit <i>shall</i> report the result of this command after finishing the post processing, if necessary. If the bit is set to one, the logical unit <i>shall</i> report the result as soon as the CDB is validated.</p> <p>The Progress Indication field <i>shall</i> not be restarted for this operation, but upon completion of this operation, the field <i>shall</i> become FFFFh.</p>
	HD DVD-R DL	<p>Suspend the finalization:</p> <p>When a finalization is in progress, the finalization <i>shall</i> be suspended.</p>
	HD DVD-RW	<p>Stop time-consuming operation:</p> <p>Stop a Formatting, Finalization, Full-finalization or Erasing operation that is in progress</p>

Table 328 - Close Function field definition^a (continued)

Close Function value	Media Types	Close Actions
001b	CD-R, CD-RW	<p>Close the track associated with the track number in the CDB:</p> <p>If the specified track is Incomplete track, the logical unit <i>shall</i> pad with all zero main data to the minimum length of 4 seconds. No other padding is to be done. If the track is Partially recorded reserved or Empty reserved track, the logical unit <i>shall</i> pad the track. In the case of an Empty reserved track, the logical unit <i>shall</i> write the track according to the Write Parameters mode page. If the Write Parameters mode page is inconsistent with the PMA or TDB, the logical unit <i>shall</i> return CHECK CONDITION status, 5/64/00 ILLEGAL MODE FOR THIS TRACK. For a Partially recorded reserved track, the logical unit <i>shall</i> continue writing in the same mode as the data already recorded.</p>
	DVD-R, DVD-RW SL with sequential recording mode, HD DVD-R	<p>Close the RZone associated with the RZone number in the CDB:</p> <p>If the specified RZone is the Partially recorded reserved RZone or the Empty reserved RZone, the logical unit <i>shall</i> pad the RZone with 00h bytes. If the RZone status is Invisible, no close operation is to be done. In the case of an Incomplete RZone, no padding is to be done and cached RMD <i>shall</i> be written into the RMA/RMZ.</p>
	DVD-RW SL with restricted overwrite mode, HD DVD-RW	<p>Reserved:</p> <p>This condition is reserved and not valid. The logical unit <i>shall</i> report CHECK CONDITION status, 5/24/00 INVALID FIELD IN CDB.</p>
	DVD-RW DL	<p>Close LJB:</p> <p>Pad physically unrecorded sectors on L1 where the corresponding sectors on L0 in the active LJB are logically recorded. Specified Jump Interval size or Manual Layer Jump Address <i>shall</i> be cleared and LJRS field value returned by READ TRACK INFORMATION command <i>shall</i> be set to 01b.</p> <p>If LJRS field value is 00b, all the sectors on L1 correspond to the logically recorded sectors on L0 <i>shall</i> become physically recorded. Last recorded PSN, End PSN of RZone, Maximum recorded PSN of the Data Area on Layer 0 and Maximum recorded PSN of the Data Area <i>shall</i> never be changed.</p> <p>If LJRS field value is other than 00b but Last recorded PSN is inner than $\overline{\text{End PSN of L0}}$, the logical unit <i>shall</i> terminate this command with CHECK CONDITION status, 5/24/00 INVALID FIELD IN CDB <i>shall</i> be set.</p> <p>If LJRS field value is other than 00b, fully recorded LJB exists and active and non-blank LJB does not exist on the disc, this command is not treated as an error.</p> <p>If the L0 part of the LJB to be closed has not been fully recorded yet, Last Layer Jump Address field <i>shall</i> be set to Last Recorded Address field value, Next Writable Address field <i>shall</i> be set to Last Layer Jump Address field value + 17, and Last Recorded Address field <i>shall</i> be set to the LBA specified by End PSN of Data Area field in Control Data Zone.</p>

Table 328 - Close Function field definition^a (continued)

Close Function value	Media Types	Close Actions
010b	CD-R, CD-RW	Close the last Session: If all tracks in the last Session are not complete, generate CHECK CONDITION status, 5/72/03 SESSION FIXATION ERROR - INCOMPLETE TRACK IN SESSION. Or if an Empty reserved or Partially recorded reserved tracks exist in the Incomplete Session, generate CHECK CONDITION status, 5/72/04 EMPTY OR PARTIALLY WRITTEN RESERVED TRACK. The behavior of the closing operation is dependent on the Multisession/Border field in the Write Parameters mode page. Closing an Empty Session does not produce an error and a write to the media <i>shall</i> not occur.
	DVD-R, DVD-RW SL with sequential recording mode, HD DVD-R SL	Close the last Border: If all RZones in the last Border are not complete, generate CHECK CONDITION status, 5/72/03 SESSION FIXATION ERROR - INCOMPLETE TRACK IN SESSION. Or if an Empty reserved or Partially recorded reserved RZones exist in the incomplete Border, generate CHECK CONDITION status, 5/72/04 EMPTY OR PARTIALLY WRITTEN RESERVED TRACK. The behavior of the closing operation is dependent on the Multisession/Border field in the Write Parameters mode page. Closing an empty Border does not produce an error and a write to the media <i>shall</i> not occur.
	DVD-RW SL with restricted overwrite mode	Close Intermediate state Border: If the last Bordered Area is in the Intermediate state, Lead-in and/or Border-out are recorded to make the Bordered Area Complete state. (If the Bordered Area is to be closed that is the first one, Lead-in and Border-out <i>shall</i> be recorded. If the Bordered Area is to be closed that is second or later one, only the Border-out <i>shall</i> be recorded.)
	DVD-RW DL	Close the Intermediate state disc: All the blocks in Lead-in Area, Lead-out Area, Middle Area and Data Area <i>shall</i> be recorded and the physical disc state <i>shall</i> be in Complete state. The last LBA of the logically recorded area of the disc <i>shall not</i> be changed by this operation.
	HD DVD-RW	Close the Intermediate state disc: When the disc is Intermediate state in Sequential formatting mode, Data Lead-in and Terminator are recorded to make the disc state Finalized state. When the disc is Intermediate state in Fragment recording mode, the disc state <i>shall</i> become Full-finalized state. See 5.15.6.2, "Full-finalization" on page 400 for HD DVD-RW SL.
	HD DVD-R DL	Reserved: This condition is reserved and not valid. The logical unit <i>shall</i> report CHECK CONDITION status, 5/24/00 INVALID FIELD IN CDB
011b	DVD-RW SL with restricted overwrite mode	Add Lead-out: If the last Bordered Area is Complete state and Lead-out is not written, Lead-out <i>shall</i> be appended after the last Border-out. If the last Bordered Area is Intermediate state, Border-out and Lead-out is recorded. If the disc is not formatted, the logical unit <i>shall</i> report CHECK CONDITION status, 5/24/00 INVALID FIELD IN CDB.
	CD-R, CD-RW, DVD-R, DVD-RW SL with sequential recording mode, DVD-RW DL, HD DVD-R, HD DVD-RW	Reserved: This condition is reserved and not valid. The logical unit <i>shall</i> report CHECK CONDITION status, 5/24/00 INVALID FIELD IN CDB

Table 328 - Close Function field definition^a (continued)

Close Function value	Media Types	Close Actions
100b	CD-R, CD-RW, DVD-R, DVD-RW, HD DVD-R, HD DVD-RW	Reserved: This condition is reserved in this specification and not valid. The logical unit <i>shall</i> report CHECK CONDITION status, 5/24/00 INVALID FIELD IN CDB.
101b	CD-R, CD-RW, DVD-R, DVD-RW, HD DVD-R, HD DVD-RW	Reserved: This condition is reserved and not valid. The logical unit <i>shall</i> report CHECK CONDITION status, 5/24/00 INVALID FIELD IN CDB.
110b	HD DVD-R	Finalization of the disc: Finalize the disc or restart the finalization.
	HD DVD-RW	Full-finalization of the disc: When the disc is Intermediate state in Sequential formatting mode, Finalized state in Sequential formatting mode or Intermediate state in Fragment recording mode, the disc state <i>shall</i> become Full-finalized state. See 5.15.6.2, "Full-finalization" on page 400 for HD DVD-RW SL and section 5.16.7.2, "Full-finalization" on page 426 for HD DVD-RW DL.
	CD-R, CD-RW, DVD-R, DVD-RW	Reserved: This condition is reserved and not valid. The logical unit <i>shall</i> report CHECK CONDITION status, 5/24/00 INVALID FIELD IN CDB.
111b	CD-R, CD-RW, DVD-R, DVD-RW, HD DVD-R, HD DVD-RW	Reserved: This condition is reserved in this specification and not valid. The logical unit <i>shall</i> report CHECK CONDITION status, 5/24/00 INVALID FIELD IN CDB.

a. See MMC for definition of this field for the other media types that is not specified by this specification.

If a Session/Border or Track/RZone is to be closed that is already closed, no error *shall* be reported.

If the Close Function field is 001b, the Track Number field indicates the Track/RZone number to be closed. Bytes 4 and 5 of the CDB *shall* be ignored if the Close Function field is set to 010b, 011b, 110b or 111b.

For a CD to close the incomplete track, the following steps are required:

1. If necessary, the track is padded with all zero main data to the minimum length of 4 seconds.
2. The PMA is consulted in order to locate the largest track number recorded, 'N'.
3. The bounds of the track are determined and a PMA entry is written for track N+1.

Closing a Track or RZone *shall* cause cached information for the specified Track or RZone to be committed to the medium prior to closing.

For CD, closing a Session *shall* cause the Lead-in and Lead-out to be written for the incomplete Session.

Closing a Session/Border when the last Session/Border is empty *shall* cause no actions to be performed and *shall not* be considered an error.

For DVD, closing an incomplete or an intermediate Bordered Area *shall* cause the Lead-in or Border-in and Border-out to be written for the incomplete or intermediate Bordered Area. If the Multisession/Border field in the Write Parameters mode page is set to 00b, a Lead-out *shall* be appended to the last Border-out. Once the Lead-out has been written for DVD media, data *shall not* be appended to the medium after the Lead-out.

For HD DVD-R SL, closing an incomplete Bordered Area *shall* cause the Lead-in or Border-in and Border-out to be written for the incomplete Bordered Area. If the unrecorded ECC blocks in Current RMZ exist and the unrecorded ECC blocks in RDZ do not exist, the command with Close Function field = 010b *shall not* be performed and the logical unit

shall report CHECK CONDITION status, 5/73/17 RDZ IS FULL. See 5.13.12.6, "Error reporting for "Border closure" by using CLOSE TRACK/SESSION command" on page 363

For HD DVD-R SL, if the Close Function field is set to 110b and the last Border is incomplete Border, the Border-out whose attribute is a Data Lead-out **shall** be written. If the Close Function field is set to 110b and the last Border is empty Border, the Terminator **shall** be appended to the last Border-out. Once the Border-out whose attribute is a Data Lead-out or the Terminator has been written, data **shall not** be appended to the medium after the Border-out or the Terminator. See 5.13.10, "Disc Final Closure" on page 356.

For HD DVD-R DL, the disc final closure **shall** cause Data Lead-in and Data Lead-out to be written for the incomplete Bordered Area. See 5.14.3, "Disc Final Closure" on page 374. Once the finalization starts, data **shall not** be appended to the medium.

During the close operation, the logical unit **shall** respond to commands as follows:

1. The logical unit may respond to commands that can return NOT READY status with CHECK CONDITION status, 2/04/07 LOGICAL UNIT NOT READY, OPERATION IN PROGRESS. See 4.6, on page 106, 3.4, on page 77, and Table 299 - NOT READY error and Timeout UNIT ATTENTION reporting (by command) on page 508.
2. In response to the INQUIRY, GET CONFIGURATION, and GET EVENT/STATUS NOTIFICATION commands, the logical unit **shall** respond as commanded.
3. In response to the REQUEST SENSE command, unless an error within the command itself has occurred, the logical unit **shall** return GOOD status, 2/04/07 LOGICAL UNIT NOT READY, OPERATION IN PROGRESS or 2/04/08 LOGICAL UNIT NOT READY, LONG WRITE IN PROGRESS indicated in the result data and the sense key specific bytes set for progress indication. See the description of deferred error handling that may occur during the close operation.
4. In response to an ATA SRST, the logical unit **shall** provide the diagnostic results and the ATAPI signature. The close operation **shall not** be affected.

If Operational Change Request/Notification Class Event is supported, closing a Track, RZone, Session, or Border **shall** cause a Operational Change Request/Notification Class Event when the command is issued if the logical unit becomes NOT READY. A Operational Change Request/Notification Class Event **shall** occur if the medium returns to READY or if the medium becomes unwritable. Other Operational Change Request/Notification Class Events may occur due to closing a Track, RZone, Session, or Border.

Table 329 describes errors that may occur during the operation of the command or which may cause a CHECK CONDITION status to be reported.

Table 329 - CLOSE TRACK/SESSION command errors

Error Description
A-1.1, "Deferred Error Reporting" on page 919
Table 835 - Basic Error Codes on page 932
Table 836 - Media Access Error Codes on page 935
Table 837 - Write Error Codes on page 938
Table 838 - Session/Border Error Codes on page 939

17.3 FORMAT UNIT command

The FORMAT UNIT command formats the medium into host addressable logical blocks per the host defined options.

The medium may be certified and control structures may be created for the management of the medium and defects. There is no guarantee that medium has or has not been altered.

The SET STREAMING command may affect the speed used to Format the medium.

Table 330 - FORMAT UNIT Command Descriptor Block

Bit Byte	7	6	5	4	3	2	1	0
0	Operation Code (04h)							
1	Restricted (See SBC-2)			FmtData(1)	CmpLst	Format Code (001b)		
2	Reserved							
3	(MSB) Interleave Value (0)							
4	(LSB)							
5	Vendor-Specific	Reserved			NACA	Flag	Link	
6	PAD							
7								
8								
9								
10								
11								

A Complete List (CmpLst) bit of one indicates that the parameter list is complete and the logical unit is to ignore any existing parameters. On DVD-RAM/HD DVD-RAM media, a CmpLst bit is used in conjunction with the Disable Certification (DCRT) bit to determine usage of the existing defect lists (e.g., the existing G₁-list, G₂-list and SDL to construct new G₁-list and G₂-list on DVD-RAM/HD DVD-RAM media). See Table 331. On CD-RW, DVD-RW and HD DVD-RW media, CmpLst bit *shall* be set to 0.

Table 331 - DVD-RAM/HD DVD-RAM Defect List Handling

CmpLst	DCRT	Certification	PDL			SDL	Remarks
			P-list	G ₁ -list	G ₂ -list		
0	0	Yes	Preserved	New from Certification	Disposed	Disposed	Slow Initialization
0	1	No	Preserved	Preserved	Old + New from SDL	Disposed	Change linear replacement to slipping, quickly
1	0	Yes (Partial) (Obsolete)	Preserved	Old plus New from Certification	Disposed	Disposed	Create new defect list by disposing all except P-list and G ₁ -list
1	1	No	Preserved	Preserved	Disposed	Disposed	Return to original slipping at the latest certification, quickly

The Format Code *shall* be set to 001b.

The Interleave Value field specifies the interleave that is used when performing the format operation. This field *shall* be set to zero.

During the format operation, the logical unit *shall* respond to other commands as follows:

1. In response to all commands that can return NOT READY status, the logical unit *shall* return CHECK CONDITION status, 2/04/04 LOGICAL UNIT NOT READY, FORMAT IN PROGRESS. INQUIRY, GET CONFIGURATION, GET EVENT/STATUS NOTIFICATION, and REQUEST SENSE are among the commands that *shall not* return a NOT READY error (Sense Key 2).
2. In response to the INQUIRY, GET CONFIGURATION, and GET EVENT/STATUS NOTIFICATION commands, the logical unit *shall* respond as commanded.
3. In response to the REQUEST SENSE command, unless an error within the command itself has occurred, the logical unit *shall* return GOOD status, 2/04/04 LOGICAL UNIT NOT READY, FORMAT IN PROGRESS indicated in the result data and the sense key specific bytes set for progress indication. See the description of deferred error handling that may occur during the format operation.
4. In response to an ATA SRST, the logical unit *shall* provide the diagnostic results and the ATAPI signature. The format operation *shall not* be affected.

During the execution of the FORMAT UNIT command, the logical unit *shall* perform a medium defect management algorithm if the Hardware Defect Management Feature is current. The FORMAT UNIT command for DVD-RAM/HD DVD-RAM media may not provide a method to receive defect location information from the host.

A format data (FmtData) bit *shall* be set to one. A FmtData bit of one indicates that the FORMAT UNIT parameter list (see Table 332) *shall* be transferred from the host to the logical unit. The data sent to the logical unit consists of a Format List Header, followed by an initialization pattern descriptor (which may have zero length), followed by one Format descriptor. The Format descriptor *shall* be one of Formattable Capacity Descriptors returned by the READ FORMAT CAPACITIES command.

Table 332 - FORMAT UNIT Parameter List

Bit Byte	7	6	5	4	3	2	1	0
0-3	Format List Header							
-	Initialization Pattern Descriptor (Not Present when IP bit =0)							
Format Descriptor (only 1 is allowed)								
4	Format Descriptor 0							
11								

The Format List Header provides several format control bits. Logical units that implement these bits give the host additional control over the formatting operation. If the host attempts to select any function not implemented by the logical unit, the logical unit *shall* terminate the command with CHECK CONDITION status, 5/26/00 INVALID FIELD IN PARAMETER LIST.

The Initialization Pattern Descriptor *shall not* be included in the Format Unit Parameter data sent to the logical unit.

Table 333 - Format List Header

Bit Byte	7	6	5	4	3	2	1	0
0	Reserved							
1	FOV	DPRY	DCRT	STPF	IP	Try-out	Immed	VS
2	Format Descriptor Length (0008h)							
3								

A Format Options Valid (FOV) bit of zero indicates that the logical unit *shall* use its default settings for the DPRY, DCRT, STPF, IP and Try-out (see below). When the FOV bit is zero, the host *shall* set these bits to zero. If any of these bits are not zero, the logical unit *shall* terminate the command with CHECK CONDITION status, 5/26/00 INVALID FIELD IN PARAMETER LIST. An FOV bit of one indicates that the logical unit *shall* examine the setting of the DPRY, DCRT, STPF, IP and Try-out bits. When the FOV bit is one, the DPRY, DCRT, STPF, IP and Try-out are defined as follows.

A Disable Primary (DPRY) bit, when set to zero, *shall* indicate that the logical unit *shall* retain the manufacturer's certification list (PList). When set to one, *shall* indicate that the manufacturer's certification list be retained but not used for defect management. DPRY bit *shall* be set to zero for DVD-RAM, HD DVD-RAM, CD-RW and DVD-RW media.

A disable certification (DCRT) bit of zero indicates that the logical unit *shall* perform a vendor-specific medium certification operation to generate a G₁-list (C-list) or a Defect Status bitmap (DS #n bits) in the Format 3 RMD on DVD-RW media. A DCRT bit of one indicates that the logical unit *shall not* perform any vendor-specific medium certification process or format verification operation while executing the FORMAT UNIT command. DCRT bit *shall* be set to zero for CD-RW media.

The Stop Format (STPF) bit *shall* be set to zero.

The Initialization Pattern (IP) bit *shall* be set to zero. If the IP bit is set to zero, the Initialization Pattern Descriptor *shall not* be included in the Format Unit Parameter data sent to the logical unit, and the Format Descriptor *shall* begin at byte offset 4.

A Try-out bit of one indicates that the logical unit *shall not* change the media format but *shall* examine whether the specified FORMAT UNIT command can be performed without error, based on available information before starting the formatting.

An immediate (Immed) bit of zero indicates that status *shall* be returned after the format operation has completed. An Immed bit of one indicates that the logical unit *shall* return status as soon as the command descriptor block has been validated, and the entire Format Descriptor has been transferred.

If the Immed bit was set to one or the FORMAT UNIT command was queued, then in response to the REQUEST SENSE command during the formatting operation, unless an error in the command has occurred, the logical unit *shall* return no CHECK CONDITION status, 2/04/04 LOGICAL UNIT NOT READY, FORMAT IN PROGRESS in the result data and the Sense Key Specific field set to the percentage of the operation that has completed. See Table 725 - *Progress Indication* on page 836 for details.

The logical unit may morph when the Format operation begins and again when it ends. For example, the medium may become inaccessible during the Format operation, and the Random Writable Feature may become current after Formatting.

The Vendor Specific (VS) bit indicates a vendor-specific format.

The Format Descriptor Length field in the Format list header specifies the total length in bytes of the Format descriptors that follow and does not include the initialization pattern descriptor or initialization pattern, if any.

The Format Descriptor Length *shall* be set to 8. Any other value in this field *shall* return CHECK CONDITION status, 5/26/00 INVALID FIELD IN PARAMETER LIST.

Table 334 - Format Descriptor - From READ FORMAT CAPACITIES

Bit Byte	7	6	5	4	3	2	1	0
0	(MSB) Number of Blocks (LSB)							
1								
2								
3								
4	Format Type				Reserved			
5	(MSB) Type Dependent Parameter (LSB)							
6								
7								

The Format descriptor specifies an eight-byte entry.

The Format Type field specifies the type of formatting. Contents of the Number of Blocks field and the Type Dependent Parameter field depend on the type of formatting. The Format Type values are defined in Table 650 - *Format Types* on page 775.

17.3.1 Formatting on Format Type = 00h (Full Format)

Formatting for the whole media is specified.

The Number of Blocks field specifies the number of addressable blocks for the whole disc and the Type Dependent Parameter field specifies the Block Length.

On DVD-RAM/HD DVD-RAM media, the defect list handling is specified by the combination of the CmpLst bit and the DCRT bit as shown in Table 331 - *DVD-RAM/HD DVD-RAM Defect List Handling* on page 549. In the case that the CmpLst bit is set to zero and the DCRT bit is set to one, the Number of Blocks field *shall* be ignored and the number of addressable blocks *shall* be retained. In other cases, the Number of Blocks field specifies the number of addressable blocks for the whole disc and the Type Dependent Parameter field specifies the Block Length. Neither field is changeable from the values reported by the READ FORMAT CAPACITIES command.

On CD-RW media, the whole media *shall* be formatted using the Write Parameters mode page.

On DVD-RW SL media, this format operation is available on any recording mode and any state of a Bordered Area. The area from the beginning of the RMA to the end of the Lead-out *shall* be recorded. There is only one Bordered Area on the medium and the number of RZone is one after this operation. The Disc Status field of Format 3 RMD *shall* be set to 12h when the operation is completed.

On DVD-RW DL media, this format operation is available on any disc status and any RZone condition. The area from the beginning of the RMA to the end of the Middle Area on both Layers *shall* be recorded. The physical disc state *shall* be in Complete state, the RZone *shall* be in Contiguous condition and the Disc Status field of Format3 RMD *shall* be set to 12h when this operation is completed. The host can adjust the Number of Blocks field value less than or equal to the value reported by the READ FORMAT CAPACITIES command for this Format Type. If the specified Number of Blocks field value is not the integer multiple of the Blocking size, the logical unit *shall* round it up to the integer multiple of the Blocking size. Faster formatting method *shall* be applied to this format, but the recorded user data is not necessary guaranteed to be preserved.

On HD DVD-RW media, this format operation is available for any state. After this format operation is completed the disc state becomes Finalized state or Full-finalized state. Middle Area *shall not* be changed. See section 5.15.2.5, "*Full-finalized state*" on page 393 for HD DVD-RW SL or section 5.16.2.4, "*Full-finalized state*" on page 420 for HD DVD-RW DL. A part of Data Area to be formatted whose ECC block pair bit is set to 1 should not be written again. The Disc Status field of RMD *shall* be set to 12h or 22h and Last PSN of RZone field of R-PFI *shall* be changed to reflect the created addressable area when the operation is completed.

17.3.2 Formatting on Format Type = 01h (Spare Area Expansion)

In order to keep more space as Spare area, this formatting is used. Eventually the capacity of the formatted area is reduced. Therefore, this formatting type is just available with the case of reduction of formatted capacity.

The logical unit *shall* ignore the defect list handling specified by the combination of the CmpLst bit and the DCRT bit. The defect list entries and the written user data within the range of the area that is specified by this command *shall* be preserved through the execution of this command. The Number of Blocks field specifies the number of addressable blocks for the whole disc and the Type Dependent Parameter field specifies the Block Length. Neither field is changeable from the values reported by the READ FORMAT CAPACITIES command.

17.3.3 Formatting on Format Type = 04h (Obsolete)

The Zone Reformat operation on DVD-RAM media is obsolete.

17.3.4 Formatting on Format Type = 05h (Obsolete)

The Zone Format operation is obsolete.

17.3.5 Formatting on Format Type = 10h (-RW Full Format)

This format operation is available for CD-RW, DVD-RW and HD DVD-RW media.

Formatting to create a Session/Border on a medium is specified. The created Session/Border *shall* become the only Session/Border on the medium. The Number of Blocks field specifies the number of addressable blocks for the new Session/Border and the Type Dependent Parameter field specifies the Fixed Packet Size for CD or set to ECC block size in sectors for DVD/HD DVD (i.e., 16 for DVD-RW, 32 for HD DVD-RW). The Number of Blocks field may be adjusted to a value less than or equal to the values reported by the READ FORMAT CAPACITIES command. The logical unit *shall* round the Number of Blocks up to be an integral multiple of the packet size for CD or the ECC block size for DVD/HD DVD. The Packet Size field may not be adjusted. In the case of CD media, if a different Fixed Packet Size is desired, the host *shall* modify the Write Parameters mode page.

On DVD-RW SL media, this format operation is available on any recording mode and any state of a Bordered Area. The number of RZone in the created Border is one after this operation. The Disc Status field of Format 3 RMD *shall* be set to 12h when the operation is completed.

On DVD-RW DL media, this format operation is available on any disc status and any RZone condition. The area from the beginning of the RMA to the end of the Middle Area on both Layers *shall* be recorded. The physical disc state *shall* be in Complete state, the RZone *shall* be in Contiguous condition and the Disc Status field of Format3 RMD *shall* be set to 12h when this operation is completed. The host can adjust the Number of Blocks field value less than or equal to the value reported by the READ FORMAT CAPACITIES command for this Format Type. If the specified Number of Blocks field value is not the integer multiple of the Blocking size, the logical unit *shall* round it up to the integer multiple of the Blocking size. All the sectors in the area to be formatted *shall* be overwritten during this format operation regardless the sectors have been recorded or not.

On HD DVD-RW media, this format operation is identical to Full format (Format Type = 00h).

17.3.6 Formatting on Format Type = 11h (Grow Session)

This format operation is available for CD-RW, DVD-RW and HD DVD-RW media.

Formatting to expand the last Session/Border on a medium is specified. The Number of Blocks field specifies the number of addressable blocks to be added to current Session/Border capacity and the Type Dependent Parameter field specifies the Packet Length for CD or set to ECC block size in sectors for DVD/HD DVD (i.e., 16 for DVD-RW and 32 for HD DVD-RW). The logical unit *shall* round the Number of Blocks up to be an integral multiple of the packet size for CD or the ECC block size for DVD/HD DVD. The Packet Size field may not be adjusted.

On DVD-RW SL media, this format operation is available only when a disc is in Restricted overwrite mode and the last Bordered Area is in a Complete state. Growing of Border operation *shall* start from the next sector of End Sector Number of RZone #n field that is corresponded to the last RZone. End PSN of Data Area and Start PSN of the

current Border-out field of Lead-in/Border-in *shall* be changed to reflect the expanded Bordered Area. The number of Bordered Areas and RZones does not change after this operation.

On DVD-RW DL media, this format operation is available only to the disc whose physical disc state is Complete state and the RZone is in Contiguous condition. If the physical disc state is in Blank state or in Intermediate state, or the RZone is in Non-contiguous condition, the logical unit *shall* terminate the command with CHECK CONDITION status, 5/26/00 INVALID FIELD IN PARAMETER LIST. Faster formatting method *shall* be applied to this format. The physical disc state *shall* be in Complete state and the RZone *shall* be in Contiguous condition when this operation is completed. The Number of Blocks field specifies the capacity to be expanded. The capacity of the formatted disc *shall* become the original size plus the requested size.

On HD DVD-RW media, this format operation is available for Finalized state in Sequential formatting mode. This format operation *shall* start from the next sector of last sector of addressable area. Middle Area *shall not* be changed. A part of Data Area to be formatted whose ECC block pair bit is set to 1 should not be written again. The Disc Status field of RMD *shall* be set to 12h or 22h and Last PSN of RZone field of R-PFI *shall* be changed to reflect the expanded addressable area when the operation is completed. When the Middle Area is not located in the original area, this format is not available.

17.3.7 Formatting on Format Type = 12h (Obsolete)

The Add Session format operation on CD-RW and DVD-RW SL media is obsolete.

17.3.8 Formatting on Format Type = 13h (Quick Grow Session)

This format operation is available for DVD-RW and HD DVD-RW media.

Formatting to expand the last Border and enter the last Bordered Area into Intermediate state of a medium is specified. The Number of Blocks field specifies the number of addressable blocks to be added to current Border capacity and the Type Dependent Parameter field is set to ECC block size in sectors. The logical unit *shall* round the Number of Blocks up to be an integral multiple of the ECC block size.

On DVD-RW media, this format operation is available only when the disc is in Restricted overwrite mode and the last Bordered Area is complete state. Growing of border operation *shall* start from the next sector of End Sector Number of RZone #n field that is corresponded to the last RZone.

On DVD-RW media, the number of Bordered Areas and RZones does not change after this operation. The Disc Status field of Format 3 RMD *shall* be set to 13h when the operation is completed. End PSN of Data Area field in Lead-in/Border-in of the last Border *shall* be set to 30000h. And Start PSN of the current Border-out and Start PSN of the next Border-in field in Lead-in/Border-in of the last Border *shall* be set to 00h.

On DVD-RW DL media, this format operation is available only to the disc whose physical disc state is in Complete state. If the physical disc state is Intermediate state, the logical unit *shall* terminate the command with CHECK CONDITION status, 5/26/00 INVALID FIELD IN PARAMETER LIST. If the RZone is in Non-contiguous condition, the Number of Blocks field *shall* be set to zero. Otherwise, the logical unit *shall* terminate the command with CHECK CONDITION status, 5/26/00 INVALID FIELD IN PARAMETER LIST. If the logical unit does not support LJ Rigid Restricted Overwrite Feature and the RZone of the mounted disc is in Non-contiguous condition, the logical unit *shall* terminate the command with CHECK CONDITION status, 5/26/00 INVALID FIELD IN PARAMETER LIST. Faster formatting method *shall* be applied to this format. The physical disc state *shall* be Intermediate state and the original RZone condition *shall* be kept when this operation is completed. If the RZone is in Contiguous condition, the logically recorded area of the formatted disc becomes the original size plus the requested size. If the RZone is in Non-contiguous condition, the logically recorded area of the formatted disc is same as the original one.

On HD DVD-RW media, this format operation is available for Intermediate state in Sequential formatting mode and Finalized state in Sequential formatting mode. This format operation *shall* start from the next sector of last sector of addressable area. A part of Data Area to be formatted whose ECC block pair bit is set to 1 should not be written again. The Disc Status field of RMD *shall* be set to 13h and Last PSN of RZone field of R-PFI *shall* be set to 0 when the operation is completed. When the Middle Area is not located in the original area, this format is not available.

17.3.9 Formatting on Format Type = 14h (Obsolete)

The Quick Add Border format operation on DVD-RW SL is obsolete.

17.3.10 Formatting on Format Type = 15h (Quick Format)

This format operation is available for DVD-RW and HD DVD-RW media.

Formatting to create a Intermediate state Border on a medium is specified. The created Border *shall* become the only Border on the medium. The Number of Blocks field specifies the number of addressable blocks for the new Border and the Type Dependent Parameter field is set to ECC block size in sectors. The host can adjust the Number of Blocks field value less than or equal to the value reported by the READ FORMAT CAPACITIES command for this Format Type. If the specified Number of Blocks field value is not the integer multiple of the Blocking size, the logical unit *shall* round it up to the integer multiple of the Blocking size.

On DVD-RW media, this format operation is available on any recording mode and any state of a Bordered Area. If a disc is to be formatted that is in Sequential recording mode, new intermediate state Bordered Area is created at the beginning of the disc and the recording mode is changed to Restricted overwrite mode. The number of RZone in the created Border is one after this operation. The Disc Status field of Format 3 RMD *shall* be set to 13h when the operation is completed.

On DVD-RW DL media, Faster formatting method *shall* be applied to this format. The physical disc state *shall* be in Intermediate state and the RZone *shall* be in Contiguous condition when this operation is completed.

On HD DVD-RW media, this format operation is available for any state. This format operation *shall* start from the first sector of Data Area. A part of Data Area whose ECC block pair bit is set to 1 should not be written again. The Disc Status field of RMD *shall* be set to 13h and Last PSN of RZone field of R-PFI *shall* be set to 0 when the operation is completed.

17.3.11 Formatting on Format Type = 16h (Test Zone Expansion)

This format operation is available for HD DVD-R SL media.

In order to keep more space as Test Zone, this formatting is used. Eventually the capacity of the Data Area is reduced.

The FOV, DPRY, DCRT, STPF, IP, Try-out and VS bit *shall* be set to 0. The Number of Blocks field and the Type Dependent Parameter field *shall* be ignored.

The Test Zone can be extended only once. Attempting to extend the Test Zone when the Test Zone is already extended, the command *shall* be terminated with CHECK CONDITION status, 5/72/07 NO MORE TEST ZONE EXTENSIONS ARE ALLOWED. See 5.13.8, "Test Zone extension" on page 354 and 5.13.12.8, "Error reporting for "Test Zone extension" by using FORMAT UNIT command" on page 364.

This Format Type is used for extending Test zone in HD DVD-R media. Then the Formattable Capacity Descriptor(s) *shall not* be returned by the READ FORMAT CAPACITIES command.

For HD DVD, the Error reporting for the command in each condition of the media is shown in Table 198 - Error reporting for "Test Zone extension" by using FORMAT UNIT command (1) on page 364.

17.3.12 Formatting on Format Type = 17h (Instant Recording Setup for L1)

This format operation is available for HD DVD-R DL and HD DVD-RW DL media.

In order to minimize time for crossing the layers during recording, this formatting is used. See 5.14.2.1, "Preparation for recording L1" on page 367.

The FOV, DPRY, DCRT, STPF, IP, Try-out and VS bit *shall* be set to 0. The Number of Blocks field and the Type Dependent Parameter field *shall* be ignored.

If Guard Track Zones on L0 already has been written, no operation *shall* occur and this *shall not* be considered an error.

The Formattable Capacity Descriptor(s) *shall not* be returned by the READ FORMAT CAPACITIES command.

17.3.13 Formatting on Format Type = 18h (Fast Re-format)

This format operation is available for DVD-RW DL media.

Formatting to create a Border is specified. This format operation is available on any disc status and any RZone condition. The area from the beginning of the RMA to the end of the Middle Area on both Layers *shall* be recorded. The Format Operation Code field of Format 3 RMD *shall* be set to 07h when this operation is started. The physical disc state *shall* be in Complete state, the RZone *shall* be in Contiguous condition and the Disc Status field of Format 3 RMD *shall* be set to 12h when this operation is completed.

The Number of Blocks field specifies the number of addressable blocks for the new Border. The host can adjust the Number of Blocks field value less than or equal to the value reported by the READ FORMAT CAPACITIES command for this Format Type. If the specified Number of Blocks field value is not the integer multiple of the Blocking size, the logical unit *shall* round it up to the integer multiple of the Blocking size.

The Type Dependent Parameter field *shall* be ignored.

Faster formatting method *shall* be applied to this format, and the recorded user data within the formatted area *shall* be guaranteed to be preserved.

17.3.14 Formatting on Format Type = 19h (Fragment recording Format)

This format operation is available for HD DVD-RW media.

Formatting to create Intermediate state disc in Fragment recording mode is specified.

If a logical unit does not support Background Padding, the logical unit *shall* set BGP bit in HD DVD-RW Fragment Recording Feature Descriptor to 0. If the FORMAT UNIT command with Format Type 19h is issued, the logical unit *shall* record RMD and R-PFI if needed.

If a logical unit supports Background Padding the logical unit *shall* set the BGP bit of HD DVD-RW Fragment Recording Feature Descriptor to 1. If the FORMAT UNIT command with Format Type 19h is issued, the logical unit *shall* perform Background Padding. The disc state becomes Full-finalized state after the formatting is completed. Even if Background Padding is in progress, any part of original Data Area is addressable¹. Logical unit *shall* pad all of ECC block pair whose status of the ECC block pair status bit map is 0b with 00h data whose Area type is Data Area and record the original Lead-out Area and Lead-in Area.

17.3.15 Formatting on Format Type = 20h (Obsolete)

The Full Format with sparing parameters operation is obsolete.

17.3.16 Formatting on Format Type = 24h (MRW Format)

See MMC.

17.3.17 Formatting on Format Type = 26h (DVD+RW Basic Format)

See MMC.

17.3.18 Formatting on Format Type = 30h (BD-RE Format with Spare Areas)

See MMC.

17.3.19 Formatting on Format Type = 31h (BD-RE Format without Spare Areas)

See MMC.

17.3.20 Formatting on Format Type = 32h (BD-R Format with Spare Areas)

See MMC.

1. There are some restrictions for writing. See 5.15.4.3, "Restriction of writing" on page 395 and 5.16.4.2, "Restriction of writing" on page 422.

Table 335 describes errors that may occur during the operation of the command or which may cause a CHECK CONDITION status to be reported.

Table 335 - FORMAT UNIT command errors

Error Description
<i>A-1.1, "Deferred Error Reporting" on page 919</i>
<i>Table 835 - Basic Error Codes on page 932</i>
<i>Table 836 - Media Access Error Codes on page 935</i>
<i>Table 837 - Write Error Codes on page 938</i>

17.4 GET CONFIGURATION command

This command is intended to provide information to the host about the overall capabilities of the logical unit and the current capabilities of the logical unit. Configurations reported by logical units, for example, are used by the host for Driver Identification/loading and other user presentation processes.

The GET CONFIGURATION command requests that the logical unit respond with the configuration of the logical unit and medium. The configuration of the logical unit is described by Features (see *Section 15.0, "Features"* on page 515). The maximum number of Features is 65 536; the maximum number of bytes that a logical unit may return to describe its Features in one command is 65 534. Feature lists longer than 65 534 bytes require multiple commands.

Persistent Prevent may be used to control when morphing occurs. If a Persistent Prevent is enabled, the configuration should not change except under host control. See *15.2, "Morphing commands and functionality"* on page 518 for more information on the interoperation of these commands.

This command **shall not** return a CHECK CONDITION status due to a pending UNIT ATTENTION condition. Any pending UNIT ATTENTION condition **shall not** be cleared for the logical unit issuing the GET CONFIGURATION command.

Table 336 - GET CONFIGURATION Command Descriptor Block

Bit Byte	7	6	5	4	3	2	1	0
0	Operation Code (46h)							
1	LUN (Obsolete)			Reserved			RT	
2	(MSB) Starting Feature Number (LSB)							
3								
4	Reserved							
5	Reserved							
6	Reserved							
7	(MSB) Allocation Length (LSB)							
8								
9	Vendor-Specific		Reserved			NACA	Flag	Link
10	PAD							
11								

The Requested Type (RT) field indicates the set of Feature Descriptors desired from the logical unit.

Table 337 - RT field definition

RT field	Description	Starting Feature Number (SFN) Usage
00b	Indicates that the logical unit shall return the Feature Header and all Feature Descriptors supported by the logical unit whether or not they are currently active.	The first Feature Descriptor returned shall have a Feature number greater than or equal to the SFN.
01b	Indicates that the Feature Header and only those Feature Descriptors that have their Current bit set shall be returned.	
10b	Indicates that exactly one Feature Header and zero or one Feature Descriptors be returned. If the logical unit does not support the indicated Feature, no Feature Descriptor is returned. Note: this may be used to request Feature 0, which is a list of Profiles.	The SFN specifies the Feature Descriptor that shall be returned.
11b	Reserved	

The Starting Feature Number indicates the first Feature number to be returned. See Table 337 for more complete definition.

The Allocation Length field specifies the maximum length in bytes of the GET CONFIGURATION Response Data. An Allocation Length field of zero indicates that no data *shall* be transferred. This condition *shall not* be considered an error.

17.4.1 GET CONFIGURATION response data

The Response Data is a Configuration Data list and *shall* contain a header followed by zero or more variable length Feature Descriptors. The format of the Configuration Data is shown in Table 338.

Table 338 - GET CONFIGURATION response data format

Bit Byte	7	6	5	4	3	2	1	0
0-7	Feature Header							
8-n	Feature Descriptor(s)							

The Feature Header *shall* be returned as shown in Table 339.

The Feature Descriptor(s) *shall* be returned as shown in Table 341 - *Feature Descriptor generic format* on page 564 and in each individual Feature description.

Table 339 - Feature Header

Bit Byte	7	6	5	4	3	2	1	0
0	(MSB) Data Length (LSB)							
1								
2								
3								
4	Reserved							
5	Reserved							
6	(MSB) Current Profile (LSB)							
7								

The Data Length field indicates the amount of data available given a sufficient Allocation Length following this field. This length *shall not* be adjusted due to an insufficient Allocation Length. If the Data Length is greater than 65 530 bytes, multiple GET CONFIGURATION commands with different Starting Feature Numbers will be required for the host to read all configuration data. This field is adjusted as appropriate for the given Starting Feature Number.

The Current Profile field *shall* indicate the logical unit's current Profile. The logical unit *shall* choose the most appropriate current Profile from the list of Profiles with their CurrentP bit set. If no Profile is current, this field *shall* contain zero.

17.4.2 Features

Features are the smallest implementable set of commands, Pages, and behavior. Table 340 lists defined Features.

Table 340 - Feature List

Feature Number	Feature Name	Description
0000h	Profile List	A list of all Profiles supported by the logical unit
0001h	Core	Mandatory behavior for all logical units
0002h	Morphing	The ability to notify host about operational changes and accept host requests to prevent operational changes.
0003h	Removable Medium	The medium may be removed from the logical unit
0004h	Write Protect	The ability to control write protection status
0005h-000Fh	Reserved	Reserved
0010h	Random Readable	Read ability for storage logical units with random addressing
0011h-001Ch	Reserved	Reserved
001Dh	MultiRead	The logical unit can read all CD media types; based on OSTA MultiRead
001Eh	CD Read	The ability to read CD specific structures
001Fh	DVD Read	The ability to read DVD specific structures
0020h	Random Writable	Write support for randomly addressed writes
0021h	Incremental Streaming Writable	Write support for sequential recording
0022h	Obsolete (Sector Erasable)	Obsolete
0023h	Formattable	Support for formatting of media
0024h	Hardware Defect Management	The ability of the logical unit/media system to provide an apparently defect-free space
0025h	Write Once	Write support for write once media that may be written in random order
0026h	Restricted Overwrite	Write support for media that <i>shall</i> be written from Blocking boundaries only
0027h	CD-RW CAV Write	The ability to write high speed CD-RW media
0028h	MRW	See MMC
0029h	Enhanced Defect Reporting	The ability to control RECOVERED ERROR reporting
002Ah	DVD+RW	See MMC
002Bh	DVD+R	See MMC
002Ch	Rigid Restricted Overwrite	Write support for media that <i>shall</i> be written from Blocking boundaries with length of integral multiple of Blocking size only
002Dh	CD Track at Once	The ability to write CD with Track at Once recording
002Eh	CD Mastering	The ability to write CD with Session at Once or Raw write methods.
002Fh	DVD-R/-RW Write	The ability to write DVD specific structures
0030h-0032h	Reserved	These values were assigned to DDCD media. See MMC-4.
0033h	Layer Jump recording	The ability to perform Layer Jump recording mode
0034h	LJ Rigid Restricted Overwrite	The ability to perform Layer Jump recording on Rigid Restricted Over-writable media
0035h	Stop Long Operation	The ability to stop the long immediate operation by a command.
0036h	Reserved	Reserved
0037h	CD-RW Media Write Support	See MMC
0038h	BD-R Pseudo Overwrite Feature	See MMC
0039h	Reserved	Reserved

Table 340 - Feature List (continued)

Feature Number	Feature Name	Description
003Ah	DVD+RW Dual Layer	See MMC
003Bh	DVD+R Dual Layer	See MMC
003Ch-003Fh	Reserved	Reserved
0040h	BD Read	See MMC
0041h	BD Write	See MMC
0042h	TSR	See MMC
0043h-004Fh	Reserved	Reserved
0050h	HD DVD Read	The ability to read HD DVD specific structures
0051h	HD DVD Write	The ability to write HD DVD specific structures
0052h	HD DVD-RW Fragment Recording	The ability to write a medium with Fragment recording mode
0053h-007Fh	Reserved	Reserved
0080h	Hybrid disc	The ability to handle Hybrid disc structures
0081h-00FFh	Reserved	Reserved
0100h	Power Management	Host and logical unit directed power management
0101h	S.M.A.R.T.	Self Monitoring Analysis and Reporting Technology (Failure prediction)
0102h	Embedded Changer	Single mechanism multiple disc changer
0103h	CD Audio analog play	The ability to play audio CDs via the drive's own analog output
0104h	Microcode Upgrade	The ability for the logical unit to accept new microcode via the interface
0105h	Timeout	The ability to respond to all commands within a specific time
0106h	DVD CSS	The ability to perform DVD CSS/CPPM authentication and RPC
0107h	Real-Time Streaming	The ability to read and write using host requested performance parameters
0108h	Logical unit Serial Number	The logical unit has a unique identifier.
0109h	Media Serial Number	See MMC
010Ah	Disc Control Blocks	The ability to read and/or write Disc Control Blocks
010Bh	DVD CPRM	The ability to perform DVD CPRM authentication
010Ch	Firmware Information	The ability to report firmware information of the logical unit
010Dh	AACS	The ability to perform AACS authentication
010Eh	DVD CSS Managed recording	The ability to perform DVD CSS Managed recording
010Eh-010Fh	Reserved	Reserved
0110h	VCPS	See MMC
0111h-0112h	Reserved	Reserved
0113h	SecurDisc	The ability to decode and encode SecurDisc protected information
0114h-FEFFh	Reserved	Reserved
FF00h-FFFFh	Vendor Unique	

Features are related by Profiles. An example of some of the relationships is shown in Figure 219. This diagram shows in a graphic form Features that are defined in this specification. Each Feature is represented by a block in the diagram. Each Feature also shows an abbreviated list of the requirements for that Feature. This diagram serves as an example to help the reader understand the Features described in this specification, but **should not be used as a reference** for Feature implementation. For information on the exact Features and their requirements, see *Section 15.0, "Features"* on page 515. In some cases, Features are independent of other Features. The hierarchical relationship shown in the diagram is given by Profiles. If a Feature is placed underneath another Feature, then the overlaying Feature is usually not implemented without the functionality of the underlying Feature. Items in quotes indicate a functionality that is required but is not a specific command or Page.

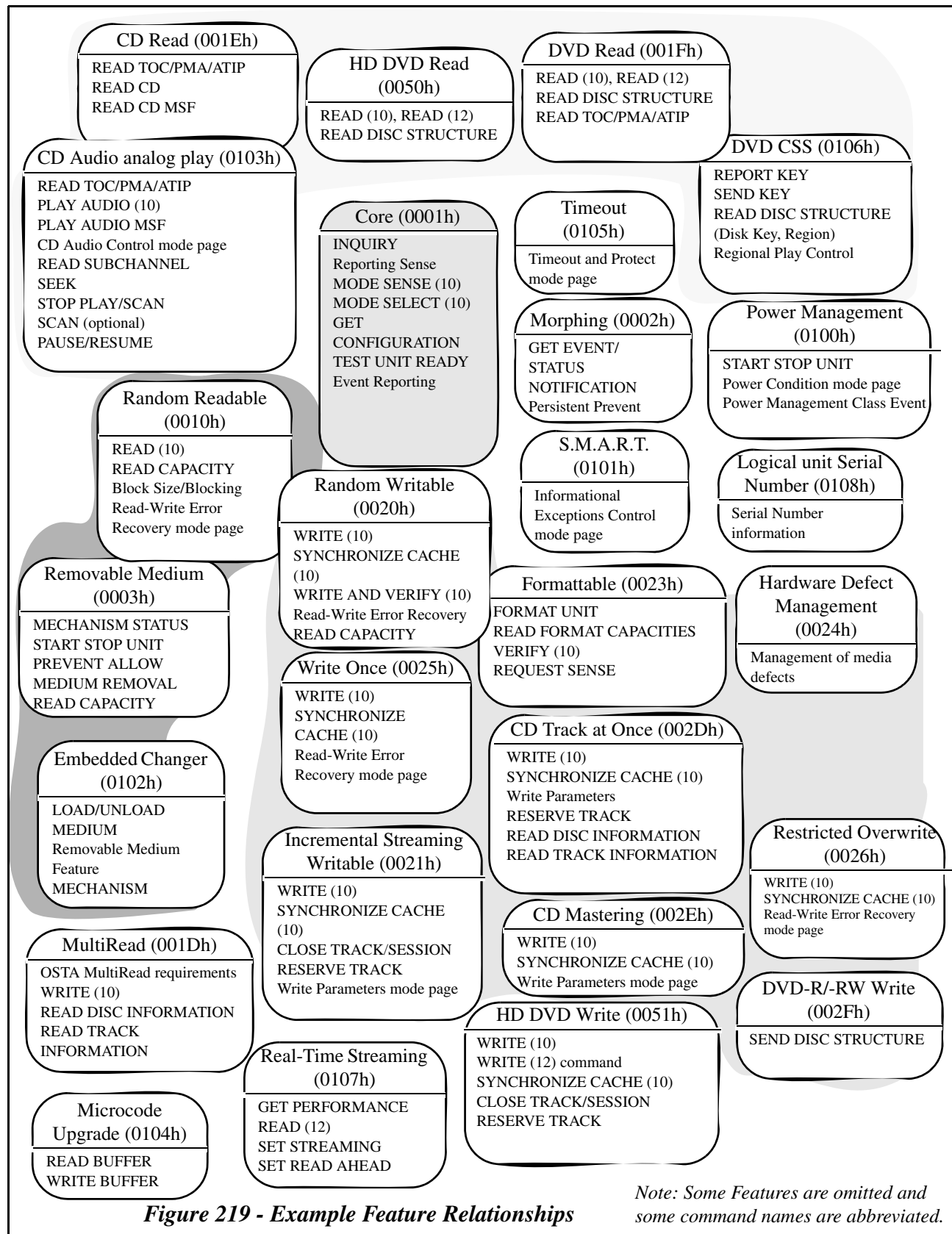


Figure 219 - Example Feature Relationships

Note: Some Features are omitted and some command names are abbreviated.

Each Feature supported by a logical unit *shall* be described by a Feature Descriptor. Each Feature Descriptor has its own parameters. All Features *shall* be a multiple of four bytes long. The format of a Feature Descriptor is shown in Table 341.

Table 341 - Feature Descriptor generic format

Bit Byte	7	6	5	4	3	2	1	0
0	(MSB) Feature Code (LSB)							
1								
2	Reserved		Version				Persistent	Current
3	Additional Length							
4-n	Feature Dependent Data							

The Feature Code field *shall* identify a Feature supported by the logical unit.

The Version field *shall* be set to zero unless otherwise specified within the Feature description. Future versions of a Feature will be backward compatible, but may contain extra information; incompatible changes will be included in a different Feature. Table 864 - *Feature Descriptor Version* on page 989 shows the current version of each Feature Descriptor.

The Persistent bit, when set to zero, *shall* indicate that this Feature may change its current status. When set to one, *shall* indicate that this Feature is always active. The logical unit *shall not* set this bit to one if the Current bit is, or may become, zero.

The Current bit, when set to zero, indicates that this Feature is not currently active and that the Feature Dependent Data may not be valid. When set to one, this Feature is currently active and the Feature Dependent Data is valid.

The Additional Length field indicates the number of Feature specific bytes that follow this header. This field *shall* be an integral multiple of 4.

17.4.2.1 Feature 0000h: Profile List

The Profile List Feature is a Feature to report a list of all Profiles supported by a logical unit. This Feature is always current. The only change allowed in the Profile List Feature during morphing is the setting of the CurrentP bits for each Profile. Logical units that support removable media *shall not* have any current Profiles listed. Profile 0 *shall not* be reported in the Profile List, but may be reported in the Current Profile field of the GET CONFIGURATION header to indicate compliance to no Profile.

Profiles provide a quick method for identifying the basic functionality of logical units. Logical units may conform to more than one Profile at a time. For example, a DVD-RAM logical unit with DVD-RAM media loaded may report both the Removable Disk and DVD-RAM Profiles. This allows generic removable disk drivers to work with DVD-RAM media while also reporting the additional capabilities required by the DVD-RAM Profile.

Table 342 - Profile List Feature Descriptor

Bit Byte	7	6	5	4	3	2	1	0
0	(MSB) Feature Code = 0000h (LSB)							
1								
2	Reserved		Version				Persistent	Current
3	Additional Length							
4-n	Profile Descriptor(s)							

The Feature Code field *shall* be set to 0000h.

The Version field is reserved and *shall* be set to zero. Future versions of a Feature will be backward compatible; incompatible changes will be included in a different Feature.

The Persistent bit *shall* be set to one to indicate that the reporting of the Profile list is persistently supported.

The Current bit *shall* be set to one.

The Additional Length field *shall* be set to ((number of Profile Descriptors) * 4).

The Profile Descriptors are shown in Table 343. All Profiles supported by the logical unit *shall* be reported. Profile Descriptors are returned in the order of preferred operation - most desirable to least desirable. E.g., a HD DVD-RAM that could also read DVD-ROM and CD-ROM would list the HD DVD-RAM Profile first, the DVD-ROM Profile second, and the CD-ROM Profile third.

Table 343 - Profile Descriptor

Bit Byte	7	6	5	4	3	2	1	0
0	(MSB) Profile Number							(LSB)
1								
2	Reserved							CurrentP
3	Reserved							

The Profile Number identifies a Profile to which the logical unit conforms. See Table 344.

The CurrentP bit, when set to one, *shall* indicate that this Profile is active. If no medium is present, no Profile should be active. Multifunction logical units *shall* select the most appropriate Profile(s), if any, to set as current. The most appropriate current Profile is also reported in the Feature Header - see Table 339 - *Feature Header* on page 560.

Table 344 - Profile List

Profile Number	Profile Name	Description
0000h	Reserved	
0001h	Obsolete	Rewritable disk capable with unchanging behavior
0002h	Removable disk	Writable disk capable with removable media
0003h	Obsolete	-
0004h	Obsolete	-
0005h	Obsolete	-
0006h-0007h	Reserved	
0008h	CD-ROM	Read only Compact Disc capable
0009h	CD-R	Write once Compact Disc capable
000Ah	CD-RW	ReWritable Compact Disc capable
000Bh-000Fh	Reserved	
0010h	DVD-ROM	Read only DVD
0011h	DVD-R Sequential recording	Write once DVD using Sequential recording
0012h	DVD-RAM	Rewritable DVD
0013h	DVD-RW Restricted Overwrite	Re-recordable DVD using Restricted Overwrite
0014h	DVD-RW Sequential recording	Re-recordable DVD using Sequential recording

Table 344 - Profile List (continued)

Profile Number	Profile Name	Description
0015h	DVD-R Dual Layer Sequential recording	Write once DVD using Sequential recording
0016h	DVD-R Dual Layer Jump recording	Write once DVD using Layer Jump recording
0017h	DVD-RW Dual Layer	Re-recordable DVD for Dual Layer
0018h	DVD-Download disc recording	Write once DVD for CSS managed recording
0019h	Reserved	Reserved
001Ah	DVD+RW	See MMC
001Bh	DVD+R	See MMC
001Ch-003Fh	Reserved	Reserved
0040h	BD-ROM	See MMC
0041h	BD-R Sequential Recording Mode (SRM)	See MMC
0042h	BD-R Random Recording Mode (RRM)	See MMC
0043h	BD-RE	See MMC
0044h-004Fh	Reserved	Reserved
0050h	HD DVD-ROM	Read only HD DVD
0051h	HD DVD-R	Write once HD DVD
0052h	HD DVD-RAM	Rewritable HD DVD
0053h	HD DVD-RW	Re-recordable HD DVD
0054h-0057h	Reserved	Reserved
0058h	HD DVD-R Dual Layer	Write once HD DVD Dual Layer
0059h	Reserved	Reserved
005Ah	HD DVD-RW Dual Layer	Re-recordable HD DVD Dual Layer
005Bh-FFFEh	Reserved	Reserved
FFFFh	Logical units Not Conforming to a Standard Profile	The logical unit does not conform to any Profile.

Example: A DVD-ROM with CD-ROM read capability would always report two Profiles. If no medium were present, the **Current Profile** field in the Feature Header would contain 0, and the **CurrentP** bits in both Profile Descriptors would be set to zero. If DVD-ROM media were inserted, the only change would be to set the **CurrentP** bit of the DVD-ROM Profile to one. If CD-ROM media were then inserted, the **CurrentP** bit of the DVD-ROM Profile would be set to zero and the **CurrentP** bit of the CD-ROM Profile would be set to one.

17.4.2.2 Feature 0001h: Core

This Feature describes basic logical unit functionality. This Feature *shall* be current. All commands and functions described *shall* function normally.

Table 345 - Core Feature Descriptor

Bit Byte	7	6	5	4	3	2	1	0
0	(MSB)							
1	Feature Code = 0001h							(LSB)
2	Reserved		Version = 2h			Persistent	Current	
3	Additional Length = 08h							
4	(MSB)							
5	Physical Interface Standard							(LSB)
6								
7								
8	Reserved					INQ2	DBEvent	
9	Reserved							
10	Reserved							
11	Reserved							

The Feature Code field *shall* be set to 0001h.

The Version field *shall* be set to 2h.

The Persistent bit *shall* be set to one.

The Current bit *shall* be set to one.

The Additional Length field *shall* be set to 08h.

The Physical Interface Standard field *shall* be set to the current host to logical unit communication path as shown in Table 346.

The INQ2 bit, when set to one, indicates that the logical unit supports 2-byte length Allocation Length field and the EVPD value of 1 in the INQUIRY Command Descriptor Block and the Vital Product Data (VPD pages 00h and 83h) defined in SPC-3. If this bit is set to zero, it indicates that the logical unit may not support the 2-byte length Allocation Length field and the logical unit may not support the Vital Product Data defined in SPC-3.

The Device Busy Class Events (DBEvent) bit *shall* be set to one. When this bit is set to one, the Device Busy Class of the GET EVENT/STATUS NOTIFICATION command *shall* be supported. Device Busy Class Events provides progress indication in time unit. When this bit is set to zero, the response data of the Device Busy Class Events is not defined in this document.

Note: If the Version field is set to 0 or if the Additional Length field is set to 04h, the response data of the Device Busy Class Events is not reliable due to the unclear description of the old version of this document.

Table 346 - Physical Interface Standard

Physical Interface Standard	Description	Application
00000000h	Unspecified	
00000001h	SCSI Family	See <i>Appendix C - "SCSI Implementation Notes (Normative)"</i> on page 953
00000002h	ATAPI	See <i>Appendix B - "ATAPI Implementation Notes (Normative)"</i> on page 941
00000003h	IEEE 1394-1995 Family	
00000004h	IEEE 1394a	
00000005h	Fibre Channel	See Fibre Channel (FCP) Implementation
00000006h	IEEE 1394b	
00000007h	Serial ATAPI	
00000008h	USB (1.1 and 2.0)	
00000009h-0000FFFEh	Reserved	
0000FFFFh	Vendor Unique	
00010000h-0001FFFFh	Defined by INCITS	
00020000h-0002FFFFh	Defined by SFFC	
00030000h-0003FFFFh	Defined by IEEE	
00040000h-FFFFFFFh	Reserved	

Table 347 shows the mandatory commands to implement this Feature.

Table 347 - Mandatory commands for Core Feature

OpCode	Commands
00h	TEST UNIT READY
03h	REQUEST SENSE
12h	INQUIRY
46h	GET CONFIGURATION
4Ah	GET EVENT/STATUS NOTIFICATION
55h	MODE SELECT (10)
5Ah	MODE SENSE (10)

Supplementary explanation for commands to implement this Feature:

- **TEST UNIT READY:**
This command is a legacy command used to check for the existence of media and to discover UNIT ATTENTION conditions. The GET CONFIGURATION or GET EVENT/STATUS NOTIFICATION commands should be used instead to determine media status.
- **REQUEST SENSE:**
Logical units *shall* be able to report sense to the host. For logical interfaces that report automatic delivery of logical unit Sense Information to the host *shall* use the transport's mechanism. For other logical interfaces, this command *shall* be supported. This command *shall not* generate any new sense information unless the Command Packet is invalid.
- **INQUIRY:**
This command *shall* complete without an error if the Command Packet is valid.
- **GET CONFIGURATION:**

UNIT ATTENTION conditions *shall not* be reported to this command.

- GET EVENT/STATUS NOTIFICATION:
Logical units *shall* be able to report Events to the host. For logical interfaces that support Event reporting to the host *shall* use the transport's mechanism. For other logical interfaces, this command *shall* be supported. The host should determine supported events by issuing this command with the Immediate (*Immed*) bit set. Zero or more Event Classes may be supported.
- MODE SELECT (10):
The Save Pages (*SP*) bit may not be supported. Logical units *shall* be able to accept mode pages whether or not appropriate media is loaded.
- MODE SENSE (10):
Logical units may not return Block Descriptors. Page Control (*PC*) field values of 00b, 01b, and 10b *shall* be supported for all supported mode pages. Logical units *shall* be able to report mode pages whether or not appropriate media is loaded.

17.4.2.3 Feature 0002h: Morphing

The Morphing Feature provides a method for identifying changes in logical unit behavior, and to some extent, preventing changes in logical unit behavior without host involvement. This Feature includes a mechanism for notifying the host about events that have occurred and requests for operational changes, a mechanism for identifying the logical unit's current behavior, and a mechanism for allowing the logical unit to change its behavior. This Feature, if implemented, *shall* be current.

Table 348 - Morphing Feature Descriptor

Bit Byte	7	6	5	4	3	2	1	0
0	(MSB) Feature Code = 0002h (LSB)							
1								
2	Reserved		Version = 1h				Persistent	Current
3	Additional Length = 04h							
4	Reserved						OCEvent	Async
5	Reserved							
6	Reserved							
7	Reserved							

The Feature Code field *shall* be set to 0002h.

The Version field *shall* be set to 1h.

The Persistent bit *shall* be set to one.

The Current bit *shall* be set to one.

The Additional Length field *shall* be set to 04h.

The Async bit, when set to zero, indicates that the logical unit supports only the polling implementation of GET EVENT/STATUS NOTIFICATION (*Immed* bit set to one). When set to one, indicates that the logical unit supports both polling and asynchronous GET EVENT/STATUS NOTIFICATION (*Immed* bit set to zero or one).

The Operational Change Request/Notification Class Events (*OCEvent*) bit *shall* be set to one. When this bit is set to one, the Operational Change Request/Notification Class of the GET EVENT/STATUS NOTIFICATION command *shall* be supported. If the *OCEvent* bit is set to zero, the response data of the Operational Change Request/Notification Class is not described in this document. The implemented logical unit behavior may not be compatible with the description of this document.

Table 349 shows the mandatory commands to implement this Feature.

Table 349 - Mandatory commands for Morphing Feature

OpCode	Commands
1Eh	PREVENT ALLOW MEDIUM REMOVAL
46h	GET CONFIGURATION
4Ah	GET EVENT/STATUS NOTIFICATION
Conditional support	
A2h	SEND EVENT

Supplementary explanation for commands to implement this Feature:

- PREVENT ALLOW MEDIUM REMOVAL:**
 The Persistent, Prevent bits *shall* be supported. When a persistent prevent is in place, the logical unit *shall not* allow, to the limit of its design, non-host events to change the operational behavior of the logical unit. Logical units with a mechanical eject may not be able to prevent ejecting the media. When a persistent prevent is in place, events are reported to the host via the GET EVENT/STATUS NOTIFICATION command instead of causing action within the logical unit. For example, if the user presses the eject button while a persistent prevent is in effect, the only action is to report the button press to the host. The logical unit *shall* behave as shown in Figure 216 - *Morphing States - Event Generation* on page 519.
- GET EVENT/STATUS NOTIFICATION:**
 The Media Class and the Operational Change Request/Notification Class *shall* be supported. Support for External Request Class Events is optional. If the Async bit is set to one, the Immed bit value of 0b and 1b *shall* be supported.
- SEND EVENT:**
 If the External Request Class is supported by the logical unit, this command *shall* be supported for any External Request Class Events that the logical unit may generate. This command is used to tell the logical unit to perform an action that was previously requested by the logical unit via a External Request Class Events. The host, after receiving a External Request Class Events, prepares for a possible logical unit change by notifying its drivers and flushing buffers as needed. After the host is prepared for a possible logical unit change, it sends the External Request Class Events descriptor back to the logical unit for processing.

17.4.2.4 Feature 0003h: Removable Medium

This Feature indicates that the logical unit has removable media. Media *shall* be considered removable if it can be removed from the loaded position, i.e. a single mechanism changer, even if the media is captive to the changer. The Feature Descriptor contains information about the logical unit and the loading of media. In particular, the Lock bit indicates the ability of the logical unit to honor at least one aspect of Persistent Prevent.

Table 350 - Removable Medium Feature Descriptor

Bit Byte	7	6	5	4	3	2	1	0
0	(MSB) Feature Code = 0003h (LSB)							
1								
2	Reserved		Version = 1h				Persistent	Current
3	Additional Length = 04h							
4	Loading Mechanism Type			Load	Eject	Pvnt Jmpr	Reserved	Lock
5	Reserved							
6	Reserved							
7	Reserved							

The Feature Code field *shall* be set to 0003h.

The Version field *shall* be set to 1h.

The Persistent bit *shall* be set to one.

The Current bit *shall* be set to one.

The Additional Length field *shall* be set to 04h.

The Loading Mechanism Type field *shall* be set according to Table 351.

Table 351 - Loading Mechanism Type

Loading Mechanism Type	Description
000b	Caddy/Slot type loading mechanism
001b	Tray type loading mechanism
010b	Pop-up type loading mechanism
011b	Reserved
100b	Embedded changer with individually changeable discs
101b	Embedded changer using a Magazine mechanism
110b-111b	Reserved

The Load bit, when set to zero, indicates that the logical unit cannot load the medium or cartridge via the normal START STOP UNIT command with the LoEj bit set. When set to one, indicates that the logical unit can load the medium or cartridge.

The Eject bit, when set to zero, indicates that the logical unit cannot eject the medium or cartridge via the normal START STOP UNIT command with the LoEj bit set. When set to one, indicates that the logical unit can eject the medium or cartridge.

The Pvnt Jmpr bit, when set to zero, *shall* indicate that the Prevent Jumper is present. The logical unit *shall* power up to the allow state and locking the logical unit with the PREVENT ALLOW MEDIUM REMOVAL command *shall not* prevent insertion of the media. When set to one, the Prevent Jumper is not present. The logical unit *shall* power up to the prevent state (locked) and *shall not* accept new media or allow the ejection of media already loaded until a PREVENT ALLOW MEDIUM REMOVAL command (allow) is issued. The Pvnt Jmpr bit *shall not* change state, even if the physical jumper is added or removed during operation. Logical units that do not have a Prevent Jumper available should set this bit to 0 to indicate that the logical unit behaves as described for a jumper being present.

The Lock bit, when set to zero, *shall* indicate that the medium cannot be locked into the logical unit. When set to one, *shall* indicate that the PREVENT ALLOW MEDIUM REMOVAL command is capable of actually locking the media into the logical unit.

Table 352 shows the mandatory commands to implement this Feature.

Table 352 - Mandatory commands for Removable Medium Feature

OpCode	Commands
1Bh	START STOP UNIT
1Eh	PREVENT ALLOW MEDIUM REMOVAL
4Ah	GET EVENT/STATUS NOTIFICATION
BDh	MECHANISM STATUS

Supplementary explanation for commands to implement this Feature:

- **START STOP UNIT:**
The Immediate (Immed) and Start bits *shall* be supported. The load eject (LoEj) bit *shall* be supported if the Eject bit in the Removable Medium Feature descriptor is set to one. A Power Condition value of 0 *shall* be supported.
- **PREVENT ALLOW MEDIUM REMOVAL:**
The Persistent bit value of zero *shall* be supported.
- **GET EVENT/STATUS NOTIFICATION:**
The logical unit *shall* generate Events for media changes. The Media Class *shall* be supported.

17.4.2.5 Feature 0004h: Write Protect

This Feature identifies reporting capability and changing capability for Write protection status of the logical unit. Current bit *shall* indicate that logical unit can currently change PWP status on the medium surface. This bit *shall* be set to zero if the logical unit can not set/release the PWP status. The reporting capability of the Write Protect status is persistent and *shall* be supported regardless of the Current bit value set to zero.

Note: If logical unit supports reporting Write Protection status but does not support changing, logical unit returns this Feature descriptor. But Current bit is never set to one in the descriptor.

Table 353 - Write Protect Feature Descriptor

Bit Byte	7	6	5	4	3	2	1	0
0	(MSB) Feature Code = 0004h (LSB)							
1								
2	Reserved		Version = 2h				Persistent	Current
3	Additional Length = 04h							
4	Reserved			DWP	WDCB	SPWP	SSWPP	
5	Reserved							
6	Reserved							
7	Reserved							

The Feature Code field *shall* be set to 0004h.

The Version field *shall* be set to 2h.

The Persistent bit *shall* be defined as in Table 341 - *Feature Descriptor generic format* on page 564. This bit *shall* be set to zero if the medium is removable.

The Current bit definition is not same as in Table 341 - *Feature Descriptor generic format* on page 564. The usage of this bit is described in the previous part of this section.

The Additional Length field *shall* be set to 04h.

The DWP bit indicates that the logical unit supports reading/writing the Disc Write Protect PAC on BD-R/-RE media. If the DWP bit is set to one, the READ/SEND DISC STRUCTURE command with Format Code = 30h *shall* be supported. See MMC for detail of Write Protect PAC.

The WDCB bit indicates that the logical unit supports writing the Write Inhibit DCB on DVD+RW media. If the WDCB bit is set to one, the SEND DISC STRUCTURE command with Format Code = 30h *shall* be supported. See MMC for detail of Write Inhibit DCB.

The Supports PWP (SPWP) bit indicates that the logical unit supports set/release PWP status. If SPWP bit is set to one, the SEND DISC STRUCTURE command with the Format Code = C0h *shall* be supported.

The Supports SWPP (SSWPP) bit indicates that the logical unit supports SWPP bit of Timeout and Protect mode page. This bit does not affect Current bit of this Feature Descriptor. If SSWPP bit is set to one, the logical unit *shall* support SWPP bit of Timeout and Protect mode page.

Table 354 shows the mandatory commands to implement this Feature.

Table 354 - Mandatory commands for Write Protect Feature

OpCode	Commands
ADh	READ DISC STRUCTURE
Conditional support	
BFh	SEND DISC STRUCTURE

Supplementary explanation for commands to implement this Feature:

- READ DISC STRUCTURE:
The Format Code field value of C0h and FFh *shall* be supported. See Section 12.2, "Write Protect Feature and related commands" on page 497. If the DWP bit is set to one, the Format Code field value of 30h *shall* also be supported.
- SEND DISC STRUCTURE:
If the DWP bit and/or WDCB bit is set to one, this command with the Format Code field value of 30h *shall* be supported. If the SPWP bit is set to one, this command with the Format Code field value of C0h *shall* be supported.

Table 355 shows the mandatory mode page to implement this Feature.

Table 355 - Mandatory mode pages for Write Protect Feature

Page Code	Mode pages
Conditional support	
1Dh	Timeout and Protect mode page

- Timeout and Protect mode page:
If the SSWPP bit is set to one, the logical unit *shall* support SWPP bit of this mode page.

17.4.2.6 Feature 0010h: Random Readable

The Random Readable Feature is for basic sector reading ability found on most storage class logical units for which data are recorded in independently addressable logical blocks which are readable in any order.

Table 356 - Random Readable Feature Descriptor

Bit Byte	7	6	5	4	3	2	1	0
0	Feature Code = 0010h							
1								
2	Reserved		Version			Persistent		Current
3	Additional Length = 08h							

Table 356 - Random Readable Feature Descriptor

Bit Byte	7	6	5	4	3	2	1	0	
4	Logical Block Size								(MSB)
5									
6									
7									
8	Blocking								(MSB)
9									
10	Reserved							PP	
11	Reserved								

The Feature Code field *shall* be set to 0010h.

The Version field *shall* be set to 0h.

The Persistent bit *shall* be defined as in Table 341 - *Feature Descriptor generic format* on page 564. This bit *shall* be set to zero if the medium is removable.

The Current bit *shall* be defined as in Table 341 - *Feature Descriptor generic format* on page 564. This bit *shall* be set to zero if random readable medium is not present.

The Additional Length field *shall* be set to 08h.

The Logical Block Size *shall* be set to the number of bytes per logical block.

The Blocking field *shall* indicate the number of logical blocks per logical unit readable unit. The Blocking field reported in the Feature Descriptor is for performance optimization only. Reads of any sector or sector count *shall* be allowed.

Note: For most CDs and hard disks, this value is 1. For DVD logical units, this number is 10h. For HD DVD logical units, this number is 20h. The Blocking field is used by the host only for performance optimization. If there is more than one Blocking on the medium possible, the Blocking field shall be set to zero. See 17.28, "READ TRACK INFORMATION command" on page 801 for more information.

The Page Present (PP) bit, when set to zero, *shall* indicate that the Read-Write Error Recovery mode page may not be present. When set to one, *shall* indicate that the Read-Write Error Recovery mode page is present.

Table 357 shows the mandatory commands to implement this Feature.

Table 357 - Mandatory commands for Random Readable Feature

OpCode	Commands
25h	READ CAPACITY
28h	READ (10)

Supplementary explanation for commands to implement this Feature:

- **READ CAPACITY:**
The Logical Block Size *shall* be reported in the Feature Descriptor. The block size for a medium may change for the entire medium after a format operation.
- **READ (10):**
This command *shall* be supported for any recorded sector. The Force Unit Access (FUA) bit *shall* be supported when a writable Feature is current. The operation of this command is modified by the Read-Write Error Recovery mode page settings.

Table 358 shows the mandatory mode page to implement this Feature.

Table 358 - Mandatory mode pages for Random Readable Feature

Page Code	Mode pages
01h	Read-Write Error Recovery mode page

Supplementary explanation for the mode page to implement this Feature:

- Read-Write Error Recovery mode page:
If the PP bit in the Feature Descriptor is set, the TB, RC, PER, DTE, and DCR bits of this mode page *shall* be supported. An Error Recovery Parameter field of 0 in this mode page *shall* be supported. Support for other bits and values in the mode page is optional. This mode page *shall not* change due to medium removal or changes. The changeable fields mask *shall not* change due to medium removal or changes. The host *shall* be able to change changeable values whether or not media is loaded.

17.4.2.7 Feature 001Dh: MultiRead

This Feature identifies a logical unit that can read all CD media types. The logical unit *shall* conform to the OSTA MultiRead specification 1.00 or greater, with the exception of CD Play capability (the CD Audio analog play Feature is not required).

Table 359 - MultiRead Feature Descriptor

Bit Byte	7	6	5	4	3	2	1	0	
0	(MSB) Feature Code = 001Dh							(LSB)	
1									
2	Reserved		Version				Persistent	Current	
3	Additional Length = 00h								

The Feature Code field *shall* be set to 001Dh.

The Version field *shall* be set to 0h.

The Persistent bit *shall* be defined as in Table 341 - *Feature Descriptor generic format* on page 564.

The Current bit *shall* be defined as in Table 341 - *Feature Descriptor generic format* on page 564.

The Additional Length field *shall* be set to 00h.

Table 360 shows the mandatory commands to implement this Feature.

Table 360 - Mandatory commands for MultiRead Feature

OpCode	Commands
28h	READ (10)
51h	READ DISC INFORMATION
52h	READ TRACK INFORMATION
BEh	READ CD

Supplementary explanation for commands to implement this Feature:

- READ DISC INFORMATION:
The Disc Information Block data of this command *shall* be supported. Logical units that do not have logical Tracks or

logical Sessions *shall* identify the media as having one session and one logical Track, numbered as Track 1. Fields that do not apply to the loaded media *shall* be marked as invalid or set to zero, as appropriate.

- **READ TRACK INFORMATION:**
Logical units that do not have logical Tracks *shall* report information as if the medium contains one logical Track encompassing all logical blocks on the medium. The support of the **Open** bit is optional.
- **READ CD:**
Reading of CD Audio data via this command *shall* be supported.

17.4.2.8 Feature 001Eh: CD Read

This Feature indicates that the logical unit is capable of reading structures specific to CD media, e.g., CD-ROM, CD-R and CD-RW, with logical formats including fixed and variable packets. When reading fixed packets, the logical unit *shall* perform Method 2 address translation. This Feature *shall* be current only if CD specific structures are available for reading.

Table 361 - CD Read Feature Descriptor

Bit Byte	7	6	5	4	3	2	1	0
0	(MSB) Feature Code = 001Eh (LSB)							
1								
2	Reserved		Version = 2h			Persistent	Current	
3	Additional Length = 04h							
4	DAP	Reserved				C2	CD-Text	
5	Reserved							
6	Reserved							
7	Reserved							

The Feature Code field *shall* be set to 001Eh.

The Version field *shall* be set to 2h.

The Persistent bit *shall* be defined as in Table 341 - *Feature Descriptor generic format* on page 564. This bit *shall* be set to zero if the medium is removable.

The Current bit *shall* be defined as in Table 341 - *Feature Descriptor generic format* on page 564. This bit *shall* be set to zero if CD medium is not present.

The Additional Length field *shall* be set to 04h.

If DAP bit is set to one, the READ CD and READ CD MSF commands support the DAP bit in bit 1, byte 1 of the CDB.

The C2 bit, when set to 1, *shall* indicate that the logical unit returns C2 error data. When set to 0, the logical unit does not support C2 error data.

The CD-Text bit, when set to 1, *shall* indicate that the logical unit supports the READ TOC/PMA/ATIP command with Format = 5. When set to 0, CD-Text is not supported.

Table 362 shows the mandatory commands to implement this Feature.

Table 362 - Mandatory commands for CD Read Feature

OpCode	Commands
43h	READ TOC/PMA/ATIP
B9h	READ CD MSF
BEh	READ CD

Supplementary explanation for commands to implement this Feature:

- READ TOC/PMA/ATIP:
The Format codes of 0h, 1h, and 2h *shall* be supported. If the CD-Text bit is set, code 5h *shall* also be supported.
- READ CD MSF:
All data forms shaded in Table 575 - *Number of Bytes Returned Based on Data Selection Field* on page 723 *shall* be supported; non-shaded forms are optional.
- READ CD:
Reading of digital audio via this command *shall* be supported. The reading of Audio Data *shall* be aligned such that contiguous READ CD commands return contiguous information, even if buffer overruns or underruns occur. All data forms shaded in Table 575 - *Number of Bytes Returned Based on Data Selection Field* on page 723 *shall* be supported; non-shaded forms are optional.

17.4.2.9 Feature 001Fh: DVD Read

This Feature identifies a logical unit that can read DVD specific information from the media.

This Feature *shall* be current only if DVD specific structures are available for reading.

Table 363 - DVD Read Feature Descriptor

Bit Byte	7	6	5	4	3	2	1	0
0	(MSB) Feature Code = 001Fh (LSB)							
1								
2	Reserved		Version = 2h			Persistent	Current	
3	Additional Length = 04h							
4	Reserved						MULTI110	
5	Reserved							
6	Reserved					Dual-RW	Dual-R	
7	Reserved							

The Feature Code field *shall* be set to 001Fh.

The Persistent bit *shall* be defined as in Table 341 - *Feature Descriptor generic format* on page 564. This bit *shall* be set to zero if the medium is removable.

The Current bit *shall* be defined as in Table 341 - *Feature Descriptor generic format* on page 564. This bit *shall* be set to zero if DVD medium is not present.

The Version field *shall* be set to 2h.

The Additional Length field *shall* be set to 04h.

If the DVD Multi Specification Version 1.1 (MULTI110) bit is set to one, logical unit *shall* comply with the DVD Multi Specifications Product Requirements Version 1.1. Reserved bits in byte 4 are reserved for DVD Forum future Specifications.

If the DVD-R Dual Layer (Dual-R) bit is set to one, the logical unit *shall* support reading of DVD-R DL discs with all recording modes (i.e., Sequential recording and Layer Jump recording modes). The logical unit *shall* support the Remapping on DVD-R DL disc.

The DVD-RW Dual Layer (Dual-RW) bit of one indicates that the logical unit is capable of reading the Complete state DVD-RW DL media. The Dual-RW bit of zero indicates that the logical unit may be unable to read the DVD-RW DL media.

Table 364 shows the mandatory commands to implement this Feature.

Table 364 - Mandatory commands for DVD Read Feature

OpCode	Commands
28h	READ (10)
43h	READ TOC/PMA/ATIP
A8h	READ (12)
ADh	READ DISC STRUCTURE

Supplementary explanation for commands to implement this Feature:

- READ TOC/PMA/ATIP:
This command *shall* be supported along with fabrication of data for DVD media as specified in the command description.
- READ DISC STRUCTURE:
The Format Codes of 00h, 01h, 03h and 04h *shall* be supported. If the logical unit also reports the DVD-RAM Profile (16.11, "Profile 0012h: DVD-RAM" on page 528) or supports reading of DVD-RAM media, then Format Code of 08h *shall* be supported if DVD-RAM media is present.

17.4.2.10 Feature 0020h: Random Writable

This Feature identifies a logical unit that can write data to logical blocks specified by a WRITE (10) command. There is no requirement that the addresses in sequences of writes occur in any particular order. This Feature *shall* be present only if writable media is present. Write protected media *shall not* be considered writable.

Table 365 - Random Writable Feature Descriptor

Bit Byte	7	6	5	4	3	2	1	0
0	(MSB) Feature Code = 0020h (LSB)							
1								
2	Reserved		Version = 1h			Persistent	Current	
3	Additional Length = 0Ch							
4	(MSB) Last LBA (LSB)							
5								
6								
7								
8	(MSB) Logical Block Size (LSB)							
9								
10								
11								
12	(MSB) Blocking (LSB)							
13								

Table 365 - Random Writable Feature Descriptor

Bit Byte	7	6	5	4	3	2	1	0
14	Reserved							PP
15	Reserved							

The Feature Code field *shall* be set to 0020h.

The Version field *shall* be set to 1h.

The Persistent bit *shall* be defined as in Table 341 - *Feature Descriptor generic format* on page 564. This bit *shall* be set to zero if the medium is removable.

The Current bit *shall* be defined as in Table 341 - *Feature Descriptor generic format* on page 564. This bit *shall* be set to zero if randomly writable medium is not present.

The Additional Length field *shall* be set to 0Ch.

Note: Earlier versions of this specification had the Version field set to zero, and the Additional Length was 4.

The Last LBA field is the address of the last addressable data block.

The Logical Block Size is the number of bytes per logical block. This value *shall* be the same as reported by the Random Readable Feature and the READ CAPACITY command.

The Blocking field *shall* indicate the number of logical blocks per logical unit writable unit. The Blocking field reported in the Feature Descriptor is for performance optimization only. Writes of any sector or sector count *shall* be allowed.

If the Page Present (PP) bit is set to one, all fields in the Read-Write Error Recovery mode page *shall* be supported. If set to zero, *shall* indicate that the Read-Write Error Recovery mode page may not be present.

Table 366 shows the mandatory commands to implement this Feature.

Table 366 - Mandatory commands for Random Writable Feature

OpCode	Commands
25h	READ CAPACITY
2Ah	WRITE (10)
2Eh	WRITE AND VERIFY (10)
35h	SYNCHRONIZE CACHE (10)

Supplementary explanation for commands to implement this Feature:

- SYNCHRONIZE CACHE (10):
The Immediate bit *shall* be supported.

17.4.2.11 Feature 0021h: Incremental Streaming Writable

This Feature identifies a logical unit that can write data to a contiguous region, and can append data to a limited number of locations on the media. On CD media, this is known as packet recording.

This Feature *shall* indicate support for sequential recording, such as CD Packet, and DVD Incremental recording to write once or rewritable media and HD DVD incremental recording. This Feature *shall* become not current after a Disc final closure is performed.

Table 367 - Incremental Streaming Writable Feature Descriptor

Bit Byte	7	6	5	4	3	2	1	0
0	(MSB) Feature Code = 0021h (LSB)							
1								
2	Reserved		Version = 3h			Persistent	Current	
3	Additional Length							
4	(MSB) Data Block Type Supported (LSB)							
5								
6	Reserved				TRIO	ARSV	BUF	
7	Number of Link Sizes							
8-n	Link Size							
n-?	Pad							

The Feature Code field *shall* be set to 0021h.

The Version field *shall* be set to 3h.

The Persistent bit *shall* be defined as in Table 341 - *Feature Descriptor generic format* on page 564. This bit *shall* be set to zero if the medium is removable.

The Current bit *shall* be defined as in Table 341 - *Feature Descriptor generic format* on page 564. This bit *shall* be set to zero if sequential write medium is not present. The Current bit may not be set at the medium insertion even if this Feature is available on the medium. See 15.4, "Delayed Feature reporting" on page 522.

The Additional Length field *shall* be set to 4 + (Number of Link Sizes) + (Number of Pad bytes).

The Data Block Type Supported field is a bit field that identifies the supported Data Block Type. A bit set to zero indicates the Data Type is not supported. A bit set to one indicates the Data Block Type is supported. Bit 0 equates to Data Block Type 0 and bit 15 equates to Data Block Type 15, etc.

The BUF bit, when set to 1, *shall* indicate that Buffer Under-run Free recording is available for the current mounted media.

The ARSV bit, when set to 1, *shall* indicate that Address Mode reservation of RESERVE TRACK command is available for the current mounted media.

The TRIO (Track Resources Information and Open) bit, when set to 1, *shall* indicate that Track Resources Information of READ DISC INFORMATION command and the Open bit of READ TRACK INFORMATION command are supported by the logical unit. This bit may not be set to 1 for CD-R/-RW media.

The ARSV bit and TRIO bit may be changed according to the mounted medium. If logical unit does not support the capability on the mounted medium when Incremental Streaming Writable Feature is current, the bit *shall not* be set to one. When this Feature is not current and if these optional capabilities are supported on some sequential recording medium, the logical unit *shall* set the ARSV and/or the TRIO bits to 1.

The Number of Link Sizes *shall* specify the number of link sizes available for the current media. If the currently mounted media supports zero as a Link size, then it *shall* be an entry in the list of Link Size fields. For HD DVD-R, this field *shall* be set to 1.

Note: For CD media, this field should be 1. For DVD-R, this field should be 2.

Each Link Size field *shall* indicate the number of logical blocks per link. Links occur on sequentially written media between independent write operations. The link size does not include any logical blocks written by the logical unit to

satisfy the writable unit specified by the **Blocking** field in the Random Readable Feature. **Link Size** fields are reported by the logical unit in the logical unit's preferred order, most desirable first.

Note: This field is 7 for CD-R media, and may be 0, 1, or 16 for DVD media.

The **Pad** field *shall* contain zeros. The number of Pad bytes *shall* be $4 * IP((\text{Number of Link Sizes} + 3)/4) - (\text{Number of Link Sizes})$, where "IP()" is the integer part of the number. The **Pad** field is present to make the length of the Feature Descriptor a multiple of 4 bytes.

Table 368 shows the mandatory commands to implement this Feature.

Table 368 - Mandatory commands for Incremental Streaming Writable Feature

OpCode	Commands
2Ah	WRITE (10)
35h	SYNCHRONIZE CACHE (10)
51h	READ DISC INFORMATION
52h	READ TRACK INFORMATION
53h	RESERVE TRACK
5Bh	CLOSE TRACK/SESSION
Conditional support	
54h	SEND OPC INFORMATION
A1h	BLANK

Supplementary explanation for commands to implement this Feature:

- **WRITE (10):**
Writing may be limited to locations identified by the READ DISC INFORMATION command and READ TRACK INFORMATION commands. If sequential WRITE (10) commands occur to contiguous locations at a sufficient rate, the logical unit *shall* stream the data to the medium without interruption or link generation occurring. If the writing is interrupted due to insufficient data ("underrun") or is forced by a SYNCHRONIZE CACHE (10) or other command, a link *shall* be generated except for HD DVD media. The nominal size of the link *shall* be that specified by the Write Parameters mode page. The number of padding and link blocks actually recorded may also depend on blocking: the data from the host may first be padded to fill a Blocking unit and then a link *shall* be appended. See 4.17.10.2, "ECC boundary padding and Data Type bit in ID field" on page 145 for an example with DVD-R media.
While a streaming write is in progress (data are in the logical unit's buffer but not committed to the medium), the commands in Table 369 *shall* perform normally without interrupting the writing. All other commands *shall* perform normally, but may interrupt recording. All other commands may force a SYNCHRONIZE CACHE (10) before execution. Logical units should perform all other commands without flushing the write buffer. This is possible if writing to the medium has not yet started. Normal execution is defined as the behavior the command would have if no data were in the write buffer.

Table 369 - Commands that shall not interrupt streaming writing

Command	Comment
TEST UNIT READY	
READ TRACK INFORMATION	Required only for current Track/RZone
GET EVENT/STATUS NOTIFICATION	
GET CONFIGURATION	
REQUEST SENSE	
INQUIRY	
READ BUFFER CAPACITY	
WRITE (10)	For NWA in current Track/RZone

- SYNCHRONIZE CACHE (10):
This command *shall* force the underrun condition regardless of the state of the Immediate bit.
- READ DISC INFORMATION:
The Disc Information Block data *shall* be supported. The support of Track Resource Information Block is optional.
- READ TRACK INFORMATION:
The support of the Open bit is optional.
- RESERVE TRACK:
The Size Mode reservation *shall* be supported. The support of Address Mode reservation is optional.
- CLOSE TRACK/SESSION:
If the host closes the Session or Border and there is insufficient space for another Session or Border to follow, the logical unit *shall* close the Session or Border with no next Session or Border pointer (on CD, point B0 would not exist).

Note: The CD MultiSession standard allows B0 = FF/FF/FF to indicate the same thing, but some legacy drives do not properly handle this means of marking the last Session.
- SEND OPC INFORMATION:
If OPC information is ever returned via the READ DISC INFORMATION command, this command *shall* be supported.
- BLANK:
If the Erasable bit in the READ DISC INFORMATION command is set to one, this command *shall* be supported with Blanking Types of 000b, 001b, and 100b for CD, 000b and 001b for DVD.

Table 370 shows the mandatory mode page to implement this Feature.

Table 370 - Mandatory mode pages for Incremental Streaming Writable Feature

Page Code	Mode pages
Conditional support	
05h	Write Parameters mode page

Supplementary explanation for the mode page to implement this Feature:

- Write Parameters mode page:
If a mounted medium is CD-R, CD-RW, DVD-R or DVD-RW SL disc, this mode page *shall* be supported. If CD-R or CD-RW media is present, the Packet recording write type *shall* be available. If DVD-R or DVD-RW SL media is present, the Incremental recording write method *shall* be available. This mode page may contain or be actively set to settings that are incompatible with the current medium, or be set when no medium is present. If writing is attempted when this mode page is not compatible with the current track, RZone, or medium, the logical unit *shall* return CHECK

CONDITION status, 5/64/00 ILLEGAL MODE FOR THIS TRACK, and the sense key specific information set to the byte and field of the incompatible parameter in the mode page.

17.4.2.12 Feature 0022h: *Obsolete (Sector Erasable)*

The Sector Erasable Feature is obsolete.

17.4.2.13 Feature 0023h: *Formattable*

This Feature identifies the ability to format media. The type of formatting that may be performed is defined in the FORMAT UNIT command (see Table 332 - *FORMAT UNIT Parameter List* on page 550).

Table 371 - Formattable Feature Descriptor

Bit Byte	7	6	5	4	3	2	1	0
0	(MSB) Feature Code = 0023h (LSB)							
1								
2	Reserved		Version = 2h			Persistent		Current
3	Additional Length = 08h							
4	Reserved			RENoSA	Expand	QCert	Cert	
5	Options for formatting DVD-RW DL							
	FRF	Reserved						
6	Reserved							
7	Reserved							
8	Reserved							RRM
9	Reserved							
10	Reserved							
11	Reserved							

The Feature Code field *shall* be set to 0023h.

The Version field *shall* be set to 2h.

The Persistent bit *shall* be defined as in Table 341 - *Feature Descriptor generic format* on page 564. This bit *shall* be set to zero if the medium is removable.

The Current bit *shall* be defined as in Table 341 - *Feature Descriptor generic format* on page 564. This bit *shall* be set to zero if non-formattable medium is present.

The Additional Length field *shall* be set to 08h.

If the logical unit does not support neither BD-R Profile nor BD-RE Profile, byte 4 and byte 11 *shall* be set to all zeros. See MMC for the definition of byte 4 and byte 11.

The Fast Re-Format (FRF) bit of one *shall* indicate that the logical unit supports the formatting on Format Type = 18h (Fast Re-format) of the FORMAT UNIT command.

Note: If a logical unit does not support option bits in byte 4 through byte 11, the logical unit may report this Feature Descriptor with the Version field and the Additional Length field set to zero.

Table 372 shows the mandatory commands to implement this Feature.

Table 372 - Mandatory commands for Formattable Feature

OpCode	Commands
03h	REQUEST SENSE
04h	FORMAT UNIT
23h	READ FORMAT CAPACITIES
2Fh	VERIFY (10)

Supplementary explanation for commands to implement this Feature:

- **FORMAT UNIT:**
The Format Code of 001b *shall* be supported. Format Type of 00h *shall* be supported. If the FRF bit is set to one, Format Type value of 18h *shall* be supported.
- **READ FORMAT CAPACITIES:**
All descriptors returned *shall* be valid for the current medium. A Format Type of 00h *shall* be supported.

17.4.2.14 Feature 0024h: Hardware Defect Management

This Feature identifies a logical unit that *shall* be able to perform defect management to provide the host with an apparently defect-free contiguous address space. This Feature *shall* be current only if media with defect management capability is present. If reading of defect managed media type(s) is supported, even if write operations are not supported, the Hardware Defect Management Feature *shall* be reported.

When this Feature is current, Enhanced Defect Reporting Feature *shall not* be current.

Table 373 - Hardware Defect Management Feature Descriptor

Bit Byte	7	6	5	4	3	2	1	0
0	(MSB) Feature Code = 0024h (LSB)							
1								
2	Reserved		Version = 1h				Persistent	Current
3	Additional Length = 04h							
4	SSA	Reserved						
5	Reserved							
6	Reserved							
7	Reserved							

The Feature Code field *shall* be set to 0024h.

The Version field *shall* be set to 1h.

The Persistent bit *shall* be defined as in Table 341 - *Feature Descriptor generic format* on page 564. This bit *shall* be set to zero if the medium is removable.

The Current bit *shall* be defined as in Table 341 - *Feature Descriptor generic format* on page 564. This bit *shall* be set to zero if managed medium is not present.

Note: Defect Managed media may have no defects.

The Additional Length field *shall* be set to 04h.

The SSA bit of one *shall* indicate that the logical unit supports the READ DISC STRUCTURE command with Format Code = 0Ah (Spare Area Information).

Table 374 shows the mandatory mode page to implement this Feature.

Table 374 - Mandatory mode pages for Hardware Defect Management Feature

Page Code	Mode pages
01h	Read-Write Error Recovery mode page

Supplementary explanation for the mode page to implement this Feature:

- Read-Write Error Recovery mode page:
If the current media is writable by the logical unit, the Automatic Write Reallocation Enabled (AWRE) and Automatic Read Reallocation Enabled (ARRE) bits (see 17.11.3.1, "Read-Write Error Recovery mode page" on page 673) and associated functionality of those bits *shall* be supported.

17.4.2.15 Feature 0025h: Write Once

This Feature identifies a logical unit that has the ability to record to any previously unrecorded logical block. The recording of logical blocks may occur in any order. Previously recorded blocks *shall not* be overwritten.

This Feature identifies a logical unit that can write data to randomly addressed logical blocks specified by a WRITE (10) command. There is no requirement that the addresses in sequences of writes occur in any particular order. This Feature *shall* be present only if write once media is present. Write protected media *shall not* be considered writable. After being written once, the logical unit cannot record the same block again. If the logical unit detects that all logical blocks are recorded, this Feature *shall* become not current.

The Random Readable Feature *shall* be current when this Feature is current.

Table 375 - Write Once Feature Descriptor

Bit Byte	7	6	5	4	3	2	1	0
0	(MSB) Feature Code = 0025h (LSB)							
1								
2	Reserved		Version				Persistent	Current
3	Additional Length = 08h							
4	(MSB)							
5	Logical Block Size							
6								
7								
8	(MSB) Blocking (LSB)							
9								
10	Reserved							PP
11	Reserved							

The Feature Code field *shall* be set to 0025h.

The Version field *shall* be set to 0h.

The Persistent bit *shall* be defined as in Table 341 - Feature Descriptor generic format on page 564. This bit *shall* be set to zero if the medium is removable.

The Current bit *shall* be defined as in Table 341 - Feature Descriptor generic format on page 564. This bit *shall* be set to zero if write once medium is not present.

The Additional Length field *shall* be set to 08h.

The Logical Block Size is the number of bytes per logical block. This value *shall* be the same as reported by the Random Readable Feature and the READ CAPACITY command.

The Blocking field *shall* indicate the number of logical blocks per logical unit writable unit. The Blocking field reported in the Feature Descriptor is for performance optimization only. Writes of any sector or sector count *shall* be allowed

If the Page Present (PP) bit is set to one, all fields in the Read-Write Error Recovery mode page *shall* be supported. When set to zero, *shall* indicate that the Read-Write Error Recovery mode page may not be present.

Table 376 shows the mandatory commands to implement this Feature.

Table 376 - Mandatory commands for Write Once Feature

OpCode	Commands
25h	READ CAPACITY
2Ah	WRITE (10)
2Eh	WRITE AND VERIFY (10)
35h	SYNCHRONIZE CACHE (10)

Supplementary explanation for commands to implement this Feature:

- WRITE (10):
Writing may occur to any previously unrecorded logical block. If recording is attempted to any recorded logical block, the logical unit *shall* generate CHECK CONDITION status, 8/00/00 BLANK CHECK.
- WRITE AND VERIFY (10):
Writing may occur to any previously unrecorded logical block. If recording is attempted to any recorded logical block, the logical unit *shall* generate CHECK CONDITION status, 8/00/00 BLANK CHECK.
- SYNCHRONIZE CACHE (10):
The Immediate bit *shall* be supported.

Table 377 shows the mandatory mode page to implement this Feature.

Table 377 - Mandatory mode pages for Write Once Feature

Page Code	Mode pages
01h	Read-Write Error Recovery mode page

Supplementary explanation for the mode page to implement this Feature:

- Read-Write Error Recovery mode page:
This mode page *shall* be supported.

17.4.2.16 Feature 0026h: Restricted Overwrite

The Restricted Overwrite Feature *shall* indicate the ability to perform writing only on Blocking boundaries. This Feature replaces the Random Writable Feature for logical units that do not perform read-modify-write operations on write requests smaller than Blocking. This Feature *shall not* be current if the Random Writable Feature is current. This Feature may be present only when Restricted Overwritable media, such as CD-RW with a single track containing fixed packets, is loaded. Logical units with write protected media *shall not* have this Feature current. If this Feature is current, the Random Writable Feature *shall not* be current.

On CD-RW, this Feature should be current only if the first track on the media is formatted for fixed packets and is complete. The Blocking field in the Random Readable Feature *shall* be equal to the packet size. The Last Addressable

Block *shall* be the last addressable block in the first track. If more than one track is present on the media, the host *shall* use READ TRACK INFORMATION command to obtain a description of the medium.

Writing from the host into the first track *shall* be in units of Blocking. Writing *shall* begin at Blocking boundaries. The writable units may be sent via multiple WRITE (10) commands. If the logical unit receives a Write that does not begin on a Blocking boundary and is not contiguous with a previous Write that did begin on a Blocking boundary *shall* return CHECK CONDITION status, 5/21/02 INVALID ADDRESS FOR WRITE. If an incomplete set of blocks is received and the logical unit is required to flush its cache via SYNCHRONIZE CACHE (10) or other implied causes, the logical unit *shall* generate CHECK CONDITION status, 1/0C/0A WRITE ERROR - PADDING BLOCKS ADDED.

Table 378 - Restricted Overwrite Feature Descriptor

Bit Byte	7	6	5	4	3	2	1	0
0	(MSB) Feature Code = 0026h (LSB)							
1								
2	Reserved			Version			Persistent	Current
3	Additional Length = 00h							

The Feature Code field *shall* be set to 0026h.

The Version field *shall* be set to 0h.

The Persistent bit *shall* be defined as in Table 341 - *Feature Descriptor generic format* on page 564. This bit *shall* be set to zero if the medium is removable.

The Current bit *shall* be defined as in Table 341 - *Feature Descriptor generic format* on page 564. This bit *shall* be set to zero if Restricted Overwritable medium is not present. The Current bit may not be set at the medium insertion even if this Feature is available on the medium. See 15.4, "Delayed Feature reporting" on page 522.

The Additional Length field *shall* be set to 00h.

Table 379 shows the mandatory commands to implement this Feature.

Table 379 - Mandatory commands for Restricted Overwrite Feature

OpCode	Commands
25h	READ CAPACITY
2Ah	WRITE (10)
35h	SYNCHRONIZE CACHE (10)
51h	READ DISC INFORMATION
52h	READ TRACK INFORMATION

Supplementary explanation for commands to implement this Feature:

- READ DISC INFORMATION:
The Disc Information Block data of this command *shall* be supported. The support of Track Resources Information Block is optional.
- READ TRACK INFORMATION
The support of the Open bit is optional.

Table 380 shows the mandatory mode page to implement this Feature.

Table 380 - Mandatory mode pages for Restricted Overwrite Feature

Page Code	Mode pages
05h	Write Parameters mode page

Supplementary explanation for the mode page to implement this Feature:

- Write Parameters mode page:
This mode page *shall* be supported.

17.4.2.17 Feature 0027h: CD-RW CAV Write

The CD-RW CAV Write Feature identifies a logical unit that has the ability to perform writing on CD-RW media in CAV mode. The logical unit *shall* conform to the Orange Book Part 3 Volume 2 specification. This Feature *shall not* be current if high speed recordable CD-RW media is not mounted. Logical units with write protected media *shall not* have this Feature current.

Table 381 - CD-RW CAV Write Feature Descriptor

Bit Byte	7	6	5	4	3	2	1	0	
0	Feature Code = 0027h							(LSB)	
1									
2	Reserved		Version			Persistent		Current	
3	Additional Length = 04h								
4	Reserved								
5	Reserved								
6	Reserved								
7	Reserved								

The Feature Code field *shall* be set to 0027h.

The Version field *shall* be set to 0h.

The Persistent bit *shall* be defined as in Table 341 - *Feature Descriptor generic format* on page 564. This bit *shall* be set to zero if the medium is removable.

The Current bit *shall* be defined as in Table 341 - *Feature Descriptor generic format* on page 564. This bit *shall* be set to zero if high speed recordable CD-RW medium is not present.

The Additional Length field *shall* be set to 04h.

Table 382 shows the mandatory commands to implement this Feature.

Table 382 - Mandatory commands for CD-RW CAV Write Feature

OpCode	Commands
25h	READ CAPACITY
2Ah	WRITE (10)
35h	SYNCHRONIZE CACHE (10)
51h	READ DISC INFORMATION
52h	READ TRACK INFORMATION

Supplementary explanation for commands to implement this Feature:

- **READ DISC INFORMATION:**
The Disc Information Block data of this command *shall* be supported. The support of Track Resources Information Block is optional.
- **READ TRACK INFORMATION:**
The support of the **Open** bit is optional.

Table 383 shows the mandatory mode page to implement this Feature.

Table 383 - Mandatory mode pages for CD-RW CAV Write Feature

Page Code	Mode pages
05h	Write Parameters mode page

17.4.2.18 Feature 0028h: MRW

See MMC.

17.4.2.19 Feature 0029h: Enhanced Defect Reporting

The Enhanced Defect Reporting Feature identifies a logical unit that has the ability to perform media certification and RECOVERED ERROR reporting for Logical unit assisted software defect management See *Section 10.0, "Logical unit assisted software defect management model"* on page 477. In case of Persistent-DM mode, the READ (12) command with Streaming bit = 1 may be performed without medium certification.

When this Feature is current, Hardware Defect Management Feature *shall not* be current. This Feature may be current if Restricted Overwrite formatted media or Rigid Restricted Overwrite formatted media is loaded.

The **Current** bit of this Feature is not affected by the EMCDR field and the PER bit settings in the Read-Write Error Recovery mode page.

If a logical unit supports DRT-DM mode, either large DBI buffer memory model or small DBI cache memory model or both models *shall* be supported. See *10.2.2, "Distributed real-time defect management (DRT-DM) mode"* on page 477 and *10.3.4, "DBI memory management"* on page 482.

Table 384 - Enhanced Defect Reporting Feature Descriptor

Bit Byte	7	6	5	4	3	2	1	0
0	(MSB) Feature Code = 0029h (LSB)							
1								
2	Reserved		Version				Persistent	Current
3	Additional Length = 04h							
4	Reserved							DRT-DM
5	Number of DBI cache zones							
6	(MSB) Number of entries (LSB)							
7								

The Feature Code field *shall* be set to 0029h.

The Version field *shall* be set to 0h.

The Persistent bit *shall* be defined as in Table 341 - *Feature Descriptor generic format* on page 564. This bit *shall* be set to zero if the medium is removable.

The **Current** bit *shall* be defined as in Table 341 - *Feature Descriptor generic format* on page 564. This bit *shall* be set to zero if Hardware Defect Management feature is current.

The **Additional Length** field *shall* be set to 04h.

DRT-DM bit, if set to 1, *shall* indicate that the logical unit supports DRT-DM mode. If set to 0, *shall* indicate that the logical unit supports Persistent-DM mode.

Number of DBI cache zones field specifies possible maximum number of regions that logical unit can handle DBI cache separately. If this field is set to 0, *shall* indicate that logical unit supports 10.3.4.1, "Simple DBI memory model" on page 482. If this field is set to 1, *shall* indicate that logical unit supports 10.3.4.2, "Large DBI buffer memory model" on page 482. In case of 10.3.4.3, "Small DBI cache memory model" on page 482, Number of DBI cache zones field *shall* be set to 2 or higher (minimum number of this field is 2). The value of Number of DBI cache zones field may be changed by media type. If this Feature is not current, this field is invalid.

Table 385 - Relationship between Number of DBI cache zones field and DBI memory model type

DRT-DM	Number of DBI cache zones field value	Number of entries	DBI buffer model type of logical unit
0	0	n ^a	simple memory model, cleared at the beginning of medium certification
0	1	0	large DBI buffer model
0	2 or higher	n ^a	small DBI cache model
1	0	n/a	Reserved
1	1	0	large DBI buffer model
1	2 or higher	n ^a	small DBI cache model

a. Value of n *shall* be 10 or higher.

Number of entries filed indicates that the number of entries that in the worst case may cause DBI memory overflow. In case of large DBI buffer model, this field *shall* be set to 0. For other DBI memory model, this field *shall* be set to 10 or higher. The value of this field may be changed by media type. If this Feature is not current, this field is invalid.

Table 386 shows the mandatory commands to implement this Feature.

Table 386 - Mandatory commands for Enhanced Defect Reporting Feature

OpCode	Commands
28h	READ (10)
2Ah	WRITE (10)
2Eh	WRITE AND VERIFY (10)
2Fh	VERIFY (10)
35h	SYNCHRONIZE CACHE (10)
51h	READ DISC INFORMATION
A8h	READ (12)
AAh	WRITE (12)
ACh	GET PERFORMANCE
Conditional support	
B6h	SET STREAMING

Supplementary explanation for commands to implement this Feature:

- SYNCHRONIZE CACHE (10):
Implicit SYNCHRONIZE CACHE operation *shall* be supported. See 10.4, "Implicit synchronize cache" on page 484.
- READ DISC INFORMATION:
The Disc Information Block data *shall* be supported.
- READ (12):
The Streaming bit value of 0 *shall* be supported. If a logical unit supports DRT-DM mode, the Streaming bit value of 1 *shall* also be supported.
- WRITE (12):
The Streaming bit value of 0 *shall* be supported. If a logical unit supports DRT-DM mode, the Streaming bit value of 1 *shall* also be supported.
- GET PERFORMANCE:
The Type field of 04h *shall* be supported. If logical unit supports DRT-DM mode and when small DBI cache memory model is supported, the Type field value of 05h *shall* also be supported. See Table 477 - Type field values description on page 643 and Table 806 - Type field values description on page 889.
- SET STREAMING:
If logical unit supports DRT-DM mode and when small DBI cache memory model is supported, the SET STREAMING command with Type field value of 05h *shall* be supported.

Table 387 shows the mandatory mode page to implement this Feature.

Table 387 - Mandatory mode pages for Enhanced Defect Reporting Feature

Page Code	Mode pages
01h	Read-Write Error Recovery mode page

Supplementary explanation for mode page to implement this Feature:

- Read-Write Error Recovery mode page:
The PER bit and the EMCDCR field *shall* be supported.

17.4.2.20 Feature 002Ah: DVD+RW

See MMC.

17.4.2.21 Feature 002Bh: DVD+R

See MMC.

17.4.2.22 Feature 002Ch: Rigid Restricted Overwrite

The Rigid Restricted Overwrite Feature *shall* indicate the ability to perform writing only on Blocking boundaries. This Feature is different from Restricted Overwrite Feature (0026h) because each Write command *shall* also end on a Blocking boundary. This Feature replaces the Random Writable Feature for logical units that do not perform read-modify-write operations on write requests smaller than Blocking. This Feature *shall not* be current if the Random Writable Feature is current. This Feature may be present when DVD-RW Restricted Overwritable media is loaded. Logical units with write protected media *shall not* have this Feature current. If this Feature is current, the Random Writable Feature *shall not* be current.

The host *shall* use the READ DISC INFORMATION and READ TRACK INFORMATION commands to obtain a description of the medium such as Blocking Factor. If more than one RZone/Border is present on the media, the host *shall* use the READ DISC INFORMATION and READ TRACK INFORMATION commands to obtain a description of the medium.

Writing from the host into the media *shall* be in units of Blocking. Writing *shall* begin and *shall* stop at Blocking boundaries. The writable units may be sent via multiple WRITE (10) commands. If the logical unit receives a Write that

does not begin on a **Blocking** boundary *shall* return CHECK CONDITION status, 5/21/02 INVALID ADDRESS FOR WRITE. And if the logical unit receives a Write that does not end on a **Blocking** boundary *shall* return CHECK CONDITION status, 5/24/00 INVALID FIELD IN CDB.

Table 388 - Rigid Restricted Overwrite Feature Descriptor

Bit Byte	7	6	5	4	3	2	1	0
0	(MSB) Feature Code = 002Ch (LSB)							
1								
2	Reserved		Version				Persistent	Current
3	Additional Length = 04h							
4	Reserved		Reserved	DSDG	DSDR	Intermediate	Blank	
5	Reserved							
6	Reserved							
7	Reserved							

The Feature Code field *shall* be set to 002Ch.

The Version field *shall* be set to 0h.

The Persistent bit *shall* be defined as in Table 341 - *Feature Descriptor generic format* on page 564. This bit *shall* be set to zero if the medium is removable.

The Current bit *shall* be defined as in Table 341 - *Feature Descriptor generic format* on page 564. This bit *shall* be set to zero if DVD-RW or HD DVD-RW medium is not present.

The Additional Length field *shall* be set to 04h.

The Defect Status Data Generate (DSDG) bit, if set to 1, *shall* indicate that the logical unit supports to generate Defect Status data during formatting. A disable certification (DCRT) bit of Table 333 - *Format List Header* on page 550 *shall* be supported. If set to 0, *shall* indicate that the logical unit does not support generating of Defect status data.

The Defect Status Data Read (DSDR) bit, if set to 1, *shall* indicate that the logical unit supports to read Defect Status data recorded on a medium. The GET PERFORMANCE command with Type = 2 (Defect Status) *shall* be supported if the DSDR bit is set to 1. If this bit is set to 0, *shall* indicate that the logical unit does not support reading of Defect Status data.

The Intermediate bit, if set to 1, *shall* indicate that the logical unit supports writing on an intermediate state Bordered Area and quick formatting (Format Type of 15h - Quick Format). If set to 0, *shall* indicate that the logical unit does not support writing on an intermediate state Bordered Area and quick formatting.

The Blank bit, if set to 1, *shall* indicate that the logical unit supports BLANK command, Blanking Type 00h and 01h. If set to 0, *shall* indicate that the logical unit does not support BLANK command.

Table 389 shows the mandatory commands to implement this Feature.

Table 389 - Mandatory commands for Rigid Restricted Overwrite Feature

OpCode	Commands
2Ah	WRITE (10)
51h	READ DISC INFORMATION
52h	READ TRACK INFORMATION
25h	READ CAPACITY
35h	SYNCHRONIZE CACHE (10)
2Fh	VERIFY (10)
Conditional support	
04h	FORMAT UNIT
A1h	BLANK
ACh	GET PERFORMANCE

Supplementary explanation for commands to implement this Feature:

- READ DISC INFORMATION:
The Disc Information Block data *shall* be supported.
- READ TRACK INFORMATION:
The support of the **Open** bit is optional.
- FORMAT UNIT:
If the **Intermediate** bit is set to one, this command with the **Format Type** value of 15h *shall* be supported.
- BLANK:
If the **Blank** bit is set to one, this command with the **Blanking Type** field value of 00h and 01h *shall* be supported.
- GET PERFORMANCE:
If the **DSDR** bit is set to one, this command with **Type** field value of 2 (Defect Status) *shall* be supported.

17.4.2.23 Feature 002Dh: CD Track at Once

This Feature *shall* indicate support for sequential Track at Once recording to write once or rewritable media. This Feature *shall* become not current after a Disc final closure is performed.

Table 390 - CD Track at Once Feature Descriptor

Bit Byte	7	6	5	4	3	2	1	0
0	(MSB) Feature Code = 002Dh (LSB)							
1								
2	Reserved		Version = 2h				Persistent	Current
3	Additional Length = 04h							
4	Reserved	BUF	Reserved	R-W Raw	R-W Pack	Test Write	CD-RW	R-W Subcode
5	Reserved							
6	(MSB) Data Block Type Supported (LSB)							
7								

The **Feature Code** field *shall* be set to 002Dh.

The **Version** field *shall* be set to 2h.

The **Persistent** bit *shall* be defined as in Table 341 - *Feature Descriptor generic format* on page 564. This bit *shall* be set to zero if the medium is removable.

The **Current** bit *shall* be defined as in Table 341 - *Feature Descriptor generic format* on page 564. This bit *shall* be set to zero if CD-R or CD-RW medium is not present. The **Current** bit may not be set at the medium insertion even if this Feature is available on the medium. See 15.4, "*Delayed Feature reporting*" on page 522.

The **Additional Length** field *shall* be set to 04h.

The following bits indicate Feature support. If set to zero, the Feature is not supported. If set to one, the Feature is supported.

The **Buffer Underrun Free (BUF)** bit, when set to 1, *shall* indicate that the logical unit supports Buffer Under-run Free recording.

The **R-W Raw** bit, if set to 1, *shall* indicate that the logical unit supports writing R-W subcode in the Raw mode. The **R-W Subcode** bit *shall* be set if this bit is set.

The **R-W Pack** bit, if set to 1, *shall* indicate that the logical unit supports writing R-W subcode in the Packed mode. The **R-W Subcode** bit *shall* be set if this bit is set.

The **Test Write** bit indicates that the logical unit can perform test writes. See 17.11.3.7, "*Write Parameters mode page*" on page 691.

The **CD-RW** bit indicates support for overwriting a Track at Once track with another.

The **R-W Subcode** bit indicates that the logical unit can record the R-W subchannels with user supplied data.

The **Data Block Type Supported** field is defined in sub-clause 17.4.2.11, "*Feature 0021h: Incremental Streaming Writable*" on page 579.

Table 391 shows the mandatory commands to implement this Feature.

Table 391 - Mandatory commands for CD Track at Once Feature

OpCode	Commands
2Ah	WRITE (10)
35h	SYNCHRONIZE CACHE (10)
5Bh	CLOSE TRACK/SESSION
53h	RESERVE TRACK
51h	READ DISC INFORMATION
52h	READ TRACK INFORMATION
Conditional support	
A1h	BLANK
54h	SEND OPC INFORMATION

Supplementary explanation for commands to implement this Feature:

- **WRITE (10):**
Writing may be limited to locations identified by the READ DISC INFORMATION and READ TRACK INFORMATION commands. If sequential WRITE (10) commands occur to contiguous locations at a sufficient rate, the logical unit *shall* stream the data to the medium without interruption or link generation occurring. If the writing is interrupted due to insufficient data ("underrun") or is forced by a SYNCHRONIZE CACHE (10) or other command, run-out and link *shall* be generated after padding. Padding *shall* consist of (1) sufficient blocks of zeros to make the track the minimum length and (2) padded to fill an existing reservation for the track. If the track is of minimum length and is not reserved, no padding blocks *shall* be added.
While a Track at Once write is in progress (data are in the logical unit's buffer but not committed to the medium), the commands in Table 392 *shall* perform normally without interrupting the writing. All other commands *shall* perform

normally, but may interrupt recording. All other commands may force a SYNCHRONIZE CACHE (10) before execution. Logical units should perform all other commands without flushing the write buffer. This is possible if writing to the medium has not yet started. Normal execution is defined as the behavior the command would have if no data were in the write buffer.

Table 392 - Commands that shall not interrupt Track at Once writing

COMMAND	COMMENT
GET CONFIGURATION	
GET EVENT/STATUS NOTIFICATION	
INQUIRY	
READ BUFFER CAPACITY	
READ TRACK INFORMATION	Required only for current Track/RZone
REQUEST SENSE	
TEST UNIT READY	
WRITE (10)	For NWA in current Track/RZone

- SYNCHRONIZE CACHE (10):
This command *shall* force the underrun condition regardless of the state of the Immediate bit.
- RESERVE TRACK:
The Size Mode reservation *shall* be supported.
- READ DISC INFORMATION:
The Disc Information Block data *shall* be supported.
- READ TRACK INFORMATION:
The support of the Open bit is optional.
- BLANK:
If the CD-RW flag in the CD Track at Once Feature Descriptor is set, the Erasable bit in the READ DISC INFORMATION result data may be set to one and this command *shall* be supported. Blanking Types 000b, 001b *shall* be supported. Overwriting of previously recorded tracks *shall* be allowed. Overwriting of previously recorded tracks is performed as if the track had been reserved and not recorded (the PMA entry is unchanged).
- SEND OPC INFORMATION:
If OPC information is ever returned via READ DISC INFORMATION, this command *shall* be supported.

Table 393 shows the mandatory commands to implement this Feature.

Table 393 - Mandatory mode pages for CD Track at Once Feature

Page Code	Mode pages
05h	Write Parameters mode page

Supplementary explanation for the mode page to implement this Feature:

- Write Parameters mode page:
If CD medium is present, the Track at Once recording write type *shall* be available. This mode page may contain or be actively set to settings that are incompatible with the current medium, or be set when no medium is present. If writing is attempted when this mode page is not compatible with the current Track or medium, the logical unit *shall* return CHECK CONDITION status, 5/64/00 ILLEGAL MODE FOR THIS TRACK, and the sense key specific information set to the byte and field of the incompatible parameter in the mode page.

17.4.2.24 Feature 002Eh: CD Mastering

Two fundamental types of CD mastering are possible - raw and session at once. A logical unit with this Feature *shall* support at least one of Raw or Session at Once recording. The type of recording is identified in the Feature Descriptor. This Feature *shall* be current only if the last session status is empty.

Note: The raw mode offers additional control but bypasses logical unit data checking and has larger data transfer size. The session at once mode offers logical unit control and supervision but has greater logical unit complexity.

Table 394 - CD Mastering Feature Descriptor

Bit Byte	7	6	5	4	3	2	1	0
0	Feature Code = 002Eh (MSB) (LSB)							
1								
2	Reserved		Version = 1h				Persistent	Current
3	Additional Length = 04h							
4	Reserved	BUF	SAO	Raw MS	Raw	Test Write	CD-RW	R-W
5	Maximum Cue Sheet Length (MSB) (LSB)							
6								
7								

The Feature Code field *shall* be set to 002Eh.

The Version field *shall* be set to 1h.

The Persistent bit *shall* be defined as in Table 341 - *Feature Descriptor generic format* on page 564. This bit *shall* be set to zero if the medium is removable.

The Current bit *shall* be defined as in Table 341 - *Feature Descriptor generic format* on page 564. This bit *shall* be set to zero if CD-R or CD-RW media is not present.

The Additional Length field *shall* be set to 04h.

The following bits indicate feature support. If set to zero, the feature is not supported. If set to one, the feature is supported.

The Buffer Underrun Free (BUF) bit, when set to 1, *shall* indicate that the logical unit supports Buffer Underrun Free recording.

The Session at Once (SAO) bit *shall* indicate that the logical unit can record using the Session at Once write type. Required commands for this write type is described in 17.4.2.24.2.

The Raw Multisession (Raw MS) bit *shall* indicate that the logical unit can record multisession in raw mode.

The Raw bit *shall* indicate that the logical unit can record using the raw write type. Required commands for this write type is described in 17.4.2.24.1.

The Test Write bit *shall* indicate that the logical unit can perform test writes. In test write mode, the logical unit *shall* behave as if data were committed to the medium, but writing to the medium *shall not* occur.

The CD-RW bit *shall* indicate that the logical unit can overwrite previously recorded data.

The R-W bit *shall* indicate that the logical unit can record the R-W subchannels with user supplied information.

The Maximum Cue Sheet Length field indicates the maximum length of a Cue Sheet that can be accepted by the logical unit for Session at Once recording. If the SAO bit is zero, this field *shall* be set to zero.

17.4.2.24.1 CD Mastering - Raw

If the **Raw** bit is set to one, the logical unit *shall* supports commands and mode page as shown in Table 395 and Table 396.

Table 395 shows the mandatory commands to implement this Feature for Raw mode.

Table 395 - Mandatory commands for CD Mastering Feature - Raw mode

OpCode	Commands
2Ah	WRITE (10)
35h	SYNCHRONIZE CACHE (10)
51h	READ DISC INFORMATION
52h	READ TRACK INFORMATION
Conditional support	
54h	SEND OPC INFORMATION

Supplementary explanation for commands to implement this Feature:

- **WRITE (10):**
The host *shall* send all data, from the beginning of Lead-in to the end of Lead-out. The number of bytes per block is determined by the **Data Block Type** in the Write Parameters mode page. The Writes *shall* occur to a contiguous sequence of addresses. When an underrun occurs, the logical unit *shall* write the last block sent from the host as a link. If the **Raw MS** bit is set, the logical unit *shall* also generate valid PMA entries for the information sent by the host. The logical unit may use the TOC and approximations, or TOC and scanning to determine PMA parameters.
- **READ DISC INFORMATION:**
The Disc Information Block data *shall* be supported.
- **READ TRACK INFORMATION:**
The support of the **Open** bit is optional.
- **SEND OPC INFORMATION:**
If OPC information is ever returned via the READ DISC INFORMATION command, this command *shall* be supported.

Table 396 shows the mandatory mode page to implement this Feature for Raw mode.

Table 396 - Mandatory mode pages for CD Mastering Feature - Raw mode

Page Code	Mode pages
05h	Write Parameters mode page

Supplementary explanation for the mode page to implement this Feature:

- **Write Parameters mode page:**
The **Write Type** field value of 03h (Raw recording) *shall* be supported. **Data Block Type** field value of 1 *shall* be supported. If the **R-W** bit in the Feature Descriptor is set, then **Data Block Type** field values of 2 and 3 *shall* also be supported.

17.4.2.24.2 CD Mastering - Session at Once

If the **SAO** bit is set to one, the logical unit *shall* supports commands and mode page as shown in Table 397 and Table 398.

Table 397 shows the mandatory commands to implement this Feature for Session at Once mode.

Table 397 - Mandatory commands for CD Mastering Feature - Session at Once mode

OpCode	Commands
2Ah	WRITE (10)
51h	READ DISC INFORMATION
52h	READ TRACK INFORMATION
5Dh	SEND CUE SHEET
Conditional support	
54h	SEND OPC INFORMATION

Supplementary explanation for commands to implement this Feature:

- **WRITE (10):**
The number of bytes per block is determined by the cue sheet. Writes *shall* be issued for every user data block, even if the cue sheet indicates that those blocks require no data be sent from the host. In that case, the number of bytes transferred is zero. WRITE (10) commands *shall* be issued by the host with an ascending sequence of Logical Block Addresses. The number of blocks per write may change over the course of recording. If an underrun occurs, the logical unit may pad the rest of the session or abort the recording. Underruns may be detected by the host at the next write, which will not be a valid address for writing due to the underrun.
- **READ DISC INFORMATION:**
The Disc Information Block data *shall* be supported.
- **READ TRACK INFORMATION:**
The support of the **Open** bit is optional.
- **SEND CUE SHEET:**
The logical unit *shall* accept cue sheets up to the size specified in the Maximum Cue Sheet Length field.
- **SEND OPC INFORMATION:**
If OPC information is ever returned via the READ DISC INFORMATION command, this command *shall* be supported.

Table 398 shows the mandatory mode page to implement this Feature.

Table 398 - Mandatory mode pages for CD Mastering Feature - Session at Once mode

Page Code	Mode pages
05h	Write Parameters mode page

Supplementary explanation for the mode page to implement this Feature:

- **Write Parameters mode page:**
The **Write Type** field value of 02h (SAO/DAO) *shall* be supported. The **Data Block Type** field is ignored; the data block type changes dynamically according to the cue sheet.

17.4.2.25 Feature 002Fh: DVD-R/-RW Write

This Feature indicates the ability to master a DVD disc on DVD-R/-RW media.

Table 399 - DVD-R/-RW Write Feature Descriptor

Bit Byte	7	6	5	4	3	2	1	0
0	(MSB) Feature Code = 002Fh (LSB)							
1								
2	Reserved		Version = 2h				Persistent	Current
3	Additional Length = 04h							
4	Reserved	BUF	Reserved		RDL	Test Write	DVD-RW SL	Reserved
5	Reserved							
6	Reserved							
7	Reserved							

The Feature Code field *shall* be set to 002Fh.

The Version field *shall* be set to 2h.

The Persistent bit *shall* be defined as in Table 341 - *Feature Descriptor generic format* on page 564. This bit *shall* be set to zero if the medium is removable.

The Current bit *shall* be defined as in Table 341 - *Feature Descriptor generic format* on page 564. This bit *shall* be set to zero if DVD-R medium is not present.

The Additional Length field *shall* be set to 04h.

The Buffer Underrun Free (BUF) bit, when set to 1, *shall* indicate that the logical unit supports Buffer Underrun Free recording.

The RDL bit, when set to 1, *shall* indicate that the logical unit supports to write DVD-R Dual Layer media. The READ DISC STRUCTURE command with Format Code value of 20h *shall* be supported.

The Test Write bit, when set to zero, *shall* indicate that the logical unit is not capable of performing test writes. When set to one, the logical unit is capable of performing test writes.

The DVD-RW SL bit indicates support for writing and erasing on DVD-RW SL media. If this bit is set to 1, *shall* indicate that the logical unit supports BLANK command with the Blanking Type field values of 00h and 01h.

Table 400 shows the mandatory commands to implement this Feature.

Table 400 - Mandatory commands for DVD-R/-RW Write Feature

OpCode	Commands
2Ah	WRITE (10)
51h	READ DISC INFORMATION
52h	READ TRACK INFORMATION
53h	RESERVE TRACK
BFh	SEND DISC STRUCTURE
Conditional support	
A1h	BLANK
ADh	READ DISC STRUCTURE

Supplementary explanation for commands to implement this Feature:

- **WRITE (10):**
The number of bytes per block is determined by the block size in the Random Readable Feature. Writes *shall* be issued for every user data block. WRITE (10) commands *shall* be issued by the host with a contiguous sequence of Logical Block Addresses. The number of blocks per write may change over the course of recording. If an underrun occurs, the logical unit may pad the rest of the disc or abort the recording. Underruns may be detected by the host at the next write, which will not be a valid address for writing due to the underrun.
- **READ DISC INFORMATION:**
The Disc Information Block data *shall* be supported.
- **READ TRACK INFORMATION:**
The support of the **Open** bit is optional.
- **RESERVE TRACK:**
The Size Mode reservation *shall* be supported.
- **BLANK:**
If the DVD-RW SL bit is set to one in the Feature Descriptor, this command with Blanking Type field values of 00h and 01h *shall* be supported.
- **READ DISC STRUCTURE:**
If the RDL bit is set to one in the Feature Descriptor, this command with Format Code field values of 20h *shall* be supported.

Table 401 shows the mandatory mode page to implement this Feature.

Table 401 - Mandatory mode pages for DVD-R/-RW Write Feature

Page Code	Mode pages
05h	Write Parameters mode page

Supplementary explanation for the mode page to implement this Feature:

- Write Parameters mode page:
A Write Type field value of 02h (SAO/DAO) *shall* be supported.

17.4.2.26 Feature 0033h: Layer Jump recording

This Feature identifies a logical unit that can write data to contiguous regions that are allocated on multiple Layers, and can append data to a limited number of locations on the media. The logical unit is able to write two or more recording Layers sequentially and alternately.

This Feature *shall* indicate support for Layer Jump recording on DVD-R Dual Layer media. This Feature *shall* become not current after a Disc final closure is performed. See 4.18.5.7, "Disc final closure" on page 205.

Table 402 - Layer Jump recording Feature Descriptor

Bit Byte	7	6	5	4	3	2	1	0
0	(MSB) Feature Code = 0033h (LSB)							
1								
2	Reserved		Version			Persistent		Current
3	Additional Length							
4	Reserved							
5								
6								
7	Number of Link Size							
8-n	Link Size							
n-?	Pad							

The Feature Code field *shall* be set to 0033h.

The Version field *shall* be set to 0h.

The Persistent bit *shall* be defined as in Table 341 - *Feature Descriptor generic format* on page 564. This bit *shall* be set to zero if the medium is removable.

The Current bit *shall* be defined as in Table 341 - *Feature Descriptor generic format* on page 564. This bit *shall* be set to zero if Layer Jump recording capable medium is not present.

The Additional Length field *shall* be set to 4 + (Number of Link Sizes) + (Number of Pad bytes).

Data Block Type 8 of Write Parameters mode page *shall* be supported.

Buffer Under-run Free recording *shall* be available for the current mounted media.

The Number of Link Sizes *shall* specify the number of link sizes available for the current media.

Note: For DVD-R DL discs, this field may be 1.

Each Link Size field *shall* indicate the number of logical blocks per link. Links occur on sequentially written media between independent write operations. The link size does not include any logical blocks written by the logical unit to satisfy the writable unit specified by the Blocking field in the Random Readable Feature. Link Size fields are reported by the logical unit in the logical unit's preferred order, most desirable first.

Note: For DVD-R DL discs, this field may be 16.

The Pad field *shall* contain zeros. The number of Pad bytes *shall* be $4 * IP((Number\ of\ Link\ Sizes + 3)/4) - (Number\ of\ Link\ Sizes)$, where "IP()" is the integer part of the number. The Pad field is present to make the length of the Feature Descriptor a multiple of 4 bytes.

Table 403 shows the mandatory commands to implement this Feature.

Table 403 - Mandatory commands for Layer Jump recording Feature

OpCode	Commands
2Ah	WRITE (10)
35h	SYNCHRONIZE CACHE (10)
51h	READ DISC INFORMATION
52h	READ TRACK INFORMATION
53h	RESERVE TRACK
5Bh	CLOSE TRACK/SESSION
ADh	READ DISC STRUCTURE
BFh	SEND DISC STRUCTURE

Supplementary explanation for commands to implement this Feature:

- **WRITE (10):**
Writing may be limited to locations identified by the READ DISC INFORMATION command and READ TRACK INFORMATION commands. The logical unit *shall* stream the data to the medium without interruption or link generation occurring regardless of data transfer rate and BUFE bit setting of Write Parameters mode page. If the writing is interrupted due to insufficient data (“underrun”), the logical unit *shall* perform Buffer Underrun Error Free recording. If the logical unit is forced by a SYNCHRONIZE CACHE (10) or other command, a link *shall* be generated. The nominal size of the link *shall* be that specified by the Write Parameters mode page. The number of padding and link blocks actually recorded may also depend on blocking: the data from the host may first be padded to fill a Blocking unit and then a link *shall* be appended. See 4.17.10.2, “ECC boundary padding and Data Type bit in ID field” on page 145 for an example with DVD-R media.
While a streaming write is in progress (data are in the logical unit’s buffer but not committed to the medium), the commands in Table 404 *shall* perform normally without interrupting the writing. All other commands *shall* perform normally, but may interrupt recording. All other commands may force a SYNCHRONIZE CACHE (10) before execution. Logical units should perform all other commands without flushing the write buffer. This is possible if writing to the medium has not yet started. Normal execution is defined as the behavior the command would have if no data were in the write buffer.

Table 404 - Commands that shall not interrupt streaming writing

Command	Comment
TEST UNIT READY	
READ TRACK INFORMATION	Required only for current Track/RZone
GET EVENT/STATUS NOTIFICATION	
GET CONFIGURATION	
REQUEST SENSE	
INQUIRY	
READ BUFFER CAPACITY	
WRITE (10)	For NWA in current Track/RZone

- **SYNCHRONIZE CACHE (10):**
This command *shall* force the underrun condition regardless of the state of the Immediate bit.
- **READ DISC INFORMATION:**
Disc Information Block data and Track Resources Information *shall* be supported.
- **READ TRACK INFORMATION:**
The Open bit in CDB, LJRS field, Next Layer Jump Address field, and Last Layer Jump Address field of Track

Information Block *shall* be supported.

- RESERVE TRACK:
Address Mode reservation and Size Mode reservation *shall* be supported.
- CLOSE TRACK/SESSION:
If the host closes the Session or Border, and there is insufficient space for another Session or Border to follow, the logical unit *shall* close the Session or Border with no next Session or Border pointer (on CD, point B0 would not exist).
Note: The CD MultiSession standard allows B0 = FF/FF/FF to indicate the same thing, but some legacy drives do not properly handle this means of marking the last Session.
- READ DISC STRUCTURE:
The Format Code field values of 20h, 21h, 22h, 23h, and 24h *shall* be supported.
- SEND DISC STRUCTURE:
The Format Code field values of 21h, 22h, 23h, and 24h *shall* be supported.

Table 405 shows the mandatory mode page to implement this Feature.

Table 405 - Mandatory mode pages for Layer Jump recording Feature

Page Code	Mode pages
05h	Write Parameters mode page

Supplementary explanation for the mode page to implement this Feature:

- Write Parameters mode page:
If DVD-R DL media is present, the Layer Jump recording method (Write Type=04h) *shall* be available. This mode page may contain or be actively set to settings that are incompatible with the current medium, or be set when no medium is present. If writing is attempted when this mode page is not compatible with the current track, RZone, or medium, the logical unit *shall* return CHECK CONDITION status, 5/64/00 ILLEGAL MODE FOR THIS TRACK, and the sense key specific information set to the byte and field of the incompatible parameter in the mode page.

17.4.2.27 Feature 0034h: LJ Rigid Restricted Overwrite

The LJ Rigid Restricted Overwrite Feature *shall* indicate the both abilities to write in Layer jump recording mode and to overwrite the logically recorded blocks in only Blocking boundaries. This Feature and the Random Writable Feature *shall not* be current at a time. If the mounted medium is write protected, this Feature *shall not* be current.

This Feature and Rigid Restricted Overwrite Feature can be current at a time, but when the current recording mode of the mounted disc is in Layer jump recording mode, Rigid Restricted Overwrite Feature *shall not* be current.

Table 406 - LJ Rigid Restricted Overwrite Feature Descriptor

Bit Byte	7	6	5	4	3	2	1	0
0	(MSB) Feature Code = 0034h (LSB)							
1								
2	Reserved		Version				Persistent	Current
3	Additional Length = 04h							
4	Reserved							CLJB
5	Reserved							
6	Reserved							
7	Buffer Block size							

The Feature Code field *shall* be set to 0034h.

The Version field *shall* be set to 0h.

The Persistent bit *shall* be defined as in Table 341 - *Feature Descriptor generic format* on page 564. This bit *shall* be set to zero if the medium is removable.

The Current bit *shall* be defined as in Table 341 - *Feature Descriptor generic format* on page 564. When a writable DVD-RW DL medium is loaded, this Feature is current.

The Additional Length field *shall* be set to 04h.

The Close Layer Jump Block (CLJB) bit *shall* indicate the logical unit supports the function to close active and not-blank LJB by a command.

The Buffer Block size field *shall* indicate the number of logical blocks of the Buffer Block allocated at the beginning of each Layer jump block.

Table 407 shows the mandatory commands to implement this Feature.

Table 407 - Mandatory commands for LJ Rigid Restricted Overwrite Feature

OpCode	Commands
25h	READ CAPACITY
2Ah	WRITE (10)
2Fh	VERIFY (10)
35h	SYNCHRONIZE CACHE (10)
51h	READ DISC INFORMATION
52h	READ TRACK INFORMATION
5Bh	CLOSE TRACK/SESSION
ADh	READ DISC STRUCTURE
BFh	SEND DISC STRUCTURE

Supplementary explanation for commands to implement this Feature:

- READ DISC INFORMATION:
The Data Type field value of 000b *shall* be supported.
- READ TRACK INFORMATION:
This command except Open bit *shall* be supported. The LJRS field, the Next Layer Jump Address field and the Last Layer Jump Address field *shall* be supported.
- CLOSE TRACK/SESSION:
The Close Function field value of 010b *shall* be supported. When CLJB bit is set to one, Close Function field value of 001b *shall* also be supported.
- READ DISC STRUCTURE:
The Format Code field values of 20h, 21h, 22h and 23h *shall* be supported.
- SEND DISC STRUCTURE:
The Format Code field values of 21h, 22h, and 23h *shall* be supported.

17.4.2.28 Feature 0035h: Stop Long Operation

This Feature identifies the ability to stop the long immediate operation (e.g., formatting and closing) by a command.

Table 408 - Stop Long Operation Feature Descriptor

Bit Byte	7	6	5	4	3	2	1	0	
0	(MSB) Feature Code = 0035h (LSB)								
1									
2	Reserved		Version				Persistent	Current	
3	Additional Length = 00h								

The Feature Code field *shall* be set to 0035h.

The Version field *shall* be set to 0h.

The Persistent bit *shall* be defined as in Table 341 - *Feature Descriptor generic format* on page 564. This bit *shall* be set to zero if the medium is removable.

The Current bit *shall* be defined as in Table 341 - *Feature Descriptor generic format* on page 564. This bit *shall* be set to one only when the stop operation for at least any one of the long immediate operations for the currently mounted medium is possible.

The Additional Length field *shall* be set to 00h.

Table 409 shows the mandatory commands to implement this Feature.

Table 409 - Mandatory commands for Stop Long Operation Feature

OpCode	Commands
03h	REQUEST SENSE
5Bh	CLOSE TRACK/SESSION

- CLOSE TRACK/SESSION:
The Close Function field value of 000b *shall* be supported. The Immed bit *shall* be supported.
- REQUEST SENSE:
Reporting of the Progress Indication field *shall* be supported.

17.4.2.29 Feature 0037h: CD-RW Media Write Support

See MMC.

17.4.2.30 Feature 0038h: BD-R Pseudo Overwrite Feature

See MMC.

17.4.2.31 Feature 003Ah: DVD+RW Dual Layer

See MMC.

17.4.2.32 Feature 003Bh: DVD+R Dual Layer

See MMC.

17.4.2.33 Feature 0040h: BD Read

See MMC.

17.4.2.34 Feature 0041h: BD Write

See MMC.

17.4.2.35 Feature 0042h: TSR

See MMC.

17.4.2.36 Feature 0050h: HD DVD Read

This Feature identifies a logical unit that supports for reading HD DVD specific information from the media. This Feature *shall* be current only if HD DVD specific structures are available for reading.

Table 410 - HD DVD Read Feature Descriptor

Bit Byte	7	6	5	4	3	2	1	0
0	(MSB) Feature Code = 0050h (LSB)							
1								
2	Reserved		Version = 2h				Persistent	Current
3	Additional Length = 08h							
4	Reserved							HD DVD-R SL
5	Reserved							HD DVD-R DL
6	Reserved							HD DVD- RAM
7	Reserved							
8	Reserved							HD DVD- RW SL
9	Reserved							HD DVD- RW DL
10-11	Reserved							

The Feature Code field *shall* be set to 0050h.

The Version field *shall* be set to 2h.

The Persistent bit *shall* be defined as in Table 341 - *Feature Descriptor generic format* on page 564. This bit *shall* be set to zero if the medium is removable.

The Current bit *shall* be defined as in Table 341 - *Feature Descriptor generic format* on page 564. This bit *shall* be set to zero if HD DVD medium is not present.

The Additional Length field *shall* be set to 08h.

The HD DVD-R SL bit, when set to one, indicates support for reading of HD DVD-R SL media.

The HD DVD-R DL bit, when set to one, indicates support for reading of HD DVD-R DL media.

The HD DVD-RAM bit, when set to one, indicates support for reading of HD DVD-RAM media.

The HD DVD-RW SL bit, when set to one, indicates support for reading of HD DVD-RW SL media.

The HD DVD-RW DL bit, when set to one, indicates support for reading of HD DVD-RW DL media.

Note: Version number 1 was assigned when the HD DVD-R DL bit was added. Version number 2 was assigned when the HD DVD-RW SL bit and HD DVD-RW DL bit were added in the Feature descriptor.

Table 411 shows the mandatory commands to implement this Feature.

Table 411 - Mandatory commands for HD DVD Read Feature

OpCode	Commands
28h	READ (10)
43h	READ TOC/PMA/ATIP
A8h	READ (12)
ADh	READ DISC STRUCTURE

Supplementary explanation for commands to implement this Feature:

- READ TOC/PMA/ATIP:
This command *shall* be supported along with fabrication of data for HD DVD media as specified in the command description.
- READ DISC STRUCTURE:
The Format Code field values of 00h, 03h, 04h, 12h and 15h *shall* be supported.

17.4.2.37 Feature 0051h: HD DVD Write

This Feature indicates the ability to master a HD DVD disc on HD DVD-R/-RAM media.

Table 412 - HD DVD Write Feature Descriptor

Bit Byte	7	6	5	4	3	2	1	0
0	(MSB) Feature Code = 0051h (LSB)							
1								
2	Reserved		Version = 2h			Persistent		Current
3	Additional Length = 08h							
4	Reserved							HD DVD-R SL
5	Reserved							HD DVD-R DL
6	Reserved							HD DVD- RAM
7	Reserved							
8	Reserved							HD DVD- RW SL
9	Reserved							HD DVD- RW DL
10-11	Reserved							

The Feature Code field *shall* be set to 0051h.

The Version field *shall* be set to 2h.

The Persistent bit *shall* be defined as in Table 341 - *Feature Descriptor generic format* on page 564. This bit *shall* be set to zero if the medium is removable.

The Current bit *shall* be defined as in Table 341 - *Feature Descriptor generic format* on page 564. This bit *shall* be set to zero if HD DVD-R/-RAM medium is not present.

The Additional Length field *shall* be set to 04h.

The HD DVD-R SL bit, when set to one, indicates support for writing of HD DVD-R SL media.

The HD DVD-R DL bit, when set to one, indicates support for writing of HD DVD-R DL media.

The HD DVD-RAM bit, when set to one, indicates support for writing of HD DVD-RAM media.

The HD DVD-RW SL bit, when set to one, indicates support for writing of HD DVD-RW SL media. A logical unit *shall* support both Sequential formatting mode and Fragment recording mode.

The HD DVD-RW DL bit, when set to one, indicates support for writing of HD DVD-RW DL media.

Note: Version number 1 was assigned when the HD DVD-R DL bit was added. Version number 2 was assigned when the HD DVD-RW SL bit and HD DVD-RW DL bit were added in the Feature descriptor.

Table 413 shows the mandatory commands to implement this Feature when the HD DVD-R SL bit in the HD DVD Write Feature Descriptor is set to 1.

Table 413 - Mandatory commands for HD DVD Write Feature - HD DVD-R SL

OpCode	Commands
04h	FORMAT UNIT
2Ah	WRITE (10)
51h	READ DISC INFORMATION
52h	READ TRACK INFORMATION
53h	RESERVE TRACK
AAh	WRITE (12)
BFh	SEND DISC STRUCTURE
Conditional support	
54h	SEND OPC INFORMATION

Supplementary explanation for commands to implement this Feature:

- **FORMAT UNIT:**
The Format Type field value of 16h *shall* be supported.
- **SEND DISC STRUCTURE:**
The Format Code field value of 0Fh *shall* be supported.
- **SEND OPC INFORMATION:**
If OPC information is ever returned via the READ DISC INFORMATION command, this command *shall* be supported.

Table 414 shows the mandatory commands to implement this Feature when the HD DVD-R DL bit in the HD DVD Write Feature Descriptor is set to 1.

Table 414 - Mandatory commands for HD DVD Write Feature - HD DVD-R DL

OpCode	Commands
04h	FORMAT UNIT
2Ah	WRITE (10)
51h	READ DISC INFORMATION
52h	READ TRACK INFORMATION
53h	RESERVE TRACK
AAh	WRITE (12)
ADh	READ DISC STRUCTURE
BFh	SEND DISC STRUCTURE
Conditional support	
54h	SEND OPC INFORMATION

Supplementary explanation for commands to implement this Feature:

- **FORMAT UNIT:**
The Format Type field value of 17h *shall* be supported.
- **READ DISC STRUCTURE**
The Format Code field values of 19h and 20h *shall* be supported.
- **SEND DISC STRUCTURE:**
The Format Code field value of 20h and 0Fh *shall* be supported.
- **SEND OPC INFORMATION:**
If OPC information is ever returned via the READ DISC INFORMATION command, the SEND OPC INFORMATION command *shall* be supported.

Table 415 shows the mandatory commands to implement this Feature when the HD DVD-RAM bit in the HD DVD Write Feature Descriptor is set to 1.

Table 415 - Mandatory commands for HD DVD Write Feature - HD DVD-RAM

OpCode	Commands
04h	FORMAT UNIT
2Ah	WRITE (10)
2Eh	WRITE AND VERIFY (10)
AAh	WRITE (12)

Supplementary explanation for commands to implement this Feature:

- **FORMAT UNIT:**
The **Format Code** field value of 001b *shall* be supported. **Format Type** field value of 00h *shall* be supported.

Table 416 shows the mandatory commands to implement this Feature when the HD DVD-RW SL bit in the HD DVD Write Feature Descriptor is set to 1.

Table 416 - Mandatory commands for HD DVD Write Feature - HD DVD-RW SL

OpCode	Commands
2Ah	WRITE (10)
51h	READ DISC INFORMATION
52h	READ TRACK INFORMATION
5Bh	CLOSE TRACK/SESSION
AAh	WRITE (12)
BFh	SEND DISC STRUCTURE
Conditional support	
54h	SEND OPC INFORMATION

Supplementary explanation for commands to implement this Feature:

- **SEND DISC STRUCTURE:**
The **Format Code** field value of 0Fh *shall* be supported.
- **SEND OPC INFORMATION:**
If OPC information is ever returned via the READ DISC INFORMATION command, this command *shall* be supported.

Table 417 shows the mandatory commands to implement this Feature when the HD DVD-RW DL bit in the HD DVD Write Feature Descriptor is set to 1.

Table 417 - Mandatory commands for HD DVD Write Feature - HD DVD-RW DL

OpCode	Commands
04h	FORMAT UNIT
2Ah	WRITE (10)
51h	READ DISC INFORMATION
52h	READ TRACK INFORMATION
5Bh	CLOSE TRACK/SESSION
AAh	WRITE (12)
ADh	READ DISC STRUCTURE
BFh	SEND DISC STRUCTURE
Conditional support	
54h	SEND OPC INFORMATION

Supplementary explanation for commands to implement this Feature:

- **FORMAT UNIT:**
The **Format Type** field value of 17h *shall* be supported.
- **READ DISC STRUCTURE**
The **Format Code** field values of 19h and 20h *shall* be supported.
- **SEND DISC STRUCTURE:**

The Format Code field value of 20h and 0Fh *shall* be supported.

- SEND OPC INFORMATION:

If OPC information is ever returned via the READ DISC INFORMATION command, this command *shall* be supported.

17.4.2.38 Feature 0052h: HD DVD-RW Fragment Recording

This Feature *shall* indicate the ability to perform writing on any part of data recordable area in multiples of Blocking. Logical units with write protected media *shall not* have this Feature current.

Writing from the host into the media *shall* be in units of Blocking. Writing *shall* begin and *shall* stop at Blocking boundaries. The writable units may be sent via multiple WRITE (10) commands. If the logical unit receives a Write that does not begin on a Blocking boundary *shall* return CHECK CONDITION status, 5/21/02 INVALID ADDRESS FOR WRITE. And if the logical unit receives a Write that does not end on a Blocking boundary *shall* return CHECK CONDITION status, 5/24/00 INVALID FIELD IN CDB.

Table 418 - HD DVD-RW Fragment Recording Feature Descriptor

Bit Byte	7	6	5	4	3	2	1	0
0	(MSB) Feature Code = 0052h (LSB)							
1								
2	Reserved		Version				Persistent	Current
3	Additional Length = 04h							
4	Reserved							BGP
5	Reserved							
6	Reserved							
7	Reserved							

The Feature Code field *shall* be set to 0052h.

The Version field *shall* be set to 0h.

The Persistent bit *shall* be defined as in Table 341 - *Feature Descriptor generic format* on page 564.

The Current bit *shall* be defined as in Table 341 - *Feature Descriptor generic format* on page 564.

The Additional Length field *shall* be set to 04h.

The BGP (Background Padding) bit *shall* be set to one if the logical unit supports Background Padding for HD DVD-RW SL media. Otherwise it *shall* be set to zero. For Background Padding, see 7.13.5.6 “Fragment recording format” on page 267.

17.4.2.39 Feature 0080h: Hybrid disc

This Feature indicates the ability to handle Hybrid disc structures.

The READ DISC STRUCTURE command with Format Code value of 90h *shall* be supported.

The FL bit and the Destination Format-layer # field of the START STOP UNIT command *shall* be supported.

Table 419 - Hybrid disc Feature Descriptor

Bit Byte	7	6	5	4	3	2	1	0
0	(MSB) Feature Code = 0080h (LSB)							
1								
2	Reserved		Version				Persistent	Current
3	Additional Length = 04h							
4	Reserved							RI
5	Reserved							
6	Reserved							
7	Reserved							

The Feature Code field *shall* be set to 0080h.

The Version field *shall* be set to 0h.

The Persistent bit *shall* be defined as in Table 341 - *Feature Descriptor generic format* on page 564. This bit *shall* be set to zero if the medium is removable.

The Current bit *shall* be defined as in Table 341 - *Feature Descriptor generic format* on page 564. This bit *shall* be set to one when and only when the logical unit identifies two or more Format-layers in the mounted disc.

The Additional Length field *shall* be set to 04h.

The Reset Immunity (RI) bit, when set to one, indicates the ability to maintain the online Format-layer through any reset and power-cycle. If the RI bit is set to one, the logical unit *shall* preserve the selection of the Format-layer through power-cycle and reset. If the RI bit is set to zero, the online Format-layers before and after the power-cycle or reset may be different. The logical unit may or may not clear the preservation of the online Format-layers at disc ejection. If the logical unit supports recording of a writable Format-layer, the RI bit *shall* be set to one. Otherwise the logical unit *shall* treat the recordable Format-layer as Read-only except the recordable Format-layer is the default Format-layer.

Table 420 shows the mandatory commands to implement this Feature.

Table 420 - Mandatory commands for Hybrid disc Feature

OpCode	Commands
1Bh	START STOP UNIT
ADh	READ DISC STRUCTURE

Supplementary explanation for commands to implement this Feature:

- START STOP UNIT:
The FL bit and Destination Format-layer # field *shall* be supported.
- READ DISC STRUCTURE:
The Format Code value of 90h *shall* be supported.

17.4.2.40 Feature 0100h: Power Management

This Feature identifies a logical unit that can perform host managed and host directed power management.

Table 421 - Power Management Feature Descriptor

Bit Byte	7	6	5	4	3	2	1	0
0	(MSB) Feature Code = 0100h (LSB)							
1								
2	Reserved		Version				Persistent	Current
3	Additional Length = 00h							

The Feature Code field *shall* be set to 0100h.

The Version field *shall* be set to 0h.

The Persistent bit *shall* be set to one.

The Current bit *shall* be set to one.

The Additional Length field *shall* be set to 0.

Table 422 shows the mandatory commands to implement this Feature.

Table 422 - Mandatory commands for Power Management Feature

OpCode	Commands
1Bh	START STOP UNIT
4Ah	GET EVENT/STATUS NOTIFICATION

Supplementary explanation for commands to implement this Feature:

- START STOP UNIT:
The Power Condition field *shall* be supported.
- GET EVENT/STATUS NOTIFICATION:
The Power Management Class *shall* be supported.

Table 423 shows the mandatory mode page to implement this Feature.

Table 423 - Mandatory mode pages for Power Management Feature

Page Code	Mode pages
1Ah	Power Condition mode page

17.4.2.41 Feature 0101h: S.M.A.R.T.

This Feature identifies a logical unit that can perform Self Monitoring Analysis and Reporting Technology.

The S.M.A.R.T. (Self-Monitoring, Analysis and Reporting Technology) is a technology developed to manage the reliability of data storage logical units. S.M.A.R.T.-capable PC systems have the goal of enhancing system reliability by warning users of some pending logical unit or media failures. With sufficient warning, users may have the opportunity to back up vital data and replace suspect logical units prior to data loss or unscheduled down time. S.M.A.R.T. capability is a key new element in the PC architecture that will one day provide new levels of data integrity and data availability.

Peripheral data storage logical units are complex electro-mechanical logical units and, as such, can suffer performance degradation or failure due to a single event or a combination of events. Some events are immediate and catastrophic

while others cause a gradual degradation of the logical unit's ability to perform. It is possible to predict a portion of the failures, but S.M.A.R.T. cannot and will not predict all future logical unit failures. S.M.A.R.T. should be treated as a Feature to assist the computer user in preventing some but not all system down time due to logical unit failure.

S.M.A.R.T. capable logical units monitor a wealth of information internal to the logical unit to assess reliability and predict an impending logical unit or medium failure. This information is, in some cases, available through the interface and can be presented to end-users via drivers and supporting applications. This data should not be presented to or interpreted by system users or managers to predict the integrity or reliability of a S.M.A.R.T. logical unit. The predictive algorithms in a S.M.A.R.T. logical unit are designed to interpret internal conditions in order to detect impending failures and thus users or system managers should not attempt to predict impending logical unit failure from this internal data. S.M.A.R.T. data are not linear predictors of the degrading reliability of a S.M.A.R.T. capable logical unit. It is the responsibility of a S.M.A.R.T. logical unit to predict an impending failure and report that failure via an Informational Exception Condition.

Table 424 - S.M.A.R.T. Feature Descriptor

Bit Byte	7	6	5	4	3	2	1	0
0	(MSB) Feature Code = 0101h (LSB)							
1								
2	Reserved		Version				Persistent	Current
3	Additional Length = 04h							
4	Reserved						PP	
5	Reserved							
6	Reserved							
7	Reserved							

The Feature Code field *shall* be set to 0101h.

The Version field *shall* be set to 0h.

The Persistent bit *shall* be defined as in Table 341 - *Feature Descriptor generic format* on page 564.

The Current bit *shall* be defined as in Table 341 - *Feature Descriptor generic format* on page 564.

The Additional Length field *shall* be set to 04h.

If the Page Present (PP) bit is set in the S.M.A.R.T Feature Descriptor, 17.11.3.4, "Informational Exceptions Control mode page" on page 683 *shall* be supported. If the Informational Exceptions Control mode page is not supported the logical unit *shall* use the following default values:

1. Performance (Perf) bit *shall* be 0 (Delays are acceptable).
2. Enable Warning (EWasc) bit *shall* be 0 (Disable WARNING Sense Code reporting).
3. Disable Exception Control (DExcept) bit *shall* be 0 (Do not Disable reporting of exception conditions).
4. Test bit *shall* be 0.
5. Method of Reporting Informational Exceptions (MRIE) *shall* be 4 (Unconditionally generate RECOVERED ERROR).
6. Interval Timer *shall* be set to 6000.

17.4.2.42 Feature 0102h: Embedded Changer

This Feature identifies a logical unit that can move media from a storage area to the mechanism and back.

For more information on changers, see the description of the *Section 11.0, "Changer Model"* on page 491. If this Feature is current, the Removable Medium Feature *shall* also be current.

Table 425 - Embedded Changer Feature Descriptor

Bit Byte	7	6	5	4	3	2	1	0
0	(MSB) Feature Code = 0102h							
1	(LSB)							
2	Reserved		Version				Persistent	Current
3	Additional Length = 04h							
4	Reserved		SCC	Reserved	SDP	Reserved		
5	Reserved							
6	Reserved							
7	Reserved			Highest Slot Number				

The Feature Code field *shall* be set to 0102h.

The Version field *shall* be set to 0h.

The Persistent bit *shall* be defined as in Table 341 - *Feature Descriptor generic format* on page 564.

The Current bit *shall* be defined as in Table 341 - *Feature Descriptor generic format* on page 564.

The Additional Length field *shall* be set to 04h.

The Side Change Capable (SCC) bit, when set to zero, *shall* indicate that the logical unit is not capable of selecting both sides of the media. When set to one, *shall* indicate that the logical unit is capable of selecting both sides of the media.

The Supports Disc Present (SDP) bit, when set to zero, *shall* indicate that the logical unit cannot report the contents of the slots after a reset or Magazine change. When set to one, *shall* indicate that the logical unit can report the contents of the slots after a reset or Magazine change and that the response to the MECHANISM STATUS command will contain valid Disc is Present status information for all slots.

Highest Slot Number *shall* be set to the number of slots minus one.

Table 426 shows the mandatory commands to implement this Feature.

Table 426 - Mandatory commands for Embedded Changer Feature

OpCode	Commands
A6h	LOAD/UNLOAD MEDIUM
BDh	MECHANISM STATUS

Supplementary explanation for commands to implement this Feature:

- MECHANISM STATUS:
If logical unit supports Write Protect Feature (0004h), this command and the Media Cartridge Write Protection status bits (CWP_V, CWP) *shall* be supported.

17.4.2.43 Feature 0103h: CD Audio analog play

This Feature identifies logical units that have an analog audio output port and that can play media that contain CD-DA tracks.

To allow for the legacy method for the host computer to determine if audio operations are supported, logical units *shall* respond to a PLAY AUDIO (10) command which has a transfer length of zero, with GOOD status, regardless of whether or not this Feature is current.

Table 427 - CD Audio analog play Feature Descriptor

Bit Byte	7	6	5	4	3	2	1	0
0	(MSB) Feature Code = 0103h							
1	(LSB)							
2	Reserved		Version			Persistent	Current	
3	Additional Length = 04h							
4	Reserved				Scan	SCM	SV	
5	Reserved							
6	(MSB) Number of Volume Levels							
7	(LSB)							

The Feature Code field *shall* be set to 0103h.

The Version field *shall* be set to 0h.

The Persistent bit *shall* be defined as in Table 341 - *Feature Descriptor generic format* on page 564.

The Current bit *shall* be defined as in Table 341 - *Feature Descriptor generic format* on page 564.

The Additional Length field *shall* be set to 04h.

The Separate Channel Mute (SCM) bit, when set to zero, *shall* indicate that all audio channels are muted simultaneously. When set to one, *shall* indicate that each audio channel can be independently muted.

The Separate Volume (SV) bit, when set to zero, *shall* indicate that all audio channels will have the same volume level. When set to one, *shall* indicate that audio channel volume may be set independently.

The Scan bit, when set to zero, *shall* indicate that the SCAN command is not supported. The Scan bit, when set to one, *shall* indicate that the SCAN command *shall* be supported.

The Number of Volume Levels *shall* indicate the number of discrete volume levels supported by the logical unit. If the logical unit supports only turning audio on and off, the Number of Volume Levels field *shall* be set to 2.

Table 428 shows the mandatory commands to implement this Feature.

Table 428 - Mandatory commands for CD Audio analog play Feature

OpCode	Commands
2Bh	SEEK
42h	READ SUBCHANNEL
43h	READ TOC/PMA/ATIP
45h	PLAY AUDIO (10)
47h	PLAY AUDIO MSF
4Bh	PAUSE/RESUME
4Eh	STOP PLAY/SCAN
Conditional support	
BAh	SCAN

Supplementary explanation for commands to implement this Feature:

- **SEEK:**
The SEEK command *shall* halt the playing of audio and set the current position to the LBA specified in the command. This current position may be used by a future PLAY AUDIO (10) or PLAY AUDIO MSF commands.
- **SCAN:**
If the Scan bit is set to one, this command *shall* be supported.

Table 429 shows the mandatory mode page to implement this Feature.

Table 429 - Mandatory mode pages for CD Audio analog play Feature

Page Code	Mode pages
0Eh	CD Audio Control mode page

Supplementary explanation for the mode page to implement this Feature:

- CD Audio Control mode page:
This mode page *shall not* be affected by the insertion or removal of CD Audio media.

17.4.2.44 Feature 0104h: Microcode Upgrade

This Feature identifies logical units that can upgrade their microcode via the logical interface. While the download technique is standard, the microcode data is vendor unique. Logical units *shall* validate microcode data before making the microcode permanent.

Table 430 - Microcode Upgrade Feature Descriptor

Bit Byte	7	6	5	4	3	2	1	0
0	(MSB) Feature Code = 0104h (LSB)							
1								
2	Reserved		Version=1h				Persistent	Current
3	Additional Length = 04h							
4	Reserved							M5
5	Reserved							
6	Reserved							
7	Reserved							

The Feature Code field *shall* be set to 0104h.

The Version field *shall* be set to 1h.

The Persistent bit *shall* be defined as in Table 341 - Feature Descriptor generic format on page 564.

The Current bit *shall* be defined as in Table 341 - Feature Descriptor generic format on page 564.

The Additional Length field *shall* be set to 04h.

The M5 bit, if set to one, indicates that the logical unit supports 5-bit length Mode field in the READ BUFFER and WRITE BUFFER commands. If this bit is set to zero, the logical unit may not support 5-bit length Mode field in the READ BUFFER and WRITE BUFFER commands.

Table 431 shows the mandatory commands to implement this Feature.

Table 431 - Mandatory commands for Microcode Upgrade Feature

OpCode	Commands
3Bh	WRITE BUFFER
3Ch	READ BUFFER

Supplementary explanation for commands to implement this Feature:

- **WRITE BUFFER:**
The Download Microcode with Offsets and Save Mode (Mode = 111b) *shall* be supported. Buffer 0 *shall* be usable for microcode upgrades.
- **READ BUFFER:**
The Descriptor Mode (Mode = 011b) *shall* be supported.

17.4.2.45 Feature 0105h: Timeout

This Feature identifies a logical unit that can always respond to commands within a set time period. If a command cannot complete normally within the allotted time, it completes with an error.

The Timeout and Protect mode page *shall* be supported. See 17.11.3.5, "Timeout and Protect mode page" on page 685.

Commands that cannot complete normal execution within their specified time limit *shall* complete within the specified time limit with CHECK CONDITION status, 6/2E/00 INSUFFICIENT TIME FOR OPERATION.

Table 432 - Timeout Feature Descriptor

Bit Byte	7	6	5	4	3	2	1	0
0	(MSB) Feature Code = 0105h (LSB)							
1								
2	Reserved		Version = 1h				Persistent	Current
3	Additional Length = 04h							
4	Reserved							Group3
5	Reserved							
6	(MSB) Unit Length (number of sectors) (LSB)							
7								

The Feature Code field *shall* be set to 0105h.

The Version field *shall* be set to 1h.

The Persistent bit *shall* be defined as in Table 341 - Feature Descriptor generic format on page 564.

The Current bit *shall* be defined as in Table 341 - Feature Descriptor generic format on page 564.

The Additional Length field *shall* be set to 04h.

The Group3 bit of one indicates that the logical unit supports G3Enable bit and Group3 Time out field in the Timeout and Protect mode page. See 14.1.1, "Group 3 timeout for Real Time Stream recording/playback" on page 509. If Real-Time Streaming Feature (0107h) is not supported, this bit *shall not* be set to one.

The Unit Length field indicates a unit of block length corresponds to increase a unit of Group 3 time unit. When the Group3 bit is set to 0, Unit Length field is not valid.

Table 433 shows the mandatory commands to implement this Feature.

Table 433 - Mandatory commands for Timeout Feature

OpCode	Commands
Conditional support	
2Fh	VERIFY (10)
4Ah	GET EVENT/STATUS NOTIFICATION

Supplementary explanation for commands to implement this Feature:

- VERIFY (10):
If the Group3 bit is set to one in the Feature Descriptor, the VERIFY (10) command with G3tout bit *shall* be supported.
- GET EVENT/STATUS NOTIFICATION:
If queuing is supported, this command and the Device Busy Class *shall* be supported.

17.4.2.46 Feature 0106h: DVD CSS

This Feature identifies a logical unit that can perform DVD CSS/CPM authentication and key management.

This Feature identifies logical units that support CSS for DVD-Video and CPPM for DVD-Audio. The logical unit *shall* maintain the integrity of the keys by only using DVD CSS authentication and key management procedures. This Feature *shall* be current only if a media containing CSS-protected DVD-Video and/or CPPM-protected DVD-Audio content is loaded.

Table 434 - DVD CSS Feature Descriptor

Bit Byte	7	6	5	4	3	2	1	0
0	Feature Code = 0106h (MSB) (LSB)							
1								
2	Reserved		Version				Persistent	Current
3	Additional Length = 04h							
4	Reserved							
5	Reserved							
6	Reserved							
7	CSS version							

The Feature Code field *shall* be set to 0106h.

The Version field *shall* be set to 0h.

The Persistent bit *shall* be defined as in Table 341 - Feature Descriptor generic format on page 564.

The Current bit *shall* be defined as in Table 341 - Feature Descriptor generic format on page 564. This bit *shall* be set to zero if DVD CSS/CPM medium is not present.

The Additional Length field *shall* be set to 04h.

The CSS version *shall* be set to 01h.

Table 435 shows the mandatory commands to implement this Feature.

Table 435 - Mandatory commands for DVD CSS Feature

OpCode	Commands
A3h	SEND KEY
A4h	REPORT KEY
ADh	READ DISC STRUCTURE

Supplementary explanation for commands to implement this Feature:

- SEND KEY:
The Key Class field value of 00h *shall* be supported.
- REPORT KEY:
The Key Class field value of 00h and all KEY Formats except 010001b *shall* be supported. The KEY Format 000100b (TITLE KEY) will not succeed for CPPM protected sectors, since they do not contain a Title Key.
- READ DISC STRUCTURE:
The Format Code field value of 02h (DISC KEY) *shall* be supported.

17.4.2.47 Feature 0107h: Real-Time Streaming

This Feature identifies logical units that support reporting and setting of performance parameters. The host may request that the logical unit perform at a certain data rate. A host may request a lower rate than the logical unit's maximum to identify a need for a continuous stream of data. This is desired because many applications need their average data rate to be constant, even over short periods of time. If a logical unit *shall* physically slow the medium to avoid "once around" access delays, this Feature provides the host requirements to the logical unit without specifying how that behavior is to be achieved.

This Feature also indicates whether the logical units support the Stream playback operation (see 9.2, "Stream playback operation" on page 472).

Table 436 - Real-Time Streaming Feature Descriptor

Bit Byte	7	6	5	4	3	2	1	0
0	(MSB) Feature Code = 0107h (LSB)							
1								
2	Reserved		Version = 5h ^a				Persistent	Current
3	Additional Length = 04h							
4	Reserved		SMP	RBCB	SCS	MP2A	WSPD	SW
5	Reserved							
6	Reserved							
7	Reserved							

a. Version number 4 was assigned when SET READ AHEAD Command was removed from this Feature.

The Feature Code field *shall* be set to 0107h.

The Version field *shall* be set to 5h.

The Persistent bit *shall* be defined as in Table 341 - Feature Descriptor generic format on page 564.

The Current bit *shall* be defined as in Table 341 - Feature Descriptor generic format on page 564.

The Additional Length field *shall* be set to 04h.

The Set Minimum Performance bit (SMP) bit indicates that the logical unit supports the HIE bit in Table 807 - *Performance Descriptor* on page 890 of SET STREAMING command.

The Read Buffer Capacity Block (RBCB) bit indicates that the logical unit supports the READ BUFFER CAPACITY command and its Block bit.

The Set CD Speed (SCS) bit indicates that the logical unit supports the SET CD SPEED command.

The Mode Page 2A (MP2A) bit indicates that the C/DVD Capabilities and Mechanical Status mode page with the logical unit Write Speed Performance Descriptor Blocks are supported.

A Write Speed Performance Descriptor (WSPD) bit of one indicates that the logical unit supports the Write Speed (Type field = 03h) data of GET PERFORMANCE command and the WRC field of SET STREAMING command. This bit *shall* be set to one, if logical unit supports writing speed selection.

A Streaming Writing (SW) bit of one indicates that the logical unit supports the Stream recording operation. A SW bit of zero indicates that the logical unit may not support the Stream recording operation (see 9.1, "Stream recording operation" on page 471).

Table 437 shows the mandatory commands to implement this Feature.

Table 437 - Mandatory commands for Real-Time Streaming Feature

OpCode	Commands
A7h	SET READ AHEAD
A8h	READ (12)
ACh	GET PERFORMANCE
B6h	SET STREAMING
Conditional support	
AAh	WRITE (12)
BBh	SET CD SPEED

Supplementary explanation for commands to implement this Feature:

- READ (12):
The Streaming bit *shall* be supported.
- GET PERFORMANCE:
The Type field value of 00h *shall* be supported. If the SW bit is set to one, Type field value of 01h *shall* be supported. If the WSPD bit is set to one, Type field value of 03h *shall* be supported.
- SET STREAMING:
If the WSPD bit is set to one, the WRC field *shall* be supported.
- WRITE (12):
If the SW bit is set to one, the WRITE (12) command with the Streaming bit *shall* be supported,
- SET CD SPEED:
If the SCS bit is set to one, this command *shall* be supported.

Table 438 shows the mandatory mode page to implement this Feature.

Table 438 - Mandatory mode pages for Real-Time Streaming Feature

Page Code	Mode pages
Conditional support	
2Ah	C/DVD Capabilities and Mechanical Status mode page

Supplementary explanation for the mode page to implement this Feature:

- C/DVD Capabilities and Mechanical Status mode page:
If the MP2A bit is set to one, the C/DVD Capabilities and Mechanical Status mode page *shall* be supported.

17.4.2.48 Feature 0108h: Logical unit Serial Number

This Feature identifies a logical unit that has a unique serial number. A logical unit can be uniquely identified by checking its vendor ID, model ID, and serial number.

Table 439 - Logical unit Serial Number Feature Descriptor

Bit Byte	7	6	5	4	3	2	1	0
0	(MSB) Feature Code = 0108h (LSB)							
1								
2	Reserved		Version				Persistent	Current
3	Additional Length							
4-n	Serial Number							

The Feature Code field *shall* be set to 0108h.

The Version field *shall* be set to 0h.

The Persistent bit *shall* be set to one.

The Current bit *shall* be set to one.

The Additional Length field *shall* be set to a multiple of 4.

The Serial Number *shall* be ASCII graphic codes (i.e. codes 20h - 7Eh). Any unused bytes in the Serial Number *shall* be padded with spaces (20h). There should not be more than three pad bytes.

17.4.2.49 Feature 0109h: Media Serial Number

See MMC.

17.4.2.50 Feature 010Ah: Disc Control Blocks

See MMC.

17.4.2.51 Feature 010Bh: DVD CPRM

This Feature identifies a logical unit that supports DVD CPRM and can perform DVD CPRM authentication and key management. This Feature *shall* be current only if a DVD CPRM recordable or rewritable medium is loaded.

Table 440 - DVD CPRM Feature Descriptor

Bit Byte	7	6	5	4	3	2	1	0
0	(MSB)							
1	Feature Code = 010Bh							
	(LSB)							
2	Reserved		Version				Persistent	Current
3	Additional Length = 04h							
4	Reserved							
5	Reserved							
6	Reserved							
7	CPRM version							

The Feature Code field *shall* be set to 010Bh.

The Version field *shall* be set to 0h.

The Persistent bit *shall* be defined as in Table 341 - *Feature Descriptor generic format* on page 564.

The Current bit *shall* be defined as in Table 341 - *Feature Descriptor generic format* on page 564. This bit *shall* be set to zero if DVD CPRM media is not present.

The Additional Length field *shall* be set to 04h.

The CPRM version field *shall* be set to 01h.

Table 441 shows the mandatory commands to implement this Feature.

Table 441 - Mandatory commands for DVD CPRM Feature

OpCode	Commands
A3h	SEND KEY
A4h	REPORT KEY
ADh	READ DISC STRUCTURE

Supplementary explanation for commands to implement this Feature:

- SEND KEY:
The Key Class field value of 00h and KEY Formats 000001b, 000011b, and 111111b *shall* be supported.
- REPORT KEY:
The Key Class field value of 00h and KEY Formats 000001b, 000010b, 010001b, and 111111b *shall* be supported.
- READ DISC STRUCTURE:
The Format Code field values of 06h and 07h *shall* be supported.

17.4.2.52 Feature 010Ch: Firmware Information

This Feature *shall* indicate that the logical unit provides the date and time of the compilation of the current firmware revision loaded on the logical unit. The date and time *shall* be the date and time of compilation of the firmware. The date and time *shall* be UTC, contain only the ASCII digits 0-9, and be zero-padded (i.e. use '09', not '9'). The date (C, Y, M, D Fields) *shall not* change for a given firmware revision. The date and time *shall* be later on “newer” firmware for a given logical unit. This Feature *shall* be persistent and current if present. No commands are required for this Feature.

Note: For example, if the date to be set is April 24, 2003, the Century field is set to “20”, the Year field is set to “03”, Month field is set to “04”, and Day field is set to “24” in numerical ASCII digits.

Table 442 - Firmware Information Feature Descriptor

Bit Byte	7	6	5	4	3	2	1	0	
0	(MSB)								
1	Feature Code = 010Ch								
	(LSB)								
2	Reserved		Version				Persistent	Current	
3	Additional Length = 10h								
4	Century (C)								
5									
6	Year (Y)								
7									
8	Month (M)								
9									
10	Day (D)								
11									
12	Hour (h)								
13									
14	Minutes (m)								
15									
16	Seconds (s)								
17									
18	Reserved								
19									

Note: This Feature may be used to help switch default software behavior for logical units with firmware produced after a certain date.

The Feature Code field **shall** be set to 010Ch.

The Version field **shall** be set to 0h.

The Persistent bit **shall** be defined as in Table 341 - *Feature Descriptor generic format* on page 564.

The Current bit **shall** be defined as in Table 341 - *Feature Descriptor generic format* on page 564.

The Additional Length field **shall** be set to 10h.

17.4.2.53 Feature 010Dh: AACS

This Feature identifies a logical unit that supports AACS and is able to perform AACS authentication process. This Feature *shall* be current only if an AACS medium is loaded.

Table 443 - AACS Feature Descriptor

Bit Byte	7	6	5	4	3	2	1	0
0	(MSB) Feature Code = 010Dh (LSB)							
1								
2	Reserved		Version = 1h			Persistent	Current	
3	Additional Length = 04h							
4	Reserved				WBE	BEC	BNG	
5	Block Count for Binding Nonce							
6	Reserved				Number of AGIDs			
7	AACS Version							

The Feature Code field *shall* be set to 010Dh.

The Version field *shall* be set to 1h.

The Persistent bit *shall* be defined as in Table 341 - *Feature Descriptor generic format* on page 564.

The Current bit *shall* be defined as in Table 341 - *Feature Descriptor generic format* on page 564. This bit *shall* be set to zero if AACS media is not present.

The Additional Length field *shall* be set to 04h.

The BNG bit *shall* be set to one if the logical unit supports generating the Binding Nonce. Otherwise it *shall* be set to zero.

The BEC bit *shall* be set to one if the logical unit supports Bus Encryption. Otherwise this bit *shall* be set to zero.

The WBE bit *shall* be set to zero if the logical unit supports Bus Encryption but only supports Bus Encryption from the logical unit to the host. If the logical unit supports writing sectors subject to Bus Encryption, this bit *shall* be set to one.

The Block Count for Binding Nonce field *shall* specify how many blocks are required to store the Binding Nonce for the media.

The Number of AGIDs field indicates the maximum number of AGIDs that the logical unit supports concurrently.

The AACS Version field *shall* be set to 01h.

Table 444 shows the mandatory commands to implement this Feature.

Table 444 - Mandatory commands for AACS Feature

OpCode	Commands
A3h	SEND KEY
A4h	REPORT KEY
ADh	READ DISC STRUCTURE
Conditional support	
BFh	SEND DISC STRUCTURE

Supplementary explanation for commands to implement this Feature:

- **SEND KEY:**
The **Key Class** field value of 02h *shall* be supported.
- **REPORT KEY:**
The **Key Class** field value of 02h with **KEY Format** values of 000000b, 000001b, 000010b, 100001b and 111111b *shall* be supported. If the **BNG** bit is set to 1b, the **KEY Format** value of 100000b *shall* be supported.
- **READ DISC STRUCTURE:**
The **Format Code** field values of 80h, 81h, 82h and 83h *shall* be supported. If the **BEC** bit is set to 1b, the **Format Code** field value of 84h *shall* be supported. Further, if the **WBE** bit is set to 1b, the **Format Code** field value of 85h *shall* be supported.
- **SEND DISC STRUCTURE:**
If both of the **BEC** and the **WBE** bits are set to 1b, this command with the **Format Code** field value of 84h and 85h *shall* be supported.

17.4.2.54 Feature 010Eh: DVD CSS Managed recording

This Feature identifies a logical unit that supports CSS Managed recording on DVD-Download disc. This Feature *shall* be current only if a recordable DVD-Download disc is loaded.

Table 445 - DVD CSS Managed recording Feature Descriptor

Bit Byte	7	6	5	4	3	2	1	0
0	(MSB) Feature Code = 010Eh (LSB)							
1								
2	Reserved		Version			Persistent	Current	
3	Additional Length = 04h							
4	Maximum number of Scramble Extent information entries							
5	Reserved							
6	Reserved							
7	Reserved							

The **Feature Code** field *shall* be set to 010Eh.

The **Version** field *shall* be set to 0h.

The **Persistent** bit *shall* be defined as in Table 341 - *Feature Descriptor generic format* on page 564.

The **Current** bit *shall* be defined as in Table 341 - *Feature Descriptor generic format* on page 564. This bit *shall* be set to zero if recordable DVD-Download disc is not present.

The **Additional Length** field *shall* be set to 04h.

The **Maximum number of Scramble Extent information entries** field *shall* be set to maximum number of entries that the logical unit can handle in a single **SEND DISC STRUCTURE** command. This number *shall* never be less than 15.

Table 446 shows the mandatory commands to implement this Feature.

Table 446 - Mandatory commands for DVD CSS Managed recording Feature

OpCode	Commands
A3h	SEND KEY
A4h	REPORT KEY
BFh	SEND DISC STRUCTURE

- SEND KEY:
The Key Class field value of 00h *shall* be supported.
- REPORT KEY:
The Key Class field value of 00h and all KEY Formats except 010001b *shall* be supported. The KEY Format 000100b (TITLE KEY) will not succeed for CPPM protected sectors, since they do not contain a Title Key.
- SEND DISC STRUCTURE:
The Format Code field values of 17h *shall* be supported.

17.4.2.55 Feature 0110h: VCPS

See MMC.

17.4.2.56 Feature 0113h: SecurDisc

This Feature identifies a logical unit that supports SecurDisc content protection and is able to perform SecurDisc authentication process. This Feature *shall* be current only if an optical disc currently in the logical unit can be used with SecurDisc. The Feature *shall* be current regardless of whether an optical disc has already been written to using SecurDisc or not.

Table 447 - SecurDisc Feature Descriptor

Bit Byte	7	6	5	4	3	2	1	0
0	(MSB) Feature Code = 0113h (LSB)							
1								
2	Reserved		Version			Persistent	Current	
3	Additional Length = 00h							

The Feature Code field *shall* be set to 0113h.

The Version field *shall* be set to 0h.

The Persistent bit *shall* be defined as in Table 341 - *Feature Descriptor generic format* on page 564.

The Current bit *shall* be defined as in Table 341 - *Feature Descriptor generic format* on page 564. This bit *shall* be set to zero if SecurDisc content protection capable medium is not present.

The Additional Length field *shall* be set to 00h.

Table 448 shows the mandatory commands to implement this Feature.

Table 448 - Mandatory commands for SecurDisc Feature

OpCode	Commands
A3h	SEND KEY
A4h	REPORT KEY

- SEND KEY:
The Key Class field value of 21h with KEY Format 000001b *shall* be supported.
- REPORT KEY:
The Key Class field value of 21h with KEY Formats 000000b, 000001b, 000010b and 111111b *shall* be supported.

Table 449 describes errors that may occur during the operation of the command or which may cause a CHECK CONDITION status to be reported.

Table 449 - GET CONFIGURATION command errors

Error Description	
5/24/00	INVALID FIELD IN CDB

17.5 GET EVENT/STATUS NOTIFICATION command

The GET EVENT/STATUS NOTIFICATION command requests the logical unit to report Event(s) and status as specified in the Notification Class Request field and provides asynchronous notification. Two modes of operation are defined here. They are Polling and Asynchronous modes.

In Polling mode, the host will issue GET EVENT/STATUS NOTIFICATION commands at periodic intervals with an immediate (Immed) bit of 1 set. The logical unit *shall* complete this command with the most recently available Event status requested. The logical unit *shall* support Polling mode.

In Asynchronous mode, the host will issue a single GET EVENT/STATUS NOTIFICATION command with the Immed bit of 0 requested. If the logical unit supports asynchronous Event status notification (through tagged queuing) the model outlined here *shall* be used. If the logical unit does not support Asynchronous mode, the command *shall* fail as an illegal request. If the host requests Asynchronous mode using a non-queueable or non-overlappable request, the command *shall* fail with CHECK CONDITION status, 5/24/00 INVALID FIELD IN CDB.

When asynchronous Event Status reporting is supported, the logical unit *shall not* complete a GET EVENT/STATUS NOTIFICATION command with an Immed bit of 0 until a change in Event status of the requested Class occurs. The logical unit *shall* complete the GET EVENT/STATUS NOTIFICATION command as soon after the Event occurs as possible. It will report the Event as outlined below.

When logical unit that support Physical Interface Asynchronous Notification such as SATA AN *shall* generate the Physical Interface Asynchronous Notification for changes in any and all Events from any and all Classes. When new event is generated in the logical unit, if the Physical Interface Asynchronous Notification was not acknowledged by the host, the logical unit *shall* send the Physical Interface Asynchronous Notification. Host may clear the Physical Interface Asynchronous Notification before issuing GET EVENT/STATUS NOTIFICATION command to cover the small window. For SATA AN, refer to B-13, "SATA Asynchronous Notification" on page 948.

Note: Only one Event Descriptor per GET EVENT/STATUS NOTIFICATION command shall be reported. The priority of Event or status reporting shall be by Class number. The lower the Class number, the higher the priority.

This command *shall not* return a CHECK CONDITION status due to a pending UNIT ATTENTION condition. Any pending UNIT ATTENTION condition for which a corresponding Event is reported *shall not* be cleared for the logical unit issuing the GET EVENT/STATUS NOTIFICATION command.

Implementation notes for logical units can be found in *Appendix E - "Example Event Implementation Notes (Informative)"* on page 963, and examples for hosts can be found in *Appendix I - "Sample Applications of Events (Informative)"* on page 993.

Table 450 - GET EVENT/STATUS NOTIFICATION Command Descriptor Block

Bit Byte	7	6	5	4	3	2	1	0
0	Operation Code (4Ah)							
1	LUN (Obsolete)			Reserved				Immed
2	Reserved							
3	Reserved							
4	Notification Class Request							
5	Reserved							
6	Reserved							
7	(MSB) Allocation Length (LSB)							
8								
9	Vendor-Specific	Reserved			NACA	Flag	Link	
10	PAD							
11								

If the **Immed** bit is set to one, and if there is no Event to report the command **shall** return good status.

If the **Immed** bit is set to zero (and the logical unit supports tagged command queuing) and if there is no event to report, the GET EVENT/STATUS NOTIFICATION command **shall** be queued by the logical unit until there is an Event to report.

If the **Immed** bit is set to zero and the logical unit does not support tagged command queuing, the logical unit **shall** return CHECK CONDITION status, 5/24/00 INVALID FIELD IN CDB.

The **Notification Class Request** field requests the logical unit to report Event(s) from the Classes listed requested in this field. A bit in this field, if set to one, indicates that the host requests the logical unit to report Events from corresponding Class defined in Table 451.

A bit field of all 0's indicates that the logical unit should immediately complete this command indicating No Event, and **shall** list the supported Classes in the Event Header. This method **shall** be used to determine which Classes a logical unit supports.

If a logical unit does not support any of the requested Classes, the logical unit **shall** terminate the command successfully, returning only the Event Header, and indicating a returned NEA bit of 1 and **Notification Class** field of 0.

Host software that manages Media Class Event status, may or may not be linked to other software that manages Power Management Class Event status. This **Notification Class Request** field provides a way that Power Management and Media Class Event status notifications can be independently managed by the responsible software. For example, if a host software manages Media, Power Management and Device Busy Class Events, the host can issue this command with **Notification Class Request** field set to 01010100b to request the logical unit to report Power Management, Media, and Device Busy Class Events.

Table 451 - Notification Class Request field definition

Bit	Definition
0	Reserved
1	Operational Change Request/Notification Class
2	Power Management Class
3	External Request Class
4	Media Class
5	Multi-host Class
6	Device Busy Class
7	Reserved

The **Allocation Length** field indicates the maximum number of bytes that **shall** be transferred from the logical unit. The **Allocation Length** field value of 4 or less indicates that the logical unit **shall** transfer Event Header only and **shall not** clear the Event. An Event **shall** be considered reported if Event Descriptor is transferred at least one byte. An **Allocation Length** field value of zero **shall not** be considered an error.

Note: The Allocation Length field definition of previous revisions (Fuji5 Rev. 1.3 and before) was as follows; "The Allocation Length field indicates the maximum number of bytes that shall be transferred from the logical unit. An event shall be considered reported even if the result data was truncated due to an insufficient Allocation Length." The host should set Allocation Length field to 8 or greater to retrieve Event Data correctly. Most of existing products in the market were designed to comply with previous revisions. Therefore the Event is cleared if Allocation Length field value is less than or equal to 4.

The returned data format is shown in Table 452.

Table 452 - Notification Status List

Bit Byte	7	6	5	4	3	2	1	0
0-3	Event Header							
0-n	Event Descriptor							

The format of the Event Header is shown in Table 453.

Table 453 - Event Header

Bit Byte	7	6	5	4	3	2	1	0
0	(MSB) Event Data Length (LSB)							
1								
2	NEA	Reserved				Notification Class		
3	Supported Classes							

The Event Data Length field specifies the amount of data that follows this field. The amount of data reported *shall* be the number of bytes data following the Event Data Length field.

The Notification Class field specifies the Class of notification by number. See Table 454.

Table 454 - Notification Class field definition

Field	Description
000b	No requested Classes are supported
001b	Operational Change Request/Notification Class
010b	Power Management Class
011b	External Request Class
100b	Media Class
101b	Multi-host Class
110b	Device Busy Class
111b	Reserved.

The No Event Available (NEA) bit, when set to one, *shall* indicate that none of the requested notification Classes are supported. When set to zero, *shall* indicate that at least one of the requested notification Classes is supported.

The Supported Classes field specifies the Classes that the logical unit supports as per the Notification Class Request field of Table 451 - *Notification Class Request field definition* on page 630. If an Class is supported, the corresponding bit *shall* be set to one.

17.5.1 Operational Change Request/Notification Class Events

This Event notifies the host of changes of operational capabilities or parameters of the logical unit.

Table 455 - Operational Change Request/Notification Class Event Descriptor

Bit Byte	7	6	5	4	3	2	1	0
0	Reserved				Operational Event			
1	Persistent Prevented	Reserved			Operational Status			
2	(MSB) Operation Request/Report (LSB)							
3								

The Operational Event field reports the type of the operational change of the logical unit. See Table 456.

Table 456 - Operational Event field definition

Code	Event	Description
0h	NoChg	No changes in operational state performed or requested
1h	Reserved	
2h	Logical unit may have changed Operational State	The Logical unit may have changed operational state.
3h-Fh	Reserved	

If a new Event occurs before an existing Event is reported to the host, the new Event *shall* replace the old Event if the new Event has a higher Code than the old Event. Otherwise, the new Event *shall* be deleted.

The Persistent Prevented bit reports the current state of the Persistent Prevent for the logical unit.

The Operational Status field *shall* report 0h.

The Operation Request/Report field reports the operation requested or operation that has been performed. The request usually originates from the unit's own user interface (i.e. front panel buttons) or from another host.

Table 457 - Operation Request/Report field definition

Code	Event	Description
0000h	NoChg	No changes in operational state performed or requested
0001h	Feature Change	Current Profile field, Current bit and/or Last LBA field in the GET CONFIGURATION response data of the logical unit may have changed.
0002h	Obsolete	-
0003h	Obsolete	-
0004h	Obsolete	-
0005h	Obsolete	-
0006h- FFFFh	Reserved	-

17.5.2 Power Management Class Events

Power Management Class Events notify the host about changes in the logical unit's power state.

Table 458 - Power Management Class Event Descriptor

Bit Byte	7	6	5	4	3	2	1	0
0	Reserved				Power Event			
1	Power Status							
2	Reserved							
3	Reserved							

The Power Event field reports the current change in the power status. This field is set to a new power Event if a change in power state occurs.

Upon reporting the current power status change to the host, this field is reported as 0h on subsequent GET EVENT/STATUS NOTIFICATION commands until a new change in power state occurs.

If the logical unit is commanded to go the same state as the logical unit is currently in, the next GET EVENT/STATUS NOTIFICATION command (Power Management Class) *shall* report a PwrChg-Succ (Power Change Successful) Event.

Table 459 - Power Event field definition

Code	Event	Description
0h	NoChg	No changes in power state, or in power state transition
1h	PwrChg-Succ	The logical unit successfully changed to the specified power state
2h	PwrChg-Fail	The logical unit failed to enter the last requested state, and is still operating at the power state specified in the Power Status field
3h-Fh	Reserved	

The Power Status field indicate the power state of the logical unit. See Table 460. The Power Status field *shall* be set to 03h (Standby) by a hard reset, power-on reset or Device reset (issued from Sleep state).

Note: Power Status field value of 4 is only likely reported with asynchronous event notification.

Table 460 - Power Status field definition

Code	Status	Description
0h	Reserved	-
1h	Active	The logical unit is in Active state
2h	Idle	The logical unit is in Idle state
3h	Standby	The logical unit is in Standby state
4h	Sleep	The logical unit is about to enter Sleep state
5h-Fh	Reserved	-

17.5.3 External Request Class Events

External Request Class Events notify the host of changes in behavior due to requests from the logical unit front panel or another host. If a Persistent Prevent is active, the Event is a request to change rather than a notification of a change.

Table 461 - External Request Class Event Descriptor

Bit Byte	7	6	5	4	3	2	1	0
0	Reserved				External Request Event			
1	Persistent Prevented	Reserved			External Request Status			
2	(MSB) External Request (LSB)							
3								

The External Request Event field reports external requests to change state and notifications of changes in logical unit state. If a Persistent Prevent is in place for the host, the action *shall not* be performed by the logical unit. If a Persistent Prevent is not in place for the host, the logical unit *shall* notify the host of actions that change logical unit state. Upon reporting operational change notification to the host, this field is reported as 0h on subsequent GET EVENT/STATUS NOTIFICATION commands until a new External Request Class occurs. The External Request Class Events are listed in Table 462.

Table 462 - External Request Event field definition

Code	Event	Description
0h	NoChg	No changes in operational state performed or requested
1h	Logical unit Key Down	A front, back, or remote button has been pressed.
2h	Logical unit Key Up	A front, back, or remote button has been released.
3h	External Request Notification	The logical unit has received a command from another host that would require an action that may interfere with the Persistent Prevent owner's operation.
4h-Fh	Reserved	-

The host may respond to “Logical unit Key Down”, “Logical unit Key UP” and “External Request Notification” Events with no action, an appropriate action, or with a SEND EVENT command. The host may respond to “External Request Notification” Event with a GET CONFIGURATION command. “Logical unit Key Down” and “Logical unit Key UP” Events should occur in pairs.

The Persistent Prevented bit reports the current state of the Persistent Prevent for the logical unit. This bit *shall* be set to 1 if any host has performed a persistent reservation.

The External Request Status field reports the logical unit's ability to respond to the host.

Table 463 - External Request Status field definition

Code	Status	Description
0h	Ready	The logical unit is ready for operation.
1h	OtherPrevent	Indicates that another host has an active Persistent Prevent. The Persistent Prevented bit <i>shall</i> be set to 1.
2h-Fh	Reserved	-

The External Request field reports the operation requested or operation that has been performed. The request usually originates from the unit's own user interface (i.e. front panel buttons) or from another host.

Table 464 - External Request field definition

Code	Event	Description
0000h	NoRequest	No requests are pending.
0001h	Overrun	The Request Queue has overflowed, External Request Events may be lost.
0002h-0100h	Reserved	-
0101h	Play	The play button was pressed or another host sent a play request
0102h	Rewind/back	The rewind/back button was pressed or another host send a rewind/back request
0103h	Fast Forward	The fast forward button was pressed or another host sent a fast forward request
0104h	Pause	The pause button was pressed or another host sent a pause request.
0105h	Reserved	-
0106h	Stop	The stop button was pressed or another host requested a stop.
0107h-01FFh	Reserved	-
0200h-02FFh	ASCIIButton	A front panel button was pressed or equivalent action requested by another host. The button has an associated ASCII value. The ASCII value <i>shall</i> be the least significant 8 bits of the Code.
0300h-EFFFh	Reserved	-
F000h- FFFFh	Vendor Unique	-

17.5.4 Media Class Events

The Media Class Event describes Events related to the insertion and removal of media.

Table 465 - Media Class Event Descriptor

Bit Byte	7	6	5	4	3	2	1	0
0	Reserved				Media Event			
1	Media Status							
2	Start Slot							
3	End Slot							

Table 466 - Media Event field definition

Code	Event	Description
0h	NoChg	Media status is unchanged.
1h	EjectRequest	The logical unit has received a request from the user (usually through a mechanical switch on the logical unit) to eject the specified slot or media.
2h	NewMedia	The specified slot (or the logical unit) has received new media, and is ready to access it.
3h	MediaRemoval	The media has been removed from the specified slot, and the logical unit is unable to access the media without user intervention.
4h	MediaChange	The user has requested that the media in the specified slot be loaded.
5h	BgformatCompleted	Background Padding has completed.
6h-Fh		Reserved

Note: In the case of embedded medium changer, Usually two Events are generated when the user requests an eject: first, an EjectRequest Event, and then a MediaRemoval Event.

Note: Regardless of the Persistent Prevent condition, if the logical unit is locked state, the logical unit should generate EjectRequest Events upon receipt of a User Eject request.

Table 467 - Media Status Byte format

Bit Byte	7	6	5	4	3	2	1	0
1	Reserved						Media Present	Door or Tray open

The Door or Tray open bit indicates if the Tray or Door mechanism is in the open state. A bit of 1 indicates the door/tray is open.

The Media Present status bit indicates if there is media present in the logical unit. A bit of 1 indicates that there is media present in the logical unit. This bit is reported independently from the Door or Tray open bit. If the logical unit does not support the capability of reporting the media state while the door or tray is open *shall* set this bit to zero when the Door or Tray open bit is one.

The Start Slot field defines the first slot of a multiple slot logical unit the media status notification applies to. For logical units that do not support multiple slots, this field *shall* be set to 00h.

The End Slot field defines the last slot of a multiple slot logical unit the media status notification applies to. For logical units that do not support multiple slots, this field *shall* be set to 00h.

The slot numbers are defined by Table 509 - Mechanism Status Header on page 664.

17.5.5 Multi-host Class Events

Multi-host Class Events notify the host of requests for control by other hosts.

Table 468 - Multi-host Class Event Descriptor

Bit Byte	7	6	5	4	3	2	1	0
0	Reserved				Multi-host Event			
1	Persistent Prevented	Reserved			Multi-host Status			
2	(MSB) Multi-host Priority (LSB)							
3								

The Multi-host Event field reports requests for control of and reporting of changes in logical unit state. If a Persistent Prevent is in place for that host, the action *shall not* be performed by the logical unit. If a Persistent Prevent is not in place for that host, the logical unit *shall* notify the host of actions that change logical unit state. Upon reporting Multi-host Class Events to the host, this field is reported as 0h on subsequent GET EVENT/STATUS NOTIFICATION commands until a new Multi-host Class Event occurs. The Multi-host Class Events are listed in Table 469.

Table 469 - Multi-host Event field definition

Code	Event	Description
0h	NoChg	No changes in operational state performed or requested
1h	Control Request	Another host has requested logical unit control.
2h	Control Grant	Another host has received logical unit control.
3h	Control Release	Another host has released logical unit control.
4h-Fh	Reserved	-

The host may respond to “Control Request”, “Control Grant” and “Control Release” Events with no action or an appropriate Persistent Prevent or Persistent Allow.

The Persistent Prevented bit reports the current state of the Persistent Prevent for the logical unit.

The Multi-host Status field reports the logical unit’s ability to respond to the host.

Table 470 - Multi-host Status codes

Code	Status	Description
0h	Ready	The logical unit is ready for operation.
1h	OtherPrevent	Indicates that another host has an active Persistent Prevent. The Persistent Prevented bit <i>shall</i> be set to 1.
2h-Fh	Reserved	

The Multi-host Priority field reports the other host’s relative priority. See Table 471.

Table 471 - Multi-host Priority field definition

Code	Event	Description
0000h	NoRequest	No requests are pending.
0001h	Low	There are no tasks pending on the host for this logical unit.
0002h	Medium	There are no critical tasks pending on the host for this logical unit.
0003h	High	There are critical tasks pending on the host for this logical unit.
0004h-FFFFh	Reserved	-

17.5.6 Device Busy Class Events

Device Busy Class Events are used to notify the host of the status of an immediate command that is executing but that require a long time to complete. In this case the logical unit may become Busy, thereby limiting the number of commands that may be executed to completion. Conditions that may cause the logical unit to become Busy are defined in 3.5, "Logical Unit Not Busy condition/Busy condition" on page 77.

Note: The functionality and descriptions of this Event is changed completely from the old version of this document. Host should check DBEvent bit in Core Feature (0001h) to detect the implemented function of the logical unit.

To retrieve progress indication synchronously, the Immed bit should be set to 1 and the Notification Class Request field should be set to 40h.

Table 472 - Device Busy Class Event Descriptor

Bit Byte	7	6	5	4	3	2	1	0
0	Reserved				Device Busy Event			
1	Device Busy Status							
2	(MSB)							
3	Time (LSB)							

When the Device Busy Status field is set to Busy (01h), the Time field is the predicted amount of time remaining for the logical unit to become not busy, in units of 100ms. This field provides progress indication in time unit. If the Device Busy Status field is other than 01h, the contents of the Time field are unspecified. 17.31.1, "Sense-key Specific" on page 835 describes progress indication in percent.

Table 473 - Device Busy Event field definition

Code	Event	Description
0h	NoChg	No changes in Logical unit state
1h	Change	Logical Unit Busy condition has been changed.
2h-Fh	Reserved	

Table 474 - Device Busy Status field definition

Code	Status	Description
00h	NoEvent	The logical unit is ready to accept a next command.
01h	Busy	The Logical unit is busy. The Logical unit may not be able to accept media access commands.
02h-FFh	Reserved	

If a GET EVENT/STATUS NOTIFICATION command of Device Busy Class Events is queued, when Logical unit changes the busy state by an immediate command that executes long operations, the queued GET EVENT/STATUS NOTIFICATION command **shall** be terminated to notify the logical unit busy state change. If the queued GET EVENT/STATUS NOTIFICATION command can be terminated before the completion of the immediate command, the queued GET EVENT/STATUS NOTIFICATION command **shall** be terminated first.

If both the host and the logical unit support command queuing, the host should issue a GET EVENT/STATUS NOTIFICATION command requesting only the Device Busy Class Events with the **Immed** bit in the CDB set to zero prior to issuing the command that may cause a logical unit busy condition. If the logical unit becomes busy, the first GET EVENT/STATUS NOTIFICATION command **shall** be executed to report the Change (Not-Busy to Busy transition). The host may issue another GET EVENT/STATUS NOTIFICATION command for the purpose of being notified of completion. Once the command has stopped executing, the second GET EVENT/STATUS NOTIFICATION command **shall** be executed to report the Change (Busy to Not-Busy transition). Figure 220 shows the flow of execution of a command that may cause a logical unit busy condition.

Implementation example can be found in *I-4.1 "Example of Device Busy Class Events reporting"* on page 998.

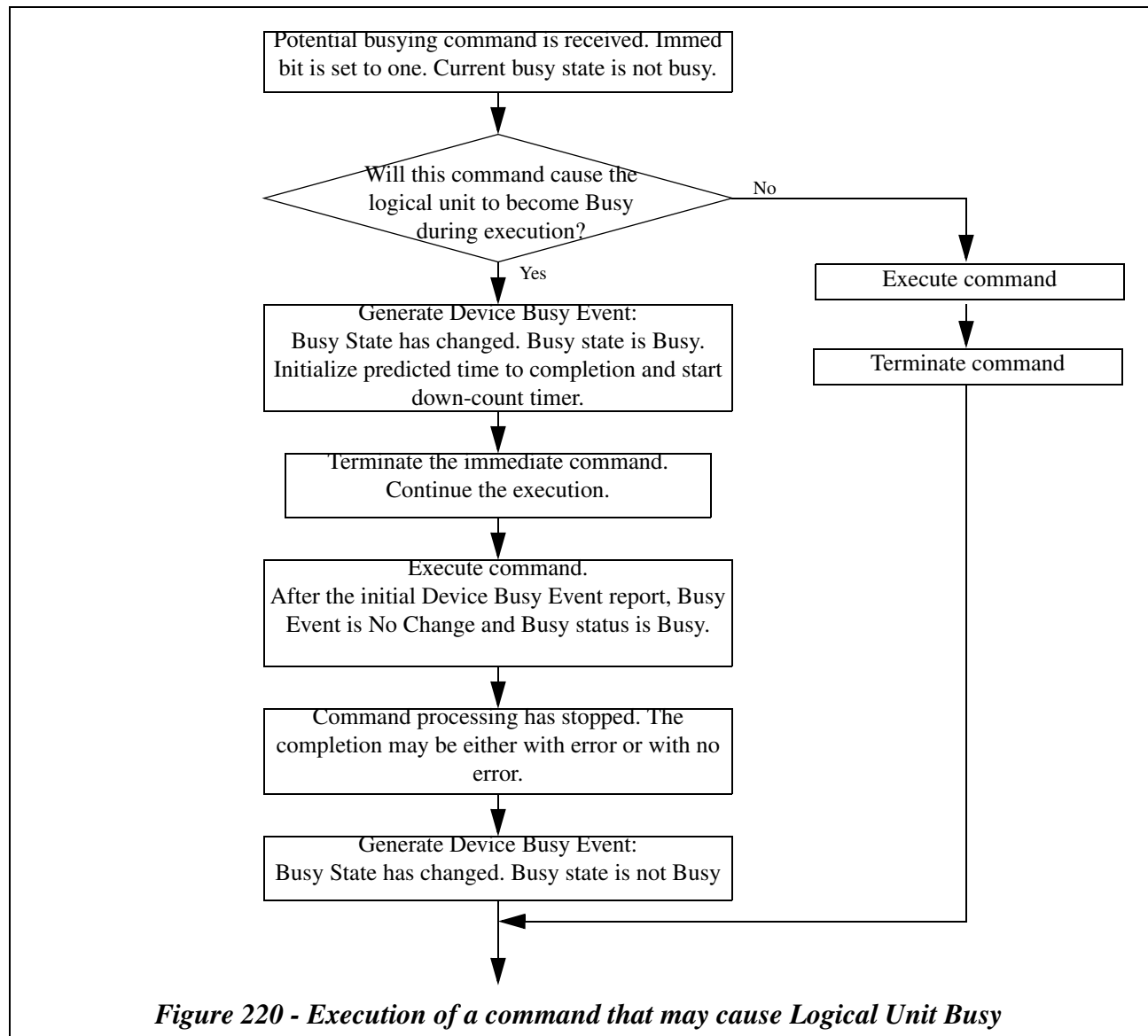


Table 475 describes errors that may occur during the operation of the command or which may cause a CHECK CONDITION status to be reported.

Table 475 - GET EVENT/STATUS NOTIFICATION command errors

Error Description	
5/24/00	INVALID FIELD IN CDB

17.6 GET PERFORMANCE command

The GET PERFORMANCE command provides a method for the host to profile the performance of the logical unit. The command also provides a means for the host to get unusable area information on the mounted writable medium.

Table 476 - GET PERFORMANCE Command Descriptor Block

Bit Byte	7	6	5	4	3	2	1	0
0	Operation Code (ACh)							
1	LUN (Obsolete)			Data Type				
2	(MSB) Starting LBA (LSB)							
3								
4								
5								
6								
7	Reserved							
8	(MSB) Maximum Number of Descriptors (LSB)							
9								
10	Type							
11	Vendor-Specific		Reserved			NACA	Flag	Link

The Data Type field definition is dependent upon the Type field value, see Table 477.

The Type field specifies which type of data *shall* be transferred. See Table 477.

The definition of the other fields and bits are changed according to the Type field value, see Table 477.

If the logical unit does not support the specified value of Type field on the media, the logical unit *shall* terminate this command with CHECK CONDITION status, 5/24/00 INVALID FIELD IN CDB.

Table 477 - Type field values description

Type field value	Definition	Data Type field				Reference
		bit 4 - 3	bit 2	bit 1	bit 0	
00h	Performance	Tolerance	Write	Except		see 17.6.1
01h	Unusable Area	Reserved	Unusable Area Type			see 17.6.2
02h	Defect Status	Reserved				see 17.6.3
03h	Write Speed	Reserved				see 17.6.4
04h	DBI	Reserved				see 17.6.5
05h	DBI cache zone	Reserved				see 17.6.6
06h-FFh	Reserved					

17.6.1 Performance (Type field = 00h)

The command reports its characteristics of reading/writing performance.

The command can report two groups of parameters: the nominal performance and exception locations that may cause seek delays to occur. These performance parameters are reported separately for read and write.

The corresponding parameter fields allocation are specified in Table 477.

The **Tolerance** field, when set to 10b, *shall* indicate that the descriptors returned *shall* have a 10% performance tolerance for the nominal performance and a 20% time tolerance for the exception list. All other values are reserved for future standardization.

The **Except** field, when set to 00b, *shall* indicate that the nominal performance parameters be returned. When set to 01b, the entire performance exception list, qualified by the **Starting LBA**, *shall* be returned. When set to 10b, only performance exceptions that cause the performance to fall outside the nominal *shall* be reported. For example, slipped sectors may not be included in the 10b list, but would be included in the 01b list. An **Except** field of 11b is reserved.

The **Write** bit, when set to zero, *shall* indicate that the performance parameters for reading *shall* be returned. When set to one, the performance parameters for writing *shall* be returned.

The **Starting LBA** field is valid only when **Except** = 01b. If **Except** = 01b, the **Starting LBA** field *shall* indicate the starting point for returning performance data. All performance data *shall* be for logical block addresses equal to this field or greater.

The **Maximum Number of Descriptors** field *shall* indicate the maximum number of descriptors that the logical unit returns. The **Maximum Number of Descriptors** field should not be set to zero. If the **Maximum Number of Descriptors** field is set to zero, only the Performance Header *shall* be returned.

The result data *shall* be formatted as listed in Table 478:

Table 478 - Performance Result Data

Bit Byte	7	6	5	4	3	2	1	0
0-7	Performance Header							
8-n	Performance Descriptor(s)							

Table 479 - Performance Header

Bit Byte	7	6	5	4	3	2	1	0
0	(MSB)							
1								
2								
3								
4	Reserved					Write	Except	
5	Reserved							
6	Reserved							
7	Reserved							

The **Performance Data Length** field specifies the length in bytes of the following result data. The **Performance Data Length** value does not include the **Performance Data Length** field itself. This value is not modified when the Maximum number of descriptors is insufficient to return all of the Performance data available.

The **Write** bit, when set to zero, *shall* indicate that the result data is for read performance using the nominal command for the data type. When set to one, *shall* indicate that the result data is for write performance.

The **Except** bit, when set to zero, *shall* indicate that the result data is for nominal performance. When set to one, *shall* indicate that the result data is for exception conditions.

Performance Descriptors that is used for the current medium *shall* be returned regardless of the disc spinning or stop. It may not be the performance that is specified by host. If no media is present, Performance Descriptors for the fastest medium *shall* be returned.

The Performance Descriptors for nominal performance are intended to give the host an approximation of logical unit performance. All numbers are nominal. On CD media, all sectors *shall* be reported as 2 352 byte sectors.

For example, a 4×-6× CD-ROM logical unit (CAV/CLV combination) with a data disc loaded may return two nominal performance descriptors. The first would indicate a Start LBA of 0, Start Performance of 706 kB/s, and an end LBA in the middle and a performance of 1 058 kB/s. The second would indicate a start LBA adjacent to the ending LBA of the previous descriptor, a start performance of 1 058 kB/s, and an end LBA at the end of the medium and an ending performance of 1 058 kB/s. The data rate may vary according to the mounted medium, i.e. CD Audio Tracks may have a different spin rate than Data Tracks. A host software may refer this information to predict total burning time on the mounted medium. For more examples refer to the F-2, "GET PERFORMANCE command Performance (Type field = 00h)" on page 971.

1kB/s is 1 000 Bytes per second.

Table 480 - Performance Descriptor - Nominal Performance

Bit Byte	7	6	5	4	3	2	1	0
0	(MSB) Start LBA (LSB)							
1								
2								
3								
4	(MSB) Start Performance (LSB)							
5								
6								
7								
8	(MSB) End LBA (LSB)							
9								
10								
11								
12	(MSB) End Performance (LSB)							
13								
14								
15								

The **Start LBA** field contains the first logical block address of the extent described by this descriptor.

The **Start Performance** field contains the nominal logical unit performance at the Start LBA in kB/s.

The **End LBA** field contains the last logical block address of the extent described by this descriptor.

The **End Performance** field contains the nominal logical unit performance at the End LBA in kB/s.

Note: These fields return only the informational value that is expected before start reading/writing. The exact start location of the extent may vary according to the disc/drive condition. In some cases, one or more descriptors reported may not be performed according to the disc/drive condition. To examine the CAV performance End LBA field is important.

Table 481 - Performance Descriptor - Exceptions

Bit Byte	7	6	5	4	3	2	1	0
0	(MSB) LBA (LSB)							
1								
2								
3								
4	(MSB) Time (LSB)							
5								

The LBA field *shall* indicate that there is a seek delay between (LBA - 1) and LBA.

The Time field *shall* indicate the expected additional delay between (LBA - 1) and LBA from nominal, in units of tenths of milliseconds (100 microseconds). This seek delay may be due to linear replacement, zone boundaries, or other media dependent features. The expected additional delay should represent the typical time expected for the type of exception described.

Note: A block replaced by linear replacement may cause two exceptions to appear in the Exception Descriptor list - one between the non-replaced area and the beginning of the replaced block, and one from the end of the replaced block back to the non-replaced area.

17.6.2 Unusable Area Data (Type field = 01h)

This command reports data to the host that how the physically unusable areas are allocated on the mounted writable media. If the mounted media is not a writable media, the logical unit terminates the command with CHECK CONDITION status, 5/24/00 INVALID FIELD IN CDB.

The corresponding parameter fields allocation are specified in Table 477.

The Unusable Area Type field specifies the type of the unusable area to be transferred. See Table 482.

Table 482 - Unusable Area Type values

Unusable Area Type value	Description
000b	Zone boundary information
001b	PDL information
010b	SDL information
Others	Reserved

The Starting LBA field in CDB *shall* indicate the starting point for returning Unusable Area data. All Unusable Area data *shall* be for logical block addresses equal to this field or greater.

The Maximum Number of Descriptors field *shall* indicate the maximum number of descriptors that the logical unit returns.

The Unusable Area data *shall* be formatted as listed in Table 483. The Unusable Area data contains a header, followed by zero or more Descriptors. Each Descriptor contains information about an Unusable Area such as an entry of defect list and Zone boundary, see 4.16.1, "Logical layout of DVD-RAM media" on page 117 or 5.17.1, "Logical layout of HD DVD-RAM media" on page 443.

Table 483 - Unusable Area Data

Bit Byte	7	6	5	4	3	2	1	0
0-7	Unusable Area Header							
8-n	Unusable Area Descriptor(s)							

Each Unusable Area Descriptor(s) *shall* be transferred to the host in ascending order of the Starting LBA.

Table 484 - Unusable Area Header

Bit Byte	7	6	5	4	3	2	1	0
0	(MSB) Unusable Area Data Length (LSB)							
1								
2								
3								
4-7	Reserved							

The Unusable Area Data Length field specifies the length in bytes of the following result data. The Unusable Area Data Length value does not include the Unusable Area Data Length field itself. This value is not modified when the Maximum number of descriptors is insufficient to return all of the Unusable Area data available.

Table 485 - Unusable Area Descriptor

Bit Byte	7	6	5	4	3	2	1	0
0	(MSB) LBA (LSB)							
1								
2								
3								
4	(MSB) Number of Unusable Physical Blocks (LSB)							
5								
6								
7								

The LBA field *shall* indicate the first LBA of the unusable area if the Unusable Area Type field in CDB is set to 010b. The LBA field *shall* indicate the LBA just before the unusable area when the Unusable Area Type field in CDB is set to 000b or 001b.

The Number of Unusable Physical Blocks field *shall* indicate number of physical blocks included in the specified unusable area. When the Unusable Area Type field in CDB is set to 000b, this field is reserved.

17.6.3 Defect Status Data (Type field = 02h)

This command reports Defect Status data to the host that is created by certification on the Restricted Overwrite media. If the mounted media is not a Restricted Overwrite media or if the logical unit does not support certification, this command *shall* be terminated with CHECK CONDITION status, 5/24/00 INVALID FIELD IN CDB.

The Data Type field in CDB *shall* be set to 0.

The Starting LBA field in CDB *shall* indicate the starting point for returning Defect Status data. All Defect Status data *shall* be for logical block addresses equal to this field or greater.

The Maximum Number of Descriptors field *shall* indicate the maximum number of descriptors that the logical unit returns.

The Defect Status data *shall* be formatted as listed in Table 486. The Defect Status data contains a header, followed by zero or more Descriptors. Each Descriptor contains information about an Defect Status such as a Defect Status bitmap on DVD-RW media, see Table 4.20.6.10 - *Format 3 RMD Field 4 to Field 12* on page 238. A Defect Status Descriptor size *shall* be 2 048 bytes.

Table 486 - Defect Status Data

Bit Byte	7	6	5	4	3	2	1	0
0-7	Defect Status Header							
8-n	Defect Status Descriptor(s)							

Each Defect Status Descriptor(s) *shall* be transferred to the host in ascending order of the Starting LBA. If the certified areas are non-contiguous and scattered, the Defect Status Descriptor(s) *shall* be returned by separate descriptors to exclude the void areas.

Table 487 - Defect Status Header

Bit Byte	7	6	5	4	3	2	1	0
0	(MSB)							
1	Defect Status Data Length							
2								
3								
4-7	Reserved							

The Defect Status Data Length field specifies the length in bytes of the following result data. The Defect Status Data Length value does not include the Defect Status Data Length field itself. This value is not modified when the Maximum number of descriptors is insufficient to return all of the Defect Status data available. If there is no Defect Status data on the media, Defect Status Data Length field *shall* be set to 4 and no Defect Status Descriptor *shall* be transferred.

Table 488 - Defect Status Descriptor

Bit Byte	7	6	5	4	3	2	1	0
0	(MSB) Start LBA (LSB)							
1								
2								
3								
4	(MSB) End LBA (LSB)							
5								
6								
7								
8	Blocking Factor							
9	Reserved					First Bit offset		
10	DS #8	DS #7	DS #6	DS #5	DS #4	DS #3	DS #2	DS #1
:	:	:	:	:	:	:	:	:
2 047	DS #16 304	DS #16 303	DS #16 302	DS #16 301	DS #16 300	DS #16 299	DS #16 298	DS #16 297

The **Start LBA** field contains the start Logical Block Address of the certified sector where the following Defect Status (DS #n bits) starts. The returned Logical Block Address *shall* be the first sector of a Block that contains logical blocks specified by the **Blocking Factor** field.

The **End LBA** field contains the end Logical Block Address of the certified sector where the following Defect Status (DS #n bits) ends. The returned Logical Block Address *shall* be the last sector of a Block that contains logical blocks specified by the **Blocking Factor** field.

The **Blocking Factor** field *shall* indicate the number of logical blocks per DS #m bit. In the case of DVD-RW, this field *shall* be set to 16 as an ECC block.

The **First Bit offset** field *shall* indicate the start valid bit number in the byte 10. The lower bits in the byte 10 are invalid. For example, if **First Bit offset** field contains 3, bit 3 of byte 10 has the defect status of the block that contains the Logical block specified **Start LBA** field. From bit 2 to bit 0 are invalid in this case.

DS #n bit contains the certification result of the block #m. When **DS #n** bit is set to 0, indicate that the block has no defect and is able to read and write the block safely. When **DS #n** bit is set to 1, indicates that the block has defect and might not be able to read and write the block safely.

17.6.4 Write Speed (Type field = 03h)

This command reports a list of possible Write Speed descriptors. If recordable media is mounted, logical unit *shall* report the list of speeds that are available for the Blocks of the current mounted medium. If no recordable media is mounted, logical unit *shall* report the most appropriate list of speeds such as the list for CD-R media or just maximum recording speed. Logical unit *shall* report Write Speed descriptors in descending order of the Write Speed value. If the logical unit supports both CLV and CAV on the media, then the logical unit *shall* report all CLV descriptors first. Host should detect a possible Write Speed descriptor by this command, then set the Write Speed via SET STREAMING command. To apply this descriptor to SET STREAMING command, the **Start LBA** field is set to 0, the **Read Time** field and the **Write Time** field are set to 1000 (1sec).

The result data *shall* be formatted as listed in Table 489:

Table 489 - Write Speed Result Data

Bit Byte	7	6	5	4	3	2	1	0
0-7	Write Speed Header							
8-n	Write Speed Descriptor(s)							

Table 490 - Write Speed Header

Bit Byte	7	6	5	4	3	2	1	0
0	Write Speed Data Length							
1								
2								
3								
4 - 7	Reserved							

The Write Speed Data Length field specifies the length in bytes of the following result data. The Write Speed Data Length value does not include the Write Speed Data Length field itself. This value is not modified when the Maximum number of descriptors is insufficient to return all of the Write Speed data available.

Table 491 - Write Speed Descriptor

Bit Byte	7	6	5	4	3	2	1	0
0	Reserved			WRC		RDD	Exact	MRW
1	Reserved							
2	Reserved							
3	Reserved							
4	End LBA							
5								
6								
7								
8	Read Speed							
9								
10								
11								
12	Write Speed							
13								
14								
15								

The Write Rotation Control (WRC) field specifies the type of the medium Rotation Control. See Table 492.

Table 492 - Write Rotation Control values

Write Rotation Control value	Description
00b	Media default rotation control
01b	CAV
Others	Reserved

Media default rotation control is the rotation control defined by the media specification originally. Media default rotation control is as follows:

- CD-R/RW CLV
- DVD-R/-RW CLV
- DVD-RAM ZCLV

If default rotation control is CAV, this field *shall* be set to 0.

RDD bit *shall* be set to 0.

Exact bit of one indicates that the logical unit can perform the recording operation specified by Write Speed Descriptor on the whole media mounted. If the logical unit is uncertain, this bit *shall* set to 0.

The MRW bit indicates that this Write Speed Descriptor is suitable for mixture of read and write (e.g., overwrite mode).

The End LBA field *shall* indicate the medium capacity if a medium is mounted. The value *shall* be same as the value reported by READ CAPACITY command. If no medium is mounted, the logical unit *shall* report the maximum capacity of the most appropriate media.

The Read Speed field *shall* indicate the lowest read performance data of all Blocks in kilobytes per second.

The Write Speed field *shall* indicate the lowest write performance data of all Blocks in kilobytes per second.

Note: The Write Speed (Type field = 03h) format cannot show the difference between 6×CLV and 6×8×ZCLV on DVD-R/+R media. 6×8×ZCLV may be regarded as 8×CLV. The correct write speed profile and read speed profile that are selected are shown by Performance (Type field = 00h) format.

17.6.5 DBI (Type field = 04h)

This command reports a list of Defective Block Information (DBI) data that is a certification result of a medium. To keep compatibility among three DBI memory models described in 10.3.4, "DBI memory management" on page 482, the host *shall* specify the correct logical block address to be read for defect information in the Starting LBA field of GET PERFORMANCE Command Descriptor Block.

If the logical unit supports Enhanced Defect Reporting Feature but this Feature is not current, only DBI data Header *shall* be reported. If logical unit does not support Enhanced Defect Reporting Feature, this command *shall* be terminated with CHECK CONDITION status, 5/24/00 INVALID FIELD IN CDB.

The result data *shall* be formatted as listed in Table 493.

Table 493 - DBI data

Bit	7	6	5	4	3	2	1	0
Byte								
0-7	DBI data Header							
8-n	DBI Descriptor(s)							

Table 494 - DBI data Header

Bit Byte	7	6	5	4	3	2	1	0
0	DBI Data Length							
1								
2								
3								
4 - 7	Reserved							

The DBI Data Length field specifies the length in bytes of the following result data. The DBI Data Length value does not include the DBI Data Length field itself. This value is not modified when the Maximum number of descriptors is insufficient to return all of the DBI data available.

Table 495 - DBI Descriptor

Bit Byte	7	6	5	4	3	2	1	0
0	Start LBA of defective blocks							
1								
2								
3								
4	Number of consecutive defective blocks							
5								
6	Reserved			DBIF	Error Level Type			
7	Reserved							

The Start LBA of defective blocks field indicates the start LBA of defective blocks on the medium. The value *shall* be the packet start LBA that the packet includes the sector specified by the Starting LBA field in CDB.

The Number of consecutive defective blocks field indicates the number of consecutive defective blocks from the LBA specified by the Start LBA of defective blocks field.

The DBI Full (DBIF) bit indicates that incomplete verify operation occurs due to DBI memory full when Simple DBI memory model or small DBI cache memory model is used (see 10.3.4, "DBI memory management" on page 482). If this bit is set to 1, the VERIFY (10) or WRITE AND VERIFY (10) command was terminated at the address calculated from this descriptor before certification completion of specified number of blocks in CDB. The actual terminated address of VERIFY (10) or WRITE AND VERIFY (10) command is "Start LBA of defective blocks" + "Number of consecutive defective blocks" - 1. To continue the verification of the blocks, the host *shall* issue VERIFY (10) command from "Start LBA of defective blocks" + "Number of consecutive defective blocks" address.

If this bit is set to 0, indicates that the VERIFY (10) or WRITE AND VERIFY (10) command is terminated without DBI memory full.

At the beginning of the next VERIFY (10)/WRITE AND VERIFY (10) command or at the medium change, the DBIF bit *shall* be set to 0. By transferring the DBI descriptor of DBIF = 1 or by performing of READ (10)/READ (12) command, this bit *shall not* be cleared.

In the case of small DBI cache memory model, when WDBI cache is updated by the WRITE (10)/WRITE (12) command, the DBIF bit *shall* be set to 0.

Error Level Type field indicates the type of the error level of the defective blocks. See Table 496.

Table 496 - Error Level Type values

Error Level Type value	Error Level Type	Description
0	Type 1	Recovered light defect in specified defective blocks. Data in the blocks can be recovered by error correction.
1	Type 2	Recovered heavy defect in specified defective blocks. Data in the blocks can be recovered by error correction and multiple retry seek/read action.
2	Type 3	Un-recovered read/seek error defect in specified defective blocks.
3	Type 4	Write error occurs in the specified defective blocks. Data had not be written on the sectors.
Others	Others	Reserved

17.6.6 DBI cache zone (Type field = 05h)

The DBI cache zone descriptor provides a way for the host to indicate to the logical unit that the application has specific request for drive behavior of small DBI cache model in DRT-DM mode. Disc volume space is divided into a few DBI cache zones. RDBI and WDBI memory *shall* be allocated for each DBI cache zones. Minimally 2 DBI cache zones *shall* be supported. Number of supported DBI cache zone is shown in Number of DBI cache zones field of Table 384 - *Enhanced Defect Reporting Feature Descriptor* on page 589.

If logical unit does not support 10.3.4.3, "Small DBI cache memory model" on page 482, the logical unit *shall* terminate this command with CHECK CONDITION status, 5/24/00 INVALID FIELD IN CDB. If the logical unit supports both Small DBI cache memory model and Large DBI buffer memory model and if the Large DBI buffer memory model is currently used, the logical unit *shall* report single DBI cache zone that starts from LBA 0 to the end of the medium.

The descriptor data *shall* be formatted as listed in Table 808 - *DBI cache zone Descriptor* on page 892.

Table 497 describes errors that may occur during the operation of the command or which may cause a CHECK CONDITION status to be reported.

Table 497 - GET PERFORMANCE command errors

Error Description	
	A-1.1, "Deferred Error Reporting" on page 919
5/24/00	INVALID FIELD IN CDB

17.7 INQUIRY command

The INQUIRY command requests that information regarding parameters of the logical unit be sent to the host Computer. Options allow the host to request additional information about the logical unit.

Table 498 - INQUIRY Command Descriptor Block

Bit Byte	7	6	5	4	3	2	1	0
0	Operation Code (12h)							
1	LUN (Obsolete)			Reserved			Obsolete	EVPD
2	Page or Operation Code							
3	Allocation Length							
4								
5	Vendor-Specific	Reserved			NACA	Flag	Link	
6	PAD							
7								
8								
9								
10								
11								

The INQUIRY command **shall** return CHECK CONDITION status only when the logical unit cannot return the requested INQUIRY data. The INQUIRY data should be returned even though the peripheral logical unit may not be ready for other commands.

If an INQUIRY command is received with a pending UNIT ATTENTION condition (i.e. before the logical unit reports CHECK CONDITION status), the logical unit **shall** perform the INQUIRY command and **shall not** clear the UNIT ATTENTION condition.

The Enable Vital Product Data (EVPD) bit is optional when the INQ2 bit of the Core Feature (0001h) is set to zero. When set to zero, **shall** indicate that INQUIRY data **shall** be returned as shown in Table 499. When set to one, **shall** indicate that the page identified by the Page or Operation Code field be returned.

The Page or Operation Code field is valid when the EVPD bit is set to one. The Page or Operation Code field **shall** identify the requested INQUIRY Page.

The Allocation Length field **shall** indicate the maximum number of bytes that may be transferred to the host.

Note: The size of this field was one byte length in the previous version of this specification. If the INQ2 bit of the Core Feature (0001h) is set to zero, the logical unit may ignore the most significant byte of this field.

It is recommended that the logical unit should support two byte length of this field regardless of the INQ2 bit setting.

The INQUIRY data should be returned even though the logical unit is not ready for other commands. To minimize delays after a power on or hard reset, the standard INQUIRY data should be available without incurring any media access delays. If the logical unit does store some of the INQUIRY data on the media, it may return zeros or ASCII spaces (20h) in those fields until the data is available from the media.

17.7.1 Standard INQUIRY Data

The standard INQUIRY data contains 36 required bytes, followed by a variable number of vendor-specific parameters. Bytes 58 through 95, if returned, are reserved for future standardization.

Table 499 - INQUIRY Data Format

Bit Byte	7	6	5	4	3	2	1	0
0 SCSI 0 ATAPI	Peripheral Qualifier			Peripheral Device Type				
	Reserved							
1	RMB	Reserved						
2 SCSI 2 ATAPI	ISO Version (0)		ECMA Version (0)			ANSI Version (>0)		
						ANSI Version (0)		
3 SCSI 3 ATAPI	AERC ^b	Obsolete	NormACA	HiSup	Response Data Format			
	ATAPI Transport Version (3)							
4	Additional Length (Number of bytes following this one)							
5	SCCS	ACC ^a	TPGS ^a		3PC ^a	Reserved		Protect ^a
6 SCSI 6 ATAPI	BQue	EncServ	VS	MultiP	MChngr	AckReqQ ^b	Addr32 ^b	Addr16 ^c
	Reserved							
7 SCSI 7 ATAPI	RelAdr ^b	WBus32 ^b	WBus16 ^c	Sync ^c	Linked	TranDis ^b	CmdQue	VS
	Reserved							
8-15	T10 Vendor Identification							
16-31	Product Identification							
32-35	Product Revision Level							
36-55	Vendor-specific							
56	Reserved				Clocking ^c		QAS ^c	IUS ^c
57	Reserved							
58	(MSB) Version Descriptor 1 ^a (LSB)							
59								
:	:							
72	(MSB) Version Descriptor 8 ^a (LSB)							
73								
74-95	Reserved							
96-n	Vendor Specific Parameters							

a. See SPC-3 for the definition.

b. These bits are obsoleted in SPC-3.

c. The meanings of these fields are specific to SPI. For SCSI transport protocols other than the SCSI Parallel Interface, these fields are reserved.

The Peripheral Qualifier value is defined in Table 500.

Table 500 - Peripheral Qualifier definitions

Peripheral Qualifier	Definition
000b	The specified Peripheral Device Type is currently connected to this logical unit. If the logical unit cannot determine whether or not a physical device is currently connected, it also <i>shall</i> use this Peripheral Qualifier when returning the INQUIRY data. This Peripheral Qualifier does not mean that the device is ready for access by the host.
001b	The logical unit is capable of supporting the specified Peripheral Device Type on this logical unit. However, the physical device is not currently connected to this logical unit.
010b	Reserved
011b	The logical unit is not capable of supporting a physical device on this logical unit. For this Peripheral Qualifier the Peripheral Device Type <i>shall</i> be set to 1Fh to provide compatibility with previous versions of SCSI. All other Peripheral Device Type values are reserved for this Peripheral Qualifier.
1xxb	Vendor Specific

The Peripheral Device Type field identifies the device as defined in Table 501. The Peripheral Device Type *shall* be set to 05h to indicate a Multi-Media logical unit.

Table 501 - Peripheral Device Types

Code	Reference	Description
00h	SBC	Direct-access block device (e.g., magnetic disk)
01h	SSC	Sequential-access device (e.g., magnetic tape)
02h	SSC	Printer device
03h	SPC	Processor device
04h	SBC	Write-once device (e.g., some optical disks)
05h	MMC	Multi-Media logical unit (e.g., CD-ROM/-R/-RW, DVD-ROM/-RAM/-R/-RW, DVD+R/+RW, HD DVD-ROM/-R/-RAM, BD-ROM/-R/-RE)
06h	-	Scanner device (obsolete)
07h	SBC	Optical memory device (e.g., some optical disks)
08h	SMC	Medium changer device (e.g., jukebox)
09h	-	Communications device (obsolete)
0Ah-0Bh	-	Obsolete
0Ch	SCC	Storage array controller device (e.g., RAID)
0Dh	SES	Enclosure services device
0Eh	RBC	Simplified direct-access device (e.g., magnetic disk)
0Fh	OCRW	Optical card reader/writer device
10h	BCC	Bridge Controller Commands
11h	OSD	Object-based Storage device
12h	ADC	Automation/Drive Interface
13h - 1Eh	-	Reserved
1Fh	-	Unknown or no logical unit type

A Removable Medium (RMB) bit of zero indicates that the medium is not removable. A RMB bit of one indicates that the medium is removable. Multi-Media read-only logical units should always report “Removable.”

The usage of non-zero code values in the ISO Version and ECMA Version fields are defined by the International Organization for Standardization and ECMA, respectively.

The **ANSI Version** field *shall* contain a non-zero value to comply with this version of the Specification for a SCSI logical unit or zero for an ATAPI logical unit.

The **ATAPI Transport Version** field *shall* contain 03h to comply with this version of the Specification. This field indicates the version of the ATAPI Transport that is being used. For more information on the transport, see the INCITS T13/1153D standard. For a SCSI logical unit this field is defined by the SCSI SPC-2 standard.

The asynchronous event reporting capability (**AERC^b**) bit indicates that the logical unit supports the asynchronous event reporting capability as defined in SAM-2. The **AERC^b** bit is qualified by the **Peripheral Device Type** field as follows:

1. Processor device-type definition: An **AERC^b** bit of one indicates that the processor device is capable of accepting asynchronous event reports. An **AERC^b** bit of zero indicates that the processor device does not support asynchronous event reports; or
2. All other device-types: This bit is reserved.

Details of the asynchronous event reporting support are protocol-specific.

The **Normal ACA Supported (NormACA)** bit of one indicates that the logical unit supports setting the **NACA** bit to one in the Control Byte of the CDB (as defined in SAM-2). A **NormACA** bit of zero indicates that the logical unit does not support setting the **NACA** bit to one.

A hierarchical support (**HiSup**) bit of zero indicates the logical unit does not use the hierarchical addressing model to assign LUNs to logical units. A **HiSup** bit of one indicates the logical unit uses the hierarchical addressing model to assign LUNs to logical units. When the **HiSup** bit is one, the logical unit *shall* support the **REPORT LUNS** command (see SPC-2).

A **Response Data Format** value of 02h indicates that the data *shall* be in the format specified in this Specification. **Response Data Format** values less than two are obsolete. **Response Data Format** values greater than two are reserved.

The **Additional Length** field *shall* specify the length in bytes of the parameters. If the allocation length of the Command Packet is too small to transfer all of the parameters, the **Additional Length** *shall not* be adjusted to reflect the truncation.

An **SCC Supported (SCCS)** bit of one indicates that the device contains an embedded storage array controller component. See SCC-2 for details about storage array controller devices. An **SCCS** bit of zero indicates that the device does not contain an embedded storage array controller component.

Note: The embedded changer model is not the one presented in this document.

The basic queuing (**BQue**) bit *shall* be zero if the **CmdQue** bit is one. When the **CmdQue** bit is zero, the **BQue** bit *shall* have the following meaning. A **BQue** bit of zero indicates that the device does not support tagged tasks (command queuing) for this logical unit. A value of one indicates that the device supports, for this logical unit, the basic task management model defined by SAM-2.

An **Enclosure Services (EncServ)** bit of one indicates that the device contains an embedded enclosure services component. See SES for details about enclosure services, including a device model for an embedded enclosure services device. An **EncServ** bit of zero indicates that the device does not contain an embedded enclosure services component.

A **Multi Port (MultiP)** bit of one *shall* indicate that this is a multi-port (2 or more ports) device and conforms to the SCSI-3 multi-port device requirements found in the applicable standards. A value of zero indicates that this device has a single port and does not implement the multi-port requirements.

A **medium changer (MChngr)** bit of one indicates that the device is embedded within or attached to a medium transport element. See SMC for details about medium changers, including a device model for an attached medium changer device. The **MChngr** bit is valid only when the **RMB** bit is equal to one. A **MChngr** bit of zero indicates that the device is not embedded within or attached to a medium transport element.

Note: The MChngr bit is unrelated to the changer model described in this specification.

A relative addressing (**RelAdr^b**) bit of one indicates that the logical unit supports the relative addressing mode. If this bit is set to one, the linked command (**Linked**) bit *shall* also be set to one; since relative addressing is only allowed with linked commands. A **RelAdr^b** bit of zero indicates the logical unit does not support relative addressing.

A linked command (**Linked**) bit of one indicates that the logical unit supports linked commands (see SAM-2). A value of zero indicates the logical unit does not support linked commands.

A command queuing (**CmdQue**) bit of one indicates that the device supports tagged tasks (command queuing) for this logical unit (see SAM-2). A value of zero indicates the logical unit may support tagged tasks for this logical unit (see the **BQue** bit, above). Table 502 summarizes the relationship of the **BQue** and **CmdQue** bits.

Table 502 - Relationship of BQue and CmdQue bits

BQue	CmdQue	Description
0	0	No command queuing of any kind supported.
0	1	Command queuing with all types of task tags supported.
1	0	Basic task set model supported (see SAM-2)
1	1	Illegal combination of BQue and CmdQue bits.

ASCII data fields *shall* contain only graphic codes (i.e. code values 20h through 7Eh). Left-aligned fields *shall* place any unused bytes at the end of the field (highest offset) and the unused bytes *shall* be filled with space characters (20h). Right-aligned fields *shall* place any unused bytes at the start of the field (lowest offset) and the unused bytes *shall* be filled with space characters (20h).

The T10 Vendor Identification field contains 8 bytes of ASCII data identifying the vendor of the product¹. The data *shall* be left aligned within this field.

The Product Identification field contains 16 bytes of ASCII data as defined by the vendor. The data *shall* be left-aligned within this field.

The Product Revision Level field contains 4 bytes of ASCII data as defined by the vendor. The data *shall* be left-aligned within this field.

17.7.2 Using the INQUIRY command

The INQUIRY command may be used by a host to determine the configuration of the logical unit. Logical units respond with information that includes their type and Specification level and may include the vendor's identification, model number and other useful information.

Table 503 describes errors that may occur during the operation of the command or which may cause a CHECK CONDITION status to be reported.

Table 503 - INQUIRY command errors

Error Description	
5/24/00	INVALID FIELD IN CDB

1. It is intended that this field provide a unique vendor identification of the manufacturer of the logical unit. In the absence of a formal registration procedure, INCITS T10 maintains a list of vendor identification codes in use. Vendors are requested to voluntarily submit their identification codes to INCITS T10 to prevent duplication of codes.

17.8 LOAD/UNLOAD MEDIUM command

The LOAD/UNLOAD MEDIUM command requests that the logical unit changer load or unload a Disc. New LOAD/UNLOAD MEDIUM commands issued before the changer posts a state of READY, will cause the changer to abort the LOAD/UNLOAD MEDIUM command in progress and begin processing the new LOAD/UNLOAD MEDIUM command.

Table 504 - LOAD/UNLOAD MEDIUM Command Descriptor Block

Bit Byte	7	6	5	4	3	2	1	0
0	Operation Code (A6h)							
1	LUN (Obsolete)			Reserved				Immed
2	Reserved							
3	Reserved							
4	Reserved						LoUnlo	Start
5	Reserved							
6	Reserved							
7	Reserved							
8	Slot							
9	Reserved							
10	Reserved							
11	Vendor-Specific		Reserved			NACA	Flag	Link

An immediate (Immed) bit of one indicates that the logical unit *shall* return status as soon as the command Descriptor Block has been validated. An Immed bit of zero indicates that the status *shall not* be returned until the operation has been completed.

A Start bit of one requests the logical unit be made ready for use. A Start bit of zero requests that the logical unit be stopped (media cannot be accessed by the host).

Table 505 - Load/Unload or Optional Selection Operations

LoUnlo	Start	Operation to be Performed
0	0	Abort any Prior Changer command (Stop)
0	1	Reserved
1	0	Unload media. The Slot Parameter is ignored for this operation.
1	1	Either Move the Disc in the selected Slot to the play position or select the Slot specified for use with future Media Access commands

The Slot field indicates the Slot to be loaded. Changers compatible with the Bootable CD specification should always initialize (Load) Slot 0 on Power On or Hard Reset.

Any attempt to Load or Unload a Disc when the logical unit does not support that capability *shall* result in CHECK CONDITION status, 5/24/00 INVALID FIELD IN CDB.

Loading when the slot does not contain a Disc will be rejected with CHECK CONDITION status, 2/3A/00 MEDIUM NOT PRESENT. When this error is returned there are two possible actions by the logical unit. If the logical unit reports Software Slot Selection (SSS) = 1, then the slot specified *shall* be selected for use. The SSS bit is defined in 17.11.3.6, "C/DVD Capabilities and Mechanical Status mode page" on page 686. If the logical unit reports SSS = 0 then the previously used slot *shall* continue to be selected for use.

If the logical unit is capable of caching data then a delayed load of a disc into the playing position can be supported.

If delayed loading of a disc into the playing position is supported, the logical unit *shall* have previously cached the Lead-in data from that disc. If the medium is DVD then the caching of the Lead-in information *shall* be performed. If the medium is CD then the caching of the TOC *shall* be performed. If the logical unit has not read the Lead-in for a disc that is being loaded into the playing position, then delayed loading *shall not* be performed and the disc *shall* be loaded into the playing position immediately. If the loading of the Disc into the playing position is delayed, then the logical unit *shall* report that the Disc is ready, even though the Disc is not spinning and installed in the playing position. In all cases the behavior seen by the host (other than a longer subsequent media access latency) *shall not* be different between delayed and immediate loading of a disc.

A UNIT ATTENTION condition *shall not* be generated for the host issuing the LOAD/UNLOAD MEDIUM command when discs are loaded or unloaded from the playing position.

Unloading when the Play Position does not contain a Disc will be rejected CHECK CONDITION status, 5/24/00 INVALID FIELD IN CDB for the Slot Byte.

Table 506 describes errors that may occur during the operation of the command or which may cause a CHECK CONDITION status to be reported.

Table 506 - LOAD/UNLOAD MEDIUM command errors

Error Description	
	<i>A-1.1, "Deferred Error Reporting" on page 919</i>
	<i>Table 835 - Basic Error Codes on page 932</i>
4/3B/16	MECHANICAL POSITIONING OR CHANGER ERROR
4/53/00	MEDIA LOAD OR EJECT FAILED

17.9 MECHANISM STATUS command

The MECHANISM STATUS command requests that the respond with the current status of the logical unit, including any Changer Mechanism that adheres to this specification. This command is intended to provide information to the host about the current operational state of the logical unit. The logical units take operational direction from both the host and the user (Person). Movement of media in/out of the logical unit may be due to external conditions beyond the control of the host. This command has been provided to allow the host to know what as transpired at the user level.

Table 507 - MECHANISM STATUS Command Descriptor Block

Bit Byte	7	6	5	4	3	2	1	0
0	Operation Code (BDh)							
1	LUN (Obsolete)			Reserved				
2	Reserved							
3	Reserved							
4	Reserved							
5	Reserved							
6	Reserved							
7	Reserved							
8	(MSB) Allocation Length (LSB)							
9								
10	Reserved							
11	Vendor-Specific		Reserved			NACA	Flag	Link

The Allocation Length field specifies the maximum length in bytes of the Returned Data that *shall* be transferred from the logical unit to the host. An Allocation Length of zero indicates that no data *shall* be transferred. This condition *shall not* be considered as an error.

The Mechanism Status Parameter List contains a header, followed by zero or more fixed-length Slot Tables. If the logical unit does not support the Embedded Changer Feature, then the number of slot tables returned to the host *shall* be zero. The number of slot tables returned *shall* be same as reported in the Number of Slots Available (Byte 5 of the Mechanism Status Header) field.

Table 508 - Mechanism Status Parameter List

Bit Byte	7	6	5	4	3	2	1	0
0-7	Mechanism Status Header							
8-n	Slot Table(s)							

Each Slot Table contains the a slot number and status information.

Table 509 - Mechanism Status Header

Bit Byte	7	6	5	4	3	2	1	0
0	Fault	Changer State		Current Slot				
1	C/DVD Mechanism State			DoorOpen	Reserved			
2	(MSB) Current LBA (LSB)							
3								
4								
5								
6	(MSB) Length of Slot Table(s) (LSB)							
7								

- Bit 0-4, Current Slot This field indicates the current Changer Slot selected. Changers compatible with a Bootable CD specification/standard, should always initialize (Load) Slot 0 on Power On or Hard Reset. This value *shall* only be changed when a LOAD/UNLOAD MEDIUM command is processed. Operations initiated by a user *shall not* cause this value to change. If the logical unit is not a changer, then this field is reserved.
- Bit 5-6, Changer State This field indicates the current state of the logical unit.
- | | |
|----|--------------------|
| 0h | Ready |
| 1h | Load in Progress |
| 2h | Unload in Progress |
| 3h | Initializing |
- Bit 7, Fault This bit indicates that the changer failed to complete the operation reported in the Changer State field. If the logical unit is not a changer, then this bit is reserved.
- Bit 4, DoorOpen This bit indicates that the Door(s) or Tray(s) is open or the Magazine is not present.
- Bit 7-5, C/DVD Mechanism State This field encodes the current operation of the logical unit.
- | | |
|------|--|
| 0h | Idle |
| 1h | Active with Audio Port in use (i.e. Playing, Paused) |
| 2h | Scan in progress |
| 3h | Active with host, Composite or Other Ports in use (i.e. READ, SCAN during a PLAY CD). ¹ |
| 4-6h | Reserved |
| 7h | No State Information Available |

The Current LBA value returns the location that was last used while reading or playing. Once a Read or Play operation has been completed the value of this field may be undefined. While a Read or Play is in progress this field will contain the LBA of the current block being processed.

The Number of Slots Available field *shall* return the number of logical Slots that the logical unit supports and *shall* be a maximum of 32.

The Length of Slot Table(s) field specifies the length in bytes of the all the slot information that follows (e.g., for a 2 slot logical unit this value would be 8).

1. MMC does not make use of this value.

Table 510 - Slot Table Response format

Bit Byte	7	6	5	4	3	2	1	0
0	Disc Present	Reserved						Change
1	Reserved						CWP_V	CWP
2	Reserved							
3	Reserved							

Bit 0, Change (mandatory)

Change indicates that the Disc in that slot has been changed since the last time the Disc was loaded.

Bit 7, Disc Present (Optional)

This bit reports the presence of a Disc in a Slot, or if the Disc for a given Slot is in the Playing Position. A value of 1 indicates the Disc is present, and 0 indicates that it is not.

SDP=0

Changer logical units may not support the capability of reporting the presence of a Disc in each of the slots after reset or a Magazine change. In this case the logical unit **shall** report this in the Embedded Changer Feature (See 17.4.2.42, "Feature 0102h: Embedded Changer" on page 614 "Supports Disc Present Reporting bit (SDP)"). In this case the logical unit **shall** report that ALL Discs are present, until the logical unit can determine that there is no Disc present (i.e. when a LOAD/UNLOAD MEDIUM command is processed for an empty slot).

SDP=1

If the Changer logical unit does support the reporting of the Disc Present then this bit **shall** be valid for all slots. It is not acceptable for the logical unit to actually load and unload each slot to compute this information.

CWP_V, if set to one, indicates that the Media Cartridge Write Protection (CWP) of the Cartridge in that slot has been checked and CWP bit is valid. If set to 0, the CWP bit is invalid.

CWP, if set to 1, indicates that the CWP status is active on the Cartridge. If CWP_V is set to 0, CWP bit is invalid and **shall** be set to 0.

Table 511 describes errors that may occur during the operation of the command or which may cause a CHECK CONDITION status to be reported.

Table 511 - MECHANISM STATUS command errors

Error Description
A-1.1, "Deferred Error Reporting" on page 919
Table 835 - Basic Error Codes on page 932

17.10 MODE SELECT (10) command

The MODE SELECT (10) command provides a means for the host to specify medium or logical unit parameters to the logical unit. Hosts should issue a MODE SENSE (10) command prior to each MODE SELECT (10) command to determine supported Pages, Page Lengths, and other parameters.

Table 512 - MODE SELECT (10) Command Descriptor Block

Bit Byte	7	6	5	4	3	2	1	0
0	Operation Code (55h)							
1	LUN (Obsolete)			PF (1)	Reserved			SP
2	Reserved							
3	Reserved							
4	Reserved							
5	Reserved							
6	Reserved							
7	(MSB) Parameter List Length (LSB)							
8								
9	Vendor-Specific	Reserved			NACA	Flag	Link	
10	PAD							
11								

A Save Pages (SP) bit of zero indicates the logical unit *shall* perform the specified MODE SELECT (10) operation, and *shall not* save any Pages. An SP bit of one indicates that the logical unit *shall* perform the specified MODE SELECT (10) operation, and *shall* save to a non-volatile vendor-specific location all the savable Pages. If a logical unit supports saved Pages, it *shall* save only one copy of the Page. The SP bit is optional, even when mode pages are supported by the logical unit. Pages that are saved are identified by the parameter savable (PS) bit that is returned in the Page Header by the MODE SENSE (10) command. If the PS bit is set in the MODE SENSE (10) data then the Page *shall* be savable by issuing a MODE SELECT (10) command with the SP bit set. If the logical unit does not implement saved Pages and the SP bit is set to one, the command *shall* be terminated with CHECK CONDITION status, 5/24/00 INVALID FIELD IN CDB.

The Parameter List Length field specifies the maximum length in bytes of the mode parameter list that *shall* be transferred from the host to the logical unit after the Command Packet is transferred. A Parameter List Length of zero indicates that no data *shall* be transferred. This condition *shall not* be considered as an error.

If the Parameter List Length results in the truncation of any mode parameter header or mode page, the logical unit *shall* terminate the command with CHECK CONDITION status, 5/1A/00 PARAMETER LIST LENGTH ERROR.

The mode parameter list for the MODE SELECT (10) and MODE SENSE (10) commands is defined in 17.11.3, "Mode Select/Sense Parameters" on page 671.

The logical unit *shall* terminate the MODE SELECT (10) command with CHECK CONDITION status, 5/26/00 INVALID FIELD IN PARAMETER LIST, and *shall not* change any mode parameters for the following conditions:

1. If the host sets any field (except for reserved fields) that is reported as not changeable by the logical unit to a value other than its current value.
2. If the host sets any unreserved field in the mode parameter header to an unsupported value.
3. If a host sends a mode page with a Page Length not equal to the Page Length returned by the MODE SENSE (10) command for that Page.
4. If the host sends an unsupported value for a mode parameter and rounding is not implemented for that mode parameter.

If the host sends a value for a mode parameter that is outside the range supported by the logical unit and rounding is implemented for that mode parameter, the logical unit may either:

1. round the parameter to an acceptable value and terminate the command with CHECK CONDITION status, 1/37/00 ROUNDED PARAMETER;
2. terminate the command with CHECK CONDITION status, 5/26/00 INVALID FIELD IN PARAMETER LIST.

A logical unit may alter any mode parameter in any mode page (even those reported as non-changeable) as a result of changes to other mode parameters¹.

The logical unit validates the non-changeable mode parameters against the current values that existed for those mode parameters prior to the MODE SELECT (10) command.

Mode pages are maintained per logical unit. The Pages are thus used for multiple media insertions/removals. In the case of a Changer Mechanism all the media in the changer make use of the same mode pages. Changing of media **shall not** cause a CHECK CONDITION status, 6/2A/01 MODE PARAMETERS CHANGED, nor **shall** any Mode Parameter change.

Table 513 describes errors that may occur during the operation of the command or which may cause a CHECK CONDITION status to be reported.

Table 513 - MODE SELECT (10) command errors

Error Description	
	<i>A-1.1, "Deferred Error Reporting" on page 919</i>
	<i>Table 835 - Basic Error Codes on page 932</i>
5/39/00	SAVING PARAMETERS NOT SUPPORTED

1. If the current values calculated by the logical unit affect the host's operation, the host **shall** issue a MODE SENSE (10) command after each MODE SELECT (10) command.

17.11 MODE SENSE (10) command

The MODE SENSE (10) command provides a means for a logical unit to report parameters to the host. It is a complementary command to the MODE SELECT (10) command.

Table 514 - MODE SENSE (10) Command Descriptor Block

Bit Byte	7	6	5	4	3	2	1	0
0	Operation Code (5Ah)							
1	LUN (Obsolete)			LLBAA	DBD	Reserved		
2	PC		Page Code					
3	Subpage Code							
4	Reserved							
5	Reserved							
6	Reserved							
7	(MSB) Allocation Length (LSB)							
8								
9	Vendor-Specific		Reserved			NACA	Flag	Link
10	PAD							
11								

The Long LBA Accepted (LLBAA) bit is not utilized by Multi-Media logical units. See SPC-3 for the definition.

Note: The LLBAA field should be set to zero. The logical unit may ignore this field.

The Disable Block Descriptor (DBD), when set to zero, **shall** specify that a Block Descriptor may be returned. When set to one, it **shall** specify that the Block Descriptor **shall not** be returned. This bit **shall** be set to one for an ATAPI logical unit. For a SCSI logical unit this bit may be set to zero only in a legacy environment.

The Subpage Code field is not utilized by Multi-Media logical units. See SPC-3 for the definition.

Note: The Subpage Code field should be set to zero. The logical unit may ignore this field.

17.11.1 Page Control

The Page Control (PC) field defines the type of mode parameter values to be returned in the mode pages. See Table 515 and 17.11.1.1 - 17.11.1.4.

Table 515 - Page Control (PC) field

Code	Type of Parameter	Section
00b	Current values	17.11.1.1
01b	Changeable values	17.11.1.2
10b	Default values	17.11.1.3
11b	Saved values	17.11.1.4

*Note: The PC field only affects the mode parameters within the mode pages, however the PS bit, Page Code and Page Length fields **shall** return current values since they have no meaning when used with other types. The mode parameter header **shall** return current values. (see also 17.11.3, "Mode Select/Sense Parameters" on page 671)*

The Page Code specifies which mode page(s) to return¹. See Table 520 - Mode page codes on page 672 for a description of the mode pages.

A host may request any one or all of the supported mode pages from a logical unit. If a host issues a MODE SENSE (10) command with a Page Code value not implemented by the logical unit, the logical unit *shall* return CHECK CONDITION status, 5/24/00 INVALID FIELD IN CDB.

A Page Code of 3Fh indicates that all mode pages implemented by the logical unit *shall* be returned to the host. If the mode parameter list exceeds 65 534 bytes for ATAPI or 65 535 for SCSI in a MODE SENSE (10) command, the logical unit *shall* return CHECK CONDITION status, 5/24/00 INVALID FIELD IN CDB.

Mode page 00h, if implemented, *shall* be returned after all other mode pages.

17.11.1.1 Current Values

A PC field value of 0h requests that the logical unit return the current values of the mode parameters. The current values returned are:

1. the current values of the mode parameters established by last successful MODE SELECT (10) command.
2. the saved values of the mode parameters if a MODE SELECT (10) command has not successfully completed since the last power-on, hard RESET condition.
3. the default values of the mode parameters, if saved values, are not available or not supported.

17.11.1.2 Changeable Values

A PC field value of 1h requests that the logical unit return a mask denoting those mode parameters that are changeable. In the mask, the fields of the mode parameters that are changeable *shall* be set to all one bits and the fields of the mode parameters that are non-changeable (i.e. defined by the logical unit) *shall* be set to all zero bits.

An attempt to change a non-changeable mode parameter (via MODE SELECT (10)) results in an error condition.

The host should issue a MODE SENSE (10) command with the PC field set to 1h and the Page Code field set to 3Fh to determine which mode pages are supported, which mode parameters within the mode pages are changeable, and the supported length of each mode page prior to issuing any MODE SELECT (10) commands.

17.11.1.3 Default Values

A PC field value of 2h requests that the logical unit return the default values of the mode parameters. Parameters not supported by the logical unit *shall* be set to zero. Default values are accessible even if the logical unit is NOT READY condition.

17.11.1.4 Saved Values

A PC field value of 3h requests that the logical unit return the saved values of the mode parameters. Implementation of saved Page parameters is optional. Mode parameters not supported by the logical unit *shall* be set to zero. If saved values are not implemented, the command *shall* be terminated with CHECK CONDITION status, 5/39/00 SAVING PARAMETERS NOT SUPPORTED.

The method of saving parameters is vendor-specific. The parameters are preserved in such a manner that they are retained when the logical unit is powered down. All savable Pages can be considered saved when a MODE SELECT (10) command issued with the SP bit set to one has returned a “good” status.

Note: As Multi-Media logical units do not have writable media and the media is removable, most will not support Saved Values. It is recommended that the host software not make use of saved Pages.

-
1. Mode pages *shall* be returned in ascending Page Code order except for mode page 00h.

17.11.2 Initial Responses

After a power-up condition or hard reset condition or for ATAPI the DEVICE RESET, the logical unit *shall* respond in the following manner:

1. If default values are requested, report the default values.
2. If saved values are requested, report valid restored mode parameters, or restore the mode parameters and report them. If the saved values of the mode parameters are not able to be accessed from the non-volatile, vendor-specific location, terminate the command with 5/39/00 SAVING PARAMETERS NOT SUPPORTED. If saved parameters are not implemented, respond as defined in 17.11.1.4.
3. If current values are requested and the current values of the mode parameters have not been sent by the host (via a MODE SELECT (10) command), the logical unit may return either the default or saved values as defined above. If current values have been sent, the current values *shall* be reported.

Table 513 describes errors that may occur during the operation of the command or which may cause a CHECK CONDITION status to be reported.

Table 516 - MODE SENSE (10) command errors

Error Description	
	<i>A-1.1, "Deferred Error Reporting" on page 919</i>
	<i>Table 835 - Basic Error Codes on page 932</i>
5/39/00	SAVING PARAMETERS NOT SUPPORTED

17.11.3 Mode Select/Sense Parameters

This section describes the Pages used with MODE SELECT (10) and MODE SENSE (10) commands.

The Mode Parameter List contains a header, followed by zero or more variable-length mode pages.

Table 517 - Mode Parameter List

Bit Byte	7	6	5	4	3	2	1	0
0-7 ^a	Mode Parameter Header							
0-m	Mode Page(s)							

- a. In the case of MODE SENSE (6) / SELECT (6) commands, Mode Parameter Header length is different. These commands are not specified by this specification.

Mode Parameter Header and generic mode page format are defined as shown in Table 518 and Table 519.

Table 518 - Mode Parameter Header

Bit Byte	7	6	5	4	3	2	1	0
0	(MSB) Mode Data Length (LSB)							
1								
2	Obsolete (Medium Type Code)							
3-5	Reserved							
6	(MSB) Block Descriptor Length 0 (8 for legacy SCSI logical units) (LSB)							
7								

Table 519 - Mode page format

Bit Byte	7	6	5	4	3	2	1	0
0	PS / Reserved	Reserved	Page Code					
1	Page Length (n-1)							
2-n	Mode Parameters							

Each mode page contains a Page Code, a Page Length, and a set of Mode Parameters.

Table 520 - Mode page codes

Page Code	Page Description	Section
00h	Vendor-specific (does not require Page Format)	
01h	Read-Write Error Recovery	17.11.3.1
02h	Reserved	
03h	MRW	See MMC
04h	Reserved	
05h	Write Parameters	17.11.3.7
06h-07h	Reserved	
08h	Caching	See MMC
09h-0Dh	Reserved	
0Eh	CD Audio Control	17.11.3.2
0Fh-19h	Reserved	
1Ah	Power Condition	17.11.3.3
1Bh	Reserved	
1Ch	Informational Exceptions Control	17.11.3.4
1Dh	Timeout and Protect	17.11.3.5
1Eh-1Fh	Reserved	
20h-29h	Vendor-specific (Page Format required)	
2Ah	C/DVD Capabilities and Mechanical Status	17.11.3.6
2Bh-3Eh	Vendor-specific (Page Format required)	
3Fh	Return all Pages (valid only for the MODE SENSE (10) command)	

When using the MODE SENSE (10) command, a Parameters Savable (PS) bit of one *shall* indicate that the mode page can be saved by the logical unit in a non-volatile, vendor-specific location. A PS bit of zero *shall* indicate that the supported parameters cannot be saved. When using the MODE SELECT (10) command, the PS bit is reserved.

The Page Code field identifies the format and parameters defined for that mode page.

When using the MODE SENSE (10) command, if Page Code 00h (vendor-specific Page) is implemented, the logical unit *shall* return that Page last in response to a request to return all Pages (Page Code 3Fh). When using the MODE SELECT (10) command, this Page *shall* be sent last.

The Page Length field specifies the length in bytes of the mode parameters that follow. If the host does not set this value to the value that is returned for the Page by the MODE SENSE (10) command, the logical unit *shall* terminate the command with CHECK CONDITION status, 5/26/00 INVALID FIELD IN PARAMETER LIST. The logical unit is permitted to implement a mode page that is less than the full Page Length defined in this specification, provided no field is truncated and the Page Length field correctly specifies the actual length implemented.

The mode parameters for each Page are defined here. Mode parameters not implemented by the logical unit *shall* be set to zero.

When using the MODE SENSE (10) command, the Mode Data Length field specifies the length in bytes of the following data that is available to be transferred. The Mode Data Length is the total byte count of all data following the Mode Data Length field. When using the MODE SELECT (10) command, this field is reserved.

The block descriptor associated with the MODE SELECT (10) and MODE SENSE (10) commands is used for legacy system support for SCSI systems. If supported, block sizes (see Table 521) *shall* include 2 048 for CD/DVD/HD DVD media and may include 512, 2 056, 2 324, 2 332, 2 336, 2 340, 2 352, 2 368, and 2 448 bytes. Table 521 shows the implementation of the various block sizes. These definitions apply for reading with the Read commands. Other block sizes are allowed and the contents of those blocks are not specified by this specification.

Table 521 - Block Descriptor Block Sizes for Read

Size	Readable block types
512	Mode 1 or Mode 2 Form 1 sectors divided into four blocks each.
2 048	Mode 1, Mode 2 Form 1, or DVD/HD DVD
2 056	Mode 2 Form 1 with sub-header. Equivalent to READ CD, Flag = 50h.
2 324	Mode 2 Form 2 with no sub-header. Note: There is no mapping to READ CD, as the 4 spare bytes are not returned.
2 332	Mode 2, form 1 or 2 data. The drive <i>shall</i> operate as specified for 2 048 byte blocks except: Both forms send 2 332 byte blocks. Form 1 blocks return the third layer ECC with the user data. Note: There is no mapping to READ CD, as the 4 spare bytes are not returned.
2 336	Mode 2 data The drive <i>shall</i> operate as specified for 2 048 byte blocks lengths. This mode will include all data, including Yellow Book Mode 2 sectors and Form 1 and Form 2. Equivalent to READ CD, Flag = 58h.
2 340	All bytes except the synchronization field. Equivalent to READ CD, Flag = 78h.
2 352	Audio or raw blocks. The drive <i>shall</i> operate as specified for 2 048 byte blocks. Reads of data mode sectors <i>shall</i> return descrambled data. Equivalent to READ CD, Flag = F8h.
2 448 or 2 368	Audio or raw blocks with raw sub-channel. The drive <i>shall not</i> perform the data descrambling operation. Equivalent to READ CD, Flag = F8, Sub-channel data selection = 010b (2 448) or Sub-channel data selection = 001b (2 368).

17.11.3.1 Read-Write Error Recovery mode page

The Read-Write Error Recovery mode page specifies the error recovery parameters the logical unit *shall* use during any command that performs a data read or write operation from or to the media (e.g., READ (10), READ TOC/PMA/ATIP, WRITE (10)).

Table 522 - Read-Write Error Recovery mode page format

Bit Byte	7	6	5	4	3	2	1	0
0	PS	Reserved	Page Code (01h)					
1	Page Length (0Ah)							
2	Error Recovery Parameter, Default 0							
	AWRE	ARRE	TB	RC	Reserved	PER	DTE	DCR
3	Read Retry Count							
4	Correction Span							
5	Head Offset count							
6	Data Strobe Offset Count							
7	Reserved						EMCDR	
8	Write Retry Count							
9	Reserved							
10	(MSB)							
11	Recovery Time Limit (LSB)							

The Parameters Savable (PS) bit is only used with the MODE SENSE (10) command. This bit is reserved with the MODE SELECT (10) command. A PS bit of one indicates that the logical unit is capable of saving the Page in a non-volatile vendor-specific location.

Note: The implementation of error recovery procedures for Multi-Media logical units is markedly different from those used for magnetic medium disk drives. At least one level of error correction is required to transfer the data stream. Therefore, the performance of the logical unit may differ substantially from what would be expected by sending the same error recovery parameters to a magnetic medium logical unit.

An automatic write reallocation enabled (AWRE) bit of one indicates that the logical unit *shall* enable automatic reallocation to be performed during write operations. An AWRE bit of zero indicates that the logical unit *shall not* perform automatic reallocation of defective data blocks during write operations.

An automatic read reallocation enabled (ARRE) bit of one indicates that the logical unit *shall* enable automatic reallocation of defective data blocks during read operation. An ARRE bit of zero indicates that the logical unit *shall not* perform automatic reallocation of defective data blocks during read operation. When ARRE is enabled other error recovery modes *shall not* be used. The Disable Correction (DCR) and Read Continuous (RC) *shall not* be enabled while ARRE is enabled.

A Transfer Block (TB) bit of one indicates that a data block that is not recovered within the recovery limits specified, *shall* be transferred to the host before CHECK CONDITION status is returned. A TB bit of zero indicates that such a data block *shall not* be transferred to the host. The TB bit does not affect the action taken for recovered data.

A Read Continuous (RC) bit of one indicates that the logical unit *shall* transfer the entire requested length of data without adding delays to perform error recovery procedures. This implies that the logical unit may send data that is erroneous or fabricated in order to maintain a continuous flow of data. A RC bit of zero indicates that error recovery operations that cause delays are acceptable during the data transfer.

A Post Error (PER) bit controls recovered error reporting of logical unit. This bit is used in conjunction with the EMCDR field if logical unit supports Enhanced Defect Reporting Feature. The description of this bit is described in 17.11.3.1.1, "Description of PER bit and EMCDR field" on page 678.

A Disable Transfer on Error (DTE) bit of one indicates that the logical unit *shall* terminate the data transfer to the host upon detection of a recovered error. A DTE bit of zero indicates that the logical unit *shall not* terminate the data transfer upon detection of a recovered error.

A Disable Correction (DCR) bit of one indicates that error correction codes *shall not* be used for data error recovery. A DCR bit of zero allows the use of error correction codes for data error recovery.

As an example, interpretation of the bits 5-0 in the Error Recovery Parameter byte for CD-ROM logical units and DVD/HD DVD logical units are given in Table 523 and Table 524.

Table 523 - Error Recovery Descriptions (CD media)

Code	Error Recovery Description
00h	The maximum error recovery procedures available are used. If an error occurs which is uncorrectable with the error correction codes (ECC) on the media, data transfer is terminated with CHECK CONDITION status. The block with the error is not transferred. The sense key is set to MEDIUM ERROR. The information bytes give the address of the block where the unrecovered error was detected. Recovered errors are not reported.
01h	Only retries of the read operation and CIRC are used (layered error correction is not used). Only CIRC unrecovered data errors are reported. If a CIRC unrecovered data error occurs, data transfer is terminated with CHECK CONDITION status. The block with the error is not transferred. The sense key is set to MEDIUM ERROR. The information bytes give the address of the block where the unrecovered error was detected. Recovered errors are not reported.
04h	The maximum error recovery procedures available are used. Recovered data errors are reported. If a recovered data error occurs, data transfer is not terminated. However, when the data transfer has completed CHECK CONDITION status is reported. The sense key is set to RECOVERED ERROR. The information bytes give the address of the last block where a recovered data error was detected. If a data error occurs that is uncorrectable with the ECC information available on the media, data transfer is terminated and CHECK CONDITION status is reported. The block with the error is not transferred. The sense key is set to MEDIUM ERROR. The information bytes give the address of the block where the uncorrectable error was detected.
05h	Only retries of the read operation and CIRC are used (layered error correction is not used). Recovered data errors are reported. If a recovered data error occurs, data transfer is not terminated. However, when the data transfer has completed CHECK CONDITION status is reported. The sense key is set to RECOVERED ERROR. The information bytes give the address of the last block where a CIRC recovered data error was detected. If an unrecovered data error occurs, data transfer is terminated and CHECK CONDITION status is reported. The block with the error is not transferred. The sense key is set to MEDIUM ERROR. The information bytes give the address of the block where the unrecovered error was detected.
06h	The maximum error recovery procedures are used. Recovered data errors are reported. If a recovered data error occurs data transfer is terminated and CHECK CONDITION status is reported. The block with the recovered error is not transferred. The sense key is set to RECOVERED ERROR. The information bytes give the address of the block where the recovered data error was detected. If a data error occurs that is uncorrectable with the ECC information on the medium, data transfer is terminated with CHECK CONDITION status. The block with the error is not transferred. The sense key is set to MEDIUM ERROR. The information bytes give the address of the block where the uncorrectable error was detected.
07h	Only retries of the read operation are used (layered error correction is not used) and CIRC recovered data errors are reported. If a CIRC recovered data error occurs, data transfer is terminated with CHECK CONDITION status. The block with the recovered error is not transferred. The sense key is set to RECOVERED ERROR. The information bytes give the address of the block where the recovered data error was detected. If a CIRC unrecovered data error occurs, data transfer is terminated with CHECK CONDITION status. The block with the error is not transferred. The sense key is set to MEDIUM ERROR. The information bytes give the address of the block where the unrecovered error was detected.
10h	If data transfer can be maintained, the maximum error recovery procedures available are used. (RC = 1.) If an error occurs which is uncorrectable with the error correction codes (ECC) on the media, or is uncorrectable in time to maintain data transfer, the data transfer is not terminated. However, when the data transfer has completed, CHECK CONDITION status is reported. The sense key is set to MEDIUM ERROR. The information bytes give the address of the block where the first unrecovered error was detected. Recovered errors are not reported.
14h	If data transfer can be maintained, the maximum error recovery procedures available are used. (RC = 1.) Recovered data errors are reported. If a recovered data error occurs, data transfer is not terminated. However, when the data transfer has completed, CHECK CONDITION status is reported. The sense key is set to RECOVERED ERROR. The information bytes give the address of the block where a recovered data error was detected. If an data error occurs that is uncorrectable with the ECC information available on the media, or is uncorrectable in time to maintain data transfer, the data transfer is not terminated. However, when the data transfer has completed CHECK CONDITION, status is reported. The sense key is set to MEDIUM ERROR. The information bytes give the address of the block where the first uncorrectable error was detected. Reporting unrecovered errors takes precedence over reporting recovered errors.
20h	The maximum error recovery procedures available are used. If an error occurs which is uncorrectable with the error correction codes (ECC) on the media, data transfer is terminated with CHECK CONDITION status. The block with the error is transferred. The sense key is set to MEDIUM ERROR. The information bytes give the address of the block where the unrecovered error was detected. Recovered errors are not reported.

Table 523 - Error Recovery Descriptions (CD media) (continued)

Code	Error Recovery Description
21h	Only retries of the read operation and CIRC are used (layered error correction is not used). Only CIRC unrecovered data errors are reported. If a CIRC unrecovered data error occurs data transfer is terminated with CHECK CONDITION status. The block with the error is transferred. The sense key is set to MEDIUM ERROR. The information bytes give the address of the block where the unrecovered error was detected. Recovered errors are not reported.
24h	The maximum error recovery procedures available are used. Recovered data errors are reported. If a recovered data error occurs data transfer is not terminated. However, when the data transfer has completed, CHECK CONDITION status is reported. The sense key is set to RECOVERED ERROR. The information bytes give the address of the last block where a recovered data error was detected. If a data error occurs that is uncorrectable with the ECC information available on the media data transfer is terminated and CHECK CONDITION status is reported. The block with the error is transferred. The sense key is set to MEDIUM ERROR. The information bytes give the address of the block where the uncorrectable error was detected.
25h	Only retries of the read operation and CIRC are used (layered error correction is not used). Recovered data errors are reported. If a recovered data error occurs, data transfer is not terminated. However, when the data transfer has completed, CHECK CONDITION status is reported. The sense key is set to RECOVERED ERROR. The information bytes give the address of the last block where a CIRC recovered data error was detected. If an unrecovered data error occurs, data transfer is terminated and CHECK CONDITION status is reported. The block with the error is transferred. The sense key is set to MEDIUM ERROR. The information bytes give the address of the block where the unrecovered error was detected.
26h	The maximum error recovery procedures are used. Recovered data errors are reported. If a recovered data error occurs, data transfer is terminated and CHECK CONDITION status is reported. The block with the recovered error is transferred. The sense key is set to RECOVERED ERROR. The information bytes give the address of the block where the recovered data error was detected. If a data error occurs that is uncorrectable with the ECC information on the media, data transfer is terminated with CHECK CONDITION status. The block with the error is transferred. The sense key is set to MEDIUM ERROR. The information bytes give the address of the block where the uncorrectable error was detected.
27h	Only retries of the read operation are used (layered error correction is not used). CIRC recovered data errors are reported. If a CIRC recovered data error occurs, data transfer is terminated with CHECK CONDITION status. The block with the recovered error is transferred. The sense key is set to RECOVERED ERROR. The information bytes give the address of the block where the recovered data error was detected. If a CIRC unrecovered data error occurs, data transfer is terminated with CHECK CONDITION status. The block with the error is transferred. The sense key is set to MEDIUM ERROR. The information bytes give the address of the block where the unrecovered error was detected.

Table 524 - Error Recovery Descriptions (DVD/HD DVD media)

Code	Error Recovery Description
00h	The maximum error recovery procedures available are used. If an error occurs which is uncorrectable with the error correction codes (ECC) on the media, data transfer is terminated with CHECK CONDITION status. The block with the error is not transferred. The sense key is set to MEDIUM ERROR. The information bytes give the address of the block where the unrecovered error was detected. Recovered errors are not reported.
04h	The maximum error recovery procedures available are used. Recovered data errors are reported. If a recovered data error occurs, data transfer is not terminated. However, when the data transfer has completed CHECK CONDITION status is reported. The sense key is set to RECOVERED ERROR. The information bytes give the address of the last block where a recovered data error was detected. If a data error occurs that is uncorrectable with the ECC information available on the media, data transfer is terminated and CHECK CONDITION status is reported. The block with the error is not transferred. The sense key is set to MEDIUM ERROR. The information bytes give the address of the block where the uncorrectable error was detected. The only possible recovered errors are when a block is automatically reassigned using ARRE.
10h	If data transfer can be maintained, the maximum error recovery procedures available are used. (RC = 1.) If an error occurs which is uncorrectable with the error correction codes (ECC) on the media, or is uncorrectable in time to maintain data transfer, the data transfer is not terminated. However, when the data transfer has completed, CHECK CONDITION status is reported. The sense key is set to MEDIUM ERROR. The information bytes give the address of the block where the first unrecovered error was detected. Recovered errors are not reported.
20h	The maximum error recovery procedures available are used. If an error occurs which is uncorrectable with the error correction codes (ECC) on the media, data transfer is terminated with CHECK CONDITION status. The block with the error is transferred. The sense key is set to MEDIUM ERROR. The information bytes give the address of the block where the unrecovered error was detected. Recovered errors are not reported.
24h	The maximum error recovery procedures available are used. Recovered data errors are reported. If a recovered data error occurs data transfer is not terminated. However, when the data transfer has completed, CHECK CONDITION status is reported. The sense key is set to RECOVERED ERROR. The information bytes give the address of the last block where a recovered data error was detected. If a data error occurs that is uncorrectable with the ECC information available on the media data transfer is terminated and CHECK CONDITION status is reported. The block with the error is transferred. The sense key is set to MEDIUM ERROR. The information bytes give the address of the block where the uncorrectable error was detected. The only possible recovered errors are when a block is automatically reassigned using ARRE.

The Read Retry Count field specifies the number of times that the logical unit *shall* attempt its read recovery algorithm.

The Correction Span field should be set to zero.

The Head Offset count field should be set to zero.

The Data Strobe Offset Count field should be set to zero.

An Enhanced Media Certification and Defect Reporting (EMCDR) bit controls medium certification and error reporting of logical unit. This field is used in conjunction with PER bit. Host *shall* set this field to 0 if logical unit does not support Enhanced Defect Reporting Feature. The description of this bit is described in 17.11.3.1.1.

The Write Retry Count field specifies the number of times that the logical unit *shall* attempt its write recovery algorithm. This may not have any affect if the logical unit does not support read after write operations.

The Recovery Time Limit field should be set to zero.

17.11.3.1.1 Description of PER bit and EMCDR field

Description of PER bit and EMCDR field is different if Enhanced Defect Reporting Feature is supported and is current. Following subsection 17.11.3.1.2 and 17.11.3.1.3 describe the description. By the setting PER bit and EMCDR field to 0, DBI data *shall not* be cleared.

17.11.3.1.2 In case of Enhanced Defect Reporting Feature is not supported or is not current

If logical unit does not support Enhanced Defect Reporting Feature, host *shall* set EMCDR field to 0.

If logical unit supports Enhanced Defect Reporting Feature and Enhanced Defect Reporting Feature is not current, logical unit *shall* ignore EMCDR field setting.

A Post Error (PER) bit of one indicates that the logical unit *shall* report recovered errors. A PER bit of zero indicates that the logical unit *shall not* report recovered errors. Error recovery procedures *shall* be performed within the limits established by the error recovery parameters. This capability is very different for DVD/HD DVD media. To be able to recover the data from DVD/HD DVD media, error correction *shall* be used. Thus it is not reasonable to report when ECC is used to recover the data. This bit for DVD/HD DVD media *shall* only be used to report when auto reallocation of a logical block has been performed. For CD media this capability is used to report when the Layered Error correction has been used to recover the data. Again as the CIRC is mandatory for recovery of data, then CIRC Recovered Data Error is defined as follows.

A CIRC Recovered Data Error is defined as a block for which the CIRC based error correction algorithm was unsuccessful for a read attempt, but on a subsequent read operation no error was reported. The number of subsequent read operations is limited to the read retry count. Layered error correction was not used.

A CIRC Unrecovered Data Error is defined as a block for which the CIRC based error correction algorithm was unsuccessful on all read attempts up to the read retry count. Layered error correction was not used.

An L-EC Recovered Data Error is defined as a block for which the CIRC based error correction algorithm was unsuccessful, but the layered error correction was able to correct the block within the read retry count.

An L-EC Uncorrectable Data Error is defined as a block which could not be corrected by layered error correction within the read retry count.

17.11.3.1.3 In case of Enhanced Defect Reporting Feature is current

Enhanced Defect Reporting Feature is supported and is current, logical unit behavior is described in 10.0, "Logical unit assisted software defect management model" on page 477.

PER bit, if set to 1, logical unit *shall* certify medium on read operation and verify operation. Recovered error *shall* be reported regardless EMCDR field setting. If EMCDR field is set to a value other than 0, returned recovered error *shall* be 1/18/05 RECOVERED DATA - RECOMMEND REASSIGNMENT for defect management purpose. If EMCDR field is set to 0, ASC/ASCQ of RECOVERED ERROR of CD media and DVD media is described in 17.11.3.1.2.

PER bit, if set to 0, logical unit *shall* follow the control by EMCDR field.

EMCDR field controls logical unit behavior for logical unit assisted software defect management (Enhanced Defect Reporting).

If EMCDR field is set to 0 and PER bit is set to 0, logical unit *shall* not certify medium on read operation and *shall not* report recovered error.

If EMCDR field is set to 1 and PER bit is set to 0, logical unit *shall* certify medium on read operation and verify operation, and *shall* not report recovered error.

If EMCDR field is set to 2 and PER bit is set to 0, logical unit *shall* certify medium on read operation and verify operation, and *shall* report recovered error or unrecovered error on verify operation. In case of DRT-DM mode, logical unit *shall* check the DBI memory and *shall* report recovered error on write operation.

If EMCDR field is set to 3 and PER bit is set to 0, logical unit *shall* certify medium on read operation and verify operation, and *shall* report recovered error or unrecovered error on read operation and verify operation. In case of DRT-DM mode, logical unit *shall* check the DBI memory and *shall* report recovered error or unrecovered error on write operation.

If EMCDR field is set to a value other than 0, returned recovered error of the verify operation *shall* be 1/18/05 RECOVERED DATA - RECOMMEND REASSIGNMENT. See Table 292 - *Definition of PER bit and EMCDR field of Persistent-DM mode* on page 485 and Table 293 - *Definition of PER bit and EMCDR field of DRT-DM mode* on page 489.

17.11.3.2 CD Audio Control mode page

The CD Audio Control mode page sets the playback modes and output controls for subsequent PLAY AUDIO (10) commands and any current audio playback operation.

Table 525 - CD Audio Control mode page format

Bit Byte	7	6	5	4	3	2	1	0
0	PS	Reserved	Page Code (0Eh)					
1	Page Length (0Eh)							
2	Reserved					Immed Always 1	SOTC Default 0	Reserved
3	Reserved							
4	Reserved							
5	Reserved							
6	Obsolete (75)							
7								
8	Reserved				CDDA Output Port 0 Channel Selection			
9	Output Port 0 Volume (Default FFh)							
10	Reserved				CDDA Output Port 1 Channel Selection			
11	Output Port 1 Volume (Default FFh)							
12	Reserved				CDDA Output Port 2 Channel Selection			
13	Output Port 2 Volume (Default 00h)							
14	Reserved				CDDA Output Port 3 Channel Selection			
15	Output Port 3 Volume (Default 00h)							

The Parameters Savable (**PS**) bit is only used with the MODE SENSE (10) command. This bit is reserved with the MODE SELECT (10) command. A **PS** bit of one indicates that the logical unit is capable of saving the Page in a non-volatile vendor-specific location.

The Immediate (**Immed**) bit is used for information purposes only; the audio commands will always send completion status as soon as the playback operation has been started. This bit *shall* be set to 1.

A Stop On Track Crossing (**SOTC**) bit of zero indicates the logical unit *shall* terminate the audio playback operation when the transfer length is satisfied. Multiple tracks *shall* be played as necessary. Periods of time encoded as audio pause/silence at the beginning of tracks, (index 0) *shall* also be played. An **SOTC** bit of one indicates the logical unit *shall* terminate the audio playback operation when the beginning of a following track is encountered. The **SOTC** bit is mandatory.

The CDDA Output Port Channel Selection field specifies the Red Book audio channels from the disc to which a specific output port *shall* be connected. More than one output port may be connected to an audio channel. More than one audio channel may be connected to an output port.

Table 526 - Example CDDA Output Port Channel Selection Codes

Code	Description
0000b	Output port muted
0001b	Connect audio channel 0 to this output port
0010b	Connect audio channel 1 to this output port
0011b	Connect audio channel 0 and audio channel 1 to this output port
0100b	Connect audio channel 2 to this output port
1000b	Connect audio channel 3 to this output port

The Output Port Volume Control indicates the relative volume level for this audio output port. The value used is specified as an attenuation of the normal volume level. A value of zero indicates the minimum volume level (Mute), and a value of FFh indicates maximum volume (No attenuation) level. It is recommended that the Mute and Volume functions should be supported on a per channel basis. The attenuation used *shall* be as specified in Table 527. All values not shown in the table *shall* be valid, with the attenuation selected by interpolating using the known table values.

It is recommended that the logical unit support at least 16 volume levels. The actual attenuation levels for any given Binary attenuation value *shall* be given by the following equation: $20 \text{ Log } ((\text{Binary Level} + 1) / 256)$

Note: Audio channel volume control regarding channel selection of Mute vs. Volume Level setting of 0. It is recommended that logical units allow the setting of the Channel Selection fields to Mute and also allow the setting of the Volume Level field to 0. It is up to the logical unit to determine how to shut off the volume, either via muting circuitry or via the volume control.

Table 527 - Attenuation Levels for Audio

Binary Level	Attenuation
FFh	0db (On)
F0h	-0,52
E0h	-1,12
C0h	-2,45
80h	-5,95
40h	-11,9
20h	-17,8
10h	-23,6
0Fh	-24,1
0Eh	-24,6
0Ch	-25,9
08h	-29,1
04h	-34,2
02h	-38,6
01h	-42,1
00h	Mute (Off)

17.11.3.3 Power Condition mode page

The Power Condition mode page provides the host the means to control the length of time a logical unit will delay before changing its power requirements. There are notification events to the host that a logical unit has entered into one of the power conditions.

Table 528 - Power Condition mode page format

Bit Byte	7	6	5	4	3	2	1	0
0	PS	Reserved	Page Code (1Ah)					
1	Page Length (0Ah)							
2	Reserved							
3	Reserved						Idle	Standby
4	(MSB) IDLE CONDITION TIMER (LSB)							
5								
6								
7								
8	(MSB) STANDBY CONDITION TIMER (LSB)							
9								
10								
11								

On the receipt of a command the logical unit *shall* adjust itself to the power condition which allows the command to perform. The timer which maps to this power condition and any lower power condition timers *shall* be reset on receipt of the command. On completion of the command the timer associated with this power condition *shall* be restarted.

The Parameters Savable (PS) bit is only used with the MODE SENSE (10) command. This bit is reserved with the MODE SELECT (10) command. A PS bit of one indicates that the logical unit is capable of saving the Page in a non-volatile vendor-specific location.

An Idle bit of one indicates a logical unit *shall* use the IDLE CONDITION TIMER to determine the length of inactivity time to wait before entering the Idle condition. If the Idle bit is zero, or a value of zero in the IDLE CONDITION TIMER field indicates the logical unit *shall* disable the IDLE CONDITION TIMER.

The IDLE CONDITION TIMER field indicates the inactivity time in 100 millisecond increments that the logical unit *shall* wait before entering the Idle condition. A value of zero disables the IDLE CONDITION TIMER.

A Standby bit of one indicates a logical unit *shall* use the STANDBY CONDITION TIMER to determine the length of inactivity time to wait before entering the Standby condition.

If the Standby bit is zero, or a value of zero in the STANDBY CONDITION TIMER field indicates the logical unit *shall* disable the STANDBY CONDITION TIMER.

The STANDBY CONDITION TIMER field indicates the inactivity time in 100 millisecond increments that the logical unit *shall* wait before entering the Standby condition. A value of zero disables the STANDBY CONDITION TIMER.

For more information on these timers see 13.1.2, "Timers" on page 503.

17.11.3.4 Informational Exceptions Control mode page

The Informational Exceptions Control mode page defines the methods used by the logical unit to control the reporting and the operations of specific informational exception conditions. This page *shall* only apply to informational exception that report CHECK CONDITION status, 1/5D/XX FAILURE PREDICTION THRESHOLD EXCEEDED to the host.

Informational exception conditions occur as result of vendor specific events within a logical unit. An informational exception condition may occur asynchronously to any commands issued by a host.

Note: This mode page was named the Fault/Failure Reporting Control page in earlier versions of this specification.

Table 529 - Informational Exceptions Control mode page format

Bit Byte	7	6	5	4	3	2	1	0
0	PS	Reserved	Page Code (1Ch)					
1	Page Length (0Ah)							
2	Perf	Reserved	EWasc	DExcept	Test	Reserved	LogErr (0)	
3	Reserved			MRIE				
4	(MSB) Interval Timer (LSB)							
5								
6								
7								
8	(MSB) Report Count (LSB)							
9								
10								
11								
11								

The Parameters Savable (PS) bit is only used with the MODE SENSE (10) command. This bit is reserved with the MODE SELECT (10) command. A PS bit of one indicates that the logical unit is capable of saving the Page in a non-volatile vendor-specific location.

A Performance (Perf) bit of zero indicates that informational exception operations that are the cause of delays are acceptable. A Perf bit of one indicates the logical unit *shall not* cause delays while doing informational exception operations. A Perf bit set to one may cause the logical unit to disable some or all of the informational exception operations, thereby limiting the reporting of informational exception conditions.

An enable warning sense code (EWasc) bit of zero indicates the logical unit *shall* disable reporting of the WARNING Sense Code. The MRIE field is ignored when DExcept is set to one and EWasc is set to zero. A EWasc bit of one indicates WARNING Sense Code reporting *shall* be enabled. The method for reporting the warning when the EWasc bit is set to one is determined from the Method of Reporting Informational Exceptions (MRIE) field.

A disable exception control (DExcept) bit of zero indicates informational exception operations *shall* be enabled. The reporting of informational exception conditions when the DExcept bit is set to zero is determined from the MRIE field. A DExcept bit of one indicates the logical unit *shall* disable all information exception operations. The MRIE field is ignored when DExcept is set to one and EWasc is set to zero.

A Test bit of one *shall* create a false logical unit failure at the next interval time (as specified by the Interval timer field), if the DExcept bit is not set. When the Test bit is one, the MRIE and Report Count fields *shall* apply as if the Test bit were zero. The false logical unit failure *shall* be reported with CHECK CONDITION status, 1/5D/FF FAILURE PREDICTION THRESHOLD EXCEEDED (FALSE). If both the Test and the DExcept bits are one, the logical unit *shall* terminate the MODE SELECT (10) command with CHECK CONDITION status, 5/26/00 INVALID FIELD IN PARAMETER LIST. A Test bit of zero *shall* instruct the logical unit not to generate any false logical unit failure notifications.

A log errors (LogErr) bit of zero indicates that the logging of informational exception conditions within a logical unit is vendor specific.

The Method of Reporting Informational Exceptions field (MRIE) indicates the methods that *shall* be used by the logical unit to report informational exception conditions (see Table 530). The priority of reporting multiple information exceptions is vendor specific.

Table 530 - Method of Reporting Informational Exceptions (MRIE) field

MRIE	Description
0h	No reporting of informational exception condition: This method instructs the logical unit to not report information exception conditions.
1h-3h	Reserved
4h	Unconditionally generate recovered error: This method instructs the logical unit to report informational exception conditions, regardless of the value of the PER bit of the Read-Write Error Recovery mode page, by returning CHECK CONDITION status, 1/5D/XX FAILURE PREDICTION THRESHOLD EXCEEDED. The command that has the CHECK CONDITION <i>shall</i> complete without error before any informational exception condition may be reported.
5h-Bh	Reserved
Ch-Fh	Vendor specific

The Interval Timer field indicates the period in 100 millisecond increments that a informational exception condition has occurred. The logical unit *shall not* report informational exception conditions more frequently than the time specified by the Interval Timer field and as soon as possible after the timer interval has elapsed. After the informational exception condition has been reported the interval timer *shall* be restarted. A value of zero or FFFFFFFFh in the Interval Timer field *shall* indicate the timer interval is vendor specific.

The Report Count field indicates the number of times to report an informational exception condition to the host. A value of zero in the Report Count field indicates there is no limit on the number of times the logical unit *shall* report an informational exception condition. The default value of this field *shall* be zero.

The maintaining of the Interval Timer and the Report Count field across power cycles and/or resets by the logical unit *shall* be vendor specific.

17.11.3.5 Timeout and Protect mode page

The Timeout and Protect mode page specifies parameters that affect operation of many commands.

Table 531 - Timeout and Protect mode page format

Bit Byte	7	6	5	4	3	2	1	0
0	PS	Reserved	Page Code (1Dh)					
1	Page Length (0Ah)							
2	Reserved							
3	Reserved							
4	Reserved				G3Enable	TMOE	DISP	SWPP
5	Reserved							
6	(MSB)	Group 1 Minimum Timeout (Seconds)						(LSB)
7								
8	(MSB)	Group 2 Minimum Timeout (Seconds)						(LSB)
9								
10	(MSB)	Group 3 Time-unit (100 milliseconds)						(LSB)
11								

The Parameters Savable (PS) bit is only used with the MODE SENSE (10) command. This bit is reserved with the MODE SELECT (10) command. A PS bit of one indicates that the logical unit is capable of saving the Page in a non-volatile vendor-specific location.

G3Enable bit, when set to 1, enables the Group 3 timeout capability. A G3Enable bit of zero disables the Group 3 timeout capability. In order to minimize compatibility problems, the default value for G3Enable bit should be set to zero.

The Timeout Enable (TMOE) bit, when set to 1, enables the Group 1 timeout capability. A TMOE bit of zero disables the timeout reporting capability. The default value of this bit *shall* be zero.

The Disable until Power cycle (DISP) bit, when set to 1, *shall* make the logical unit unavailable until power has been removed and then reapplied. The logical unit *shall* report NOT READY for all media access after this bit has been set to 1. The default value of this bit *shall* be zero. Support for the DISP bit is optional.

The SWPP bit provides a Software Write Protect until Powerdown. When this bit is set to 1 the logical unit *shall* prevent writes to the media. When the bit is set to 1, the logical unit *shall* flush any data in the Cache to the media before preventing any further writes. The default value of this bit *shall* be zero. Support for the SWPP bit is optional.

See 14.0, "Timeout and Reset models" on page 507 for more information on the Group 1 Minimum Timeout field, Group 2 Minimum Timeout field and Group 3 Time unit field.

17.11.3.6 C/DVD Capabilities and Mechanical Status mode page

The C/DVD Capabilities and Mechanical Status mode page is read only and may not be set with MODE SELECT (10).

Note: This information is available via the GET CONFIGURATION command.

Table 532 - C/DVD Capabilities and Mechanical Status mode page format

Bit Byte	7	6	5	4	3	2	1	0	
0	PS	Reserved	Page Code (2Ah)						
1	Page Length (30+4*(maximum number of n))								
2	Reserved		DVD-RAM Read	DVD-R Read	DVD-ROM Read	Method 2	CD-RW Rd	CD-R Rd	
3	Reserved		DVD-RAM Wr	DVD-R Write	Reserved	Test Write	CD-RW Wr	CD-R Wr	
4	Media Function Capabilities	BUF/Reserved	Multi-session	Mode 2 Form 2	Mode 2 Form 1	Digital Port(2)	Digital Port(1)	Composite	Audio Play
5		Read Bar Code Capable	UPC	ISRC	C2Pointers Supported	R-W D&C	R-W Supported	CDDA Stream Accurate	CD-DA
6		LMT			Reserved	Eject	Prevent Jumper	Lock State	Lock
7		Reserved		R-W in Lead-in Readable	Side Change Capable	S/W Slot Selection (SSS)	Supports Disc Present (SDP)	Separate Channel Mute	Sep. vol.
8	(MSB) Obsolete (LSB)								
9									
10	(MSB) Number of Volume Levels Supported (LSB)								
11									
12	(MSB) Buffer Size supported by logical unit (in KBytes) (LSB)								
13									
14	(MSB) Obsolete (LSB)								
15									
16	Obsolete								
17	Reserved		Length		LSBF	RCK	BCKF	Reserved	
18	(MSB) Obsolete (LSB)								
19									
20	(MSB) Obsolete (LSB)								
21									
22	(MSB) Copy Management Revision Supported (LSB)								
23									
24-26	Reserved								
27	Reserved						Rotation Control Selected		
28	(MSB) Current Write Speed Selected (kbytes/sec) (LSB)								
29									
30	(MSB) Number of logical unit Write Speed Performance Descriptor Tables (n) (LSB)								
31									
32-35	Logical unit Write Speed Performance Descriptor Block #1								
36-39	Logical unit Write Speed Performance Descriptor Block #2								

Table 532 - C/DVD Capabilities and Mechanical Status mode page format (continued)

Bit Byte	7	6	5	4	3	2	1	0
:	:							
n*4+28- n*4+31	Logical unit Write Speed Performance Descriptor Block #n							
:	Padding							

The Parameters Savable (PS) bit is only used with the MODE SENSE (10) command. This bit is reserved with the MODE SELECT (10) command. A PS bit of one indicates that the logical unit is capable of saving the Page in a non-volatile vendor-specific location.

The Page Length field *shall* be set to maximum length that contains maximum number of logical unit Write Speed Performance Descriptor Blocks. The Page Length is fixed for a logical unit, but may be different from one logical unit to the other. If the logical unit Write Speed Performance Descriptor Block for mounted media is shorter than the maximum length of the logical unit Write Speed Performance Descriptor Block, then the rest of the field *shall* be padded with 0.

If logical unit does not support high speed CD-R/RW recording, the logical unit *shall not* return the mode page data after byte 26.

Media Function Capabilities, when set to one, indicates support for the identified item. When set to zero, indicates no support:

If CD-R Read (CD-R Rd) bit is set to one, the logical unit *shall* support the read function of CD-R disc (Orange Book Part II).

If CD-RW Read (CD-RW Rd) bit is set to one, the logical unit *shall* support the read function of CD-RW disc (Orange Book Part III).

If Method 2 bit is set to one, the logical unit *shall* support the read function of CD-R media written using fixed packet tracks using Addressing Method 2.

If DVD-ROM Read bit (read only field) is set to one, the logical unit *shall* support the read function of DVD-ROM disc.

If DVD-R Read bit (read only field) is set to one, the logical unit *shall* support the read function of DVD-R disc.

If DVD-RAM Read bit (read only field) is set to one, the logical unit *shall* support the read function of DVD-RAM disc.

If CD-R Write (CD-R Wr) bit is set to one, the logical unit *shall* support the write function of CD-R disc (Orange Book Part II).

If CD-RW Write (CD-RW Wr) bit is set to one, the logical unit *shall* support the write function of CD-RW disc (Orange Book Part III).

If DVD-R Write bit (read only field) is set to one, the logical unit *shall* support the write function of DVD-R disc. If the Test Write bit is set to one, the logical unit *shall* only accept data from the host and not write to the media.

If DVD-RAM Write (DVD-RAM Wr) bit (read only field) is set to one, the logical unit *shall* support the write function of DVD-RAM disc.

The individual capabilities of the logical unit are specified by bytes 4 through 7. Each of the bits indicate if that specific capability is supported. A value of zero indicates that the capability is NOT supported; a value of one indicates the capability IS supported.

Bit 0, Sep. vol. Separate Volume Levels. The audio level for each channel can be controlled independently.

Bit 1, Separate Channel Mute The mute capability for each channel can be controlled independently.

Bit 2, SDP	Supports Disc Present. This bit indicates that the logical unit contains an embedded changer, and that after a reset condition or if a cartridge is changed, it can report the exact contents of the slots. The response to the MECHANISM STATUS command will contain valid Disc is Present status information for all slots.
Bit 3, SSS	Software Slot Selection. This bit controls the behavior of the LOAD/UNLOAD MEDIUM command when trying to load a Slot with no Disc present (see Table 505 - <i>Load/Unload or Optional Selection Operations</i> on page 661).
Bit 4, Side Change Capable	This bit indicates that the logical unit is capable of selecting both sides of the Discs. This capability can be reported for logical units that have changer functions.
Bit 5, R-W in Lead-in Readable	This bit indicates that the logical unit is capable of reading R-W subcode in the Lead-in. This is used with CD-Text.
Bits 7-6, Reserved	Reserved.
Bit 8, Lock	The PREVENT ALLOW MEDIUM REMOVAL command is capable of actually locking the media into the logical unit.
Bit 9, Lock State	This indicates the current state of the logical unit. 0 The logical unit is currently in the allow (Unlocked) state. Media may be inserted or ejected. 1 The logical unit is currently in the prevent (Locked) state. Media loaded in the logical unit may not be removed via a soft or hard eject. If the logical unit is empty, media may not be inserted if the Prevent Jumper is not present. If the jumper is present, then media may be inserted.
Bit 10, Prevent Jumper	This indicates the state of the (Optional) Prevent/Allow Jumper. 0 Jumper is present. Logical unit will power up to the allow state. Locking the logical unit with the PREVENT ALLOW MEDIUM REMOVAL command shall not prevent the insertion of media. 1 Jumper is not present. Logical unit will power up to the Prevent State (Locked). The logical unit will not accept new media or allow the ejection of media already loaded until an allow command is issued.
Bit 11, Eject	The logical unit can eject the disc via the normal START STOP UNIT command with the LoEj bit set. If the mechanism is a Changer that uses a Cartridge, then this bit indicates that the Cartridge can be ejected.
Bit 12, Reserved	Reserved
Bit 15-13, LMT	Loading Mechanism Type. This field specifies the type of disc loading the logical unit supports. See Table 533.

Table 533 - Loading Mechanism Type (LMT)

Bit 15	Bit 14	Bit 13	Definition
0	0	0	Caddy type loading mechanism
0	0	1	Tray type loading mechanism
0	1	0	Pop-up type loading mechanism
0	1	1	Reserved
1	0	0	Changer with individually changeable discs
1	0	1	Changer using a Cartridge Mechanism
1	1	0	Reserved
1	1	1	Reserved

Bit 16, CD-DA	Red Book audio can be read using the READ CD command.
Bit 17, CDDA Stream Accurate	This bit indicates that the logical unit supports an advanced feature that allows it to return to an audio location without losing place to continue the READ CD command. 0: The logical unit is incapable of accurately restarting the CD-DA read operation, and CHECK CONDITION status, B/11/11 READ ERROR - LOSS OF STREAMING <i>shall</i> be reported whenever a loss of streaming occurs. This error will be fatal and the command will have to be repeated from the beginning. 1 The logical unit can continue from a loss of streaming condition and no error will be generated.
Bit 18, R-W Supported	The commands that return Sub-channel data can return the combined R-W information.
Bit 19, R-W D&C	R-W De-interleaved & Corrected. This indicates that the R-W sub-channel data will be returned de-interleaved and error corrected.
Bit 20, C2 Pointers Supported	This indicates that the logical unit supports the C2 Error Pointers. This also indicates that the logical unit is capable of returning the C2 Error Pointers and C2 Block Error flags in the READ CD command.
Bit 21, ISRC	The logical unit can return the International Standard Recording Code Information.
Bit 22, UPC	The logical unit can return the Media Catalog Number (UPC)
Bit 23, Read Bar Code Capable	The logical unit is capable of reading the disc bar code.
Bit 24, Audio Play	The logical unit is capable of Audio Play operation. This also indicates that the logical unit is capable of overlapping Play and other commands such as reading of the Sub-channel information.
Bit 25, Composite	The logical unit is capable of delivering a composite Audio and Video data stream.
Bit 26, Digital Port(1)	The logical unit supports digital output (IEC958) on port 1
Bit 27, Digital Port(2)	The logical unit supports digital output(IEC958) on port 2
Bit 28, Mode 2 Form 1	The logical unit is capable of reading sectors in Mode 2 Form 1 (XA) format.
Bit 29, Mode 2 Form 2	The logical unit is capable of reading sectors in Mode 2 Form 2 format.
Bit 30, Multi-session	The logical unit is capable of reading multiple session or Photo-CD discs.
Bit 31, BUF/Reserved	For CD logical unit, this bit indicates that the logical unit is capable of buffer underrun free recording on CD-R/CD-RW media. For non-CD logical unit, this bit is reserved.

The **Number of Volume Levels Supported** field returns the number of discrete levels. If the logical unit only supports turning audio on and off, the **Number of Volume Levels Supported** field *shall* be set to 2.

The **Buffer Size Supported** field returns the number of bytes of buffer dedicated to the data stream returned to the host. This value is returned in Kbytes (Size/1 024). If the logical unit does not have a buffer cache, the value returned *shall* be zero.

Byte 17 is used to describe the format of the logical unit's digital output. See Table 534.

Table 534 - Digital Output format

Bit	Name	Behavior
1	BCKF	Set if data valid on the falling edge of the BCK signal. Clear if data valid on the rising edge of the BCK signal
2	RCK	Set if HIGH on LRCK indicates left channel. Clear if HIGH on LRCK indicates right channel.
3	LSBF	Set if LSB first. Clear if MSB first.
4-5	Length	00 32 BCKs 01 16 BCKs 10 24 BCKs 11 24 BCKs (I ² S)

The Copy Management Revision Supported field indicates the version of the DVD content protection scheme that is supported by the logical unit. This *shall* be 0001h if DVD CSS/CPM is supported or 0000h otherwise.

The Rotation Control Selected field indicates the actual Rotation Control to the current disc.

The Current Write Speed Selected field indicates the actual data rate that the logical unit is currently using.

Number of Drive Write Speed Performance Descriptor Tables field specifies the number of logical unit Write Speed Performance Descriptor Blocks that follow this field.

Each logical unit Write Speed Performance Descriptor Block *shall* contain rotation control information and write speed that is supported by the logical unit.

The logical unit Write Speed Performance Descriptor Block is structured as shown in Table 535.

Table 535 - logical unit Write Speed Performance Descriptor Table format

Bit Byte	7	6	5	4	3	2	1	0
0	Reserved							
1	Reserved						Rotation Control	
2	(MSB) Write Speed Supported (kbytes/sec)							
3	(LSB)							

Table 536 - Rotation Control field definition

Value	Definition
00b	Non-pure CAV and CLV
01b	Pure CAV
10b	Reserved
11b	Reserved

The Write Speed Supported field indicates the write speed that is supported by the logical unit. In the case of non-CLV rotational control, the Logical unit Write Speed *shall* be assumed to reference the speed at 79:59:74 MSF, regardless of actual capacity or disc diameter.

The logical unit *shall* report a record speed in descending order. If the logical unit supports both CLV and CAV on the medium, then the logical unit *shall* report all CLV descriptors first.

In the case of no recordable media mounted, the logical unit Write Speed Performance Descriptor Table *shall* report the most appropriate list of the speed such as the list for CD-R disc or just maximum recording speed.

17.11.3.7 Write Parameters mode page

The writing of a disc requires the host read a set of parameters from the device, selecting the parameters to be used, setting those parameters in the write parameters of the device and then using the normal WRITE command. Once the write process has begun, data is streamed from the host to the device.

The Write Parameters mode page contains parameters needed for the correct execution of WRITE commands.

The values in this Page do not necessarily reflect the status on a given medium. They will be used as applicable when a write operation occurs. If any parameters have values incompatible with the current medium, the logical unit *shall* generate a CHECK CONDITION status, 5/64/00 ILLEGAL MODE FOR THIS TRACK when a write is attempted.

Fields that are ignored for the current medium may contain 0 for the default mode parameter value.

For DVD-RW SL media, if a medium is in Sequential recording mode, usage of this mode page *shall* conform to descriptions for DVD-R unless otherwise specified. If a medium is in Restricted overwrite mode, this mode page *shall not* be used.

For HD DVD, this mode page *shall not* be used.

Table 537 - Write Parameters mode page format

Bit Byte	7	6	5	4	3	2	1	0								
0	PS	Reserved	Page Code(05h)													
1	Page Length(32h)															
2	Reserved	BUFE	LS_V	Test Write	Write Type											
3	Multisession/Border		FP ^a	Copy	Track Mode ^a											
4	Reserved				Data Block Type ^a											
5	Link Size															
6	Reserved															
7	Reserved		Host Application Code ^a													
8	Session Format ^a															
9	Reserved															
10	(MSB) Packet Size (LSB)															
11																
12																
13																
14	(MSB) Audio Pause Length ^a (LSB)															
15																
16	(MSB) Media Catalog Number ^a (LSB)															
:																
31																
32																
:	(MSB) International Standard Recording Code ^a (LSB)															
47																
48									Sub-header Byte 0 ^a							
49									Sub-header Byte 1 ^a							
50	Sub-header Byte 2 ^a															
51	Sub-header Byte 3 ^a															

a. Ignored when DVD-R medium is present.

The Parameters Savable (PS) bit is only used with the MODE SENSE (10) command. This bit is reserved with the MODE SELECT (10) command. A PS bit of one indicates that the logical unit is capable of saving the Page in a non-volatile vendor-specific location.

The Buffer Underrun Free Enable (BUFE) bit, when set to one, *shall* indicate that Buffer Under-run Free recording is enabled for sequential recording. The logical unit *shall* perform Lossless-Link and continue the writing when the buffer becomes empty. The value zero *shall* indicate that logical unit *shall* terminate writing and perform linking. The following WRITE (10) command is terminated with CHECK CONDITION status, 5/21/02 INVALID ADDRESS FOR WRITE. In order to minimize compatibility problems, the default value for BUFE bit should be zero for CD-R/RW logical units. For DVD-R Dual Layer discs, this bit is ignored and the logical unit *shall* assume this bit is set to one.

The Link Size Valid (LS_V) bit *shall* be set to one to indicate that the value in the Link Size field is valid. The value zero is for compatibility with legacy logical units that did not implement the Link Size field; such logical units assume a Link Size of 7.

On CD-R or CD-RW media, the Test Write bit is valid only for Write Type 1 or 2 (Track at Once or Session at Once).

On DVD-R media, the Test Write bit is valid only for Write Type 0 or 2 (Incremental or Disc-at-once).

The validity of the Test Write bit is vendor specific for other media types.

When the **Test Write** bit is set to one, it indicates that the logical unit performs the write process, but does not write data to the media. When the bit is set to zero the Write laser power is set such that user data is transferred to the media. In addition, all Track/RZone and disc information collected, during test write mode, *shall* be cleared. It should be noted that the number of Track/RZones reserved or written may be limited in test write mode.

Write Type field specifies the stream type to be used during writing. See Table 538.

Table 538 - Write Type field

Value	Definition
00h	Packet/Incremental recording
01h	Track-at-once recording ^a
02h	Session-at-once/Disc-at-Once recording
03h	Raw recording ^a
04h	Layer Jump recording ^b
05h-0Fh	Reserved

- a. Invalid when non-CD medium is present.
- b. Invalid when non-Layer Jump recording capable medium is present.

Packet/incremental - the logical unit *shall* perform packet/incremental writing when WRITE (10) commands are issued.

Track-at-once - the logical unit *shall* perform track at once recording when WRITE (10) commands are issued.

Session-at-once/Disc-at-once - For CD, the logical unit *shall* perform session at once recording. This mode requires that a cue sheet be sent prior to sending WRITE (10) commands. For DVD, the logical unit *shall* perform Disc at once recording. All data, includes Lead-in and Lead-out, is recorded on the media sequentially without interruption.

Raw - the logical unit *shall* write data as received from the host. In this mode, the host sends the Lead-in. As the host *shall* provide Q sub-channel in this mode, the only valid Data Block Types are 1, 2, and 3. The NWA starts at the beginning of the Lead-in (which *shall* be a negative LBA on a blank disc). In RAW record mode, the drive *shall not* generate run-in and run-out blocks (main and sub-channel 1 data) but *shall* generate and record the link block.

Layer Jump recording - the logical unit *shall* perform Layer Jump recording when WRITE (10) commands are issued. When this write type is specified, regardless of BUFE bit setting, Buffer Underrun Error Free recording *shall* be performed.

The Multisession/Border field defines how a Session/Border closure affects the opening of the next Session/Border. See Table 539.

Table 539 - Multisession/Border field definition

Multisession/Border Field	Action Upon Session/Border Closure
00b	For CD, No B0 pointer. Next Session not allowed. For DVD, next Border not allowed. When current Border is closed, Lead-out <i>shall</i> be appended after the last Border-out. In the case of DVD-R media, the Next Border Marker in last Border-out <i>shall</i> be padded with 00h bytes and <i>shall</i> have the Lead-out attribute set.
01b	For CD, B0 pointer = FF:FF:FF. Next session not allowed. For DVD, Reserved
10b	Reserved
11b	For CD, Next session allowed. B0 pointer = next possible program area. For DVD, Next Border allowed. Lead-out <i>shall not</i> be appended after the last Border-out.

The Fixed Packet (FP) bit, when set to one indicates that the packet type is fixed. Otherwise, the packet type is variable. This bit is ignored unless the Write Type is set to 0 (Packet). For DVD-R, this bit *shall* be set to one and ignored.

A Copy bit with value one indicates that this is the first or higher generation copy of a copyright protected track. When set to one, the copyright bit in the control nibble of each mode 1 Q sub-channel *shall* alternate between 1 and 0 at 9,375 Hz. The duty cycle is 50%, changing every 4 blocks. The initial value on the medium is zero. For DVD-R, this field *shall* be ignored.

Track Mode is the Control nibble in all mode 1 Q sub-channel in the track. This field *shall* be ignored for DVD-R recording. The default value of this field for DVD-R logical units should be 5.

Data Block Type defines both the specific data fields in a user data block and its size. The Data Block Type is as defined in Table 540. This size is used for writing instead of the block size set in the Mode Select Header. For DVD-R, this field *shall* be ignored. The default value of this field for DVD-R logical units should be 8.

Table 540 - Data Block Type codes

Value	Block Size	Definition	Requirement
0	2 352	Raw data 2 352 bytes of raw data (not valid for Write Type = packet)	Optional
1	2 368	Raw data with P and Q sub-channel 2 352 bytes of raw data, 16 bytes buffer for Q sub-channel: Bytes 0..9 are Q sub-channel data Bytes 10..11 are Q sub-channel EDC Bytes 12..14 are zero Byte 15, most significant bit has state of P sub-channel bit (not valid for Write Type = packet) (Q sub-channel data is in binary format.)	Optional
2	2 448	Raw data with P-W sub-channel appended: 2 352 bytes of raw data. 96 bytes of pack form R-W sub-channel in the low order 6 bits of each byte. Bit 7 of each byte contains the P sub-channel state and bit 6 of each byte contains the Q sub-channel bit. (not valid for Write Type = packet)	Optional
3	2 448	Raw data with raw P-W sub-channel appended: 2 352 bytes of raw data. 96 bytes of raw P-W sub-channel. (not valid for Write Type = packet)	Optional
4-6		Reserved values	-
7	NA	Vendor Specific	Optional
8	2 048	Mode 1 (ISO/IEC 10149): 2 048 bytes of user data	Mandatory
9	2 336	Mode 2 (ISO/IEC 10149): 2 336 bytes of user data	Optional
10	2 048	Mode 2 (CD-ROM XA, form 1): 2 048 bytes of user data, sub-header from write parameters	Mandatory
11	2 056	Mode 2 (CD-ROM XA, form 1): 8 bytes of sub-header, 2 048 bytes of user data	Optional
12	2 324	Mode 2 (CD-ROM XA, form 2): 2 324 bytes of user data, sub-header from write parameters	Optional
13	2 332	Mode 2 (CD-ROM XA, form 1, form 2, or mixed form): 8 bytes of sub-header 2 324 bytes of user data	Mandatory
14	-	Reserved	-
15	NA	Vendor Specific	Optional

General Writing Requirements

- When a track has been designated for packet writing, the device *shall* ensure that the TDB is written upon receipt of the WRITE (10) command.
- With the exceptions of data block types 1, 2, and 3, the device *shall* generate all P sub-channel and all mode 1, mode 2, and mode 3 Q sub-channel.
- For data block types 8 through 13, the device *shall* generate all sync fields and all headers.
- For data blocks of mode 1 or of mode 2, form 1, the device *shall* generate EDC and L-EC parity.
- For data block types 0, 1, 2, and 3, the device *shall* perform no data scrambling per ISO/IEC 10149.
- For data block types 8 through 13, the device *shall* perform data scrambling per ISO/IEC 10149.

The **Link Size** field specifies the Linking Loss Area size in sectors. The **Link Size** field is valid only for **Write Type** “Packet/Incremental” or “Layer Jump recording”. When another **Write Type** is specified, device *shall* ignore **LS_V** bit and **Link Size** field. The logical unit *shall* accept values that are valid for the logical unit but not valid for the current medium. If writing is attempted when an invalid **Link Size** is set, the logical unit *shall* generate CHECK CONDITION status, ILLEGAL REQUEST, ILLEGAL MODE FOR THIS TRACK/RZONE.

Table 541 - Link Size field definition

Value	Description
00h	Linking Loss Area size is 0 bytes.
01h	Linking Loss Area size is 2 048 bytes.
02h	Linking Loss Area size is 4 096 bytes.
:	:
10h	Linking Loss Area size is 32 768 bytes.
:	:
FFh	Linking Loss Area size is 522 240 bytes.

The **Host Application Code** is typically zero. When the **Unrestricted Use Disc (URU)** bit in **Disc Information Block** is one, the **Host Application Code** *shall* be ignored by the device. If the **URU** bit is zero, then the **Host Application Code** *shall* be set to the appropriate value for the medium in order that writing be allowed. A **Host Application Code** of zero is used for a **Restricted Use - General Purpose Disc**. The **Host Application Code** field is ignored for **DVD-R** recording.

The **Session Format code** is to be written in the **TOC** of the session containing this track. The **Session Format code** is the **PSEC** byte of the mode 1, point A0 **TOC** entry. See Table 542. The **Session Format code** is ignored for **DVD-R/-RW** recording.

Table 542 - Session Format codes

Disc Type Code	Session Format
00h	CD-DA, CD-ROM, or other data disc
10h	CD-I Disc
20h	CD-ROM XA Disc
All Other Values	Reserved

The **Packet Size** field, if **FP** bit is set to 1, specifies the number of **User Data Blocks** per fixed packet. The **Packet Size** field, if **FP** bit is set to 0, *shall* be ignored. For **DVD-R** media, the default **Packet Size** *shall* be 16. The **Packet Size** *shall* be set to 16 to record to **DVD-R** media.

Audio Pause Length is the number of blocks from the beginning of the track for which the mode 1 **Q** sub-channel **INDEX** *shall* be zero. If this number is zero, then there is no period where the Mode 1 **Q** sub-channel **INDEX** *shall* be zero. The default value *shall* be 150. This field is valid only for audio tracks, otherwise it is ignored.

The **Media Catalog Number (MCN)** will be written in a mode 2 **Q** sub-channel in at least one out of every 100 blocks in the program area.

The **International Standard Recording Code (ISRC)** is valid only for audio tracks. Otherwise it is ignored. **ISRC** is formatted as in Table 663 - *ISRC Format of Data Returned to host* on page 784.

17.12 PAUSE/RESUME command

The PAUSE/RESUME command requests that the logical unit stop or start an audio play operation. This command is used with PLAY AUDIO (10) command that are currently executing in immediate mode.

Table 543 - PAUSE/RESUME Command Descriptor Block

Bit Byte	7	6	5	4	3	2	1	0
0	Operation Code (4Bh)							
1	LUN (Obsolete)			Reserved				
2	Reserved							
3	Reserved							
4	Reserved							
5	Reserved							
6	Reserved							
7	Reserved							
8	Reserved							Resume
9	Vendor-Specific	Reserved			NACA	Flag	Link	
10	PAD							
11								

A **Resume** bit of zero causes the logical unit to enter the hold track state with the audio output muted after the current block is played. A **Resume** bit of one causes the logical unit to release the pause/scan and begin play at the block following the last block played/scanned.

If an audio play operation cannot be resumed and the **Resume** bit is one, the command *shall* be terminated with CHECK CONDITION status, 5/2C/00 COMMAND SEQUENCE ERROR. If the **Resume** bit is zero and an audio play operation cannot be paused, (no audio play operation has been requested, or the requested audio play operation has been completed), the command is terminated with CHECK CONDITION status. See Figure 224 - *Stop Play/Play Audio/Audio Scan/Pause/Resume Sequencing* on page 899 for additional information.

It *shall not* be considered an error to request a PAUSE when a pause is already in effect or to request a RESUME when a play operation is in progress.

Table 544 describes errors that may occur during the operation of the command or which may cause a CHECK CONDITION status to be reported.

Table 544 - PAUSE/RESUME command errors

Error Description
<i>A-1.1, "Deferred Error Reporting" on page 919</i>
<i>Table 835 - Basic Error Codes on page 932</i>
<i>Table 836 - Media Access Error Codes on page 935</i>

17.13 PLAY AUDIO (10) command

The PLAY AUDIO (10) command requests that the CD logical unit begin an audio playback operation. The command function and the output of audio signals *shall* be as specified by the settings of the CD Audio Control mode page, including the SOTC bit.

Table 545 - PLAY AUDIO (10) Command Descriptor Block

Bit Byte	7	6	5	4	3	2	1	0
0	Operation Code (45h)							
1	LUN (Obsolete)				Reserved			
2	(MSB) Starting Logical Block Address (LSB)							
3								
4								
5								
6								
7	(MSB) Play Length (LSB)							
8								
9	Vendor-Specific		Reserved			NACA	Flag	Link
10	PAD							
11								

This command responds with immediate status, allowing overlapped commands.

If any commands related to audio operations are implemented then the PLAY AUDIO (10) command *shall* be implemented to allow a method for the host to determine if audio operations are supported. A CD logical unit responding to a PLAY AUDIO (10) command that has a transfer length of zero with CHECK CONDITION status, 5/20/00 INVALID COMMAND OPERATION CODE does not support audio play operations.

The Starting Logical Block Address field specifies the logical block at which the audio playback operation *shall* begin. PLAY AUDIO (10) commands with a Starting Logical Block Address of FFFF FFFFh *shall* implement audio play from the current location of the pickup. PLAY AUDIO (10) commands with a Starting LBA of 0000 0000h *shall* begin the audio play operation at 00/02/00.

The Play Length field specifies the number of contiguous logical blocks that *shall* be played. A Play Length field of zero indicates that no audio operation *shall* occur. This condition *shall not* be considered an error.

If the Starting Logical Block Address is not found the command *shall* be terminated with CHECK CONDITION status, 5/21/00 LOGICAL BLOCK ADDRESS OUT OF RANGE. If the address is not within an audio track the command *shall* be terminated with CHECK CONDITION status, 5/64/00 ILLEGAL MODE FOR THIS TRACK. If a NOT READY condition exists, the command *shall* be terminated with CHECK CONDITION Status with the Sense Key set to 2 unless the Play Length is set to 0.

If the CD information type (data vs. audio) changes within the Transfer Length, the command *shall* be terminated with a CHECK CONDITION status, 5/63/00 END OF USER AREA ENCOUNTERED ON THIS TRACK at the time of encountering the transition.

If the logical block address requested is not within an audio track and the Play Length is non-zero, the command *shall* be terminated with CHECK CONDITION status, 5/64/00 ILLEGAL MODE FOR THIS TRACK.

17.13.1 PLAY AUDIO (10) with Immediate Packet commands

The PLAY AUDIO (10) and SCAN commands will continue to play while other commands are processed by the logical unit. Some commands can be accepted without disrupting the audio operations, while others will cause the Play operation to stop. The following section describes the operation of other commands while playing audio.

The CD logical unit *shall* accept and perform the commands as specified in Table 546. If any other command than described in Table 546 is received, the Audio playback or scan may be terminated.

See Figure 224 - *Stop Play/Play Audio/Audio Scan/Pause/Resume Sequencing* on page 899 for additional information.

For ATAPI logical units, the ATA commands other than A2 or A0 *shall* stop any play or scan.

When any command generates CHECK CONDITION status, 5/24/00 INVALID FIELD IN CDB, it may terminate the play operation.

Table 546 - Play or Scan overlapped command operation

Opcode	Command Description	Action Taken
A1h	BLANK	Play operation <i>shall</i> be stopped.
5Bh	CLOSE TRACK/SESSION	Play operation <i>shall</i> be stopped.
04h	FORMAT UNIT	Play operation <i>shall</i> be stopped
46h	GET CONFIGURATION	Play operation <i>shall not</i> be stopped
4Ah	GET EVENT/STATUS NOTIFICATION	Play operation <i>shall not</i> be stopped
ACh	GET PERFORMANCE	Play operation may be stopped
12h	INQUIRY	Play operation <i>shall not</i> be stopped
A6h	LOAD/UNLOAD MEDIUM	Play operation <i>shall</i> be stopped
BDh	MECHANISM STATUS	Play operation <i>shall not</i> be stopped
55h	MODE SELECT (10)	Play operation <i>shall not</i> be stopped
5Ah	MODE SENSE (10)	Play operation <i>shall not</i> be stopped
4Bh	PAUSE/RESUME	Play operation <i>shall</i> stop or continue based on command type
45h	PLAY AUDIO (10)	Play <i>shall</i> continue from the new address.
47h	PLAY AUDIO MSF	Play <i>shall</i> continue from the new address.
1Eh	PREVENT ALLOW MEDIUM REMOVAL	Play operation <i>shall not</i> be stopped
28h/A8h	READ (10), READ (12)	Play operation <i>shall</i> be stopped.
3Ch	READ BUFFER	Play operation may be stopped
5Ch	READ BUFFER CAPACITY	Play operation <i>shall not</i> be stopped
25h	READ CAPACITY	Play operation <i>shall not</i> be stopped
BEh	READ CD	If the READ CD command requests only the Q sub-channel data then the Play will continue and the command will return the data from the current location. If any data other than the Q sub-channel is requested the command <i>shall</i> be performed and the Play operation will be aborted.
B9h	READ CD MSF	If the READ CD command requests only the Q sub-channel data then the Play will continue and the command will return the data from the current location. If any data other than the Q sub-channel is requested the command <i>shall</i> be performed and the Play operation will be aborted.
51h	READ DISC INFORMATION	Play operation may be stopped
ADh	READ DISC STRUCTURE	Play operation may be stopped
23h	READ FORMAT CAPACITIES	Play operation may be stopped

Table 546 - Play or Scan overlapped command operation (continued)

Opcode	Command Description	Action Taken
42h	READ SUBCHANNEL	Only the current position information (Format Code 01h) will be supported while the play is in progress. If any other type of information is requested the READ SUB-CHANNEL may not be performed and a CHECK CONDITION status will be generated.
43h	READ TOC/PMA/ATIP	Only logical units that cache the TOC will be able to respond to this command while the play is in progress. If the logical unit does not support caching the TOC, the command may not be performed and a CHECK CONDITION will be generated.
52h	READ TRACK INFORMATION	Play operation may be stopped
58h	REPAIR RZONE	Play operation <i>shall</i> be stopped
A4h	REPORT KEY	Play operation may be stopped
03h	REQUEST SENSE	Play operation <i>shall not</i> be stopped
53h	RESERVE TRACK	Play operation may be stopped
BAh	SCAN	SCAN command will be performed and the PLAY command will resume at completion of the Scan.
2Bh	SEEK	Play operation <i>shall</i> be stopped
5Dh	SEND CUE SHEET	Play operation may be stopped
BFh	SEND DISC STRUCTURE	Play operation may be stopped
A2h	SEND EVENT	Play operation may be stopped
A3h	SEND KEY	Play operation may be stopped
54h	SEND OPC INFORMATION	Play operation may be stopped
A7h	SET READ AHEAD	Play operation <i>shall not</i> be stopped
B6h	SET STREAMING	Play operation may be stopped
1Bh	START STOP UNIT	Play operation <i>shall</i> be stopped
4Eh	STOP PLAY/SCAN	Play operation <i>shall</i> be stopped
35h	SYNCHRONIZE CACHE (10)	Play operation <i>shall not</i> be stopped
00h	TEST UNIT READY	Play operation <i>shall not</i> be stopped
2Fh	VERIFY (10)	Play operation <i>shall</i> be stopped
2Ah/AAh	WRITE (10) / WRITE (12)	Play operation <i>shall</i> be stopped
2Eh	WRITE AND VERIFY (10)	Play operation <i>shall</i> be stopped
3Bh	WRITE BUFFER	Play operation may be stopped

Table 547 describes errors that may occur during the operation of the command or which may cause a CHECK CONDITION status to be reported.

Table 547 - PLAY AUDIO (10) command errors

Error Description
A-1.1, "Deferred Error Reporting" on page 919
Table 835 - Basic Error Codes on page 932
Table 836 - Media Access Error Codes on page 935

17.14 PLAY AUDIO MSF command

The PLAY AUDIO MSF command requests that the CD logical unit begin an audio playback operation. The command function and the output of audio signals *shall* be as specified by the settings of the mode parameters including the SOTC Default 0 bit described in Table 525 - *CD Audio Control mode page format* on page 680.

Table 548 - PLAY AUDIO MSF Command Descriptor Block

Bit Byte	7	6	5	4	3	2	1	0
0	Operation Code (47h)							
1	LUN (OBsolete)			Reserved				
2	Reserved							
3	Starting M							
4	Starting S							
5	Starting F							
6	Ending M							
7	Ending S							
8	Ending F							
9	Vendor-Specific		Reserved			NACA	Flag	Link
10	PAD							
11								

This command responds with immediate status, allowing overlapped commands.

The Starting M field, the Starting S field, and the Starting F field specify the absolute MSF address at which the audio play operation *shall* begin. The Ending M field, the Ending S field, and the Ending F field specify the absolute MSF address where the audio play operation *shall* end. All contiguous audio sectors between the starting and the ending MSF address *shall* be played.

If the Starting M, Starting S and Starting F fields are set to FFh, the starting address is taken from the Current Optical Head location. This allows the Audio Ending address to be changed without interrupting the current playback operation.

A Starting MSF address equal to an Ending MSF address causes no audio play operation to occur. This *shall not* be considered an error. If the Starting MSF address is greater than the Ending MSF address, the command *shall* be terminated with CHECK CONDITION status, 5/24/00 INVALID FIELD IN CDB.

If the starting address is not found the command *shall* be terminated with CHECK CONDITION status, 5/21/00 LOGICAL BLOCK ADDRESS OUT OF RANGE. If the address is not within an audio track the command *shall* be terminated with CHECK CONDITION status, 5/64/00 ILLEGAL MODE FOR THIS TRACK. If a NOT READY condition exists, the command *shall* be terminated with CHECK CONDITION status and the Sense Key set to 2, unless the Starting and Ending MSF fields are equal.

See 17.13.1, "PLAY AUDIO (10) with Immediate Packet commands" on page 700 for information on overlapped commands during an Audio Playback.

Table 549 describes errors that may occur during the operation of the command or which may cause a CHECK CONDITION status to be reported.

Table 549 - PLAY AUDIO MSF command errors

Error Description
<i>A-1.1, "Deferred Error Reporting" on page 919</i>
<i>Table 835 - Basic Error Codes on page 932</i>
<i>Table 836 - Media Access Error Codes on page 935</i>

17.15 PREVENT ALLOW MEDIUM REMOVAL command

The PREVENT ALLOW MEDIUM REMOVAL command requests that the logical unit enable or disable the removal of the medium in the logical unit. The prevention of media removal (when implemented) *shall* be accomplished through the use of a Locking Mechanism. The use of a physical locking mechanism is optional. If a non persistent prevent is issued and the logical unit does not support a physical locking mechanism, the logical unit *shall* return CHECK CONDITION status, 5/24/00 INVALID FIELD IN CDB. If the operation is persistent then the Prevent will not be reset when media is removed or inserted. This will allow new media to become captive without host interaction. The Persistent Prevent is to be used in conjunction with the GET EVENT/STATUS NOTIFICATION command, to prevent media from being ejected with dirty file system buffers.

Table 550 - PREVENT ALLOW MEDIUM REMOVAL Command Descriptor Block

Bit Byte	7	6	5	4	3	2	1	0
0	Operation Code (1Eh)							
1	LUN (Obsolete)			Reserved				
2	Reserved							
3	Reserved							
4	Reserved						Persistent	Prevent
5	Vendor-Specific	Reserved			NACA	Flag	Link	
6	PAD							
7								
8								
9								
10								
11								

The Persistent bit, when set, indicates that this will be a Persistent PREVENT ALLOW MEDIUM REMOVAL command. If the Prevent and Persistent bits are both 1, upon receiving this command, the logical unit *shall* disable any eject mechanisms, and all media after initial drive spin up *shall* remain locked in the drive until the host issues an eject request, or the Persistent Prevent status is reset and the hardware eject mechanism again becomes available.

The Persistent Prevent status *shall* be reset upon receipt of a PREVENT ALLOW MEDIUM REMOVAL command (from the same host that originally set the Persistent Prevent state) with the Persistent bit set and the Prevent bit cleared, a bus reset, or a power reset condition.

Upon insertion of new media, under Persistent Prevent conditions, the logical unit eject controls *shall* remain functional up until the drive generates or reports a New Media event as defined in the Media Events section. After this event has been generated or reported, the media *shall* remain locked as defined above. The logical unit is allowed to morph from the no medium present state to the medium present state without explicit direction from the host.

The logical unit *shall not* report a New Media Event if the medium is removed between the generation of the Event and the next GET EVENT/STATUS NOTIFICATION command issued.

The Persistent Prevent state *shall not* prevent an eject request from the host from succeeding.

See 15.2, "Morphing commands and functionality" on page 518 for more information.

The behavior of the PREVENT ALLOW MEDIUM REMOVAL command with a Persistent bit of 0 is not affected by the Persistent Prevent state. The prevention of medium removal *shall* begin when the host issues a PREVENT ALLOW

MEDIUM REMOVAL command with a Prevent bit of one and a Persistent bit of zero (medium removal prevented). The prevention of medium removal for the logical unit *shall* terminate:

1. after the host has issued a PREVENT ALLOW MEDIUM REMOVAL command with a prevent bit of zero (Unlock), and the logical unit has successfully performed a Flush cache operation; or
2. upon a Hard Reset condition; or
3. upon a DEVICE RESET in an ATAPI environment; or
4. if the drive does not support a locking mechanism.

While a prevention of medium removal condition is in effect (Locked) the logical unit *shall* inhibit mechanisms that normally allow removal of the medium by an operator. This is also the case for changers.

The default state of the drive at power on is unlocked, unless the drive supports a prevent/allow jumper and the jumper is in the prevent state (See 17.11.3.6, "C/DVD Capabilities and Mechanical Status mode page" on page 686.)

This command will affect the actions of the START STOP UNIT command (See 17.43, "START STOP UNIT command" on page 895) and other mechanisms external to this specification (manual ejection / media removal systems.)

Table 551 - Actions for Lock/Unlock/Eject (Persistent bit = 0)

Operation	Locked / Unlocked	If logical unit NOT READY (No Media)	If logical unit READY (Media Present)
Unlock (Prevent = 0)	Unlocked	No Error	No Error
	Locked	No Error, Now media may be inserted	No Error, Now media may be removed
Lock (Prevent = 1)	Unlocked	No Error, Logical unit door locked and will not allow media to be inserted	No Error, Logical unit door locked and will not allow media to be removed
	Locked	No Error	No Error
Lock when the drive does not support a Locking Mechanism	Would always be Unlocked	CHECK CONDITION status, 5/24/00 INVALID FIELD IN CDB	CHECK CONDITION status, 5/24/00 INVALID FIELD IN CDB
Eject (START STOP UNIT command with LoEj set)	Unlocked	No Error and Tray is opened if a tray exists.	No Error: Media Ejects
	Locked	CHECK CONDITION status, 2/53/02 MEDIUM REMOVAL PREVENTED	CHECK CONDITION status, 5/53/02 MEDIUM REMOVAL PREVENTED
Manual Eject	Unlocked	Tray opens (If tray exists)	Media is Ejected
	Locked	No operation occurs	No operation, Media stays locked in drive

Table 552 describes errors that may occur during the operation of the command or which may cause a CHECK CONDITION status to be reported.

Table 552 - PREVENT ALLOW MEDIUM REMOVAL command errors

Error Description
A-1.1, "Deferred Error Reporting" on page 919
Table 835 - Basic Error Codes on page 932
Table 836 - Media Access Error Codes on page 935

17.16 READ (10) command

The READ (10) command requests that the logical unit transfer data to the host. The most recent data value written in the addressed logical block *shall* be returned. Any read by the host to a Logical Block with a Title Key present in the sector (DVD-ROM media Only), when the Authentication Success Flag (ASF) is set to zero *shall* be blocked. The command *shall* be terminated with CHECK CONDITION status, 5/6F/03 READ OF SCRAMBLED SECTOR WITHOUT AUTHENTICATION. For more information on the authentication process, see Figure 17 - *Device Key Exchange and Authentication State Diagram* on page 109. For more information on the Authentication Success Flag, see Figure 18 - *Authentication Flag Sequence* on page 109.

If Enhanced Defect Reporting Feature (0029h) is current, the logical unit *shall* follow the setting of the PER bit and the EMCDDR field in Read-Write Error Recovery mode page. See 10.0, "Logical unit assisted software defect management model" on page 477.

Table 553 - READ (10) Command Descriptor Block

Bit Byte	7	6	5	4	3	2	1	0
0	Operation Code (28h)							
1	Restricted (See SBC-2)			DPO (0)	FUA	Reserved	Restricted (See SBC-2)	Obsolete
2	(MSB) Logical Block Address (LSB)							
3								
4								
5								
6								
7	(MSB) Transfer Length (LSB)							
8								
9	Vendor-Specific	Reserved			NACA	Flag	Link	
10	PAD							
11								

The Disable Page Out (DPO) bit is not used by logical units and *shall* be set to zero. A DPO bit of zero indicates the priority *shall* be determined by the retention priority fields in the Cache Page if supported. All other aspects of the algorithm implementing the cache memory replacement strategy are vendor specific.

A Force Unit Access (FUA) bit of one indicates that the logical unit *shall* access the media in performing the command. Read commands *shall* access the specified logical blocks from the media (i.e. the data is not directly retrieved from the cache). In the case where the cache contains a more recent version of a logical block than the media, the logical block *shall* first be written to the media.

An FUA bit of zero indicates that the logical unit may satisfy the command by accessing the cache memory. For read operations, any logical blocks that are contained in the cache memory may be transferred to the host directly from the cache memory.

The Transfer Length field specifies the number of contiguous logical blocks of data that *shall* be transferred. A Transfer Length of zero indicates that no logical blocks *shall* be transferred. This condition *shall not* be considered an error. Any other value indicates the number of logical blocks that *shall* be transferred.

When Restricted Overwrite method is performed (Restricted Overwrite Feature (0026h) or Rigid Restricted Overwrite Feature (002Ch)), READ (10) command or READ (12) command *shall* be performed normally after data in buffer is written on the disc.

Although the logical unit is capable of returning a variety of data, this command *shall* only return the “User Data” portion of the sector. Currently for HD DVD, DVD and CD media this length is 2 048 bytes, and is specified according to the Feature that is currently active (e.g., the Random Readable Feature, see 17.4.2.6, “Feature 0010h: Random Readable” on page 573).

For CD media, Mode 1 and Mode 2 Form 1 sectors are the only sector types allowed for reading with the READ (10) or READ (12) commands. For all other sector types, the logical unit *shall* set the ILI bit in the Request Sense Standard Data and return CHECK CONDITION status, 5/64/00 ILLEGAL MODE FOR THIS TRACK error if any read to them using this command is attempted.

For DVD media, all the sectors are of the same type, thus the user data portion of any sector in the user area of the media can be read with this command.

Not Ready error may be reported to READ command. For example while writing is occurring, if READ (10) command or READ (12) command cannot be terminated immediately due to insufficient buffer capacity, the logical unit may terminate the READ command with CHECK CONDITION status, 2/04/07 LOGICAL UNIT NOT READY, OPERATION IN PROGRESS or 2/04/08 LOGICAL UNIT NOT READY, LONG WRITE IN PROGRESS. The host *shall* issue the same READ command again. After logical unit becomes ready due to sufficient buffer capacity for the READ command, the READ command *shall* be performed normally.

Table 554 describes errors that may occur during the operation of the command or which may cause a CHECK CONDITION status to be reported.

Table 554 - READ (10) command errors

Error Description
<i>A-1.1, "Deferred Error Reporting" on page 919</i>
<i>Table 835 - Basic Error Codes on page 932</i>
<i>Table 836 - Media Access Error Codes on page 935</i>

17.17 READ (12) command

The READ (12) command requests that the logical unit transfer data to the host. The most recent data value written in the addressed logical block *shall* be returned. Any read by the host to a Logical Block with a Title Key present in the sector (DVD-ROM media only), when the Authentication Success Flag (ASF) is set to zero *shall* be blocked. The command *shall* be terminated with CHECK CONDITION status, 5/6F/03 READ OF SCRAMBLED SECTOR WITHOUT AUTHENTICATION. For more information on the authentication process, see Figure 17 - *Device Key Exchange and Authentication State Diagram* on page 109. For more information on the Authentication Success Flag, see Figure 18 - *Authentication Flag Sequence* on page 109.

If Enhanced Defect Reporting Feature is current, logical unit *shall* follow the setting of PER bit and EMCDDR field in Read-Write Error Recovery mode page. See 10.0, "Logical unit assisted software defect management model" on page 477.

Table 555 - READ (12) Command Descriptor Block

Bit Byte	7	6	5	4	3	2	1	0
0	Operation Code (A8h)							
1	Restricted (See SBC-2)			DPO (0)	FUA	Reserved	Restricted (See SBC-2)	Obsolete
2	Logical Block Address (MSB) (LSB)							
3								
4								
5								
6	Transfer Length (MSB) (LSB)							
7								
8								
9								
10	Streaming	Reserved		Restricted (See SBC-2)				
11	Vendor-Specific		Reserved			NACA	Flag	Link

The **Streaming** bit of one specifies that the Stream playback operation *shall* be used for the command (see 9.2, "Stream playback operation" on page 472). The **Streaming** bit of zero specifies that the conventional READ operation *shall* be used for the command. If the **Streaming** bit is set to one, the cache control Mode parameter may be ignored.

If **Streaming** bit is set to 1 and if the logical unit supports Group 3 timeout and if G3Enable bit in Timeout and Protect mode page is set to 1, the logical unit *shall* terminate this command within Group 3 timeout duration. If G3Enable bit is set to 0, this command is categorized as Group 1 timeout.

When the **Streaming** bit is set to one, the **FUA** bit *shall* be set to zero. If both the **Streaming** bit and the **FUA** bit are set to one, the logical unit *shall* terminate the command with CHECK CONDITION status, 5/24/00 INVALID FIELD IN CDB.

On DVD-R Dual Layer discs, if the **Streaming** bit is set to one, the logical unit *shall* restrain from remapping operation and transfer the data from the original physical blocks on the medium. If the block is unreadable or uncorrectable, the erroneous data or Null data may be returned instead.

See 17.16, "READ (10) command" on page 707 for a description of the parameters for this command.

See Table 554 - READ (10) command errors on page 708 for information on the error conditions.

17.18 READ BUFFER command

The READ BUFFER command is used in conjunction with the WRITE BUFFER command as a diagnostic function for testing logical unit memory in the target SCSI device and the integrity of the service delivery subsystem. This command *shall not* alter the medium.

Table 556 - READ BUFFER Command Descriptor Block

Bit Byte	7	6	5	4	3	2	1	0
0	Operation Code (3Ch)							
1	LUN (Obsolete)				Mode			
2	Buffer ID							
3	(MSB)							
4	Buffer offset							
5	(LSB)							
6	(MSB)							
7	Allocation length							
8	(LSB)							
9	Vendor-Specific	Reserved			NACA	Flag	Link	
10	PAD							
11	PAD							

If reservations are active, they *shall* affect the execution of the READ BUFFER command as follows. A reservation conflict *shall* occur when a READ BUFFER command is received from a host other than the one holding a logical unit or element reservation.

The function of this command and the meaning of fields within the command descriptor block depend on the contents of the Mode field. The Mode field is defined in Table 557.

Table 557 - READ BUFFER Mode field

Mode	Description	Implementation requirements
00000b	Combined header and data	Optional
00001b	Vendor-specific	Vendor-specific
00010b	Data	Optional
00011b	Descriptor	Optional
00100b	Reserved	Reserved
00101b	Reserved	Reserved
00110b	Reserved	Reserved
00111b	Reserved	Reserved

Note: In the previous version of this specification, the length of the Mode field was 3-bit.

17.18.1 Combined header and data mode (00000b)

In this mode, a four-byte header followed by data bytes is returned to the host in the Data-In Buffer. The Buffer ID and the Buffer offset fields are reserved.

The four-byte READ BUFFER header (see Table 558) is followed by data bytes from the buffer.

Table 558 - READ BUFFER header

bit byte	7	6	5	4	3	2	1	0
0	Reserved							
1	(MSB)							
2	Buffer Capacity							
3								

The Buffer Capacity field specifies the total number of data bytes available in the buffer. This number is not reduced to reflect the Allocation length; nor is it reduced to reflect the actual number of bytes written using the WRITE BUFFER command. Following the READ BUFFER header, the logical unit *shall* transfer data from the buffer. The logical unit *shall* terminate filling the Data-In Buffer when allocation length bytes of header plus data have been transferred or when all available header and buffer data have been transferred to the host, whichever is less.

17.18.2 Vendor-specific mode (00001b)

In this mode, the meaning of the Buffer ID, Buffer offset, and Allocation length fields are not specified by this specification.

17.18.3 Data mode (00010b)

In this mode, the Data-In Buffer is filled only with logical unit buffer data. The Buffer ID field identifies a specific buffer within the logical unit from which the data *shall* be transferred. The vendor assigns Buffer ID codes to buffers within the logical unit. Buffer ID zero *shall* be supported. If more than one buffer is supported, additional Buffer ID codes *shall* be assigned contiguously, beginning with one. Buffer ID code assignments for the READ BUFFER command *shall* be the same as for the WRITE BUFFER command. If an unsupported Buffer ID code is selected, the logical unit *shall* return CHECK CONDITION Status, 5/24/00 INVALID FIELD IN CDB.

The logical unit *shall* terminate filling the Data-In Buffer when allocation length bytes have been transferred or when all the available data from the buffer has been transferred to the host, whichever amount is less.

The Buffer offset field contains the byte offset within the specified buffer from which data *shall* be transferred. The host should conform to the offset boundary requirements returned in the READ BUFFER descriptor (see Table 559). If the logical unit is unable to accept the specified Buffer offset, it *shall* return CHECK CONDITION Status, 5/24/00 INVALID FIELD IN CDB.

17.18.4 Descriptor mode (00011b)

In this mode, a maximum of four bytes of READ BUFFER descriptor information is returned. The logical unit *shall* return the descriptor information for the buffer specified by the Buffer ID (see the description of the Buffer ID in 17.18.3). If there is no buffer associated with the specified Buffer ID, the logical unit *shall* return all zeros in the READ BUFFER descriptor. The Buffer offset field is reserved in this mode. The Allocation length should be set to four or greater. The logical unit *shall* transfer the lesser of the Allocation length or four bytes of READ BUFFER descriptor. The READ BUFFER descriptor is defined as shown in Table 559.

Table 559 - READ BUFFER descriptor

bit byte	7	6	5	4	3	2	1	0
0	Offset Boundary							
1	(MSB)							
2	Buffer Capacity							
3								

The **Offset Boundary** field returns the boundary alignment within the selected buffer for subsequent **WRITE BUFFER** and **READ BUFFER** commands. The value contained in the **Offset Boundary** field *shall* be interpreted as a power of two.

The value contained in the **Buffer offset** field of subsequent **WRITE BUFFER** and **READ BUFFER** commands should be a multiple of $2^{\text{offset boundary}}$ as shown in Table 560.

Table 560 - Buffer offset boundary

Offset Boundary	$2^{\text{Offset Boundary}}$	Buffer Offsets
00h	$2^0 = 1$	Byte boundaries
01h	$2^1 = 2$	Even-byte boundaries
02h	$2^2 = 4$	Four-byte boundaries
03h	$2^3 = 8$	Eight-byte boundaries
04h	$2^4 = 16$	16-byte boundaries
...		
FFh	Not Applicable	0 is the only supported buffer offset

The **Buffer Capacity** field *shall* return the size of the selected buffer in bytes.

*Note: In a system employing multiple hosts, a buffer may be altered between the **WRITE BUFFER** and **READ BUFFER** commands by another host. Buffer testing applications should insure that only a single host is active. Use of reservations (to all logical units on the device) or linked commands may be helpful in avoiding buffer alteration between these two commands.*

Table 561 describes errors that may occur during the operation of the command or which may cause a **CHECK CONDITION** status to be reported.

Table 561 - READ BUFFER command Errors

Error Description
A-1.1, "Deferred Error Reporting" on page 919
Table 835 - Basic Error Codes on page 932

17.19 READ BUFFER CAPACITY command

The READ BUFFER CAPACITY command checks the total length of buffer and the length of blank area.

Table 562 - READ BUFFER CAPACITY Command Descriptor Block

Bit Byte	7	6	5	4	3	2	1	0
0	Operation Code (5Ch)							
1	LUN (Obsolete)			Reserved				Block
2	Reserved							
3	Reserved							
4	Reserved							
5	Reserved							
6	Reserved							
7	(MSB) Allocation Length							(LSB)
8								
9	Vendor-Specific	Reserved			NACA	Flag	Link	
10	PAD							
11								

The logical unit reports the length of the buffer during Session at Once Recording or Track at Once Recording, or Disc at once recording.

The **Block** bit, if set to one, indicates that the host is requesting buffer data returned in blocks.

An **Allocation Length** of zero is not an error.

The READ BUFFER CAPACITY data is sent in response to this command.

Table 563 - READ BUFFER CAPACITY data when Block bit of CDB = 0

Bit Byte	7	6	5	4	3	2	1	0
0	(MSB) Data Length							(LSB)
1								
2	Reserved							
3	Reserved							
4	(MSB) Length of Buffer							(LSB)
5								
6								
7								
8	(MSB) Blank Length of Buffer							(LSB)
9								
10								
11								

The **Data Length** field defines the number of data bytes to be transferred by the logical unit. The **Data Length** value does not include the **Data Length** field itself.

The **Length of Buffer** indicates the whole capacity of the buffer in bytes.

The Blank Length of Buffer indicates the length of unused area of the buffer in bytes.

If the READ BUFFER CAPACITY command is issued in a condition except Session at Once Recording or Track at Once Recording, or Disc at once recording, the Blank Length of Buffer field may be invalid.

Table 564 - READ BUFFER CAPACITY data when Block bit of CDB = 1

Bit Byte	7	6	5	4	3	2	1	0
0	(MSB)							
1	Data Length							(LSB)
2	Reserved							
3	Reserved							Block
4	Reserved							
5								
6								
7								
8	(MSB)							
9	Available Buffer (blocks)							(LSB)
10								
11								

The Data Length field indicates the number of data bytes to be transferred by the logical unit. The Data Length value does not include the Data Length field itself.

The Available Buffer field indicates the number of blocks of buffer currently available to be written to by the host. The logical unit *shall* be able to immediately accept at least this much data for writing. If the Available Buffer becomes zero, the logical unit *shall* begin writing. The logical unit may begin writing before the Available Buffer reaches zero.

The Block bit, if set to one, indicates the current number of blocks is being returned. If set to zero, the host assumes legacy behavior of number of bytes being returned.

Table 565 describes errors that may occur during the operation of the command or which may cause a CHECK CONDITION status to be reported.

Table 565 - READ BUFFER CAPACITY command errors

Error Description
A-1.1, "Deferred Error Reporting" on page 919
Table 835 - Basic Error Codes on page 932

17.20 READ CAPACITY command

The READ CAPACITY command provides a means for the host to request information regarding the capacity of the logical unit.

This command may not report the correct capacity of the recorded data for CD-R/-RW and DVD-R/-RW, HD DVD-R media that do not have a Lead-out in the last Session or Border-out in the last Bordered Area.

Table 566 - READ CAPACITY Command Descriptor Block

Bit Byte	7	6	5	4	3	2	1	0
0	Operation Code (25h)							
1	LUN (Obsolete)			Reserved				Obsolete
2	Logical Block Address							
3								
4								
5								
6	Reserved							
7	Reserved							
8	Reserved							PMI (0)
9	Vendor-Specific	Reserved			NACA	Flag	Link	
10	PAD							
11								

The PMI bit *shall* be set to zero for Multi-Media logical units.

The Logical Block Address field *shall* be set to zero for Multi-Media logical units.

Eight bytes of READ CAPACITY data *shall* be returned to the host. The returned logical block address and the block length in bytes are those of the last logical block on the logical unit.

Table 567 - READ CAPACITY DATA

Bit Byte	7	6	5	4	3	2	1	0
0	(MSB)							
1	Logical Block Address							
2								
3								
4								
5	(MSB)							
6	Block Length							
7								
	LSB							

The Logical Block Address field identifies the last addressable user data block. If no complete session exists on the medium, this field *shall* be set to zero. For CD media, the logical unit *shall* use the AAh point found in the last Table of Contents, convert to an LBA, and subtract one. If that block is a run-out block (found on incrementally recorded CD-R and CD-RW), the logical unit *shall* subtract two. For DVD/HD DVD media, this field identifies the maximum LBA on the disc that contains the host supplied user data.

The **Block Length** field specifies, in bytes, the length of each Logical Block. For CD or DVD/HD DVD media, this value *shall* be 2 048.

Table 568 describes errors that may occur during the operation of the command or which may cause a CHECK CONDITION status to be reported.

Table 568 - READ CAPACITY command errors

Error Description
<i>A-1.1, "Deferred Error Reporting" on page 919</i>
<i>Table 835 - Basic Error Codes on page 932</i>
<i>Table 836 - Media Access Error Codes on page 935</i>

17.21 READ CD command

The READ CD command (Family) provides one standard, universal way of accessing CD data. Rather than breaking the types of data into several related commands, this command is generic to all CD data types.

This command returns any of the CD data streams, including the headers, EDC and ECC, ROM data and CD-DA data. Each type of data is enabled via the use of flags. These flags indicate which information from the CD is to be returned in the data stream. If a flag is cleared, then that particular information will not be returned. If all the flags are cleared, no data will be returned to the host and this condition is not treated as an error.

Table 569 - READ CD Command Descriptor Block

Bit Byte	7	6	5	4	3	2	1	0	
0	Operation Code (BEh)								
1	LUN (Obsolete)			Expected Sector Type			DAP	Obsolete	
2	Starting Logical Block Address (MSB) (LSB)								
3									
4									
5									
6	Transfer Length in Blocks (MSB) (LSB)								
7									
8									
9	Sync Field	Header(s) Code	User Data	EDC & ECC	Error Flag(s)	Reserved			
10	Reserved				Sub-Channel Data Selection Bits				
11	Vendor-Specific	Reserved			NACA	Flag	Link		

Digital Audio Play (DAP) is used to control error concealment when the data being read is CD-DA. If the data being read is not CD-DA, DAP *shall* be ignored. If the data being read is CD-DA and DAP is set to zero, then the user data returned to the host should not be modified by flaw obscuring mechanisms such as audio data mute and interpolate. If the data being read is CD-DA and DAP is set to one, then the user data returned to the host should be modified by flaw obscuring mechanisms such as audio data mute and interpolate.

The Expected Sector Type field is used to limit the amount of information returned to the host. If the Requested Sector(s) do not match the specified type, the command will be terminated with CHECK CONDITION status, 5/64/00 ILLEGAL MODE FOR THIS TRACK. The Sector that does not match will not be transferred to the host.

Note: The Expected Sector Type is used to generate an error and terminate the transfer when the sectors found on the media, do not match the type desired. This field has NO control of the actual number of bytes transferred.

Table 570 - READ CD, Expected Sector Type field definition

Expected Sector Type	Definition	Description
000b	Any Type (Mandatory)	No checking of the Sector Type will be performed. The logical unit <i>shall</i> terminate a command, at the sector where a transition between CD-Rom and CD-DA occurs.
001b	CD DA (Optional)	Only Red Book (CD-DA) sectors <i>shall</i> be returned. An attempt to read any other format <i>shall</i> result in the reporting of an error.
010b	Mode 1 (Mandatory)	Only Yellow Book sectors which have a “user” data field of 2 048 bytes <i>shall</i> be returned. An attempt to read any other format <i>shall</i> result in the reporting of an error.
011b	Mode 2 (Mandatory)	Only Yellow Book sectors which have a “user” data field of 2 336 bytes <i>shall</i> be returned. An attempt to read any other format <i>shall</i> result in the reporting of an error.
100b	Mode 2 Form 1 (Mandatory)	Only Green Book sectors which have a “user” data field of 2 048 <i>shall</i> be returned. An attempt to read any other format <i>shall</i> result in the reporting of an error.
101b	Mode 2 Form 2 (Mandatory)	Only Green Book sectors which have a “user” data field of 2 324 <i>shall</i> be returned. An attempt to read any other format <i>shall</i> result in the reporting of an error. The spare data is included in the user data making the size $2\ 324+4=2\ 328$.
110b-111b		Reserved

See also Figure 2 - CD-ROM sector formats on page 73.

Byte 9 is collectively identified as Flag Bits.

The Sync Field bit, when set to one indicates that the Sync Field from the sector will be included in the data stream. The data fields that are requested to be included in the data stream *shall* be contiguous. The Sync Field information (if selected) will be the first information in the data stream; all other fields will follow.

The Header(s) Code is an encoded field that indicates the Header/Subheader information to be placed in the data stream. See Table 571.

Table 571 - READ CD, Header(s) Code field definition

Header(s) Code	Definition	Description
00b	None	None of the header data <i>shall</i> be returned.
01b	HdrOnly	Only the Mode 1 or Form 1 4-byte header will be returned in the data stream.
10b	SubheaderOnly	Only the Mode 2 Form 1 or 2 Subheader will be placed into the data stream.
11b	All Headers	Both the Header and Subheader will be placed in the data stream.

The User Data bit, when set to one, indicates that the Data part of a CD Sector *shall* be returned in the data stream. When set to 1, the whole user data will be returned to the host. The setting of the Mode Select Block size and Density Code does not apply to this command, and the physical user data will be returned. If the current track is an Audio Track then the Audio Data will be returned, else the normal CD data will be returned.

The EDC & ECC bit, when set to one, indicates that the EDC and ECC (L-EC) field *shall* be included in the data stream. For Mode 1 CDs this will include the 8 bytes of pad data.

Error Flag(s) is an encoded field that indicates which (if any) of the C2 and/or Block Error data will be included in the data stream. All the field types are mandatory. If the logical unit does not support the C2 pointers (as reported in the C/DVD Capabilities and Mechanical Status mode page) the data returned *shall* be zero filled. See Table 572.

Table 572 - READ CD, Error Flag(s) field definition

Error Flags	Definition	Description
00b	None	No Error information will be included in the data stream.
01b	C2 Error Flag data	The C2 Error Flag (Pointer) bits (2 352 bits or 294 bytes) will be included in the data stream. When the C2 Error pointer bits are included in the data stream, there will be one bit for each byte in error in the sector (2 352 total). The bit ordering is from the most significant bit to the least significant bit in each byte. The first bytes in the sector will be the first bits/bytes in the data stream.
10b	C2 & Block Error Flags	Both the C2 Error Flags (2 352 bits or 294 bytes) and the Block Error Byte will be included in the data stream. The Block Error byte is the OR of all the C2 Error Flag bytes. So that the data stream will always be an even number of bytes, the Block Error byte will be padded with a byte (undefined). The Block Error byte will be first in the data stream followed by the pad byte.
11b	Reserved	Reserved for future enhancement.

The Sub-Channel Data Selection Bits field indicate which CD Sub-Channel information is to be included in the data stream, the Q information and/or the “Raw” Sub-channel information (All eight channels, one byte from each of the small frames.) If the bit is set, then that Sub-channel data will be included in the data stream to the host. See Table 573.

Table 573 - READ CD, Sub-Channel Data Selection Bits field definition

Sub-channel Data Selection	Definition	Description	Type
000b	No Sub-channel Data	No Sub-channel data will be transferred	Mandatory
001b	RAW	Raw Sub-channel data will be transferred	Optional
010b	Q	Q data will be transferred	Optional
011b	Reserved		
100b	R - W	R-W data will be transferred	Optional
101b-111b	Reserved		

Support of Sub-channel data is optional. In the case of R-W the logical unit may return the data de-interleaved and error-corrected, RAW or padded with zeros depending on the R-W Supported and R-W de-interleaved and error-corrected bits in the C/DVD Capabilities and Mechanical Status mode page. Changing the DCR bit on the Read-Write Error Recovery mode page will affect error correction of subcode data. The inclusion of the sub-channel data will only be valid for Audio sectors. See Table 574 for a description of sub-channel data.

If the Starting Logical Block Address is set to FFFFFFFFh and the **only** information requested to be placed in the data stream is the Sub-channel data and there is currently a PLAY AUDIO (10) command in process, the actual address used will be from the current location (of the Play). If the logical unit is not playing audio, the logical unit will respond with CHECK CONDITION status, 5/2C/00 COMMAND SEQUENCE ERROR.

When the Starting Logical Block Address is set to F0000000h and P-W raw data is selected, the drive returns P-W raw data from the Lead-in Area, and the current location **shall** be incremented by one. If there are no P-W data recorded in the Lead-in Area, the command **shall** be terminated with CHECK CONDITION status, 5/64/00 ILLEGAL MODE FOR THIS TRACK. If the Starting Logical Block Address is set to FFFFFFFFh after the above command, the Sub-channel data **shall** be returned from the current location within the Lead-in Area, and the current location **shall** be incremented by one. It is the responsibility of the device driver to convert this data to CD-Text format.

Table 574 - Formatted Q-subcode Data (A Total of 16 Bytes)

Byte	Description
0	Control (4 M.S. bits), ADR (4 L.S. bits)
1	Track number
2	Index number
3	Min
4	Sec
5	Frame
6	Reserved (00h)
7	AMin
8	Asec
9	AFrame
10	CRC ^a or 00h (hex)
11	CRC ^a or 00h (hex)
12	00h (pad)
13	00h (pad)
14	00h (pad)
15	Most Significant Bit is P for this sector (Optional) all other bits are zero.

a. CRC is optional

Table 575 - Number of Bytes Returned Based on Data Selection Field

Data to be transferred	Flag Bits	CD-DA	Mode 1	Mode 2 non XA	Mode 2 Form 1	Mode 2 Form 2
No Data	00h	0	0	0	0	0
User Data	10h	2 352	2 048	2 336	2 048	2 328
User Data + EDC/ECC	18h	(10h)	2 336	(10h)	2 328	(10h)
Header Only	20h	(10h)	4	4	4	4
Header Only + EDC/ECC	28h	(10h)	Illegal	Illegal	Illegal	Illegal
Header & User Data	30h	(10h)	2 052	2 340	Illegal	Illegal
Header & User Data + EDC/ECC	38h	(10h)	2 340	(30h)	Illegal	Illegal
Sub Header Only	40h	(10h)	0	0	8	8
Sub Header Only + EDC/ECC	48h	(10h)	Illegal	Illegal	Illegal	Illegal
Sub Header & User Data	50h	(10h)	(10h)	(10h)	2 056	2 336
Sub Header & User Data + EDC/ECC	58h	(10h)	(18h)	(10h)	2 336	(50h)
All Headers Only	60h	(10h)	4	4	12	12
All Headers Only + EDC/ECC	68h	(10h)	Illegal	Illegal	Illegal	Illegal
All Headers & User Data	70h	(10h)	(30h)	(30h)	2 060	2 340
All Headers & User Data + EDC/ECC	78h	(10h)	(38h)	(30h)	2 340	2 340
Sync & User Data	90h	(10h)	Illegal	Illegal	Illegal	Illegal
Sync & User Data + EDC/ECC	98h	(10h)	Illegal	Illegal	Illegal	Illegal
Sync & Header Only	A0h	(10h)	16	16	16	16
Sync & Header Only + EDC/ECC	A8h	(10h)	Illegal	Illegal	Illegal	Illegal
Sync & Header & User Data	B0h	(10h)	2 064	2 352	Illegal	Illegal
Sync & Header & User Data + EDC/ECC	B8h	(10h)	2 352	(B0h)	Illegal	Illegal
Sync & Sub Header Only	C0h	(10h)	Illegal	Illegal	Illegal	Illegal
Sync & Sub Header Only + EDC/ECC	C8h	(10h)	Illegal	Illegal	Illegal	Illegal
Sync & Sub Header & User Data	D0h	(10h)	Illegal	Illegal	Illegal	Illegal
Sync & Sub Header & User Data + EDC/ECC	D8h	(10h)	Illegal	Illegal	Illegal	Illegal
Sync & All Headers Only	E0h	(10h)	16	16	24	24
Sync & All Headers Only + EDC/ECC	E8h	(10h)	Illegal	Illegal	Illegal	Illegal
Sync & All Headers & User Data	F0h	(10h)	2 064	2 352	2 072	2 352
Sync & All Headers & User Data + EDC/ECC	F8h	(10h)	2 352	(F0h)	2 352	(F0h)
Repeat All Above and Add Error Flags	02h	+294	+294	+294	+294	+294
Repeat All Above and Add Block & Error Flags	04h	+296	+296	+296	+296	+296

The lengths of the data returned from the READ CD command vary based on the type of sector that is being read and the requested fields to be returned to the host. Many combinations are possible, but most are not very useful. Table 575 specifies how the logical unit responds to many of the requests possible. Requests for transfers not specified by this table **shall not** be supported and treated as Illegal. Illegal values will cause the command to be aborted with CHECK CONDITION status, 5/24/00 INVALID FIELD IN CDB.

The Values in () indicate that the amount of data is the same as the Flag byte setting specified by the contents of the parenthesis.

Values that are shaded are most useful to the host and **shall** return the number of bytes specified if supported.

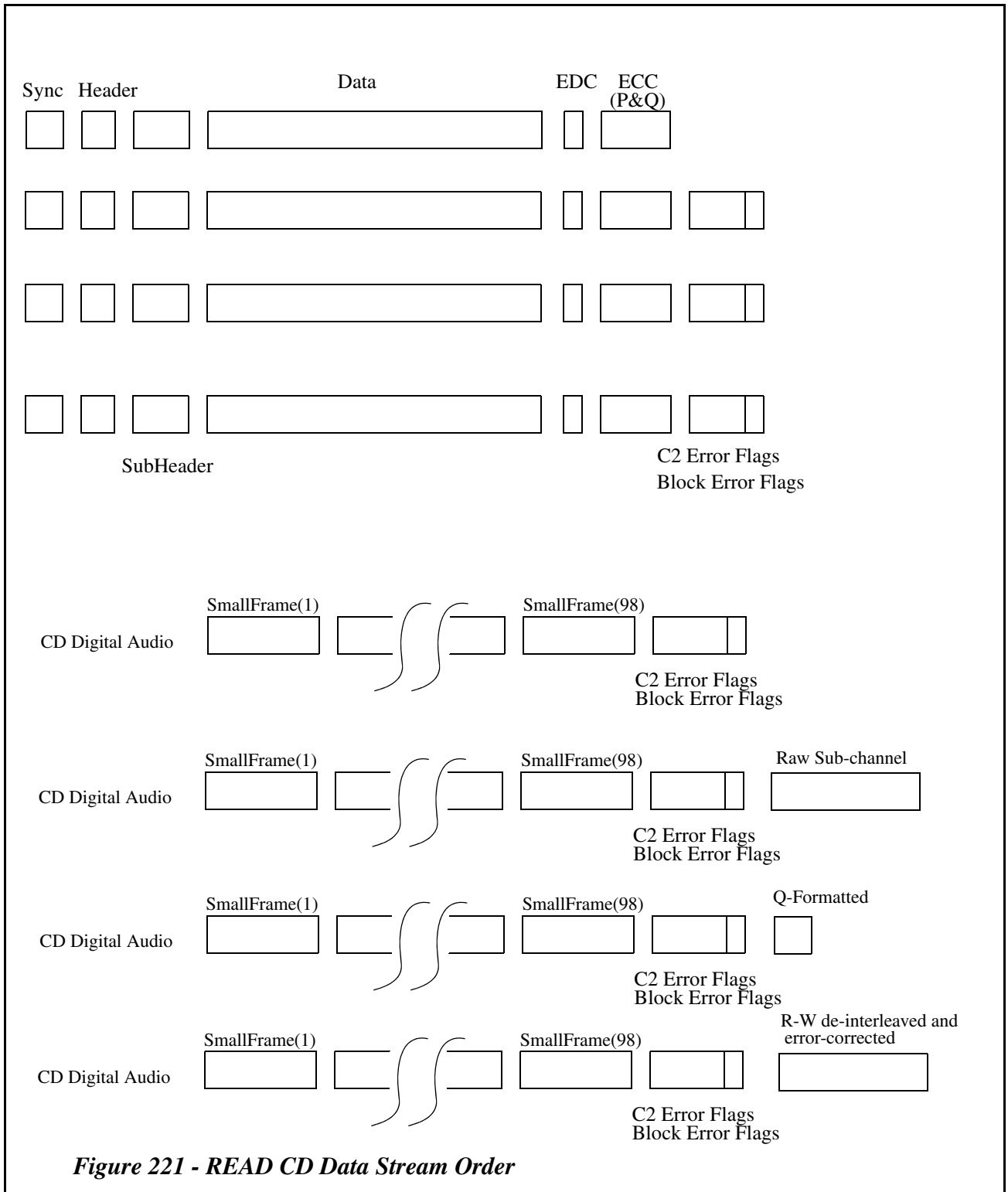
See Figure 2 - CD-ROM sector formats on page 73 for a description of the data available for each sector type.

The CD-DA audio data includes 16 bits of information for each channel, and will be formatted as follows when an audio track is read.

Table 576 - CD-DA (Digital Audio) Data Block Format

Bit Byte	7	6	5	4	3	2	1	0
Cell 1 (1st of 588)								
0	Left Channel (Lower Byte)							
	b7	b6	b5	b4	b3	b2	b1	b0
1	Left Channel (Upper Byte)							
	b15	b14	b13	b12	b11	b10	b9	b8
2	Right Channel (Lower Byte)							
	b7	b6	b5	b4	b3	b2	b1	b0
3	Right Channel (Upper Byte)							
	b15	b14	b13	b12	b11	b10	b9	b8
.	...							
.								
.								
2348	Left Channel (Lower Byte)							
	b7	b6	b5	b4	b3	b2	b1	b0
2349	Left Channel (Upper Byte)							
	b15	b14	b13	b12	b11	b10	b9	b8
2350	Right Channel (Lower Byte)							
	b7	b6	b5	b4	b3	b2	b1	b0
2351	Right Channel (Upper Byte)							
	b15	b14	b13	b12	b11	b10	b9	b8

If the CD-ROM logical unit does not support the CD-DA Stream-Is-Accurate capability (See 17.11.3.6, "C/DVD Capabilities and Mechanical Status mode page" on page 686) then the Digital Audio data *shall* be read as a continuous stream. If while streaming the logical unit *shall* stop, the logical unit *shall* generate CHECK CONDITION status, B/11/11 READ ERROR - LOSS OF STREAMING. This is due to the 1 second uncertainty of the address (There is no header in CD-DA Data). Reissuing the command may not return exactly the same data as the previous try. When the logical unit supports the Stream Accurate capability, there will be no error, only some time delay for rotational latency.



17.21.0.1 Description of Sub-channels R-W

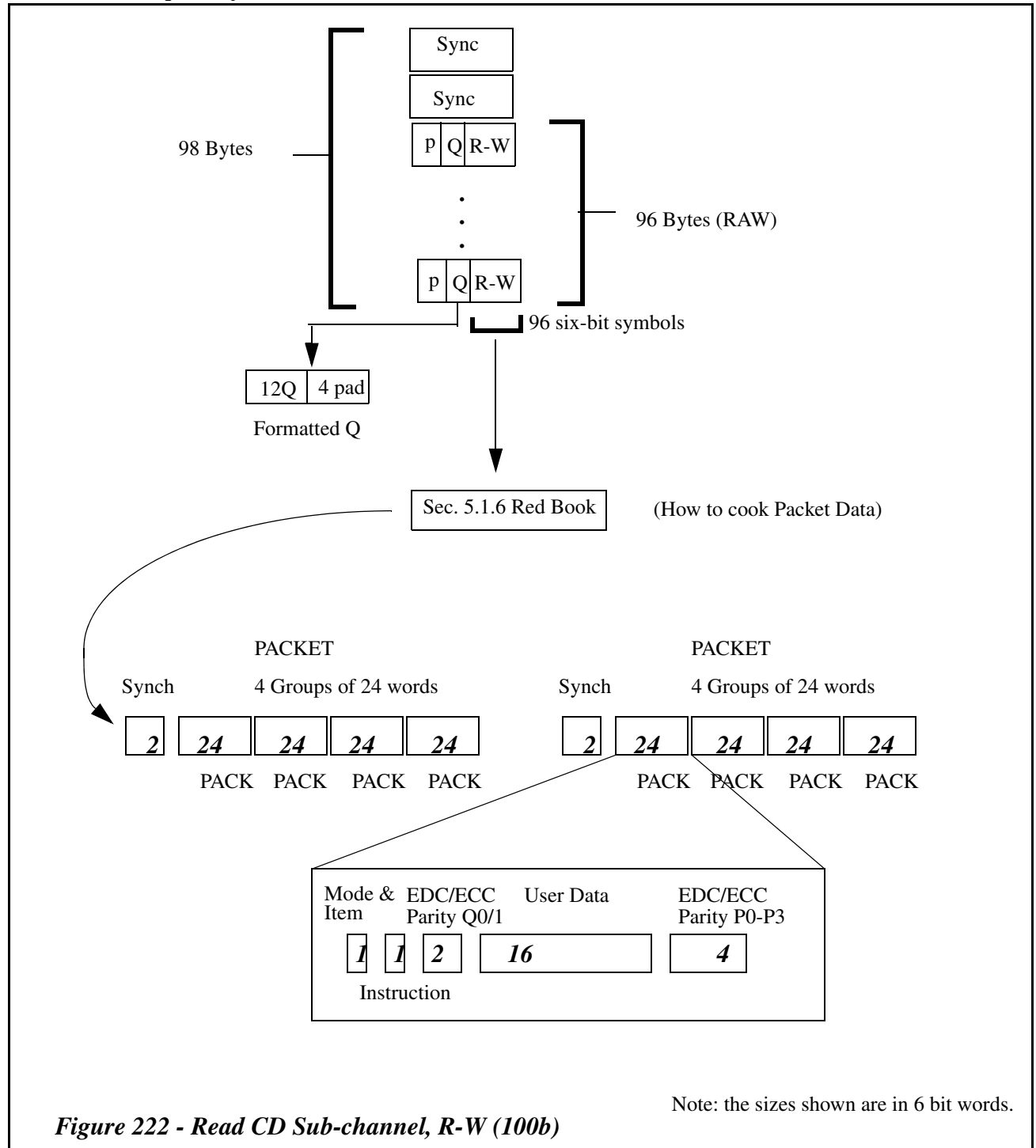


Figure 222 - Read CD Sub-channel, R-W (100b)

Note: the sizes shown are in 6 bit words.

Table 577 - P-W Raw

Bit Byte	7	6	5	4	3	2	1	0
0	P-W (0)							
1	P-W (1)							
...	...							
95	P-W (95)							

P-W Raw is returned in the format and order found on the media. It is the responsibility of the host to deinterleave and perform error detection and correction on the RAW data to make it usable to higher level applications. The P and Q bits may be set to 0 or read from the medium.

Table 578 - R-W De-Interleaved & Error Corrected

Bit Byte	7	6	5	4	3	2	1	0
0	P	Q	PACK1(0)					
1	P	Q	PACK1(1)					
...	...							
23	P	Q	PACK1(23)					
24	P	Q	PACK2(0)					
25	P	Q	PACK2(1)					
...	...							
47	P	Q	PACK2(23)					
48	P	Q	PACK3(0)					
49	P	Q	PACK3(1)					
...	...							
71	P	Q	PACK3(23)					
72	P	Q	PACK4(0)					
73	P	Q	PACK4(1)					
...	...							
95	P	Q	PACK4(23)					

logical units that can not return P or Q code with PACK data will return 0 in the unsupported P or Q bits. Each PACK is generated after 2 contiguous Sub Channel data frames consisting of 24 bytes with 6 bits of PACK data per byte. Each 96 byte Packet consists of 4 PACKs of 24 bytes each.

The basic RAW format is shown in Figure 222 - *Read CD Sub-channel, R-W (100b)* on page 726. The data is synchronized with the subcode synch patterns S0 and S1. Each group of 6 bits (R-W) is called a “symbol”. The symbol following the synchs S0 and S1 is the first symbol of the first pack in a packet. The packs following the sync bytes in R-W data *shall* be from the same block and in chronological order.

To guard the data in the subcoding channels R-W, a (24,20) Reed-Solomon Error Correction Code is used. To improve the burst error correction capability, eight-way interleaving is added to this error correction system.

The first two symbols in a pack have additional protection with a (4,2) Read-Solomon Error Correction Code. The first symbol of a pack contains a mode-switch of 3 bits and a 3-bit subdivision of mode, called “item.” The defined mode-item combinations are defined in the following table.

Table 579 - Sub-channel R-W, Allowed Mode/Item Combinations

Mode	Item	Description
000b (0d)	000b (0d)	The ZERO mode
001b (1d)	000b (0d)	The LINE GRAPHICS mode
	001b (1d)	The TV GRAPHICS mode
111b (7d)	000b (0d)	The USER mode
All Others		Reserved for future use

The R-W information is returned as part of the “raw” sub-channel data. The lower 6 bits of each of the bytes contain the R-W data. This data follows the format shown in Figure 222 - *Read CD Sub-channel, R-W (100b)* on page 726. If the Q information needs to be taken from the raw data, then it *shall* be deinterleaved according to the Red book formats.

Table 580 describes errors that may occur during the operation of the command or which may cause a CHECK CONDITION status to be reported.

Table 580 - READ CD command errors

Error Description
<i>A-1.1, "Deferred Error Reporting" on page 919</i>
<i>Table 835 - Basic Error Codes on page 932</i>
<i>Table 836 - Media Access Error Codes on page 935</i>

17.22 READ CD MSF command

The READ CD command (Family) provides one standard, universal way of accessing CD data. Rather than breaking the types of data into several related commands, this command is generic to all CD data types.

This command returns any of the CD data streams, including the headers, EDC and ECC, ROM data and CD-DA data. Each type of data is enabled via the use of flags. These flags indicate which information from the CD is to be returned in the data stream. If a flag is cleared, then that particular information will not be returned. If all the flags are cleared, no data will be returned to the host and this condition is not treated as an error.

Table 581 - READ CD MSF Command Descriptor Block

Bit Byte	7	6	5	4	3	2	1	0	
0	Operation Code (B9h)								
1	LUN (Obsolete)			Expected Sector Type			DAP	Reserved	
2	Reserved								
3	Starting M Field								
4	Starting S Field								
5	Starting F Field								
6	Ending M Field								
7	Ending S Field								
8	Ending F Field								
9	Sync Field	Header(s) Code		User Data	EDC & ECC	Error flag(s)		Reserved	
10	Reserved					Sub-Channel Data Selection Bits			
11	Vendor-Specific		Reserved			NACA	Flag	Link	

Digital Audio Play (DAP) is used to control error concealment when the data being read is CD-DA. If the data being read is not CD-DA, DAP *shall* be ignored. If the data being read is CD-DA and DAP is set to zero, then the user data returned to the host should not be modified by flaw obscuring mechanisms such as audio data mute and interpolate. If the data being read is CD-DA and DAP is set to one, then the user data returned to the host should be modified by flaw obscuring mechanisms such as audio data mute and interpolate.

The Starting M Field, the Starting S Field, and the Starting F Field specify the absolute MSF address at which the Read operation *shall* begin. The Ending M Field, the Ending S Field, and the Ending F Field specify the absolute MSF address where the Read operation *shall* end. All contiguous sectors between the starting and the ending MSF address *shall* be read.

A starting MSF address equal to an ending MSF address prevents a read operation. This *shall not* be considered an error. If the starting MSF address is greater than the ending MSF address, the command *shall* be terminated with CHECK CONDITION status, 5/24/00 INVALID FIELD IN CDB.

If the starting address is not found, or if a NOT READY condition exists, the command *shall* be terminated with CHECK CONDITION status.

See 17.21, "READ CD command" on page 719 for a description of Expected Sector Type, Sync Field, Header(s) Code, User Data, EDC & ECC, Error Flag(s), and Sub-Channel Data Selection Bits fields.

Table 582 describes errors that may occur during the operation of the command or which may cause a CHECK CONDITION status to be reported.

Table 582 - READ CD command errors

Error Description
<i>A-1.1, "Deferred Error Reporting" on page 919</i>
<i>Table 835 - Basic Error Codes on page 932</i>
<i>Table 836 - Media Access Error Codes on page 935</i>

17.23 READ DISC INFORMATION command

The READ DISC INFORMATION command provides information about all discs and requests that the logical unit transfer general information about the medium that is mounted to the host. The parameters returned by the logical unit are specific to the media that is currently installed in the logical unit. In the case of a DVD read-only logical unit, the disc information returned may be for the last closed Session/Border. In the case of media that does not have logical Tracks, the number of RZones and Borders is considered one. If this command is required by an implemented Feature, this command *shall* function even if that Feature's Current bit becomes zero.

If this command is issued during a long immediate operation, e.g., CLOSE TRACK/SESSION operation, the logical unit *shall* return NOT READY status with CHECK CONDITION Status, 2/04/07 LOGICAL UNIT NOT READY, OPERATION IN PROGRESS.

Table 583 - READ DISC INFORMATION Command Descriptor Block

Bit Byte	7	6	5	4	3	2	1	0
0	Operation Code (51h)							
1	LUN (Obsolete)			Reserved		Data Type		
2	Reserved							
3	Reserved							
4	Reserved							
5	Reserved							
6	Reserved							
7	(MSB) Allocation Length (LSB)							
8								
9	Vendor-Specific		Reserved		NACA	Flag	Link	
10	PAD							
11								

The Data Type field indicates the type of information that is requested to be sent to the host. See Table 584.

Table 584 - Data Type field definition

Data Type	Definition
000b	Standard Disc Information
001b	Track Resources Information
010b	POW Resources Information (See MMC)
011b-111b	Reserved

When this field is set to 000b, it requests the logical unit to transfer the Disc Information Block data shown in Table 585 with Disc Information Data Type field set to 000b. When this field is set to 001b, it requests the logical unit to transfer Track Resources information defined in Table 592. If the TRIO bit in Incremental Streaming Writable Feature Descriptor is set to one, the Data Type field value of 001b *shall* be supported. It is recommended to check the Disc Information Data Type field of the data that is sent by logical unit. If logical unit does not support the Data Type field, Disc Information Data Type field is set to incorrect value (e.g., zero).

The number of information bytes returned is limited by the Allocation Length parameter of the CDB. An Allocation Length of zero *shall not* be considered an error. If the Allocation Length is greater than the amount of available information bytes, only the available data will be transferred.

17.23.1 Disc Information Block data

This information reports the disc information of the mounted medium. The structure of the Disc Information Block is defined in Table 585.

Table 585 - Disc Information Block

Bit Byte	7	6	5	4	3	2	1	0
0	(MSB) Data Information Length (LSB)							
1								
Information Block								
2	Disc Information Data Type			Erasable	Status of Last Session		Disc Status	
3	First Track number on Disc							
4	Number of Sessions (LSB)							
5	First Track Number in Last Session (LSB)							
6	Last Track Number in Last Session (LSB)							
7	DID_V ^a	DBC_V ^a	URU	DAC_V	Reserved	Dbit	BG Format Status	
8	Disc Type ^a							
9	Number of Sessions (MSB)							
10	First Track Number in Last Session (MSB)							
11	Last Track Number in Last Session (MSB)							
12	(MSB) Disc Identification ^a (LSB)							
13								
14								
15								
16	(MSB) Lead-in Start Time of Last Session ^a (LSB)							
17								
18								
19								
20	(MSB) Last Possible Start Time for Start of Lead-out ^a (LSB)							
21								
22								
23								
24	(MSB) Disc Bar Code ^a (LSB)							
:								
31								
32	Disc Application Code							
33	Number of OPC Table Entries (Obsolete) ^b							
34-n	OPC Table Entries (Obsolete)							

a. Inapplicable field for non-CD media. Shall be set to zero.

b. Logical unit should transfer Number of OPC Table Entries (Obsolete) filed with Zero value.

The invalid field for corresponded media *shall* be set to zero.

The Data Information Length is the number of bytes available in both the recording information area and the appended OPC table. Data Information Length excludes itself.

The Disc Information Data Type field indicates the type of information be sent to the host. This field *shall* be set to 000b for Disc Information Block.

The Erasable bit, when set to 1, indicates that a rewritable medium is present. Otherwise, such a medium is not present. The Status of Last Session field definition is given by Table 586¹.

Table 586 - Status of Last Session field definition

Status of Last Session field code	Description
00b	Empty Session/Border: On sequential recording media ^a , this code indicates that the last Session/Border is Empty state. For the other media, this code is reserved.
01b	Incomplete Session/Border: On sequential recording media, this code indicates that the last Session/Border is Incomplete state. On restricted overwrite media ^b , this code indicates that the last Border is Intermediate state ^c . For the other media, this code is reserved.
10b	Damaged Border or Finalization suspended: On DVD-R, DVD-RW and HD DVD-RW media, this code indicates that the last Bordered area is damaged. On HD DVD-R DL media, this code indicates that the finalization of the disc is suspended. For the other media, this code is reserved.
11b	Complete Session/Border: On sequential recording media, this code indicates that the last Session/Border is Complete state. On restricted overwrite media, if the last Border is Complete state, this code is returned. For the other media ^d , this code is returned.

- a. E.g., CD-R, DVD-R, DVD-RW with sequential recording mode and HD DVD-R media
- b. E.g., DVD-RW media with restricted overwrite mode
- c. If the disc is Intermediate state, this code is returned even if user data is not recorded.
- d. E.g., DVD-RAM media

The Disc Status field indicates the status of the disc and is shown in Table 587². The logical unit which does not have the ability to write for the inserted medium (e.g., a read-only Multi-Media logical unit) will return “Complete”(10b) status.

When the Status of Last Session field value is 11b, the returned value of the Disc Status field value *shall* be either 10b or 11b.

For DVD-RW and HD DVD-RW media, if the Status of Last Session field value is 10b, the returned value of the Disc Status field value *shall* be 01b.

1. Caution: The returned code for the media that is not defined in this specification (e.g., DVD+RW, DVD+R, BD) may be different from the definition described in Table 586. See MMC.
2. Caution: The returned code for the media that is not defined in this specification (e.g., DVD+RW, DVD+R, BD) may be different from the definition described in Table 587. See MMC.

Table 587 - Disc Status field definition

Disc Status code	Description
00b	Empty disc: On sequential recording media ^a , this code indicates that user data is not recorded. For the other media, this code is reserved.
01b	Incomplete disc: On sequential recording media, this code indicates that the disc is partially recorded and user data is appendable on the medium. On restricted overwrite media ^b , if the disc is Intermediate state, this code is returned regardless of write protection status. For the other media, this code is reserved.
10b	Complete disc: This code indicates that user data is not appendable on the medium. On sequential recording media, the disc is finalized and the next Session/Border is not allowed. On restricted overwrite media, if the disc is Complete state, this code is returned regardless of write protection status. For the other media, if the disc is not writable (e.g., the disc may be write-protected) or the disc is stamped (ROM), this code is returned.
11b	Finalization suspended disc: On HD DVD-R DL media, this code indicates that the finalization is suspended. Others: This code indicates that the medium is neither sequential recording medium nor restricted overwrite media and the disc is not write-protected. On sequential recording media and restricted overwrite media, this code is reserved except HD DVD-R DL.

a. E.g., CD-R, DVD-R, DVD-RW with sequential recording mode or HD DVD-R media

b. E.g., DVD-RW media with restricted overwrite mode

The Number of First Track on Disc field:

For non-CD media, this field *shall* be set to 1.

For CD media,

1. If Disc Status field is set to 00b (Empty Disc), the Number of First Track number on Disc field *shall* be 1.
2. If there are no entries in the PMA and the first track is an Incomplete Track, the Number of First Track on Disc field *shall* be equal to 1.
3. If the only session on the disc is an Incomplete Session, the Number of First Track on Disc field is from the PMA.
4. Otherwise, the Number of First Track on Disc field contains the Track number for the first TOC entry in the first Session.

The Number of Sessions on the disc refers to all complete Sessions/Borders plus any incomplete or empty Sessions/Borders. This field *shall* be set to 1 for a blank disc.

The First Track Number in Last Session field (bytes 5 & 10) is the track/RZone number of the first Track/RZone in the last session/Border. In order for Track/RZones in the last Session/Border, that may be open, to be scanned by the READ TRACK INFORMATION command, the First Track Number in Last Session is identified. This is inclusive of the Invisible Track/RZone.

The Last Track Number in Last Session field (bytes 6 & 11) is the track/RZone number of the last track/RZone in the last session/Border. In order for Track/RZones in the last Session/Border, that may be open, to be scanned by READ TRACK INFORMATION command, the Last Track Number in Last Session is identified. This is inclusive of the invisible track/RZone.

The Disc Identification Valid (DID_V) bit specifies the validity of the Disc Identification field. If it is set to one, then the Disc Identification field is valid. Otherwise, it is invalid.

The Disc Bar Code Valid (DBC_V) bit specifies the validity of the Disc Bar Code field. If it is set to one, then the Disc Bar Code field is valid. Otherwise, it is invalid.

The Unrestricted Use Disc (URU) bit, when set to one, indicates that the mounted DVD-R, CD-R or CD-RW disc is defined for unrestricted use. When the URU bit is set to zero, the mounted DVD-R, CD-R or CD-RW disc is defined for restricted use. To record data to the mounted disc the appropriate Host Application code *shall* be set through the Write Parameters mode page. A Host Application Code of zero may be used to indicate a restricted use disc - general purpose. Logical units that cannot determine the state of the URU bit from the medium should set this bit to one. For HD DVD-R, this bit *shall* be set to one.

The BG Format Status field indicates Fragment recording format status on HD DVD-RW. This field is valid for HD DVD-RW media. The definition is shown in Table 588. For all other media, this field is not valid. In any state except for Intermediate state in Fragment recording mode and Full-finalized state, this field *shall* be set to 00b. If a logical unit does not support Background Padding operation, this field *shall* be set to 01b when the disc state is Intermediate state in Fragment recording mode.

Note: This field may be valid for DVD+R/+RW media and +MRW formatted CD-RW media that are not specified in this specification. See MMC.

Table 588 - BG Format Status field definition

BG Format Status	Definition
00b	The disc is in Empty state or any state in Sequential formatting mode.
01b	Background Padding was started but is not currently running and is not complete.
10b	Background Padding is in progress. Background Padding has been started and is not yet completed.
11b	Background Padding has completed. The disc is in Full-finalized state.

For CD, the Disc Type specifies the type of the data on the whole disc. A disc has only one disc type. The disc type is recorded in the A0/PSEC field in the TOC of the first session in which there is at least one data track, or is recorded together with disc ID in PMA. In the case of a session that contains no data tracks (only audio), A0/PSEC field in the TOC of the session is always 00h regardless of actual disc type. For CD disc, the Disc type *shall* be determined from the following sequence:

1. Disc ID (Disc Type) as written in PMA.
2. From the first Complete Session that includes at least one data track.
3. From the first session of a Complete Disc (not appendable).
4. The Disc type is NOT decided, the Disc Type field of Disc Information Block *shall* contain FFh.

Table 589 - Disc Type field definition

Disc Type code	Disc Type
00h	CD-DA or CD-ROM disc
10h	CD-I disc
20h	CD-ROM XA disc
FFh	Undefined
All other values	Reserved

For CD, the Disc Identification Number field returns Disc Identification Number that is recorded in the PMA. The Disc Identification Number is recorded in the PMA as a six-digit BCD number. It is returned in the Disc Information Block as a 32 bit binary integer.

The Lead-in Start Time of Last Session field is valid only for CD medium. Otherwise, this field *shall* be set to all 00h. This field indicates the location of the next Lead-in to be recorded. If the disc is Empty as specified in the Disc Status field or has no Complete Session, then the Lead-in Start Time of Last Session is set to the address encoded in the ATIP. If the last session, which is the second or greater, is an Empty or Incomplete Session, this field *shall* be set to the B0 pointer of the previous session - 60 seconds. If the Disc Status is Complete, the Lead-in Start Time of Last Session field *shall* be filled with FFh. The Lead-in Start Time of Last Session is given in the MSF format.

The Last Possible Start Time for Start of Lead-out field is valid only for CD media. Otherwise this field *shall* be set to all 00h. If the disc is a Complete disc, the Last Possible Start Time of Lead-out field is filled with FFh. The Last Possible Start Time for Start of Lead-out is returned as the address encoded in the ATIP and it is given in MSF format.

Disc Bar Code field is valid only for CD medium. Otherwise, this field *shall* be set to all 00h. If the logical unit has the ability to read Disc Bar Code and a bar code is present, then the Disc Bar Code field contains the 12 hex digits of the bar code.

The Number of OPC Table Entries field is obsolete and is not used anymore. This field *shall* be set to 00h. No OPC Table Entries (Obsolete) *shall* be returned. Original definition is as follows.

An OPC (Optimum Power Calibration) Table is attached only if the values are known for the mounted disc. Since OPC values are likely to be different for different recording speeds, each table entry is associated with a recording speed. The Number of OPC Table Entries (Obsolete) is used to compute the number of bytes that will follow. The number of bytes that follow will be the number of entries times 8. This number *shall* be the same for all values of Allocation Length.

Note: The Number of OPC Table Entries (Obsolete) is zero for CD-ROM, DVD-ROM, DVD-RAM, HD DVD-RAM and HD DVD-RW discs and for CD-R/RW discs for which OPC have not yet been determined. For DVD-R/RW and HD DVD-R/RW, the use of OPC table entries is vendor-specific.

Table 590 - OPC Table Entry (Obsoleted)

Bit Byte	7	6	5	4	3	2	1	0
0	(MSB) Speed (LSB)							
1								
2	(MSB) OPC Value (LSB)							
3								
4								
5								
6								
7								

The **Speed** field indicates the speed for which this OPC value is valid. This value is the number of kilobytes per/second (Speed/1000) that the data is read from the logical unit.

Table 591 - Example Data Rates

Speed	CD (ROM/R/RW) Data Rate
1×	176 kBytes/second
2×	353 kBytes/second
4×	706 kBytes/second
8×	1 400 kBytes/second
16×	2 800 kBytes/second

The **OPC Value** field is associated with given speed and its contents are vendor specific.

17.23.2 Track Resources Information

This information reports the Track resources information of the mounted medium via Table 592 - *Track Resources Information Block* on page 738.

Table 592 shows the definition of the Track Resources information.

Table 592 - Track Resources Information Block

Bit Byte	7	6	5	4	3	2	1	0
0	(MSB) Data Information Length (LSB)							
1								
Information Block								
2	Disc Information Data Type			Reserved				
3	Reserved							
4	(MSB) Maximum possible number of the Tracks on the disc (LSB)							
5								
6	(MSB) Number of the assigned Tracks on the disc (LSB)							
7								
8	(MSB) Maximum possible number of appendable Tracks on the disc (LSB)							
9								
10	(MSB) Current number of appendable Tracks on the disc (LSB)							
11								

The Data Information Length is the number of bytes transferred to host. Data Information Length excludes itself.

The Disc Information Data Type field indicates the type of information be sent to the host. This field *shall* be set to 001b for Track Resources information.

Maximum possible number of the Tracks on the disc field indicates the possible maximum number of track that can be assigned to the disc. In case of CD, this value is 99. In case of DVD, this value may be number of current existing RZones plus number of remaining empty ECC blocks in RMA.

Number of the assigned Tracks on the disc field indicates number of current existing Tracks/RZones.

Maximum possible number of appendable Tracks on the disc field indicates the possible maximum number of appendable Tracks that can have NWA on the disc.

Table 593 - Maximum possible number of appendable Tracks value

Media	Value
CD-R/CD-RW	{99 - (number of closed tracks)}
DVD-R SL/DVD-RW SL (Sequential recording mode)	3
DVD-R DL	4
DVD-RW DL	1
HD DVD-R	3

Current number of appendable Tracks on the disc field indicates number of current existing appendable Tracks/RZones that have NWA.

Table 594 describes errors that may occur during the operation of the command or which may cause a CHECK CONDITION status to be reported.

Table 594 - READ DISC INFORMATION command errors

Error Description
<i>A-1.1, "Deferred Error Reporting" on page 919</i>
<i>Table 835 - Basic Error Codes on page 932</i>
<i>Table 836 - Media Access Error Codes on page 935</i>

17.24 READ DISC STRUCTURE command

The READ DISC STRUCTURE command requests that the logical unit transfer data from areas on the specified media to the host.

For DVD/HD DVD media, there are several control structures, including the Lead-in and Burst Cutting Area (BCA). The Lead-in Area for DVD/HD DVD media contains information about the media as well as information used by the logical unit to allow it to recover information from the media. The BCA for DVD media is optional which contents are specified by media manufacturer.

Table 595 - READ DISC STRUCTURE Command Descriptor Block

Bit Byte	7	6	5	4	3	2	1	0
0	Operation Code (ADh)							
1	LUN (Obsolete)			Reserved	Media Type			
2	(MSB) Address (LSB)							
3								
4								
5								
6	Layer Number							
7	Format Code							
8	(MSB) Allocation Length (LSB)							
9								
10	AGID		Reserved					
11	Vendor-Specific		Reserved			NACA	Flag	Link

The **Media Type** field indicates the type of command definition to expand this command for other media type than DVD/HD DVD. This value *shall* be set to 0000b for DVD/HD DVD media.

Table 596 - Media Type field definition

Media Type value	Supported Media Type
0000b	DVD-ROM, DVD-RAM, DVD-R, DVD-RW, DVD+RW, DVD+R, HD DVD-ROM, HD DVD-R, HD DVD-RW and HD DVD-RAM media
0001b	BD-RE, BD-R, BD-ROM media, See MMC
Others	Reserved

The **Format Code** field indicates the type of information that is requested to be sent to the host.

The **Layer Number** field specifies the Layer number for which the READ DISC STRUCTURE data will be returned.

The **AGID** field is described in the REPORT KEY command. This field is used only when the **Format Code** field contains 2h, 6h, 7h (with **Address** field of 00000000h), 80h, 81h, 82h, 84h or 86h (with **Address** field of 00000000h). For all other values, it is reserved.

Requests for **Format Code** C0h - FFh *shall* be fulfilled, even if no or incompatible media is installed.

When a READ DISC STRUCTURE command is issued for media that is not supported by the **Media Type** field, with **Format Codes** 00h - BFh, this command *shall* be terminated with CHECK CONDITION status, 5/30/02 CANNOT

READ MEDIUM - INCOMPATIBLE FORMAT. When the device/media does not support specified Format Code value, this command *shall* be terminated with CHECK CONDITION status, 5/24/00 INVALID FIELD IN CDB.

In the case of DVD-R/-RW and HD DVD-R/-RW, the logical unit may have cache memory for the Lead-in Control Data. If the disc has no Lead-in and there are no structures in the cache, the logical unit *shall* generate CHECK CONDITION status, 5/24/00 INVALID FIELD IN CDB. If the Lead-in is already written or there are DISC STRUCTURE data in the cache, the logical unit *shall* return the requested structure.

The number of READ DISC STRUCTURE data bytes returned is limited by the Allocation Length field of the CDB. An Allocation Length of zero is not an error.

The Address field contains a value which depends on the value in the Format Code field. See Table 597.

Table 597 - Format Code field definitions for Media Type = 0000b

Format Code	Returned Data	Layer Byte Usage	Address field Usage	Applicable media type	Description
00h	Physical format information	Layer Number	Reserved	All DVD, All HD DVD	Returns physical format information in the DVD/HD DVD Lead-in Area ^a
01h	Copyright	Layer Number	Reserved	All DVD	Returns the Copyright information from DVD Lead-in
02h	Disc Key	Reserved	Reserved	DVD-ROM, DVD-Download	Returns the Disc Key obfuscated by using a Bus Key
03h	BCA	Reserved	Reserved	All DVD, All HD DVD	Returns the BCA information on DVD/HD DVD media
04h	Manufacturer's information	Layer Number	Reserved	All DVD, All HD DVD	Returns the Disc Manufacturing information from DVD/HD DVD Lead-in
05h	Copyright Management	Reserved	LBA (Logical Block Address)	All DVD	Returns Copyright Management information from specified sector
06h	Media Identifier	Reserved	Reserved	DVD with CPRM supported	Returns the Media Identifier protected by using a Bus Key
07h	Media Key Block	Reserved	Pack Number	DVD with CPRM supported	Returns the Media Key Block protected by using a Bus Key
08h	DDS	Reserved	Reserved	DVD-RAM, HD DVD-RAM	Returns the DDS information on DVD-RAM/HD DVD-RAM media
09h	DVD-RAM/HD DVD-RAM Medium status	Reserved	Reserved	DVD-RAM, HD DVD-RAM	Returns the medium status information on DVD-RAM/HD DVD-RAM media
0Ah	Spare Area Information	Reserved	Reserved	DVD-RAM, HD DVD-RAM	Returns the Spare Area information for the media
0Bh	Recording Type Information	Reserved	LBA (Logical Block Address)	DVD-RAM, HD DVD-RAM	Returns Recording Type information from specified sector
0Ch	RMD in the last Border-out	Reserved	Start Field Number of RMD block ^b	DVD-R, HD DVD-R SL	Returns the Field of RMD in the last Border-out
0Dh	RMD	Reserved	Start RMA Sector Number ^c	DVD-R	Returns RMD sectors which are recorded in RMA
0Eh	Pre-recorded information in Lead-in	Reserved	Reserved	DVD-R	Returns Pre-recorded information in Lead-in
0Fh	Unique Disc Identifier	Reserved	Reserved	DVD-R, DVD-RW, HD DVD-R, HD DVD-RW	Returns Unique Disc Identifier of the disc

Table 597 - Format Code field definitions for Media Type = 0000b (continued)

Format Code	Returned Data	Layer Byte Usage	Address field Usage	Applicable media type	Description
10h	Physical format information in the Lead-in	Layer Number	Reserved	DVD-R, DVD-RW, HD DVD-R, HD DVD-RW	Returns Physical format information of Control Data Zone in the Lead-in
11h	ADIP information	Reserved	Reserved	See MMC	See MMC
12h	HD DVD Copyright Protection Info.	Layer Number	Reserved	All HD DVD	Returns the Copyright Protection Information from HD DVD Lead-in
13h-14h	Reserved				
15h	Copyright data section	Layer Number	Start Copyright data section Sector Number ^d	All HD DVD, DVD-ROM 3×	Returns the Copyright Data Section from HD DVD Lead-in or DVD-ROM 3× adapted to AACS Lead-in
16h-18h	Reserved				
19h	HD DVD-R/-RW Medium Status	Reserved	Reserved	HD DVD-R, HD DVD-RW	Returns the medium status information on HD DVD-R or HD DVD-RW media
1Ah	Last recorded RMD in the latest RMZ	Reserved	Start Field Number of RMD block ^e	HD DVD-R, HD DVD-RW	Returns the last recorded RMD in the latest RMZ
1Bh-1Fh	Reserved				
20h	Layer Boundary Information	Reserved	Reserved	DVD-R DL, DVD-RW DL, HD DVD-R DL, HD DVD-RW DL	Returns the Layer boundary information of DVD-R DL, HD DVD-R DL and HD DVD-RW DL disc. See MMC for +R DL media.
21h	Shifted Middle Area Start Address	Reserved	Reserved	DVD-R DL, DVD-RW DL	Returns the start logical block address of the Shifted Middle Area on L0
22h	Jump Interval size	Reserved	Reserved	DVD-R DL, DVD-RW DL	Returns the Jump Interval size of Regular Interval Layer Jump recording
23h	Manual Layer Jump Address	Reserved	Reserved	DVD-R DL, DVD-RW DL	Returns the start logical block address of the Manual Layer Jump
24h	Remapping Address	Reserved	Anchor Point Number	DVD-R DL	Returns one Remapping information of the specified Anchor Point
25h-2Fh	Reserved				
30h	Disc Control Blocks	Reserved	Content Descriptor ^f	See MMC	See MMC
31h	MTA	Reserved	PSN	See MMC	See MMC
32h-7Fh	Reserved				

a. For DVD-R/-RW and HD DVD-R multi-border disc, this **Format Code** returns information in the last Border-in.

b. The **Address field** specifies the Field number of RMD block that is recorded in the last Border-out. A Field number of RMD block are integers assigned in ascending order in the range 0 to 14 for DVD, 0 to 21 for HD DVD.

c. The **Address field** specifies the sector number of RMA where the RMD read operation *shall* begin. The RMA sector size is 2 KB. The RMA sector number is assigned to each sector of RMA, including RMD Linking Loss Area. The RMA sector numbers are integers assigned in ascending order starting with zero. Each successive sector of RMA has a number increased by 1. When the **Address field** specifies an unrecorded RMA sector, this command *shall* be terminated with CHECK CONDITION status, Sense Key BLANK CHECK. Cached RMD information *shall* be returned by this command as if it had been committed to the medium. For HD DVD, this **Format Code** *shall not* be supported.

- d. The **Address** field specifies the starting address of the Copyright data section sector position where the read operation *shall* begin
- e. The **Address** field specifies a Field number of the last recorded RMD block that is recorded in the latest RMZ. Field number of the last recorded RMD block is assigned in ascending order in the range 0 to 21 for HD DVD.
- f. See MMC.

The Format Code value of 80h through BFh are used to return media format independent information. Regardless of the Media Type field value in CDB, the same information on applicable mounted media is returned to the host.

Table 598 - Format Code field definitions for media format independent information

Format Code	Returned Data	Layer Byte Usage	Address field Usage	Applicable media type	Description
80h	Volume ID of AACS	Reserved	Reserved	DVD-ROM 3×, HD DVD-ROM	Returns the Volume Identifier specified by AACS
81h	Serial Number of AACS	Reserved	Reserved	DVD-ROM 3×, HD DVD-ROM	Returns the Pre-recorded Media Serial Number specified by AACS
82h	Media ID of AACS	Reserved	Reserved	All writable DVD, All writable HD DVD	Returns the Media Identifier specified by AACS
83h	Media Key Block of AACS	Layer Number	Pack Number	All writable HD DVD	Returns the Media Key Block of AACS in Lead-in specified by AACS
84h	Data Keys	Reserved	Reserved	All DVD, All HD DVD	Returns the Data Keys specified by AACS
85h	LBA Extents	Reserved	Reserved	All writable DVD, All writable HD DVD	Returns the LBA Extents to which data is recorded with the flag for Bus Encryption specified by AACS
86h	Media Key Block of CPRM	Reserved	Pack Number	All writable DVD	Returns the Media Key Block of CPRM in Lead-in specified by AACS
87h-8Fh	Reserved				
90h	Hybrid disc structure	Reserved	Reserved	Hybrid discs	Returns the list of recognized Format-layers
91h-BFh	Reserved				

The Format Code values in the range of C0h through FEh are used to return media independent information. Regardless of the Media Type field value in the CDB, the same information is returned to the host.

For Format Code value of FFh, supported Format Codes for the specific Media Type and their length *shall* be returned according to the Media Type field value in the CDB.

Table 599 - Format Code field definitions for media independent information

Format Code	Returned Data	Layer Byte Usage	Address field Usage	Applicable media type	Description
C0h	Write Protection status	Reserved	Reserved	All ^a	Returns Write Protection Status and MSWI status
C1h-FEh	Reserved				
FFh	Structure List	Reserved	Reserved	All ^a	Returns a list of Disc Structures data present in the specified Layer.

a. All media types other than CD

The following sections 17.24.1 through 17.24.36 specifies the returned DISC STRUCTURE data for DVD/HD DVD media (Media Type = 0000b).

17.24.1 Physical Format Information (Format Code = 00h)

For DVD-R/-RW/HD DVD-R media, this Format code returns the last updated Physical format information. For example, if a medium is recorded with multi-Border, this information is retrieved from the last Border-in. To retrieve the Control Data Zone information in the Lead-in Area, Format 10h (Table 621) *shall* be used.

Physical Format Information is shown in Table 600.

Table 600 - READ DISC STRUCTURE Data format (With Format Code = 00h)

Bit Byte	7	6	5	4	3	2	1	0
0	(MSB) DISC STRUCTURE Data Length (LSB)							
1								
2	Reserved							
3	Reserved							
Physical format information								
0	Book Type				Part Version			
1	Disc Size				Maximum Rate			
2	Reserved	Number of Layers		Track Path	Layer Type			
3	Linear Density				Track Density			
4	00h							
5	(MSB) Start physical sector number of the Data area (LSB)							
6								
7								
8	00h							
9	(MSB) End physical sector number of the Data area (LSB)							
10								
11								
12	00h							
13	(MSB) End physical sector number of Layer 0 (LSB)							
14								
15								
16	BCA Flag	Reserved						
17-2 047	Media Specific							

This information is returned for DVD/HD DVD media Only. The information for the Layer specified by the **Layer Number** field in the CDB is returned. If there is only one Layer then the only valid Layer is L0. If a non-existent Layer is requested then the command *shall* be aborted with CHECK CONDITION status, 5/24/00 INVALID FIELD IN CDB. If the media has more than one Layer, but is recorded using the Opposite Track Path method, then the same information *shall* be returned for all Layers.

The DISC STRUCTURE Data Length field indicates the length in bytes of the following DISC STRUCTURE data that is available to be transferred to the host. The DISC STRUCTURE Data Length value does not include the DISC STRUCTURE Data Length field itself.

The **Book Type** field specifies with which DVD/HD DVD Book this media complies. See Table 17 - *Book Type field definition* on page 96 or Table 148 - *Book Type field definition* on page 313.

The **Part Version** specifies the version of the specified book that this media complies with.

The **Disc Size** specifies the physical size of the media. A value of 0000b specifies 120mm, a value of 0001b specifies a size of 80mm.

The **Maximum Rate** is used to specify to the logical unit the read rate to use for this media. See Table 20 - *Maximum Transfer Rate field definition* on page 97 or Table 150 - *Maximum Transfer Rate field definition* on page 314.

The **Number of Layers** field specifies the number of Layers for this side of the media. A value of 00b indicates that the media has only one Layer. A value of 01b specifies that this side of the media has two Layers. Currently only one and two Layer discs are specified.

The **Track Path** bit specifies the direction of the Layers when more than one Layer is used. If the bit is cleared to 0 then this media uses Parallel Track Path (PTP). When PTP is used each Layer is independent and has its own Lead-in and Lead-out Areas on the media. If the bit is set to 1 then the media uses Opposite Track Path (OTP). With opposite track path both Layers are tied together. There is only one Lead-in and Lead-out. In the middle of the media there is an area called the Middle Area. The addresses of blocks in one Layer are mirrored in the other Layer.

The **Layer Type** field *shall* identify the Layer according to Table 21 - *Layer Type field definition* on page 97 or Table 151 - *Layer Type field definition* on page 314.

The **Linear Density** field indicates the minimum/maximum pit length used for this Layer. See Table 22 - *Linear Density field definition* on page 97 or Table 152 - *Linear Density field definition* on page 314.

The **Track Density** field indicates the track width used for this media. See Table 23 - *Track Density field definition* on page 97 or Table 153 - *Track Density field definition* on page 315.

The **Start physical sector number of the Data area** field specifies the first PSN that contains user data. See Table 601. For HD DVD-RAM, this field indicates the starting PSN of Data Area in land track (= 030000h).

Table 601 - Starting Physical Sector Number of Data Area

Starting Sector Number	Media Type
30000h	DVD-ROM, DVD-R, DVD-RW, HD DVD-ROM, HD-DVD-R SL, HD DVD-RW SL and HD DVD-RAM
31000h	DVD-RAM
40000h	HD DVD-R DL and HD DVD-RW DL
Others	Reserved

The **End physical sector number of the Data area** field specifies the last PSN of the user Data Area in the last Layer of the media. For DVD-RAM, the **End physical sector number of the Data area** is the PSN for the last spare sector of the last zone. It should not be used for counting user capacity. For HD DVD-R, this field specifies the Outer limit of Data Recordable area. For HD DVD-RAM, this field specifies the End PSN of Data Area in land track. The value of this field is 4ED73Fh.

The **End physical sector number of Layer 0** field specifies the last PSN of the user data in L0, if the media contains multiple Layers with using the Opposite Track Path. For HD DVD-RAM, the **End physical sector number of Layer 0** field specifies offset value between start PSN of the Data Area in land track and start PSN of the Data Area in groove track. The value of this field is 800000h. In other cases, this value is set to 000000h.

The **Media Specific** field contains information as specified in the associated DVD/HD DVD specification.

The **BCA Flag** indicates the presence of data in the Burst Cutting Area. A bit of zero indicates BCA data does not exist. A bit of one indicates BCA data exist.

17.24.2 DVD Copyright Information (Format Code = 01h)

Table 602 - READ DISC STRUCTURE Data format (With Format Code = 01h)

Bit Byte	7	6	5	4	3	2	1	0
0	(MSB) DISC STRUCTURE Data Length							(LSB)
1								
2	Reserved							
3	Reserved							
DVD Copyright Information								
0	Copyright Protection System Type							
1	Region Management Information							
2	Reserved							
3	Reserved							

The DISC STRUCTURE Data Length field indicates the length in bytes of the following DISC STRUCTURE data that is available to be transferred to the host. The DISC STRUCTURE Data Length value does not include the DISC STRUCTURE Data Length field itself.

The Copyright Protection System Type field indicates the presence of data structures specific to a copyright protection system. Four values are defined, 00h indicates there is no such data, 01h indicates a specific data structure for CSS/CPM exists, 02h indicates a specific data structure for CPRM exists, and 03h indicates a specific data structure for AACS exists. All other values are reserved. Please note that this command with Format Code = 01h *shall* be applicable only to DVD discs. For HD DVD Copyright Protection Information, this command with Format Code = 12h *shall* be used.

The Region Management Information field describes the regions in which the disc can be played. Each bit represents one of eight regions. If a bit is Cleared in this field, the disc can be played in the corresponding region. If a bit is set in this field the disc cannot be played in the corresponding region.

There are currently 6 regions defined. See the DVD Book for more information.

17.24.3 DISC KEY (Format Code = 02h)

Table 603 - READ DISC STRUCTURE Data format (With Format Code = 02h)

Bit Byte	7	6	5	4	3	2	1	0
0	(MSB) DISC STRUCTURE Data Length							(LSB)
1								
2	Reserved							
3	Reserved							
Disk Key Structures								
0	(MSB) DISC KEY Data							
:								
2 047								(LSB)

The DISC STRUCTURE Data Length field indicates the length in bytes of the following DISC STRUCTURE data that is available to be transferred to the host. The DISC STRUCTURE Data Length value does not include the DISC STRUCTURE Data Length field itself.

The DISC KEY Data field returns the DISC KEY data for CSS and/or the Album Identifier for CPPM, which are obfuscated by a Bus Key. The length of the DISC KEY Data field is currently 2 048 bytes only.

When neither the DISC KEY data nor the Album Identifier exist on DVD media, this command with Format Code = 02h *shall* be terminated with CHECK CONDITION status, 5/6F/01 COPY PROTECTION KEY EXCHANGE FAILURE - KEY NOT PRESENT.

When the DVD logical unit is not in the Bus Key Established state for CSS/CPPM, this command with Format Code = 02h *shall* be terminated with CHECK CONDITION status, 5/6F/02 COPY PROTECTION KEY EXCHANGE FAILURE - KEY NOT ESTABLISHED.

17.24.4 BCA (Format Code = 03h)

Table 604 - READ DISC STRUCTURE Data format (With Format Code = 03h)

Bit Byte	7	6	5	4	3	2	1	0	
0	(MSB)							DISC STRUCTURE Data Length	(LSB)
1									
2	Reserved								
3	Reserved								
BCA Structures									
0	(MSB)							BCA Information	(LSB)
:									
N									

The DISC STRUCTURE Data Length field indicates the length in bytes of the following DISC STRUCTURE data that is available to be transferred to the host. The DISC STRUCTURE Data Length value does not include the DISC STRUCTURE Data Length field itself.

The BCA Information is returned from BCA recorded DVD/HD DVD media. The Length of BCA Information is in the range of 12 to 188 bytes for DVD. For HD DVD, the maximum Length of BCA Information is 76 bytes.

When a READ DISC STRUCTURE with a Format Code field value of 03h is presented for a DVD media without BCA, the command *shall* be terminated with CHECK CONDITION status, 5/24/00 INVALID FIELD IN CDB.

17.24.5 Disc Manufacturing Information (Format Code = 04h)

Table 605 - READ DISC STRUCTURE Data format (With Format Code = 04h)

Bit Byte	7	6	5	4	3	2	1	0
0	(MSB) DISC STRUCTURE Data Length (LSB)							
1								
2	Reserved							
3	Reserved							
Lead-in Structures								
0	Disc Manufacturing Information							
:								
2 047								

The DISC STRUCTURE Data Length field indicates the length in bytes of the following DISC STRUCTURE data that is available to be transferred to the host. The DISC STRUCTURE Data Length value does not include the DISC STRUCTURE Data Length field itself.

The Disc Manufacturing Information is taken from the DVD/HD DVD media Lead-in. In the case of DVD-R/-RW/HD DVD-R multi-border disc, this information is taken from the last Border-in.

17.24.6 Copyright Management Information (Format Code = 05h)

Table 606 - READ DISC STRUCTURE Data format (With Format Code = 05h)

Bit Byte	7	6	5	4	3	2	1	0
0	(MSB) DISC STRUCTURE Data Length (LSB)							
1								
2	Reserved							
3	Reserved							
Copyright Management Information								
0	CPR_MAI							
1	Reserved							
2	Reserved							
3	Reserved							

The DISC STRUCTURE Data Length field indicates the length in bytes of the following DISC STRUCTURE data that is available to be transferred to the host. The DISC STRUCTURE Data Length value does not include the DISC STRUCTURE Data Length field itself.

The definition of the CPR_MAI field depends on the mounted media. The CPR_MAI field definition is shown in Table 607.

Table 607 - CPR_MAI field definition

Bit Media	7	6	5	4	3	2	1	0
DVD-ROM	CPM	CP_SEC	CGMS		CP_MOD			
DVD-RAM	Reserved							
DVD-R, DVD-RW	Reserved				ADP_TY		Reserved	

The CPM bit, if set to 0, indicates that this sector contains no copyrighted material. If the CPM bit is set to 1, indicates that this sector contains copyrighted material.

When the CPM bit is set to 0, the CP_SEC bit is set to 0. When the CPM bit is set to 1, the CP_SEC bit indicates whether this sector has a specific data structure for prerecorded media copyright protection system. A value of 0 indicates that no such data structure exists in this sector. A value of 1 indicates a specific data structure for CSS or CPPM exists in this sector.

When the CPM bit is set to 0, the CGMS field is set to 00b. When the CPM bit is set to 1, and if the CGMS field is set to 00b, indicates that copying is permitted without restriction, and if the CGMS field is set to 01b, indicates that the CGMS field is reserved, and if the CGMS field is set to 10b, indicates that one generation of copies may be made, and if the CGMS field is set to 11b, indicates that no copying is permitted.

When the CP_SEC bit is set to 0, the CP_MOD field is set to 0h. When the CP_SEC bit is set to 1, the CP_MOD field indicates the copyright protection mode of the specified sector. A value of 0h indicates the sector is scrambled by CSS. A value of 1h indicates the sector is encrypted by CPPM. Other values are reserved.

The ADP_TY field is defined only for DVD-RW SL Ver. 1.2 and DVD-R SL Ver. 2.1 media. The ADP_TY field, if set to 01b, indicates that this sector contains materials defined in DVD Specifications for Read-Only Disc Part 3 VIDEO SPECIFICATIONS. A value of 00b indicates that no such data exists in this sector. All other values of ADP_TY are reserved.

Note: For DVD-R/-RW media, a value of each field may not be correct at the first and last 16 sectors of each recording extent due to the nature of recording method for DVD-R/-RW media.

17.24.7 Media Identifier (Format Code = 06h)

Table 608 - READ DISC STRUCTURE Data format (With Format Code = 06h)

Bit Byte	7	6	5	4	3	2	1	0
0	(MSB) DISC STRUCTURE Data Length (LSB)							
1								
2	Reserved							
3	Reserved							
Media Identifier Structures								
0	(MSB) Media Identifier Data (LSB)							
:								
N								

The DISC STRUCTURE Data Length field indicates the length in bytes of the following DISC STRUCTURE data that is available to be transferred to the host. The DISC STRUCTURE Data Length value does not include the DISC STRUCTURE Data Length field itself.

The Media Identifier Data field returns the Media Identifier, which is protected by a Bus Key.

When the DVD logical unit is not in the Bus Key Established state for CPRM, this command with Format Code = 06h *shall* be terminated with CHECK CONDITION status, 5/6F/02 COPY PROTECTION KEY EXCHANGE FAILURE - KEY NOT ESTABLISHED.

17.24.8 Media Key Block (Format Code = 07h)

Table 609 - READ DISC STRUCTURE Data format (With Format Code = 07h)

Bit Byte	7	6	5	4	3	2	1	0
0	(MSB) DISC STRUCTURE Data Length							(LSB)
1								
2	Reserved							
3	Total Packs							
Media Key Block Structures								
0	(MSB) Media Key Block Pack Data							(LSB)
:								
N								

The DISC STRUCTURE Data Length field indicates the length in bytes of the following DISC STRUCTURE data that is available to be transferred to the host. The DISC STRUCTURE Data Length value does not include the DISC STRUCTURE Data Length field itself.

The Total Packs field reports the total number of Media Key Block Packs that are available for transfer to the host.

The Media Key Block Pack Data field returns the requested Media Key Block Pack, which is protected by a Bus Key only when the Address field set to 00000000h.

The Address field in the CDB specifies which of the available Media Key Block Packs *shall* be read. A valid AGID field value *shall* be supplied only when the Address field is set to 00000000h.

When the Address field value is 00000000h and the DVD logical unit is not in the Bus Key Established state for CPRM, this command with Format Code = 07h *shall* be terminated with CHECK CONDITION status, 5/6F/02 COPY PROTECTION KEY EXCHANGE FAILURE - KEY NOT ESTABLISHED.

17.24.9 Disc Definition Structure (DDS) (Format Code = 08h)

When a READ DISC STRUCTURE command with the Format Code field value of 08h is issued for other than DVD-RAM/HD DVD-RAM media, this command *shall* be terminated with CHECK CONDITION status, 5/24/00 INVALID FIELD IN CDB.

Table 610 - READ DISC STRUCTURE Data format (With Format Code = 08h)

Bit Byte	7	6	5	4	3	2	1	0
0	(MSB) DISC STRUCTURE Data Length (LSB)							
1								
2	Reserved							
3	Reserved							
Disc Definition Structure (DDS)								
0	(MSB) DDS Information (LSB)							
:								
2 047								

The DISC STRUCTURE Data Length field indicates the length in bytes of the following DISC STRUCTURE data that is available to be transferred to the host. The DISC STRUCTURE Data Length value does not include the DISC STRUCTURE Data Length field itself.

The DDS Information is taken from the Defect Controls of the DVD-RAM/HD DVD-RAM media Lead-in. The length of the DDS Information is currently 2 048 bytes only.

When a READ DISC STRUCTURE command with a Format Code field value of 08h is presented for a DVD media other than DVD-RAM media, the command *shall* be terminated with CHECK CONDITION status, 5/24/00 INVALID FIELD IN CDB.

17.24.10 DVD-RAM/HD DVD-RAM Medium Status Information (Format Code = 09h)

When a READ DISC STRUCTURE command with the Format Code field value of 09h is issued for other than DVD-RAM/HD DVD-RAM media, this command *shall* be terminated with CHECK CONDITION status, 5/24/00 INVALID FIELD IN CDB.

Table 611 - READ DISC STRUCTURE Data format (With Format Code = 09h)

Bit Byte	7	6	5	4	3	2	1	0
0	(MSB) DISC STRUCTURE Data Length (LSB)							
1								
2	Reserved							
3	Reserved							
DVD-RAM/HD DVD-RAM Medium Status Data								
0	Cartridge	Out	Reserved		MSWI ^a	CWP	PWP ^a	Reserved
1	Disc Type Identification							
2	Reserved							
3	RAM-SWI Information ^a							

a. For HD DVD-RAM, this field/bit is reserved.

The DISC STRUCTURE Data Length field indicates the length in bytes of the following DISC STRUCTURE data that is available to be transferred to the host. The DISC STRUCTURE Data Length value does not include the DISC STRUCTURE Data Length field itself.

The **Cartridge** bit of one indicates that a medium is in a cartridge. The **Cartridge** bit of zero indicates that a medium is not in a cartridge.

The **Out** bit of one indicates that a medium has been taken out from a cartridge or a medium is put into a cartridge. The **Out** bit of zero indicates that a medium has not been taken out from a cartridge. This field is valid only when the **Cartridge** bit is set to one. If the **Cartridge** bit is set to zero, the **Out** bit *shall* be set to zero.

The Media Specific Write Inhibition (MSWI) bit of one indicates that the writing is inhibited by the specific reason. The reason is indicated in the RAM-SWI Information^a field. The MSWI bit of zero indicates that the writing is not inhibited by the specific reason. For HD DVD-RAM, this bit is reserved.

The Media Cartridge Write Protection (CWP) bit of one indicates that the write protect switch/tabs on a cartridge is set to write protected state. The **CWP** bit of zero indicates that the write protect switch/tabs on a cartridge is set to write permitted state. This field is valid only when the **Cartridge** bit is set to one. If the **Cartridge** bit is set to zero, the **CWP** bit *shall* be set to zero.

The Persistent Write Protection (PWP^a) bit of one indicates that the media surface is set to write protected status. The PWP^a bit of zero indicates that the media surface is set to write permitted status. For HD DVD-RAM, this bit is reserved.

The Disc Type Identification field indicates the Disc Type as defined in Table 612.

Table 612 - Disc Type Identification field definition

Value	Definition
00h	A Disc <i>shall not</i> be written without a cartridge.
01h-0Fh	Reserved
10h	A Disc may be written without a cartridge.
11h-FFh	Reserved

The DVD-RAM Specific Write Inhibition Information (RAM-SWI Information^a) field indicates the reason of DVD-RAM specific write inhibition status. This field is valid only when the MSWI bit is set to one. For HD DVD-RAM, this field is reserved.

If MSWI bit is set to one, RAM-SWI Information^a field *shall* be set according to Table 613.

Table 613 - RAM-SWI Information field definition

Value	Definition
00h	Reserved
01h	Bare Disc Write Inhibition (Disc Type Identification field of 00h and no cartridge)
02h-FEh	Reserved
FFh	Unspecified reason

17.24.11 Spare Area Information (Format Code = 0Ah)**Table 614 - READ DISC STRUCTURE Data format (With Format Code = 0Ah)**

Bit Byte	7	6	5	4	3	2	1	0
0	(MSB) DISC STRUCTURE Data Length (LSB)							
1								
2	Reserved							
3	Reserved							
Spare Area Information								
0	(MSB) Number of Unused Primary Spare Blocks (LSB)							
1								
2								
3								
4	(MSB) Number of Unused Supplementary Spare Blocks (LSB)							
5								
6								
7								
8	(MSB) Number of Allocated Supplementary Spare Blocks (LSB)							
9								
10								
11								

When a READ DISC STRUCTURE command with the **Format Code** field value of 0Ah is issued for other than DVD/HD DVD media which is capable of allocation of the Supplementary Spare area, this command *shall* be terminated with CHECK CONDITION status, 5/24/00 INVALID FIELD IN CDB.

The host can recognize whether the media is capable of allocation of the Supplementary Spare area or not, indicated in the Hardware Defect Management Feature Descriptor reported by the GET CONFIGURATION command.

The **DISC STRUCTURE Data Length** field indicates the length in bytes of the following DISC STRUCTURE data that is available to be transferred to the host. The **DISC STRUCTURE Data Length** value does not include the **DISC STRUCTURE Data Length** field itself.

The **Number of Unused Primary Spare Blocks** field indicates the number of unused spare blocks in the Primary Spare area.

The **Number of Unused Supplementary Spare Blocks** field indicates the number of unused spare blocks in the Supplementary Spare area.

The **Number of Allocated Supplementary Spare Blocks** field indicates the number of allocated spare blocks in the Supplementary Spare area.

17.24.12 Recording Type Information (Format Code = 0Bh)**Table 615 - READ DISC STRUCTURE Data format (With Format Code = 0Bh)**

Bit Byte	7	6	5	4	3	2	1	0
0	(MSB) DISC STRUCTURE Data Length (LSB)							
1								
2	Reserved							
3	Reserved							
Recording Type Information								
0	Recording Type Information Data							
1	Reserved							
2	Reserved							
3	Reserved							

When a READ DISC STRUCTURE command with the **Format Code** field value of 0Bh is issued for other than DVD-RAM Ver. 2.2 or HD DVD-RAM media, this command *shall* be terminated with CHECK CONDITION status, 5/24/00 INVALID FIELD IN CDB.

The DISC STRUCTURE Data Length field indicates the length in bytes of the following DISC STRUCTURE data that is available to be transferred to the host. The DISC STRUCTURE Data Length value does not include the DISC STRUCTURE Data Length field itself.

The definition of the Recording Type Information Data is shown in Table 616.

Table 616 - Recording Type Information Data field definition

Bit Byte	7	6	5	4	3	2	1	0
0	Reserved			Recording Type	Reserved			

The Recording Type bit is defined only for DVD-RAM Ver. 2.2 and HD DVD-RAM media. The Recording Type bit, if set to 1b, indicates that this sector contains a real-time data. A value of 0b indicates that this sector contains a general data. (see Table 13 - *Recording Type bit definition for DVD-RAM Ver. 2.2 media* on page 93 or Table 144 - *Recording Type bit definition for HD DVD-RAM media* on page 310.)

Note: Streaming bit of the WRITE (12) command shall be used to set/clear the Recording Type bit. (see 17.49, "WRITE (12) command" on page 911).

17.24.13 RMD in the last Border-out (Format Code = 0Ch)**Table 617 - READ DISC STRUCTURE Data format (With Format Code = 0Ch)**

Bit Byte	7	6	5	4	3	2	1	0
0	(MSB) DISC STRUCTURE Data Length (LSB)							
1								
2	Reserved							
3	Reserved							
RMD in last Border-out								
0	(MSB) RMD Bytes (LSB)							
:								
N								

The DISC STRUCTURE Data Length field indicates the length in bytes of the following DISC STRUCTURE data that is available to be transferred to the host. The DISC STRUCTURE Data Length value does not include the DISC STRUCTURE Data Length field itself.

The RMD Bytes field returns the RMD which is written in the last recorded Border-out.

The Address field in the CDB specifies the starting RMD Field number where the read operation *shall* begin. The Allocation Length field in the CDB specifies the maximum number of RMD bytes that *shall* be returned. The largest RMD available is 30 720 bytes (15 sectors) for DVD, 45 056 (22 sectors) for HD DVD.

17.24.14 Recording Management Area Data (Format Code = 0Dh)**Table 618 - READ DISC STRUCTURE Data format (With Format Code = 0Dh)**

Bit Byte	7	6	5	4	3	2	1	0
0	(MSB) DISC STRUCTURE Data Length (LSB)							
1								
2	Reserved							
3	Reserved							
DVD-R/-RW Recording Management Data Structure								
0	(MSB) Last Recorded RMA Sector Number / Start Sector Number of Valid Format 3 RMD Set (LSB)							
:								
3								
4-N	(MSB) RMD Bytes (LSB)							

This format is available only for DVD-R/-RW media. For other media, this format is reserved.

The DISC STRUCTURE Data Length field indicates the length in bytes of the following DISC STRUCTURE data that is available to be transferred to the host. The DISC STRUCTURE Data Length value does not include the DISC STRUCTURE Data Length field itself.

The Last Recorded RMA Sector Number / Start Sector Number of Valid Format 3 RMD Set field indicates the RMA sector number where the last RMD is recorded. On DVD-RW restricted overwritten media, this field indicates the start sector number of valid Format 3 RMD Set.

The RMD Bytes field returns the RMD which is written in RMA. The Address field in the CDB specifies the starting address of the RMA sector where the read operation *shall* begin. The Allocation Length field in the CDB specifies the maximum length of the descriptor returned to the host. The returned RMD data *shall* end at the next ECC boundary. The maximum number of RMD bytes that can be returned is 32 768.

17.24.15 Pre-recorded Information in Lead-in (Format Code = 0Eh)

Table 619 - READ DISC STRUCTURE Data format (With Format Code = 0Eh)

Bit Byte	7	6	5	4	3	2	1	0
0	(MSB) DISC STRUCTURE Data Length (LSB)							
1								
2	Reserved							
3	Reserved							
DVD-R Pre-recorded Information Structure								
0-n	Pre-recorded Information ^a							

a. See Table 54 - Copy of Pre-pit Information on page 149.

This format is available only for DVD-R/-RW media. For other media, this format is reserved.

The DISC STRUCTURE Data Length field indicates the length in bytes of the following DISC STRUCTURE data that is available to be transferred to the host. The DISC STRUCTURE Data Length value does not include the DISC STRUCTURE Data Length field itself.

The contents of Pre-recorded information are specified by the DVD Specifications for Recordable Disc, Part 1 or DVD Specifications for Re-Recordable Disc Part 1.

17.24.16 Unique Disc Identifier (Format Code = 0Fh)

Table 620 - READ DISC STRUCTURE Data format (With Format Code = 0Fh)

Bit Byte	7	6	5	4	3	2	1	0
0	(MSB) DISC STRUCTURE Data Length (LSB)							
1								
2	Reserved							
3	Reserved							
Unique Disc Identifier								
0-17	Unique Disc Identifier ^a							

a. See Table 53 - Unique Disc ID on page 148 or Table 174 - Unique Disc ID on page 335.

This format is available only for DVD-R/-RW and HD DVD-R/-RW media. For other media, this format is invalid and reserved.

The DISC STRUCTURE Data Length field indicates the length in bytes of the following DISC STRUCTURE data that is available to be transferred to the host. The DISC STRUCTURE Data Length value does not include the DISC STRUCTURE Data Length field itself.

This format returns the Unique Disc Identifier which is recorded in RMD Field 0.

17.24.17 Physical Format Information of Control Data Zone in the Lead-in (Format Code = 10h)

This format is available only for DVD-R/-RW and HD DVD-R/-RW media. For other media, this format is invalid and reserved.

This DISC STRUCTURE data returns Physical format information of Control Data Zone in the Lead-in Area even if the disc is recorded with multi-Bordered Area.

Table 621 - READ DISC STRUCTURE Data format (With Format Code = 10h)

Bit Byte	7	6	5	4	3	2	1	0
0	(MSB) DISC STRUCTURE Data Length (LSB)							
1								
2	Reserved							
3	Reserved							
Physical format information in the Lead-in								
0	Book Type				Part Version			
1	Disc Size				Maximum Rate			
2	Reserved	Number of Layers		Track Path	Layer Type			
3	Linear Density				Track Density			
4	00h							
5	(MSB) Starting Physical Sector Number of Data Area (LSB)							
6								
7								
8	00h							
9	(MSB) End Physical Sector Number of Data Area (LSB)							
10								
11								
12	00h							
13	(MSB) End Sector Number in L0 (LSB)							
14								
15								
16	BCA Flag	Reserved						
17-2 047	Media Specific							

The Media Specific field *shall* return information as specified in the associated DVD/HD DVD specification.

The other field definitions are same as the definitions of Format code 00h.

17.24.18 HD DVD Copyright Protection Information (Format Code = 12h)

Table 622 - READ DISC STRUCTURE Data format (With Format Code = 12h)

Bit Byte	7	6	5	4	3	2	1	0
0	(MSB) DISC STRUCTURE Data Length							(LSB)
1								
2	Reserved							
3	Reserved							
HD DVD Copyright Protection Information								
0	(MSB) HD DVD Copyright Protection Information Data							(LSB)
:								
2 047								

The DISC STRUCTURE Data Length field indicates the length in bytes of the following DISC STRUCTURE data that is available to be transferred to the host. The DISC STRUCTURE Data Length value does not include the DISC STRUCTURE Data Length field itself.

The HD DVD Copyright Protection Information is taken from the Copyright Protection Information recorded at the System Lead-in of the HD DVD discs. The length of the HD DVD Copyright Protection Information Data field is 2 048 bytes only.

17.24.19 Copyright data section (Format Code = 15h)

Table 623 - READ DISC STRUCTURE Data format (With Format Code = 15h)

Bit Byte	7	6	5	4	3	2	1	0
0	(MSB) DISC STRUCTURE Data Length							(LSB)
1								
2	Reserved							
3	Reserved							
Copyright data section								
0	Copyright data							
:								
N								

The DISC STRUCTURE Data Length field indicates the length in bytes of the following DISC STRUCTURE data that is available to be transferred to the host. The DISC STRUCTURE Data Length value does not include the DISC STRUCTURE Data Length field itself.

The Copyright data field *shall* return information of the Copyright data section in the Control data zone.

For HD DVD, the Address field in the CDB specifies the starting address of the Copyright data section sector position from 0 to 31 where the read operation *shall* begin. The Allocation Length field in the CDB specifies the maximum length of the descriptor returned to the host. The maximum number of Copyright data that can be returned is 63488 that contains 31 sectors.

For DVD adapted to AACs, the Address field in the CDB specifies the starting address of the Copyright data section sector position from 2 to 15 where the read operation *shall* begin. The Allocation Length field in the CDB specifies the

maximum length of the descriptor returned to the host. The maximum number of the Copyright data section that can be returned is 28 672.

17.24.20 HD DVD-R/-RW Medium Status information (Format Code = 19h)

Table 624 - READ DISC STRUCTURE Data format (With Format Code = 19h)

Bit Byte	7	6	5	4	3	2	1	0	
0	(MSB) DISC STRUCTURE Data Length (LSB)								
1									
2	Reserved								
3	Reserved								
HD DVD-R/-RW Medium Status									
0	Reserved						IRSL1	Extended Test Zone	
1	Number of remaining RMDs in RDZ								
2	Number of remaining RMDs in Current RMZ								
3									

The DISC STRUCTURE Data Length field indicates the length in bytes of the following DISC STRUCTURE data that is available to be transferred to the host. The DISC STRUCTURE Data Length value does not include the DISC STRUCTURE Data Length field itself.

The IRSL1 (Instant Recording Setup for L1) bit of one indicates that the logical unit is ready to record on L1.

5.14.2.1, "Preparation for recording L1" on page 367 and 5.14.2.2.1, "Guard Track Zone allocation by Middle Area expansion" on page 370.

The Extended Test Zone bit of one indicates that Test Zone has been extended.

The Number of remaining RMDs in RDZ field indicates the number of the unrecorded ECC blocks in the RDZ. For HD DVD-RW, this field indicates the number of the ECC blocks in RDZ which are not defective.

The Number of remaining RMDs in Current RMZ field indicates the number of the unrecorded ECC blocks in the current RMZ. For HD DVD-RW, this field indicates the number of the ECC blocks in L-RMZ which are not defective.

17.24.21 Last recorded RMD in the latest RMZ (Format Code = 1Ah)

Table 625 - READ DISC STRUCTURE Data format (With Format Code = 1Ah)

Bit Byte	7	6	5	4	3	2	1	0
0	(MSB) DISC STRUCTURE Data Length (LSB)							
1								
2	Reserved							
3	Reserved							
Last recorded RMD in the latest RMZ								
0	RMD Bytes							
:								
N								

The DISC STRUCTURE Data Length field indicates the length in bytes of the following DISC STRUCTURE data that is available to be transferred to the host. The DISC STRUCTURE Data Length value does not include the DISC STRUCTURE Data Length field itself.

For HD DVD, the RMD Bytes field returns the last recorded RMD which is written in the latest RMZ.

The Address field in the CDB specifies the starting RMD Field number where the read operation *shall* begin. The Allocation Length field in the CDB specifies the maximum number of RMD bytes that *shall* be returned. The largest RMD available is 45056 (22 sectors).

17.24.22 Layer Boundary Information (Format Code = 20h)

This format is available only for DVD-R DL, DVD-RW DL, HD DVD-R DL and HD DVD-RW DL discs. For the other media, this format is invalid and reserved.

This Format Code returns the Layer boundary information. In the case of DVD-R DL or DVD-RW DL discs, this value is a fixed value calculated from End PSN of L0 and is not changeable.

Table 626 - READ DISC STRUCTURE Data format (With Format Code = 20h)

Bit Byte	7	6	5	4	3	2	1	0
0	(MSB)							
1	DISC STRUCTURE Data Length							(LSB)
2	Reserved							
3	Reserved							
Layer Boundary Information								
0	Init Status	Reserved						
1	Reserved							
2	Reserved							
3	Reserved							
4	(MSB)							
5	L0 Data Area Capacity							(LSB)
6								
7								

The Init Status bit indicates whether the capacity of Data Area is changeable by the host or not. When the Init Status is set to zero, the L0 Data Area Capacity value has not been written into the Control Data Zone and the capacity of the medium *shall* be the default capacity. The host may specify a smaller capacity value by using the SEND DISC STRUCTURE command with Format Code = 20h. When Init Status is set to one, L0 Data Area Capacity value has been specified and may not be changed. For HD DVD-R/-RW, when Init Status is set to zero, the L0 Data Area Capacity value *shall* be the default capacity. When Init Status is set to one, L0 Data Area Capacity value has been specified. For HD DVD-R, L0 Data Area Capacity value may not be changed. For HD DVD-RW, L0 Data Area Capacity value may be changed even when Init Status is set to one.

L0 Data Area Capacity is the number of Data Area sectors available for recording on L0. This value *shall* be an integral multiple of 16 for DVD or 32 for HD DVD. The capacity of L0 is the number of sectors between the end of the Lead-in and the first sector of the Middle Area.

For DVD-R DL or DVD-RW DL discs, the Init Status bit *shall* be set to one regardless of disc status since the value is not changeable.

For HD DVD-R DL discs, when no L0 Data Area Capacity has been selected, the default capacity *shall* be based upon Control Data Zone. The disc does not provide exactly the same capacity in ECC blocks on each Layer. L0 Data Area

Capacity is larger number of 3300h sectors than L1 Data Area capacity. If the HD DVD-R DL disc is completely blank, the Init Status bit *shall* be set to zero and the default L0 Data Area Capacity value *shall* be reported.

In the case of HD DVD-RW DL disc, the default capacity *shall* be based upon Control Data Zone. L0 Data Area Capacity value may be changeable unless the addressable area is expanded to L1. The disc does not provide exactly the same capacity in ECC blocks on each Layer. L0 Data Area Capacity is larger number of 3300h sectors than L1 Data Area Capacity.

For DVD+R DL discs, see MMC.

17.24.23 Shifted Middle Area Start Address (Format Code = 21h)

This format is available only for DVD-R DL and DVD-RW DL discs. For other media, this format is invalid and reserved.

This Format code returns the start logical block address of Shifted Middle Area on L0.

Table 627 - READ DISC STRUCTURE Data format (With Format Code = 21h)

Bit Byte	7	6	5	4	3	2	1	0
0	(MSB)							
1	DISC STRUCTURE Data Length							(LSB)
2	Reserved							
3	Reserved							
Shifted Middle Area Information								
0	Init Status	Reserved						
1-3	Reserved							
4	(MSB)							
5	Shifted Middle Area Start Address							(LSB)
6								
7								
7								

Init Status bit indicates whether the Shifted Middle Area start address is changeable by the host or not. When Init Status is set to zero, Shifted Middle Area start address is changeable. If this bit is set to 1, Shifted Middle Area start address is not changeable. The address of Shifted Middle Area has been registered in RMD on the disc. In case of DVD-RW DL media, this bit *shall* be set to 1 when the medium is finalized. When the medium is formatted and becomes Intermediate state, this bit *shall* be set to 0.

Shifted Middle Area Start Address is the start logical block address of the Shifted Middle Area on L0. If this value is set to 0, the Shifted Middle Area is not specified on the medium or the Fixed Middle Area is applied.

In case of DVD-RW DL media, Shifted Middle Area Start Address *shall* be reset when the physical disc state is changed from Complete state to Intermediate state by formatting.

17.24.24 Jump Interval size (Format Code = 22h)

This format is available only for DVD-R DL and DVD-RW DL discs. For other media, this format is invalid and reserved.

This Format Code returns the Jump Interval size for the Regular Interval Layer Jump recording by number of blocks. The Jump Interval size is specified by the SEND DISC STRUCTURE command with Format Code =22h.

Table 628 - READ DISC STRUCTURE Data format (With Format Code = 22h)

Bit Byte	7	6	5	4	3	2	1	0
0	(MSB) DISC STRUCTURE Data Length (LSB)							
1								
2	Reserved							
3	Reserved							
Jump Interval size								
0-3	Reserved							
4	(MSB) Jump Interval size (LSB)							
5								
6								
7								

The Jump Interval size field indicates the Jump Interval size for the Regular Interval Layer Jump recording. If the Jump Interval size is not specified to the Invisible/Incomplete RZone, the Jump Interval size field *shall* be set to 0.

17.24.25 Manual Layer Jump Address (Format Code = 23h)

This format is available only for DVD-R DL and DVD-RW DL discs. For other media, this format is invalid and reserved.

This Format code returns the Manual Layer Jump Address on L0 specified by Manual Layer Jump Address of SEND DISC STRUCTURE command.

Table 629 - READ DISC STRUCTURE Data format (With Format Code = 23h)

Bit Byte	7	6	5	4	3	2	1	0
0	(MSB) DISC STRUCTURE Data Length (LSB)							
1								
2	Reserved							
3	Reserved							
Manual Layer Jump Address Information								
0-3	Reserved							
4	(MSB) Layer Jump Logical Block Address (LSB)							
5								
6								
7								

The Layer Jump Logical Block Address field indicates the Manual Layer Jump Address on L0. After the specified Manual Layer Jump has happened or if no Layer jump is specified, the Layer Jump Logical Block Address field *shall* be set to 0.

17.24.26 Remapping Address (Format Code = 24h)

This format is available only for DVD-R Dual Layer disc. For other media, this format is invalid and reserved.

This Format code returns the remapping address information of the specified Anchor Point.

Table 630 - READ DISC STRUCTURE Data format (With Format Code = 24h)

Bit Byte	7	6	5	4	3	2	1	0
0	(MSB) DISC STRUCTURE Data Length (LSB)							
1								
2	Reserved							
3	Reserved							
Remapping Information								
0-3	Reserved							
4	(MSB) Remapping Address (LSB)							
5								
6								
7								

The Remapping Address field indicates the first logical block address of the ECC block that is used to reassign the Anchor Point block specified by Address field of CDB. If this value is set to 0, there is no valid remapped data of Anchor Point block.

The Address field of CDB is used to specify the Anchor Point Number. Single remapping information *shall* be reported.

17.24.27 Volume Identifier of AACS (Format Code = 80h)

Table 631 - READ DISC STRUCTURE Data format (With Format Code = 80h)

Bit Byte	7	6	5	4	3	2	1	0
0	(MSB) DISC STRUCTURE Data Length (LSB)							
1								
2	Reserved							
3	Reserved							
Volume Identifier Structure								
0	(MSB) Volume Identifier Data (LSB)							
:								
N								

The DISC STRUCTURE Data Length field indicates the length in bytes of the following DISC STRUCTURE data that is available to be transferred to the host. The DISC STRUCTURE Data Length value does not include the DISC STRUCTURE Data Length field itself.

The Volume Identifier Data field returns the Volume Identifier of AACS, which integrity is ensured by the AACS Authentication.

When the logical unit is not in the Bus Key established state of the AACS Authentication, this command with Format Code = 80h *shall* be terminated with CHECK CONDITION status, 5/6F/02 COPY PROTECTION KEY EXCHANGE FAILURE - KEY NOT ESTABLISHED.

17.24.28 Pre-recorded Media Serial Number of AACCS (Format Code = 81h)**Table 632 - READ DISC STRUCTURE Data format (With Format Code = 81h)**

Bit Byte	7	6	5	4	3	2	1	0
0	(MSB) DISC STRUCTURE Data Length (LSB)							
1								
2	Reserved							
3	Reserved							
Pre-recorded Media Serial Number Structure								
0	(MSB) Pre-recorded Media Serial Number Data (LSB)							
:								
N								

The DISC STRUCTURE Data Length field indicates the length in bytes of the following DISC STRUCTURE data that is available to be transferred to the host. The DISC STRUCTURE Data Length value does not include the DISC STRUCTURE Data Length field itself.

The Pre-recorded Media Serial Number Data field returns the Pre-recorded Media Serial Number of AACCS, which integrity is ensured by the AACCS Authentication.

When the logical unit is not in the Bus Key established state of the AACCS Authentication, this command with Format Code = 81h *shall* be terminated with CHECK CONDITION status, 5/6F/02 COPY PROTECTION KEY EXCHANGE FAILURE - KEY NOT ESTABLISHED.

17.24.29 Media Identifier of AACCS (Format Code = 82h)**Table 633 - READ DISC STRUCTURE Data format (With Format Code = 82h)**

Bit Byte	7	6	5	4	3	2	1	0
0	(MSB) DISC STRUCTURE Data Length (LSB)							
1								
2	Reserved							
3	Reserved							
Media Identifier Structure								
0	(MSB) Media Identifier Data (LSB)							
:								
N								

The DISC STRUCTURE Data Length field indicates the length in bytes of the following DISC STRUCTURE data that is available to be transferred to the host. The DISC STRUCTURE Data Length value does not include the DISC STRUCTURE Data Length field itself.

The Media Identifier Data field returns the Media Identifier of AACCS, which integrity is ensured by the AACCS Authentication.

When the logical unit is not in the Bus Key established state of the AACCS Authentication, this command with Format Code = 82h *shall* be terminated with CHECK CONDITION status, 5/6F/02 COPY PROTECTION KEY EXCHANGE FAILURE - KEY NOT ESTABLISHED.

17.24.30 Media Key Block of AACS (Format Code = 83h)**Table 634 - READ DISC STRUCTURE Data format (With Format Code = 83h)**

Bit Byte	7	6	5	4	3	2	1	0
0	(MSB) DISC STRUCTURE Data Length (LSB)							
1								
2	Reserved							
3	Total Packs							
Media Key Block Structure								
0	(MSB) Media Key Block Pack Data (LSB)							
:								
N								

The DISC STRUCTURE Data Length field indicates the length in bytes of the following DISC STRUCTURE data that is available to be transferred to the host. The DISC STRUCTURE Data Length value does not include the DISC STRUCTURE Data Length field itself.

The Total Packs field reports the total number of Media Key Block Packs that are available for transfer to the host.

The Media Key Block Pack Data field returns the requested Media Key Block Pack of Media Key Block of AACS in Lead-in specified by AACS. The size of Media Key Block Pack Data is 32 KB maximum.

The Address field in the CDB specifies which of the available Media Key Block Packs *shall* be read.

This command with Format Code = 83h does not require the AACS Authentication.

17.24.31 Data Keys of AACS (Format Code = 84h)**Table 635 - READ DISC STRUCTURE Data format (With Format Code = 84h)**

Bit Byte	7	6	5	4	3	2	1	0
0	(MSB) DISC STRUCTURE Data Length (LSB)							
1								
2	Reserved							
3	Reserved							
Data Key Structure								
0	(MSB) Data Key Data (LSB)							
:								
N								

The DISC STRUCTURE Data Length field indicates the length in bytes of the following DISC STRUCTURE data that is available to be transferred to the host. The DISC STRUCTURE Data Length value does not include the DISC STRUCTURE Data Length field itself.

The Data Key Data field returns the Read Data Key and the Write Data Key of AACS, which is encrypted by a Bus Key.

When the Read Data Key is not defined because the appropriate ID (either the Media ID or the Volume ID) is corrupted or not present, this command with Format Code = 84h *shall* be terminated with CHECK CONDITION status, 5/6F/01 COPY PROTECTION KEY EXCHANGE FAILURE - KEY NOT PRESENT.

When the logical unit is not in the Bus Key established state of the AACS Authentication, this command with Format Code = 84h *shall* be terminated with CHECK CONDITION status, 5/6F/02 COPY PROTECTION KEY EXCHANGE FAILURE - KEY NOT ESTABLISHED.

17.24.32 LBA Extents for Bus Encryption flag of AACS (Format Code = 85h)

Table 636 - READ DISC STRUCTURE Data format (With Format Code = 85h)

Bit Byte	7	6	5	4	3	2	1	0
0	(MSB) DISC STRUCTURE Data Length (LSB)							
1								
2	Reserved							
3	Maximum Number of LBA Extents							
1st LBA Extent Structure								
0	Reserved							
:								
7								
8	(MSB) Start LBA (LSB)							
:								
11								
12	(MSB) LBA Count (LSB)							
:								
15								
Nth LBA Extent Structure								
16(N-1) ^a	Reserved							
:								
16(N-1)+7	(MSB) Start LBA (LSB)							
16(N-1)+8								
:								
16(N-1)+11	(MSB) LBA Count (LSB)							
16(N-1)+12								
:								
16(N-1)+15								

a. N is integer value and greater than or equal to 1 to apply this formula. If there is no LBA Extent Structure in this DISC STRUCTURE data, N is considered as 0.

The DISC STRUCTURE Data Length field indicates the length in bytes of the following DISC STRUCTURE data that is available to be transferred to the host. The DISC STRUCTURE Data Length value does not include the DISC STRUCTURE Data Length field itself.

The Maximum Number of LBA Extents field returns the maximum number of LBA Extents that the logical unit can store. The value of 1 for this field means the logical unit can store only a single LBA Extent. The value of 2 for this field means the logical unit can store up to two LBA Extents. The value of 0 for this field means the logical unit can store up to 256 LBA Extents.

LBA Extent Structure data return what LBA Extents the logical unit currently stores. Each LBA Extent is denoted by the Start LBA and the LBA Count, where the first LBA is Start LBA and the last LBA is Start LBA + LBA Count - 1. The LBA Extent Structure data *shall* be sorted by the Start LBA field value in ascending order. Each LBA Extent *shall not* cause any overlapping regions.

If the logical unit does not store any LBA Extents, no LBA Extent Structure (N=0) *shall* be reported.

This command with Format Code = 85h does not require the AACS Authentication.

17.24.33 Media Key Block of CPRM (Format Code = 86h)

Table 637 - READ DISC STRUCTURE Data format (With Format Code = 86h)

Bit Byte	7	6	5	4	3	2	1	0
0	(MSB)							
1	DISC STRUCTURE Data Length							(LSB)
2	Reserved							
3	Total Packs							
Media Key Block Structure								
0	(MSB)							
:	Media Key Block Pack Data							
N								(LSB)

The DISC STRUCTURE Data Length field indicates the length in bytes of the following DISC STRUCTURE data that is available to be transferred to the host. The DISC STRUCTURE Data Length value does not include the DISC STRUCTURE Data Length field itself. When the Address field is set to 00000FFh, the DISC STRUCTURE Data Length field *shall* be set to 0002h.

The Total Packs field reports the total number of Media Key Block Packs that are available for transfer to the host.

The Media Key Block Pack Data field returns the requested Media Key Block Pack of Media Key Block of CPRM in Lead-in specified by AACS, which is protected by a Bus Key only when the Address field set to 00000000h. The size of Media Key Block Pack Data is 32 KB maximum.

The Address field in the CDB specifies which of the available Media Key Block Packs *shall* be read. A valid AGID field value *shall* be supplied only when the Address field is set to 00000000h. The Address field of 00000FFh indicates that only the 4-byte header of DISC STRUCTURE data *shall* be returned. No Media Key Block Pack Data *shall* be included in the returned DISC STRUCTURE data. The host can use this function to obtain the Total Packs of the Media Key Block of CPRM on the medium without the AACS Authentication.

When the Address field value is 00000000h and the logical unit is not in the Bus Key Established state of the AACS Authentication, this command with Format Code = 86h *shall* be terminated with CHECK CONDITION status, 5/6F/02 COPY PROTECTION KEY EXCHANGE FAILURE - KEY NOT ESTABLISHED.

17.24.34 Hybrid disc structure (Format Code = 90h)

Table 638 - READ DISC STRUCTURE Data format (With Format Code = 90h)

Bit Byte	7	6	5	4	3	2	1	0
0	(MSB) DISC STRUCTURE Data Length (LSB)							
1								
2	Reserved							
3	Reserved							
Hybrid disc structure information								
0	Number of recognized Format-layers							
1	Reserved	Default Format-layer			Reserved	Online Format-layer		
2-3	Type of Format-layer #0							
:	:							
2n+2-2n+3	Type of Format-layer #n							

The DISC STRUCTURE Data Length field indicates the length in bytes of the following DISC STRUCTURE data that is available to be transferred to the host. The DISC STRUCTURE Data Length value does not include the DISC STRUCTURE Data Length field itself.

The Number of recognized Format-layers field indicates the number of Format-layers that the logical unit has identified in the mounted disc. The identified Format-layers are listed in the Type of Format-layer #n fields.

The Default Format-layer field indicates the Format-layer number which becomes online when the disc is inserted. The selection of the Format-layer number to be set in this field is vendor-specific.

The Online Format-layer field indicates the current online Format-layer number or the Format-layer number that is going to be online.

The Type of Format-layer #n field indicates the type of the Format-layer numbered n. Each Format-layer identified by the logical unit *shall* be numbered from 0 and incremented by one. The numbering of the Format-layer *shall* be in numerical ascending order of the Format-layer type code defined in Table 639. The Format-layer which exist in the disc but not identified by the logical unit *shall not* be listed.

Table 639 - Format-layer type code definition

Value	Definition
0000h-0007h	Reserved
0008h	CD type format
0009h	Reserved
0010h	DVD type format
0011h-003Fh	Reserved
0040h	BD type format
0041h-004Fh	Reserved
0050h	HD DVD type format
0051h-FFFFh	Reserved

17.24.35 Write Protection Status (Format Code = C0h)

Table 640 - READ DISC STRUCTURE Data format (With Format Code = C0h)

Bit Byte	7	6	5	4	3	2	1	0
0	(MSB) DISC STRUCTURE Data Length (LSB)							
1								
2	Reserved							
3	Reserved							
Write Protection Status								
0	Reserved				MSWI	CWP	PWP	SWPP
1	Reserved							
2	Reserved							
3	Reserved							

The Software Write Protection until Power down (SWPP) bit of one indicates that the software write protection is active. The SWPP bit of zero indicates that the software write protection is inactive. If the logical unit does not support SWPP, this bit *shall* be set to zero.

The Persistent Write Protection (PWP) bit of one indicates that the media surface is set to write protected status. The PWP bit of zero indicates that the media surface is set to write permitted status. If the mounted medium and logical unit do not support PWP, this bit *shall* be set to zero.

The Media Cartridge Write Protection (CWP) bit of one indicates that the write protect switch/tabs on a cartridge is set to write protected state. The CWP bit of zero indicates that the write protect switch/tabs on a cartridge is set to write permitted state. If the cartridge does not have CWP function or medium is mounted without cartridge, this bit *shall* be set to zero. Otherwise CWP bit *shall* indicate its actual status.

The Media Specific Write Inhibition (MSWI) bit of one indicates that any writing is inhibited by the media specific reason. The MSWI bit of zero indicates that writing is not inhibited by the media specific reason.

17.24.36 DISC Structure List (Format Code = FFh)

Requests for Format Code FFh *shall* be fulfilled, even if no or incompatible media is installed.

Table 641 - READ DISC STRUCTURE Data format (With Format Code = FFh)

Bit Byte	7	6	5	4	3	2	1	0
0	(MSB) DISC STRUCTURE Data Length (LSB)							
1								
2	Reserved							
3	Reserved							
DISC Structure List								
0	Structure List							
:								
N								

The Structure List is returned as a sequence of Structure List Entries as shown in Table 642.

Note: This DISC STRUCTURE is generated by the logical unit rather than read from the medium.

Table 642 - Structure List entry

Bit Byte	7	6	5	4	3	2	1	0
0	Format Code							
1	SDS	RDS	Reserved					
2	Obsolete (Structure Length)							
3								

The Format Code field *shall* identify a DISC STRUCTURE data that is readable via the READ DISC STRUCTURE command and/or writable via SEND DISC STRUCTURE command.

The SDS bit, when set to zero, *shall* indicate that the DISC STRUCTURE data is not writable via the SEND DISC STRUCTURE command. When set to one, *shall* indicate that the DISC STRUCTURE data is writable via the SEND DISC STRUCTURE command.

The RDS bit, when set to zero, *shall* indicate that the DISC STRUCTURE data is not readable via the READ DISC STRUCTURE command. When set to one, *shall* indicate that the DISC STRUCTURE data is readable via the READ DISC STRUCTURE command.

This Format Code (=FFh) should be reported as one of supported Structure List entries with RDS bit and/or SDS bit set to one.

Note: Structure Length field is removed, because many different implementation existed. For example Format Code= 00 returns data length of DVD medium Physical Format Information (Format Code = 00h) that is 2048 bytes. Some implementation set 2048 in the Structure Length field. Other set 2050 or 2052. Some Format Code (e.g. BCA (Format Code = 03h) has variable length of data. Therefore host may issue READ DISC STRUCTURE command with Allocation Length=4 to obtain the actual returned data length of the mounted medium from the DISC STRUCTURE Data Length field.

Table 643 describes errors that may occur during the operation of the command or which may cause a CHECK CONDITION status to be reported.

Table 643 - READ DISC STRUCTURE command Errors

Error Description
A-1.1 "Deferred Error Reporting" on page 919
Table 835 - Basic Error Codes on page 932
Table 836 - Media Access Error Codes on page 935

17.25 READ FORMAT CAPACITIES command

The READ FORMAT CAPACITIES command allows the host to request a list of the possible format capacities for an installed random-writable media. This command also has the capability to report the capacity for a media when it is installed. If this command is required by an implemented Feature, this command *shall* function independently of the state of that Feature's Current bit.

Table 644 - READ FORMAT CAPACITIES Command Descriptor Block

Bit Byte	7	6	5	4	3	2	1	0
0	Operation Code (23h)							
1	LUN (Obsolete)			Reserved				
2	Reserved							
3	Reserved							
4	Reserved							
5	Reserved							
6	Reserved							
7	(MSB) Allocation Length (LSB)							
8								
9	Vendor-Specific	Reserved			NACA	Flag	Link	
10	PAD							
11								

The Allocation Length field specifies the maximum number of bytes that a host has allocated for returned data. An Allocation Length of zero indicates that no data *shall* be transferred. This condition *shall not* be considered as an error. The logical unit *shall* terminate the data transfer when Allocation Length bytes have been transferred or when all available data have been transferred to the host, whichever is less.

Table 645 - Read Format Capacities Data Format

Bit Byte	7	6	5	4	3	2	1	0
0-3	Capacity List Header							
4-11	Current/Maximum Capacity Descriptor							
Formattable Capacity Descriptor(s)								
0	Formattable Capacity Descriptor 0							
7								
...	Formattable Capacity Descriptor n							
n × 8								
n × 8 + 7								

Table 646 - Capacity List Header

Bit Byte	7	6	5	4	3	2	1	0
0	Reserved							
1								
2								
3	Capacity List Length							

The Capacity List Length specifies the length in bytes of the Capacity Descriptors that follow. Each Capacity Descriptor is eight bytes in length, making the Capacity List Length equal to eight times the number of descriptors. Values of $n \times 8$ are valid, where $0 < n < 32$.

Table 647 - Current/Maximum Capacity Descriptor

Bit Byte	7	6	5	4	3	2	1	0
4	(MSB) Number of Blocks (LSB)							
5								
6								
7								
8	Reserved					Descriptor Type		
9	(MSB) Block Length (LSB)							
10								
11								

The Number of Blocks indicates the number of addressable blocks for the capacity defined by each Descriptor Type. The Descriptor Type field indicates the type of information the descriptor contains. The values are shown in Table 648.

Table 648 - Descriptor Type field definition

Descriptor Type value	Definition	Description
00b	Reserved	Reserved
01b	Unformatted media	The reported value is for the Maximum formattable capacity for this media. The blank media <i>shall</i> be reported as “Unformatted media” with Descriptor Type = 01b.
10b	Formatted media	The reported value is the current media’s capacity. In the case of sequential recorded media, the number of blocks field indicates the number of addressable blocks between the first Lead-in and the last Lead-out or Border-out. When the sequential recorded media has no closed session or Border, it <i>shall</i> be reported as “Unknown capacity media” with Descriptor Type = 11b.
11b	No media present or Unknown capacity media	The reported value is for the maximum capacity of a media that the logical unit is capable of reading. The quick formatted DVD-RW/HD DVD-RW media <i>shall</i> be reported as “Unknown capacity media” with Descriptor Type = 11b.

The Block Length specifies the length in bytes of each logical block.

Table 649 - Formattable Capacity Descriptor(s)

Bit Byte	7	6	5	4	3	2	1	0
0	Number of Blocks							
1								
2								
3								
4	Format Type					Reserved		
5	Type Dependent Parameter							
6								
7								

The Format Type field indicates the type of information for formatting.

Table 650 - Format Types

Format Type	Description	Applicable Media Type	Type Dependent Parameter
00h	Full Format: The Number of Blocks field indicates the number of addressable blocks and the Type Dependent Parameter field indicates the block size used for formatting the whole media. If multiple formatting for the whole media is possible, each capacity/block size combination <i>shall</i> be reported as a separate descriptor.	All	Block Length in bytes
01h	Spare Area Expansion: The Number of Blocks field indicates the number of addressable blocks and the Type Dependent Parameter field indicates the block size used for formatting the whole media. If multiple formatting for the whole media is possible, each capacity/block size combination <i>shall</i> be reported as a separate descriptor.	DVD-RAM, HD DVD-RAM	Block Length in bytes
02h-03h	Reserved	-	-
04h	Obsolete (Zone Reformat)	DVD-RAM	Obsolete
05h	Obsolete (Zone Format)		Obsolete
06h-0Fh	Reserved	-	-
10h	-RW Full Format: The Number of Blocks field indicates the maximum number of addressable blocks and the Type Dependent Parameter field indicates the maximum packet size that can be used to fully format CD-RW or the Blocking size of DVD-RW media. The packet size and number of addressable blocks may be adjusted downward by the host before sending this descriptor back via the FORMAT UNIT command.	CD-RW, DVD-RW, HD DVD-RW	Fixed Packet Size in sectors/ Blocking size in sectors
11h	Grow Session: The Number of Blocks field indicates the maximum number of addressable blocks and the Type Dependent Parameter field indicates the packet size which can be used to expand (grow) the last complete session/Border of CD-RW, DVD-RW or HD DVD-RW media. The number of addressable blocks may be adjusted downward by the host before sending this descriptor back via the FORMAT UNIT command.	CD-RW, DVD-RW, HD DVD-RW	Fixed Packet Size in sectors/ ECC block size in sectors

Table 650 - Format Types (continued)

Format Type	Description	Applicable Media Type	Type Dependent Parameter
12h	Obsolete (Add Session/Border on CD-RW or DVD-RW)	-	Obsolete
13h	Quick Grow Border: The Number of Blocks field indicates the maximum number of addressable blocks and the Type Dependent Parameter field indicates the ECC block size which can be used to expand (grow) the last complete Border of DVD-RW media as an intermediate state. The number of addressable blocks may be adjusted downward by the host before sending this descriptor back via the FORMAT UNIT command.	DVD-RW, HD DVD-RW	ECC block Size in sectors
14h	Obsolete (Quick Add Border on DVD-RW)	-	Obsolete
15h	Quick Format: The Number of Blocks field indicates the maximum number of addressable blocks and the Type Dependent Parameter field indicates ECC block size that can be used to fully format DVD-RW media as an intermediate state. The number of addressable blocks may be adjusted downward by the host before sending this descriptor back via the FORMAT UNIT command.	DVD-RW, HD DVD-RW	ECC block Size in sectors
16h	Test Zone Expansion: The descriptor <i>shall not</i> be reported. This Format type is used for extending Test zone in HD DVD-R media by using FORMAT UNIT command.	HD DVD-R SL	-
17h	Dual Layer Instant Recording Setup for L1: The Formattable Capacity Descriptor <i>shall not</i> be reported.	HD DVD-R DL, HD DVD-RW DL	
18h	Fast Re-format Two descriptors <i>shall</i> be reported. The Number of Blocks field in the first descriptor <i>shall</i> indicate the maximum capacity to be formatted in the shortest execution time. The value <i>shall</i> be calculated by the following formula; $\text{Number of Blocks} = \max(D70-MA, \min(OR0, \overline{OR1}))$ where D70-MA is the PSN at the diameter of 70mm minus the width of the Middle Area. If both OR0 and $\overline{OR1}$ specifies ED0, the Number of Blocks field <i>shall</i> indicate the maximum number of addressable blocks. The Number of Blocks field in the second descriptor <i>shall</i> indicate the maximum number of addressable blocks. The Type Dependent Parameter field <i>shall</i> indicate the Blocking size in sectors that can be used to format DVD-RW media.	DVD-RW DL	Blocking size in sectors
19h	Fragment recording Format: The Number of Blocks field indicates the number of addressable blocks and the Type Dependent Parameter field indicates the block size	HD DVD-RW SL	ECC block Size in sectors
1Ah-1Fh	Reserved	-	-
20h	Obsolete (Full Format with sparing parameters)	-	Obsolete
21h-23h	Reserved	-	Reserved
24h	MRW Format	See MMC	See MMC
25h	Reserved	-	Reserved
26h	DVD+RW Basic Format	See MMC	See MMC
27h-2Fh	Reserved	-	Reserved
30h	BD-RE Format with Spare Areas	See MMC	See MMC

Table 650 - Format Types (continued)

Format Type	Description	Applicable Media Type	Type Dependent Parameter
31h	BD-RE Format without Spare Areas	See MMC	See MMC
32h	BD-R Format with Spare area	See MMC	See MMC
33h-3Fh	Reserved	-	Reserved

The Number of Blocks field indicates the number of addressable blocks for the capacity defined by each Format Type.

The Type Dependent Parameter contents are as specified for each Format Type in Table 650. In the case of Format Type 20h, M specifies SL where $SL = 2^M$, $4 \leq M \leq 15$ or $SL = 0$ if $M = 0$ and N identifies SI where $SI = 2^N$, $4 \leq N \leq 24$. The Type Dependent Parameter *shall* be set to $M \times 10000h + N$, effectively placing M in byte offset 5 and N in byte offset 7, and making byte 8 reserved. The logical unit *shall* supply its default values for M and N.

The logical unit *shall* only return Formattable Capacity Descriptors that apply to the installed media. If there is no medium installed, the logical unit *shall* return only the Current/Maximum Capacity Descriptor, with the maximum capacity of a medium that the logical unit is capable of reading.

A Formattable Capacity Descriptor of Format Type 00h *shall* be reported if any other Formattable Capacity Descriptor is reported.

The descriptors *shall* be returned in ascending order of Format Type. For Format Types other than 04h and 05h, if multiple format descriptors exist, they *shall* be returned in logical unit preferred order. For Format Types 04h and 05h, the format descriptors *shall* be returned in ascending order of Zone number.

Formattable Capacity Descriptors for media that can be read, but cannot be formatted by the logical unit *shall not* be reported.

Table 651 - Returned Current/Maximum Descriptor for Combination of drive and media

		Media			
		No Media	ROM Media	Sequential Writable Media	Random Writable Media
Drive	ROM	Descriptor Type = 11b	Descriptor Type = 10b	Descriptor Type = 10b or 11b	Descriptor Type = 10b
	Sequential Writable			Descriptor Type = 10b	Descriptor Type = 10b
	Random Writable			Descriptor Type = 10b or 11b	Descriptor Type = 01b or 10b plus Formattable Capacity Descriptor(s)

Note: This command is not mandatory for all drive types shown in Table 651; the table indicates the values returned if the command is implemented.

Table 652 describes errors that may occur during the operation of the command or which may cause a CHECK CONDITION status to be reported.

Table 652 - READ FORMAT CAPACITIES command errors

Error Description
A-1.1, "Deferred Error Reporting" on page 919
Table 835 - Basic Error Codes on page 932
Table 836 - Media Access Error Codes on page 935

17.26 READ SUBCHANNEL command

The READ SUBCHANNEL command requests that the CD logical unit return the requested sub-channel data plus the state of play operations.

Table 653 - READ SUBCHANNEL Command Descriptor Block

Bit Byte	7	6	5	4	3	2	1	0
0	Operation Code (42h)							
1	LUN (Obsolete)			Reserved			MSF	Reserved
2	Reserved	SubQ	Reserved					
3	Sub-channel Data Format							
4	Reserved							
5	Reserved							
6	Track Number							
7	(MSB) Allocation Length (LSB)							
8								
9	Vendor-Specific		Reserved			NACA	Flag	Link
10	PAD							
11								

Sub-channel data returned by this command may be from the last appropriate sector encountered by a current or previous media accessing operation. When there is no current play operation, the CD logical unit may access the media to read the sub-channel data. The CD logical unit is responsible for ensuring that the data returned are current and consistent.

See 3.6, "CD address reporting formats (MSF bit)" on page 78 for a description of the MSF bit. Support for the MSF bit is mandatory.

The SubQ bit set to one requests that the CD logical unit return the Q sub-channel data. The SubQ bit set to zero requests that no sub-channel data be returned. This *shall not* be considered an error. Support for the SubQ bit is mandatory. When the SubQ bit is Zero, only the Sub-Channel data header is returned. See Table 655.

The Sub-channel Data Format field specifies the returned sub channel data. If this field is 01h, 02h or 03h, the requested sub-Q data item is returned.

Table 654 - Sub-channel Data Format Codes

Format Code	Returned data	Support Requirement
00h	Reserved	Reserved
01h	CD current position	Mandatory
02h	Media catalogue number (UPC/bar code)	Mandatory
03h	Track international standard recording code (ISRC)	Mandatory
04h-EFh	Reserved	
F0h-FFh	Vendor-specific	Optional

The Track Number field specifies the track number from which the ISRC code is transferred. This field *shall* have a value from 01h to 63h (99d), and is valid only when the sub-channel data format is 03h. If this field is nonzero for any Sub-channel Data Formats other than 03h, the drive will terminate the command with a check condition (INVALID REQUEST / INVALID FIELD IN COMMAND PACKET).

The result data format is a Sub-Channel Data Header followed by data specified by the Sub-channel Data Format Code.

The Allocation Length field *shall* indicate the maximum number of bytes the drive *shall* return to the host. An Allocation Length field of zero *shall not* be considered an error.

Table 655 - Sub-channel Data Header format

Bit Byte	7	6	5	4	3	2	1	0
0	Reserved							
1	Audio Status							
2	(MSB)							
3	Sub-channel Data Length (LSB)							

17.26.1 CD Current Position Data Format

Table 656 describes the result data format if Format Code 01h is requested.

Table 656 - CD Current Position Data format (Format Code 01h)

Bit Byte	7	6	5	4	3	2	1	0
Sub Channel Data Header								
0	Reserved							
1	Audio Status							
2	(MSB)							
3	Sub-channel Data Length (LSB)							
CD Current Position Data Block								
0	Sub Channel Data Format Code (01h)							
1	ADR				Control			
2	Track Number							
3	Index Number							
4	(MSB)							
5	Absolute CD Address							
6	See Table 6 - <i>MSF address format</i> on page 78							
7	(LSB)							
8	(MSB)							
9	Track Relative CD Address							
10	See Table 6 - <i>MSF address format</i> on page 78							
11	(LSB)							

The **Audio Status** field indicates the status of play operations. The **Audio Status** values are defined in Table 657 - *Audio Status codes* on page 781. **Audio Status** values 13h and 14h return information on previous audio operations; they are returned only once after the condition has occurred. If another play operation is not requested, the **Audio Status** returned for subsequent READ SUBCHANNEL commands is 15h.

Table 657 - Audio Status codes

Status	Description
00h	Audio status byte not supported or not valid
11h	Play operation in progress
12h	Play operation paused
13h	Play operation successfully completed
14h	Play operation stopped due to error
15h	No current audio status to return

The Sub-channel Data Length specifies the length in bytes of the following sub-channel data block. A Sub-channel Data Length of zero indicates that no sub-channel data block is included in the returned data. Sub-channel Data Length does not include the sub channel header.

The Sub-Q Channel Data Block consists of control data (bytes 4 - 5), current position data (bytes 6 - 15) and identification data (bytes 16 - 47). The control data and current position data is obtained from the Q sub-channel information of the current block. Identification data may be reported that was obtained from a previous block. If identification data is reported, the data *shall* be valid for the sector addressed by the current position data.

1. If an play operation is proceeding in the background, position data for the last sector played *shall* be reported.
2. In other cases, for instance after a READ command, the CD logical unit may either report position data for the last sector processed for that operation or may report position data from the sector at the current read head position.

The ADR field gives the type of information encoded in the Q sub-channel of this block, as shown in the following table.

Table 658 - ADR Sub-channel Q Field

ADR code	Description
0h	Sub-channel Q mode information not supplied
1h	Sub-channel Q encodes current position data (i.e. track, index, absolute address, relative address)
2h	Sub-channel Q encodes media catalogue number
3h	Sub-channel Q encodes ISRC
4h-Fh	Reserved

For a description of the Sub-Q channel Control bits, see Table 676 - *Bit Definitions for the Control field in Sub-channel Q* on page 797.

The Track Number field *shall* indicate the Track number of the current track.

The Index Number specifies the index number in the current track.

The Absolute CD Address field gives the current location relative to the logical beginning of the media. If the MSF bit is zero, this field is a logical block address. If the MSF bit is one, this field is an absolute MSF address.

The Track Relative CD Address field gives the current location relative to the logical beginning of the current track. If the MSF bit is zero, this field is a track relative logical block address. (If the current block is in the pre-gap area of a track, this will be a negative value, expressed as a twos-complement number.) If the MSF bit is one, this field is the relative MSF address from the Q sub-channel.

17.26.2 Media Catalogue Number Data Format

The Media Catalogue Number Data Format is shown in Table 659.

Table 659 - Media Catalogue Number Data Format (Format Code 02h)

Bit Byte	7	6	5	4	3	2	1	0
Sub Channel Data Header								
0	Reserved							
1	Audio Status							
2	MSB Sub-channel Data Length LSB							
3								
Media Catalogue Number Data Block								
0	Sub Channel Data Format Code (02h)							
1	Reserved							
2	Reserved							
3	Reserved							
4	Media Catalogue Number (UPC/Bar Code) (See Table 660 - <i>UPC Format</i> on page 783)							
:								
:								
19								

A Media Catalogue Valid (MCVal) bit of one indicates that the media catalogue number field is valid. A MCVal bit of zero indicates that the media catalogue number field is not valid.

The Media Catalogue Number field contains the identifying number of this media according to the universal product code values (UPC/EAN bar coding) expressed in ASCII. Non-zero values in this field are controlled by the Uniform Code Council, Inc.¹ and the EAN International². A value in this field of all ASCII zeros indicates that the media catalogue number is not supplied.

If media catalogue number data is found, the MCVal bit is set to one. If MCN data is not detected, the MCVal bit is set to zero to indicate the Media Catalogue Number field is invalid.

The Media Catalogue Number data returned by this command with sub-channel data format field code 02h may be from any block that has UPC bar code Q sub-channel data. (This code is constant anywhere in every applicable disc.)

The CD logical unit may either return the UPC information that it has previously read (Cached data) or may scan for the information. As the UPC is only guaranteed to be contained in 1 out of 100 sectors and errors may be encountered, the time required to return the UPC data could be several seconds.

1. The Uniform Code Council, Inc. is located at 1009 Lenox Drive, Suite 202 Lawrenceville, NJ 08648.

2. The EAN International is located at 145 rue Royale B - 1000 Brussels, Belgium.

Table 660 - UPC Format

Bit Byte	7	6	5	4	3	2	1	0
0	MCVal	Reserved						
1	N1 (Most significant)							
2	N2							
3	N3							
4	N4							
5	N5							
6	N6							
7	N7							
8	N8							
9	N9							
10	N10							
11	N11							
12	N12							
13	N13 (Least significant)							
14	Zero							
15	AFrame (Binary)							

N1 through N13 *shall* be retrieved from the Q channel in mode 2. The data *shall* be encoded as ASCII characters (i.e. if N1 of the UPC is 01bcd, then N1 of the above field *shall* be 49d or 31h).

17.26.3 Track International Standard Recording Code Data Format

The Track ISRC field contains the identifying number of this media according to the ISRC standards (DIN-31-621). The result data format is described in Table 661.

Table 661 - Track International Standard Recording Code Data Format

Bit Byte	7	6	5	4	3	2	1	0
Sub Channel Data Header								
0	Reserved							
1	Audio Status							
2	(MSB) Sub-channel Data Length (LSB)							
3								
Track ISRC Data Block								
0	Sub Channel Data Format Code (03h)							
1	ADR (03)				Control			
2	Track Number							
3	Reserved							
4	Track International Standard Recording Code (ISRC) See Table 663 - <i>ISRC Format of Data Returned to host</i> on page 784.							
:								
:								
19								

If ISRC data is detected, the TCVal bit is set to one. If ISRC data is not detected, the TCVal bit is set to zero to indicate the Track ISRC field is invalid.

Track ISRC data returned by this command with Sub-channel Data Format field 03h may be from any block in the specified track that has ISRC data. When ADR field is 3 (0011), it is used to assign a unique number to an audio track. This is done by means of the ISRC which is 12 characters long (represented by I1 to I12.) The ISRC can only change immediately after the TNO has been changed.

Table 662 - Raw ISRC Format on the CD Disc

S0, S1	Control	ADR	I1 I2	I3 I4 I5	00	I6 I7 I8 I9 I10 I11 I12	zero	A Frame	CRC		
		3	ISRC 60 bits								

00: These 2 bits are zero.

zero: These 4 bits are zero.

I1, I2 are the country code; I3, I4, I5 are the owner code; I6, I7 are the year of recording; I8, I9, I10, I11, I12 are the serial number of the recording. AFrame is the absolute frame number.

The information returned for the ISRC *shall* be converted to ASCII. The translation used will translate media codes from 00h - 09h to ASCII '0' - '9' and media codes from 10h - 3Fh to ASCII '@' - '0'.

Table 663 - ISRC Format of Data Returned to host

Bit Byte	7	6	5	4	3	2	1	0
0	TCVal	Reserved						
1	I1 (Country Code) Valid codes are ASCII 'A' - 'Z'							
2	I2							
3	I3 (Owner Code) Valid codes are ASCII '0' - '9' & 'A' - 'Z'							
4	I4							
5	I5							
6	I6 (Year of Recording) Valid codes are ASCII '0' - '9'							
7	I7							
8	I8 (Serial Number) Valid codes are ASCII '0' - '9'							
9	I9							
10	I10							
11	I11							
12	I12							
13	Zero							
14	AFrame							
15	Reserved							

The following codes *shall* be valid for the above fields (Table 663):

1. Country Code: 'A' - 'Z' (41h - 5Ah)
2. Owner Code: '0' - '9' and 'A' - 'Z' (30h -39h, 41h - 5Ah)
3. Year of Recording: '0' - '9' (30h - 39h)
4. Serial Number: '0' - '9' (30h - 39h)

Zero field *shall* be set to 00h.

AFRAME may return the frame number in which the MCN was found. This *shall* be a value from 00h to 4Ah. All other values are reserved.

17.26.4 Caching of Sub-Channel Data

Sub-channel Q data *shall* be cached by the drive while playing audio. This is necessary so that the READ SUBCHANNEL or READ CD commands can access the Sub-Channel Q data while executing an immediate command. The device *shall* generate an error if the data is not in the cache.

READ SUBCHANNEL will return the "Current" data, while READ CD will return the specified data and remove any previous (older) data from the cache.

Using "FFFFFFFFh" on READ CD will work just like READ SUBCHANNEL.

Table 664 describes errors that may occur during the operation of the command or which may cause a CHECK CONDITION status to be reported.

Table 664 - READ SUBCHANNEL command errors

Error Description
<i>A-1.1, "Deferred Error Reporting" on page 919</i>
<i>Table 835 - Basic Error Codes on page 932</i>
<i>Table 836 - Media Access Error Codes on page 935</i>

17.27 READ TOC/PMA/ATIP command

The READ TOC/PMA/ATIP command requests that the CD logical unit transfer data from the Table of Contents, the Program Memory Area (PMA), or the Absolute Time in Pre-Grove (ATIP) from CD media.

For DVD/HD DVD media, as there is no TOC, this command will return fabricated information that is similar to that of CD media for some formats. This fabrication is required for some legacy host environments. To retrieve correct information, host *shall* set MSF bit to 0. See Section 17.27.9, "Fabrication of TOC information for DVD/HD DVD media" on page 798.

Table 665 - READ TOC/PMA/ATIP Command Descriptor Block

Bit Byte	7	6	5	4	3	2	1	0
0	Operation Code (43h)							
1	LUN (Obsolete)			Reserved			MSF	Reserved
2	Reserved				Format			
3	Reserved							
4	Reserved							
5	Reserved							
6	Track / Session Number							
7	(MSB) Allocation Length (LSB)							
8								
9	Vendor-Specific		Reserved			NACA	Flag	Link
10	PAD							
11								

See 3.6, "CD address reporting formats (MSF bit)" on page 78 for a description of the MSF bit. The Format field is defined in Table 666.

The Track / Session Number field specifies the starting track number for which the data *shall* be returned. The data is returned in contiguous ascending track number order. A value of AAh requests that the starting address of the Lead-out Area be returned. If this value is zero, the Table of Contents data *shall* begin with the first track or session on the medium.

If the Track / Session Number field is not valid for the currently installed medium, the command *shall* be terminated with CHECK CONDITION status, 5/24/00 INVALID FIELD IN CDB.

When a READ TOC/PMA/ATIP command is presented for a CD-R/RW media, where the first TOC has not been recorded (no complete session) and the Format codes 0000b, 0001b, or 0010b are specified, this command *shall* be rejected with CHECK CONDITION status, 5/24/00 INVALID FIELD IN CDB. Logical units that are not capable of reading an incomplete session on CD-R/RW media *shall* report CHECK CONDITION status, 2/30/02 CANNOT READ MEDIUM - INCOMPATIBLE FORMAT.

Table 666 - Format code definitions for READ TOC/PMA/ATIP command

Format field	Returned Data	Usage	Description	Use of Track/Session Field
0h	TOC	CD Read Feature and Fabricated data for DVD/HD DVD media	The Track/Session Number field specifies starting track number for which the data will be returned. For multi-session discs, this command will return the TOC data for all sessions and for Track number AAh only the Lead-out Area of the last complete session. See Table 667 - <i>READ TOC/PMA/ATIP Data Format (With Format field = 0h)</i> on page 789	Contains the Track number
1h	Session Information	CD Read Feature and Fabricated data for DVD/HD DVD media	This format returns the first complete session number, last complete session number and last complete session starting address. In this format, the Track/Session Number field is reserved and should be set to 00h. NOTE: This format provides the initiator access to the last finalized session starting address quickly. See Table 668 - <i>READ TOC/PMA/ATIP Data Format (With Format field = 1h)</i> on page 790	Reserved
2h	Full TOC	CD Read Feature	This format returns all Q Sub-code data in the Lead-in (TOC) areas starting from a session number as specified in the Track/Session Number field. In this format, the drive will support Q Sub-channel Point field value of A0h, A1h, A2h, Track numbers, B0h, B1h, B2h, B3h, B4h, C0h, and C1h. See Table 669 - <i>READ TOC/PMA/ATIP Data Format (With Format field = 2h)</i> on page 791	Contains the Session number
3h	PMA	Incremental Streaming Write Feature	This format returns all Q Sub-code data in the PMA area. In this format, the Track/Session Number field is reserved and shall be set to 00h. See Table 671 - <i>READ TOC/PMA/ATIP Data Format (With Format field = 3h)</i> on page 793	Reserved
4h	ATIP	Incremental Streaming Write Feature	This format returns ATIP data. In this format, the Track/Session Number field is reserved and shall be set to 00h. See Table 672 - <i>READ TOC/PMA/ATIP Data Format (With Format field = 4h)</i> on page 794	Reserved
5h	CD-Text	CD-Text	This format returns CD-Text information from the Lead-in	Contains the Session number
6h-0Fh	Reserved			

17.27.1 READ TOC/PMA/ATIP Format 0h**Table 667 - READ TOC/PMA/ATIP Data Format (With Format field = 0h)**

Bit Byte	7	6	5	4	3	2	1	0
0	(MSB) TOC Data Length (LSB)							
1								
2	First Track Number							
3	Last Track Number							
TOC Track Descriptors								
0	Reserved							
1	ADR				Control			
2	Track Number							
3	Reserved							
4	MSB Track Start Address LSB							
5								
6								
7								

The READ TOC/PMA/ATIP data consist of four header bytes and zero or more track descriptors. The READ TOC/PMA/ATIP data is dependent upon the format specified in the **Format** field of the COMMAND PACKET.

The **TOC Data Length** specifies the length in bytes of the following TOC data. The **TOC Data Length** value does not include the **TOC Data Length** field itself. This value is not modified when the allocation length is insufficient to return all of the TOC data available.

The **First Track Number** field indicates the first track number in the first complete session Table of Contents.

The **Last Track Number** field indicates the last track number in the last complete session Table of Contents before the Lead-out.

The **ADR** field gives the type of information encoded in the Q sub-channel of the block where this TOC entry was found. The possible **ADR** values are defined in Table 658 - *ADR Sub-channel Q Field* on page 781.

The **Control** field indicates the attributes of the track. The possible **Control** field values are defined in Table 676 - *Bit Definitions for the Control field in Sub-channel Q* on page 797

The **Track Number** field indicates the track number for which the data in the TOC track descriptor is valid. A track number of AAh indicates that the track descriptor is for the start of the Lead-out Area.

The **Track Start Address** contains the address of the first block with user information for that track number as read from the Table of Contents. An **MSF** bit of zero indicates that the **Track Start Address** field contains a Logical Block Address. An **MSF** bit of one indicates the **Track Start Address** field contains an MSF address.

17.27.2 READ TOC/PMA/ATIP Format 1h**Table 668 - READ TOC/PMA/ATIP Data Format (With Format field = 1h)**

Bit Byte	7	6	5	4	3	2	1	0
0	(MSB) TOC Data Length (0Ah) (LSB)							
1								
2	First Complete Session Number (Hex)							
3	Last Complete Session Number (Hex)							
TOC Track Descriptors								
0	Reserved							
1	ADR				Control			
2	First Track Number in Last Complete Session							
3	Reserved							
4	(MSB) Start Address of First Track in Last Session (LSB)							
5								
6								
7								

The TOC Data Length specifies the length in bytes of the available session data. The TOC Data Length value does not include the TOC Data Length field itself. This value is not modified when the allocation length is insufficient to return all of the session data available.

The First Complete Session Number is set to one.

The Last Complete Session Number indicates the number of the last complete session on the disc. The Last Complete Session Number *shall* be set to one for a single session disc or if the logical unit does not support multi-session discs.

The ADR field gives the type of information encoded in the Q sub-channel of the block where this TOC entry was found. The possible ADR values are defined in Table 658 - *ADR Sub-channel Q Field* on page 781.

The Control field indicates the attributes of the track. The possible Control field values are defined in Table 676 - *Bit Definitions for the Control field in Sub-channel Q* on page 797.

First Track Number in Last Complete Session returns the first track number in the last complete session.

The Start Address of First Track in Last Session contains the address of the first block with user information for the first track of the last session, as read from the Table of Contents. An MSF bit of zero indicates that the Start Address of First Track in Last Session field contains a Logical Block Address. An MSF bit of one indicates the Start Address of First Track in Last Session field contains an MSF address.

17.27.3 READ TOC/PMA/ATIP Format 2h

None of the fields in the result data of Format 2h are affected by the MSF bit in the CDB.

Table 669 - READ TOC/PMA/ATIP Data Format (With Format field = 2h)

Bit Byte	7	6	5	4	3	2	1	0
0	(MSB) TOC Data Length (LSB)							
1								
2	First Complete Session Number							
3	Last Complete Session Number							
TOC Track Descriptors								
0	Session Number							
1	ADR				Control			
2	Byte 1 or TNO							
3	Byte 2 or Point							
4	Byte 3 or Min							
5	Byte 4 or Sec							
6	Byte 5 or Frame							
7	Byte 6 or Zero							
8	Byte 7 or PMin							
9	Byte 8 or PSec							
10	Byte 9 or PFrame							

Multiple entries are recorded in the TOC area, but only one of each entry is reported.

For a Format field of 2h, the logical unit should return TOC data for Q sub-channel modes 1 and 5 (except mode 5, point 1 through 40) in the Lead-in Area.

The TOC Data Length specifies the length in bytes of the available TOC data. The TOC Data Length value does not include the TOC Data Length field itself. This value is not modified when the allocation length is insufficient to return all TOC data available.

The First Complete Session Number is set to one.

The Last Complete Session Number indicates the number of the last complete session on the disc. The Last Complete Session Number is set to one for a single session disc or if the logical unit does not support multi-session discs.

The ADR field gives the type of information encoded in the Q sub-channel of the block where this TOC entry was found. The possible ADR values are defined in Table 658 - *ADR Sub-channel Q Field* on page 781.

The Control field indicates the attributes of the track. The possible Control field values are defined in Table 676 - *Bit Definitions for the Control field in Sub-channel Q* on page 797.

Entries in bytes 2 through 10 of the descriptors *shall* be converted to hex by the logical unit if the media contains a value between 0 and 99bcd.

The returned TOC data of a multi-session disc is arranged in ascending order of the session number with duplicates removed. The TOC data within a session is arranged in the order of Q Sub-channel Point field value of A0h-AFh, Track Numbers, B0h-BFh, C0h-FFh. Only recorded Points *shall* be returned.

Q sub-channel formats in the Lead-in Area of the TOC is described in Table 675 - *Lead-in Area, Sub-channel Q formats* on page 796.

Table 670 - READ TOC/PMA/ATIP Track Descriptors

Byte	Point	Action	Description
Byte 0	-	Return a hex value	Session Number
Byte 1	-	No conversion, return as is	ADR / Control
Byte 2	-	0	Track (CD STRUCTURE = 0)
Byte 3	-	If 0-99bcd, then convert to hex	Point
Bytes 4 - 6 (MSF field)	00 - 99	Value should be 00h	
	A0h - AFh	Value should be 00h	
	B0h	Convert to hex	NRA
	B1h - BFh	Convert to hex	Skip Values
	C0	No Conversion	ORP / App Code
	C1	No Conversion	Copy of ATIP additional info 1
	C2 - FFh	No Conversion	Reserved
Byte 7	00h - AFh	Value should be 00h	
	B0h - BFh	Convert to Hex	# Pntrs / Skip
	C0h	No Conversion	Reserved
	C1h	Value should be 00h	
	C2h - FFh	No Conversion	Reserved
Bytes 8 - 10 (MSF field)	00 - 99	Convert to hex	Track Start
	A0h	Convert PMIN to hex, PSEC is returned as is	1st / Last / Start LO
	A1h - AFh	Convert to hex	1st / Last / Start LO
	B0h	Convert to hex	Lead Out Max
	B1h - BFh	Convert to hex	Skip Values
	C0h	Convert to hex	ORP / App Code
	C1h	Convert to hex	1st / Last / Start LO from ATIP
C2h - FFh	No conversion	Reserved	

17.27.4 READ TOC/PMA/ATIP Format 3h

None of the fields in the result data of Format 3h are affected by the MSF bit in the CDB.

Table 671 - READ TOC/PMA/ATIP Data Format (With Format field = 3h)

Bit Byte	7	6	5	4	3	2	1	0
0	(MSB) PMA Data Length (LSB)							
1								
2	Reserved							
3	Reserved							
PMA Descriptors								
0	Reserved							
1	ADR				Control			
2	Byte 1 or TNO							
3	Byte 2 or Point							
4	Byte 3 or Min							
5	Byte 4 or Sec							
6	Byte 5 or Frame							
7	Byte 6 or Zero							
8	Byte 7 or PMin							
9	Byte 8 or PSec							
10	Byte 9 or PFrame							

Multiple entries are recorded in the PMA area.

The PMA Data Length specifies the length in bytes of the available PMA data. The PMA Data Length value does not include the PMA Data Length field itself. This value is not modified when the Allocation Length is insufficient to return all PMA data available. This value is set to 2 plus eleven times the number of descriptors read.

The returned PMA descriptors are arranged in the order found in the PMA, with duplicates removed.

Entries in bytes 2 through 10 of the descriptors *shall* be converted to hex by the logical unit if the media contains a value between 0 and 99bcd.

17.27.5 READ TOC/PMA/ATIP Format 4h

None of the fields in the result data of Format 4h are affected by the MSF bit in the CDB.

Table 672 - READ TOC/PMA/ATIP Data Format (With Format field = 4h)

Bit Byte	7	6	5	4	3	2	1	0
0	MSB							
1	ATIP Data Length							LSB
2	Reserved							
3	Reserved							
ATIP Descriptors								
0	1	Indicative Device Writing Power			Reserved	Reference Speed		
1	0	URU	Reserved					
2	1	Disc Type	Disc Sub-Type			A1	A2	A3
3	Reserved							
4	ATIP Start Time of Lead-in (Min)							
5	ATIP Start Time of Lead-in (Sec)							
6	ATIP Start Time of Lead-in (Frame)							
7	Reserved							
8	ATIP Last Possible Start Time of Lead-out (Min)							
9	ATIP Last Possible Start Time of Lead-out (Sec)							
10	ATIP Last Possible Start Time of Lead-out (Frame)							
11	Reserved							
12-14	A1 Values							
15	Reserved							
16-18	A2 Values							
19	Reserved							
20-22	A3 Values							
23	Reserved							

ATIP Data Length specifies the number of bytes to be transferred in response to the command. The **ATIP Data Length** value does not include the data length field itself. This value is not modified when the **Allocation Length** is insufficient to return all of the ATIP data available.

Indicative Device Writing Power - encoded information indicating the media's recommended initial laser power setting. The meaning of these bits varies between CD-R and CD-RW media.

Reference Speed - encoded information indicating the recommended write speed for the media. 00h = reserved. 01h - 2x recording. Valid only for CD-RW media.

The Unrestricted Use Disc (URU) flag, when set to one, indicates that the mounted CD-R/RW disc is defined for unrestricted use. When the URU flag is set to zero, the mounted CD-R/RW disc is defined for restricted use. To record data to the mounted disc the appropriate Host Application code *shall* be set through the Write Parameters mode page. A Host Application Code of zero may be used to indicate a restricted use disc - general purpose.

Disc Type - zero indicates CD-R media; one indicates CD-RW media.

Disc Sub-Type - reports the following value according to the Orange Book Part 2 or Part 3 (B1,B2,B3).

Table 673 - Disc Type and Disc Sub Type field definition

Media	Disc Type	Disc Sub-Type	Field Definition
CD-R	0	See Orange Book	Media Type (Physical Characteristic)
CD-RW	1	000	Standard Speed CD-RW
		001	High Speed CD-RW

A1 - when set to one, indicates that the A1 Values field is valid. Otherwise, the A1 Values field is invalid.

A2 - when set to one, indicates that the A2 Values field is valid. Otherwise, the A2 Values field is invalid.

A3 - when set to one, indicates that the A3 Values field is valid. Otherwise, the A3 Values field is invalid.

ATIP Start time of Lead-in - the start time of the Lead-in. The value is read from ATIP and returned in hex format. Legal values for the M field are 50h through 63h.

ATIP Last Possible Start Time of Lead-out - the last possible start time of Lead-out. The value is read from ATIP and returned in hex format. Valid values for the M field are 0 through 4Fh.

A1 Values, A2 Values, and A3 Values field definitions depend on an applicable Orange Book.

17.27.6 READ TOC/PMA/ATIP Format 5h

None of the fields in the result data of Format 5h are affected by the MSF bit in the CDB.

Table 674 - READ TOC/PMA/ATIP Data Format (With Format field = 5h)

Bit Byte	7	6	5	4	3	2	1	0
0	(MSB) CD-Text Data Length (LSB)							
1								
2	Reserved							
3	Reserved							
CD-Text Descriptor								
0-17	CD-Text Descriptor							

CD-Text Data Length specifies the number of bytes available to be transferred in response to the command. The CD-Text Data Length value does not include the CD-Text Data Length field itself. This value is not modified when the Allocation Length is insufficient to return all of the CD-Text data available. This length is variable, and depends on the number of recorded Pack Data.

The CD-Text Descriptor field provides Pack Data available in the Lead-in Area of the medium. Each Pack Data consists of 18 bytes of CD-Text information. If Pack Data is recorded repeatedly on the medium, the logical unit should return it only once. CD-Text Pack Data is described in *Appendix G - "CD-Text Format in the Lead-in Area (Informative)"* on page 975.

17.27.7 Sub-channel Q information

Table 675 - Lead-in Area, Sub-channel Q formats

S0, S1	Control / ADR	TNO	Point	Min	Sec	Frame	Zero	Pmin	PSec	PFrame	CRC
4/6	1	00	A0	00 (Absolute time is allowed)			00	First Track num	Disc Type	00	$x^{16} + x^{12} + x^5 + 1$
4/6	1	00	A1	00 (Absolute time is allowed)			00	Last Track num	00	00	
4/6	1	00	A2	00 (Absolute time is allowed)			00	Start position of the Lead-out Area			
4/6	1	00	01-99	00 (Absolute time is allowed)			00	Start position of track			
4/6	5	00	B0	Start time of next possible program in the Recordable Area of the Hybrid Disc			# of pointers in Mode 5	Maximum start time of the outermost Lead Out area in the Recordable Area of the Hybrid Disc			
4/6	5	00	B1	00	00	00	00	# of Skip Interval Pointers (N<=40)	# of Skip Track Pointers (N<=21)	00	
4/6	5	00	B2-B4	Skip #	Skip #	Skip #	Skip #	Skip #	Skip #	Skip #	
4/6	5	00	01-40	Ending time for the interval that should be skipped			Reserved	Start time for interval that should be skipped on playback			
4/6	5	00	C0	Optimum recording power	Application Code	Reserved	Reserved	Start time of the first Lead In Area of the Hybrid Disc			
4/6	5	00	C1	Copy of information from A1 point in ATIP							

Point The Point field defines various types of information:

- 01-99 Track number references
- A0 First Track number in the program area
- A1 Last Track number in the program area
- A2 Start location of the Lead-out Area
- B0 Used to identify a Hybrid Disc (Photo CD)
Contains start time of next possible program area
- B1 Number of Skip Interval Pointers & Skip Track assignments
- B2-B4 Skip Track Assignment Pointers
- C0 Start time of first Lead In area of Hybrid Disc
This only exists in the first Lead In area
- C1 Copy of information from additional area in ATIP

Disc Type Byte This byte contains a definition of the type of disc

- 00h CD-DA or CD-ROM with first track in Mode 1
- 10h CD-I disc
- 20h CD-ROM XA disc with first track in Mode 2

The Control field is defined in Table 676.

Table 676 - Bit Definitions for the Control field in Sub-channel Q

Control Field	Definition
00x0b	2 Audio without Pre-emphasis
00x1b	2 Audio with Pre-emphasis of 50/15µs
10x0b	Audio channels without pre-emphasis (Reserved in CD-R/RW)
10x1b	Audio channels with pre-emphasis of 50/15 µs (Reserved in CD-R/RW)
01x0b	Data track, recorded uninterrupted
01x1b	Data track, recorded incremental
11xxb	Reserved
xx0xb	Digital copy prohibited
xx1xb	Digital copy permitted

17.27.8 Example READ TOC/PMA/ATIP Operations

The following example is based on a 4-session, 12-track Photo CD disc. Data structure is shown as the data to host.

Command Packet: 43h 00 02h 00 00 00 00 10h 00 00 00 00

Table 677 - Example READ TOC/PMA/ATIP Operations

Ses ^a	A/C ^b	TNO ^c	Pnt ^d	Min Sec Frame	Zero	PMin PSec PFrame	Comments
01	14	00	A0	00 00 00	00	01 20 00	First track is 1. XA disc
01	14	00	A1	00 00 00	00	03 00 00	Last track is 3
01	14	00	A2	00 00 00	00	02 08 3F	Lead Out Area on 1st session
01	14	00	01	00 00 00	00	00 02 00	Start address of track 1
01	14	00	02	00 00 00	00	00 08 02	Start address of track 2
01	14	00	03	00 00 00	00	00 15 32	Start address of track 3
01	54	00	B0	04 26 3F	02	40 02 00	Next recordable area address
01	54	00	C0	C0 00 00	00	61 2C 00	Hybrid disc
02	14	00	A0	00 00 00	00	04 20 00	1st track on 2nd session is 4
02	14	00	A1	00 00 00	00	06 00 00	Last track on 2nd session is 6
02	14	00	A2	00 00 00	00	08 20 08	Lead Out Area on 2nd session
02	14	00	04	00 00 00	00	04 28 3F	Start address of track 4
02	14	00	05	00 00 00	00	04 2E 41	Start address of track 5
02	14	00	06	00 00 00	00	06 27 36	Start address of track 6
02	54	00	B0	09 2C 08	01	40 02 00	Next recordable area address
03	14	00	A0	00 00 00	00	07 20 00	1st track on 3rd session is 7
03	14	00	A1	00 00 00	00	09 00 00	Last track on 3rd session is 9
03	14	00	A2	00 00 00	00	0C 27 32	Lead Out Area on 3rd session
03	14	00	07	00 00 00	00	09 2E 08	Start address of track 7
03	14	00	08	00 00 00	00	09 34 10	Start address of track 8
03	14	00	09	00 00 00	00	0B 04 24	Start address of track 9
03	54	00	B0	0E 09 32	01	40 02 00	Next recordable area address
04	14	00	A0	00 00 00	00	0A 20 00	1st track on 4th session is 10
04	14	00	A1	00 00 00	00	0C 00 00	Last track on 4th session is 12
04	14	00	A2	00 00 00	00	12 1B 1A	Lead Out Area on 4th session
04	14	00	0A	00 00 00	00	0E 0B 32	Start address of track 10

Table 677 - Example READ TOC/PMA/ATIP Operations (continued)

Ses ^a	A/C ^b	TNO ^c	Pnt ^d	Min Sec Frame	Zero	PMin PSec PFrame	Comments
04	14	00	0B	00 00 0	00	0E 11 34	Start address of track 11
04	14	00	0C	00 00 00	00	11 08 22	Start address of track 12
04	54	00	B0	13 39 1A	01	40 02 00	Next recordable area address

- a. Ses:session number
- b. A/C:ADR/Control
- c. TNO:00 for Lead In area
- d. Pnt:Point

If you use the following command on this disc:

Command Packet: 43h 00 01h 00 00 00 00h 10h 00 00 00 00, return data would be as shown in Table 678.

Table 678 - Values for Control field in READ TOC/PMA/ATIP

Control Field value	Description
01h	First Session Number
04h	Last Session Number
00h	Reserved
14h	ADR/Control
0Ah (10d)	First Track Number in Last session
00h	Reserved
00h, 00h, F8h, EDh (In LBA format, 63725)	Absolute CD-ROM address of first track in last session -> 14M 9S 50F -> add 2 sec: 14M 11S 50F

17.27.9 Fabrication of TOC information for DVD/HD DVD media

When the READ TOC/PMA/ATIP command is used with DVD/HD DVD media the basic CD information required by some legacy host environments should be fabricated from the DVD/HD DVD Lead-in information. Although there are commands that report the needed information about DVD/HD DVD media to the host, these commands are not used by some BIOS and Legacy OS systems. Thus the need to report some basic information to the host using the READ TOC/PMA/ATIP command is allowed.

This section will give some guidelines to the developer that would like to fabricate information about DVD/HD DVD media to be reported to the READ TOC/PMA/ATIP command.

There are many types of structures that exist in CD media that have no corresponding DVD/HD DVD structure. For example CD media have multiple tracks but DVD/HD DVD data is contained in only one track. As CD media provides Audio and host Data as different types of information and DVD/HD DVD has only host Data, reporting of host data types only can be performed for DVD/HD DVD media.

When reporting the CD media ADR/Control fields for DVD/HD DVD media, the ADR field should contain 1h and the Control field should contain 4h.

17.27.9.1 Conversion of addresses on DVD/HD DVD media to CD MSF addressing

For some forms of the READ TOC/PMA/ATIP command the information that is reported to the host is formatted in a special address form called MSF. The largest address that can be reported using MSF addressing is only 1 151 849 blocks or about 2,35 Gigabytes. Thus addresses larger than this will be truncated. For LBA addressing the full four byte field may be used for the address and thus should not create any truncation.

17.27.9.2 Conversion of DVD/HD DVD track to CD track information

DVD/HD DVD media is different from CD media in that there is only one track and there is no logical track information as used for CD Audio tracks. Thus in providing information to the host using the READ TOC/PMA/ATIP command, there will be only two or three tracks reported to the host: the data tracks and the Lead-out track. If the media is DVD-ROM, DVD-RAM, DVD+RW, HD DVD-ROM or HD DVD-RAM there will only be two tracks reported that should cover the full recorded capacity. When DVD-R/HD DVD-R media that has been recorded using multiple borders is reported, all the border areas except the last one are reported as the first track and the last border is reported as the second track.

For reporting of the starting address for the Lead-out track, the address reported will be one more than the ending address of the last data track reported and less than MSF of 255/59/75.

17.27.9.3 Example Fabricated Data for DVD/HD DVD media

In the following example, the size of the recorded media is larger than the maximum that can be reported using MSF addressing, so the addresses have been truncated.

17.27.9.3.1 Sample 1

The following sample Command Packet requests Format 1 in LBA format.

Command Packet: 43h 00h 01h 00 00 00 00 00 30h 00 00 00

Table 679 - Example READ TOC/PMA/ATIP Operations for DVD/HD DVD media - Format 1

F_Ses ^a	L_Ses ^b	A/C ^c	TNO ^d	Address ^e	Comments
01	01	14	01	0	As if one session exists

- a. F_Ses: First session number
- b. L_Ses: Last session number
- c. A/C: ADR/Control
- d. TNO: First Track in Last Session
- e. Address: Address of First Track in Last Session

17.27.9.3.2 Sample 2

In the following example, the sample Command Packet requests Format 0 in LBA format.

Command Packet: 43h 00 00 00 00 00 00 00 30h 00 00 00

Table 680 - Example READ TOC/PMA/ATIP Operations for DVD/HD DVD media - Format 0

A/C ^a	TNO ^b	Track Start Address	Comments
14	01	00000000h	Track 1
14	AA	00230000h	Lead Out Area

- a. A/C: ADR/Control
- b. TNO: Track Number

Table 681 describes errors that may occur during the operation of the command or which may cause a CHECK CONDITION status to be reported.

Table 681 - READ TOC/PMA/ATIP command errors

Error Description
<i>A-1.1, "Deferred Error Reporting" on page 919</i>
<i>Table 835 - Basic Error Codes on page 932</i>
<i>Table 836 - Media Access Error Codes on page 935</i>

17.28 READ TRACK INFORMATION command

The READ TRACK INFORMATION command provides information about a Track/RZone, regardless of its status. In case of DVD-RAM/ROM, HD DVD-RAM/ROM, the number of RZone and Border is considered one. If this command is required by an implemented Feature, this command *shall* function if any media is present.

For CD, if the PMA/TOC is unreadable, the command *shall* be terminated with CHECK CONDITION status, 3/57/00 UNABLE TO RECOVER TABLE-OF-CONTENTS.

For DVD, if the RMD is unreadable, the command *shall* be terminated with CHECK CONDITION status, 3/11/05 L-EC UNCORRECTABLE ERROR.

For HD DVD, if the RMZ/RMD in Border-out is unreadable, the command *shall* be terminated with CHECK CONDITION status, 3/11/05 L-EC UNCORRECTABLE ERROR.

If this command is issued during a long immediate operation, e.g., CLOSE TRACK/SESSION operation, the logical unit *shall* return NOT READY status with CHECK CONDITION status, 2/04/07 LOGICAL UNIT NOT READY, OPERATION IN PROGRESS.

Table 682 - READ TRACK INFORMATION Command Descriptor Block

Bit Byte	7	6	5	4	3	2	1	0								
0	Operation Code (52h)															
1	LUN (Obsolete)			Reserved		Open	Address/Number Type									
2	Logical Block Address/ Track/Session Number															
3									(MSB)							(LSB)
4																
5																
6																
7	Allocation Length															
8									(MSB)							(LSB)
9	Vendor-Specific		Reserved			NACA	Flag	Link								
10	PAD															
11																

The Address/Number Type field in byte 1 is used to specify the contents of the Logical Block Address/ Track/ Session Number field.

If the Open bit is set to zero, the Track/RZone Information Block of the Track/RZone specified by the Logical Block Address/ Track/Session Number field is returned. If the Open bit is set to one, the Track/RZone Information Block of the open Track/RZone that has the smallest Track/RZone number greater than or equal to the specified Track/RZone number in the Logical Block Address/ Track/Session Number field is returned. When no open Track/RZone exist at the specified Track/RZone (Track/RZone number = n) and higher (Track/RZone number > n), the logical unit *shall* transfer the Track Information Block with the following fields set to all FFh:

- the Session Number (LSB) field,
- the Session Number (MSB) field,
- the Track Number (LSB) field,
- the Track Number (MSB) field,

and all the other fields except Track Information Length field *shall* be set to 00h in the Track Information Block. On CD-R/RW media, when the Address/Number Type field is set to 1 and the Logical Block Address/ Track/Session

Number is set to FFh or when the Address/Number Type field is set to 2, the Open bit *shall* be set to 0. Otherwise the command *shall* be terminated with CHECK CONDITION status, 5/24/00 INVALID FIELD IN CDB.

Note: When Open bit is set to one, the Track Number (MSB) field, the Track Number (LSB) field and the Free Blocks field of Track/RZone Information Block should be checked. If the logical unit does not support the Open bit and ignores the bit, the logical unit reports Track/RZone information of Track/RZone that is specified by Logical Block Address/ Track/Session Number field to host. In this case, the host should increment the Track/RZone number in Logical Block Address/ Track/Session Number field one by one to obtain the next open Track/RZone Information.

The Logical Block Address/ Track/Session Number field is defined in Table 683.

Table 683 - Logical Block Address/ Track/Session Number field definition

Address/ Number Type Value	Logical Block Address/ Track/Session Number field	Description
0	Logical Block Address	T_{LBA} , where T_{LBA} is the number of the Track/RZone which contains the block associated with Logical Block Address.
1	00h ^a	T_{TOC} , where T_{TOC} is the Lead-in Area of the disc
	Valid Track/RZone Number	T_{CDB}
	FFh	For CD, this value means T_{INV} , where T_{INV} is the Track number of the invisible or incomplete Track For DVD/HD DVD, this value means T_{CDB} (RZone number is 255)
2	Border Number	R_{BORDER} , where R_{BORDER} is the number of the first RZone which is in the Border Number.
3	Reserved	

a. If the Open bit is set to one, the setting of this value (00h) is prohibited.

Note: The Address/Number Type 2 is easy way to recognize UDF-Bridge file system that specified by DVD-ROM Book Part 2.

The number of Track/RZone Information Block bytes returned is limited by the Allocation Length parameter of the CDB. An Allocation Length of zero is not an error. Fields not used with the loaded media *shall* return 0.

The format and content of the Track/RZone Information Block is shown in Table 684.

Table 684 - Track Information Block

Bit Byte	7	6	5	4	3	2	1	0
0	(MSB) Track Information Length (LSB)							
1								
2	Track Number (LSB)							
3	Session Number (LSB)							
4	Reserved							
5	LJRS		Damage	Copy	Track Mode			
6	RT	Blank	Packet/Inc	FP	Data Mode			
7	Reserved						LRA_V	NWA_V
8	(MSB) Track Start Address (LSB)							
9								
10								
11								
12	(MSB) Next Writable Address (LSB)							
13								
14								
15								
16	(MSB) Free Blocks (LSB)							
17								
18								
19								
20	(MSB) Fixed Packet Size/ Blocking Factor (LSB)							
21								
22								
23								
24	(MSB) Track Size / RZone End Address (LSB)							
25								
26								
27								
28	(MSB) Last Recorded Address (LSB)							
29								
30								
31								
32	Track Number (MSB)							
33	Session Number (MSB)							
34-35	Reserved							
36	(MSB) Read Compatibility LBA (LSB)							
37								
38								
39								

Table 684 - Track Information Block (continued)

Bit Byte	7	6	5	4	3	2	1	0
40	Next Layer Jump Address							
41								
42								
43								
44	Last Layer Jump Address							
45								
46								
47								

The Track Information Length field specifies the length, in bytes, of the data available to be transferred given a sufficient Allocation Length. The Track Information Length value does not include the Track Information Length field itself. If the Allocation Length specified is less than the Track Information Length, the response *shall* be truncated at the Allocation Length specified. This truncation *shall* not cause a CHECK CONDITION status. The Track Information Length is not modified when the Allocation Length is insufficient to return all of the response data available.

Track/RZone Number is the Track number on CD media, the RZone number on DVD-R/HD DVD-R media, or 1 for media not containing logical tracks.

Session/Border Number is the Session number on CD media, the Border number on DVD/HD DVD media, or 1 for media not containing Sessions or Borders, that contains this Track/RZone.

The Layer Jump recording Status (LJRS) field indicates the status of Layer Jump recording mode of the disc. The definition of this field is shown in Table 685. In case of Reserved RZone or Complete RZone on Layer Jump recording mode disc, the LJRS field *shall* be set to 01b. This field *shall* be valid when the disc to which the Layer Jump recording is applicable is mounted. For all other media, this field *shall* be set to zero.

Table 685 - LJRS field definition

Value	Recording mode		Definition
00b	DAO/Incremental or Non-Layer jump recording		<p>The disc is not in Layer Jump recording mode.</p> <p>On DVD-R discs, the recording mode is either DAO or Incremental recording. Or the disc is blank and Write Type field is set to other than Layer Jump.</p> <p>On DVD-RW SL discs, this code <i>shall</i> be returned.</p> <p>On DVD-RW DL discs, this code is returned when the RZone is in Contiguous condition. See <i>Section 4.21.3.4, "RZone conditions"</i> on page 259.</p>
01b	Layer Jump	Unspecified	<p>The disc is in Layer Jump recording mode.</p> <p>On DVD-R DL discs, the RZone is Complete state, Reserved state or Invisible state. For the Invisible RZone, neither Manual Layer Jump Address nor Jump Interval size for Regular Interval Layer Jump recording is specified.</p> <p>Or the disc is blank and Write Type field is set to Layer Jump.</p> <p>On DVD-RW DL discs, this code is returned when the RZone is in Non-contiguous condition and 1) Active LJB is blank and neither the Layer Jump PSN on Layer 0 nor the Jump interval is specified, or 2) no Active LJB exists. See <i>Section 4.21.3.4, "RZone conditions"</i> on page 259.</p>
10b		Manual	<p>The disc is in Layer Jump recording mode and Manual Layer jump recording is in progress.</p> <p>On DVD-R DL discs, the RZone is Invisible/Incomplete state and is in Manual Layer Jump recording mode.</p> <p>On DVD-RW DL discs, this code is returned when the RZone is in Non-contiguous condition and the Jump interval is not specified and 1) the Layer Jump PSN on Layer 0 is specified, or 2) the Active LJB is not blank. See <i>Section 4.21.3.4, "RZone conditions"</i> on page 259.</p>
11b		Regular Interval	<p>The disc is in Layer Jump recording mode and Regular Interval Layer jump recording is in progress. The Jump Interval size field of the READ DISC STRUCTURE command with Format Code=22h <i>shall</i> report the Jump Interval size in blocks.</p> <p>On DVD-R DL discs, the RZone is Invisible/Incomplete state and is in Regular Interval Layer Jump recording mode.</p> <p>On DVD-RW DL discs, this code is returned when the RZone is in Non-contiguous condition and the Jump interval is specified. See <i>Section 4.21.3.4, "RZone conditions"</i> on page 259.</p>

When the LJRS field is set to other than zero, the Next Layer Jump Address field and the Last Layer Jump Address fields *shall* be present after the Read Compatibility LBA field in Track Information Block. The Packet/Inc bit *shall* be set to one. For DVD-R DL media, the FP bit *shall* be set to zero.

The Damage bit, when set to one, and the NWA_V is set to zero, the Track/RZone *shall* be considered "not closed due to an incomplete write". An automatic repair may be attempted by the logical unit when the CLOSE TRACK/SESSION command is issued. Further incremental writing in this Track/RZone is not possible.

The Damage bit, when set to one, and the NWA_V is set to one, indicates a Track/RZone that may be recorded further in an incremental manner. An automatic repair *shall* be attempted by the logical unit when the next command that requires writing to the Track/RZone is issued. If the repair is successful, the Damage bit *shall* be set to zero. Prior to the start of the repair, the Next Writable Address field *shall* contain the address of the Next Writable Sector assuming a successful repair. The Damage bit *shall* be set to zero for HD DVD-R.

The Copy bit indicates that this track is a second or higher generation copy (CD). For all other media, this bit *shall* be set to zero.

On CD media, the **Track Mode** is the control nibble as defined for mode 1 Q sub-channel for this track. For all other media, this field *shall* be set to 4 except when **Session Number (LSB)**, **Session Number (MSB)**, **Track Number (LSB)** and **Track Number (MSB)** are set to FFh.

For CD, if the **RT** bit is zero, then the Track is not reserved, otherwise the Track is reserved. The **RT** bit indicates that a PMA entry indicating the track's start and end addresses exists. If the logical unit is not capable of reading the PMA or RMA, this field *shall* be set to zero. For DVD/HD DVD, the **RT** bit of zero indicates that the RZone is Complete, Invisible, or Incomplete status. The **RT** bit of one indicates that the RZone is Empty reserved or Partially recorded reserved status.

The **Blank** bit, when set to one, indicates that the Track/RZone contains no written data and **Last Recorded Address** field is invalid. For CD, tracks with the Track Descriptor Block recorded *shall not* be considered blank. In the case of media that does not have logical Tracks, this bit *shall* be set to zero.

The **Packet/Inc** bit, when set to one, indicates that this Track/RZone is to be written only with packets (CD) or incremental recording (DVD). For CD, the **Packet/Inc** bit is valid only when the **RT** bit is set to one or the track indicated is the incomplete track. For DVD-RW DL and HD DVD-R media, the **Packet/Inc** bit *shall* be set to one.

The **Fixed Packet (FP)** bit is valid only when the **Packet/Inc** bit is set to one. When the **Packet/Inc** bit is set to one and the **FP** bit is also set to one, then the track is to be written only with fixed packets on CD media, or the RZone is to be written with restricted overwrite method on DVD-RW media or to be written on HD DVD-RW media. When the **Packet/Inc** bit is set to one and the **FP** bit is set to zero, then the track is to be written only with variable packets on CD media, or the RZone is to be written with incremental recording on DVD-R media. Except for CD-R/-RW, DVD-R or DVD-RW SL media, this field should be zero. For DVD-RW DL media, the **FP** bit *shall* be set to one.

When writing, certain parameters may be set via the Write Parameters mode page. The state of the Track/RZone determines what parameters *shall* be set and which parameters in the mode page *shall* match. Required Write Parameters are defined in Table 686. All parameters common to READ TRACK INFORMATION and the Write Parameters mode page *shall* match if the Write Parameters mode page is used.

Table 686 - Write Parameter Restrictions due to Track/RZone State

RT	Blank	Packet/Inc	LJRS	DVD Write Parameter Restrictions	CD Write Parameter Restrictions
0	0	0	00b	Write type is set to DAO. RZone is Complete state. The logical unit cannot write to the disc.	Can't write to stamped disc, or during track at once on invisible track, or writing session at once mode
X	X	0	01b	Invalid state	Invalid State
			10b		
			11b		
0	0	1	00b	Write type is set to Incremental. RZone is Complete or Incomplete state.	Write type is set to packet.
			01b	Write type is set to Layer Jump recording. RZone is Complete state.	Invalid State
			10b	Write type is set to Layer Jump recording. RZone is Incomplete state and is Manual Layer Jump recording mode.	
			11b	Write type is set to Layer Jump recording. RZone is Incomplete state and is Regular Interval Layer Jump recording ^a mode.	
0	1	0	00b	Write type is set to DAO. RZone is Invisible state The disc is empty. The logical unit cannot start DAO recording in this state. An RZone <i>shall</i> be reserved prior to start DAO recording.	Write type may be set to packet or TAO.
0	1	1	00b	Write type is set to Incremental. RZone is Invisible state and writable.	Invalid State
			01b	Write type is set to Layer Jump recording. RZone is Invisible state. Either Manual Layer Jump recording or Regular Interval recording can be specified.	
			10b	Write type is set to Layer Jump recording. RZone is Invisible state and is Manual Layer Jump recording mode.	
			11b	Write type is set to Layer Jump recording. RZone is Invisible state and is Regular Interval Layer Jump recording mode.	
1	0	0	00b	Write type is set to DAO. RZone is Partially recorded reserved state. The logical unit is performing DAO recording.	Can't write to recorded track or during track at once on reserved track.
1	0	1	00b	Write type is set to Incremental. RZone is Partially recorded reserved state and is writable.	Write type is set to packet.
			01b	Write type is set to Layer Jump recording. RZone is Partially recorded reserved state.	Invalid State
			10b	Invalid State	
			11b	Invalid State	
1	1	0	00b	Write type is set to DAO. RZone is Empty reserved state and ready to start DAO recording.	Write type is set to TAO. Copy bit may be set only if copyright bit in track mode is clear.

Table 686 - Write Parameter Restrictions due to Track/RZone State

RT	Blank	Packet/Inc	LJRS	DVD Write Parameter Restrictions	CD Write Parameter Restrictions
1	1	1	00b	Write type is set to Incremental. RZone is Empty reserved and is writable.	Write type is set to Packet. Copy bit may be set only if copyright bit in track mode is clear. FP and packet size are changeable. <i>Note: It is not possible to create such a track using commands described in this specification.</i>
			01b	Write type is set to Layer Jump recording. RZone is Empty reserved state.	Invalid State
			10b	Invalid State	
			11b	Invalid State	

- a. The READ DISC STRUCTURE command with Format Code = 22h *shall* report the Jump Interval size of the Regular Interval Layer Jump recording.

For CD, when RT, Blank and Packet/Inc bits are set to one, FP bit of a READ TRACK INFORMATION result data is set to zero.

For DVD, when RT bit or Packet/Inc bit is set to one, FP bit of a READ TRACK INFORMATION result data is set to zero.

Table 687 - Track/RZone Status Indications

RT	Blank	Pack et/Inc	FP	LJRS	HD DVD		DVD		CD	
					Write Method	RZone Status	Write Method	RZone Status	Write Method	Track Status
0	0	0	-	00b	-	-	DAO	Complete	Uninterrupted/ TAO/SAO	Complete/ During TAO/SAO
0	0	1	0	00b	Incremental	Incomplete or Complete ^a	Incremental	Incomplete or Complete ^b	Variable	Incomplete
0	0	1	0	01b/ 10b/ 11b	-	-	Layer Jump	Incomplete or Complete ^c	-	(invalid)
0	0	1	1	00b	Sequential formatting or Fragment recording	Complete or Incomplete ^d	Restricted Overwrite	Complete or Incomplete ^e	Fixed	Incomplete
0	0	1	1	01b/ 10b/ 11b	-	-	Restricted Overwrite with Layer Jump	Complete or Incomplete ^e	-	(invalid)
0	1	0	-	00b	-	-	DAO	Invisible	TAO/ Variable/ Fixed ^f (*)	Invisible
0	1	1	0	00b	Incremental	Invisible	Incremental	Invisible	-	(invalid)
0	1	1	0	01b/ 10b/ 11b	-	-	Layer Jump	Invisible	-	(invalid)
0	1	1	1	00b	Sequential formatting	Invisible	Restricted Overwrite	Invisible	-	(invalid)
0	1	1	1	01b/ 10b/ 11b	-	-	Restricted Overwrite with Layer Jump	Invisible	-	(invalid)
1	0	0	-	00b	-	-	DAO	during DAO	TAO	Complete/ During TAO
1	0	1	0	00b	Incremental	Partially recorded reserved	Incremental	Partially recorded reserved	Variable	Complete/ Partially recorded reserved
1	0	1	0	01b/ 10b/ 11b	-	-	Layer Jump	Partially recorded reserved	-	(invalid)
1	0	1	1	00b	-	-	-	(invalid)	Fixed	Complete/ Partially recorded reserved
1	1	0	-	00b	-	-	DAO	Empty reserved before start writing	TAO	Empty reserved

Table 687 - Track/RZone Status Indications (continued)

RT	Blank	Packet/Inc	FP	LJRS	HD DVD		DVD		CD	
					Write Method	RZone Status	Write Method	RZone Status	Write Method	Track Status
1	1	1	0	00b	Incremental	Empty reserved	Incremental	Empty reserved	Variable/Fixed	Empty reserved
1	1	1	0	01b/ 10b/ 11b	-	-	Layer Jump	Empty reserved	-	(invalid)
1	1	1	1	00b	-	-	-	(invalid)	-	(invalid)

- If Free Blocks field is 0, the RZone is Complete state. Otherwise, the RZone is Incomplete state.
- If Free Blocks field is 0, the RZone is Complete state. Otherwise, the RZone is Incomplete state.
- If Free Blocks field is 0, the RZone is Complete state. Otherwise, the RZone is Incomplete state.
- In the case of disc that is in Intermediate state in Sequential formatting mode, the RZone is considered as Incomplete state. In the case of disc that is in Intermediate state in Fragment recording mode, the RZone is considered as Complete state.
- In the case of RZone that is in the intermediate state Bordered Area, the RZone is considered as Incomplete state.
- In case last session is empty, SAO is also valid.

For CD, Data Mode defines the track content. Data Mode is defined in Table 688. For other media, this field should report 1 except when Session Number (LSB), Session Number (MSB), Track Number (LSB) and Track Number (MSB) are set to FFh.

Table 688 - Data Mode definition (CD)

Value	Definition
0h	Reserved
1h	Mode 1 (ISO/IEC 10149)
2h	Mode 2 (ISO/IEC 10149 or CD-ROM XA)
3h-Eh	Reserved
Fh	Data Block Type unknown (no track descriptor block)

The Next Writable Address Valid (NWA_V) bit validates the Next Writable Address field. If NWA_V is zero, then the Next Writable Address field is not valid. Otherwise, the Next Writable Address field is valid. The NWA_V bit *shall* be set to zero if the Track/RZone is not writable for any reason.

The Last Recorded Address Valid (LRA_V) bit validates the last recorded address. If LRA_V is zero, then the Last Recorded Address field is not valid. Otherwise, the Last Recorded Address field is valid. The LRA_V bit *shall* be set to zero if the Track/RZone has damage for any reason and is repaired automatically.

The Track Start Address is the starting address for the specified Track/RZone.

The Next Writable Address, if valid, is the LBA of the next writable user block in the Track/RZone specified by the Logical Block Address/ Track/Session Number field in the CDB. For CD media, the Next Writable Address *shall* be associated with the RT, Blank, and Packet/Inc bits as defined in Table 689. If the Write Type is Raw, the Next Writable Address may be a negative number as required to point to the start of the first Lead-in. When streaming in any Write Type, the Next Writable Address *shall* be the next user data block the logical unit expects to receive if no under-run occurs.

Table 689 - Next Writable Address definition (CD)

RT	Blank	Packet/ Inc	FP	NWA_V	Definition
0	0	0	x	1 ^a	LBA that <i>shall</i> be specified by next write command ^b
0	0	1	0	1 ^c	LBA that <i>shall</i> be specified by next write command ^b
0	0	1	1	1 ^c	LBA that <i>shall</i> be specified by next write command ^{b, d}
0	1	0	0	1	LBA of the first data block after pre-gap ^e
0	1	1	0	x	Not Valid
0	1	1	1	x	Not Valid
1	0	0	x	0 ^a	LBA that <i>shall</i> be specified by next write command ^b
1	0	1	0	1 ^c	LBA that <i>shall</i> be specified by next write command ^b
1	0	1	1	1 ^c	LBA that <i>shall</i> be specified by next write command ^{b, d}
1	1	0	x	1	LBA of the first data block after pre-gap
1	1	1	0	1	LBA of the first data block after pre-gap
1	1	1	1	-	-

a. During TAO (SAO), NWA_V is 1.

b. NWA *shall* be taken account of data blocks in buffer that has not yet been written to media. If the logical unit can write the data of next write command without interrupting of current data streaming (no underrun condition), NWA *shall* be contiguous to last address data in buffer. If WCE in Mode Cache Page is zero, NWA *shall* be taken account of Link Blocks (2 Run-out blocks, 1 Link block and 4 Run-out blocks) in case of Addressing Method-1.

c. When “Free Blocks” becomes 0 (data full), NWA_V becomes 0.

d. NWA *shall* follow the Addressing Method-2 if Method-2 bit in Mode CD Capabilities and Mechanical Status Page is set to one.

e. *In the case of SAO NWA *shall* be the first block after Lead-in for the first track of session.

The Free Blocks field represents the maximum number of user data blocks available for recording in the Track/RZone.

For CD media, this field *shall* be computed as follows: First, the Available Track Space (ATS) *shall* be computed. For the invisible track, $ATS = (StartTimeofLastPossibleLeadout) - NWA + 5$.

For DVD-R/-RW, this field value *shall* exclude the number of BSGA/LLA blocks that are located on the RZone boundary. In the case of Layer Jump recording mode on DVD-R/-RW DL media, the number of BSGA/LLA blocks and Buffer Blocks that are located on LJB boundary *shall* also be excluded to return actual available user data blocks in the RZone.

For a reserved track, $ATS = (PMAStopTime) - NWA + 5$.

If the track is reserved for, or written with, fixed packets, or is the invisible track and the Write Parameters page specifies fixed packets:

$FreeBlocks = IP(ATS / (PacketSize + 7)) \cdot PacketSize$. Otherwise, $FreeBlocks = ATS - 7$

Note: The *StartTimeofLastPossibleLead-out* is the last possible location of the link block at the start of the Lead-out.

Note: If a disc is fully recorded, the PMA entry for the last track will be equal to the *StartTimeofLastPossibleLead-out*.

Addressing within fixed packet written tracks is translated by the logical unit for reading and writing. The NWA *shall* also reflect this translation:

$NWA_{Method2} = NWA_{Method1} - 7 \cdot IP((NWA_{Method1} - TrackStartAddress) / (PacketSize + 7))$

Method 1 is the physical address. Method 2 is used on fixed packet written tracks to hide the link areas from the initiator. The *TrackStartAddress* is a physical address, even if prior tracks are recorded with Method 2. *IP()* is the integer part of the value.

For CD, the **Fixed Packet Size/ Blocking Factor** field is valid only when the **Packet/Inc** and the **FP** bits are both set to one.

For DVD, if the **FP** bit is set to 0, the **Fixed Packet Size/ Blocking Factor** field specifies the number of sectors that is actual disc access unit. In case of DVD, this field is 16 and in case of HD DVD, this field is 32. For DVD-R, **FP** bit 1 is undefined.

If the disc is stamped, then **Damage** = 0, **Blank** = 0, **RT** = 0, and **NWA_V** = 0.

For CD, the **Track Size / RZone End Address** field reports the length in blocks of the user data in the specified track.

The track size *shall* be computed as follows:

First, compute the Complete Track Size (CTS).

For an incomplete track, $CTS = (StartTimeofLastPossibleLeadout) - PMATrackStart + 5$.

For a reserved track, $CTS = (PMAStopTime) - PMAStartTime + 5$.

If the track is reserved for, or written with, fixed packets, or is the invisible track and the Write Parameters page specifies fixed packets:

$$TrackSize = IP(CTS / (PacketSize + 7)) \bullet PacketSize$$

Otherwise,

$$TrackSize = CTS - 7$$

For CD media, the **Track Size / RZone End Address** value may not be exact for the tracks that do not have a PMA entry. The track size of tracks that do not have PMA entries is calculated as follows:

$$TrackSizeofTrack_n = (StartofTrack_n+1) - (StartofTrack_n)$$

where n+1 is the Lead-out if n is the last track recorded in the TOC.

The track size from this calculation may include blocks from the following track and these blocks may not be readable.

For DVD, when **LJRS** field is set to 00b, the **Track Size / RZone End Address** field reports the number of sectors in the specified RZone.

The RZone size *shall* be reported as follows:

For a Complete RZone, this field reports the number of sectors in the specified RZone including all padded sectors except the last 1 or 16 sectors of the RZone.

The RZone size is calculated as the following rule:

First, compute the following bit mask operation to get Linking Status of RZone (LSR):

$$LSR = NextRZoneStartAddress \text{ AND } 0Fh$$

where the NextRZoneStartAddress¹ is the start address of the RZone that is located immediately after the Complete RZone to be calculated.

The "AND" means the mathematical AND operation.

If the $LSR = 0$,

$$RZoneSize = NextRZoneStartAddress - RZoneStartAddress - 16 \text{ sectors};$$

1. If the Complete RZone to be calculated is the last RZone, the *NextRZoneStartAddress* is the start address of the last Border-out, or the start address of the Lead-out if the Border-out does not exist.

Otherwise,

$$RZoneSize = NextRZoneStartAddress - RZoneStartAddress - 1 \text{ sector};$$

where the *RZoneStartAddress* is the start address of the Complete RZone to be calculated.

For an Incomplete RZone or Invisible RZone, this field reports the number of sectors in the specified RZone including unrecorded sectors except the sectors to be used for the Border-out or truncated Border-out and its BSGA (16 sectors). As for truncated Border-out, see 4.17.11.6, "Disc final closure" on page 161. The end address of the Invisible/Incomplete RZone is specified as shown in Table 690.

Table 690 - End Address of the Invisible/Incomplete RZone

Media	Recording mode	Field that specifies the end address of Invisible/Incomplete RZone
DVD-R SL, DVD-RW SL	Incremental recording, DAO recording	Outer limit of Data Recordable area field in Data Area Allocation field of CDZ
DVD-R DL		End PSN of Data Area field in Data Area Allocation field of CDZ
DVD-R DL	Layer jump recording	End sector number of Invisible RZone in Format 4 RMD
DVD-RW DL	-	End PSN of RZone field in Format 3 RMD

The RZone size is calculated as follows:

$$RZoneSize = EndPSNOfRZone - RZoneStartAddress - NumberOfSectorsInBorderOut - 16 \text{ sectors}$$

where the *EndPSNOfRZone* is the end address of the Invisible/Incomplete RZone.
The *NumberOfSectorsInBorderOut* is the number of sectors to be recorded as Border-out or truncated Border-out just before the Lead-out.

For a reserved RZone, this field reports the number of sectors in the specified RZone including all unrecorded sectors except the last 16 sectors of the RZone to be used as a BSGA.

The RZone size is calculated as follows:

$$RZoneSize = NextRZoneStartAddress - RZoneStartAddress - 16 \text{ sectors}$$

For DVD-R DL/-RW DL, when the LJRS field is set to other than 00b, the Track Size / RZone End Address field reports the logical block address of the last sector that is available to record user data in the specified RZone.

For HD DVD, the Track/RZone Size field reports the number of sectors in the specified RZone.

The RZone size *shall* be reported as follows:

For a Complete RZone, this field reports the number of sectors in the specified RZone.

The RZone size is calculated as the following rule:

$$RZoneSize = NextRZoneStartAddress - RZoneStartAddress$$

For an Incomplete RZone or Invisible RZone, this field reports the number of sectors in the specified RZone including unrecorded sectors except the sectors to be used for the Border-out. The end address of the Invisible/Incomplete RZone is specified by the Outer limit of Data Recordable area field in Data Area Allocation field of Control Data Zone.

The RZone size is calculated as follows:

$$RZoneSize = EndPSNOfRZone - RZoneStartAddress$$

where the *EndPSNOfRZone* is the end address of the Invisible/Incomplete RZone.

For a reserved RZone, this field reports the number of sectors in the specified RZone including all unrecorded sec-

tors.

The RZone size is calculated as follows:

$$RZoneSize = NextRZoneStartAddress - RZoneStartAddress$$

The **Last Recorded Address** is the address of last written user data sector of the specified RZone. The last written sector of padded sectors **shall not** be considered as the last written user data sector.

The **Read Compatibility LBA** is a padding recommendation logical block address of the current medium from the Logical Unit that the Initiator may use to ensure a minimal recorded radius. Some read-only logical units are constructed such that a minimal amount of a disc need to be recorded (typically to a radius of 28 ~ 30 mm) in order that it is acceptable as a valid, readable disc. If the disc is DVD+R and the track is the invisible track (i.e., RT=0), the **Read Compatibility LBA** field **shall** be present. For all other media, the **Read Compatibility LBA** is 00000000h.

The **Next Layer Jump Address** is the LBA of the future Layer Jump Address that will cause Layer jump from L0 to L1 or from L1 to L0 of the Reserved/Invisible/Incomplete RZone of DVD-R Dual Layer medium and the Invisible/Incomplete RZone of the DVD-RW DL medium. The reported address is either the LBA on L0 or the LBA on L1. If no more Layer jump occurs in the RZone, this field **shall** be set to 0. So when Layer jump of a Reserved RZone has happened or the RZone is closed, this field **shall** be set to 0. The default value of the blank DVD-R DL and DVD-RW DL media is the end LBA of the L0.

The **Last Layer Jump Address** is the address of the last Layer Jump Address on L0. In case of DVD-R DL or DVD-RW DL medium, only previous Layer Jump Address on L0 is reported. See 4.18.5.1.3, "*LJB structure of Invisible/Incomplete RZone*" on page 176. If no Layer jump has happened in the RZone and the NWA is located on L0, this field **shall** be set to 0. In case of DVD-R DL if the RZone is closed status, this field **shall** report the maximum recorded LBA on L0 in the closed RZone. In case of DVD-RW DL if the RZone is closed status (the medium is closed), this field **shall** report zero. The maximum recorded LBA on L0 of the closed DVD-RW DL medium is reported via **Shifted Middle Area Start Address** of the READ DISC STRUCTURE command.

When the RZone is Invisible or Incomplete state, the **Last Layer Jump Address** field and the **Next Layer Jump Address** fields report the information about Layer Jump Block (LJB). See 4.18.5.1, "*Recording unit*" on page 174.

When the LJRS field is set to 00b and if the **Next Layer Jump Address** field and **Last Layer Jump Address** field present after **Read Compatibility LBA** field, these fields are 00000000h.

Note: READ TRACK INFORMATION shall provide certain valid fields for a disc with Unrecordable status: Track/RZone Number, Session/Border Number, Track Mode, Data Mode, Track/RZone Start Address.

Table 691 describes errors that may occur during the operation of the command or which may cause a CHECK CONDITION status to be reported.

Table 691 - READ TRACK INFORMATION command errors

Error Description
A-1.1, " <i>Deferred Error Reporting</i> " on page 919
Table 835 - <i>Basic Error Codes</i> on page 932
Table 836 - <i>Media Access Error Codes</i> on page 935

17.29 REPAIR RZONE command

An RZone which has been defined for incremental writing may be damaged due to an incomplete ECC block at the end of written data. This may be caused by a RESET or a power-fail condition during a incremental write.

The REPAIR RZONE command will fill multiple of ECC block length data from beginning of damaged sector of the ECC block and ended with linking.

The recovery indicated here only allows the RZone to become writable again.

Table 692 - REPAIR RZONE Command Descriptor Block

Bit Byte	7	6	5	4	3	2	1	0
0	Operation Code (58h)							
1	Reserved							Immed
2	Reserved							
3	Reserved							
4	(MSB)		RZone Number				(LSB)	
5								
6	Reserved							
7	Reserved							
8	Reserved							
9	Vendor-Specific		Reserved			NACA	Flag	Link
10	PAD							
11								

The **Immed** bit allows execution of the REPAIR RZONE command function as an immediate operation. If **Immed** is set to 0, then the requested repair operation is performed to completion prior to returning status. If **Immed** is set to 1, then status is returned once the Command Packet has been validated.

The **RZone Number** specifies the RZone which requires repair.

Behavior of this command is the same as automatic repair. This command causes repair action without an explicit write of data.

For DVD-R, if the **RZone Number** field is set to 0, the RMA may be repaired.

Table 693 describes errors that may occur during the operation of the command or which may cause a CHECK CONDITION status to be reported.

Table 693 - REPAIR RZONE command errors

Error Description
A-1.1, "Deferred Error Reporting" on page 919
Table 835 - Basic Error Codes on page 932
Table 836 - Media Access Error Codes on page 935
Table 837 - Write Error Codes on page 938

17.30 REPORT KEY command

The REPORT KEY command requests the start of authentication process, transfers data for the authentication process, transfers data protected by the authentication process and ends the authentication process. Different type of authentication process and key exchange may be classified by different Key Class. When the Key Class is different, definitions of the rest of Command Descriptor Block may be different. Currently the following Key Classes are assigned as shown in Table 694.

Table 694 - Key Class Definitions

Key Class	Authentication Type
00h	DVD CSS/CPM or CPRM
01h	Obsolete
02h	AACS
03h-1Fh	Reserved
20h	VCPS (See MMC)
21h	SecurDisc
22h-FFh	Reserved

17.30.1 REPORT KEY command for DVD CSS/CPM or CPRM (Key Class = 00h)

The REPORT KEY command with Key Class = 00h is used for DVD CSS/CPM authentication process and CPRM authentication process. The REPORT KEY command with Key Class = 00h requests the start of the authentication process and provides data necessary for authentication and for generating a Bus Key for the DVD logical unit. This command, in conjunction with SEND KEY command, is intended to perform authentication for logical units which conform to DVD content protection scheme and to generate a Bus Key as the result of authentication.

The REPORT KEY command also requests the DVD logical unit to transfer TITLE KEY data, obfuscated by a Bus Key, to the host.

Note: DVD CSS/CPM and CPRM authentication use the same Key Class field value since they have the same Challenge KEY, KEY1, and KEY2 sizes, and since they are licensed through the same entity.

Table 695 - REPORT KEY Command Descriptor Block (Key Class = 00h)

Bit Byte	7	6	5	4	3	2	1	0
0	Operation Code (A4h)							
1	LUN (Obsolete)			Reserved				
2	(MSB) Reserved/Logical Block Address (LSB)							
3								
4								
5								
6	Reserved							
7	Key Class							
8	(MSB) Allocation Length (LSB)							
9								
10	AGID			KEY Format				
11	Vendor-Specific			Reserved		NACA	Flag	Link

The KEY Format field specifies the type of information that is requested to be sent to the host.

The REPORT KEY command with KEY Format field of 000000b or 010001b begins the authentication process. The logical unit, when ready to begin the authentication process, *shall* grant the request by returning an Authentication Grant ID (AGID). If there is no available Authentication Grant ID, the command *shall* be terminated with CHECK CONDITION status, 5/55/00 SYSTEM RESOURCE FAILURE.

The AGID field is used to control simultaneous key exchange sequences. The AGID specified in subsequent Key Exchange commands *shall* match a currently active AGID. An AGID becomes active by requesting one with KEY Format 000000b or 010001b. The AGID remains active until the authentication sequence completes or is invalidated. The AGID field *shall* be reserved when the KEY Format field contains 000000b, 000101b or 010001b.

Note: logical units that support more than one KEY Format for requesting an AGID do not necessarily support simultaneous key exchange sequences.

In case of KEY Format = 000100b, the Reserved/Logical Block Address field specifies the logical block address which contains the TITLE KEY to be sent to the host obfuscated by a Bus Key. In all other cases, this field *shall* be reserved.

The Allocation Length field specifies the maximum length in bytes of the REPORT KEY response data that *shall* be transferred from the logical unit to the host. An Allocation Length of zero indicates that no data *shall* be transferred. This condition *shall not* be considered as an error.

Table 696 - KEY Format code definitions for REPORT KEY command (Key Class = 00h)

Key Format	Returned Data	Description	AGID Use
000000b	AGID for CSS/ CPPM	Returns an AUTHENTICATION GRANT ID for Authentication for CSS/ CPPM	Reserved & N/A
000001b	Challenge KEY	Returns a Challenge KEY	Valid AGID required
000010b	KEY1	Returns a KEY1	
000100b	TITLE KEY	Returns a TITLE KEY obfuscated by a Bus Key	
000101b	ASF	Returns the current state of the Authentication Success Flags for CSS/ CPPM	Reserved & Ignored
001000b	RPC State	Report drive region settings	
010001b	AGID for CPRM	Returns an AUTHENTICATION GRANT ID for Authentication for CPRM	Reserved & N/A
111111b	None	Invalidate Specified AGID. Invalidating an invalid AGID <i>shall not</i> be considered an error. An AGID that has not been granted <i>shall</i> be considered invalid.	Valid AGID required
All other values		Reserved	

17.30.1.1 REPORT KEY data format for DVD CSS/ CPPM, or CPRM (Key Class = 00h)

The following sections 17.30.1.1.1 through 17.30.1.1.7 specifies the data returned to the host for this command with Key Class = 00h.

With KEY Format Code of 111111b, no data *shall* be returned to the host.

17.30.1.1.1 Authentication Grant ID for CSS/CPM (Key Format = 000000b)**Table 697 - REPORT KEY Data format (With KEY Format = 000000b, Key Class = 00h)**

Bit Byte	7	6	5	4	3	2	1	0
0	(MSB) REPORT KEY Data Length (06h) (LSB)							
1								
2	Reserved							
3	Reserved							
AUTHENTICATION GRANT ID FOR CSS/CPM								
0	Reserved							
1	Reserved							
2	Reserved							
3	AGID		Reserved					

This KEY Format requests the logical unit to return an Authentication Grant ID for CSS/CPM. If the authentication process is started by the REPORT KEY command with a KEY Format of 000000b, the authentication *shall* be processed to exchange Key data only for CSS/CPM protected contents.

Note: If the command with this KEY Format is required by an implemented Feature, the command should function, even when the current bit for that Feature is zero.

17.30.1.1.2 Challenge Key (Key Format = 000001b)**Table 698 - REPORT KEY Data format (With KEY Format = 000001b, Key Class = 00h)**

Bit Byte	7	6	5	4	3	2	1	0
0	(MSB) REPORT KEY Data Length (0Eh) (LSB)							
1								
2	Reserved							
3	Reserved							
Challenge Key								
0	(MSB) Challenge Key Value (LSB)							
:								
9								
10	Reserved							
11	Reserved							

The REPORT KEY Data Length field indicates the length in bytes of the following REPORT KEY Data that is available to be transferred to the host. The REPORT KEY Data Length value does not include the REPORT KEY Data Length field itself.

The Challenge Key Value field returns a value to be used to interrogate an external device to determine conformance with the DVD content protection scheme. The external device then generates the corresponding KEY2.

17.30.1.1.3 Key 1 (Key Format = 000010b)

Table 699 - REPORT KEY Data format (With KEY Format = 000010b, Key Class = 00h)

Bit Byte	7	6	5	4	3	2	1	0
0	(MSB) REPORT KEY Data Length (0Ah) (LSB)							
1								
2	Reserved							
3	Reserved							
KEY 1								
0	(MSB) KEY1 Value (LSB)							
:								
4								
5	Reserved							
6	Reserved							
7	Reserved							

The REPORT KEY Data Length field indicates the length in bytes of the following REPORT KEY Data that is available to be transferred to the host. The REPORT KEY Data Length value does not include the REPORT KEY Data Length field itself.

KEY1 Value field returns a value used to determine the logical unit's conformity with DVD Copy Protection scheme by an external device. The KEY1 Value will also be used as a parameter to generate a Bus Key in the logical unit.

When the logical unit is unable to produce a KEY1 Value, this command with KEY Format = 000010b *shall* be terminated with CHECK CONDITION status, 5/6F/01 COPY PROTECTION KEY EXCHANGE FAILURE - KEY NOT PRESENT.

17.30.1.1.4 Copyright Management Information and Title Key (Key Format = 000100b)

Table 700 - REPORT KEY Data format (With KEY Format = 000100b, Key Class = 00h)

Bit Byte	7	6	5	4	3	2	1	0
0	(MSB) REPORT KEY Data Length (0Ah) (LSB)							
1								
2	Reserved							
3	Reserved							
Copyright Management Information								
0	CPM	CP_SEC	CGMS			CP_MOD		
TITLE KEY								
1	(MSB) Title Key Value (LSB)							
2								
3								
4								
5								
6	Reserved							
7	Reserved							

The REPORT KEY Data Length field indicates the length in bytes of the following REPORT KEY Data that is available to be transferred to the host. The REPORT KEY Data Length value does not include the REPORT KEY Data Length field itself.

The CPM bit identifies the presence of copyrighted material in this sector. A value of 0 *shall* indicate material not copyrighted. A value of 1 *shall* indicate copyrighted material.

When the CPM bit is 1, the CP_SEC field indicates whether the specified sector has a specific data structure for copyright protection system. A value of 0 *shall* indicate that no such data structure exists in this sector. A value of 1 *shall* indicate a specific data structure for CSS or CPPM exists in this sector.

When the CPM bit is 1, the CGMS field indicates the restrictions on copying, as shown in

Table 701 - CGMS field definition

CGMS Value	Definition
00b	Copying is permitted without restriction
01b	Reserved
10b	One generation of copies may be made
11b	No copying is allowed

When the CP_SEC bit is 1, the CP_MOD field indicates the copyright protection mode of the specified sector. A value of 0h indicates the sector is scrambled by CSS. A value of 1h indicates the sector is encrypted by CPPM. Other values are reserved.

Title Key Value field returns the TITLE KEY which is obfuscated by a Bus Key. The length of Title Key Value is currently 5 bytes only.

Note: CPPM protected sectors do not contain a TITLE KEY.

When the specified sector does not contain TITLE KEY, this command with KEY Format = 000100b *shall* be terminated with CHECK CONDITION status, 5/6F/01 COPY PROTECTION KEY EXCHANGE FAILURE - KEY NOT PRESENT.

When the logical unit is not in the Bus Key Established state for CSS/CPPM, this command with KEY Format = 000100b *shall* be terminated with CHECK CONDITION status, 5/6F/02 COPY PROTECTION KEY EXCHANGE FAILURE - KEY NOT ESTABLISHED.

17.30.1.1.5 Authentication Success Flag (Key Format = 000101b)

Table 702 - REPORT KEY Data format (With KEY Format = 000101b, Key Class = 00h)

Bit Byte	7	6	5	4	3	2	1	0		
0	(MSB)							REPORT KEY Data Length		(LSB)
1										
2	Reserved									
3	Reserved									
AUTHENTICATION SUCCESS FLAG										
0	Reserved									
1	Reserved									
2	Reserved									
3	Reserved								ASF	

The REPORT KEY Data Length field indicates the length in bytes of the following REPORT KEY Data that is available to be transferred to the host. The REPORT KEY Data Length value does not include the REPORT KEY Data Length field itself.

An ASF bit of one indicates that the authentication process for CSS/CPPM has completed successfully. Note, however, that the ASF value is not relevant to CPPM, since CPPM protected sectors do not contain a Title Key.

For more information on the contents of the ASF, see Figure 18 - *Authentication Flag Sequence* on page 109.

17.30.1.1.6 RPC status (Key Format = 001000b)

Table 703 - REPORT KEY Data format (With KEY Format = 001000b, Key Class = 00h)

Bit Byte	7	6	5	4	3	2	1	0
0	(MSB) REPORT KEY Data Length (06h) (LSB)							
1								
2	Reserved							
3	Reserved							
RPC State								
0	Type Code	# of Vendor Resets Available			# of User Controlled Changes Available			
1	Region Mask							
2	RPC Scheme							
3	Reserved							

The REPORT KEY Data Length field indicates the length in bytes of the following REPORT KEY Data that is available to be transferred to the host. The REPORT KEY Data Length value does not include the REPORT KEY Data Length field itself.

The logical unit *shall not* report an error concerning media to this KEY Format code. See 4.15.1, "Playback limitations by world region" on page 113.

The Type Code field specifies the current state of the Regionalization Process. See Table 704.

Table 704 - Type Code field definition

Type Code	Name	Definition
00b	NONE	No drive region setting
01b	SET	Drive region is set
10b	LAST CHANCE	Drive region is set, with additional restrictions required to make a change.
11b	PERM	Drive region has been set permanently, but may be reset by the vendor if necessary.

of Vendor Resets Available is a count down counter that indicates the number of times that the vendor can reset the region. This value is set to 4 by the drive manufacturer and decremented each time the vendor clears the drive's region. When this value is zero, the vendor can no longer clear the drive's region.

of User Controlled Changes Available is a count down counter that indicates the number of times that the user can set the region. This value is initially 5.

The Region Mask returns a value that indicates the logical unit's specified region. Once the drive region has been set, exactly one bit *shall* be set to zero to indicate the region. Each bit represents one of eight regions. If a bit is set to zero in this field, the disc can be played in the corresponding region. If a bit is set to one in this field, the disc cannot be played in the corresponding region.

RPC Scheme specifies the type of Region Playback Controls being used by the logical unit. See Table 705.

Table 705 - RPC Scheme

RPC Scheme	RPC Name	Definition
00h	Unknown	The logical unit does not enforce Region Playback Controls (RPC).
01h	RPC Phase II	The logical unit <i>shall</i> adhere to this specification and all requirements of the CSS license agreement concerning RPC.
02h-FFh	Reserved	

17.30.1.1.7 Authentication Grant ID for CPRM (Key Format = 010001b)

Table 706 - REPORT KEY Data format (With KEY Format = 010001b, Key Class = 00h)

Bit Byte	7	6	5	4	3	2	1	0
0	(MSB)							
1	REPORT KEY Data Length (06h)							
2	(LSB)							
3	Reserved							
4	Reserved							
AUTHENTICATION GRANT ID FOR CPRM								
0	Reserved							
1	Reserved							
2	Reserved							
3	AGID		Reserved					

The REPORT KEY Data Length field indicates the length in bytes of the following REPORT KEY Data that is available to be transferred to the host. The REPORT KEY Data Length value does not include the REPORT KEY Data Length field itself.

This KEY Format requests the logical unit to return an Authentication Grant ID for CPRM. If the authentication process is started by the REPORT KEY command with a KEY Format of 010001b, the authentication *shall* be processed to exchange Key data only for CPRM protected contents.

Note: If the command with this KEY Format is required by an implemented Feature, the command should function, even when the current bit for that Feature is zero.

17.30.2 REPORT KEY command for AACS (Key Class = 02h)

The REPORT KEY command with Key Class = 02h is used for AACS authentication process. The REPORT KEY command with Key Class = 02h requests the start of the authentication process, requests data necessary for authentication and for generating a Bus Key, generates and returns or just returns the Binding Nonce and ends the authentication process.

Table 707 - REPORT KEY Command Descriptor Block (Key Class = 02h)

Bit Byte	7	6	5	4	3	2	1	0
0	Operation Code (A4h)							
1	LUN (Obsolete)			Reserved				
2	Reserved/Address (MSB) (LSB)							
3								
4								
5								
6								
7	Key Class							
8	Allocation Length (MSB) (LSB)							
9								
10	AGID		KEY Format					
11	Vendor-Specific		Reserved			NACA	Flag	Link

The KEY Format field specifies the type of information that is requested to be sent to the host.

The REPORT KEY command with KEY Format field of 000000b begins the authentication process. The logical unit, when ready to begin the authentication process, *shall* grant the request by returning an Authentication Grant ID for AACS (AGID for AACS). If there is no available Authentication Grant ID for AACS, the command *shall* be terminated with CHECK CONDITION status, 5/55/00 SYSTEM RESOURCE FAILURE.

The AGID field is used to control simultaneous authentication process. The AGID for AACS specified in subsequent commands for the given authentication process *shall* match a currently active AGID for AACS. An AGID for AACS becomes active by requesting one with KEY Format 000000b. The AGID for AACS remains active until the authentication sequence completes or is invalidated. The AGID field *shall* be reserved when the KEY Format field contains 000000b.

The Reserved/Address field contains a value which depends on the value in the KEY Format field.

For KEY Format field = 100000b (Generate Binding Nonce), the Reserved/Address field contains the starting address of the LBA Extent the Binding Nonce is to be recorded.

For KEY Format field = 100001b (Read Binding Nonce), the Reserved/Address field contains the starting address of the LBA Extent the Binding Nonce is to be read.

For other values - The Reserved/Address field *shall* be reserved.

The Reserved/Block Count field specifies a value which depends on the value in the KEY Format field.

For KEY Format field = 100000b (Generate Binding Nonce), the Block Count field contains the length of LBA Extent the Binding Nonce is to be recorded. The length of LBA Extent *shall* be no less than the value in the Block Count for Binding Nonce field in the AACS Feature Descriptor. If the length of LBA Extent designated by the REPORT KEY command is less than this value, the command *shall* be terminated with CHECK CONDITION status, 5/6F/06 INSUFFICIENT BLOCK COUNT FOR BINDING NONCE RECORDING. If the designated LBA Extent is overlapped with other LBA Extent being stored, the command *shall* be terminated with CHECK CONDITION status, 5/6F/07 CONFLICT IN BINDING NONCE RECORDING.

For KEY Format field = 100001b (Read Binding Nonce), the Block Count field contains the length of LBA Extent the Binding Nonce is to be read. The length of LBA Extent *shall* be no less than the value in the Block Count for Binding Nonce field in the AACS Feature Descriptor. If the length of LBA Extent designated by the REPORT KEY command is less than this value, the command *shall* be terminated with CHECK CONDITION status, 5/6F/06 INSUFFICIENT BLOCK COUNT FOR BINDING NONCE RECORDING.

For other values - The Reserved/Block Count field *shall* be reserved.

The Allocation Length field specifies the maximum length in bytes of the REPORT KEY response data that *shall* be transferred from the logical unit to the host. An Allocation Length of zero indicates that no data *shall* be transferred. This condition *shall not* be considered as an error.

Table 708 - KEY Format code definitions for REPORT KEY command (Key Class = 02h)

Key Format	Returned Data	Description	AGID Use
000000b	AGID for AACS	Returns an AUTHENTICATION GRANT ID for Authentication for AACS	Reserved & N/A
000001b	Drive Certificate Challenge	Returns a Drive Certificate Challenge	Valid AGID required
000010b	Drive Key	Returns a Drive Key	
100000b	Binding Nonce	Generates and stores a Binding Nonce and returns it	
100001b	Binding Nonce	Returns a Binding Nonce	
111111b	None	Invalidate Specified AGID for AACS. Invalidating an invalid AGID for AACS <i>shall not</i> be considered an error. An AGID for AACS that has not been granted <i>shall</i> be considered invalid.	
All other values		Reserved	

17.30.2.1 REPORT KEY data format for AACS (Key Class = 02h)

The following sections 17.30.2.1.1 through 17.30.2.1.5 specifies the data returned to the host for this command with Key Class = 02h. With KEY Format value of 111111b, no data *shall* be returned to the host.

17.30.2.1.1 Authentication Grant ID for AACS (Key Format = 000000b)

Table 709 - REPORT KEY Data format (With KEY Format = 000000b, Key Class = 02h)

Bit Byte	7	6	5	4	3	2	1	0
0	(MSB) REPORT KEY Data Length (06h) (LSB)							
1								
2	Reserved							
3	Reserved							
AUTHENTICATION GRANT ID FOR AACS								
0	Reserved							
1	Reserved							
2	Reserved							
3	AGID		Reserved					

The REPORT KEY Data Length field indicates the length in bytes of the following REPORT KEY Data that is available to be transferred to the host. The REPORT KEY Data Length value does not include the REPORT KEY Data Length field itself.

This KEY Format requests the logical unit to return an Authentication Grant ID for AACS.

Note: If the command with this KEY Format is required by an implemented Feature, the command should function, even when the current bit for that Feature is zero.

17.30.2.1.2 Drive Certificate Challenge (Key Format = 000001b)

Table 710 - REPORT KEY Data format (With KEY Format = 000001b, Key Class = 02h)

Bit Byte	7	6	5	4	3	2	1	0
0	(MSB) REPORT KEY Data Length (72h) (LSB)							
1								
2	Reserved							
3	Reserved							
Drive Certificate Challenge								
0	(MSB) Drive Certificate Challenge Data (LSB)							
:								
111								

The REPORT KEY Data Length field indicates the length in bytes of the following REPORT KEY Data that is available to be transferred to the host. The REPORT KEY Data Length value does not include the REPORT KEY Data Length field itself.

The Drive Certificate Challenge Data field returns a value by which the host verifies legitimacy of the logical unit.

17.30.2.1.3 Drive Key (Key Format = 000010b)

Table 711 - REPORT KEY Data format (With KEY Format = 000010b, Key Class = 02h)

Bit Byte	7	6	5	4	3	2	1	0
0	(MSB) REPORT KEY Data Length (52h) (LSB)							
1								
2	Reserved							
3	Reserved							
Drive Key								
0	(MSB) Drive Key Data (LSB)							
:								
79								

The REPORT KEY Data Length field indicates the length in bytes of the following REPORT KEY Data that is available to be transferred to the host. The REPORT KEY Data Length value does not include the REPORT KEY Data Length field itself.

The Drive Key Data field returns a value that is used, together with the Host Key Data to generate the Bus Key.

17.30.2.1.4 Binding Nonce generated by the logical unit (Key Format = 100000b)**Table 712 - REPORT KEY Data format (With KEY Format = 100000b, Key Class = 02h)**

Bit Byte	7	6	5	4	3	2	1	0
0	(MSB) REPORT KEY Data Length (22h) (LSB)							
1								
2	Reserved							
3	Reserved							
Binding Nonce (generated by the logical unit)								
0	(MSB) Binding Nonce Data (LSB)							
:								
31								

The REPORT KEY Data Length field indicates the length in bytes of the following REPORT KEY Data that is available to be transferred to the host. The REPORT KEY Data Length value does not include the REPORT KEY Data Length field itself.

The Binding Nonce Data field returns a Binding Nonce that is generated by this command with KEY Format = 100000b and stored in the logical unit for later recording in a protected manner.

When the logical unit is not in the Bus Key established state of the AACS Authentication, this command with KEY Format = 100000b *shall* be terminated with CHECK CONDITION status, 5/6F/02 COPY PROTECTION KEY EXCHANGE FAILURE - KEY NOT ESTABLISHED.

When the Binding Nonce is not supported by the current disc, this command with KEY Format = 100000b *shall* be terminated with CHECK CONDITION status, 5/30/02 CANNOT READ MEDIUM - INCOMPATIBLE FORMAT.

17.30.2.1.5 Binding Nonce (read from the medium) (Key Format = 100001b)**Table 713 - REPORT KEY Data format (With KEY Format = 100001b, Key Class = 02h)**

Bit Byte	7	6	5	4	3	2	1	0
0	(MSB) REPORT KEY Data Length (22h) (LSB)							
1								
2	Reserved							
3	Reserved							
Binding Nonce (read from the medium)								
0	(MSB) Binding Nonce Data (LSB)							
:								
31								

The REPORT KEY Data Length field indicates the length in bytes of the following REPORT KEY Data that is available to be transferred to the host. The REPORT KEY Data Length value does not include the REPORT KEY Data Length field itself.

The Binding Nonce Data field returns a Binding Nonce that is read from the designated LBA Extent by this command with KEY Format = 100001b in a protected manner.

When the logical unit is not in the Bus Key established state of the AACS Authentication, this command with KEY Format = 100001b *shall* be terminated with CHECK CONDITION status, 5/6F/02 COPY PROTECTION KEY EXCHANGE FAILURE - KEY NOT ESTABLISHED.

When the Binding Nonce is not supported by the current disc, this command with KEY Format = 100001b *shall* be terminated with CHECK CONDITION status, 5/30/02 CANNOT READ MEDIUM - INCOMPATIBLE FORMAT.

17.30.3 REPORT KEY command for SecurDisc (Key Class = 21h)

The REPORT KEY command with Key Class = 21h is used for SecurDisc authentication process. The REPORT KEY command with Key Class = 21h requests the start of the authentication process, requests data necessary for authentication and for generating a Bus Key, generates and returns or just returns the DUID and ends the authentication process.

Table 714 - REPORT KEY Command Descriptor Block (Key Class = 21h)

Bit Byte	7	6	5	4	3	2	1	0																								
0	Operation Code (A4h)																															
1	LUN (Obsolete)			Reserved																												
2	(MSB) (LSB)																															
3									Reserved																							
4																	Reserved															
5																									Reserved							
6																																
7	Key Class																															
8	(MSB) (LSB)																															
9									Allocation Length																							
10	AGID		KEY Format																													
11	Vendor-Specific		Reserved			NACA	Flag	Link																								

The KEY Format field specifies the type of information that is requested to be sent to the host.

The REPORT KEY command with KEY Format field of 000000b begins the authentication process. The logical unit, when ready to begin the authentication process, *shall* grant the request by returning an Authentication Grant ID for SecurDisc (AGID for SecurDisc). If there is no available Authentication Grant ID for SecurDisc, the command *shall* be terminated with CHECK CONDITION status, 5/55/00 SYSTEM RESOURCE FAILURE.

The AGID field is used to control simultaneous authentication process. The AGID for SecurDisc specified in subsequent commands for the given authentication process *shall* match a currently active AGID for SecurDisc. An AGID for SecurDisc becomes active by requesting one with KEY Format 000000b. The AGID for SecurDisc remains active until it is invalidated. The AGID field *shall* be reserved and *shall* be set to zero when the KEY Format field contains 000000b.

The Allocation Length field specifies the maximum length in bytes of the REPORT KEY response data that *shall* be transferred from the logical unit to the host. An Allocation Length of zero indicates that no data *shall* be transferred. This condition *shall not* be considered as an error.

Table 715 - KEY Format code definitions for REPORT KEY command (Key Class = 21h)

Key Format	Returned Data	Description	AGID Use
000000b	AGID for SecurDisc	Returns an AGID for protocol version	Reserved
000001b	Drive Key Contribution	Returns R1, R2, x and AARB Node Key	Valid AGID required
000010b	DUID	Returns encrypted Disc Unique ID	
111111b	None	Invalidate Specified AGID for SecurDisc. Invalidating an invalid AGID for SecurDisc <i>shall not</i> be considered an error. An AGID for SecurDisc that has not been granted <i>shall</i> be considered invalid.	
All other values		Reserved	

17.30.3.1 REPORT KEY data format for SecurDisc (Key Class = 21h)

The following sections 17.30.3.1.1 through 17.30.3.1.3 specifies the data returned to the host for this command with Key Class = 21h. With KEY Format value of 111111b, no data *shall* be returned to the host.

17.30.3.1.1 AGID for SecurDisc (Key Format = 000000b)**Table 716 - REPORT KEY Data format (With KEY Format = 000000b, Key Class = 21h)**

Bit Byte	7	6	5	4	3	2	1	0
0	(MSB) REPORT KEY Data Length (0Ah) (LSB)							
1								
2	Reserved							
3	Reserved							
AGID for SecurDisc								
0	Reserved							
1	Reserved							
2	Drive Protocol Version Number							
3	AGID		Reserved					
4	(MSB) DEVID (LSB)							
5								
6								
7								

The REPORT KEY Data Length field indicates the length in bytes of the following REPORT KEY Data that is available to be transferred to the host. The REPORT KEY Data Length value does not include the REPORT KEY Data Length field itself.

This KEY Format requests the logical unit to return an AGID for SecurDisc.

Drive Protocol Version Number specifies the protocol version number for the authentication sequence supported by the logical unit. If the host supports a more recent version of the protocol but still supports the protocol version supported by the logical unit, the host may choose to use the old protocol version to complete the authentication sequence. For this version of the specification, the protocol version number is 00h.

AGID contains the AGID reserved for this authentication process by the logical unit. This AGID *shall* be passed to all following REPORT KEY and SEND KEY commands.

DEVID specifies the Device ID assigned to the logical unit.

17.30.3.1.2 Drive Key Contribution (Key Format = 000001b)

Table 717 - REPORT KEY Data format (With KEY Format = 000001b, Key Class = 21h)

Bit Byte	7	6	5	4	3	2	1	0
0	(MSB) REPORT KEY Data Length (36h) (LSB)							
1								
2	Reserved							
3	Reserved							
Drive Key Contribution								
0	(MSB) Encrypted Drive Random Number (R1) (LSB)							
:								
15								
16	(MSB) Encrypted Host Random Number (R2) (LSB)							
:								
31								
32	Bit Position Index Value (x)							
33	Reserved							
34	(MSB) AARB Node Key (LSB)							
:								
49								
50-51	Reserved							

The REPORT KEY Data Length field indicates the length in bytes of the following REPORT KEY Data that is available to be transferred to the host. The REPORT KEY Data Length value does not include the REPORT KEY Data Length field itself.

This KEY Format requests the logical unit to return an Drive Key Contribution.

Encrypted Drive Random Number (R1) contains the 128-bit random number generated by the logical unit, encrypted using the secret key PK2 that has been assigned to the application.

Encrypted Host Random Number (R2) contains the 128-bit random number previously sent to the logical unit by the host, encrypted using the secret key PK2 that has been assigned to the application.

Note: R1 and R2 are concatenated before encryption.

Bit Position Index Value (x) specifies the bit position corresponding to the node key in the application authentication revocation block returned by the logical unit. It is also the index inside the key contribution array used by the application to calculate PK2.

AARB Node Key specifies the node key returned by the logical unit which combined with the key contribution array stored inside the application allows the application to calculate PK2.

17.30.3.1.3 DUID (Key Format = 000010b)**Table 718 - REPORT KEY Data format (With KEY Format = 000010b, Key Class = 21h)**

Bit Byte	7	6	5	4	3	2	1	0
0	(MSB) REPORT KEY Data Length (12h) (LSB)							
1								
2	Reserved							
3	Reserved							
DUID								
0	(MSB) Encrypted Disc Unique ID (DUID) (LSB)							
:								
15								

The REPORT KEY Data Length field indicates the length in bytes of the following REPORT KEY Data that is available to be transferred to the host. The REPORT KEY Data Length value does not include the REPORT KEY Data Length field itself.

This KEY Format requests the logical unit to return a DUID

Encrypted Disc Unique ID (DUID) contains the 128-bit Disc Unique ID, encrypted with the bus key.

Table 719 describes errors that may occur during the operation of the command or which may cause a CHECK CONDITION status to be reported.

Table 719 - REPORT KEY command errors

Error Description
<i>A-1.1, "Deferred Error Reporting" on page 919</i>
<i>Table 835 - Basic Error Codes on page 932</i>
<i>Table 836 - Media Access Error Codes on page 935</i>
<i>Table 839 - Authentication Error Codes on page 939</i>

17.31 REQUEST SENSE command

The REQUEST SENSE command requests that the logical unit transfer sense data to the host.

Table 720 - REQUEST SENSE Command Descriptor Block

Bit Byte	7	6	5	4	3	2	1	0
0	Operation Code (03h)							
1	LUN (Obsolete)			Reserved				DESC
2	Reserved							
3	Reserved							
4	Allocation Length							
5	Vendor-Specific		Reserved				Flag	Link
6	PAD							
7								
8								
9								
10								
11								

The DESC bit *shall* be set to zero for Multi-Media logical unit.

The sense data:

1. *shall* be available if an error condition (CHECK CONDITION) had previously been reported to the host;
2. *shall* be available if other information (e.g., medium position) is available in any field.

If the logical unit has no other sense data available to return, it *shall* return a sense key of NO SENSE and an additional sense code of NO ADDITIONAL SENSE INFORMATION. No further CHECK CONDITION status *shall* be generated.

The sense data *shall* be preserved by the logical unit until retrieved by a REQUEST SENSE command or until the receipt of any other I/O command.

The logical unit *shall* return CHECK CONDITION status for a REQUEST SENSE command only to report exception conditions specific to the command itself. For example:

1. A logical unit malfunction prevents return of the sense data.

If a recovered error occurs during the execution of the REQUEST SENSE command, the logical unit *shall* return the sense data with GOOD status. If a logical unit returns CHECK CONDITION status for a REQUEST SENSE command, the sense data may be invalid.

Logical units *shall* be capable of returning at least 18 bytes of data in response to a REQUEST SENSE command. If the Allocation Length is 18 or greater, and a logical unit returns less than 18 bytes of data, the host should assume that the bytes not transferred would have been zeros had the logical unit returned those bytes. Hosts is able to determine how much sense data has been returned by examining the allocation length parameter in the Command Packet and the additional sense length in the sense data. Logical units *shall not* adjust the additional sense length to reflect truncation if the Allocation Length is less than the sense data available.

The sense data format for error codes 70h (current errors) and 71h (deferred errors) are defined in Table 721. Error code values of 72h to 7Eh are reserved. Error code 7Fh is for a vendor-specific sense data format. Logical units *shall* implement error code 70h; implementation of error code 71h is optional. Error code values of 00h to 6Fh are not defined by this Specification and their use is not recommended.

Table 721 - Request Sense Standard Data

Bit Byte	7	6	5	4	3	2	1	0
0	Valid	Error Code (70h or 71h)						
1	Segment Number (Reserved)							
2	Reserved		ILI	Reserved		Sense Key		
3	Information							
6								
7	Additional Sense Length (n - 7)							
8	Command Specific Information							
9								
10								
11								
12	Additional Sense Code							
13	Additional Sense Code Qualifier (Optional)							
14	Field Replaceable Unit Code (Optional)							
15	SKSV	Sense Key Specific						
16								
17								
18	Additional Sense Bytes							
:								
n								

A **Valid** bit of zero indicates that the information field is not as defined in this Specification. A **Valid** bit of one indicates the information field contains valid information as defined in this Specification. Logical units *shall* implement the **Valid** bit.

The **Segment Number** field is reserved.

An **Incorrect Length Indicator (ILI)** bit of one indicates that the requested allocation length did not match the logical block length of the data on the medium.

The **Sense Key**, **Additional Sense Code** and **Additional Sense Code Qualifier** provide a hierarchy of information. The intention of the hierarchy is to provide a top-down approach for a host to determine information relating to the error and exception conditions. The **Sense Key** provides generic categories in which error and exception conditions can be reported. Hosts would typically use sense keys for high-level error recovery procedures. **Additional Sense Codes** provide further detail describing the sense key. **Additional Sense Code Qualifiers** add further detail to the additional sense code. The **Additional Sense Code** and **Additional Sense Code Qualifier** can be used by hosts where sophisticated error recovery procedures require detailed information describing the error and exception conditions.

The **Sense Key** field is mandatory and indicates generic information describing an error or exception condition. The sense keys are defined in Table 726 - *Sense Key descriptions* on page 838.

The contents of the **Information** field is command-specific and is defined within the appropriate section for the command of interest. Logical units *shall* implement the **Information** field. Unless specified otherwise, this field contains the unsigned logical block address associated with the sense key.

The **Additional Sense Length** field indicates the number of additional sense bytes to follow. If the **Allocation Length** of the Command Packet is too small to transfer all of the additional sense bytes, the **Additional Sense Length** is not adjusted to reflect the truncation.

The **Command Specific Information** field contains information that depends on the command that was performed. Further meaning for this field is defined within the command description. When this field is used to report a logical block

address the data contained in this field *shall* be a logical address. Commands that make use of MSF addressing *shall* report the error location in LBA format.

The **Additional Sense Code (ASC)** field indicates further information related to the error or exception condition reported in the **Sense Key** field. Logical units *shall* support the **Additional Sense Code** field. Support of the additional sense codes not explicitly required by this Specification is optional. A list of additional sense codes is in Table 834 - *All Error Codes* on page 920. If the logical unit does not have further information related to the error or exception condition, the Additional Sense Code is set to NO ADDITIONAL SENSE INFORMATION.

The **Additional Sense Code Qualifier (ASCQ)** indicates detailed information related to the **Additional Sense Code**. The ASCQ is optional. If the error or exception condition is reportable by the logical unit, the value returned *shall* be as specified in Table 834 - *All Error Codes* on page 920. If the logical unit does not have detailed information related to the error or exception condition, the ASCQ is set to zero.

Non-zero values in the **Field Replaceable Unit Code** field are used to define a logical unit-specific mechanism or unit that has failed. A value of zero in this field *shall* indicate that no specific mechanism or unit has been identified to have failed or that the data is not available. The **Field Replaceable Unit Code** field is optional. The format of this information is not specified by this Specification. Additional information about the field replaceable unit may be available in the ASCII information page, if supported by the logical unit.

The **Additional Sense Bytes** field may contain command specific data, peripheral device specific data, or vendor-specific data that further defines the nature of the CHECK CONDITION status.

17.31.1 Sense-key Specific

The **Sense Key Specific** field is defined by this Specification when the value of the Sense-key Specific Valid (SKSV) bit is one. The SKSV bit and **Sense Key Specific** field are optional. The definition of this field is determined by the value of the **Sense Key** field. This field is reserved for sense keys not described below. An SKSV value of zero indicates that this field is not as defined by this Specification.

If the **Sense Key** field is set to ILLEGAL REQUEST and the SKSV bit is set to one, the **Sense Key Specific** field indicates which illegal parameters in the Command Packet or the data parameters are in error.

Table 722 - Field Pointer Bytes

Bit Byte	7	6	5	4	3	2	1	0
15	SKSV	C/D	Reserved	Reserved	BPV	Bit Pointer		
16	(MSB) Field Pointer							
17	(LSB)							

A command Data (C/D) bit of one indicates that the illegal parameter is in the Command Packet. A C/D bit of zero indicates that the illegal parameter is in the data parameters sent by the host.

A Bit Pointer Valid (BPV) bit of zero indicates that the value in the **Bit Pointer** field is not valid. A BPV bit of one indicates that the **Bit Pointer** field specifies which bit of the byte designated by the **Field Pointer** field is in error. When a multiple-bit field is in error, the **Bit Pointer** field *shall* point to the most-significant (left-most) bit of the field.

The **Field Pointer** field indicates which byte of the Command Packet or of the parameter data was in error. Bytes are numbered starting from zero, as shown in the tables describing the commands and parameters. When a multiple-byte field is in error, the pointer *shall* point to the most significant (left-most) byte of the field.

If the sense key is RECOVERED ERROR, HARDWARE ERROR or MEDIUM ERROR and if the SKSV bit is one, the **Sense Key Specific** field *shall* be as shown in Table 723.

Table 723 - Actual Retry Count Bytes

Bit Byte	7	6	5	4	3	2	1	0
15	SKSV	Reserved						
16	(MSB)	Actual Retry Count						
17								

The Actual Retry Count field returns implementation-specific information on the actual number of retries of the recovery algorithm used in attempting to recover an error or exception condition. This field should relate to the Retry Count fields within the Read-Write Error Recovery mode page of the MODE SELECT (10) command.

If the sense key is MEDIUM ERROR and the additional sense code & qualifier set to ZONED FORMATTING FAILED DUE TO SPARE LINKING and if the SKSV bit is one, the Sense Key Specific field *shall* be as shown in Table 724.

Table 724 - Zone Number Bytes

Bit Byte	7	6	5	4	3	2	1	0
15	SKSV	Reserved						
16	(MSB)	Zone Number						
17								

The Zone Number field returns the zone number of the first zone which has a spare linking into the zone designated by a FORMAT UNIT command.

If the Sense Key field is set to NOT READY or NO SENSE and the SKSV bit is set to one, the Sense Key Specific field *shall* be as shown in Table 725.

Table 725 - Progress Indication

Bit Byte	7	6	5	4	3	2	1	0
15	SKSV	Reserved						
16	(MSB)	Progress Indication						
17								

The Progress Indication field is a percent complete indication in which the returned value is the numerator that has 65 536 (10000h) as its denominator. The progress indication *shall* be based upon the total operation time including any certification or initialization operations. 17.5.6, "Device Busy Class Events" on page 638 describes progress indication in time unit.

17.31.2 Deferred Errors

Error Code field value of 70h indicates that the CHECK CONDITION status returned is the result of an error or exception condition on the I/O process that returned the CHECK CONDITION status. This includes errors generated during execution of the command by the actual execution process. It also includes errors not related to any command that are first observed during execution of a command. Examples of this latter type of error include disk servo-mechanism, off-track errors, and power-up test errors.

Error Code field value of 71h (deferred error) indicates that the CHECK CONDITION status returned is the result of an error or exception condition that occurred during execution of a previous command for which GOOD status has already been returned. Such commands are associated with use of the immediate bit, with some forms of caching, and with multiple command buffering. Logical units that implement these features are required to implement deferred error reporting.

The deferred error may be indicated by returning CHECK CONDITION status to the host as described below. The subsequent execution of a REQUEST SENSE command *shall* return the deferred error sense information.

If an I/O command terminates with CHECK CONDITION status and the subsequent sense data returns a deferred error, that I/O command *shall not* have been performed. After the logical unit detects a deferred error condition on a logical unit, it *shall* return a deferred error according to the rules described below:

1. If a deferred error can be recovered with no external system intervention, a deferred error indication *shall not* be posted unless required by the error handling parameters of the MODE SELECT (10) command. The occurrence of the error may be logged if statistical or error logging is supported.
2. If a deferred error can be associated with a particular function or a particular subset of data, and the error is either unrecovered or required to be reported by the mode parameters, a deferred error indication *shall* be returned to the host.

Deferred errors may indicate that an operation was unsuccessful long after the command performing the data transfer returned GOOD status. If data that cannot be replicated or recovered from other sources is being stored using buffered write operations, synchronization commands should be performed before the critical data is destroyed in the host. This is necessary to be sure that recovery actions can be taken if deferred errors do occur in the storing of the data.

17.31.3 Sense-key and Sense Code Definitions

Table 726 - Sense Key descriptions

Sense key	Description
0h	NO SENSE. Indicates that there is no specific sense key information to be reported for the designated logical unit. This would be the case for a successful command.
1h	RECOVERED ERROR. Indicates that the last command completed successfully with some recovery action performed by the logical unit. Details may be determinable by examining the additional sense bytes and the information field. When multiple recovered errors occur during one command, the choice of which error to report (first, last, most severe, etc.) is logical unit specific.
2h	NOT READY. Indicates that the logical unit cannot be accessed. Operator intervention may be required to correct this condition.
3h	MEDIUM ERROR. Indicates that the command terminated with a non-recovered error condition that was probably caused by a flaw in the medium or an error in the recorded data. This sense key may also be returned if the logical unit is unable to distinguish between a flaw in the medium and a specific hardware failure (sense key 4h).
4h	HARDWARE ERROR. Indicates that the logical unit detected a non-recoverable hardware failure (e.g., controller failure, logical unit failure, parity error) while performing the command or during a self test.
5h	ILLEGAL REQUEST. Indicates that there was an illegal parameter in the Command Packet or in the additional parameters supplied as data for some commands. If the logical unit detects an invalid parameter in the Command Packet, then it <i>shall</i> terminate the command without altering the medium. If the logical unit detects an invalid parameter in the additional parameters supplied as data, then the logical unit may have already altered the medium.
6h	UNIT ATTENTION. Indicates that the removable medium may have been changed or the logical unit has been reset.
7h	DATA PROTECT. Indicates that a command that reads the medium was attempted on a block that is protected from this operation. The read operation is not performed.
8h	BLANK CHECK. Indicates that a write-once device or a sequential-access device encountered blank medium or format-defined end-of-data indication while reading or a write-once device encountered a non-blank medium while writing.
9h-Ah	Reserved
Bh	ABORTED COMMAND. Indicates that the logical unit has aborted the command. The host may be able to recover by trying the command again. This error is reported for conditions such as an overrun etc.
0Ch-0Dh	Reserved
Eh	MISCOMPARE. Indicates that the source data did not match the data read from the medium.
Fh	Reserved

17.31.4 Using the REQUEST SENSE command

Whenever an Error is reported, the host should issue a REQUEST SENSE command to receive the sense data describing what caused the Error condition. If the host issues some other command, the sense data is lost.

This command may be issued even if CHECK CONDITION status has not been reported to the host.

See *Appendix A - "Error Reporting and Sense Codes (Normative)"* on page 919 for a list of Sense Key, ASC, and ASCQ code values that may be reported to this command.

Table 727 - REQUEST SENSE command errors

Error Description	
5/24/00	INVALID FIELD IN CDB

17.32 RESERVE TRACK command

The RESERVE TRACK command allows reservation of disc space for a Track/RZone or RMZ. A PMA/RMA/RMZ entry for the Track/RZone/RMZ *shall* be either written or cached for writing prior to disc removal.

Table 728 - RESERVE TRACK Command Descriptor Block

Bit Byte	7	6	5	4	3	2	1	0
0	Operation Code (53h)							
1	Reserved						RMZ	ARSV
2	(MSB) Track Reservation Parameter (LSB)							
3								
4								
5								
6								
7								
8								
9								
10	PAD							
11								

When the ARSV (Address Mode reservation) bit is set one, the Track Reservation Parameter field is utilized for the Address Mode reservation as defined in Table 734. When this bit is set to zero, the Track Reservation Parameter field is utilized for the Size Mode reservation as defined in Table 730. Supporting of the Address Mode reservation is not mandatory for Incremental Streaming Writable Feature. When the Address Mode reservation is available, the ARSV bit and the Current bit in Incremental Streaming Writable Feature Descriptor are set to one or the Current bit in Layer Jump recording Feature (0033h) Descriptor is set to one.

The RMZ bit indicates the type of reservation and is shown in Table 729. The RMZ bit is valid only when the ARSV bit is set to 0b. For non-HD DVD-R SL media, the RMZ bit *shall* be set to 0b.

Table 729 - RMZ bit definition

Value	Definition
0b	Reserves Track/RZone
1b	Reserves U-RMZ

This command may work as immediate mode when the logical unit needs longer time to perform the track reservation.

The Track Reservation Parameter field contains the parameter to perform Track/RZone reservation as follows.

17.32.1 Size Mode reservation

When the ARSV bit is set to zero, this command *shall* behave as the Size Mode reservation. The Track Reservation Parameter field for the Size Mode reservation is defined as shown in Table 730.

Table 730 - Track Reservation Parameter definition for the Size Mode reservation

Bit Byte	7	6	5	4	3	2	1	0
2	Reserved							
3								
4								
5	Reservation Size							
6								
7								
8								

The **Reservation Size** field contains the number of user blocks desired for the Track/RZone reservation. The actual number of blocks allocated *shall* be according to the Write Parameters mode page. If size of the reserved Track/Rzone is larger than disc available space, the command *shall* be terminated with CHECK CONDITION status, 5/24/00 INVALID FIELD IN CDB.

Note: If a logical unit does not support the Address Mode reservation, when the fourth byte of the Start LBA of new Invisible Track field of the Track Reservation Parameter is set to a non-zero value, the size of the reserved Track/RZone becomes larger than available disc space. When the fourth byte of the Start LBA of new Invisible Track field is set to zero, the size of the reserved Track/RZone becomes zero. Therefore a legacy logical unit that does not support Address Mode reservation may not modify the disc information.

For both reservation modes, a logical unit *shall* check whether new Reserved RZone satisfies the following conditions.

For CD, the PMA start time *shall* reflect the appropriate pre-gap, as determined by the previous track's mode and the settings of the Write Parameters mode page.

For DVD, when the Write Type field of Write Parameters mode page is set to "Disc-at-once," the Reservation Size field is used to specify the actual size of user data to be transferred from host to the logical unit. When the Write Type field specifies "Incremental," the tail of reserved RZone is rounded up to ECC block unit and one ECC block length is added to the reserved RZone as a BSGA. When the Write Type field specifies "Layer Jump" the tail of reserved RZone is rounded up to ECC block unit and one ECC block length per Layer is added to the reserved RZone as a LLA.

Table 732 specifies the RZone reservation sizing.

For HD DVD, if the RMZ bit is set to 0b, the tail of reserved RZone is round up to ECC block unit. For HD DVD-R SL media, if the RMZ bit is set to 1b, the Reservation Size field *shall* be ignored and the logical unit *shall* reserve RMZ with 128 ECC blocks in size.

Table 731 - RZone/RMZ reservation sizing (HD DVD)

RMZ bit value	Reserved RZone/RMZ Size
0b	Reserves the number of user blocks specified. The Reserved RZone Size <i>shall</i> be $ReservedRZoneSize = 32 \cdot Ceil(ReservationSize / 32)$ where <i>ReservationSize</i> is the value specified in the CDB. Ceil (x) returns the least integer value greater than or equal to x.
1b (valid for HD DVD-R SL media only)	The $ReservedRMZSize = 1000h$ (128 ECC blocks)

Table 732 - RZone reservation sizing (DVD)

Write Parameters mode page Write Type Value	Reserved RZone Size
Disc-at-once	Reserves the number of user blocks specified. The Reserved RZone Size <i>shall</i> be: $ReservedRZoneSize = ReservationSize$ where <i>ReservationSize</i> is the value specified in the CDB.
Incremental/ Layer Jump	Reserves the number of user blocks specified. The Reserved RZone Size <i>shall</i> be: $ReservedRZoneSize = 16 \cdot Ceil((ReservationSize + (NWA AND 0Fh)) / 16) - (NWA AND 0Fh) + SizeOfLLA^a$ where <i>ReservationSize</i> is the value specified in the CDB. NWA is the Next Writable Address of the Invisible RZone. "AND" means mathematical AND. For Incremental recording, the <i>SizeOfLLA</i> =16. For Layer Jump recording, the <i>SizeOfLLA</i> =16 when no L1 part exists and the <i>SizeOfLLA</i> =32 when L1 part exists. <i>Ceil(x)</i> returns the least integer value greater than or equal to x.

a. If the reservation size is equal to the remaining disc capacity, the BSGA *shall not* be added to the reserved RZone size.

Table 733 specifies the PMA stop time.

Table 733 - Track reservation sizing (CD)

Write Parameters mode page Write Type Value	PMA Stop Time
Session-at-once	Return CHECK CONDITION status, 5/2C/00 COMMAND SEQUENCE ERROR.
Track-at-once	Reserves the number of user blocks specified. The PMA stop time <i>shall</i> be $PMAStart + ReservationSize + 2$
Variable Packet	Reserve behaves as in track-at-once.
Fixed Packet	Set $p = ReservationSize / PacketSize$ packets, where packet size is taken from the Write Parameters mode page. If p is an integer, then the reservation is performed and the PMA stop time <i>shall</i> be $PMAStart + (PacketSize + 7) \cdot p - 5$. Otherwise, the reservation is not performed and the logical unit returns CHECK CONDITION status, 5/24/00 INVALID FIELD IN CDB. Enough space for reservation size user data packets <i>shall</i> be reserved.

The Invisible Track/RZone is known to have Track/RZone number N+1 only because the Track/RZone number of the Track/RZone immediately preceding it has Track/RZone number N. Tracks/RZones *shall* only be reserved from the beginning of the invisible Track/RZone. Each Track/RZone prior to the invisible Track/RZone has a Track/RZone number defined in the RMA/PMA/RMZ. After the reservation is done, the Track/RZone number given to the new Track/RZone is the current Track/RZone number of the invisible Track/RZone. The number of the invisible Track/RZone is increased by one following a reservation.

For CD, if the Reservation Size or size of new Reserved Track of Address Mode is smaller than 298, excluding pre-gap length, the logical unit *shall* return CHECK CONDITION status, 5/24/00 INVALID FIELD IN CDB.

For DVD/HD DVD, if the Reservation Size field is set to 0, no reservation is done by logical unit and *shall not* be considered an error.

17.32.2 Address Mode reservation

When the ARSV bit is set to one, this command *shall* behave as the Address Mode reservation. The Track Reservation Parameter field for the Address Mode reservation is defined as shown in Table 734.

Table 734 - Track Reservation Parameter definition for the Address Mode reservation

Bit Byte	7	6	5	4	3	2	1	0
2	(MSB) Start LBA of new Invisible Track (LSB)							
3								
4								
5								
6	Reserved							
7								
8								

The Start LBA of new Invisible Track field *shall* specify the start logical block address of new Invisible Track/RZone. The logical unit *shall* reserve a Track/RZone to create the new Invisible Track/RZone from specified logical block address. The reservation on Incomplete Track/RZone *shall* be allowed except Layer Jump recording mode of DVD-R Dual Layer disc and Fixed Packet mode (Method 2 Addressing) of CD. For these exceptional cases, the Incomplete Track/RZone *shall* be closed prior to perform Address Mode reservation. See 4.19, "Address Mode reservation" on page 223.

The Incomplete Track/RZone becomes an Reserved Track/RZone by the Address Mode reservation. The number of free blocks of the new reserved Track/RZone should be checked by the READ TRACK INFORMATION command. The address *shall* be the multiple of blocking factor shown by the Blocking field of Random Readable Feature (0010h). When the Blocking field is set to zero, the Fixed Packet Size/ Blocking Factor field of the Track Information Block *shall* be checked as blocking factor. If the specified address is not valid, the command *shall* be terminated with CHECK CONDITION status, 5/24/00 INVALID FIELD IN CDB.

Reserving by the Size mode reservation, and the Address Mode reservation on Layer Jump recording mode disc *shall* be allowed when the last Track/RZone is Invisible. When the last Track/RZone is not Invisible, the logical unit *shall* generate CHECK CONDITION status, 5/2C/00 COMMAND SEQUENCE ERROR.

For CD, reserving a Track when the Write Type is set to Packet Writing *shall* cause the TDB (Track Descriptor Block) to be written.

For DVD/HD DVD, the maximum number of Partially recorded reserved RZones is two¹. Attempting to reserve RZone when two¹ RZones are already reserved but not fully recorded, the command *shall* be terminated with CHECK CONDITION status, 5/72/05 NO MORE RZONE RESERVATIONS ARE ALLOWED.

Because three RMD blocks are required for reservation, RZone closure and Border closure, attempting to reserve RZone when remaining ECC blocks in the RMA are less than three, the command *shall* be terminated with CHECK CONDITION status, 3/73/05 PROGRAM MEMORY AREA/RMA IS FULL.

For HD DVD, the Error reporting for the command with RMZ bit = 0 in each condition of the media is shown in Table 191 - Error reporting for "RZone reservation" by using RESERVE TRACK command on page 361.

For HD DVD, when the unrecorded ECC blocks in Current RMZ are equal to or less than 15 ECC blocks, a zone which consists of 128 ECC blocks can be reserved for the Extended RMZ in User data zone (U-RMZ). Attempting to extend U-RMZ when the unrecorded ECC blocks in Current RMZ are greater than 15 ECC blocks, the command with RMZ bit = 1

1. For DVD-R Dual Layer disc, the maximum number of Partially recorded reserved RZones is three.

shall be terminated with CHECK CONDITION status, 5/72/06 RMZ EXTENSION IS NOT ALLOWED. See 5.13.12.5, "Error reporting for "RMZ extension by U-RMZ" by using RESERVE TRACK command" on page 362.

Table 735 - RESERVE TRACK command errors

Error Description
<i>A-1.1, "Deferred Error Reporting" on page 919</i>
<i>Table 835 - Basic Error Codes on page 932</i>
<i>Table 836 - Media Access Error Codes on page 935</i>
<i>Table 837 - Write Error Codes on page 938</i>

17.33 SCAN command

The SCAN command requests a fast-forward or fast-reverse scan operation starting from the Scan Starting Address. The command *shall* scan all the way to the end of the media (last audio track).

This command responds with immediate status, allowing overlapped commands. See also B-9, "Immediate command processing considerations" on page 946.

Table 736 - SCAN Command Descriptor Block

Bit Byte	7	6	5	4	3	2	1	0
0	Operation Code (BAh)							
1	LUN (Obsolete)			DIRECT	Reserved			Obsolete
2	Scan Starting Address (MSB) (LSB)							
3								
4								
5								
6								
7	Reserved							
8	Reserved							
9	Type	Reserved						
10	Reserved							
11	Vendor-Specific			Reserved		NACA	Flag	Link

A Direction (DIRECT) bit of zero indicates a fast-forward. A DIRECT bit of one indicates a fast-reversed operation.

The Scan Starting Address specifies the address at which the Audio Fast Scan *shall* begin. The Type field determines the interpretation of the address.

Like the Audio Play commands, the SCAN command *shall* terminate the scan at the last audio track or upon receipt of the STOP PLAY/SCAN command. Upon receipt of the STOP PLAY/SCAN command the logical unit *shall* set the current address to the last address output during the SCAN command. Subsequent Audio Play commands *shall* cause the logical unit to begin playing at the location last output by the SCAN command. If the logical unit receives a PAUSE/RESUME command with the Resume bit clear, the logical unit *shall* pause. After that, if the logical unit receives a PAUSE/RESUME command with the Resume bit set, the logical unit *shall* resume audio play (note: not scan) from the address where the audio pause occurred. See Figure 224 - Stop Play/Play Audio/Audio Scan/Pause/Resume Sequencing on page 899 for additional information.

If the logical unit receives a SCAN command during play or pause, the logical unit *shall* stop play or pause and perform Scan.

Upon receipt of a READ SUBCHANNEL command during scan, the logical unit *shall* return an Audio Status of 11h (Audio Play operation in Progress).

If the logical unit receives a SCAN command during play or pause for which a valid stop address was specified, the logical unit will remember the stop address but ignore it during the SCAN command. The stop address becomes valid again when audio play resumes. Thus, upon resumption of audio play, if the current address is greater than the former stop address, the logical unit *shall* stop playing and return good status. After this, if the logical unit receives a READ SUBCHANNEL command, the logical unit *shall* return an Audio Status of 13h (Audio Play operation successfully completed).

If the logical unit reaches a data track, it *shall* stop scan.

Request to the implementer: The following implementation of forward and reverse scan speed will provide good quality sound: Forward scan - [Play six CD-DA blocks and then jump 190* CD-DA blocks in the forward direction. Reverse

scan - play six CD-DA blocks and then jump 150 CD-DA blocks (from the last block of the six) in the reverse direction.*

*This can be some fixed number between 150 and 200.

The **Type** field is defined in Table 737. This field specifies the “Type” of address contained in the **Scan Starting Address** field.

Table 737 - Type field

Type field	Definition
00b	Logical Block Address format
01b	AMIN, ASEC and AFRAME format
10b	Track Number (TNO) format
11b	Reserved

See 17.13.1, “PLAY AUDIO (10) with Immediate Packet commands” on page 700 for information on overlapped commands during a SCAN operation.

Table 738 - Scan Starting Address in Logical Block Format

Bit Byte	7	6	5	4	3	2	1	0
2	Scan Starting Address							
3								
4								
5								

Table 739 - Scan Starting Address in AMIN, ASEC and AFRAME Format

Bit Byte	7	6	5	4	3	2	1	0
2	Reserved							
3	CD-absolute time (AMIN)							
4	CD-absolute time (ASEC)							
5	CD-absolute time (AFRAME)							

The AMIN, ASEC and AFRAME fields specifies the relative running time from the beginning of the disc. The AMIN field has a range of 00 to 99d (63h). The ASEC ranges from 00 to 59d (3Bh). The AFRAME field has a range of 00 to 74d (4Ah). All MSF fields *shall* be Binary.

Table 740 - Scan Starting Address in Track Number (TNO) Format

Bit Byte	7	6	5	4	3	2	1	0
2	Reserved							
3	Reserved							
4	Reserved							
5	Track Number (TNO)							

The Track Number field specifies the track in binary notation at which the scan operation will begin. This field has a range of 01h to 63h.

Table 741 - SCAN command errors

Error Description
<i>A-1.1, "Deferred Error Reporting" on page 919</i>
<i>Table 835 - Basic Error Codes on page 932</i>
<i>Table 836 - Media Access Error Codes on page 935</i>

17.34 SEEK command

The SEEK command request that the logical unit seek to the specified logical block address. All Logical Block Addresses are valid targets for a seek operation, including a CD-DA audio sector. The content of the Sector at the specified LBA *shall not* affect the seek operation nor cause an error to be generated.

The SEEK command should be performed as an immediate command. The command should return completion status as soon as the seek operation has been started.

Table 742 - SEEK Command Descriptor Block

Bit Byte	7	6	5	4	3	2	1	0
0	Operation Code (2Bh)							
1	LUN (Obsolete)			Reserved				
2	Logical Block Address (MSB) (LSB)							
3								
4								
5								
6								
7	Reserved							
8	Reserved							
9	Vendor-Specific		Reserved			NACA	Flag	Link
10	PAD							
11								

The Logical Block Address field specifies the destination of the SEEK command.

Table 743 - SEEK command errors

Error Description
<i>A-1.1, "Deferred Error Reporting" on page 919</i>
<i>Table 835 - Basic Error Codes on page 932</i>
<i>Table 836 - Media Access Error Codes on page 935</i>

17.35 SEND CUE SHEET command

A Session-at-once recording is written beginning with the Lead-in and continuing through the Lead-out. Only user data will be sent with the write commands, so a guide structure is required by the CD-R/RW logical unit in order to control the recording process. This guide structure is called the cue sheet. The cue sheet is constructed in the host and sent to the logical unit.

Table 744 - SEND CUE SHEET Command Descriptor Block

Bit Byte	7	6	5	4	3	2	1	0
0	Operation Code (5Dh)							
1	LUN (Obsolete)			Reserved				
2	Reserved							
3	Reserved							
4	Reserved							
5	Reserved							
6	(MSB) Cue Sheet Size (LSB)							
7								
8								
9	Vendor-Specific	Reserved			NACA	Flag	Link	
10	PAD							
11								

The Cue Sheet Size parameter is the number of bytes in the cue sheet to be sent to the logical unit. The entire cue sheet *shall* be received by the logical unit prior to beginning the write process. If the logical unit cannot accept and buffer the entire cue sheet, then the logical unit *shall* return CHECK CONDITION Status, 5/24/00 INVALID FIELD IN CDB.

If the Write Parameters mode page does not have Write Type set to Session-at-once, then the logical unit *shall* return CHECK CONDITION Status, 5/2C/00 COMMAND SEQUENCE ERROR.

If the Write Type in the Write Parameters mode page is changed from session at once, the cue sheet may be lost.

17.35.1 CUE SHEET FORMAT

The Cue Sheet contains information required to specify the layout of a disc to be written, and *shall* be sent to the logical unit via the SEND CUE SHEET command before writing data to the disc.

Table 745 - Cue Sheet Format

Byte Number	Cue Sheet Data
0	Mixture of Information of absolute disc location, catalogue code and ISRC (Total M lines)
...	
(M-1) * 8	

If the Catalogue Code is to be recorded, it *shall* be described at the beginning of the Cue sheet.

If the ISRC is to be recorded, it *shall* be described immediately preceding each Track's information in the Cue Sheet.

For the Cue sheet, the Lead-out start time *shall* be the last entry.

17.35.2 Information of the absolute disc location

The logical unit writes a disc according to this information. This information defines the following parameters:

1. Generation of Sub-channel P and Q channel.
2. Format and block size of the data transferred by the WRITE (10) command

Table 746 - Sample Cue Sheet

Byte Number (hex)	Ctl/Adr (hex)	TNO (hex)	Index (hex)	Data Form (hex)	SCMS (hex)	Absolute Time		
						Min	Sec	Frame
00 (Lead-in)	01 ^a	00	00 ^b	01 ^a	00	00 ^b	00 ^b	00 ^b
08 (TNO:01) ^c	01	01	00	01	00	00	02	00
18 (TNO:02)	01	02	00	C0	00	07	29	71
20 (TNO:02)	01	02	01	C0	00	07	31	71
28 (TNO:03)	01	03	01	C0	00	14	18	03
30 (TNO:04) ^d	41	04	00	10	00	19	06	62
38 (TNO:04)	41	04	01	10	00	19	09	62
40 (TNO:05) ^d	41	05	00	11	00	27	37	10
48 (TNO:05)	41	05	01	10	00	27	40	10
50 (TNO:06)	01	06	00	01	80 ^e	38	53	23
58 (TNO:06)	01	06	01	00	80 ^e	38	55	23
60 (Lead-out)	01 ^a	AA	01 ^f	01 ^a	00	56	37	46

- a. For the Lead-in and Lead-out Area the DATA FORM *shall* be one. For Lead-in, data form and control mode of the first track is specified. For Lead-out, data form and control mode of last track is specified automatically. All data for both Lead-in and Lead-out *shall* be generated by the logical unit.
- b. Always zero for Lead-in.
- c. The first information track on a disc is preceded by a pause encoding of 2-3 seconds. (If the first track is a Data track, this track does not contain pause encoding, but always contains a “pause” of 2 seconds of pre-gap).
- d. Pre-gap
- e. Copy
- f. Always 01h for Lead-out

This information is composed of data units of 8 bytes (1 line). The information consists of three parts:

1. The Lead-in Area, which contains exactly one data unit.
2. The Program area, which contains one or more data units.
3. The Lead-out Area, which contains exactly one data unit.

The data units in Program Area and Lead-out Area are in Absolute Time order from the start time of index = 0 of the first track of the session.

Each data unit of Program area and Lead-out Area indicates that the value of each field (CONTROL, TNO, X, DATA FORM or ZERO) changes at the time shown in ABSOLUTE TIME field.

Table 747 - CUE Sheet Data

Ctl/Adr (hex)	TNO (hex)	Index (hex)	Data Form (hex)	SCMS (hex)	Absolute Time		
					Min	Sec	Frame
01	02	01	C0	00	07	31	71
01	03	01	C0	00	14	18	03

The above data unit indicates that the value of TNO changes from 02 to 03 when ABSOLUTE TIME is 14/18/03 MSF.

17.35.2.1 Control/Address Field

The CTL/ADR byte contains the Control field in the upper 4 bits and the ADR in the lower 4 bits. See Table 748.

Table 748 - CTL/ADR Byte

7	6	5	4	3	2	1	0
CTL Field				ADR Field			

17.35.2.2 CTL Field (upper 4 bits)

The CTL (Control) field contains 4 bits that define the kind of information in a track. See Table 749.

Table 749 - Control Field

Bit 7	Bit 6	Bit 5	Bit 4	Definition
0	0	x	0	2 audio channels without pre-emphasis
1	0	x	0	4 audio channels without pre-emphasis
0	0	x	1	2 audio channels with pre-emphasis of 50/15 μ s.
1	0	x	1	4 audio channels with pre-emphasis of 50/15 μ s.
0	1	x	0	Data track
x	x	0	x	digital copy prohibited
x	x	1	x	digital copy permitted

The bits of the Control field (except for the copy bit) *shall* only be changed during an actual pause (Index = 00) of at least 2 seconds and during Lead-in Area.

17.35.2.3 ADR Field (lower 4 bits)

Table 750 defines the codes found in the ADR Field.

Table 750 - ADR Field

Bit 3	Bit 2	Bit 1	Bit 0	Definition
0	0	0	1	start time at TNO/IDX
0	0	1	0	CATALOG CODE
0	0	1	1	ISRC CODE

All other codes are reserved for future use.

Control *shall* be the same for each entry associated with a particular track except for first part of pre-gap.

17.35.2.4 TNO

The TNO field indicates track number expressed in HEX. Each track has a minimum length of 4 seconds, not including the pause length preceding the track.

17.35.2.5 INDEX Field

The index number expressed in HEX. The logical unit supports only 00h - 63h.

17.35.2.6 DATA FORM

The following table defines the data form byte.

Table 751 - Data Form Byte

7	6	5	4	3	2	1	0
Data Form of Sub-channel		Data Form of Main Data					

17.35.2.7 SCMS (Serial Copy Management System)

Bit 7 of data form of 1 indicates that Copy bit of CONTROL field alternates for Serial Copy Management System (see Table 752). The other 7 bits (Reserved) are zero. This bit is effective if Copy bit of the Control Code is zero.

Table 752 - SCMS Byte

7	6	5	4	3	2	1	0
Alternate Copy bit	Reserved						

17.35.2.8 DATA FORM OF MAIN DATA

The DATA FORM OF MAIN DATA field specifies the format of the main data to be sent by a WRITE command to write on the disc. Currently available data formats are 1.) CD-DA, 2.) CD-ROM mode 1, 3.) CD-ROM XA and CD-I. For Lead-in and Lead-out Area data are generated automatically.

17.35.2.9 CD-DA Data Form

The Table 753 defines a CD-DA Data Form for one frame.

Table 753 - CD-DA Data Form

Data Form	Data of One Frame	Data Size
00h	2 352	2 352
01h	2 352	0

The CD-DA data format, is as follows:

Table 754 - CD-DA Data format (1 Sample)

Bit Byte	7	6	5	4	3	2	1	0
n*4+0 (L ch)	L7	L6	L5	L4	L3	L2	L1	L0
n*4+1 (L ch)	L15	L14	L13	L12	L11	L10	L9	L8
n*4+2 (R ch)	R7	R6	R5	R4	R3	R2	R1	R0
n*4+3 (R ch)	R15	R14	R13	R12	R11	R10	R9	R8

n = 0,1, .. ,587

1 Second = 75 Frames

1 Frame = 588 Samples

1 Sample = 4 bytes (16 bits L, R ch)

17.35.2.10 CD-ROM mode 1 Form

The Table 755 defines the form for CD-ROM mode 1.

Table 755 - CD-ROM Mode 1

Data Form	Sync/ Header	Data of One Frame	EDC/ECC Area	Data Size
10h	16 *2	2 048 *1	288 *2	2 048
11h	16 *3	2 048 *1	288 *3	2 352
12h	16 *2	2 048 *3	288 *2	2 048
13h	16 *3	2 048 *3	288 *3	2 352
14h	16 *2	2 048 *2	288 *2	0

17.35.2.11 CD-ROM XA, CD-I Form

The Table 756 defines the form for CD-ROM XA, CD-I.

Table 756 - CD-ROM XA, CD-I

Data Form		Sync/ Header	Sub Header	Data of One Frame	EDC/ECC Area	Data Size
20h	Form 1	16 *2	8 *1	2 048 *1	280 *3	2 336
	Form 2	16 *2	8 *1	2 324 *1	4 *3	2 336
21h	Form 1	16 *3	8 *1	2 048 *1	280 *3	2 352
	Form 2	16 *3	8 *1	2 324 *1	4 *3	2 352
22h	Form 1	16 *2	8 *1	2 048 *3	280 *3	2 336
	Form 2	16 *2	8 *1	2 324 *3	4 *3	2 336
23h	Form 1	16 *3	8 *1	2 048 *3	280 *3	2 352
	Form 2	16 *3	8 *1	2 324 *3	4 *3	2 352
24h	Form 1	NA	NA	NA	NA	NA
	Form 2	16 *2	8 *2	2 324 *2	4 *2	0

Reserved Area: The Reserved Area contains 4 bytes that are reserved for quality control during the disc production process. In case of Generate Zero, the logical unit generates zero data of 4 bytes for this area.

17.35.2.12 CD-ROM mode 2

The Table 757 defines the form for CD-ROM mode 2.

Table 757 - CD-ROM Mode 2

Data Form	Sync/ Header	Data of One Frame	Data Size
30h	16 *2	2 336 *1	2 336
31h	16 *3	2 336 *1	2 352
32h	16 *2	2 336 *3	2 336
33h	16 *3	2 336 *3	2 352
34h	16 *2	2 336 *2	0

Notes for all forms:

1. Read Buffer: The data is sent by the initiator.
2. Generate Data: The logical unit generates the data in this area. The host *shall not* send the data for this area. All sectors in the program area *shall* have an associated write, even if all data for the sector is to be generated by the logical unit. Zero bytes *shall* be transferred for such sectors.
3. Ignore Buffer: The logical unit receives the data for this area from the initiator with WRITE (10) command. However, the logical unit ignores the data and generates data for this area.

17.35.3 Data Form of Sub-Channel

The DATA FORM OF SUB-CHANNEL (Table 758) field specifies the format of the sub-channel data stored in the inner buffer by WRITE (10) command to write on the disc.

Table 758 - Data Form of Sub-channel

Data Form		Data of One Frame				Data Size
Bit 7	Bit 6					
0	0	96 ^a				0
0	1	96 ^b				96
1	0	Reserved				
1	1	24 Pack ^c	24 Pack ^c	24 Pack ^c	24 Pack ^c	96

- a. Generate zero data
- b. RAW Data
- c. PACK DATA, Initiator sends packed data. The logical unit writes R-W. The logical unit calculates and overwrites ECC, and performs Interleaving for each PACK.

The Sub-channel data is placed at the end of each Frame of main data. Figure 223 shows the relationship of Main Data and sub-channel data.

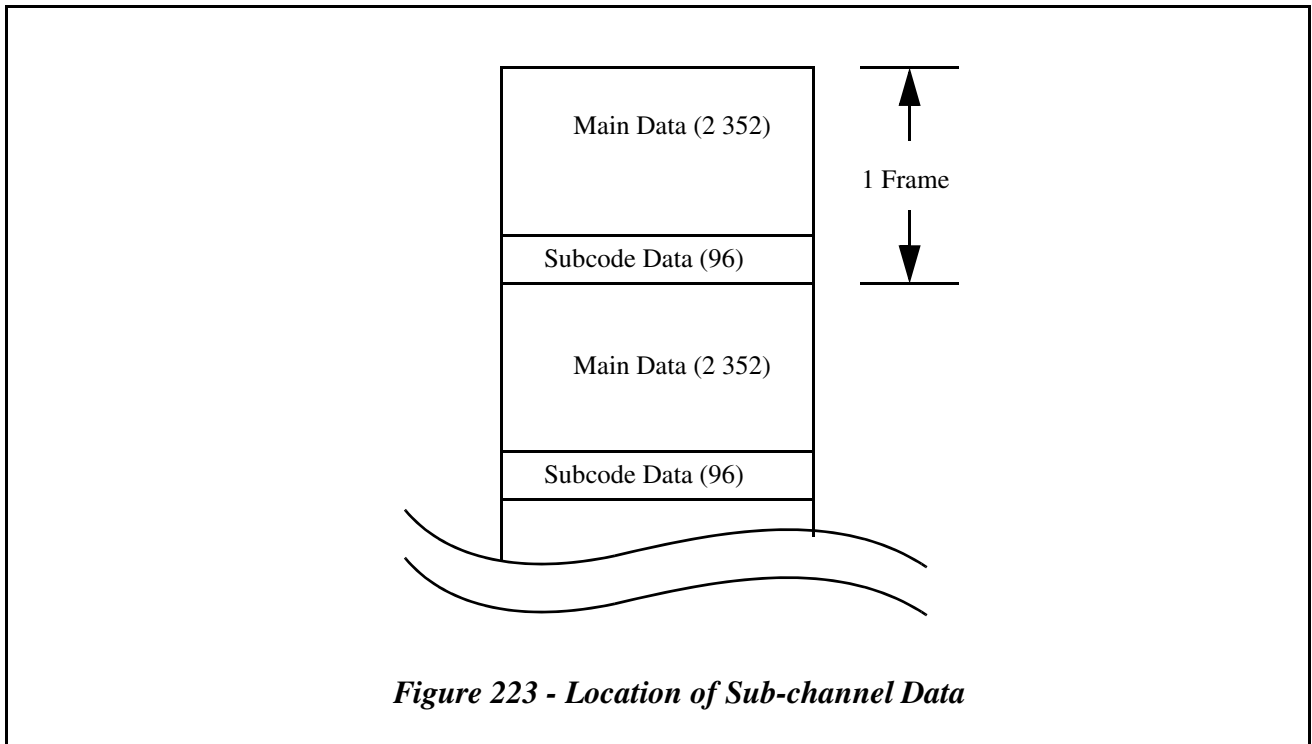


Figure 223 - Location of Sub-channel Data

The P and Q sub-channel information contained within the Subcode Data *shall* be ignored. The P and Q sub-channel information is generated by the logical unit and based on the content of the cue sheet.

17.35.4 Absolute Time

The time shown at Min, Sec, and Frame gives the changing point of the CONTROL, TNO, X, DATA FORM or SCMS field. These values are given in absolute time scale.

17.35.5 Session Format

The Session Format is used for the identification of the type of disc. See Table 542 - *Session Format codes* on page 696.

17.35.6 Pre-gap

If a Data track is preceded by a different mode of track (such as an audio track) or if the mode number of CD-ROM changes, this Data track starts with an extended pre-gap. A pre-gap is placed at the head of a Data track, also is belonging to the Data track. A pre-gap does not contain actual user data. The pre-gap is encoded as "pause."

An extended pre-gap is divided into two parts. The first part of the extended pre-gap has a minimum 1 second of data, and it is encoded according to the data structure of previous track. The second part has a minimum 2 seconds data, and this data track is encoded according to the same data structure as the other parts.

17.35.7 Post-gap

If a Data track is followed by another kind of track (such as an audio track), this Data track ends with a post-gap. A post-gap is placed at the end of a Data track, and is part of the Data Track. A post-gap does not contain actual user data. The minimum length of post-gap is 2 seconds. The logical unit does not perform any action for a Post-gap.

17.35.8 Catalog Number

The Catalog Number, indicates the catalog number of a disc. The number uses UPC/EAN-code (BAR coding). If no catalog number is used, it *shall* be omitted. The format is as follows;

Table 759 - Catalog Number (N1..N13)

CTL/ ADR	Catalog Number						
Byte 0	Byte 1	Byte 2	Byte 3	Byte 4	Byte 5	Byte 6	Byte 7
02h	N1	N2	N3	N4	N5	N6	N7
02h	N8	N9	N10	N11	N12	N13	00h

N1-N13: Catalog Number
 CTL: 4 bits are zero.
 ADR: 0010b
 Catalog Number: ASCII 13 BYTES

17.35.9 ISRC

Table 760, ISRC (International Standard Recording Code), is a code that is given to CD-DA tracks. If no ISRC is used, it *shall* be omitted. If a track has no ISRC, it is not written in the Cue Sheet.

Table 760 - ISRC (I1..I12)

CTL/ ADR	ISRC (International Standard Recording Code)						
byte 0	byte 1	byte 2	byte 3	byte 4	byte 5	byte 6	byte 7
x3h	TNO	I1	I2	I3	I4	I5	I6
x3h	TNO	I7	I8	I9	I10	I11	I12

CTL: 4 bits of Control code are the same as that of disc location of the specified track
 ADR: 0011b
 TNO: Track number in HEX.
 12 letters ISRC (On the Cue Sheet, I1-I12 *shall* be described by valid ASCII characters. See Table 663 - *ISRC Format of Data Returned to host* on page 784 for valid codes.
 I1-I2: Country Code
 I3-I5: Owner Code
 I6-I7: Year of recording
 I8-I12: Serial Number

Table 761 - SEND CUE SHEET command errors

Error Description
A-1.1, "Deferred Error Reporting" on page 919
Table 835 - Basic Error Codes on page 932
Table 836 - Media Access Error Codes on page 935
Table 837 - Write Error Codes on page 938

17.36 SEND DISC STRUCTURE command

The SEND DISC STRUCTURE command provides a means for the host to transfer disc structure data to the logical unit.

Table 762 - SEND DISC STRUCTURE Command Descriptor Block

Bit Byte	7	6	5	4	3	2	1	0
0	Operation Code (BFh)							
1	LUN			Reserved	Media Type			
2	Reserved							
3	Reserved							
4	Reserved							
5	Reserved							
6	Reserved							
7	Format Code							
8	(MSB) Parameter List Length (LSB)							
9								
10	AGID		Reserved					
11	Vendor-Specific		Reserved			NACA	Flag	Link

The **Media Type** field indicates the type of command definition to expand this command for other media type than DVD/HD DVD. This value *shall* be set to 0000b for DVD/HD DVD media.

Table 763 - Media Type field definition

Media Type	Media Type
0000b	DVD-ROM, DVD-RAM, DVD-R, DVD-RW, DVD-Download, DVD+RW, DVD+R, HD DVD-ROM, HD DVD-R, HD DVD-RW and HD DVD-RAM media
0001b	BD-RE, BD-R, BD-ROM media (See MMC)
Others	Reserved

The **Format Code** field indicates the type of information that is requested to be sent to the logical unit. When a SEND DISC STRUCTURE command is issued for media that is not supported by the **Media Type** field, with **Format Code** values of 00h - BFh, this command *shall* be terminated with CHECK CONDITION status, 5/30/05 CANNOT WRITE MEDIUM - INCOMPATIBLE FORMAT. When the logical unit and medium combination does not support specified **Format Code** value, this command *shall* be terminated with CHECK CONDITION status, 5/24/00 INVALID FIELD IN CDB.

The **AGID** field is described in the REPORT KEY command. This field is used only when the **Format Code** field contains 84h. For all other values it is reserved.

Table 764 - Format Code definitions for SEND DISC STRUCTURE command (Media Type = 0)

Format Code	Data to be sent to logical unit	Applicable media type	Description
00h-03h	Reserved	Reserved	
04h	User Specific Data	DVD-R/-RW, HD DVD-R	Send User Specific Data to the RMD cache
05h	Copyright Management	DVD-R, DVD-RW	Send data to CPR_MAI in Data Area cache. (CPM, CGMS, ADP_TY)
06h-0Eh	Reserved	Reserved	
0Fh	Timestamp	DVD-R, DVD-RW, HD DVD-R, HD DVD-RW	Send Timestamp data to the RMD cache
10h-16h	Reserved	Reserved	
17h	Scramble Content Allocation information	DVD-Download	Send Scramble Content Allocation information
18h-1Fh	Reserved	Reserved	
20h	Layer Boundary Information	HD DVD-R DL, HD DVD-RW DL	Send capacity of L0
21h	Shifted Middle Area Start Address	DVD-R DL, DVD-RW DL	Send start logical block address of Shifted Middle Area on L0
22h	Jump Interval size	DVD-R DL, DVD-RW DL	Send Jump Interval size of Regular Interval Layer Jump recording
23h	Manual Layer Jump Address	DVD-R DL, DVD-RW DL	Send logical block address for Layer Jump on L0
24h	Remapping Address	DVD-R DL	Send logical block address for remapping Anchor Point
25h-2Fh	Reserved	Reserved	
30h	Disc Control Block	See MMC	Send a Disc Control Block. See MMC.
31h-83h	Reserved	Reserved	
84h	Write Data Key	All writable DVD, All writable HD DVD	Send the Write Data Key specified by AACs
85h	LBA Extents	All writable DVD, All writable HD DVD	Send the LBA Extents to which data is recorded with the flag for Bus Encryption specified by AACs
86h-BFh	Reserved	Reserved	
C0h	Write Protection	DVD-RW, DVD-RAM, HD DVD-RW	Send PWP status
C1h-FFh	Reserved	Reserved	

A DVD-R/HD DVD-R logical unit *shall* implement cache memory for the DISC STRUCTURE data defined in Section 17.36.1 through Section 17.36.12, "Write Protection (Format Code = C0h)" on page 871.

The cached RMD can be read by using the READ DISC STRUCTURE command.

The Parameter List Length field specifies the length in bytes of the DISC STRUCTURE data that *shall* be transferred from the host to the logical unit after the Command Packet is transferred. A Parameter List Length field of zero indicates that no data *shall* be transferred. This condition *shall not* be considered an error.

17.36.1 User Specific Data (Format Code = 04h)

Table 765 - SEND DISC STRUCTURE Data Format (With Format Code = 04h)

Bit Byte	7	6	5	4	3	2	1	0
0	(MSB) Structure Data Length							(LSB)
1								
2	Reserved							
3	Reserved							
DVD-R/HD DVD-R User Specific Data								
0-N	(MSB) User Specific Data							(LSB)

The Structure Data Length field specifies the number of bytes that follow the Structure Data Length field.

The User Specific Data field contains user specific data. This data *shall* be used to specify the RMD Field 2, and when writing of Lead-in or Border-in occurs, the contents of this field *shall* also be written in Disc manufacturing information field of Lead-in or Border-in.

17.36.2 Copyright Management Information (Format Code = 05h)

Note: This Format Code does not work for DVD-Download disc. See Table 764.

Table 766 - SEND DISC STRUCTURE Data Format (With Format Code = 05h)

Bit Byte	7	6	5	4	3	2	1	0
0	(MSB) Structure Data Length							(LSB)
1								
2	Reserved							
3	Reserved							
Copyright Management Information in Data Area								
0	CPR_MAI							
1	Reserved							
2								
3								

The Structure Data Length field specifies the number of bytes that follow the Structure Data Length field.

The sector written in the Data Area *shall* reflect the values in Table 766 for the copyright management information field of the sector.

The definition of the CPR_MAI field depends on the mounted media. The CPR_MAI field definition is shown in Table 767.

Table 767 - CPR_MAI field definition

Bit Media	7	6	5	4	3	2	1	0
DVD-RAM Ver. 2.2, DVD-Download	Reserved							
DVD-R SL Ver. 2.1, DVD-RW SL Ver. 1.2 ^a , DVD-R DL, DVD-RW DL	Reserved				ADP_TY		Reserved	

a. On DVD-RW SL Ver. 1.0, the definition of this field is different. See previous version of this specification.

The ADP_TY field is defined only for DVD-RW SL Ver. 1.2 and DVD-R SL Ver. 2.1 media. If the sector contains materials defined in DVD Specifications for Read-Only Disc Part 3 VIDEO SPECIFICATIONS, the ADP_TY field *shall* be set to 01b. If the sector contains no such data, ADP_TY field *shall* be set to 00b. All other values of ADP_TY are reserved.

Note: A value of each field may not be stable at the first and last 16 sectors of each recording extent due to the nature of recording method for DVD-R/-RW media.

17.36.3 Timestamp (Format Code = 0Fh)

Table 768 - SEND DISC STRUCTURE Data Format (With Format Code = 0Fh)

Bit Byte	7	6	5	4	3	2	1	0
0	(MSB) Structure Data Length (LSB)							
1								
2	Reserved							
3	Reserved							
Timestamp Data								
0-1	Reserved							
2-3	Reserved							
4-7	(MSB) Year				(LSB)			
8-9	(MSB) Month				(LSB)			
10-11	(MSB) Day				(LSB)			
12-13	(MSB) Hour				(LSB)			
14-15	(MSB) Minute				(LSB)			
16-17	(MSB) Second				(LSB)			

The Structure Data Length field specifies the number of bytes that follow the Structure Data Length field.

The Timestamp data *shall* be used to specify the Structure Data Length field of the RMD Field 0.

The Timestamp data may also be used in the OPC related field in the RMD Field 1 and may help the judgement to do OPC.

The time value of the Timestamp data should be current UTC (Universal Coordinated Time) 24 hour clock.

The Year field *shall* specify the year which coded as ASCII in the range “0001” to “9999”.

The Month field *shall* specify the month of the year which coded as ASCII in the range “01” to “12”.

The Day field *shall* specify the day of the month which coded as ASCII in the range “01” to “31”.

The Hour field *shall* specify the hour of the day which coded as ASCII in the range “00” to “23”.

The Minute field *shall* specify the minute of the hour which coded as ASCII in the range “00” to “59”.

The Second field *shall* specify the second of the minute which coded as ASCII in the range “00” to “59”.

17.36.4 Scramble Content Allocation information (Format Code = 17h)

This format works for DVD-Download disc. When the logical unit loads other disc, this command *shall* be terminated with CHECK CONDITION status, 5/24/00 INVALID FIELD IN CDB.

Table 769 - SEND DISC STRUCTURE Data Format (With Format Code = 17h)

Bit Byte	7	6	5	4	3	2	1	0
0	(MSB) Structure Data Length (LSB)							
1								
2	Reserved							
3	Reserved							
Scramble Content Allocation information								
4-19	Title Set Zone information							
20-35	Scramble Extent information entry #1							
:	:							
16n+4 - 16n+19	Scramble Extent information entry #n							
- 16n+19+x ^a	Scrambled padded bytes x (make the Scrambled bytes to be multiple of 5)							
- 16n+19+x+y ^a	Padded bytes y (make the transferred bytes to be multiple of 4)							

- a. When x or y equal 0 these padded bytes areas do not exist. Therefore the byte position descriptions show the end position of these areas only.

The Structure Data Length field specifies the number of bytes that follow the Structure Data Length field.

The Scramble Content Allocation information that the logical unit currently has *shall* be discarded by another issuance of SEND DISC STRUCTURE command with Format Code = 17h, Hard Reset or medium eject.

The Scramble Content Allocation information is sent as a sequence of Title Set Zone information, Scramble Extent information entries, Scrambled padded bytes x and Padded bytes y as shown in Table 769. Title Set Zone information, Scramble Extent information entries and Scrambled padded bytes x are obfuscated by a Bus key. Each of these structure is defined as shown in Table 770 and Table 771. The length of Scramble Content Allocation information becomes multiple of 5 and the padded bytes length x is computed as follows:

$$x = (5 - (16n+16) \bmod 5) \bmod 5 \quad \text{if } x \text{ equals } 0, \text{ Scrambled padded bytes does not exist.}$$

The total data transfer length *shall* be multiple of 4. The padded bytes length y is computed as follows:

$$y = (4 - (16n+20+x) \bmod 4) \bmod 4 \quad \text{if } y \text{ equals } 0, \text{ Padded bytes does not exist.}$$

Note: (A mod B) is an operation to calculate remainder when A is divided by B.

The Title Set Zone information specifies the Title Set Zone.

Table 770 - Title Set Zone information

Bit Byte	7	6	5	4	3	2	1	0	
0-7	Reserved								
8-11	(MSB)				Start LBA				(LSB)
12-15	(MSB)				LBA Count				(LSB)

The logical unit *shall* accept minimum 15 entries of Scramble Extent information entries.

Table 771 - Scramble Extent information entry

Bit Byte	7	6	5	4	3	2	1	0	
0-2	Reserved								
3-7	(MSB)				CSS scrambled Title Key				(LSB)
8-11	(MSB)				Start LBA				(LSB)
12-15	(MSB)				LBA Count				(LSB)

The CSS scrambled Title Key field *shall* specify the scrambled Title Key to be written in sector header. The value of the second Scramble Extent information or later *shall not* be zero.

The Start LBA field and LBA Count field *shall* specify a LBA Extent that the scrambled Title Key is written in sector header. The LBA Extent *shall* be arranged to ECC block boundary. One ECC block *shall* be located between two LBA Extents. See 4.22.4, on page 294. The LBA Extent *shall* be sorted by the Start LBA field in ascending order.

Logical unit *shall* check the consistency of parameter (Title Set Zone coverage, overlap of Scramble Extents and last address of the Title Set Zone and end address of the recording area). If the field value of Title Set Zone information and Scramble Extent information entry is not valid, the command *shall* be terminated with CHECK CONDITION status, 5/26/00 INVALID FIELD IN PARAMETER LIST.

When the number of Scramble Extent information entries exceeds the maximum number of entries that logical unit can store, this command with Format Code = 17h *shall* be terminated with CHECK CONDITION status, 5/55/00 SYSTEM RESOURCE FAILURE.

When the DVD logical unit is not in the Bus Key Established state for CSS/CPPM, this command with Format Code = 17h *shall* be terminated with CHECK CONDITION status, 5/6F/02 COPY PROTECTION KEY EXCHANGE FAILURE - KEY NOT ESTABLISHED.

17.36.5 Layer Boundary Information (Format Code = 20h)

This format does not work for DVD-R DL and DVD-RW DL discs. When DVD-R DL or DVD-RW DL disc is mounted, this command *shall* be terminated with CHECK CONDITION status, 5/24/00 INVALID FIELD IN CDB.

Table 772 - SEND DISC STRUCTURE Data Format (With Format Code = 20h)

Bit Byte	7	6	5	4	3	2	1	0
0	(MSB) Structure Data Length (LSB)							
1								
2	Reserved							
3	Reserved							
Layer Boundary Information								
0-3	Reserved							
4-7	(MSB)	L0 Data Area Capacity						(LSB)

The Structure Data Length field specifies the number of bytes that follow the Structure Data Length field.

The L0 Data Area Capacity field *shall* specify the Data Area capacity on L0 in logical block. The value *shall* be greater than zero. For HD DVD-R DL and HD DVD-RW DL, the value *shall* be equal to or larger than 1FE00h. The last LBA of Data Area on L0 is L0 Data Area Capacity - 1.

If the value of L0 Data Area Capacity field is not an integral multiple of 16 for DVD or 32 for HD DVD, the value *shall* be rounded up to the next integral multiple of 16 or 32. If the rounded L0 Data Area Capacity value is greater than available capacity on L0, the command *shall* be terminated with CHECK CONDITION status, 5/26/00 INVALID FIELD IN PARAMETER LIST. If Data Area capacity has already been established by a previous SEND DISC STRUCTURE command with Format Code value of 20h, the command *shall* be terminated with CHECK CONDITION status, 5/24/00 INVALID FIELD IN CDB.

Note: MMC5 and Mt. Fuji Ver. 6 specified 5/26/00 INVALID FIELD IN PARAMETER LIST as the error code if Data Area capacity has already been established.

In the case of HD DVD-RW DL disc, L0 Data Area Capacity value is changeable unless the addressable area has been expanded to L1 and when the disc state is Intermediate state. LBA space is changed with L0 Data Area capacity change. Middle Area *shall not* be overlapped the addressable area. The erasing resets L0 Data Area capacity. The formatting resets this capacity.

17.36.6 Shifted Middle Area Start Address (Format Code = 21h)

This function provides a means for the host to specify the location of the Shifted Middle Area.

Table 773 - SEND DISC STRUCTURE Data Format (With Format Code = 21h)

Bit Byte	7	6	5	4	3	2	1	0
0	(MSB) Structure Data Length (LSB)							
1								
2	Reserved							
3	Reserved							
Shifted Middle Area Information								
0-3	Reserved							
4-7	(MSB) Shifted Middle Area Start Address (LSB)							

The Structure Data Length field specifies the number of bytes that follow the Structure Data Length field.

The Shifted Middle Area Start Address field *shall* specify the start LBA of the Shifted Middle Area on L0. If this value has already been set, the command *shall* be terminated with CHECK CONDITION status, 5/24/00 INVALID FIELD IN CDB.

On DVD-R DL discs, this value *shall* be:

- multiple of the Blocking factor, and
- located in the unrecorded area of Invisible/Incomplete RZone, and
- larger than or equal to the LBA on L0 that is corresponding to the end LBA on L1, and
- less than or equal to the end LBA on L0 - AC10h only if the logical unit allocates the flexible ODTA (Outer Disc Testing Area). When the value is set larger than the end LBA on L0 - AC10h, no flexible ODTA is allocated.

Once this value has been set, the value is not changeable. The outer radius area beyond the Shifted Middle Area becomes unusable for user data. Therefore the number of free blocks is decreased. If the specified value is not correct, this command *shall* be terminated with CHECK CONDITION status, 5/26/00 INVALID FIELD IN PARAMETER LIST. If this parameter has already been set upon receiving this command, the command *shall* be terminated with CHECK CONDITION status, 5/24/00 INVALID FIELD IN CDB. See 4.18.5.6.5, "Disc-at-Once like way" on page 201.

On DVD-RW DL discs, this field *shall*:

- be integer multiple of the Blocking factor,
- specify the sector in the logically unrecorded area on Layer 0,
- specify the LBA greater than or equal to the LBA on L0 that is corresponding to the end LBA on L1,
- specify the LBA less than the end LBA on L0, and
- specify the LBA greater than the Layer Jump Logical Block Address if it has already been set.

If the specified value does not meet the above requirements, this command *shall* be terminated with CHECK CONDITION status, 5/26/00 INVALID FIELD IN PARAMETER LIST. See 4.18.5.6.5, "Disc-at-Once like way" on page 201.

17.36.7 Jump Interval size (Format Code = 22h)

This function provides a mean for the host to specify the size of the Jump interval for Regular Interval Layer Jump recording.

Table 774 - SEND DISC STRUCTURE Data Format (With Format Code = 22h)

Bit Byte	7	6	5	4	3	2	1	0
0	(MSB)							
1	Structure Data Length							(LSB)
2	Reserved							
3	Reserved							
Jump Interval size								
0-3	Reserved							
4-7	(MSB)	Jump Interval size						(LSB)

The Structure Data Length field specifies the number of bytes that follow the Structure Data Length field.

The Jump Interval size field *shall* specify the Jump Interval size of the Regular Interval Layer Jump recording of Invisible RZone in number of blocks.

On DVD-R DL disc, the specified Jump Interval size is applied to Invisible RZone. This field *shall* be greater than or equal to 8 192 (16 MB) and *shall* be less than or equal to 65 520 (127,9 MB). The number of sectors *shall* be multiple of Blocking Factor specified by the Fixed Packet Size/ Blocking Factor field of Table 684 - *Track Information Block* on page 803. If the value is not multiple of Blocking Factor, the value is not correct value and this command *shall* be terminated with CHECK CONDITION status, 5/26/00 INVALID FIELD IN PARAMETER LIST. If this parameter has already been set to the Invisible RZone or a Manual Layer Jump Address has already been set to the Invisible RZone upon receiving this command, the command *shall* be terminated with CHECK CONDITION status, 5/24/00 INVALID FIELD IN CDB. If this command is issued to a disc that contains an Incomplete RZone, the command *shall* be terminated with CHECK CONDITION status, 5/24/00 INVALID FIELD IN CDB. See 4.18.5.3.3, "Regular Interval Layer Jump" on page 187.

On DVD-RW DL disc, the Jump Interval size can be set only when the value of the LJRS field in Track Information Block returned by READ TRACK INFORMATION command is 01b or when the LJRS field value is 00b, the NWA_V field is 1b and Next Writable Address field is 00h. If the condition does not meet these requirements, the command *shall* be terminated with CHECK CONDITION status, 5/24/00 INVALID FIELD IN CDB. This field *shall* be integer multiple of the Blocking factor. This field *shall* be greater than or equal to 8 192 (16 MB) and *shall* be less than or equal to 65 520 (127,9 MB). If the specified value does not meet these requirements, this command *shall* be terminated with CHECK CONDITION status, 5/26/00 INVALID FIELD IN PARAMETER LIST.

17.36.8 Manual Layer Jump Address (Format Code = 23h)

This function provides a mean for the host to specify the Layer jump address manually.

Table 775 - SEND DISC STRUCTURE Data Format (With Format Code = 23h)

Bit Byte	7	6	5	4	3	2	1	0
0	(MSB) Structure Data Length (LSB)							
1								
2	Reserved							
3	Reserved							
Manual Layer Jump Address								
0-3	Reserved							
4-7	(MSB) Layer Jump Logical Block Address (LSB)							

The Structure Data Length field specifies the number of bytes that follow the Structure Data Length field.

The Layer Jump Logical Block Address field *shall* specify the logical block address that cause Layer jump of NWA from L0 to L1 non-contiguously after the sector of the logical block address is written. The logical block address *shall* be the last sector number of an ECC block.

If the corresponding address on Layer 1 of the Layer Jump Address on L0 is not available for recording (i.e., Out of range of the RZone), this command *shall* be terminated with CHECK CONDITION status, 5/26/00 INVALID FIELD IN PARAMETER LIST. If a Manual Layer Jump Address or a Jump Interval size has already been set upon receiving this command, the command *shall* be terminated with CHECK CONDITION status, 5/24/00 INVALID FIELD IN CDB. See 4.18.5.3.2, "Manual Layer Jump" on page 184.

On DVD-RW DL disc, the Layer Jump Logical Block Address can be set only when the value of the LJRS field in Track Information Block returned by READ TRACK INFORMATION command is 01b or 10b and Layer Jump Logical Block Address has not been set, or when the value of the LJRS field is 00b and the Next Writable Address is on L0. The remaining logically unrecorded blocks on L0 *shall* be more than the Blocking size. If the condition does not meet these requirements, the command *shall* be terminated with CHECK CONDITION status, 5/24/00 INVALID FIELD IN CDB. The Layer Jump Logical Block Address field *shall*:

- specify the block in the logically unrecorded area on L0,
- specify the last block in an ECC block,
- specify the block whose corresponding L1 block is not in the Lead-out area,
- specify the LBA less than or equal to the end LBA on L0 - Blocking size, and
- specify the LBA less than the Shifted Middle Area Start Address - Blocking size if it has already been set.

If the specified value does not meet the above requirements, this command *shall* be terminated with CHECK CONDITION status, 5/26/00 INVALID FIELD IN PARAMETER LIST.

17.36.9 Remapping Address (Format Code = 24h)

Table 776 - SEND DISC STRUCTURE Data Format (With Format Code = 24h)

Bit Byte	7	6	5	4	3	2	1	0
0	(MSB) Structure Data Length							(LSB)
1								
2	Reserved							
3	Reserved							
Remapping Address								
0	(MSB) Anchor Point Number							(LSB)
1								
2-3	Reserved							
4-7	(MSB) Remapping Address							(LSB)

The Structure Data Length field specifies the number of bytes that follow the Structure Data Length field.

The Anchor Point Number field *shall* specify the number of Anchor Point that is reassigned. In the case of DVD-R Dual Layer disc, the number *shall* be one of 1, 2, 3, and 4.

The Remapping Address field *shall* specify the logical block address that is used to reassign the Anchor Point block specified by Anchor Point Number field. The logical block address *shall* be multiple of Blocking Factor specified by the Fixed Packet Size/ Blocking Factor field of Table 684 - *Track Information Block* on page 803. If the value is not multiple of Blocking Factor or is not correct value, this command *shall* be terminated with CHECK CONDITION status, 5/26/00 INVALID FIELD IN PARAMETER LIST. Logical unit *shall* check the ECC block that are specified by Anchor Point Number field and Remapping Address field has been written. If the ECC block is not written, this command *shall* be terminated with CHECK CONDITION status, 5/26/00 INVALID FIELD IN PARAMETER LIST. See 4.18.5.6.1, "AP remap operation" on page 200.

Note: Logical unit needs not check the validity of Remapping Address. Even if the address specify Border Zone or Clearance, logical unit may not report any error.

17.36.10 Write Data Key of AACS (Format Code = 84h)

Table 777 - SEND DISC STRUCTURE Data Format (With Format Code = 84h)

Bit Byte	7	6	5	4	3	2	1	0
0	(MSB) Structure Data Length							(LSB)
1								
2	Reserved							
3	Reserved							
Write Data Key Structure								
0	(MSB) Write Data Key Data							(LSB)
:								
N								

The Structure Data Length field specifies the number of bytes that follow the Structure Data Length field.

The Write Data Key Data field *shall* specify the Write Data Key of AACS, which is encrypted by a Bus Key.

When the host is not authorized to send the Write Data Key but does send it, this command with Format Code = 84h *shall* be terminated with CHECK CONDITION status, 5/6F/08 INSUFFICIENT PERMISSION.

When the logical unit is not in the Bus Key established state of the AACS Authentication, this command with Format Code = 84h *shall* be terminated with CHECK CONDITION status, 5/6F/02 COPY PROTECTION KEY EXCHANGE FAILURE - KEY NOT ESTABLISHED.

17.36.11 LBA Extents for Bus Encryption flag of AACS (Format Code = 85h)

Table 778 - SEND DISC STRUCTURE Data Format (With Format Code = 85h)

Bit Byte	7	6	5	4	3	2	1	0
0	(MSB) Structure Data Length (LSB)							
1								
2	Reserved							
3								
1st LBA Extent Structure								
0	Reserved							
:								
7								
8	(MSB) Start LBA (LSB)							
:								
11								
12	(MSB) LBA Count (LSB)							
:								
15								
Nth LBA Extent Structure								
16(N-1) ^a	Reserved							
:								
16(N-1)+7	(MSB) Start LBA (LSB)							
16(N-1)+8								
:								
16(N-1)+11	(MSB) LBA Count (LSB)							
16(N-1)+12								
16(N-1)+15								

a. N is integer value and greater than or equal to 1 to apply this formula. If there is no LBA Extent Structure in this DISC STRUCTURE data, N is considered as 0.

The Structure Data Length field specifies the number of bytes that follow the Structure Data Length field.

LBA Extent Structure data *shall* specify LBA Extents, to which the Bus Encryption flag is associated when data is recorded. Each LBA Extent is denoted by the Start LBA and the LBA Count, where the first LBA is Start LBA and the last LBA is Start LBA + LBA Count - 1. The LBA Extent Structure data *shall* be sorted by the Start LBA field value in ascending order.

A null LBA Extent Structure (N=0) *shall* be used to clear all current LBA Extents.

Each LBA Extent *shall not* cause any overlapping regions. Any LBA contained in any LBA Extent *shall not* be located beyond the maximum capacity of the current media. An LBA Count *shall not* be zero. When any of these conditions are

not satisfied, this command with Format Code = 85h *shall* be terminated with CHECK CONDITION status, 5/26/00 INVALID FIELD IN PARAMETER LIST.

When the number of LBA Extents specified in the LBA Extent Structure data exceeds the maximum number of LBA Extents that logical unit can store, this command with Format Code = 85h *shall* be terminated with CHECK CONDITION status, 5/55/00 SYSTEM RESOURCE FAILURE.

The LBA Extents that the logical unit currently has *shall* be discarded by another issuance of SEND DISC STRUCTURE command with Format Code = 85h, Hard Reset or medium eject.

This command with Format Code = 85h does not require the AACS Authentication.

17.36.12 Write Protection (Format Code = C0h)

Table 779 - SEND DISC STRUCTURE Data Format (With Format Code = C0h)

Bit Byte	7	6	5	4	3	2	1	0	
0	(MSB) Structure Data Length							(LSB)	
1									
2	Reserved								
3	Reserved								
Write Protection Data									
0	Reserved					PWP		Reserved	
1	Reserved								
2	Reserved								
3	Reserved								

The Structure Data Length field *shall* indicate the number of bytes following this field.

The Persistent Write Protection (PWP) bit of one indicates that the medium surface *shall* be set to write protected status.

The PWP bit of zero indicates that the medium surface *shall* be set to write permitted status.

Table 780 describes errors that may occur during the operation of the command or which may cause a CHECK CONDITION status to be reported.

Table 780 - SEND DISC STRUCTURE command errors

Error Description
A-1.1, "Deferred Error Reporting" on page 919
Table 835 - Basic Error Codes on page 932
Table 836 - Media Access Error Codes on page 935
Table 837 - Write Error Codes on page 938

17.37 SEND EVENT command

The SEND EVENT command requests the logical unit to process an event for the host. The Event should be one that the host had received from an earlier GET EVENT/STATUS NOTIFICATION command but not handled by the host.

If a logical unit has received a persistent prevent, it will report events via the GET EVENT/STATUS NOTIFICATION command instead of processing them directly. For example if a user pushes an independent play button on the front panel while the logical unit is in a Persistent Prevent state, the play would not be performed and instead the request *shall* be reported to the host by a GET EVENT/STATUS NOTIFICATION command. Such events may include front panel button presses, etc. When such a request is received by the host, it should complete any operations in progress and process the event by emulating the button's functionality via commands or sending the event back to the logical unit using the SEND EVENT command.

The Media Class Events reported to the host *shall not* be sent back to the logical unit using the SEND EVENT command. Only Events of External Request Class *shall* be sent via the SEND EVENT command.

Table 781 - SEND EVENT Command Descriptor Block

Bit Byte	7	6	5	4	3	2	1	0
0	Operation Code (A2h)							
1	LUN (Obsolete)			Reserved				Immed
2	Reserved							
3	Reserved							
4	Reserved							
5	Reserved							
6	Reserved							
7	Reserved							
8	(MSB) Parameter List Length (LSB)							
9								
10	Reserved							
11	Vendor-Specific		Reserved			NACA	Flag	Link

An immediate (Immed) bit of zero *shall* indicate that the command *shall not* complete until the requested operation is complete. An Immed bit of one indicates that status *shall* be returned as soon as the Command Packet has been validated. The actual operation specified by the Event Parameter *shall* be processed after the status has been reported to the host. The Immed bit *shall* be set to 1 for ATAPI logical units.

The Parameter List Length field specifies the length in bytes of the Event parameter list that *shall* be transferred from the host to the logical unit after the Command Packet is transferred. A Parameter List Length of zero indicates that no data *shall* be transferred. This condition *shall not* be considered as an error.

If the Event parameter list length results in the truncation of Event parameter data, the logical unit *shall* terminate the command with CHECK CONDITION Status, 5/1A/00 PARAMETER LIST LENGTH ERROR.

The logical unit *shall* terminate the command with CHECK CONDITION Status, 5/26/00 INVALID FIELD IN PARAMETER LIST, and *shall not* take any action directed by the event specified for the following conditions:

1. If the host sets any unreserved field in the Event parameter header to an unsupported value.
2. If an host sends an Event parameter list with a Event Data Length not equal to the length returned by the GET EVENT/STATUS NOTIFICATION command for the specified event class.
3. If the host sends an invalid value for any Event parameter.

The Parameter List *shall* consist of an Event Parameter Header followed by an External Request Event Descriptor. See Table 452 - *Notification Status List* on page 631 for the Parameter List layout, Table 453 - *Event Header* on page 631 for the Event Status Header format, and 17.5.3, "*External Request Class Events*" on page 633 for a description of the External Request Class Descriptor.

No more than one External Request Event Descriptor *shall* be sent by the host.

Table 782 - SEND EVENT command errors

Error Description
<i>A-1.1, "Deferred Error Reporting" on page 919</i>
<i>Table 835 - Basic Error Codes on page 932</i>

17.38 SEND KEY command

The SEND KEY command provides data necessary for authentication process. Different type of authentication process and key exchange may be classified by different Key Class. When the Key Class is different, definitions of the rest of Command Descriptor Block may be different. Currently the following Key Classes are assigned.

Table 783 - Key Class definitions

Key Class	Authentication Type
00h	DVD CSS/CPPM or CPRM
01h	Obsolete
02h	AACS
03h-1Fh	Reserved
20h	VCPS (See MMC)
21h	SecurDisc
22h-FFh	Reserved

17.38.1 SEND KEY command for DVD CSS/CPPM or CPRM (Key Class = 00h)

The SEND KEY command with Key Class = 00h is used for DVD CSS/CPPM authentication process and CPRM authentication process. The SEND KEY command with Key Class = 00h provides data necessary for authentication and for generating a Bus Key for the DVD logical unit.

This command, in conjunction with REPORT KEY command, is intended to perform authentication for logical units which conform to DVD content protection scheme and to generate a Bus Key as the result of authentication.

Note: DVD CSS/CPPM and CPRM authentication use the same Key Class field value since they have the same Challenge KEY, KEY1, and KEY2 sizes, and since they are licensed through the same entity.

Table 784 - SEND KEY Command Descriptor Block (Key Class = 00h)

Bit Byte	7	6	5	4	3	2	1	0
0	Operation Code (A3h)							
1	LUN (Obsolete)			Reserved				
2	Reserved							
3	Reserved							
4	Reserved							
5	Reserved							
6	Reserved							
7	Key Class							
8	(MSB) Parameter List Length (LSB)							
9								
10	AGID			KEY Format				
11	Vendor-Specific			Reserved		NACA	Flag	Link

The KEY Format field specifies the type of information that is sent to the logical unit.

The AGID field is used to control simultaneous key exchange sequences. The AGID specified in subsequent Key Exchange commands *shall* match a currently active AGID. The AGID field is further described in the REPORT KEY command. See 17.30, on page 817.

The Parameter List Length field specifies the length in bytes of the SEND KEY parameter list that *shall* be transferred from the host to the logical unit after the Command Packet is transferred. A Parameter List Length of zero indicates that no data *shall* be transferred. This condition *shall not* be considered as an error.

If the Parameter List Length results in the truncation of any SEND KEY parameter list, the logical unit *shall* terminate the command with CHECK CONDITION status, 5/1A/00 PARAMETER LIST LENGTH ERROR.

Table 785 - Key Format code definitions for SEND KEY command (Key Class = 00h)

Key Format	Sent Data	Description	AGID Use
000001b	Challenge KEY	Accepts a Challenge KEY	Valid AGID required
000011b	KEY2	Accepts a KEY2	
000110b	RPC Structure	Set Region	Reserved & Ignored
111111b	None	Invalidate Specified AGID. Invalidating an invalid AGID <i>shall not</i> be considered an error. An AGID that has not been granted <i>shall</i> be considered invalid.	Valid AGID required
All other values		Reserved	

17.38.1.1 SEND KEY data format for DVD CSS/CPPM, or CPRM (Key Class = 00h)

The following sections 17.38.1.1.1 through 17.38.1.1.3 specifies the data sent to the logical unit by this command with Key Class = 00h.

17.38.1.1.1 Challenge Key (KEY Format = 000001b)

Table 786 - SEND KEY Parameter List (With KEY Format = 000001b, Key Class = 00h)

Bit Byte	7	6	5	4	3	2	1	0
0	(MSB)							
1	SEND KEY Parameter List Length (0Eh)							
2	(LSB)							
3	Reserved							
4	Reserved							
Challenge Key								
0	(MSB)							
:	Challenge Key Value							
9	(LSB)							
10	Reserved							
11	Reserved							

The SEND KEY Parameter List Length field specifies the length in bytes of the following SEND KEY parameter list to be transferred to the logical unit. The SEND KEY Parameter List Length value does not include the SEND KEY Parameter List Length field itself.

The Challenge Key Value is sent to the DVD logical unit to get corresponding KEY1 from the DVD logical unit to interrogate conformity with DVD Copy Protection scheme.

17.38.1.1.2 KEY 2 (KEY Format = 000011b)

Table 787 - SEND KEY Parameter List (With KEY Format = 000011b, Key Class = 00h)

Bit Byte	7	6	5	4	3	2	1	0
0	(MSB) SEND KEY Parameter List Length (0Ah) (LSB)							
1								
2	Reserved							
3	Reserved							
KEY 2								
0	(MSB) KEY2 Value (LSB)							
:								
4								
5	Reserved							
6	Reserved							
7	Reserved							

The SEND KEY Parameter List Length field specifies the length in bytes of the following SEND KEY parameter list to be transferred to the logical unit. The SEND KEY Parameter List Length value does not include the SEND KEY Parameter List Length field itself.

The KEY2 Value, generated external to the DVD logical unit, is sent to the DVD logical unit to determine its conformity with DVD Copy Protection scheme. The KEY2 Value will be used for the second input to generate a Bus Key in the DVD logical unit.

When the KEY2 Value sent does not conform with the DVD Copy Protection scheme, this command *shall* be terminated with CHECK CONDITION status, 5/6F/00 COPY PROTECTION KEY EXCHANGE FAILURE - AUTHENTICATION FAILURE.

When the SEND KEY command with KEY Format = 000011b terminates with CHECK CONDITION status, the retry of authentication *shall* be performed from the beginning.

17.38.1.1.3 RPC Structure (KEY Format = 000110b)

Table 788 - SEND KEY Parameter List (With KEY Format = 000110b, Key Class = 00h)

Bit Byte	7	6	5	4	3	2	1	0
0	(MSB) SEND KEY Parameter List Length (06h) (LSB)							
1								
2	Reserved							
3	Reserved							
RPC Structure								
0	Preferred Drive Region Code							
1	Reserved							
2	Reserved							
3	Reserved							

The SEND KEY Parameter List Length field specifies the length in bytes of the following SEND KEY parameter list to be transferred to the logical unit. The SEND KEY Parameter List Length value does not include the SEND KEY Parameter List Length field itself.

Preferred Drive Region Code is sent to the DVD logical unit to make the logical unit regionalized. The Preferred Drive Region Code specifies a single region in which the disc can be played. Each bit represents one of eight regions. If a bit is Cleared in this field, the disc can be played in the corresponding region. If a bit is Set in this field, the disc cannot be played in the corresponding region. Exactly one bit of the Preferred Drive Region Code *shall* contain a zero.

If the logical unit does not support setting of the Region, or the Region is no longer changeable, then this command *shall* be terminated with CHECK CONDITION status, 5/6F/05 DRIVE REGION MUST BE PERMANENT/REGION RESET COUNT ERROR.

17.38.2 SEND KEY command for AACS (Key Class = 02h)

The SEND KEY command with Key Class = 02h is used for AACS authentication process. The SEND KEY command with Key Class = 02h provides data necessary for authentication and for generating a Bus Key and ends the authentication process.

Table 789 - SEND KEY Command Descriptor Block (Key Class = 02h)

Bit Byte	7	6	5	4	3	2	1	0
0	Operation Code (A3h)							
1	LUN (Obsolete)			Reserved				
2	Reserved							
3	Reserved							
4	Reserved							
5	Reserved							
6	Reserved							
7	Key Class							
8	(MSB) Parameter List Length (LSB)							
9								
10	AGID		KEY Format					
11	Vendor-Specific		Reserved			NACA	Flag	Link

The KEY Format field specifies the type of information that is sent to the logical unit.

The AGID field is used to control simultaneous key authentication process. The AGID for AACS specified in subsequent commands for the given authentication process *shall* match a currently active AGID for AACS. The AGID field is further described in the REPORT KEY command. See Section 17.30, "REPORT KEY command" on page 817.

The Parameter List Length field specifies the length in bytes of the SEND KEY parameter list that *shall* be transferred from the host to the logical unit after the Command Packet is transferred. A Parameter List Length of zero indicates that no data *shall* be transferred. This condition *shall not* be considered as an error.

If the Parameter List Length results in the truncation of any SEND KEY parameter list, the logical unit *shall* terminate the command with CHECK CONDITION status, 5/1A/00 PARAMETER LIST LENGTH ERROR.

Table 790 - Key Format code definitions for SEND KEY command (Key Class = 02h)

Key Format	Sent Data	Description	AGID Use
000001b	Host Certificate Challenge	Send a Host Certificate Challenge to logical unit	Valid AGID required
000010b	Host Key	Send a Host Key to logical unit	
111111b	None	Invalidate Specified AGID for AACS. Invalidating an invalid AGID for AACS <i>shall not</i> be considered an error. An AGID for AACS that has not been granted <i>shall</i> be considered invalid.	
All other values		Reserved	

17.38.2.1 SEND KEY data format for AACS (Key Class = 02h)

The following sections 17.38.2.1.1 through 17.38.2.1.2 specifies the data sent to the logical unit by this command with Key Class = 02h.

17.38.2.1.1 Host Certificate Challenge (KEY Format = 000001b)**Table 791 - SEND KEY Parameter List (With KEY Format = 000001b, Key Class = 02h)**

Bit Byte	7	6	5	4	3	2	1	0	
0	SEND KEY Parameter List Length (72h)							(MSB)	(LSB)
1									
2	Reserved								
3	Reserved								
Host Certificate Challenge									
0	Host Certificate Challenge Data							(MSB)	(LSB)
:									
111									

The SEND KEY Parameter List Length field specifies the length in bytes of the following SEND KEY parameter list to be transferred to the logical unit. The SEND KEY Parameter List Length value does not include the SEND KEY Parameter List Length field itself.

The Host Certificate Challenge Data is sent to the logical unit to be used by the logical unit to verify legitimacy of the host.

When the Host Certificate Challenge Data is verified as it is not legitimate or is revoked, the command *shall* be terminated with CHECK CONDITION status, 5/6F/00 COPY PROTECTION KEY EXCHANGE FAILURE - AUTHENTICATION FAILURE.

17.38.2.1.2 Host Key (KEY Format = 000010b)**Table 792 - SEND KEY Parameter List (With KEY Format = 000010b, Key Class = 02h)**

Bit Byte	7	6	5	4	3	2	1	0
0	(MSB) SEND KEY Parameter List Length (52h) (LSB)							
1								
2	Reserved							
3	Reserved							
Host Key								
0	(MSB) Host Key Data (LSB)							
:								
79								

The SEND KEY Parameter List Length field specifies the length in bytes of the following SEND KEY parameter list to be transferred to the logical unit. The SEND KEY Parameter List Length value does not include the SEND KEY Parameter List Length field itself.

The Host Key Data is sent to the logical unit to be used, together with the Drive Key Data, to generate the Bus Key.

17.38.3 SEND KEY command for SecurDisc (Key Class = 21h)

The SEND KEY command with Key Class = 21h is used for SecurDisc authentication process. The SEND KEY command with Key Class = 21h provides data necessary for authentication and for generating a Bus Key for the logical unit.

Table 793 - SEND KEY Command Descriptor Block (Key Class = 21h)

Bit Byte	7	6	5	4	3	2	1	0
0	Operation Code (A3h)							
1	LUN (Obsolete)				Reserved			
2	Reserved							
3	Reserved							
4	Reserved							
5	Reserved							
6	Reserved							
7	Key Class							
8	(MSB) Parameter List Length (LSB)							
9								
10	AGID			KEY Format				
11	Vendor-Specific			Reserved		NACA	Flag	Link

The KEY Format field specifies the type of information that is sent to the logical unit.

The AGID field is used to control simultaneous key exchange sequences. The AGID specified in subsequent Key Exchange commands *shall* match a currently active AGID. The AGID field is further described in the REPORT KEY command. See Section 17.30, "REPORT KEY command" on page 817.

The Parameter List Length field specifies the length in bytes of the SEND KEY parameter list that *shall* be transferred from the host to the logical unit after the Command Packet is transferred. A Parameter List Length of zero indicates that no data *shall* be transferred. This condition *shall not* be considered as an error.

If the Parameter List Length results in the truncation of any SEND KEY parameter list, the logical unit *shall* terminate the command with CHECK CONDITION status, 5/1A/00 PARAMETER LIST LENGTH ERROR.

Table 794 - Key Format code definitions for SEND KEY command (Key Class = 21h)

Key Format	Sent Data	Description	AGID Use
000001b	Host Key Contribution	Send host random number and protocol version	Valid AGID required
111111b	None	Invalidate Specified AGID. Invalidating an invalid AGID <i>shall not</i> be considered an error. An AGID that has not been granted <i>shall</i> be considered invalid.	
All other values		Reserved	

17.38.3.1 SEND KEY data format for SecurDisc (Key Class = 21h)

The following section 17.38.3.1.1 specifies the data sent to the logical unit by this command with Key Class = 21h.

17.38.3.1.1 Host Key Contribution (KEY Format = 000001b)

Table 795 - SEND KEY Parameter List (With KEY Format = 000001b, Key Class = 21h)

Bit Byte	7	6	5	4	3	2	1	0
0	(MSB)							
1	SEND KEY Parameter List Length (2Ah)							(LSB)
2	Reserved							
3	Reserved							
Host Key Contribution								
0	(MSB)							
:	Encrypted Host Random Number (R2)							(LSB)
15								
16	Protocol Version							
17	Bit Position Index Value (x)							
18	(MSB)							
:	Revocation Block Node Key (RBNK)							(LSB)
33								
34	(MSB)							
:	Application Authentication Unique ID (AAUID)							(LSB)
37								
38-39	Reserved							

The SEND KEY Parameter List Length field specifies the length in bytes of the following SEND KEY parameter list to be transferred to the logical unit. The SEND KEY Parameter List Length value does not include the SEND KEY Parameter List Length field itself.

Encrypted Host Random Number (R2) contains the 128-bit random number created by the host, encrypted using the secret key PK1 that has been assigned to the logical unit.

Protocol Version contains the protocol version number for the authentication sequence to be used.

Bit Position Index Value (x) specifies the index within the PK1 array assigned to the logical unit that should be used by the logical unit to build PK1.

Revocation Block Node Key (RBNK) specifies the node key associated with position x in the Drive Revocation Block (DRB) as a 128-bit key value.

Application Authentication Unique ID (AAUID) specifies the Application Authentication Unique ID which will be used by the logical unit to do Application Authentication Revocation Block (AARB) parsing. When the Application Authentication Unique ID is verified as it is not legitimate or is revoked, the command *shall* be terminated with CHECK CONDITION status, 5/6F/00 COPY PROTECTION KEY EXCHANGE FAILURE - AUTHENTICATION FAILURE.

Table 796 describes errors that may occur during the operation of the command or which may cause a CHECK CONDITION status to be reported.

Table 796 - SEND KEY command errors

Error Description
<i>A-1.1, "Deferred Error Reporting" on page 919</i>
<i>Table 835 - Basic Error Codes on page 932</i>
<i>Table 836 - Media Access Error Codes on page 935</i>
<i>Table 839 - Authentication Error Codes on page 939</i>

17.39 SEND OPC INFORMATION command

This command is used to restore the Optimum Power Calibration (OPC) values to the logical unit for a specific disc. For CD, it is used in combination with the READ DISC INFORMATION command.

Table 797 - SEND OPC INFORMATION Command Descriptor Block

Bit Byte	7	6	5	4	3	2	1	0
0	Operation Code (54h)							
1	Reserved			Reserved			DoOpc	
2	Reserved							
3	Reserved							
4	Reserved							
5	Reserved							
6	Reserved							
7	(MSB) Parameter List Length (Obsolete) (LSB)							
8								
9	Vendor-Specific	Reserved			NACA	Flag	Link	
10	PAD							
11								

The DoOpc bit, when set to one, indicates the logical unit *shall* perform an OPC operation to set the OPC values for the current speed. When this bit is set to zero, logical unit does not perform any operation. When Parameter List Length (Obsolete) field is not set to zero, the logical unit *shall* report CHECK CONDITION Status, 5/24/00 INVALID FIELD IN CDB.

If PCA is almost full, and the DoOpc bit is set to one, the command *shall* be performed normally and report CHECK CONDITION Status, 1/73/01 POWER CALIBRATION AREA ALMOST FULL.

If PCA is full, and the DoOpc bit is set to one, the command is not performed, and the logical unit *shall* report CHECK CONDITION Status, 3/73/02 POWER CALIBRATION AREA IS FULL.

For HD DVD, if current PCA is almost full, Test zone is not extended, and the DoOpc bit is set to one, then the command *shall* be performed normally and report CHECK CONDITION Status, 1/73/10 CURRENT POWER CALIBRATION AREA ALMOST FULL. If current PCA is full, Test zone is not extended, and the DoOpc bit is set to one, then the command is not performed, and the logical unit *shall* report CHECK CONDITION Status, 5/73/11 CURRENT POWER CALIBRATION AREA IS FULL.

For HD DVD, the Error reporting for the command in each condition of the media is shown in Table 200 - *Error reporting for SEND OPC INFORMATION command* on page 365.

For HD DVD, when the number of the unrecorded ECC blocks in Current RMZ is equal to or less than 8, the logical unit *shall not* write RMD on the disc.

Table 798 - SEND OPC INFORMATION Parameter List (Obsolete)

Bit Byte	7	6	5	4	3	2	1	0
0	(MSB)							
1	OPC Speed in kBytes per Second							(LSB)
2	(MSB)							
3	OPC Value							
4								
5								
6								
7								

Table 799 describes errors that may occur during the operation of the command or which may cause a CHECK CONDITION status to be reported.

Table 799 - SEND OPC INFORMATION command errors

Error Description
<i>A-1.1, "Deferred Error Reporting" on page 919</i>
<i>Table 835 - Basic Error Codes on page 932</i>
<i>Table 836 - Media Access Error Codes on page 935</i>
<i>Table 837 - Write Error Codes on page 938</i>

17.40 SET CD SPEED command

The SET CD SPEED command is used to set Read Speed and Write Speed and only applicable to CD-R/RW logical unit.

Note: PLAY commands will not use the speed that is set by this command.

Table 800 - SET CD SPEED Command Descriptor Block

Bit Byte	7	6	5	4	3	2	1	0
0	Operation Code (BBh)							
1	LUN (Obsolete)			Reserved			Rotational Control	
2	(MSB) Logical unit Read Speed (kBytes/sec) (LSB)							
3								
4	(MSB) Logical unit Write Speed (kBytes/sec) (LSB)							
5								
6	Reserved							
7	Reserved							
8	Reserved							
9	Reserved							
10	Reserved							
11	Vendor-Specific		Reserved			NACA	Flag	Link

The Logical unit Read Speed and Logical unit Write Speed parameters contain the requested Data rates the logical unit should use.

Host **shall** set one of the values of logical unit Write Speed Performance Descriptor in C/DVD Capabilities and Mechanical Status mode page to Rotational Control field and Logical unit Write Speed field.

The logical unit is to select the Logical unit Read Speed specified or any higher rate. A value of FFFFh will set the Logical unit Read Speed or the Logical unit Write Speed to the best performance supported. If the logical unit is requested to write at the speed which is not listed in the logical unit Write Speed Performance Descriptor, the logical unit **shall** select any slower logical unit Write Speed. This condition is not regarded as an error condition. If the logical unit is requested to write at the lower speed than the logical unit's slowest speed, the logical unit may return CHECK CONDITION Status, 5/24/00 INVALID FIELD IN CDB or select an appropriate logical unit Write Speed.

Note: logical unit should return an error if current write mode is not packet write and buffer under-run free recording is not supported.

The Rotational Control field defines the operations that are defined in Table 801.

Table 801 - Rotational Control field definition

Value	Definition
0h	Non-pure CAV and CLV recording
1h	Pure CAV recording
Other values	Reserved

In the case of non-CLV rotational control, the logical unit Write Speed field value **shall** be assumed to reference the speed at 79:59:74 MSF, regardless of actual capacity or disc diameter.

The logical unit keeps the actual write speed setting till the current disc is ejected. When the disc is changed to another one and it does not support the write speed that was set for the previous media, the logical unit may select an appropriate write speed to the current medium. It is recommended that the host should set the write speed upon the media change.

Table 802 describes errors that may occur during the operation of the command or which may cause a CHECK CONDITION status to be reported.

Table 802 - SET CD SPEED command errors

Error Description
<i>A-1.1, "Deferred Error Reporting" on page 919</i>
<i>Table 835 - Basic Error Codes on page 932</i>
<i>Table 836 - Media Access Error Codes on page 935</i>
<i>Table 837 - Write Error Codes on page 938</i>

17.41 SET READ AHEAD command

The SET READ AHEAD command requests that the logical unit perform Read Ahead Caching operations from the Read Ahead Logical Block Address when the logical unit encounters the Trigger Logical Block Address during its internal Read Ahead Caching operation.

If this command is received by the logical unit when data after the Trigger Logical Block Address (Trigger LBA) and before the Read Ahead Logical Block Address (Read Ahead LBA) is contained in its cache, that data should be discarded and Read Ahead Caching restarted from the specified Read Ahead Logical Block Address.

Sectors after the Trigger LBA (Not including the Trigger LBA) should be skipped. The data for both the Trigger and Read Ahead LBAs will normally be read by the host. The sectors between these addresses (exclusive) are normally not read by the host.

Note: The host should expect seek delays if these sectors are read.

If the logical unit has enough performance, the logical unit may perform no operation and returns GOOD CONDITION status.

If the logical unit performs the Read-Ahead operation, the operation *shall* be performed in background, i.e. the logical unit *shall* accept a command during the Read-Ahead operation.

Table 803 - SET READ AHEAD Command Descriptor Block

Bit Byte	7	6	5	4	3	2	1	0
0	Operation Code (A7h)							
1	LUN (Obsolete)			Reserved				
2	(MSB) Trigger Logical Block Address (LSB)							
3								
4								
5								
6	(MSB) Read Ahead Logical Block Address (LSB)							
7								
8								
9								
10	Reserved							
11	Vendor-Specific	Reserved			NACA	Flag	Link	

Table 804 describes errors that may occur during the operation of the command or which may cause a CHECK CONDITION status to be reported.

Table 804 - SET READ AHEAD command errors

Error Description
A-1.1, "Deferred Error Reporting" on page 919
Table 835 - Basic Error Codes on page 932
Table 836 - Media Access Error Codes on page 935

17.42 SET STREAMING command

The SET STREAMING command provides a way for the host to indicate to the logical unit that the application has specific request or requirements for logical unit performance.

Table 805 - SET STREAMING command Descriptor Block

Bit Byte	7	6	5	4	3	2	1	0
0	Operation Code (B6h)							
1	LUN (Obsolete)			Reserved				
2	Reserved							
3	Reserved							
4	Reserved							
5	Reserved							
6	Reserved							
7	Reserved							
8	Type							
9	(MSB) Parameter List Length (LSB)							
10								
11	Vendor-Specific	Reserved			NACA	Flag	Link	

The **Type** field specifies which type of data *shall* be transferred. If logical unit does not report Enhanced Defect Reporting Feature, host *shall* set the **Type** field to 0. If logical unit reports Enhanced Defect Reporting Feature, the logical unit *shall* support the **Type** field. The **Type** field is defined in Table 806.

If logical unit does not support 10.3.4.3, "Small DBI cache memory model" on page 482 and **Type** field is set to other than 0, the logical unit *shall* terminate this command with CHECK CONDITION status, 5/24/00 INVALID FIELD IN CDB.

Table 806 - Type field values description

Type field value	Description	Reference
0	Performance descriptor	see 17.42.1
1-4	Reserved	
5	DBI cache zone descriptor	see 17.42.2
Others	Reserved	

The **Parameter List Length** field specifies the length in bytes of the Performance Descriptor that *shall* be transferred from the host to the logical unit after the Command Packet is transferred. A **Parameter List Length** of zero indicates that no data *shall* be transferred. This condition *shall not* be considered as an error.

If the **Parameter List Length** results in the truncation of Performance Descriptor, the logical unit *shall* terminate the command with CHECK CONDITION status, 5/1A/00 PARAMETER LIST LENGTH ERROR.

17.42.1 Performance descriptor

The Performance descriptor provides a way for the host to indicate to the logical unit that the application has specific request for logical unit performance. The logical unit may utilize the host supplied information to change mechanical or logical operation. For example, the spindle motor speed may be adjusted downward for lower data rates to help avoid buffer overrun (during reading) or buffer under-run (during writing) followed by a consequent rotational delay. The

logical unit resets the performance as default at medium ejection. The setting only applies to the extent identified by the Start and End LBA field. Only zero or one performance extents *shall* be valid at any time.

If the SET STREAMING command is used to set performance, the logical unit may disable read and write reallocation in the specified region in order to meet the performance criteria. The host *shall* send a Performance Descriptor during the data phase of this command. The Performance Descriptor *shall* be sent in the format shown in Table 807.

Table 807 - Performance Descriptor

Bit Byte	7	6	5	4	3	2	1	0
0	Reserved		HIE	WRC		RDD	Exact	MRW
1	Reserved							
2	Reserved							
3	Reserved							
4	(MSB)							
5	Start LBA							
6								
7								
7								
8	(MSB)							
9	End LBA							
10								
11								
11								
12	(MSB)							
13	Read Size							
14								
15								
15								
16	(MSB)							
17	Read Time							
18								
19								
19								
20	(MSB)							
21	Write Size							
22								
23								
23								
24	(MSB)							
25	Write Time							
26								
27								
27								

The Higher than or Equal to (HIE) bit indicates that Reading/Writing throughput is specified for higher than or equal to the address range specified by the Start LBA and the End LBA. When HIE bit is set to 1, drive *shall* ignore MRW bit and WRC field to satisfy the specified throughput on the mounted medium.

~~See Table 492—Write Rotation Control values on page 651. If logical unit does not support the write rotation control mode specified, the logical unit *shall* generate CHECK CONDITION status, 5/26/00 INVALID FIELD IN PARAMETER LIST.~~

The Write Rotation Control (WRC) field specifies the type of the medium rotation control to write. See Table 492 - Write Rotation Control values on page 651. If logical unit does not support the write rotation control mode

specified, the logical unit **shall** generate CHECK CONDITION status, 5/26/00 INVALID FIELD IN PARAMETER LIST.

The Restore Drive Defaults (RDD) bit, when set to zero, means that the remaining fields are valid. When set to one, **shall** indicate that the logical unit is to return to its default performance settings and the remaining fields in this descriptor **shall** be ignored. Read and Write reallocation ability **shall** be restored to operation specified by the Read-Write Error Recovery mode page.

The Exact bit, when set to zero, **shall** indicate that the logical unit set its internal configuration to match the parameters as best as possible. No errors **shall** occur. When set to one, **shall** indicate that the logical unit set its internal configuration to support the requested parameters. If the logical unit cannot perform as requested, it **shall** generate CHECK CONDITION status, 5/26/00 INVALID FIELD IN PARAMETER LIST, and the Sense Key Specific bytes **shall** identify the Size or Time parameter that is not valid.

When Exact bit and HIE bit are set to 1 if logical unit cannot perform the requested parameter that is Reading/Writing throughput higher than or equal to the address range, the logical unit **shall** generate CHECK CONDITION status, 5/26/00 INVALID FIELD IN PARAMETER LIST.

Note: When other configuration setting does not allow the throughput, logical unit generates CHECK CONDITION status, 5/26/00 INVALID FIELD IN PARAMETER LIST.

When Exact bit is set to 0 and HIE bit is set to 1 logical unit should set its internal configuration to higher than or equal to the specified throughput as near as possible. No errors **shall** occur. When the specified throughput is not possible the logical unit is allowed to select the highest throughput that is lower than the specified throughput.

Note: When other configuration setting does not allow the throughput, logical unit may select the highest throughput that is allowed by the configuration and is lower than the specified throughput. host may check the assigned performance by Performance (Type field = 00h) of GET PERFORMANCE command.

The Mixed Read/Write (MRW) bit, when set to zero, allows the logical unit to independently set the read and write speeds. When set to one, **shall** indicate to the logical unit that its performance settings should be optimized for random changes between reading and writing by the host. For example, a CD recorder that can record at 2× and read at 6× may choose to limit reading to 2× if the MRW bit was set to one.

The Start LBA field is the first logical block for which the performance request is being made.

The End LBA field is the last logical block for which the performance request is being made.

Note: In the case of the Dual layer disc the End LBA field may specify the end LBA of the high bit rates contents on Layer 1. In this case logical unit should check Start LBA on layer 0 and End LBA on layer 1 which specifies the inner radius of the disc.

The data rate to be delivered for reading is $\frac{\text{ReadSize}}{\text{ReadTime}}$.

The Read Size field **shall** indicate the number of kilobytes the host expects to be delivered per period of Read Time when the host's requests for data occur sufficiently fast.

The Read Time field **shall** indicate the amount of time, in milliseconds, over which the Read Size is expected to be read.

The host may set these two fields by setting Read Size to the size of its application's buffer and the Read Time to the amount of time it takes to empty that buffer.

The Write Size field **shall** be set to the number of kilobytes to be written per Write Time.

The Write Time field **shall** indicate the amount of time, in milliseconds, over which the Write Size is expected to be written.

When Write Size field is set to 0 the Writing throughput is not specified. The Write Time field should not be set to 0 (host may set 1000) to avoid logical unit error of division by 0. The logical unit **shall** refer Read Size/Read Time fields.

When the highest Writing speed of the logical unit for the mounted media is slower than the specified throughput and when data writing is occurred, logical unit **shall** adjust its internal configuration as near as possible to the specified

throughput (it should be the highest writing speed). No errors *shall* occur on the write operation. Reading speed that followed the writing may be changed by this write operation.

Note: Playback software that needs higher reading throughput than the highest Writing should check the currently applied performance by GET PERFORMANCE command.

In many cases, the **Write Size** and **Write Time** fields should be set to match the corresponding Read fields. If not, the host may set the **Write Size** to the size of its application buffer and the **Write Time** to the time it takes to fill that buffer.

When the logical unit is not able to write the mounted medium (e.g. Read only disc is mounted), logical unit *shall not* terminate the command with Check Condition due to the **Write Size** and **Write Time** fields. When the mounted medium is write protected that is changeable by host (e.g. Persistent Write Protection (PWP) of 17.36.12, "Write Protection (Format Code = C0h)" on page 871) logical unit *shall* check the **Write Size** and **Write Time** fields. When Exact bit and HIE bit are set to 1 if logical unit cannot perform the requested parameter, logical unit *shall* generate CHECK CONDITION status, 5/26/00 INVALID FIELD IN PARAMETER LIST.

When normal Reading/Writing is performed, defect management may reduce the throughput.

When normal Reading/Writing is performed, logical unit should perform possible retry of the Reading/Writing to end the operation successfully. This retry may change the logical unit performance (disc rotation speed may be changed to be lower speed). After the retry operation of the normal Reading/Writing, logical unit should resume the performance to be the specified throughput for Streaming Read/Write.

17.42.2 DBI cache zone Descriptor

The DBI cache zone descriptor provides a way for the host to indicate to the logical unit that the application has specific request for logical unit behavior of small DBI cache model in DRT-DM mode. Disc volume space is divided into a few DBI cache zones. RDBI and WDBI memory *shall* be allocated for each DBI cache zones. At least two DBI cache zones *shall* be supported. Number of supported DBI cache zone is shown in Number of DBI cache zones field of Table 384 - Enhanced Defect Reporting Feature Descriptor on page 589.

Table 808 - DBI cache zone Descriptor

Bit Byte	7	6	5	4	3	2	1	0
0-7	DBI cache zone Header							
8-n	DBI cache zone Descriptor(s)							

Table 809 - DBI cache zone Header

Bit Byte	7	6	5	4	3	2	1	0								
0	(MSB)															
1																
2									DBI cache zone Data Length							
3									(LSB)							
4-7	Reserved															

The DBI cache zone data length field specifies the length in bytes of the following data. The DBI cache zone data length value does not include the DBI cache zone data length field itself.

Table 810 - DBI cache zone Descriptor(s)

Bit Byte	7	6	5	4	3	2	1	0
0	Start LBA of DBI cache zone							
1								
2								
3								
4-7	Reserved							

Start LBA of DBI cache zone field specifies start LBA of a DBI cache zone. Logical unit *shall* adjust the start LBA to the packet start address that includes specified start LBA by Blocking factor for each media. The end address of a DBI cache zone is the end address of a packet that is preceded to the next DBI cache zone. The end address of the last DBI cache zone is the value of the last addressable LBA for the media. In case of CD-RW or DVD-RW media, the last readable address of the last track/RZone is the end address of the last DBI cache zone.

For CD-RW or DVD-RW media, the first DBI cache zone *shall* be started from 0 and host *shall* set the first cache zone start address to 0. In case of small DBI cache model, host should specify 2 descriptors minimally.

If logical unit received any invalid DBI cache zone descriptor and if number of DBI cache zone descriptors exceeded the value of Number of DBI cache zones field, the logical unit *shall* terminate this command with CHECK CONDITION status, 5/26/00 INVALID FIELD IN PARAMETER LIST.

Table 811 describes errors that may occur during the operation of the command or which may cause a CHECK CONDITION status to be reported.

Table 811 - SET STREAMING command errors

Error Description
<i>A-1.1 "Deferred Error Reporting" on page 919</i>
<i>Table 835 - Basic Error Codes on page 932</i>
<i>Table 836 - Media Access Error Codes on page 935</i>
<i>Table 837 - Write Error Codes on page 938</i>

17.43 START STOP UNIT command

The START STOP UNIT command requests that the logical unit enable or disable media access operations.

Table 812 - START STOP UNIT Command Descriptor Block

Bit Byte	7	6	5	4	3	2	1	0
0	Operation Code (1Bh)							
1	LUN (Obsolete)			Reserved				Immed
2	Reserved							
3	Reserved						Destination Format-layer #	
4	Power Condition			Reserved	FL	LoEj	Start	
5	Vendor-Specific	Reserved			NACA	Flag	Link	
6	PAD							
7								
8								
9								
10								
11								

An immediate (Immed) bit of one indicates that status *shall* be returned as soon as the Command Packet has been validated. An Immed bit of zero indicates that status *shall* be returned after the operation is completed.

The Destination Format-layer # field specifies the Format-layer the host has requested to be online. The number set in this field *shall* be less than the Number of recognized Format-layers field value reported by Hybrid disc structure of READ DISC STRUCTURE command. If the value set in the Destination Format-layer # field does not match the number reported by the Hybrid disc structure of the READ DISC STRUCTURE command, the logical unit *shall* terminate the command with CHECK CONDITION status, 5/24/00 INVALID FIELD IN CDB.

The Format-layer (FL) bit of one requests the logical unit to change the online Format-layer to the Format-layer specified by the Destination Format-layer # field. If the FL bit is set to one, both LoEj bit and Start bit *shall* also be set to one. If the FL bit is set to one and either one or both of the LoEj bit and Start bit is set to zero, the logical unit *shall* terminate the command with CHECK CONDITION status, 5/24/00 INVALID FIELD IN CDB. If the FL bit is set to zero, the Destination Format-layer # field *shall* also be set to zero.

If the Hybrid disc Feature exists but is not current and either the FL bit or the Destination Format-layer # field is not set to zero, the logical unit *shall* terminate the command with CHECK CONDITION status, 5/24/00 INVALID FIELD IN CDB.

A Start bit of one requests the logical unit be made ready for use. The IDLE CONDITION TIMER and STANDBY CONDITION TIMER are reloaded. A Start bit of zero requests that the logical unit be stopped (media cannot be accessed by the host). See Table 813.

Table 813 - Start/Stop and Eject Operations

FL	Destination Format-layer #	LoEj	Start	Power Condition	Operation to be Performed
0	0	0	0	0	Stop the Disc
0	0	0	1	0	Start the Disc and read the TOC
0	0	1	0	0	Eject the Disc if possible (See Table 551 - <i>Actions for Lock/Unlock/Eject (Persistent bit = 0)</i> on page 706)

Table 813 - Start/Stop and Eject Operations

FL	Destination Format-layer #	LoEj	Start	Power Condition	Operation to be Performed
0	0	1	1	0	Load the Disc (Close Tray)
1	N	1	1	0	Jump to Format-layer #N
0	0	x	x	1h - Fh	Power Condition Change (Table 815)

Any attempt to Eject or Load a Disc when the logical unit does not support that capability *shall* result in CHECK CONDITION status, 5/24/00 INVALID FIELD IN CDB.

A load eject (LoEj) bit of zero requests that no action be taken regarding loading or ejecting the medium. A LoEj bit of one requests that the medium be unloaded if the start bit is zero. A LoEj bit of one requests that the medium be loaded if the start bit is one.

When the Loading Mechanism Type is a Changer utilizing individual disc change capability (4h), the Eject operation *shall* only eject the disc that is currently in the Play Position. If the Loading Mechanism is a changer utilizing a Cartridge (5h), then the Cartridge *shall* only be ejected when no media is in the play position. See Table 814.

Table 814 - Actions for Eject/Load Disc in Changer

Operation	Locked / Unlocked	If logical unit NOT READY (No Media)	If logical unit READY (Media Present)
Eject	Unlocked	No Error and Tray is opened	No Error: Media Ejects
	Locked	CHECK CONDITION status, 2/53/02 MEDIUM REMOVAL PREVENTED	CHECK CONDITION status, 5/53/02 MEDIUM REMOVAL PREVENTED
	Changer using Cartridge with Disc in Play Position	CHECK CONDITION status, 2/53/02 MEDIUM REMOVAL PREVENTED	CHECK CONDITION status, 5/53/02 MEDIUM REMOVAL PREVENTED
	Changer using Individual disc changeability with no Disc in the Play Position	CHECK CONDITION status, 2/53/02 MEDIUM REMOVAL PREVENTED	CHECK CONDITION status, 5/53/02 MEDIUM REMOVAL PREVENTED
Manual Eject	Unlocked	Tray opens (If tray exists)	Media is ejected
	Locked	No operation occurs	No operation, Media stays locked in logical unit

The Power Condition field requests the logical unit be placed into the power state defined in Table 815. If any bit is set in this field then the Start and the LoEj bits *shall* be ignored.

When the logical unit enters the sleep state, any queued GET EVENT/STATUS NOTIFICATION commands *shall* be removed from the command queue without command completion.

If any commands other than event status are in the queue upon receipt of the sleep command then the sleep command *shall* terminate with CHECK CONDITION status, 5/2C/00 COMMAND SEQUENCE ERROR.

The Immed bit *shall* be ignored if the Power Condition field contains 5h (Place logical unit into Sleep State).

Requests to enter the current power state *shall* complete without error.

If a request to go to a power state fails, the logical unit *shall* remain in the current power state and *shall* generate Power Management Class Event with the Power Event field set to 2h (PwrChg-Fail).

All power state change requests, except sleep, that complete successfully *shall* generate Power Management Class Event with the Power Event field set to 1h (PwrChg-Succ).

Notification of power states *shall* occur upon entering a new power state.

Table 815 - Power Conditions

Code	Description
0h	No change in power conditions or in which logical unit is controlling power conditions
1h	Reserved
2h	Place logical unit into the Idle State, STANDBY CONDITION TIMER is reloaded
3h	Place logical unit into the Standby State
4h	Reserved
5h	Place logical unit into Sleep State. Before entering the sleep state, all buffers <i>shall</i> be successfully flushed by the logical unit. If the sleep command is successful, the host <i>shall not</i> issue new commands after receiving the successful completion status. The Device <i>shall</i> de-power and disable the interface only after all logical units have successful complete sleep commands.
6h-Fh	Reserved

In the Sleep condition the device *shall* only respond to a reset condition. When a device has multiple logical units attached it *shall* enter the Sleep condition only after all the logical units have been placed into a Sleep condition.

17.43.1 Online Format-layer change

When the logical unit receives a request to change the online Format-layer, the logical unit *shall* return status as soon as the CDB has been validated and start changing the Format-layer, regardless of the *Immed* bit setting.

When the logical unit starts changing the online Format-layer, the logical unit behaves as if a new medium is inserted. All the supported Profiles *shall* become not current until the logical unit becomes ready.

The logical unit *shall* terminate the subsequent media access command, including a TEST UNIT READY command issued during the execution of the Format-layer changing process with CHECK CONDITION status, 2/04/01 LOGICAL UNIT IS IN PROCESS OF BECOMING READY.

If the logical unit is prevented from being ejected with non-Persistent mode when the logical unit receives the request to change the online Format-layer, the logical unit *shall* terminate the command with CHECK CONDITION status, 5/53/02 MEDIUM REMOVAL PREVENTED.

When the logical unit becomes ready after changing the online Format-layer with this command, all UNIT ATTENTION condition with 28/02h NOT READY TO READY CHANGE, FORMAT-LAYER MAY HAVE CHANGED, logical unit may have changed Operational State Event and NewMedia Event *shall* be generated.

See Section 6.0, "Hybrid disc model" on page 457.

Table 816 describes errors that may occur during the operation of the command or which may cause a CHECK CONDITION status to be reported.

Table 816 - START STOP UNIT command errors

Error Description
A-1.1, "Deferred Error Reporting" on page 919
Table 835 - Basic Error Codes on page 932
Table 836 - Media Access Error Codes on page 935

17.44 STOP PLAY/SCAN command

The STOP PLAY/SCAN command stops playback of audio or scan commands.

Table 817 - STOP PLAY/SCAN Command Descriptor Block

Bit Byte	7	6	5	4	3	2	1	0
0	Operation Code (4Eh)							
1	LUN (Obsolete)			Reserved				
2	Reserved							
3	Reserved							
4	Reserved							
5	Reserved							
6	Reserved							
7	Reserved							
8	Reserved							
9	Vendor-Specific	Reserved			NACA		Flag	Link
10	PAD							
11	PAD							

Issuing a STOP PLAY/SCAN command while the logical unit is scanning *shall* result in continuation of the play command. Issuing a STOP PLAY/SCAN command while the logical unit is paused *shall* stop the play command.

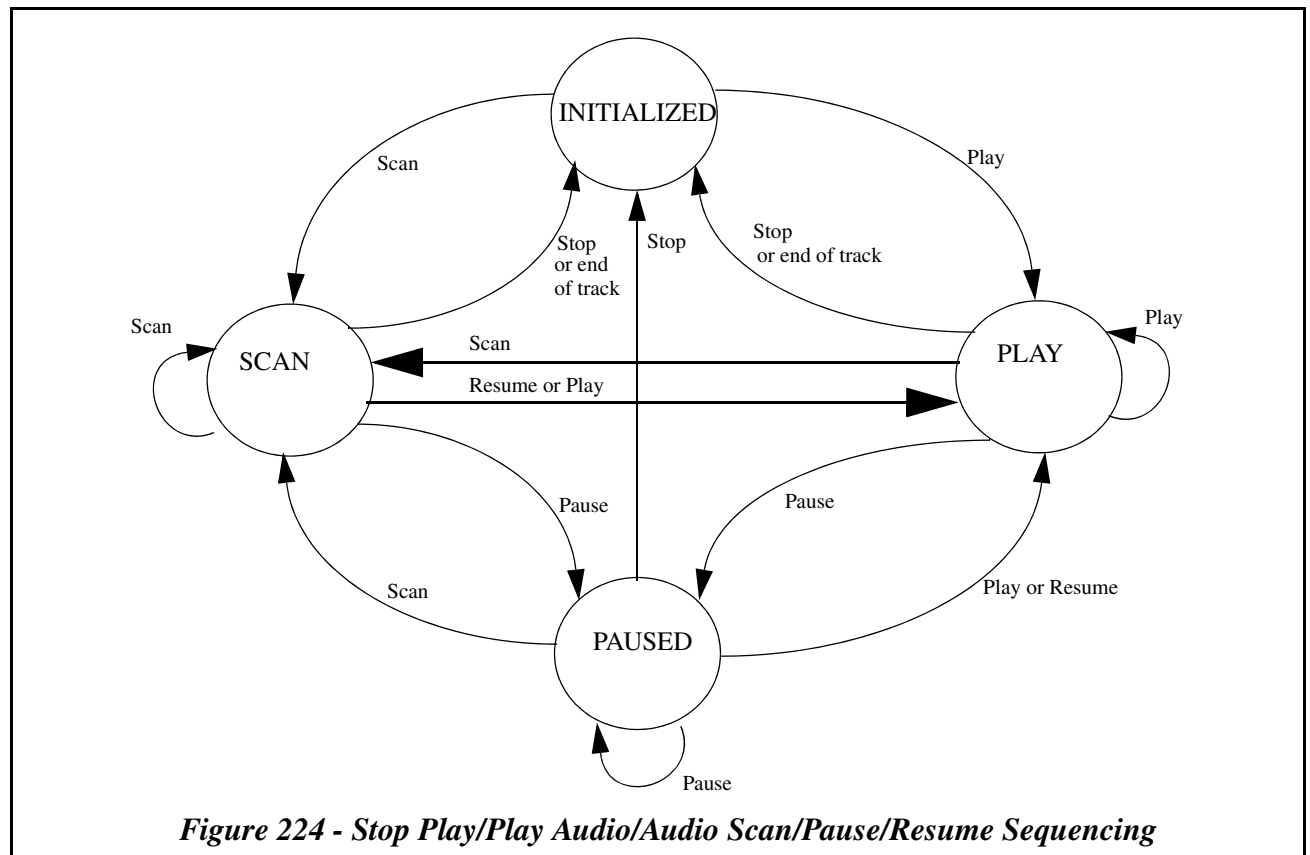


Figure 224 - Stop Play/Play Audio/Audio Scan/Pause/Resume Sequencing

Table 818 - STOP PLAY/SCAN command Errors

Error Description
<i>A-1.1, "Deferred Error Reporting" on page 919</i>
<i>Table 835 - Basic Error Codes on page 932</i>
<i>Table 836 - Media Access Error Codes on page 935</i>

17.45 SYNCHRONIZE CACHE (10) command

The SYNCHRONIZE CACHE (10) command ensures that logical blocks in the cache memory have their most recent data value recorded on the physical medium. If a more recent data value for a logical block exists in the cache memory than on the physical medium, then the logical blocks from the cache memory *shall* be written to the physical medium. Logical blocks are not necessarily removed from the cache memory as a result of the cache flush operation. Table 819 describes the Command Packet.

Note: This command does not make use of the range allowed in the SCSI version of this command. This definition replaces the definition in the SCSI Standard.

Table 819 - SYNCHRONIZE CACHE (10) Command Descriptor Block

Bit Byte	7	6	5	4	3	2	1	0
0	Operation Code (35h)							
1	LUN (Obsolete)			Reserved		Restricted (See SBC-2)	Immediate	Obsolete
2	Logical Block Address (MSB) (LSB)							
3								
4								
5								
6								
7	Number of Blocks							
8								
9	Vendor-Specific		Reserved		NACA	Flag	Link	
10	PAD							
11								

The Immediate bit, when set to zero, indicates that the SYNCHRONIZE CACHE (10) operation *shall* complete before completing the command. When set to one, *shall* indicate that the command *shall* return after the command parameters have been verified.

The Logical Block Address and the Number of Blocks fields may be ignored by the logical unit.

For HD DVD, the Error reporting for the command in each condition of the media is shown in Table 190 - *Error reporting for SYNCHRONIZE CACHE (10) command* on page 361.

For HD DVD, when the number of the unrecorded ECC blocks in Current RMZ is equal to or less than 8, the logical unit *shall not* write RMD on the disc.

Table 820 describes errors that may occur during the operation of the command or which may cause a CHECK CONDITION status to be reported.

Table 820 - SYNCHRONIZE CACHE (10) command errors

Error Description
A-1.1, "Deferred Error Reporting" on page 919
Table 835 - Basic Error Codes on page 932
Table 836 - Media Access Error Codes on page 935
Table 837 - Write Error Codes on page 938
Table 838 - Session/Border Error Codes on page 939

17.46 TEST UNIT READY command

The TEST UNIT READY command provides a means to check if the logical unit is ready. This is not a request for a self-test. If the logical unit would accept an appropriate medium-access command without returning CHECK CONDITION status, this command *shall* return a GOOD status. For unformatted media, the FORMAT UNIT command *shall* be considered an appropriate medium access command. If the logical unit cannot become operational or is in a state such that a host action (e.g., START STOP UNIT command with **Start** = 1) is required to make the unit ready, the logical unit *shall* return CHECK CONDITION status with a Sense Key of NOT READY.

Table 821 - TEST UNIT READY Command Descriptor Block

Bit Byte	7	6	5	4	3	2	1	0
0	Operation Code (00h)							
1	LUN (Obsolete)			Reserved				
2	Reserved							
3	Reserved							
4	Reserved							
5	Vendor-Specific	Reserved			NACA	Flag	Link	
6	PAD							
7								
8								
9								
10								
11								

17.46.1 Using the TEST UNIT READY command

The TEST UNIT READY command is useful in that it allows a host to poll a logical unit until it is ready without the need to allocate space for returned data. It is especially useful to check cartridge status. Logical units are expected to respond promptly to indicate the current status of the logical unit. See Figure 225.

If TEST UNIT READY command is issued during a long immediate operation except BLANK command and FORMAT UNIT command, e.g., CLOSE TRACK/SESSION command with **Immed** bit set to one, the command *shall* be terminated with GOOD status. To detect the completion of the long immediate operation, REQUEST SENSE command or READ TRACK INFORMATION command or READ DISC INFORMATION command should be used.

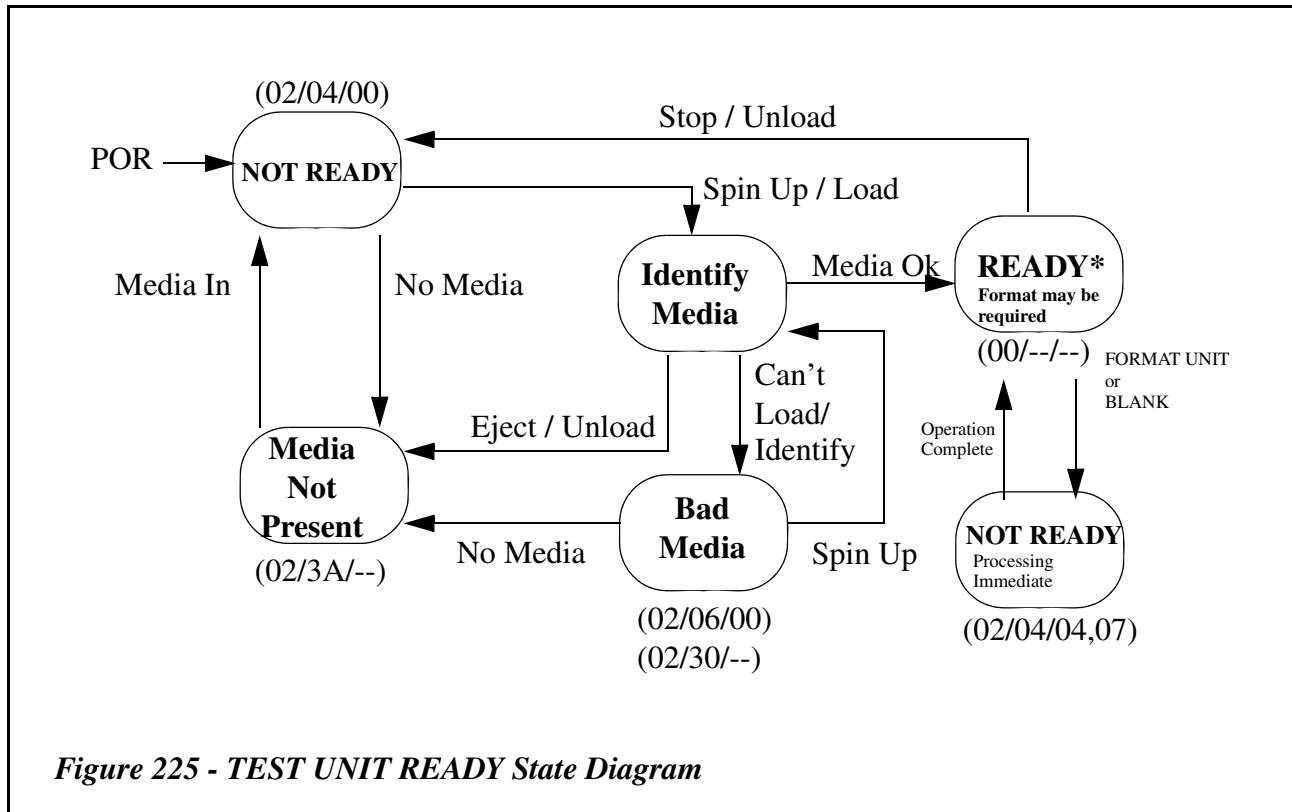


Figure 225 - TEST UNIT READY State Diagram

Table 822 describes errors that may occur during the operation of the command or which may cause a CHECK CONDITION status to be reported.

Table 822 - TEST UNIT READY command errors

Error Description
A-1.1, "Deferred Error Reporting" on page 919
Table 835 - Basic Error Codes on page 932
Table 836 - Media Access Error Codes on page 935

Note: Some logical units return ASC/ASCQ with Audio Status and Sense Key 0 when there is no error condition.

17.47 VERIFY (10) command

The VERIFY (10) command requests that the logical unit verify the data on the medium.

If Enhanced Defect Reporting Feature is current, the logical unit *shall* follow the setting of the PER bit and the EMCDR field in Read-Write Error Recovery mode page. See 10.0, "Logical unit assisted software defect management model" on page 477.

Table 823 - VERIFY (10) Command Descriptor Block

Bit Byte	7	6	5	4	3	2	1	0
0	Operation Code (2Fh)							
1	Restricted (See SBC-2)		DPO (0)	Reserved	BlkVfy	BytChk (0)	Obsolete	
2	Logical Block Address (MSB) (LSB)							
3								
4								
5								
6								
7	Verification Length (MSB) (LSB)							
8								
9	Vendor-Specific	Reserved			NACA	Flag	Link	
10	PAD							
11								

The VERIFY (10) command *shall* use stricter criteria for data recoverability than Read commands. The criteria is derived from the relevant media standard, with additional vendor specific criteria allowed. Automatic reallocation *shall* be controlled by the ARRE bit (see 17.11.3.1, "Read-Write Error Recovery mode page" on page 673). The VERIFY (10) command may return an error for a sector that a Read command may not.

Verify Error Recovery Page parameters are not supported.

The byte check (BytChk) bit is not used and *shall* be set to zero, which causes a medium verification to be performed with no data comparison.

A blank verify (BlkVfy) bit of one causes a verification that the blocks are blank.

The Disable Page Out (DPO) bit is not used and *shall* be set to zero. A DPO bit of zero indicates the priority *shall* be determined by the retention priority fields in the cache page if supported. All other aspects of the algorithm implementing the cache memory replacement strategy are vendor specific.

The Logical Block Address field specifies the logical block where the verify operation *shall* begin.

The Verification Length specifies the number of contiguous logical blocks of data or blanks that *shall* be verified. A Verification Length of zero indicates that no logical blocks *shall* be verified. This condition *shall not* be considered as an error. Any other value indicates the number of logical blocks that *shall* be verified.

If the G3tout bit is set to 1 and if the logical unit supports Group3 timeout and if Restricted Overwrite Feature or Rigid Restricted Overwrite Feature (e.g., CD-RW, DVD-RW) is current and if G3Enable bit in Timeout and Protect mode page is set to 1, the logical unit *shall* terminate this command within Group 3 timeout duration. In other cases, this command is categorized as Group 2 timeout.

Table 824 - VERIFY (10) command errors

Error Description
<i>A-1.1, "Deferred Error Reporting" on page 919</i>
<i>Table 835 - Basic Error Codes on page 932</i>
<i>Table 836 - Media Access Error Codes on page 935</i>

17.48 WRITE (10) command

The WRITE (10) command requests that the logical unit write the data transferred from the host to the medium.

If used with the Incremental Streaming Write Feature, the WRITE (10) command *shall* use the Write Parameters mode page to determine its operating behavior.

If Enhanced Defect Reporting Feature (0029h) is current, the logical unit *shall* follow the setting of the PER bit and the EMCDDR field in Read-Write Error Recovery mode page. See 10.0, "Logical unit assisted software defect management model" on page 477.

Table 825 - WRITE (10) Command Descriptor Block

Bit Byte	7	6	5	4	3	2	1	0
0	Operation Code (2Ah)							
1	Restricted (See SBC-2)		DPO	FUA	TSR ^a	Restricted (See SBC-2)	Obsolete	
2	Logical Block Address (MSB) (LSB)							
3								
4								
5								
6								
7	Transfer Length (MSB) (LSB)							
8								
9	Vendor-Specific	Reserved			NACA	Flag	Link	
10	PAD							
11								

a. In the previous version of this document, this bit was defined as EBP bit. The EBP bit was obsolete and marked as reserved in SBC-2.

The TSR (Timely and Safe Recording) bit is not specified in this document. See MMC.

The Disable Page Out (DPO) bit is not used by Multi-Media logical units and *shall* be set to zero. A DPO bit of zero indicates the priority *shall* be determined by the retention priority fields in the cache page if supported. All other aspects of the algorithm implementing the cache memory replacement strategy are vendor specific.

A Force Unit Access (FUA) bit of one indicates that the Multi-Media logical unit *shall* access the media in performing the command. Write commands *shall* access the specified logical blocks on the media. In the case where the cache contains a more recent version of a logical block than the media, the logical block *shall* first be written to the media. A FUA bit of zero indicates that the Multi-Media logical unit may satisfy the command by writing to the cache memory.

The Transfer Length specifies the number of contiguous logical blocks of data that *shall* be transferred. A Transfer Length of zero indicates that no data *shall* be transferred. This condition *shall not* be considered an error and no data *shall* be written. Any other value indicates the number of logical blocks that *shall* be transferred.

The Logical Block Address field specifies the logical block where the write operation *shall* begin. For CD-R or DVD-R or HD DVD-R, and FUA=0 with incremental writing, and if the LBA is equal to the NWA in the same RZone as a previous write, then writing should continue without interruption of streaming. If the LBA is equal to the NWA in another Track/RZone, a SYNCHRONIZE CACHE (10) may be performed before executing the write command. If the LBA is not any NWA, the logical unit *shall* return CHECK CONDITION status, 5/21/02 INVALID ADDRESS FOR WRITE.

For CD, LBA in the range of -45150 (FFFF4FA2h) to -1 (FFFFFFFh) **shall** be encoded as a two's complement negative number. Values in the range 0 through ffff4fa1h **shall** be considered positive values. Values -45150 through 404849 are valid for CD media. Table 826 shows the MSF to LBA mapping.

Table 826 - LBA to MSF translation (CD)

Condition	Formulae
$-150 \leq LBA \leq 404849$	$M = IP((LBA + 150) / (60 \cdot 75))$ $S = IP((LBA + 150 - (M \cdot 60 \cdot 75)) / 75)$ $F = IP(LBA + 150 - (M \cdot 60 \cdot 75) - (S \cdot 75))$
$-45150 \leq LBA \leq -151$	$M = IP((LBA + 450150) / (60 \cdot 75))$ $S = IP((LBA + 450150 - (M \cdot 60 \cdot 75)) / 75)$ $F = IP(LBA + 450150 - (M \cdot 60 \cdot 75) - (S \cdot 75))$
$00/00/00 \leq MSF \leq 89/59/74$	$LBA = (M \cdot 60 + S) \cdot 75 + F - 150$
$90/00/00 \leq MSF \leq 99/59/74$	$LBA = (M \cdot 60 + S) \cdot 75 + F - 450150$

For CD-R or DVD-R, once actual writing to the media has started, the data stream **shall** be uninterrupted until the recording is done. Interruptions of data are called “underruns.” The underrun condition may also be forced with the SYNCHRONIZE CACHE (10) command. The CD-R or DVD-R logical unit **shall** behave as follows in an underrun condition.

1) Disc-at-Once: (DVD)

The logical unit **shall** generate and write a Lead-out (the Lead-in was generated and written before any data). The logical unit **shall** update the RMA.

2) Session at Once mode: (CD)

The logical unit **shall** generate and write a Lead-out (the Lead-in was generated and written before any data). The logical unit **shall** update the PMA to match the data actually recorded.

3) Track at Once mode: (CD)

The logical unit **shall** pad the track with all 00h main data if reserved or not minimum length and update the PMA.

4-1) Incremental mode: (DVD)

The logical unit **shall** perform linking.

4-2) Variable Packet: (CD)

If insufficient space exists for another variable packet within a reserved track, the logical unit **shall** pad the packet with all 00h data such that it fills the track. Otherwise, the logical unit **shall** write run-out and link blocks.

4-3) Fixed Packet: (CD)

The logical unit **shall** pad the packet with all 00h main data to the fixed packet size.

5) Raw mode: (CD)

The logical unit **shall** write run-out and link blocks. The logical unit **shall** read the TOC and track information from the session just written and update the PMA. It is assumed that the initiator has written the Lead-out.

6) Layer Jump recording mode: (DVD)

The logical unit **shall** perform linking.

Note: In Raw mode, it is possible for the host to send a TOC that is not valid, thus making a disc that cannot be read.

*Note: “Update the RMA/PMA” means to update the RMA/PMA on the disc or to update the RMA/PMA Cache, which **shall** be written to the RMA/PMA on the disc prior to removing the disc from the logical unit. PMA Caching is vendor specific.*

For HD DVD, when the number of the remaining ECC blocks in Current RMZ is less than or equal to 8, the logical unit **shall not** write RMD on the disc. The Error reporting for the command in each condition of the media is shown in Table 189 - *Error reporting for WRITE (10) command and WRITE (12) command* on page 360.

For CD, if the block number specified by the LBA field is already written on CD-R media, the logical unit **shall** return CHECK CONDITION status, 5/21/02 INVALID ADDRESS FOR WRITE. This error will indicate that an underrun may have occurred, as the run-out and link blocks occupy logical addresses. On CD-RW media, the LBA **shall** specify an address that is an appendable point (according to CD-R rules) or is the first user data block of an existing packet or track.

For DVD-RAM Ver. 2.2 and HD DVD-RAM, the logical unit **shall** set all Recording Type bits to zero, which are in the Data ID fields of all sectors within the ECC block to be written.

While writing is occurring, the logical unit may not be able to process all SCSI/ATAPI commands. The following is a list of commands that **shall** function during writing without causing a flush cache.

1. TEST UNIT READY
2. REQUEST SENSE
3. INQUIRY
4. READ TRACK INFORMATION (for current track). If the LBA or track number specified is not within the current track, the logical unit may return CHECK CONDITION status, 5/24/00 INVALID FIELD IN CDB.
5. READ BUFFER CAPACITY
6. GET CONFIGURATION
7. GET EVENT/STATUS NOTIFICATION

If Random Writable Feature (0020h) or Write Once Feature (0025h) is current, all other commands **shall** perform normally, but may force a SYNCHRONIZE CACHE (10) before executing. The process of writing from the logical unit's cache to the medium **shall not** cause a NOT READY condition for any command.

In general, while writing is occurring, if WRITE (10) command or WRITE (12) command cannot be terminated immediately (e.g., insufficient buffer capacity), the logical unit may terminate the WRITE command with CHECK CONDITION status, 2/04/07 LOGICAL UNIT NOT READY, OPERATION IN PROGRESS or 2/04/08 LOGICAL UNIT NOT READY, LONG WRITE IN PROGRESS and the host **shall** issue the same WRITE command again. After logical unit becomes ready due to sufficient buffer capacity for the WRITE command, the WRITE command **shall** be performed normally.

If one of the following listed Features is current, commands that are allowed to report NOT READY error (See Table 299 - *NOT READY error and Timeout UNIT ATTENTION reporting (by command)* on page 508) may be terminated with CHECK CONDITION status, 2/04/08 LOGICAL UNIT NOT READY, LONG WRITE IN PROGRESS.

- Incremental Streaming Writable Feature (0021h)
- CD Track at Once Feature (002Dh)
- CD Mastering Feature (002Eh)
- DVD-R/-RW Write Feature (002Fh)
- Restricted Overwrite Feature (0026h)
- Rigid Restricted Overwrite Feature (002Ch)

When Restricted Overwrite method is currently performed (Restricted Overwrite Feature (0026h) or Rigid Restricted Overwrite Feature (002Ch)), READ (10) command or READ (12) command **shall** be performed normally after data in buffer is written on the disc.

In case of DRT-DM mode, when Enhanced Defect Reporting Feature (0029h) is current and when the EMCDR field is set to 2 or 3, and if a Type 1, Type 2, or Type 3 defect level is found in DBI memory for any of the blocks being written, the logical unit **shall** terminate the command with CHECK CONDITION status, 1/18/05 RECOVERED DATA -

RECOMMEND REASSIGNMENT at the completion of the command. Data in buffer *shall* be written on the medium normally.

When Rigid Restricted Overwrite Feature and/or LJ Rigid Restricted Overwrite Feature is current, the Logical Block Address field and the Transfer Length field *shall* be integer multiple of Blocking size. If the Logical Block Address field value does not meet this condition, the command *shall* be terminated with CHECK CONDITION status, 5/21/02 INVALID ADDRESS FOR WRITE. If the Transfer Length field value does not meet this condition, the command *shall* be terminated with CHECK CONDITION status, 5/24/00 INVALID FIELD IN CDB.

Table 827 describes errors that may occur during the operation of the command or which may cause a CHECK CONDITION status to be reported.

Table 827 - WRITE (10) command errors

Error Description
<i>A-1.1, "Deferred Error Reporting" on page 919</i>
<i>Table 835 - Basic Error Codes on page 932</i>
<i>Table 836 - Media Access Error Codes on page 935</i>
<i>Table 837 - Write Error Codes on page 938</i>

17.49 WRITE (12) command

The WRITE (12) command requests that the logical unit write the data transferred from the host to the medium.

This command is mandatory to support the Real-Time Streaming Feature with SW bit is set to one.

If Enhanced Defect Reporting Feature (0029h) is current, the logical unit *shall* follow the setting of the PER bit and the EMCDR field in Read-Write Error Recovery mode page. See 10.0, "Logical unit assisted software defect management model" on page 477.

Table 828 - WRITE (12) Command Descriptor Block

Bit Byte	7	6	5	4	3	2	1	0																								
0	Operation Code (AAh)																															
1	Restricted (See SBC-2)		DPO	FUA	TSR	Restricted (See SBC-2)	Obsolete																									
2	Logical Block Address																															
3									(MSB)																							
4																	(LSB)															
5																																
6																																
7	Transfer Length																															
8																																
9																	(LSB)															
10																									Streaming	VNR	Reserved	Restricted (See SBC-2)				
11																									Vendor-Specific		Reserved		NACA	Flag	Link	

The **Streaming** bit of one specifies that the Stream recording operation *shall* be used for the command (see 9.0, "Real-Time Stream recording/playback model" on page 471). The **Streaming** bit of zero specifies that the conventional write operation *shall* be used for the command. If the **Streaming** bit is set to one, the cache control Mode parameter may be ignored.

If **Streaming** bit is set to 1 and if the logical unit supports Group3 timeout and if G3Enable bit in Timeout and Protect mode page is set to 1, the logical unit *shall* terminate this command within Group 3 timeout duration. If G3Enable bit is set to 0, this command is categorized as Group 1 timeout.

When the **Streaming** bit is set to one, the **FUA** bit *shall* be set to zero. If both the **Streaming** bit and the **FUA** bit are set to one, the logical unit *shall* terminate the command with CHECK CONDITION status, 5/24/00 INVALID FIELD IN CDB.

The **Logical Block Address** field specifies the logical block where the write operation *shall* begin.

When the host issues the command with the **Streaming** bit set to one, the value of the **Logical Block Address** field and the **Transfer Length** field *shall* be the integral multiple of the Blocking factor. The Blocking factor of the media is described in the Feature description of each media, see 17.4.2, "Features" on page 561. If the **Logical Block Address** field and the **Transfer Length** field values are not set to the integral multiple of the Blocking factor, the logical unit *shall* terminate the command with CHECK CONDITION status, 5/24/00 INVALID FIELD IN CDB.

For the DVD-RAM Ver. 2.2 and HD DVD-RAM, the logical unit *shall* set all Recording Type bits to one, which are in the Data ID fields of all sectors within the ECC block to be written, when WRITE (12) command with the **Streaming** bit set to one is issued by the host. And the logical unit *shall* set all the Recording Type bits to zero when WRITE (12) command with the **Streaming** bit set to zero is issued by the host.

When Enhanced Defect Reporting Feature (0029h) is current and the PER bit and/or the EMCDR field is set to 2 or 3 and the **Streaming** bit is set to one, and if the logical unit could not write some data to the medium, the logical unit *shall*

terminate the command with CHECK CONDITION status, 1/18/05 RECOVERED DATA - RECOMMEND REASSIGNMENT at the completion of the command. Type 4 defect *shall* be stored in DBI memory. For other cases, see 17.48, "WRITE (10) command" on page 907.

The VNR (Verify Not Required) bit is defined for media that is not specified in this document. See MMC.

See 17.48, "WRITE (10) command" on page 907 for a description of the other parameters for this command.

See Table 827 - *WRITE (10) command errors* on page 910 for information on the error conditions.

17.50 WRITE AND VERIFY (10) command

The WRITE AND VERIFY (10) command requests that the logical unit write the data transferred from the host to the medium and then verify that the data is correctly written.

If Enhanced Defect Reporting Feature (0029h) is current, the logical unit *shall* follow the setting of the PER bit and the EMCDDR field in Read-Write Error Recovery mode page. See 10.0, "Logical unit assisted software defect management model" on page 477.

Table 829 - WRITE AND VERIFY (10) Command Descriptor Block

Bit Byte	7	6	5	4	3	2	1	0								
0	Operation Code (2Eh)															
1	Restricted (See SBC-2)		DPO (0)		Reserved		BytChk (0)	Obsolete								
2	Logical Block Address															
3									(MSB)							
4																
5																
6									(LSB)							
6	Reserved			Restricted (See SBC-2)												
7	Transfer Length															
8									(MSB)							
9									(LSB)							
9	Vendor-Specific		Reserved			NACA	Flag	Link								
10	PAD															
11																

The verify operation of this command *shall* use stricter criteria for data recoverability than Read commands. The criteria is derived from the appropriate media standard, with additional vendor specific criteria allowed. Automatic reallocation *shall* be controlled by the ARRE bit (see 17.11.3.1, "Read-Write Error Recovery mode page" on page 673). The VERIFY command may return an error for a sector that a READ command may not.

The byte check (BytChk) bit is not used and *shall* be set to zero, which causes a medium verification to be performed with no data comparison.

The Disable Page Out (DPO) bit is not used by Multi-Media logical units and *shall* be set to zero. A DPO bit of zero indicates the priority *shall* be determined by the retention priority fields in the cache page if supported. All other aspects of the algorithm implementing the cache memory replacement strategy are vendor specific.

The Transfer Length field specifies the number of contiguous logical blocks of data or blanks that *shall* be written and verified. A Transfer Length of zero indicates that no logical blocks *shall* be verified. This condition *shall not* be considered as an error. Any other value indicates the number of logical blocks that *shall* be verified.

For DVD-RAM Ver. 2.2 and HD DVD-RAM, the logical unit *shall* set the all Recording Type bits to zero, which are in the Data ID fields of all sectors within the ECC block to be written.

Table 830 - WRITE AND VERIFY (10) command errors

Error Description
A-1.1, "Deferred Error Reporting" on page 919
Table 835 - Basic Error Codes on page 932
Table 836 - Media Access Error Codes on page 935
Table 837 - Write Error Codes on page 938

17.51 WRITE BUFFER command

The WRITE BUFFER command is used in conjunction with the READ BUFFER command as a diagnostic function for testing logical unit memory in the target SCSI device and the integrity of the service delivery subsystem. Additional modes are provided for downloading microcode and for downloading and saving microcode.

Table 831 - WRITE BUFFER Command Descriptor Block

Bit Byte	7	6	5	4	3	2	1	0
0	Operation Code (3Bh)							
1	LUN (Obsolete)			Mode				
2	Buffer ID							
3	(MSB)							
4	Buffer offset							
5	(LSB)							
6	(MSB)							
7	Parameter list length							
8	(LSB)							
9	Vendor-Specific		Reserved			NACA	Flag	Link
10	PAD							
11	PAD							

If reservations are active, they *shall* affect the execution of the WRITE BUFFER command as follows. A reservation conflict *shall* occur when a WRITE BUFFER command is received from a host other than the one holding a logical unit or element reservation.

This command *shall not* alter any medium of the logical unit when the data mode or the combined header and data mode is specified.

The function of this command and the meaning of fields within the command descriptor block depend on the contents of the Mode field. The Mode field is defined in Table 832.

Table 832 - WRITE BUFFER Mode field definition

Mode	Description	Implementation requirements
00000b ^a	Write combined header and data	Optional
00001b ^a	Vendor-specific	Vendor-specific
00010b	Write data	Optional
00011b	Reserved	Reserved
00100b	Download microcode	Optional
00101b	Download microcode and save	Optional
00110b ^b	Download microcode with offsets	Optional
00111b ^b	Download microcode with offsets and save	Optional

- a. Implementing this Mode is not recommended.
- b. These are the only Modes recommended when Buffer offsets are used.

Note: In the previous version of this specification, the length of the Mode field was 3-bit.

17.51.1 Combined header and data mode (00000b)

In this mode, data to be transferred is preceded by a four-byte header. The four-byte header consists of all reserved bytes. The Buffer ID and the Buffer offset fields *shall* be zero. The Parameter list length field specifies the maximum number of bytes that *shall* be transferred from the Data-Out Buffer. This number includes four bytes of header, so the data length to be stored in the logical unit's buffer is Parameter list length minus four. The host should attempt to ensure that the Parameter list length is not greater than four plus the buffer capacity (see 17.18.4, on page 712) that is returned in the header of the READ BUFFER command (Mode 00b). If the Parameter list length exceeds the buffer capacity the logical unit *shall* return CHECK CONDITION status, 5/1A/00 PARAMETER LIST LENGTH ERROR.

17.51.2 Vendor-specific mode (00001b)

In this mode, the meaning of the Buffer ID, Buffer offset, and Parameter list length fields are not specified by this specification.

17.51.3 Data mode (00010b)

In this mode, the Data-Out Buffer contains buffer data destined for the logical unit. The Buffer ID field identifies a specific buffer within the logical unit. The vendor assigns Buffer ID codes to buffers within the logical unit. Buffer ID zero *shall* be supported. If more than one buffer is supported, additional Buffer ID codes *shall* be assigned contiguously, beginning with one. If an unsupported Buffer ID code is selected, the logical unit *shall* return CHECK CONDITION status, 5/24/00 INVALID FIELD IN CDB. Data are written to the logical unit buffer starting at the location specified by the Buffer offset. The host should conform to the offset boundary requirements returned in the READ BUFFER descriptor. If the logical unit is unable to accept the specified Buffer offset, it *shall* return CHECK CONDITION status, 5/24/00 INVALID FIELD IN CDB.

The Parameter list length specifies the maximum number of bytes that *shall* be transferred from the Data-Out Buffer to be stored in the specified buffer beginning at the Buffer offset. The host should attempt to ensure that the Parameter list length plus the Buffer offset does not exceed the capacity of the specified buffer. (The capacity of the buffer may be determined by the Buffer Capacity field in the READ BUFFER descriptor.) If the Buffer offset and Parameter list length fields specify a transfer in excess of the buffer capacity, the logical unit *shall* return CHECK CONDITION status, 5/24/00 INVALID FIELD IN CDB.

17.51.4 Download microcode mode (00100b)

If the logical unit cannot accept this command because of some device condition, the logical unit *shall* terminate each WRITE BUFFER command with this mode (100b) with CHECK CONDITION status, 5/2C/00 COMMAND SEQUENCE ERROR.

In this mode, vendor-specific microcode or control information *shall* be transferred to the control memory space of the logical unit. After a power-cycle or reset, the device operation *shall* revert to a vendor-specific condition. The meanings of the Buffer ID, Buffer offset, and Parameter list length fields are not specified by this specification and are not required to be zero-filled. When the microcode download has completed successfully the logical unit *shall* generate a UNIT ATTENTION condition for all hosts except the one that issued the WRITE BUFFER command. The additional sense code *shall* be set to MICROCODE HAS BEEN CHANGED.

17.51.5 Download microcode and save mode (00101b)

If the logical unit cannot accept this command because of some device condition, the logical unit *shall* terminate each WRITE BUFFER command with this mode (101b) with CHECK CONDITION status, 5/2C/00 COMMAND SEQUENCE ERROR.

In this mode, vendor-specific microcode or control information *shall* be transferred to the logical unit and, if the WRITE BUFFER command is completed successfully, also *shall* be saved in a non-volatile memory space (semiconductor, disk, or other). The downloaded code *shall* then be effective after each power-cycle and reset until it is supplanted in another download microcode and save operation. The meanings of the Buffer ID, Buffer offset, and Parameter list length fields are not specified by this specification and are not required to be zero-filled. When the download microcode and save command has completed successfully the logical unit *shall* generate a UNIT ATTENTION condition for all hosts

except the one that issued the WRITE BUFFER command. When reporting the UNIT ATTENTION condition, the logical unit *shall* set the additional sense code to MICROCODE HAS BEEN CHANGED.

17.51.6 Download microcode with offsets (00110b)

In this mode, the host may split the transfer of the vendor-specific microcode or control information over two or more WRITE BUFFER commands. If the logical unit cannot accept this command because of some device condition, the logical unit *shall* terminate each WRITE BUFFER command with this mode (00110b) with CHECK CONDITION status, 5/2C/00 COMMAND SEQUENCE ERROR.

If the last WRITE BUFFER command of a set of one or more commands completes successfully, the microcode or control information *shall* be transferred to the control memory space of the logical unit. After a power-cycle or reset, the device *shall* revert to a vendor-specific condition. In this mode, the Data-Out Buffer contains vendor-specific, self-describing microcode or control information.

Since the downloaded microcode or control information may be sent using several commands, when the logical unit detects the last download microcode with offsets and save mode WRITE BUFFER command has been received, the logical unit *shall* perform any logical unit required verification of the complete set of downloaded microcode or control information prior to returning GOOD status for the last command. After the last command completes successfully the logical unit *shall* generate a UNIT ATTENTION condition for all hosts except the one that issued the set of WRITE BUFFER commands. When reporting the UNIT ATTENTION condition, the logical unit *shall* set the additional sense code to MICROCODE HAS BEEN CHANGED.

If the complete set of WRITE BUFFER commands required to effect a microcode or control information change (one or more commands) are not received before a reset or power-on cycle occurs, the change *shall not* be effective and the new microcode or control information *shall* be discarded.

The Buffer ID field identifies a specific buffer within the logical unit. The vendor assigns Buffer ID codes to buffers within the logical unit. A Buffer ID value of zero *shall* be supported. If more than one buffer is supported, additional Buffer ID codes *shall* be assigned contiguously, beginning with one. If an unsupported Buffer ID code is identified, the logical unit *shall* return CHECK CONDITION status, 5/24/00 INVALID FIELD IN CDB.

The microcode or control information are written to the logical unit buffer starting at the location specified by the Buffer offset. The host *shall* send commands that conform to the offset boundary requirements (see 17.18.4, on page 712). If the logical unit is unable to accept the specified Buffer offset, it *shall* return CHECK CONDITION status, 5/24/00 INVALID FIELD IN CDB.

The Parameter list length specifies the maximum number of bytes that *shall* be present in the Data-Out Buffer to be stored in the specified buffer beginning at the Buffer offset. The host should attempt to ensure that the Parameter list length plus the Buffer offset does not exceed the capacity of the specified buffer. (The capacity of the buffer may be determined by the Buffer Capacity field in the READ BUFFER descriptor.) If the Buffer offset and Parameter list length fields specify a transfer in excess of the buffer capacity, the logical unit *shall* return CHECK CONDITION status, 5/24/00 INVALID FIELD IN CDB.

17.51.7 Download microcode with offsets and save mode (00111b)

In this mode, the host may split the transfer of the vendor-specific microcode or control information over two or more WRITE BUFFER commands. If the logical unit cannot accept this command because of some device condition, the logical unit *shall* terminate each mode 111b WRITE BUFFER command with CHECK CONDITION status, 5/2C/00 COMMAND SEQUENCE ERROR.

If the last WRITE BUFFER command of a set of one or more commands completes successfully, the microcode or control information *shall* be saved in a non-volatile memory space (semiconductor, disk, or other). The saved downloaded microcode or control information *shall* then be effective after each power-cycle and reset until it is supplanted by another download microcode with save operation or download microcode with offsets and save operation. In this mode, the Data-Out Buffer contains vendor-specific, self-describing microcode or control information.

Since the downloaded microcode or control information may be sent using several commands, when the logical unit detects the last download microcode with offsets and save mode WRITE BUFFER command has been received, the

logical unit *shall* perform any logical unit required verification of the complete set of downloaded microcode or control information prior to returning GOOD status for the last command. After the last command completes successfully the logical unit *shall* generate a UNIT ATTENTION condition for all hosts except the one that issued the set of WRITE BUFFER commands. When reporting the UNIT ATTENTION condition, the logical unit *shall* set the additional sense code to MICROCODE HAS BEEN CHANGED.

If the complete set of WRITE BUFFER commands required to effect a microcode or control information change (one or more commands) are not received before a reset or power-on cycle occurs, the change *shall not* be effective and the new microcode or control information *shall* be discarded. The Buffer ID field identifies a specific buffer within the logical unit. The vendor assigns Buffer ID codes to buffers within the logical unit. A Buffer ID value of zero *shall* be supported. If more than one buffer is supported, additional Buffer ID codes *shall* be assigned contiguously, beginning with one. If an unsupported Buffer ID code is identified, the logical unit *shall* return CHECK CONDITION status, 5/24/00 INVALID FIELD IN CDB.

The microcode or control information are written to the logical unit buffer starting at the location specified by the Buffer offset. The host *shall* conform to the offset boundary requirements. If the logical unit is unable to accept the specified Buffer offset, it *shall* return CHECK CONDITION status, 5/24/00 INVALID FIELD IN CDB.

The Parameter list length specifies the maximum number of bytes that *shall* be present in the Data-Out Buffer to be stored in the specified buffer beginning at the Buffer offset. The host should attempt to ensure that the Parameter list length plus the Buffer offset does not exceed the capacity of the specified buffer. (The capacity of the buffer may be determined by the Buffer Capacity field in the READ BUFFER descriptor.) If the Buffer offset and Parameter list length fields specify a transfer in excess of the buffer capacity, the logical unit *shall* return CHECK CONDITION status, 5/24/00 INVALID FIELD IN CDB.

Table 833 describes errors that may occur during the operation of the command or which may cause a CHECK CONDITION status to be reported.

Table 833 - WRITE BUFFER command errors

Error Description
<i>A-1.1, "Deferred Error Reporting" on page 919</i>
<i>Table 835 - Basic Error Codes on page 932</i>

Appendix A - Error Reporting and Sense Codes (Normative)

A-1 Error Reporting

This annex lists error codes that may be generated by logical units. Specific commands specify that certain errors occur in response to certain conditions, but each command does not contain a comprehensive list of possible error conditions. Although a particular command lists a set of errors, some of those errors may be typically reported to a subsequent command due to deferred error reporting.

A-1.1 Deferred Error Reporting

Any error may be reported in response to any command due to the occurrence of a deferred error. For example, a write error may occur due to data cached from a WRITE (10) command and that error *shall* be reported in response to the next command (with some exceptions). Errors listed in Table 835 are not caused by any specific commands but by actions outside the control of the Initiator.

A-1.2 Error Tables

Table 834 lists all errors that may be generated by logical units. Not all errors are applicable to all devices.

Table 835 lists errors that may occur at any time, typically in response to a protocol or hardware error or user intervention.

Table 836 lists errors that may occur when accessing the medium. The access may be implicit or explicit, and may be a read or write.

Table 837 lists errors that may occur when writing to the medium. The write may be to the user Data Area or to a control area on the medium.

Table 838 lists errors that may occur when operating on Sessions or Borders.

Table 839 lists errors that may occur when performing a key exchange operation.

Table 834 - All Error Codes (Sheet 1 of 13)

Sense Key	ASC	ASCQ	Description	Type
8	00	00	BLANK CHECK	Write Once, Incremental Streaming Write
0	00	00	NO ADDITIONAL SENSE INFORMATION	General
0	00	01	FILEMARK DETECTED	N/A
0	00	02	END-OF-PARTITION/MEDIUM DETECTED	N/A
0	00	03	SETMARK DETECTED	N/A
0	00	04	BEGINNING-OF-PARTITION/MEDIUM DETECTED	N/A
0	00	05	END-OF-DATA DETECTED	N/A
B	00	06	I/O PROCESS TERMINATED, PLAY OPERATION ABORTED	General
0	00	11	AUDIO PLAY OPERATION IN PROGRESS	Audio Play
0	00	12	AUDIO PLAY OPERATION PAUSED	Audio Play
0	00	13	AUDIO PLAY OPERATION SUCCESSFULLY COMPLETED	Audio Play
0	00	14	AUDIO PLAY OPERATION STOPPED DUE TO ERROR	Audio Play
0	00	15	NO CURRENT AUDIO STATUS TO RETURN	Audio Play
0	00	16	OPERATION IN PROGRESS	Sequential Write
4	00	17	CLEANING REQUESTED	Read
-	00	18	ERASE OPERATION IN PROGRESS	N/A
-	00	19	LOCATE OPERATION IN PROGRESS	N/A
-	00	1A	REWIND OPERATION IN PROGRESS	N/A
-	00	1B	SET CAPACITY OPERATION IN PROGRESS	N/A
-	00	1C	VERIFY OPERATION IN PROGRESS	N/A
-	00	1D	ATA PASS THROUGH INFORMATION AVAILABLE	N/A
4	01	00	NO INDEX/SECTOR SIGNAL	Read
3	02	00	NO SEEK COMPLETE	Read
3	03	00	PERIPHERAL DEVICE WRITE FAULT	Random Write
3	03	01	NO WRITE CURRENT	N/A
3	03	02	EXCESSIVE WRITE ERRORS	N/A
2	04	00	LOGICAL UNIT NOT READY, CAUSE NOT REPORTABLE	General
2	04	01	LOGICAL UNIT IS IN PROCESS OF BECOMING READY	Read
2	04	02	LOGICAL UNIT NOT READY, INITIALIZING CMD. REQUIRED	Read
2	04	03	LOGICAL UNIT NOT READY, MANUAL INTERVENTION REQUIRED	General
2	04	04	LOGICAL UNIT NOT READY, FORMAT IN PROGRESS	Random Write
2	04	05	LOGICAL UNIT NOT READY, REBUILD IN PROGRESS	N/A
2	04	06	LOGICAL UNIT NOT READY, RECALCULATION IN PROGRESS	N/A
2	04	07	LOGICAL UNIT NOT READY, OPERATION IN PROGRESS	Read
2	04	08	LOGICAL UNIT NOT READY, LONG WRITE IN PROGRESS	Write
-	04	09	LOGICAL UNIT NOT READY, SELF-TEST IN PROGRESS	
-	04	0A	LOGICAL UNIT NOT ACCESSIBLE, ASYMMETRIC ACCESS STATE TRANSITION	
-	04	0B	LOGICAL UNIT NOT ACCESSIBLE, TARGET PORT IN STANDBY STATE	
-	04	0C	LOGICAL UNIT NOT ACCESSIBLE, TARGET PORT IN UNAVAILABLE STATE	
-	04	10	LOGICAL UNIT NOT READY, AUXILIARY MEMORY NOT ACCESSIBLE	
-	04	11	LOGICAL UNIT NOT READY, NOTIFY (ENABLE SPINUP) REQUIRED	

Table 834 - All Error Codes (Sheet 2 of 13)

Sense Key	ASC	ASCQ	Description	Type
-	04	12	LOGICAL UNIT NOT READY, OFFLINE	
4	05	00	LOGICAL UNIT DOES NOT RESPOND TO SELECTION	General
2	06	00	NO REFERENCE POSITION FOUND (medium may be upside down)	Read
5	07	00	MULTIPLE PERIPHERAL DEVICES SELECTED	N/A
4	08	00	LOGICAL UNIT COMMUNICATION FAILURE	General
4	08	01	LOGICAL UNIT COMMUNICATION TIME-OUT	General
4	08	02	LOGICAL UNIT COMMUNICATION PARITY ERROR	General
4	08	03	LOGICAL UNIT COMMUNICATION CRC ERROR (ULTRA-DMA/32)	General
-	08	04	UNREACHABLE COPY TARGET	
4	09	00	TRACK FOLLOWING ERROR	Read
4	09	01	TRACKING SERVO FAILURE	Read
4	09	02	FOCUS SERVO FAILURE	Read
4	09	03	SPINDLE SERVO FAILURE	Read
4	09	04	HEAD SELECT FAULT	N/A
6	0A	00	ERROR LOG OVERFLOW	General
1	0B	00	WARNING	General
1	0B	01	WARNING - SPECIFIED TEMPERATURE EXCEEDED	General
1	0B	02	WARNING - ENCLOSURE DEGRADED	General
-	0B	03	WARNING - BACKGROUND SELF-TEST FAILED	
-	0B	04	WARNING - BACKGROUND PRE-SCAN FAILED	
-	0B	05	WARNING - BACKGROUND MEDIUM SCAN FAILED	
3	0C	00	WRITE ERROR	Write
3	0C	01	WRITE ERROR - RECOVERED WITH AUTO REALLOCATION	N/A
3	0C	02	WRITE ERROR - AUTO REALLOCATION FAILED	Random Write
3	0C	03	WRITE ERROR - RECOMMEND REASSIGNMENT	Random Write
3	0C	04	COMPRESSION CHECK MISCOMPARE ERROR	N/A
3	0C	05	DATA EXPANSION OCCURRED DURING COMPRESSION	N/A
3	0C	06	BLOCK NOT COMPRESSIBLE	N/A
3	0C	07	WRITE ERROR - RECOVERY NEEDED	Write
3	0C	08	WRITE ERROR - RECOVERY FAILED	Write
3	0C	09	WRITE ERROR - LOSS OF STREAMING	Sequential Write
1	0C	0A	WRITE ERROR - PADDING BLOCKS ADDED	Sequential Write
-	0C	0B	AUXILIARY MEMORY WRITE ERROR	
-	0C	0C	WRITE ERROR - UNEXPECTED UNSOLICITED DATA	
-	0C	0D	WRITE ERROR - NOT ENOUGH UNSOLICITED DATA	
-	0D	00	Reserved	
-	0D	01	THIRD PARTY DEVICE FAILURE	
-	0D	02	COPY TARGET DEVICE NOT REACHABLE	
-	0D	03	INCORRECT COPY TARGET DEVICE TYPE	
-	0D	04	COPY TARGET DEVICE DATA UNDERRUN	
-	0D	05	COPY TARGET DEVICE DATA OVERRUN	
-	0E	00	Reserved	
-	0E	01	INFORMATION UNIT TOO SHORT	
-	0E	02	INFORMATION UNIT TOO LONG	
-	0E	03	INVALID FIELD IN COMMAND INFORMATION UNIT	
-	0F	00	Reserved	

Table 834 - All Error Codes (Sheet 3 of 13)

Sense Key	ASC	ASCQ	Description	Type
3	10	00	ID CRC OR ECC ERROR	Read
-	10	01	DATA BLOCK GUARD CHECK FAILED	
-	10	02	DATA BLOCK APPLICATION TAG CHECK FAILED	
-	10	03	DATA BLOCK REFERENCE TAG CHECK FAILED	
3	11	00	UNRECOVERED READ ERROR	Read
3	11	01	READ RETRIES EXHAUSTED	Read
3	11	02	ERROR TOO LONG TO CORRECT	Read
3	11	03	MULTIPLE READ ERRORS	N/A
3	11	04	UNRECOVERED READ ERROR - AUTO REALLOCATE FAILED	N/A
3	11	05	L-EC UNCORRECTABLE ERROR	Read
3	11	06	CIRC UNRECOVERED ERROR	CD Read
3	11	07	DATA RE-SYNCHRONIZATION ERROR	N/A
3	11	08	INCOMPLETE BLOCK READ	N/A
3	11	09	NO GAP FOUND	N/A
3	11	0A	MISCORRECTED ERROR	N/A
3	11	0B	UNRECOVERED READ ERROR - RECOMMEND REASSIGNMENT	N/A
3	11	0C	UNRECOVERED READ ERROR - RECOMMEND REWRITE THE DATA	N/A
3	11	0D	DE-COMPRESSION CRC ERROR	N/A
3	11	0E	CANNOT DECOMPRESS USING DECLARED ALGORITHM	N/A
3	11	0F	ERROR READING UPC/EAN NUMBER	CD Read
3	11	10	ERROR READING ISRC NUMBER	CD Read
B	11	11	READ ERROR - LOSS OF STREAMING	Read
-	11	12	AUXILIARY MEMORY READ ERROR	
-	11	13	READ ERROR - FAILED RETRANSMISSION REQUEST	
3	12	00	ADDRESS MARK NOT FOUND FOR ID FIELD	Read
3	13	00	ADDRESS MARK NOT FOUND FOR DATA FIELD	Read
-	14	00	RECORDED ENTITY NOT FOUND	-
3	14	01	RECORD NOT FOUND	Read
3	14	02	FILEMARK OR SETMARK NOT FOUND	N/A
3	14	03	END-OF-DATA NOT FOUND	N/A
3	14	04	BLOCK SEQUENCE ERROR	N/A
3	14	05	RECORD NOT FOUND - RECOMMEND REASSIGNMENT	Read
3	14	06	RECORD NOT FOUND - DATA AUTO-REALLOCATED	Read
-	14	07	LOCATE OPERATION FAILURE	N/A
3	15	00	RANDOM POSITIONING ERROR	Read
3	15	01	MECHANICAL POSITIONING ERROR	Read
3	15	02	POSITIONING ERROR DETECTED BY READ OF MEDIUM	Read
3	16	00	DATA SYNCHRONIZATION MARK ERROR	Random Write
3	16	01	DATA SYNC ERROR - DATA REWRITTEN	Random Write
3	16	02	DATA SYNC ERROR - RECOMMEND REWRITE	Random Write
3	16	03	DATA SYNC ERROR - DATA AUTO-REALLOCATED	Random Write
3	16	04	DATA SYNC ERROR - RECOMMEND REASSIGNMENT	Random Write
1	17	00	RECOVERED DATA WITH NO ERROR CORRECTION APPLIED	Read
1	17	01	RECOVERED DATA WITH RETRIES	Read
1	17	02	RECOVERED DATA WITH POSITIVE HEAD OFFSET	Read
1	17	03	RECOVERED DATA WITH NEGATIVE HEAD OFFSET	Read

Table 834 - All Error Codes (Sheet 4 of 13)

Sense Key	ASC	ASCQ	Description	Type
1	17	04	RECOVERED DATA WITH RETRIES AND/OR CIRC APPLIED	Read
1	17	05	RECOVERED DATA USING PREVIOUS SECTOR ID	Read
1	17	06	RECOVERED DATA WITHOUT ECC - DATA AUTO-REALLOCATED	Random Write
1	17	07	RECOVERED DATA WITHOUT ECC - RECOMMEND REASSIGNMENT	Random Write
1	17	08	RECOVERED DATA WITHOUT ECC - RECOMMEND REWRITE	Random Write
1	17	09	RECOVERED DATA WITHOUT ECC - DATA REWRITTEN	Random Write
1	18	00	RECOVERED DATA WITH ERROR CORRECTION APPLIED	Read
1	18	01	RECOVERED DATA WITH ERROR CORR. & RETRIES APPLIED	Read
1	18	02	RECOVERED DATA - DATA AUTO-REALLOCATED	Random Write
1	18	03	RECOVERED DATA WITH CIRC	CD Read
1	18	04	RECOVERED DATA WITH L-EC	Read
1	18	05	RECOVERED DATA - RECOMMEND REASSIGNMENT	Random Write
1	18	06	RECOVERED DATA - RECOMMEND REWRITE	Random Write
1	18	07	RECOVERED DATA WITH ECC - DATA REWRITTEN	Random Write
1	18	08	RECOVERED DATA WITH LINKING	N/A
3	19	00	DEFECT LIST ERROR	Random Write
3	19	01	DEFECT LIST NOT AVAILABLE	Random Write
3	19	02	DEFECT LIST ERROR IN PRIMARY LIST	Random Write
3	19	03	DEFECT LIST ERROR IN GROWN LIST	Random Write
5	1A	00	PARAMETER LIST LENGTH ERROR	General
4	1B	00	SYNCHRONOUS DATA TRANSFER ERROR	General
4	1C	00	DEFECT LIST NOT FOUND	Random Write
4	1C	01	PRIMARY DEFECT LIST NOT FOUND	Random Write
4	1C	02	GROWN DEFECT LIST NOT FOUND	Random Write
E	1D	00	MISCOMPARE DURING VERIFY OPERATION	Write
1	1E	00	RECOVERED ID WITH ECC CORRECTION	Read
3	1F	00	PARTIAL DEFECT LIST TRANSFER	N/A
5	20	00	INVALID COMMAND OPERATION CODE	General
-	20	01	ACCESS DENIED - INITIATOR PENDING-ENROLLED	
-	20	02	ACCESS DENIED - NO ACCESS RIGHTS	
-	20	03	ACCESS DENIED - INVALID MGMT ID KEY	
-	20	04	ILLEGAL COMMAND WHILE IN WRITE CAPABLE STATE	N/A
-	20	05	Obsolete	N/A
-	20	06	ILLEGAL COMMAND WHILE IN EXPLICIT ADDRESS MODE	N/A
-	20	07	ILLEGAL COMMAND WHILE IN IMPLICIT ADDRESS MODE	N/A
-	20	08	ACCESS DENIED - ENROLLMENT CONFLICT	
-	20	09	ACCESS DENIED - INVALID LU IDENTIFIER	
-	20	0A	ACCESS DENIED - INVALID PROXY TOKEN	
-	20	0B	ACCESS DENIED - ACL LUN CONFLICT	
5	21	00	LOGICAL BLOCK ADDRESS OUT OF RANGE	Read
5	21	01	INVALID ELEMENT ADDRESS	N/A
5	21	02	INVALID ADDRESS FOR WRITE	Incremental Streaming Write
5	21	03	INVALID WRITE CROSSING LAYER JUMP	Layer Jump
5	22	00	ILLEGAL FUNCTION (USE 20 00, 24 00, OR 26 00)	N/A
-	23	00	Reserved	

Table 834 - All Error Codes (Sheet 5 of 13)

Sense Key	ASC	ASCQ	Description	Type
5	24	00	INVALID FIELD IN CDB	General
-	24	01	CDB DECRYPTION ERROR	
-	24	02	Obsolete	N/A
-	24	03	Obsolete	N/A
-	24	04	SECURITY AUDIT VALUE FROZEN	N/A
-	24	05	SECURITY WORKING KEY FROZEN	N/A
-	24	06	NONCE NOT UNIQUE	N/A
-	24	07	NONCE TIMESTAMP OUT OF RANGE	N/A
5	25	00	LOGICAL UNIT NOT SUPPORTED	General
5	26	00	INVALID FIELD IN PARAMETER LIST	General
5	26	01	PARAMETER NOT SUPPORTED	General
5	26	02	PARAMETER VALUE INVALID	General
5	26	03	THRESHOLD PARAMETERS NOT SUPPORTED	General
5	26	04	INVALID RELEASE OF ACTIVE PERSISTENT RESERVATION	General
-	26	05	DATA DECRYPTION ERROR	
-	26	06	TOO MANY TARGET DESCRIPTORS	
-	26	07	UNSUPPORTED TARGET DESCRIPTOR TYPE CODE	
-	26	08	TOO MANY SEGMENT DESCRIPTORS	
-	26	09	UNSUPPORTED SEGMENT DESCRIPTOR TYPE CODE	
-	26	0A	UNEXPECTED INEXACT SEGMENT	
-	26	0B	INLINE DATA LENGTH EXCEEDED	
-	26	0C	INVALID OPERATION FOR COPY SOURCE OR DESTINATION	
-	26	0D	COPY SEGMENT GRANULARITY VIOLATION	
-	26	0E	INVALID PARAMETER WHILE PORT IS ENABLED	
-	26	0F	INVALID DATA-OUT BUFFER INTEGRITY CHECK VALUE	N/A
7	27	00	WRITE PROTECTED	Write
7	27	01	HARDWARE WRITE PROTECTED	Write
7	27	02	LOGICAL UNIT SOFTWARE WRITE PROTECTED	Write
7	27	03	ASSOCIATED WRITE PROTECT	Write
7	27	04	PERSISTENT WRITE PROTECT	Write
7	27	05	PERMANENT WRITE PROTECT	Write
7	27	06	CONDITIONAL WRITE PROTECT	Write
6	28	00	NOT READY TO READY CHANGE, MEDIUM MAY HAVE CHANGED	General
6	28	01	IMPORT OR EXPORT ELEMENT ACCESSED	N/A
6	28	02	NOT READY TO READY CHANGE, FORMAT-LAYER MAY HAVE CHANGED	General
6	29	00	POWER ON, RESET, OR BUS DEVICE RESET OCCURRED	General
6	29	01	POWER ON OCCURRED	General
6	29	02	SCSI BUS RESET OCCURRED	General
6	29	03	BUS DEVICE RESET FUNCTION OCCURRED	General
6	29	04	DEVICE INTERNAL RESET	General
-	29	05	TRANSCEIVER MODE CHANGED TO SINGLE-ENDED	
-	29	06	TRANSCEIVER MODE CHANGED TO LVD	
-	29	07	I_T NEXUS LOSS OCCURRED	
6	2A	00	PARAMETERS CHANGED	General
6	2A	01	MODE PARAMETERS CHANGED	General
6	2A	02	LOG PARAMETERS CHANGED	General

Table 834 - All Error Codes (Sheet 6 of 13)

Sense Key	ASC	ASCQ	Description	Type
6	2A	03	RESERVATIONS PREEMPTED	General
-	2A	04	RESERVATIONS RELEASED	
-	2A	05	REGISTRATIONS PREEMPTED	
-	2A	06	ASYMMETRIC ACCESS STATE CHANGED	
-	2A	07	IMPLICIT ASYMMETRIC ACCESS STATE TRANSITION FAILED	
-	2A	08	PRIORITY CHANGED	
-	2A	09	CAPACITY DATA HAS CHANGED	
-	2A	10	TIMESTAMP CHANGED	
5	2B	00	COPY CANNOT EXECUTE SINCE HOST CANNOT DISCONNECT	General
5	2C	00	COMMAND SEQUENCE ERROR	General
5	2C	01	TOO MANY WINDOWS SPECIFIED	N/A
5	2C	02	INVALID COMBINATION OF WINDOWS SPECIFIED	N/A
5	2C	03	CURRENT PROGRAM AREA IS NOT EMPTY	CD Write
5	2C	04	CURRENT PROGRAM AREA IS EMPTY	CD Write
5	2C	05	PERSISTENT PREVENT CONFLICT	Morphing
-	2C	06	PERSISTENT PREVENT CONFLICT	
-	2C	07	PREVIOUS BUSY STATUS	
-	2C	08	PREVIOUS TASK SET FULL STATUS	
-	2C	09	PREVIOUS RESERVATION CONFLICT STATUS	
-	2C	0A	PARTITION OR COLLECTION CONTAINS USER OBJECTS	
-	2C	0B	NOT RESERVED	
3	2D	00	OVERWRITE ERROR ON UPDATE IN PLACE	N/A
6	2E	00	INSUFFICIENT TIME FOR OPERATION	Timeout
6	2F	00	COMMANDS CLEARED BY ANOTHER INITIATOR	General
2	30	00	INCOMPATIBLE MEDIUM INSTALLED	Read
2	30	01	CANNOT READ MEDIUM - UNKNOWN FORMAT	Read
2	30	02	CANNOT READ MEDIUM - INCOMPATIBLE FORMAT	Read
5	30	02	CANNOT READ MEDIUM - INCOMPATIBLE FORMAT	Read
2	30	03	CLEANING CARTRIDGE INSTALLED	Read
5	30	04	CANNOT WRITE MEDIUM - UNKNOWN FORMAT	Write
5	30	05	CANNOT WRITE MEDIUM - INCOMPATIBLE FORMAT	Write
5	30	06	CANNOT FORMAT MEDIUM - INCOMPATIBLE MEDIUM	Random Write
2	30	07	CLEANING FAILURE	N/A
5	30	08	CANNOT WRITE - APPLICATION CODE MISMATCH	Sequential Write
5	30	09	CURRENT SESSION NOT FIXATED FOR APPEND	Sequential Write
-	30	0A	CLEANING REQUEST REJECTED	
-	30	0C	WORM MEDIUM - OVERWRITE ATTEMPTED	
-	30	10	MEDIUM NOT FORMATTED	
3	31	00	MEDIUM FORMAT CORRUPTED	Random Write
3	31	01	FORMAT COMMAND FAILED	Formattable
3	31	02	ZONED FORMATTING FAILED DUE TO SPARE LINKING	Formattable
3	32	00	NO DEFECT SPARE LOCATION AVAILABLE	Random Write
3	32	01	DEFECT LIST UPDATE FAILURE	Random Write
3	33	00	TAPE LENGTH ERROR	N/A
4	34	00	ENCLOSURE FAILURE	General
4	35	00	ENCLOSURE SERVICES FAILURE	General

Table 834 - All Error Codes (Sheet 7 of 13)

Sense Key	ASC	ASCQ	Description	Type
5	35	01	UNSUPPORTED ENCLOSURE FUNCTION	General
2	35	02	ENCLOSURE SERVICES UNAVAILABLE	General
4	35	03	ENCLOSURE SERVICES TRANSFER FAILURE	General
5	35	04	ENCLOSURE SERVICES TRANSFER REFUSED	General
-	35	05	ENCLOSURE SERVICES CHECKSUM ERROR	
3	36	00	RIBBON, INK, OR TONER FAILURE	N/A
1	37	00	ROUNDED PARAMETER	N/A
5	38	00	Reserved	Sequential Write
-	38	02	ESN - POWER MANAGEMENT CLASS EVENT	
-	38	04	ESN - MEDIA CLASS EVENT	
-	38	06	ESN - DEVICE BUSY CLASS EVENT	
5	39	00	SAVING PARAMETERS NOT SUPPORTED	General
2	3A	00	MEDIUM NOT PRESENT	General
2	3A	01	MEDIUM NOT PRESENT - TRAY CLOSED	General
2	3A	02	MEDIUM NOT PRESENT - TRAY OPEN	General
-	3A	03	MEDIUM NOT PRESENT - LOADABLE	
-	3A	04	MEDIUM NOT PRESENT - MEDIUM AUXILIARY MEMORY ACCESSIBLE	
3	3B	00	SEQUENTIAL POSITIONING ERROR	N/A
3	3B	01	TAPE POSITION ERROR AT BEGINNING-OF-MEDIUM	N/A
3	3B	02	TAPE POSITION ERROR AT END-OF-MEDIUM	N/A
3	3B	03	TAPE OR ELECTRONIC VERTICAL FORMS UNIT NOT READY	N/A
4	3B	04	SLEW FAILURE	N/A
4	3B	05	PAPER JAM	N/A
3	3B	06	FAILED TO SENSE TOP-OF-FORM	N/A
3	3B	07	FAILED TO SENSE BOTTOM-OF-FORM	N/A
3	3B	08	REPOSITION ERROR	N/A
3	3B	09	READ PAST END OF MEDIUM	N/A
3	3B	0A	READ PAST BEGINNING OF MEDIUM	N/A
3	3B	0B	POSITION PAST END OF MEDIUM	N/A
3	3B	0C	POSITION PAST BEGINNING OF MEDIUM	N/A
5	3B	0D	MEDIUM DESTINATION ELEMENT FULL	N/A
5	3B	0E	MEDIUM SOURCE ELEMENT EMPTY	N/A
6	3B	0F	END OF MEDIUM REACHED	Read
2	3B	11	MEDIUM MAGAZINE NOT ACCESSIBLE	Load
6	3B	12	MEDIUM MAGAZINE REMOVED	Load
6	3B	13	MEDIUM MAGAZINE INSERTED	Load
6	3B	14	MEDIUM MAGAZINE LOCKED	Load
6	3B	15	MEDIUM MAGAZINE UNLOCKED	Load
4	3B	16	MECHANICAL POSITIONING OR CHANGER ERROR	Load
-	3B	17	READ PAST END OF USER OBJECT	
-	3C	00	Reserved	N/A
5	3D	00	INVALID BITS IN IDENTIFY MESSAGE	General
2	3E	00	LOGICAL UNIT HAS NOT SELF-CONFIGURED YET	General
4	3E	01	LOGICAL UNIT FAILURE	General
4	3E	02	TIMEOUT ON LOGICAL UNIT	General
-	3E	03	LOGICAL UNIT FAILED SELF-TEST	

Table 834 - All Error Codes (Sheet 8 of 13)

Sense Key	ASC	ASCQ	Description	Type
-	3E	04	LOGICAL UNIT UNABLE TO UPDATE SELF-TEST LOG	
6	3F	00	TARGET OPERATING CONDITIONS HAVE CHANGED	General
6	3F	01	MICROCODE HAS BEEN CHANGED	General
6	3F	02	CHANGED OPERATING DEFINITION	General
6	3F	03	INQUIRY DATA HAS CHANGED	General
-	3F	04	COMPONENT DEVICE ATTACHED	
-	3F	05	COMPONENT DEVICE ATTACHED	
-	3F	06	REDUNDANCY GROUP CREATED OR MODIFIED	
-	3F	07	REDUNDANCY GROUP DELETED	
-	3F	08	SPARE CREATED OR MODIFIED	
-	3F	09	SPARE DELETED	
-	3F	0A	VOLUME SET CREATED OR MODIFIED	
-	3F	0B	VOLUME SET DELETED	
-	3F	0C	VOLUME SET DEASSIGNED	
-	3F	0D	VOLUME SET REASSIGNED	
-	3F	0E	REPORTED LUNS DATA HAS CHANGED	
-	3F	0F	ECHO BUFFER OVERWRITTEN	
-	3F	10	MEDIUM LOADABLE	
-	3F	11	MEDIUM AUXILIARY MEMORY ACCESSIBLE	
4	40	00	RAM FAILURE (SHOULD USE 40 NN)	N/A
4	40	NN	DIAGNOSTIC FAILURE ON COMPONENT NN (80H-FFH)	General
4	41	00	DATA PATH FAILURE (SHOULD USE 40 NN)	N/A
4	42	00	POWER-ON OR SELF-TEST FAILURE (SHOULD USE 40 NN)	N/A
5	43	00	MESSAGE ERROR	General
4	44	00	INTERNAL TARGET FAILURE	General
-	44	71	ATA DEVICE FAILED SET FEATURES	
b	45	00	SELECT OR RESELECT FAILURE	General
4	46	00	UNSUCCESSFUL SOFT RESET	General
4	47	00	SCSI PARITY ERROR	General
-	47	01	DATA PHASE CRC ERROR DETECTED	
-	47	02	SCSI PARITY ERROR DETECTED DURING ST DATA PHASE	
-	47	03	INFORMATION UNIT <i>iu</i> CRC ERROR DETECTED	
-	47	04	ASYNCHRONOUS INFORMATION PROTECTION ERROR DETECTED	
-	47	05	PROTOCOL SERVICE CRC ERROR	
-	47	06	PHY TEST FUNCTION IN PROGRESS	
-	47	7F	SOME COMMANDS CLEARED BY ISCSI PROTOCOL EVENT	
b	48	00	INITIATOR DETECTED ERROR MESSAGE RECEIVED	General
b	49	00	INVALID MESSAGE ERROR	General
4	4A	00	COMMAND PHASE ERROR	General
4	4B	00	DATA PHASE ERROR	General
-	4B	01	INVALID TARGET PORT TRANSFER TAG RECEIVED	
-	4B	02	TOO MUCH WRITE DATA	
-	4B	03	ACK/NAK TIMEOUT	
-	4B	04	NAK RECEIVED	
-	4B	05	DATA OFFSET ERROR	
-	4B	06	INITIATOR RESPONSE TIMEOUT	

Table 834 - All Error Codes (Sheet 9 of 13)

Sense Key	ASC	ASCQ	Description	Type
4	4C	00	LOGICAL UNIT FAILED SELF-CONFIGURATION	General
b	4D	NN	TAGGED OVERLAPPED COMMANDS (NN = QUEUE TAG)	General
B	4E	00	OVERLAPPED COMMANDS ATTEMPTED	General
-	4F	00	Reserved	N/A
-	50	00	WRITE APPEND ERROR	N/A
-	50	01	WRITE APPEND POSITION ERROR	N/A
-	50	02	POSITION ERROR RELATED TO TIMING	N/A
3	51	00	ERASE FAILURE	Random Write
3	51	01	ERASE FAILURE - Incomplete erase operation detected	Sequential Write
3	52	00	CARTRIDGE FAULT	N/A
4	53	00	MEDIA LOAD OR EJECT FAILED	Load
-	53	01	UNLOAD TAPE FAILURE	N/A
2	53	02	MEDIUM REMOVAL PREVENTED	General
5	53	02	MEDIUM REMOVAL PREVENTED	General
-	54	00	SCSI TO HOST SYSTEM INTERFACE FAILURE	N/A
5	55	00	SYSTEM RESOURCE FAILURE	General
-	55	01	SYSTEM BUFFER FULL	N/A
-	55	02	INSUFFICIENT RESERVATION RESOURCES	
5	55	03	INSUFFICIENT RESOURCES	AACS
-	55	04	INSUFFICIENT REGISTRATION RESOURCES	
-	55	05	INSUFFICIENT ACCESS CONTROL RESOURCES	
-	55	06	AUXILIARY MEMORY OUT OF SPACE	
-	55	07	QUOTA ERROR	
-	56	00	Reserved	N/A
3	57	00	UNABLE TO RECOVER TABLE-OF-CONTENTS	Read
-	58	00	GENERATION DOES NOT EXIST	N/A
-	59	00	UPDATED BLOCK READ	N/A
6	5A	00	OPERATOR REQUEST OR STATE CHANGE INPUT	General
6	5A	01	OPERATOR MEDIUM REMOVAL REQUEST	General
6	5A	02	OPERATOR SELECTED WRITE PROTECT	Write
6	5A	03	OPERATOR SELECTED WRITE PERMIT	Write
6	5B	00	LOG EXCEPTION	General
6	5B	01	THRESHOLD CONDITION MET	General
6	5B	02	LOG COUNTER AT MAXIMUM	General
6	5B	03	LOG LIST CODES EXHAUSTED	General
6	5C	00	RPL STATUS CHANGE	N/A
6	5C	01	SPINDLES SYNCHRONIZED	N/A
3	5C	02	SPINDLES NOT SYNCHRONIZED	N/A
1	5D	00	FAILURE PREDICTION THRESHOLD EXCEEDED	General
1	5D	01	MEDIA FAILURE PREDICTION THRESHOLD EXCEEDED	General
-	5D	02	LOGICAL UNIT FAILURE PREDICTION THRESHOLD EXCEEDED	General
1	5D	03	SPARE AREA EXHAUSTION PREDICTION THRESHOLD EXCEEDED	Random Write
-	5D	10	HARDWARE IMPENDING FAILURE GENERAL HARD DRIVE FAILURE	N/A
-	5D	11	HARDWARE IMPENDING FAILURE DRIVE ERROR RATE TOO HIGH	N/A
-	5D	12	HARDWARE IMPENDING FAILURE DATA ERROR RATE TOO HIGH	N/A
-	5D	13	HARDWARE IMPENDING FAILURE SEEK ERROR RATE TOO HIGH	N/A

Table 834 - All Error Codes (Sheet 10 of 13)

Sense Key	ASC	ASCQ	Description	Type
-	5D	14	HARDWARE IMPENDING FAILURE TOO MANY BLOCK REASSIGNS	N/A
-	5D	15	HARDWARE IMPENDING FAILURE ACCESS TIMES TOO HIGH	N/A
-	5D	16	HARDWARE IMPENDING FAILURE START UNIT TIMES TOO HIGH	N/A
-	5D	17	HARDWARE IMPENDING FAILURE CHANNEL PARAMETRICS	N/A
-	5D	18	HARDWARE IMPENDING FAILURE CONTROLLER DETECTED	N/A
-	5D	19	HARDWARE IMPENDING FAILURE THROUGHPUT PERFORMANCE	N/A
-	5D	1A	HARDWARE IMPENDING FAILURE SEEK TIME PERFORMANCE	N/A
-	5D	1B	HARDWARE IMPENDING FAILURE SPIN-UP RETRY COUNT	N/A
-	5D	1C	HARDWARE IMPENDING FAILURE DRIVE CALIBRATION RETRY COUNT	N/A
-	5D	20	CONTROLLER IMPENDING FAILURE GENERAL HARD DRIVE FAILURE	N/A
-	5D	21	CONTROLLER IMPENDING FAILURE DRIVE ERROR RATE TOO HIGH	N/A
-	5D	22	CONTROLLER IMPENDING FAILURE DATA ERROR RATE TOO HIGH	N/A
-	5D	23	CONTROLLER IMPENDING FAILURE SEEK ERROR RATE TOO HIGH	N/A
-	5D	24	CONTROLLER IMPENDING FAILURE TOO MANY BLOCK REASSIGNS	N/A
-	5D	25	CONTROLLER IMPENDING FAILURE ACCESS TIMES TOO HIGH	N/A
-	5D	26	CONTROLLER IMPENDING FAILURE START UNIT TIMES TOO HIGH	N/A
-	5D	27	CONTROLLER IMPENDING FAILURE CHANNEL PARAMETRICS	N/A
-	5D	28	CONTROLLER IMPENDING FAILURE CONTROLLER DETECTED	N/A
-	5D	29	CONTROLLER IMPENDING FAILURE THROUGHPUT PERFORMANCE	N/A
-	5D	2A	CONTROLLER IMPENDING FAILURE SEEK TIME PERFORMANCE	N/A
-	5D	2B	CONTROLLER IMPENDING FAILURE SPIN-UP RETRY COUNT	N/A
-	5D	2C	CONTROLLER IMPENDING FAILURE DRIVE CALIBRATION RETRY COUNT	N/A
-	5D	30	DATA CHANNEL IMPENDING FAILURE GENERAL HARD DRIVE FAILURE	N/A
-	5D	31	DATA CHANNEL IMPENDING FAILURE DRIVE ERROR RATE TOO HIGH	N/A
-	5D	32	DATA CHANNEL IMPENDING FAILURE DATA ERROR RATE TOO HIGH	N/A
-	5D	33	DATA CHANNEL IMPENDING FAILURE SEEK ERROR RATE TOO HIGH	N/A
-	5D	34	DATA CHANNEL IMPENDING FAILURE TOO MANY BLOCK REASSIGNS	N/A
-	5D	35	DATA CHANNEL IMPENDING FAILURE ACCESS TIMES TOO HIGH	N/A
-	5D	36	DATA CHANNEL IMPENDING FAILURE START UNIT TIMES TOO HIGH	N/A
-	5D	37	DATA CHANNEL IMPENDING FAILURE CHANNEL PARAMETRICS	N/A
-	5D	38	DATA CHANNEL IMPENDING FAILURE CONTROLLER DETECTED	N/A
-	5D	39	DATA CHANNEL IMPENDING FAILURE THROUGHPUT PERFORMANCE	N/A
-	5D	3A	DATA CHANNEL IMPENDING FAILURE SEEK TIME PERFORMANCE	N/A
-	5D	3B	DATA CHANNEL IMPENDING FAILURE SPIN-UP RETRY COUNT	N/A
-	5D	3C	DATA CHANNEL IMPENDING FAILURE DRIVE CALIBRATION RETRY COUNT	N/A
-	5D	40	SERVO IMPENDING FAILURE GENERAL HARD DRIVE FAILURE	N/A
-	5D	41	SERVO IMPENDING FAILURE DRIVE ERROR RATE TOO HIGH	N/A
-	5D	42	SERVO IMPENDING FAILURE DATA ERROR RATE TOO HIGH	N/A
-	5D	43	SERVO IMPENDING FAILURE SEEK ERROR RATE TOO HIGH	N/A
-	5D	44	SERVO IMPENDING FAILURE TOO MANY BLOCK REASSIGNS	N/A
-	5D	45	SERVO IMPENDING FAILURE ACCESS TIMES TOO HIGH	N/A
-	5D	46	SERVO IMPENDING FAILURE START UNIT TIMES TOO HIGH	N/A
-	5D	47	SERVO IMPENDING FAILURE CHANNEL PARAMETRICS	N/A
-	5D	48	SERVO IMPENDING FAILURE CONTROLLER DETECTED	N/A
-	5D	49	SERVO IMPENDING FAILURE THROUGHPUT PERFORMANCE	N/A

Table 834 - All Error Codes (Sheet 11 of 13)

Sense Key	ASC	ASCQ	Description	Type
-	5D	4A	SERVO IMPENDING FAILURE SEEK TIME PERFORMANCE	N/A
-	5D	4B	SERVO IMPENDING FAILURE SPIN-UP RETRY COUNT	N/A
-	5D	4C	SERVO IMPENDING FAILURE DRIVE CALIBRATION RETRY COUNT	N/A
-	5D	50	SPINDLE IMPENDING FAILURE GENERAL HARD DRIVE FAILURE	N/A
-	5D	51	SPINDLE IMPENDING FAILURE DRIVE ERROR RATE TOO HIGH	N/A
-	5D	52	SPINDLE IMPENDING FAILURE DATA ERROR RATE TOO HIGH	N/A
-	5D	53	SPINDLE IMPENDING FAILURE SEEK ERROR RATE TOO HIGH	N/A
-	5D	54	SPINDLE IMPENDING FAILURE TOO MANY BLOCK REASSIGNS	N/A
-	5D	55	SPINDLE IMPENDING FAILURE ACCESS TIMES TOO HIGH	N/A
-	5D	56	SPINDLE IMPENDING FAILURE START UNIT TIMES TOO HIGH	N/A
-	5D	57	SPINDLE IMPENDING FAILURE CHANNEL PARAMETRICS	N/A
-	5D	58	SPINDLE IMPENDING FAILURE CONTROLLER DETECTED	N/A
-	5D	59	SPINDLE IMPENDING FAILURE THROUGHPUT PERFORMANCE	N/A
-	5D	5A	SPINDLE IMPENDING FAILURE SEEK TIME PERFORMANCE	N/A
-	5D	5B	SPINDLE IMPENDING FAILURE SPIN-UP RETRY COUNT	N/A
-	5D	5C	SPINDLE IMPENDING FAILURE DRIVE CALIBRATION RETRY COUNT	N/A
-	5D	60	FIRMWARE IMPENDING FAILURE GENERAL HARD DRIVE FAILURE	N/A
-	5D	61	FIRMWARE IMPENDING FAILURE DRIVE ERROR RATE TOO HIGH	N/A
-	5D	62	FIRMWARE IMPENDING FAILURE DATA ERROR RATE TOO HIGH	N/A
-	5D	63	FIRMWARE IMPENDING FAILURE SEEK ERROR RATE TOO HIGH	N/A
-	5D	64	FIRMWARE IMPENDING FAILURE TOO MANY BLOCK REASSIGNS	N/A
-	5D	65	FIRMWARE IMPENDING FAILURE ACCESS TIMES TOO HIGH	N/A
-	5D	66	FIRMWARE IMPENDING FAILURE START UNIT TIMES TOO HIGH	N/A
-	5D	67	FIRMWARE IMPENDING FAILURE CHANNEL PARAMETRICS	N/A
-	5D	68	FIRMWARE IMPENDING FAILURE CONTROLLER DETECTED	N/A
-	5D	69	FIRMWARE IMPENDING FAILURE THROUGHPUT PERFORMANCE	N/A
-	5D	6A	FIRMWARE IMPENDING FAILURE SEEK TIME PERFORMANCE	N/A
-	5D	6B	FIRMWARE IMPENDING FAILURE SPIN-UP RETRY COUNT	N/A
-	5D	6C	FIRMWARE IMPENDING FAILURE DRIVE CALIBRATION RETRY COUNT	N/A
1	5D	FF	FAILURE PREDICTION THRESHOLD EXCEEDED (FALSE)	General
6	5E	00	LOW POWER CONDITION ON	General
6	5E	01	IDLE CONDITION ACTIVATED BY TIMER	General
6	5E	02	STANDBY CONDITION ACTIVATED BY TIMER	General
6	5E	03	IDLE CONDITION ACTIVATED BY COMMAND	General
6	5E	04	STANDBY CONDITION ACTIVATED BY COMMAND	General
-	5E	41	POWER STATE CHANGE TO ACTIVE	N/A
-	5E	42	POWER STATE CHANGE TO IDLE	N/A
-	5E	43	POWER STATE CHANGE TO STANDBY	N/A
-	5E	45	POWER STATE CHANGE TO SLEEP	N/A
-	5E	47	POWER STATE CHANGE TO DEVICE CONTROL	N/A
-	5F	00	Reserved	N/A
4	60	00	LAMP FAILURE	N/A
3	61	00	VIDEO ACQUISITION ERROR	N/A
3	61	01	UNABLE TO ACQUIRE VIDEO	N/A
3	61	02	OUT OF FOCUS	N/A
4	62	00	SCAN HEAD POSITIONING ERROR	N/A

Table 834 - All Error Codes (Sheet 12 of 13)

Sense Key	ASC	ASCQ	Description	Type
5	63	00	END OF USER AREA ENCOUNTERED ON THIS TRACK	CD Read
5	63	01	PACKET DOES NOT FIT IN AVAILABLE SPACE	CD Read
5	64	00	ILLEGAL MODE FOR THIS TRACK	CD Read
5	64	01	INVALID PACKET SIZE	CD Write
4	65	00	VOLTAGE FAULT	General
4	66	00	AUTOMATIC DOCUMENT FEEDER COVER UP	N/A
4	66	01	AUTOMATIC DOCUMENT FEEDER LIFT UP	N/A
4	66	02	DOCUMENT JAM IN AUTOMATIC DOCUMENT FEEDER	N/A
4	66	03	DOCUMENT MISS FEED AUTOMATIC IN DOCUMENT FEEDER	N/A
4	67	00	CONFIGURATION FAILURE	N/A
4	67	01	CONFIGURATION OF INCAPABLE LOGICAL UNITS FAILED	N/A
4	67	02	ADD LOGICAL UNIT FAILED	N/A
4	67	03	MODIFICATION OF LOGICAL UNIT FAILED	N/A
4	67	04	EXCHANGE OF LOGICAL UNIT FAILED	N/A
4	67	05	REMOVE OF LOGICAL UNIT FAILED	N/A
4	67	06	ATTACHMENT OF LOGICAL UNIT FAILED	N/A
4	67	07	CREATION OF LOGICAL UNIT FAILED	N/A
-	67	08	ASSIGN FAILURE OCCURRED	
-	67	09	MULTIPLY ASSIGNED LOGICAL UNIT	
-	67	0A	SET TARGET PORT GROUPS COMMAND FAILED	
2	68	00	LOGICAL UNIT NOT CONFIGURED	N/A
4	69	00	DATA LOSS ON LOGICAL UNIT	N/A
4	69	01	MULTIPLE LOGICAL UNIT FAILURES	N/A
4	69	02	A PARITY/DATA MISMATCH	N/A
1	6A	00	INFORMATIONAL, REFER TO LOG	N/A
6	6B	00	STATE CHANGE HAS OCCURRED	N/A
6	6B	01	REDUNDANCY LEVEL GOT BETTER	N/A
6	6B	02	REDUNDANCY LEVEL GOT WORSE	N/A
3	6C	00	REBUILD FAILURE OCCURRED	N/A
3	6D	00	RECALCULATE FAILURE OCCURRED	N/A
4	6E	00	COMMAND TO LOGICAL UNIT FAILED	N/A
5	6F	00	COPY PROTECTION KEY EXCHANGE FAILURE - AUTHENTICATION FAILURE	CPP
5	6F	01	COPY PROTECTION KEY EXCHANGE FAILURE - KEY NOT PRESENT	CPP
5	6F	02	COPY PROTECTION KEY EXCHANGE FAILURE - KEY NOT ESTABLISHED	CPP
5	6F	03	READ OF SCRAMBLED SECTOR WITHOUT AUTHENTICATION	CPP
5	6F	04	MEDIA REGION CODE IS MISMATCHED TO LOGICAL UNIT REGION	CPP
5	6F	05	DRIVE REGION MUST BE PERMANENT/REGION RESET COUNT ERROR	CPP
5	6F	06	INSUFFICIENT BLOCK COUNT FOR BINDING NONCE RECORDING	AACS
5	6F	07	CONFLICT IN BINDING NONCE RECORDING	AACS
5	6F	08	INSUFFICIENT PERMISSION	AACS
3	70	NN	DECOMPRESSION EXCEPTION SHORT ALGORITHM ID OF NN	N/A
3	71	00	DECOMPRESSION EXCEPTION LONG ALGORITHM ID	N/A
3	72	00	SESSION FIXATION ERROR	Sequential Write
3	72	01	SESSION FIXATION ERROR WRITING Lead-in	Sequential Write
3	72	02	SESSION FIXATION ERROR WRITING Lead-out	Sequential Write

Table 834 - All Error Codes (Sheet 13 of 13)

Sense Key	ASC	ASCQ	Description	Type
5	72	03	SESSION FIXATION ERROR - INCOMPLETE TRACK IN SESSION	Sequential Write
5	72	04	EMPTY OR PARTIALLY WRITTEN RESERVED TRACK	Sequential Write
5	72	05	NO MORE RZONE RESERVATIONS ARE ALLOWED	Sequential Write
5	72	06	RMZ EXTENSION IS NOT ALLOWED	Sequential Write
5	72	07	NO MORE TEST ZONE EXTENSIONS ARE ALLOWED	Sequential Write
3	73	00	CD CONTROL ERROR	CD Read
1	73	01	POWER CALIBRATION AREA ALMOST FULL	Sequential Write
3	73	02	POWER CALIBRATION AREA IS FULL	Sequential Write
3	73	03	POWER CALIBRATION AREA ERROR	Sequential Write
3	73	04	PROGRAM MEMORY AREA/RMA UPDATE FAILURE	Sequential Write
3	73	05	PROGRAM MEMORY AREA/RMA IS FULL	Sequential Write
1	73	06	PROGRAM MEMORY AREA/RMA IS ALMOST FULL	Sequential Write
1	73	10	CURRENT POWER CALIBRATION AREA ALMOST FULL	Sequential Write
5	73	11	CURRENT POWER CALIBRATION AREA IS FULL	Sequential Write
5	73	15	CURRENT PROGRAM MEMORY AREA/RMZ IS FULL	Sequential Write
1	73	16	CURRENT PROGRAM MEMORY AREA/RMZ IS (almost) FULL	Sequential Write
5	73	17	RDZ IS FULL	Sequential Write
-	80 through FF	xx xx	VENDOR SPECIFIC	

ALL CODES NOT SHOWN ARE RESERVED.

Table 835 - Basic Error Codes (Sheet 1 of 3)

Sense Key	ASC	ASC Q	Description
0	00	00	NO ADDITIONAL SENSE INFORMATION
B	00	06	I/O PROCESS TERMINATED, PLAY OPERATION ABORTED
2	05	00	LOGICAL UNIT DOES NOT RESPOND TO SELECTION
5	07	00	MULTIPLE PERIPHERAL DEVICES SELECTED
4	08	00	LOGICAL UNIT COMMUNICATION FAILURE
4	08	01	LOGICAL UNIT COMMUNICATION TIME-OUT
4	08	02	LOGICAL UNIT COMMUNICATION PARITY ERROR
4	08	03	LOGICAL UNIT COMMUNICATION CRC ERROR (ULTRA-DMA/32)
6	0A	00	ERROR LOG OVERFLOW
1	0B	00	WARNING
1	0B	01	WARNING - SPECIFIED TEMPERATURE EXCEEDED
1	0B	02	WARNING - ENCLOSURE DEGRADED
5	1A	00	PARAMETER LIST LENGTH ERROR
4	1B	00	SYNCHRONOUS DATA TRANSFER ERROR
5	20	00	INVALID COMMAND OPERATION CODE
5	24	00	INVALID FIELD IN CDB
5	25	00	LOGICAL UNIT NOT SUPPORTED
5	26	00	INVALID FIELD IN PARAMETER LIST

Table 835 - Basic Error Codes (Sheet 2 of 3)

Sense Key	ASC	ASC Q	Description
5	26	01	PARAMETER NOT SUPPORTED
5	26	02	PARAMETER VALUE INVALID
5	26	03	THRESHOLD PARAMETERS NOT SUPPORTED
5	26	04	INVALID RELEASE OF ACTIVE PERSISTENT RESERVATION
6	28	00	NOT READY TO READY CHANGE, MEDIUM MAY HAVE CHANGED
6	28	01	IMPORT OR EXPORT ELEMENT ACCESSED
6	28	02	NOT READY TO READY CHANGE, FORMAT-LAYER MAY HAVE CHANGED
6	29	00	POWER ON, RESET, OR BUS DEVICE RESET OCCURRED
6	29	01	POWER ON OCCURRED
6	29	02	SCSI BUS RESET OCCURRED
6	29	03	BUS DEVICE RESET FUNCTION OCCURRED
6	29	04	DEVICE INTERNAL RESET
6	2A	00	PARAMETERS CHANGED
6	2A	01	MODE PARAMETERS CHANGED
6	2A	02	LOG PARAMETERS CHANGED
6	2A	03	RESERVATIONS PREEMPTED
5	2C	00	COMMAND SEQUENCE ERROR
6	2F	00	COMMANDS CLEARED BY ANOTHER INITIATOR
4	34	00	ENCLOSURE FAILURE
4	35	00	ENCLOSURE SERVICES FAILURE
5	35	01	UNSUPPORTED ENCLOSURE FUNCTION
2	35	02	ENCLOSURE SERVICES UNAVAILABLE
4	35	03	ENCLOSURE SERVICES TRANSFER FAILURE
5	35	04	ENCLOSURE SERVICES TRANSFER REFUSED
5	3D	00	INVALID BITS IN IDENTIFY MESSAGE
2	3E	00	LOGICAL UNIT HAS NOT SELF-CONFIGURED YET
4	3E	01	LOGICAL UNIT FAILURE
4	3E	02	TIMEOUT ON LOGICAL UNIT
6	3F	00	TARGET OPERATING CONDITIONS HAVE CHANGED
6	3F	01	MICROCODE HAS BEEN CHANGED
6	3F	02	CHANGED OPERATING DEFINITION
6	3F	03	INQUIRY DATA HAS CHANGED
4	40	00	RAM FAILURE (SHOULD USE 40 NN)
4	40	NN	DIAGNOSTIC FAILURE ON COMPONENT NN (80H-FFH)
4	41	00	DATA PATH FAILURE (SHOULD USE 40 NN)
4	42	00	POWER-ON OR SELF-TEST FAILURE (SHOULD USE 40 NN)
5	43	00	MESSAGE ERROR
4	44	00	INTERNAL TARGET FAILURE
b	45	00	SELECT OR RESELECT FAILURE
4	46	00	UNSUCCESSFUL SOFT RESET
4	47	00	SCSI PARITY ERROR
b	48	00	INITIATOR DETECTED ERROR MESSAGE RECEIVED
b	49	00	INVALID MESSAGE ERROR
4	4A	00	COMMAND PHASE ERROR
4	4B	00	DATA PHASE ERROR
4	4C	00	LOGICAL UNIT FAILED SELF-CONFIGURATION

Table 835 - Basic Error Codes (Sheet 3 of 3)

Sense Key	ASC	ASC Q	Description
b	4D	NN	TAGGED OVERLAPPED COMMANDS (NN = QUEUE TAG)
B	4E	00	OVERLAPPED COMMANDS ATTEMPTED
4	54	00	SCSI TO HOST SYSTEM INTERFACE FAILURE
5	55	00	SYSTEM RESOURCE FAILURE
6	55	01	SYSTEM BUFFER FULL
5	55	03	INSUFFICIENT RESOURCES
6	5A	00	OPERATOR REQUEST OR STATE CHANGE INPUT
6	5A	01	OPERATOR MEDIUM REMOVAL REQUEST
6	5A	02	OPERATOR SELECTED WRITE PROTECT
6	5A	03	OPERATOR SELECTED WRITE PERMIT
6	5B	00	LOG EXCEPTION
6	5B	01	THRESHOLD CONDITION MET
6	5B	02	LOG COUNTER AT MAXIMUM
6	5B	03	LOG LIST CODES EXHAUSTED
1	5D	00	FAILURE PREDICTION THRESHOLD EXCEEDED - Predicted logical unit Failure
1	5D	01	FAILURE PREDICTION THRESHOLD EXCEEDED - Predicted Media Failure
1	5D	03	FAILURE PREDICTION THRESHOLD EXCEEDED - Predicted Spare Area Exhaustion
1	5D	FF	FAILURE PREDICTION THRESHOLD EXCEEDED (FALSE)
6	5E	00	LOW POWER CONDITION ON
6	5E	01	IDLE CONDITION ACTIVATED BY TIMER
6	5E	02	STANDBY CONDITION ACTIVATED BY TIMER
6	5E	03	IDLE CONDITION ACTIVATED BY COMMAND
6	5E	04	STANDBY CONDITION ACTIVATED BY COMMAND
4	65	00	VOLTAGE FAULT
4	67	00	CONFIGURATION FAILURE
4	67	01	CONFIGURATION OF INCAPABLE LOGICAL UNITS FAILED
4	67	02	ADD LOGICAL UNIT FAILED
4	67	03	MODIFICATION OF LOGICAL UNIT FAILED
4	67	04	EXCHANGE OF LOGICAL UNIT FAILED
4	67	05	REMOVE OF LOGICAL UNIT FAILED
4	67	06	ATTACHMENT OF LOGICAL UNIT FAILED
4	67	07	CREATION OF LOGICAL UNIT FAILED
2	68	00	LOGICAL UNIT NOT CONFIGURED
6	6A	00	INFORMATIONAL, REFER TO LOG
6	6B	00	STATE CHANGE HAS OCCURRED
6	6B	01	REDUNDANCY LEVEL GOT BETTER
6	6B	02	REDUNDANCY LEVEL GOT WORSE
3	6C	00	REBUILD FAILURE OCCURRED
3	6D	00	RECALCULATE FAILURE OCCURRED
4	6E	00	COMMAND TO LOGICAL UNIT FAILED
	80	xx	VENDOR SPECIFIC
	through		
	FF	xx	

Table 836 - Media Access Error Codes (Sheet 1 of 3)

Sense Key	ASC	ASC Q	Description
4	00	17	CLEANING REQUESTED
4	01	00	NO INDEX/SECTOR SIGNAL
3	02	00	NO SEEK COMPLETE
2	04	00	LOGICAL UNIT NOT READY, CAUSE NOT REPORTABLE
2	04	01	LOGICAL UNIT IS IN PROCESS OF BECOMING READY
2	04	02	LOGICAL UNIT NOT READY, INITIALIZING CMD. REQUIRED
2	04	03	LOGICAL UNIT NOT READY, MANUAL INTERVENTION REQUIRED
2	04	04	LOGICAL UNIT NOT READY, FORMAT IN PROGRESS
2	04	05	LOGICAL UNIT NOT READY, REBUILD IN PROGRESS
2	04	06	LOGICAL UNIT NOT READY, RECALCULATION IN PROGRESS
2	04	07	LOGICAL UNIT NOT READY, OPERATION IN PROGRESS
2	04	08	LOGICAL UNIT NOT READY, LONG WRITE IN PROGRESS
2	06	00	NO REFERENCE POSITION FOUND (medium may be upside down)
4	09	00	TRACK FOLLOWING ERROR
4	09	01	TRACKING SERVO FAILURE
4	09	02	FOCUS SERVO FAILURE
4	09	03	SPINDLE SERVO FAILURE
4	09	04	HEAD SELECT FAULT
3	10	00	ID CRC OR ECC ERROR
3	11	00	UNRECOVERED READ ERROR
3	11	01	READ RETRIES EXHAUSTED
3	11	02	ERROR TOO LONG TO CORRECT
3	11	03	MULTIPLE READ ERRORS
3	11	04	UNRECOVERED READ ERROR - AUTO REALLOCATE FAILED
3	11	05	L-EC UNCORRECTABLE ERROR
3	11	06	CIRC UNRECOVERED ERROR
3	11	07	RE-SYNCHRONIZATION ERROR
3	11	08	INCOMPLETE BLOCK READ
3	11	09	NO GAP FOUND
3	11	0A	MISCORRECTED ERROR
3	11	0B	UNRECOVERED READ ERROR - RECOMMEND REASSIGNMENT
3	11	0C	UNRECOVERED READ ERROR - RECOMMEND REWRITE THE DATA
3	11	0D	DE-COMPRESSION CRC ERROR
3	11	0E	CANNOT DECOMPRESS USING DECLARED ALGORITHM
3	11	0F	ERROR READING UPC/EAN NUMBER
3	11	10	ERROR READING ISRC NUMBER
B	11	11	READ ERROR - LOSS OF STREAMING
3	12	00	ADDRESS MARK NOT FOUND FOR ID FIELD
3	13	00	ADDRESS MARK NOT FOUND FOR DATA FIELD
3	15	00	RANDOM POSITIONING ERROR
3	15	01	MECHANICAL POSITIONING ERROR
3	15	02	POSITIONING ERROR DETECTED BY READ OF MEDIUM
1	17	00	RECOVERED DATA WITH NO ERROR CORRECTION APPLIED
1	17	01	RECOVERED DATA WITH RETRIES

Table 836 - Media Access Error Codes (Sheet 2 of 3)

Sense Key	ASC	ASC Q	Description
1	17	02	RECOVERED DATA WITH POSITIVE HEAD OFFSET
1	17	03	RECOVERED DATA WITH NEGATIVE HEAD OFFSET
1	17	04	RECOVERED DATA WITH RETRIES AND/OR CIRC APPLIED
1	17	05	RECOVERED DATA USING PREVIOUS SECTOR ID
1	17	06	RECOVERED DATA WITHOUT ECC - DATA AUTO-REALLOCATED
1	17	07	RECOVERED DATA WITHOUT ECC - RECOMMEND REASSIGNMENT
1	17	08	RECOVERED DATA WITHOUT ECC - RECOMMEND REWRITE
1	17	09	RECOVERED DATA WITHOUT ECC - DATA REWRITTEN
1	18	00	RECOVERED DATA WITH ERROR CORRECTION APPLIED
1	18	01	RECOVERED DATA WITH ERROR CORR. & RETRIES APPLIED
1	18	02	RECOVERED DATA - DATA AUTO-REALLOCATED
1	18	03	RECOVERED DATA WITH CIRC
1	18	04	RECOVERED DATA WITH L-EC
1	18	05	RECOVERED DATA - RECOMMEND REASSIGNMENT
1	18	06	RECOVERED DATA - RECOMMEND REWRITE
1	18	07	RECOVERED DATA WITH ECC - DATA REWRITTEN
1	18	08	RECOVERED DATA WITH LINKING
3	19	00	DEFECT LIST ERROR
3	19	01	DEFECT LIST NOT AVAILABLE
3	19	02	DEFECT LIST ERROR IN PRIMARY LIST
3	19	03	DEFECT LIST ERROR IN GROWN LIST
4	1C	00	DEFECT LIST NOT FOUND
4	1C	01	PRIMARY DEFECT LIST NOT FOUND
4	1C	02	GROWN DEFECT LIST NOT FOUND
1	1E	00	RECOVERED ID WITH ECC CORRECTION
3	1F	00	PARTIAL DEFECT LIST TRANSFER
5	21	00	LOGICAL BLOCK ADDRESS OUT OF RANGE
5	21	01	INVALID ELEMENT ADDRESS
2	30	00	INCOMPATIBLE MEDIUM INSTALLED
2	30	01	CANNOT READ MEDIUM - UNKNOWN FORMAT
2	30	02	CANNOT READ MEDIUM - INCOMPATIBLE FORMAT
5	30	02	CANNOT READ MEDIUM - INCOMPATIBLE FORMAT
2	30	03	CLEANING CARTRIDGE INSTALLED
5	30	04	CANNOT WRITE MEDIUM - UNKNOWN FORMAT
5	30	05	CANNOT WRITE MEDIUM - INCOMPATIBLE FORMAT
5	30	06	CANNOT FORMAT MEDIUM - INCOMPATIBLE MEDIUM
2	30	07	CLEANING FAILURE
5	30	08	CANNOT WRITE - APPLICATION CODE MISMATCH
5	30	09	CURRENT SESSION NOT FIXATED FOR APPEND
2	3A	00	MEDIUM NOT PRESENT
2	3A	01	MEDIUM NOT PRESENT - TRAY CLOSED
2	3A	02	MEDIUM NOT PRESENT - TRAY OPEN
3	57	00	UNABLE TO RECOVER TABLE-OF-CONTENTS
6	59	00	UPDATED BLOCK READ

Table 836 - Media Access Error Codes (Sheet 3 of 3)

Sense Key	ASC	ASC Q	Description
5	63	00	END OF USER AREA ENCOUNTERED ON THIS TRACK
5	63	01	PACKET DOES NOT FIT IN AVAILABLE SPACE
5	64	00	ILLEGAL MODE FOR THIS TRACK
5	6F	03	READ OF SCRAMBLED SECTOR WITHOUT AUTHENTICATION
3	73	00	CD CONTROL ERROR
	80	xx	VENDOR SPECIFIC
	through		
	FF	xx	

Table 837 - Write Error Codes (Sheet 1 of 2)

Sense Key	ASC	ASC Q	Description
8	00	00	BLANK CHECK
3	03	00	PERIPHERAL DEVICE WRITE FAULT
3	03	01	NO WRITE CURRENT
3	03	02	EXCESSIVE WRITE ERRORS
3	0C	00	WRITE ERROR
3	0C	01	WRITE ERROR - RECOVERED WITH AUTO REALLOCATION
3	0C	02	WRITE ERROR - AUTO REALLOCATION FAILED
3	0C	03	WRITE ERROR - RECOMMEND REASSIGNMENT
3	0C	04	COMPRESSION CHECK MISCOMPARE ERROR
3	0C	05	DATA EXPANSION OCCURRED DURING COMPRESSION
3	0C	06	BLOCK NOT COMPRESSIBLE
3	0C	07	WRITE ERROR - RECOVERY NEEDED
3	0C	08	WRITE ERROR - RECOVERY FAILED
3	0C	09	WRITE ERROR - LOSS OF STREAMING
1	0C	0A	WRITE ERROR - PADDING BLOCKS ADDED
E	1D	00	MISCOMPARE DURING VERIFY OPERATION
5	21	02	INVALID ADDRESS FOR WRITE
5	21	03	INVALID WRITE CROSSING LAYER JUMP
7	27	01	HARDWARE WRITE PROTECTED
7	27	02	LOGICAL UNIT SOFTWARE WRITE PROTECTED
7	27	03	ASSOCIATED WRITE PROTECT
7	27	04	PERSISTENT WRITE PROTECT
7	27	05	PERMANENT WRITE PROTECT
7	27	06	CONDITIONAL WRITE PROTECT
5	30	04	CANNOT WRITE MEDIUM - UNKNOWN FORMAT
5	30	05	CANNOT WRITE MEDIUM - INCOMPATIBLE FORMAT
5	30	06	CANNOT FORMAT MEDIUM - INCOMPATIBLE MEDIUM
2	30	07	CLEANING FAILURE
5	30	08	CANNOT WRITE - APPLICATION CODE MISMATCH
5	30	09	CURRENT SESSION NOT FIXATED FOR APPEND
3	32	00	NO DEFECT SPARE LOCATION AVAILABLE
3	32	01	DEFECT LIST UPDATE FAILURE
5	38	00	Reserved
4	50	00	WRITE APPEND ERROR
4	50	01	WRITE APPEND POSITION ERROR
4	50	02	POSITION ERROR RELATED TO TIMING
3	51	00	ERASE FAILURE
3	51	01	ERASE FAILURE - Incomplete erase operation detected
5	64	01	INVALID PACKET SIZE
3	73	00	CD CONTROL ERROR
1	73	01	POWER CALIBRATION AREA ALMOST FULL
3	73	02	POWER CALIBRATION AREA IS FULL
3	73	03	POWER CALIBRATION AREA ERROR
3	73	04	PROGRAM MEMORY AREA/RMA UPDATE FAILURE

Table 837 - Write Error Codes (Sheet 2 of 2)

Sense Key	ASC	ASC Q	Description
3	73	05	PROGRAM MEMORY AREA/RMA IS FULL
1	73	06	PROGRAM MEMORY AREA/RMA IS (almost) FULL
1	73	10	CURRENT POWER CALIBRATION AREA ALMOST FULL
5	73	11	CURRENT POWER CALIBRATION AREA IS FULL
5	73	15	CURRENT PROGRAM MEMORY AREA/RMZ IS FULL
1	73	16	CURRENT PROGRAM MEMORY AREA/RMZ IS (almost) FULL
5	73	17	RDZ IS FULL
	80 through FF	xx xx	VENDOR SPECIFIC

Table 838 - Session/Border Error Codes

Sense Key	ASC	ASC Q	Description
5	2C	03	CURRENT PROGRAM AREA IS NOT EMPTY
5	2C	04	CURRENT PROGRAM AREA IS EMPTY
3	72	00	SESSION FIXATION ERROR
3	72	01	SESSION FIXATION ERROR WRITING Lead-in
3	72	02	SESSION FIXATION ERROR WRITING Lead-out
5	72	03	SESSION FIXATION ERROR - INCOMPLETE TRACK IN SESSION
5	72	04	EMPTY OR PARTIALLY WRITTEN RESERVED TRACK
5	72	05	NO MORE RZONE RESERVATIONS ARE ALLOWED
5	72	06	RMZ EXTENSION IS NOT ALLOWED
5	72	07	NO MORE TEST ZONE EXTENSIONS ARE ALLOWED
	80 through FF	xx xx	VENDOR SPECIFIC

Table 839 - Authentication Error Codes

Sense Key	ASC	ASC Q	Description
5	6F	00	COPY PROTECTION KEY EXCHANGE FAILURE - AUTHENTICATION FAILURE
5	6F	01	COPY PROTECTION KEY EXCHANGE FAILURE - KEY NOT PRESENT
5	6F	02	COPY PROTECTION KEY EXCHANGE FAILURE - KEY NOT ESTABLISHED
5	6F	04	MEDIA REGION CODE IS MISMATCHED TO LOGICAL UNIT REGION
5	6F	05	DRIVE REGION MUST BE PERMANENT/REGION RESET COUNT ERROR
5	6F	06	INSUFFICIENT BLOCK COUNT FOR BINDING NONCE RECORDING
5	6F	07	CONFLICT IN BINDING NONCE RECORDING
5	6F	08	INSUFFICIENT PERMISSION

Appendix B - ATAPI Implementation Notes (Normative)

B-1 Introduction

See the INCITS T13 ATA/ATAPI-4 Specification for information on the connection and protocol to be use for ATAPI Multi-Media device.

The ATA/IDE interface has become a de facto industry standard for connection of disk drives in PC's. In the interest of simplicity and cost, the ATA/IDE interface was originally designed to support only a small subset of computer peripherals. The expanding use of multimedia, inexpensive program distribution on optical discs (e.g., CD, DVD), and faster and more powerful systems has created the need for enhancements to ATA. This specification is one of those enhancements and provides a simple and inexpensive Multi-Media device interface through a superset of ATA.

B-2 ATA Signal Utilization

ATAPI Devices will utilize the same signals and timing from the ATA Standard and Extensions.

B-3 ATA command Utilization

The ATA Task File concept does not contain enough bytes to support some of the command structures, so a command called "ATAPI Packet command" has been added to allow a Packet to be sent to the Device. The Packet will be transferred by writing multiple times to the Data Register. No random access to the register file in the Peripheral can be done. This technique reduces the number of register addresses needed, but not the actual space needed. Although all the commands for the CD-ROM Device could be sent via this packet mode, some of the existing ATA commands and the full ATA command protocol *shall* be provided for the existing drivers to operate correctly. The Multi-Media device will therefore support some existing ATA commands in addition to the new "ATAPI Packet command," so that there will be minimal changes to the existing drivers. This minimal set of ATA commands is different than the minimum as defined in the ATA standard, but should be sufficient for normal operation.

B-4 ATA Compatibility

There are several legacy issues with the existing ATA commands, and therefore the Device will respond to the existing ATA Reset Master/Slave Diagnostic Sequence, but not the Identify Drive or Read commands. This will allow the BIOS and older drivers to ignore the Device and not confuse ATAPI data with normal ATA Drive format data. All unsupported ATA commands *shall* be Aborted, and not performed. As with aborted commands in ATA, an interrupt will be generated to signal the completion with an "aborted" error status.

B-5 Packet Types

To allow for generic packet transfer and the connection of SCSI like peripherals, there *shall* exist a minimum set of information that is exchanged. This information *shall* generically support the following:

- Command Packet (Always padded to number of bytes identified in byte 0 of the identify drive data. 00 = 12 bytes, 01 = 16 bytes)
- Command Parameter Data (e.g., Write Data)
- Command Response Data (e.g., Read Data)
- Status. The Status will not take the form of a packet of information. The status will be presented using the ATAPI Status Register (redefinitions of the ATA Status Register).

B-6 How SCSI is Used by ATAPI

Although the ATAPI Device will utilize many of the actual packet definitions from the SCSI standard, it will NOT use most other features of the normal SCSI Protocol. Thus there are no Phases, no Messages, no sharable bus, (only one host Computer) and no SCSI Hardware. For those who are familiar with the current SCSI-3 effort, this specification will not conform with that Packetized Standard.

B-6.1 Differences from the SCSI Standard

Some of the major differences from the SCSI Standard:

- Status will use the ATAPI description, rather than a Data Byte passed at the end of the command.
- ATAPI Device is slave during operation rather than the master view of a SCSI Peripheral.
- No messages are supported.
- No disconnect/reconnect or any of the SCSI Pointers.
- No linking.
- All CD Command Packets (CP) are 12 bytes in length, rather than the 6, 8, 10 or 12-byte packets of the SCSI Standard; however, 16-byte ATAPI command packets are defined for SAM compatibility for future Devices. The size of the command packet required by a Device is defined in word 0 of the ATAPI Identify Device command, allowing host System Device Drivers to determine the size of the Command Packets before issuing an ATAPI command packet.
- No allegiance conditions are used.

This specification will make use of many of the Standard SCSI Command Block definitions and commands, but some of the commands that would normally be supported by a SCSI Device will not be supported for various reasons. These commands are:

- Reserve and release; as there is only one host allowed, this is not needed.
- Send and receive diagnostics; the ATA EXECUTE DRIVE DIAGS command replaces these commands.
- Change definitions; as there is no SCSI, this command is nonsensical.
- Copy / Copy and Verify; no shared bus so this command can't be implemented.
- Compare; no shared bus, so this command can't be implemented.
- Read and Write Buffer; simplification.
- Log Sense and Select; simplification.
- Search Data; simplification.
- Verify; simplification.

B-6.2 Reset Usage

This section describes the three types of resets and how they are used in an ATAPI environment.

Table 840 - Reset Function Mapping

Reset Type	ATAPI
Power-On Reset	Same as Power-On Reset in the proposed ATA/ATAPI-4 INCITS T13/1153D Standard
Hard Reset	Hard Reset, Reset-bus signal
Interface Reset	ATA SRST. This is a channel reset. The same behavior as Hard Reset is possible. However the SRST <i>shall not</i> reset any mode parameters to the default state.
Device Reset	Device Reset in proposed ATA/ATAPI-4 INCITS T13/1153D Standard
	ATAPI Soft Reset in SFF8020i (expired)

B-6.3 Power On Reset

The Power On Reset ***shall*** operate as specified in the proposed ATA/ATAPI-4 INCITS T13/1153D Standard.

B-6.4 Hard Reset

The Hard Reset corresponds to the Hard Reset (RESET- signal line) and the SRST (ATA/ATAPI Software Reset).

The ATAPI Hard Reset, being different from SCSI, can not reset just one device. In ATAPI all the devices on the same cable are reset.

The effect of these two resets are the same, but usage of the SRST will be restricted.

B-6.4.1 SRST

The SRST was defined for use in an ATA environment and **should not be used in an ATAPI environment**. However there are some specific requirements of the SRST that are specified in the ATA/ATAPI-4 INCITS T13/1153D Proposed Standard. These *shall* be followed. These are requirements caused because the SRST is a Channel Reset and not a specific device reset.

B-6.5 Device Reset

The Device Reset corresponds to the DEVICE RESET command in the proposed ATA/ATAPI-4 INCITS T13/1153D Standard. In an earlier standard (SFF8020i - expired) the Device Reset was called ATAPI SOFT RESET. The functions of DEVICE RESET and ATAPI SOFT RESET are the same.

The Device Reset is capable of resetting an individual device.

The Device Reset should keep the media-based information such as disc TOC. It is expected that the Device Reset will operate quickly. Host drivers expect that the device will be ready to perform other commands quickly after the Device Reset. It is recommended that all information about a previously installed media be maintained across a Device Reset.

The ATAPI version of Device Reset is different from SCSI. Known differences include:

- Device Reset will immediately reset ATAPI logical protocol sequence. SCSI protocols are not affected by the Device Reset.
- Time constraints on the processing of the reset exist in ATAPI but not the SCSI environments.

B-6.6 Function Comparison Table

Table 841 - Reset Function Comparison

Function	Power-On / Hard Reset	ATA/ATAPI-4 Device Reset	SRST
Initialization sequence required	Yes	No	No
Immediate Bus Release	Yes	Yes	Yes
Mode parameters	Reset to default or saved parameters	No change allowed	No change allowed
Cached Lead-in information	Discarded	Should not re-read Lead-in	Should not re-read Lead-in
Persistent Prevent Flag	Unlocked	No change allowed	No change allowed
Key Management	Reset to Default state	Reset to Default state	No change allowed

B-6.7 Redundant command functionality (Task File vs. Packet)

The SCSI Standard has provided some commands that the ATA Standard also provides. It is the intent of this specification to allow all the functionality to exist, by utilizing only Command Packets. This will allow existing SCSI like drivers to continue to issue packets for all operation, and have some lower level driver convert them to the ATAPI protocol. Unfortunately there are existing low level drivers that would like to continue to use some non data transfer ATA Task File commands. As such both these “Task File” and “Packet” commands will be supported.

B-6.7.1 Door Lock and Door Unlock vs. Prevent / Allow Medium Removal

There exists both an ATA and a Packet method to control the insertion and removal of media. Both of these methods do not provide necessary functionality for the host operating system. It is therefore recommended that both the ATA Lock/Unlock and the Packet Prevent/Allow functions not be implemented by a Multi-Media device. There now exist a new set of commands, both for ATA and for Packet Commands. These commands control a capability called Media Status Notification. As the functionality for the packet and the register based commands are similar, only the Packet versions of the MSN commands *shall* be implemented by Multi-Media devices.

B-6.7.2 ATAPI Identify Drive vs. Inquiry

The ATAPI IDENTIFY DRIVE command has information that the low level drivers use to perform ATA interface hardware configuration. Information in the Identify Drive *shall* continue to look exactly as the ATA Identify Drive does for compatibility reasons. As the information in the Inquiry command cannot be returned by the ATAPI Identify Drive command, the Inquiry command will be supported for use by higher level drivers.

B-6.7.3 Initialize Drive Parameters & Set Features vs. Mode Sense and Mode Select

The INITIALIZE DRIVE PARAMETERS command does not contain a method to provide non ATA device configuration information, and will not be used. As such the Mode Select and Mode Sense from the SCSI standard *shall* be supported. The combination of Mode Select and Set Features commands contain all the necessary functionality and is most compatible with the existing BIOSes and OS Drivers.

B-6.8 ATAPI Device Reset

Note: For performance reasons, a Device reset may not force reading of TOC.

B-6.9 Execute Drive Diagnostics

This command *shall* perform the internal diagnostic tests implemented by the drive. The DRV bit is ignored. Both drives, if present, *shall* perform this command. See the ATA Standard (INCITS T9.2/791D) for more information.

Note: ATAPI device drivers issuing the Execute Diagnostics command will cause all ATA and ATAPI devices to perform a diagnostic command resulting in a device reset. To prevent unwanted resets and or driver compatibility issues, ATAPI drivers should not issue the Execute Diagnostics command. The command is implemented by ATAPI devices for ATA compatibility only.

B-6.10 ATAPI Identify Device

The ATAPI IDENTIFY DEVICE command enables the host to receive parameter information from the drive. For more information see ATA/ATAPI-4 Standard.

B-7 Command Packet Description

An ATAPI command is communicated by sending a Command Packet to the Device. For several commands, the Command Packet is accompanied by a list of parameters sent upon receiving an interrupt following the Command Packet being sent. See the specific commands for detailed information.

The Command Packet always has an Operation Code as its first byte.

For all commands, if there is an invalid parameter in the Command Packet, then the ATAPI Device *shall* abort the command without altering the medium.

Table 842 - Typical Command Packet for Most commands

Bit Byte	7	6	5	4	3	2	1	0
0	Operation Code							
1	Reserved			Reserved				
2	(MSB) Logical Block Address (if required) (LSB)							
3								
4								
5								
6								
7	(MSB) Transfer Length (if required) or Parameter List Length (if required) or Allocation Length (if required) (LSB)							
8								
9								
10	Pad							
11								

Table 843 - Typical Command Packet for Some Extended commands

Bit Byte	7	6	5	4	3	2	1	0
0	Operation Code							
1	Reserved			Reserved				
2	(MSB) Logical Block Address (if required) (LSB)							
3								
4								
5								
6								
7								
8								
9								
10	Reserved							
11	Reserved							

B-7.1 Operation Code

The Operation Code of the Command Packet has a group code field and a command code field. The three-bit group code field provides for eight groups of command codes. The five-bit command code field provides for thirty-two command codes in each group. Thus, a total of 256 possible Operation Codes exist. Operation Codes are defined in the subsequent sections.

Table 844 - Operation Code

Bit	7	6	5	4	3	2	1	0
	Group Code				Command Code			

Note: The Group / Command code fields have been kept for backward compatibility and are not used by ATAPI.

B-7.2 Logical Block Address

The logical block address *shall* begin with block zero and be contiguous up to the last logical block.

B-7.3 Transfer Length

The Transfer Length Field specifies the amount of data to be transferred, usually the number of blocks. For several commands the transfer length indicates the requested number of bytes to be sent as defined in the command description. For these commands the Transfer Length Field may be identified by a different name. See the following descriptions and the individual command descriptions for further information.

In commands that use multiple bytes for the transfer length, a transfer length of zero indicates that no data transfer *shall* take place. A value of one or greater indicates the number of blocks that *shall* be transferred.

B-7.4 Parameter List Length

The Parameter List Length is used to specify the number of bytes to be sent to the Drive. This field is typically used in Command Packets for parameters that are sent to a Drive (e.g., mode parameters, diagnostic parameters). A parameter length of zero indicates that no data *shall* be transferred.

B-7.5 Allocation Length

The Allocation Length Field specifies the maximum number of bytes that a host Computer has allocated for returned data. An allocation length of zero indicates that no data *shall* be transferred. The Drive *shall* terminate the data transfer when allocation length bytes have been transferred or when all available data have been transferred to the host Computer, whichever is less. The allocation length is used to limit the maximum amount of data (e.g., sense data, mode data) returned to a host Computer. When data is truncated, no error is generated, except for the Mechanism Status command that *shall* generate a Parameter List Length Error.

B-8 Status

A Status byte *shall* be sent from the Drive to the host Computer at the completion of each command unless the command is terminated by one of the following events:

1. A hard reset condition.
2. An unexpected event.

Status is normally presented at the end of a command, but in some cases may occur prior to transferring the Command Packet.

ILI bit and EOM bit in the error register are not used in this specification. These bits *shall* be set to zero at the PACKET command completion. Host *shall* take out all error information via sense data.

For a description of the Status Byte see ATA/ATAPI-4.

B-9 Immediate command processing considerations

Immediate commands are a class of commands which return completion status to the host system before they are finished executing the command. The purpose of immediate commands is to allow the host to perform more than one command at a time on the same IDE cable.

In earlier specification (SFF8002i (expired), INF-8090i rev. 3.6) DSC bit was defined to indicate the completion status of the seek operation of immediate commands. But currently DSC bit is replaced by SERV bit for PACKET command overlap feature. About progress indication, refer to each command description and *Section 17.31.1, "Sense-key Specific"* on page 835 and *17.5.6, "Device Busy Class Events"* on page 638.

For Multi-Media device, at the completion of Power-on reset sequence DSC bit is set to zero. When a command is issued this bit *shall* be set to one and remain in this state unless the logical unit supports overlap or command queuing as defined in ATA/ATAPI-4.

B-10 Command processing considerations and exception conditions

The following sections describe some exception conditions and errors associated with command processing and the sequencing of commands.

B-10.1 Selection of an invalid logical unit

The CD-ROM Drive's response to selection of a logical unit that is not valid is described in the following paragraphs. The logical unit may not be valid because:

1. The ATAPI CD-ROM Drive does not support the logical unit. In response to an INQUIRY command, the ATAPI CD-ROM Drive *shall* return the INQUIRY data with the peripheral qualifier set to the value required in *17.7.1, "Standard INQUIRY Data"* on page 655. In response to any other command except REQUEST SENSE, the ATAPI CD-ROM Drive *shall* terminate the command with CHECK CONDITION status. In response to a REQUEST SENSE command, the ATAPI CD-ROM Drive *shall* return sense data. The sense key *shall* be set to ILLEGAL REQUEST and the additional sense code *shall* be set to LOGICAL UNIT NOT SUPPORTED.
2. The ATAPI CD-ROM Drive supports the logical unit, but the peripheral device is not currently attached to the ATAPI CD-ROM Drive. In response to an INQUIRY command, the ATAPI CD-ROM Drive *shall* return the INQUIRY data with the peripheral qualifier set to the value required in *17.7.1, "Standard INQUIRY Data"* on page 655. In response to any other command except REQUEST SENSE, the ATAPI CD-ROM Drive *shall* terminate the command with CHECK CONDITION status. In response to a REQUEST SENSE command, the ATAPI CD-ROM Drive *shall* return sense data. The sense key *shall* be set to ILLEGAL REQUEST and the additional sense code *shall* be set to LOGICAL UNIT NOT SUPPORTED.
3. The ATAPI CD-ROM Drive supports the logical unit and the peripheral device is attached, but not operational. In response to an INQUIRY command, the ATAPI CD-ROM Drive *shall* return the INQUIRY data with the peripheral qualifier set to the value required in *17.7.1, "Standard INQUIRY Data"* on page 655. The ATAPI CD-ROM Drive's response to any command other than INQUIRY and REQUEST SENSE is vendor-specific.

B-10.2 Parameter Rounding

Certain parameters sent to an ATAPI Device with various commands contain a range of values. ATAPI devices may choose to implement only selected values from this range. When the ATAPI Device receives a value that it does not support, it either rejects the command (CHECK CONDITION status with ILLEGAL REQUEST sense key) or it rounds the value received to a supported value. The ATAPI device *shall* reject unsupported values unless rounding is permitted in the description of the parameter.

Rounding of parameter values, when permitted¹, *shall* be performed as follows - An ATAPI device that receives a parameter value that is not an exact supported value *shall* adjust the value to one that it supports and *shall* return CHECK CONDITION status with a sense key of RECOVERED ERROR. The additional sense code *shall* be set to ROUNDED PARAMETER. The host Computer is responsible for issuing an appropriate command to learn what value the ATAPI device has selected.

1. Generally, the ATAPI device should adjust maximum-value fields down to the next lower supported value than the one specified by the host Computer. Minimum-value fields should be rounded up to the next higher supported value than the one specified by the host Computer. In some cases, the type of rounding (up or down) is explicitly specified in the description of the parameter.

B-11 UNIT ATTENTION condition

The ATAPI device *shall* generate a UNIT ATTENTION on each valid logical unit whenever the ATAPI device has been reset by a hard reset condition, or by a power-on reset. The ATAPI device *shall* also generate a UNIT ATTENTION condition on the affected logical unit(s) whenever one of the following events occurs:

1. A removable Disc or Cartridge may have been changed.
2. The version or level of microcode has been changed.
3. INQUIRY or Packet Identify Drive Data has been changed.
4. The mode parameters in effect for the host Computer have been restored from non-volatile memory.
5. Any other event occurs that requires the attention of the host Computer.
6. Any Disc or Cartridge has been manually moved within a Changer.

The ATAPI device may queue UNIT ATTENTION conditions on logical units. After the first UNIT ATTENTION condition is cleared, another UNIT ATTENTION condition may exist (e.g., a power on condition followed by a microcode change condition).

The UNIT ATTENTION condition *shall* persist on the logical unit, until the host Computer clears the condition as described in the following paragraphs.

If an INQUIRY command is received from an host Computer to a logical unit with a pending UNIT ATTENTION condition, the ATAPI device *shall* perform the INQUIRY command and *shall not* clear the UNIT ATTENTION condition.

If a REQUEST SENSE command is received from a host Computer with a pending UNIT ATTENTION condition, then the ATAPI device *shall* either:

1. report any pending sense data and preserve the UNIT ATTENTION condition on the logical unit, or,
2. report the UNIT ATTENTION condition, may discard any pending sense data, and clear the UNIT ATTENTION condition on the logical unit.

If an host Computer issues a command other than GET CONFIGURATION, GET EVENT/STATUS NOTIFICATION, INQUIRY or REQUEST SENSE while a UNIT ATTENTION condition exists for that host, the ATAPI device *shall not* perform the command and *shall* report CHECK CONDITION status unless a higher priority status as defined by the ATAPI device is also pending (e.g., BUSY).

B-12 Commands and Parameters

The ATAPI commands were derived from the SCSI command set.

With the exception of the CD-ROM MSF addressing technique, the interface uses logical rather than physical addressing for all data blocks. Each Device may be interrogated to determine how many blocks it contains. A logical unit may coincide with all or part of a peripheral device.

Commands often implemented on CD/DVD logical units are listed in Table 845.

B-13 SATA Asynchronous Notification

This section describes logical unit implementation if the peripheral Device Type 5 logical unit implements Serial ATA Revision 2.5 or later compliant to this SFF specification and also implements the SATA Asynchronous Notification.

The IDENTIFY PACKET DEVICE information Word 78 bit 5 *shall* be set to 1 to indicate the support of Asynchronous Notification. See Serial ATA specification for further details about IDENTIFY PACKET DEVICE command.

After verifying the logical unit SATA capabilities with the IDENTIFY PACKET DEVICE data, the host may enable the SATA Asynchronous Notification through the SET FEATURES command. See Serial ATA specification for further details about SET FEATURES command.

When the host has enabled the SATA Asynchronous Notification, every time an Event is added to the GESN pool and the NotifyPending variable is zero, the logical unit *shall* set the Set Device Bits FIS Notification 'N' and Interrupt 'I' bits to one. When the NotifyPending variable is one, the logical unit *shall not* set the Set Device Bits FIS Notification 'N'. See Serial ATA specification for further details about the Set Device Bits FIS.

When the logical unit has set the Set Device Bits FIS Notification 'N' and Interrupt 'I' bits to one, the logical unit *shall* also set the NotifyPending variable to one, according to Serial ATA specification. Adding the event to the pool, setting the Set Device Bits FIS Notification 'N' and Interrupt 'I' bits to one and setting the NotifyPending variable to one *shall* be an atomic operation.

The host may send any Register FIS to the logical unit to acknowledge the reception of the Asynchronous Notification. The host to logical unit Register FIS acknowledging the reception of the Asynchronous Notification may be a GET EVENT/STATUS NOTIFICATION command. This host to logical unit Register FIS may also be any other Register FIS. This *shall* not be considered an error. The host should send as this Register FIS or an eventual Register FIS a GET EVENT/STATUS NOTIFICATION command to query the logical unit on the nature of the event that caused the Asynchronous Notification. Upon reception of any Register FIS, whether it is a GET EVENT/STATUS NOTIFICATION command or not, the logical unit *shall* clear the NotifyPending variable to zero, according to Serial ATA specification. See Serial ATA specification for further details about the NotifyPending variable.

Table 845 - Packet Commands for ATAPI Multi-Media devices

Command Description	Opcode	Reference
BLANK	A1h	17.1, on page 539
CLOSE TRACK/SESSION	5Bh	17.2, on page 543
FORMAT UNIT	04h	17.3, on page 549
GET CONFIGURATION	46h	17.4, on page 559
GET EVENT/STATUS NOTIFICATION	4Ah	17.5, on page 629
GET PERFORMANCE	ACh	17.6, on page 643
INQUIRY	12h	17.7, on page 655
LOAD/UNLOAD MEDIUM	A6h	17.8, on page 661
MECHANISM STATUS	BDh	17.9, on page 663
MODE SELECT (10)	55h	17.10, on page 667
MODE SENSE (10)	5Ah	17.11, on page 669
PAUSE/RESUME	4Bh	17.12, on page 697
PLAY AUDIO (10)	45h	17.13, on page 699
PLAY AUDIO MSF	47h	17.14, on page 703
PLAY CD	BCh	Obsolete
PREVENT ALLOW MEDIUM REMOVAL	1Eh	17.15, on page 705
READ (10)	28h	17.16, on page 707
READ (12)	A8h	17.17, on page 709
READ CAPACITY	25h	17.20, on page 717
READ CD	BEh	17.21, on page 719
READ CD MSF	B9h	17.22, on page 729
READ DISC INFORMATION	51h	17.23, on page 731
READ DISC STRUCTURE	ADh	17.24, on page 741
READ FORMAT CAPACITIES	23h	17.25, on page 773
READ HEADER	44h	Obsolete
READ SUBCHANNEL	42h	17.26, on page 779
READ TOC/PMA/ATIP	43h	17.27, on page 787
READ TRACK INFORMATION	52h	17.28, on page 801
REPAIR RZONE	58h	17.29, on page 815
REPORT KEY	A4h	17.30, on page 817
REQUEST SENSE	03h	17.31, on page 833
RESERVE TRACK	53h	17.32, on page 839
SCAN	BAh	17.33, on page 845
SEEK	2Bh	17.34, on page 849
SEND CUE SHEET	5Dh	17.35, on page 851
SEND DISC STRUCTURE	BFh	17.36, on page 859
SEND EVENT	A2h	17.37, on page 873
SEND KEY	A3h	17.38, on page 875
SEND OPC INFORMATION	54h	17.39, on page 883
SET CD SPEED	BBh	17.40, on page 885
SET READ AHEAD	A7h	17.41, on page 887
SET STREAMING	B6h	17.42, on page 889
START STOP UNIT	1Bh	17.43, on page 895
STOP PLAY/SCAN	4Eh	17.44, on page 899
SYNCHRONIZE CACHE (10)	35h	17.45, on page 901

Table 845 - Packet Commands for ATAPI Multi-Media devices (continued)

Command Description	Opcode	Reference
TEST UNIT READY	00h	<i>17.46</i> , on page 903
VERIFY (10)	2Fh	<i>17.47</i> , on page 905
WRITE (10)	2Ah	<i>17.48</i> , on page 907
WRITE (12)	AAh	<i>17.49</i> , on page 911
WRITE AND VERIFY (10)	2Eh	<i>17.50</i> , on page 913

Appendix C - SCSI Implementation Notes (Normative)

C-1 Introduction

This section will describe where possible the use of the contents for SCSI Multi-Media devices. This specification is intended to be used in conjunction with the SCSI-3 Architecture Model (SAM-2), the SCSI-3 Primary Command Set (SPC-2) standard and the SCSI-3 Block Command Set (SBC).

See the INCITS T10 SCSI-3 Specifications for information on the connection and protocol to be use for a SCSI Multi-Media device.

C-2 SCSI Signal Utilization

Multi-Media devices will utilize the same signals and timing from the SCSI Standard and Extensions.

C-3 SCSI Compatibility

C-3.1 Use of the RelAdr bit

The use of the RelAdr bit is obsolete in SPC-3 and SBC-2. The legacy meaning of this bit is as follows.

A relative address (RelAdr) bit of one indicates that the logical block address field is a two's complement displacement. This negative or positive displacement *shall* be added to the logical block address last accessed on the logical unit to form the logical block address for this command. This feature is only available when linking commands. The feature requires that a previous command in the linked group have accessed a block of data on the logical unit.

A RelAdr bit of zero indicates that the logical block address field specifies the first logical block of the range of logical blocks to be operated on by this command.

C-3.2 Differences from the SCSI Standard

Some of the major differences from the SCSI Standard:

- LUN field of command packets (CDB) is used by this specification.
- SYNCHRONIZE CACHE (10) command does not make use of the Logical Block or Number of Blocks fields.
- EVENT STATUS NOTIFICATION replaces the AEN capability in SCSI.
- CHANGE DEFINITION is not used.
- INQUIRY command does not use EVPD or CmdDt CDB bits.
- UNIT ATTENTION with INQUIRY DATA HAS CHANGED is not used.
- Peripheral qualifier in the INQUIRY data is not used.
- The AERC, TrmTsk and NormACA are in conflict with the current definition of the INQUIRY data. This specification specifies the ATAPI Transport version in place of these bits.
- EncServ, MultiP, MChngr, ACKREQQ, Addr32, Addr16, RelAdr, WBus32, WBus16, Sync, Linked, TranDis, CmdQue bits in the INQUIRY data is defined as Reserved in this specification.
- Byte 56 and 57 of the INQUIRY data are used to specify the Major and Minor version the logical unit is compliant with.
- The Mechanism State in this specification uses a value of 3h for the data port in use and not 1h as is specified in the SCSI Standard.
- The PF bit in the MODE SELECT command is specified as always set to 1.
- The DBD bit in the MODE SENSE is specified as being set to one. This bit is allowed to be set to zero only when the logical unit is a legacy SCSI device.
- EER bit of the Read-Write recovery page is not supported by this specification.
- Correction Span, Head offset count, Data strobe offset count, Recovery Time Limit fields of the Read-Write recovery page are not supported by this specification.
- The power model for this specification is different from that described for SCSI.
- LogErr bit in the Information Exceptions mode page is not supported.
- Disconnect/Reconnect, Write Parameter, Verify Error Recovery, Caching, Peripheral Device, Control Mode and Medium Types pages are not supported by this specification.
- DPO bit in the READ command is not supported by this specification.
- Only the READ(12) is supported by this specification.
- The PMI bit of the READ CAPACITY command is not supported by this specification.
- READ CAPACITY command is recommended not to be used by this specification.

C-4 Reset Functionality

This section describes the functionality of the various resets in SCSI.

C-4.1 Power On Reset

The Power On Reset is an event that causes the Power On condition in SCSI. See “Task and Command Lifetimes” in the SCSI Architecture Model standard (SAM-2).

C-4.2 Hard Reset

In SCSI, Hard Reset is mapped as Hard Reset in the SCSI Architecture Model. See “Hard Reset” in SAM-2.

Devices that comply with this specification follow a simple model and the initiator is mapped to the host and a target is mapped to the device. Hard Reset for a SCSI Device will:

- Abort all tasks in all task sets;
- Clear all auto contingent allegiance conditions;
- Release all SCSI device reservations;
- Return any device operating modes to their appropriate initial conditions, similar to those conditions that would be found following device power-on. The MODE SELECT conditions *shall* be restored to their last saved values if saved values have been established. MODE SELECT conditions for which no saved values have been established *shall* be returned to their default values;
- UNIT ATTENTION condition *shall* be set.

C-4.2.1 TARGET RESET task management function

A response to a TARGET RESET task management request, issued by an initiator.

Different from ATA/ATAPI, in SCSI, the TARGET RESET can reset a devices individually. When a SCSI initiator wishes to reset all the devices connected on one cable with TARGET RESET request, the initiator *shall* issue the TARGET RESET task management request to every device.

Note: The TARGET RESET task management function was called a “Bus Device Reset” in SCSI-2.

*Note: The LOGICAL UNIT RESET function is gone from SCSI-3 SAM revision 18. If this function is issued by the host to this a Multi-Media device, the reaction of the device **shall** be same as the TARGET RSET task management function.*

C-4.2.2 Reset Events

A protocol specific event which may trigger a Hard Reset response from a SCSI device.

For example, SIP SCSI-3 Parallel Interface, there's a Reset Service generated by assertion of the RST- (reset) bus signal. This is one of the reset events and is a kind of Task Management Service defined in SIP SCSI-3 Interlocked Protocol specification, as a ULP, upper layer protocol.

SIP: SCSI Interlocked Protocol specification (INCITS T10/856D)

SPI: SCSI Parallel Interface specification (INCITS T10/855D)

Table 846 - Example Hard Reset Implementation

Mt Fuji	Generic SCSI-3 SAM	Example SCSI-3 SIP,SPI
Hard Reset	TARGET RESET task management function	TARGET RESET message
	Reset events	RST bus signal activated

C-4.3 Device Reset

In SCSI, Device Reset is not equivalent with the ATA/ATAPI Device Reset. For SCSI devices there are two possible Device Reset alternatives, ABORT TASK SET or CLEAR TASK SET. The ABORT TASK SET is mandatory for all SCSI devices, but the function is a little different from the ATA/ATAPI Device Reset. The CLEAR TASK SET is not always supported by the SCSI devices that don't support tagged tasks. CLEAR TASK SET is different from ABORT TASK SET in that CLEAR TASK SET clears all the queued tasks for all initiators. If the device is in a single initiator SCSI environment, ABORT and CLEAR TASK SET are the same.

As in ATAPI Device Reset, these “resets” in SCSI don't set to defaults the Mode Parameters, or SCAM functions and does not flush the contents of any cached Lead-in data.

The ABORT/CLEAR TASK SET:

- Does not immediately reset SCSI bus protocol.
- Does not reset parameters in mode page to default values
- Always keep the disc information such as disc TOC information
- Does not change the Persistent Prevent state

Although the host may use the ABORT/CLEAR TASK SET functions to provide a Device Reset, when something is wrong with the SCSI communications it may be necessary for the host to use stronger means, such as Hard Reset (a TARGET RESET or a Reset Event).

Table 847 - Reset Function Comparison

Function	Power-On / Hard Reset	SCSI-3 ABORT/CLEAR TASK SET
Initialization sequence required	Yes	No
Immediate Bus Release	Yes	No
Mode parameters	Reset to default or saved parameters	No change allowed
Cached Lead-in information	Discarded	Not Specified
Persistent Prevent Flag	Unlocked	No change allowed
Key Management	Reset to Default state	Reset to Default state

C-4.3.1 Device Reset Issues for SCSI Devices

The host may generate a Device Reset to bring the hung-up (something wrong or the communication is broken) device back to operation. For this purpose, this will work well in ATAPI. But in SCSI, this may not work well. Even the Hard Reset (a TARGET RESET or a Reset Event) may not work well in SCSI system because these Hard Resets are not always HARDWARE based resets, and it depends on the device design. Thus the application should consider the differences between ATAPI and SCSI environment.

Note: In the SCSI-3 standard, the term "Soft Reset" is no longer defined.

C-4.4 Power management and Device Reset in SCSI

When a SCSI Device is in the Power Managed Sleep state, the SCSI Target Reset *shall* be used to wake the device.

C-5 Command Utilization for a SCSI logical unit

Commands often implemented on CD/DVD logical units are listed in Table 848.

Table 848 - Packet Commands for SCSI Multi-Media Devices

Command Description	Opcode	Reference
BLANK	A1h	17.1, on page 539
CLOSE TRACK/SESSION	5Bh	17.2, on page 543
FORMAT UNIT	04h	17.3, on page 549
GET CONFIGURATION	46h	17.4, on page 559
GET EVENT/STATUS NOTIFICATION	4Ah	17.5, on page 629
GET PERFORMANCE	ACH	17.6, on page 643
INQUIRY	12h	17.7, on page 655
LOAD/UNLOAD MEDIUM	A6h	17.8, on page 661
MECHANISM STATUS	BDh	17.9, on page 663

Table 848 - Packet Commands for SCSI Multi-Media Devices (continued)

Command Description	Opcode	Reference
MODE SELECT (10)	55h	17.10, on page 667
MODE SELECT (6)		SPC
MODE SENSE (10)	5Ah	17.11, on page 669
MODE SENSE (6)		SPC
PAUSE/RESUME	4Bh	17.12, on page 697
PLAY AUDIO (10)	45h	17.13, on page 699
PLAY AUDIO (12)		MMC
PLAY AUDIO MSF	47h	17.14, on page 703
PLAY CD	BCh	Obsolete
PREVENT ALLOW MEDIUM REMOVAL	1Eh	17.15, on page 705
READ (10)	28h	17.16, on page 707
READ (12)	A8h	17.17, on page 709
READ (6)	08h	SBC
READ CAPACITY	25h	17.20, on page 717
READ CD	BEh	17.21, on page 719
READ CD MSF	B9h	17.22, on page 729
READ DISC INFORMATION	51h	17.23, on page 731
READ DISC STRUCTURE	ADh	17.24, on page 741
READ FORMAT CAPACITIES	23h	17.25, on page 773
READ HEADER	44h	Obsolete
READ SUBCHANNEL	42h	17.26, on page 779
READ TOC/PMA/ATIP	43h	17.27, on page 787
READ TRACK INFORMATION	52h	17.28, on page 801
RELEASE		SPC
REPAIR RZONE	58h	17.29, on page 815
REPORT KEY	A4h	17.30, on page 817
REQUEST SENSE	03h	17.31, on page 833
RESERVE		SPC
RESERVE TRACK	53h	17.32, on page 839
SCAN	BAh	17.33, on page 845
SEEK	2Bh	17.34, on page 849
SEND CUE SHEET	5Dh	17.35, on page 851
SEND DIAGNOSTIC		SPC
SEND DISC STRUCTURE	BFh	17.36, on page 859
SEND EVENT	A2h	17.37, on page 873
SEND KEY	A3h	17.38, on page 875
SEND OPC INFORMATION	54h	17.39, on page 883
SET CD SPEED	BBh	17.40, on page 885
SET READ AHEAD	A7h	17.41, on page 887
SET STREAMING	B6h	17.42, on page 889

Table 848 - Packet Commands for SCSI Multi-Media Devices (continued)

Command Description	Opcode	Reference
START STOP UNIT	1Bh	<i>17.43</i> , on page 895
STOP PLAY/SCAN	4Eh	<i>17.44</i> , on page 899
SYNCHRONIZE CACHE (10)	35h	<i>17.45</i> , on page 901
TEST UNIT READY	00h	<i>17.46</i> , on page 903
VERIFY (10)	2Fh	<i>17.47</i> , on page 905
WRITE (10)	2Ah	<i>17.48</i> , on page 907
WRITE (12)	AAh	<i>17.49</i> , on page 911
WRITE AND VERIFY (10)	2Eh	<i>17.50</i> , on page 913

Appendix D - IEEE 1394 Implementation Notes (Normative)

D-1 Introduction

This section will describe where possible the use of the contents for IEEE 1394 devices. This specification is intended to be used in conjunction with IEEE 1394, the SCSI-3 Architecture Model (SAM-2), the Serial Bus Protocol (SBP-2), the SCSI-3 Primary Command Set (SPC-2) standard and the SCSI-3 Block Command Set.

See the INCITS T10 SCSI-3 Specifications for information on the connection and protocol to be use for a SCSI Multi-Media device.

D-2 IEEE 1394 Signal Utilization

logical units *shall* utilize the signals and timing defined in IEEE 1394.

D-3 Compatibility

D-3.1 Use of the RelAdr bit

The use of the RelAdr bit is obsolete in SPC-3 and SBC-2. The legacy meaning of this bit is described as follows.

A relative address (RelAdr) bit of one indicates that the logical block address field is a two's complement displacement. This negative or positive displacement *shall* be added to the logical block address last accessed on the logical unit to form the logical block address for this command. This feature is only available when linking commands. The feature requires that a previous command in the linked group have accessed a block of data on the logical unit.

A RelAdr bit of zero indicates that the logical block address field specifies the first logical block of the range of logical blocks to be operated on by this command.

D-3.2 Comparison of SBP-2 and MMC-2

Some of the major differences between MMC-2 and SCSI or SBC-2:

- EVENT STATUS NOTIFICATION replaces unsolicited status.
- CHANGE DEFINITION is not used.
- INQUIRY command does not use EVPD or CmdDt CDB bits.
- UNIT ATTENTION with INQUIRY DATA HAS CHANGED is not used.
- Peripheral qualifier in the INQUIRY data is not used.
- The PF bit in the MODE SELECT (10) command is specified as always set to 1.
- The power model for this specification is different from that described for IEEE 1394.

D-4 Reset Functionality

This section describes the functionality of the various resets in IEEE 1394.

D-4.1 Power On Reset

The Power On Reset is an event that causes the Power On condition in IEEE 1394. See “Task and Command Lifetimes” in the SCSI Architecture Model standard (SAM-2).

D-4.2 Hard Reset

In IEEE 1394, Hard Reset is mapped as Hard Reset in the SCSI Architecture Model. See “Hard Reset” in SAM-2.

Devices that comply with this specification follow a simple model and the initiator is mapped to the host and a target is mapped to the logical unit. Hard Reset for a IEEE 1394 logical unit will:

- Abort all tasks in all task sets;
- Clear all auto contingent allegiance conditions;
- Release all device reservations;
- Return any device operating modes to their appropriate initial conditions, similar to those conditions that would be found following device power-on. The MODE SELECT (10) conditions *shall* be restored to their last saved values if saved values have been established. MODE SELECT (10) conditions for which no saved values have been established *shall* be returned to their default values;
- UNIT ATTENTION condition *shall* be set.

D-4.2.1 TARGET RESET task management function

A response to a TARGET RESET task management request, issued by an initiator.

Different from ATA/ATAPI, in IEEE 1394, the TARGET RESET can reset a devices individually. When a host wishes to reset all the devices connected on one cable with TARGET RESET request, the host *shall* issue the TARGET RESET task management request to every device.

Note: The TARGET RESET task management function was called a “Bus Device Reset” in SCSI-2.

Note: The LOGICAL UNIT RESET function is gone from SCSI-3 SAM revision 18. If this function is issued by the host to this a Multi-Media device, the reaction of the device shall be same as the TARGET RSET task management function.

D-4.3 Device Reset

In IEEE 1394, Device Reset is not equivalent with the ATA/ATAPI Device Reset. For IEEE 1394 devices there are two possible Device Reset alternatives, ABORT TASK SET or CLEAR TASK SET. The ABORT TASK SET is mandatory for all IEEE 1394 devices, but the function is a little different from the ATA/ATAPI Device Reset. The CLEAR TASK SET is not always supported by the IEEE 1394 devices that don't support tagged tasks. CLEAR TASK SET is different from ABORT TASK SET in that CLEAR TASK SET clears all the queued tasks for all initiators. If the device is in a single initiator IEEE 1394 environment, ABORT and CLEAR TASK SET are the same.

As in ATAPI Device Reset, these “resets” in IEEE 1394 don't set to defaults the Mode Parameters and does not flush the contents of any cached Lead-in data.

The ABORT/CLEAR TASK SET:

- Does not immediately reset IEEE 1394 bus protocol.
- Does not reset parameters in mode page to default values
- Always keep the disc information such as disc TOC information
- Does not change the Persistent Prevent state

Although the host may use the ABORT/CLEAR TASK SET functions to provide a Device Reset, when something is wrong with the IEEE 1394 communications it may be necessary for the host to use stronger means, such as Hard Reset (a TARGET RESET or a Reset Event).

Table 849 - Reset Function Comparison

Function	Power-On / Hard Reset	IEEE 1394 ABORT/CLEAR TASK SET
Initialization sequence required	Yes	No
Immediate Bus Release	Yes	No
Mode parameters	Reset to default or saved parameters	No change allowed
Cached Lead-in information	Discarded	Not Specified
Persistent Prevent Flag	Unlocked	No change allowed
Key Management	Reset to Default state	Reset to Default state

D-4.3.1 Device Reset Issues for IEEE 1394 Devices

The host may generate a Device Reset to bring the hung-up (something wrong or the communication is broken) device back to operation. For this purpose, this will work well in ATAPI. But in IEEE 1394, this may not work well. Even the Hard Reset (a TARGET RESET or a Reset Event) may not work well in IEEE 1394 system because these Hard Resets are not always HARDWARE based resets, and it depends on the device design. Thus the application should consider the differences between ATAPI and IEEE 1394 environment.

Note: In the SCSI-3 standard, the term "Soft Reset" is no longer defined.

D-4.4 Power management and Device Reset in IEEE 1394

When a IEEE 1394 Device is in the Power Managed Sleep state, a Target Reset *shall* be used to wake the device.

D-5 Command Utilization for a IEEE 1394 logical unit**Table 850 - Packet Commands for IEEE 1394 Multi-Media Devices**

Command Description	Opcode	Reference
BLANK	A1h	17.1, on page 539
CLOSE TRACK/SESSION	5Bh	17.2, on page 543
FORMAT UNIT	04h	17.3, on page 549
GET CONFIGURATION	46h	17.4, on page 559
GET EVENT/STATUS NOTIFICATION	4Ah	17.5, on page 629
GET PERFORMANCE	ACh	17.6, on page 643
INQUIRY	12h	17.7, on page 655
LOAD/UNLOAD MEDIUM	A6h	17.8, on page 661
MECHANISM STATUS	BDh	17.9, on page 663
MODE SELECT (10)	55h	17.10, on page 667
MODE SELECT (6)		SPC
MODE SENSE (10)	5Ah	17.11, on page 669
MODE SENSE (6)		SPC
PAUSE/RESUME	4Bh	17.12, on page 697
PLAY AUDIO (10)	45h	17.13, on page 699
PLAY AUDIO (12)		MMC
PLAY AUDIO MSF	47h	17.14, on page 703
PLAY CD	BCh	Obsolete
PREVENT ALLOW MEDIUM REMOVAL	1Eh	17.15, on page 705

Table 850 - Packet Commands for IEEE 1394 Multi-Media Devices

Command Description	Opcode	Reference
READ (10)	28h	17.16, on page 707
READ (12)	A8h	17.17, on page 709
READ (6)	08h	SBC
READ CAPACITY	25h	17.20, on page 717
READ CD	BEh	17.21, on page 719
READ CD MSF	B9h	17.22, on page 729
READ DISC INFORMATION	51h	17.23, on page 731
READ DISC STRUCTURE	ADh	17.24, on page 741
READ FORMAT CAPACITIES	23h	17.25, on page 773
READ HEADER	44h	Obsolete
READ SUBCHANNEL	42h	17.26, on page 779
READ TOC/PMA/ATIP	43h	17.27, on page 787
READ TRACK INFORMATION	52h	17.28, on page 801
RELEASE		SPC
REPAIR RZONE	58h	17.29, on page 815
REPORT KEY	A4h	17.30, on page 817
REQUEST SENSE	03h	17.31, on page 833
RESERVE		SPC
RESERVE TRACK	53h	17.32, on page 839
SCAN	BAh	17.33, on page 845
SEEK	2Bh	17.34, on page 849
SEND CUE SHEET	5Dh	17.35, on page 851
SEND DIAGNOSTIC		SPC
SEND DISC STRUCTURE	BFh	17.36, on page 859
SEND EVENT	A2h	17.37, on page 873
SEND KEY	A3h	17.38, on page 875
SEND OPC INFORMATION	54h	17.39, on page 883
SET CD SPEED command	BBh	17.40, on page 885
SET READ AHEAD	A7h	17.41, on page 887
SET STREAMING	B6h	17.42, on page 889
START STOP UNIT	1Bh	17.43, on page 895
STOP PLAY/SCAN	4Eh	17.44, on page 899
SYNCHRONIZE CACHE (10)	35h	17.45, on page 901
TEST UNIT READY	00h	17.46, on page 903
VERIFY (10)	2Fh	17.47, on page 905
WRITE (10)	2Ah	17.48, on page 907
WRITE (12)	AAh	17.49, on page 911
WRITE AND VERIFY (10)	2Eh	17.50, on page 913

Appendix E - Example Event Implementation Notes (Informative)

E-1 Design Intent

E-1.1 Goals

The set of commands used with Morphing was designed to eliminate the use of errors for the communication of errors and normal device events to the host. The use of event reporting allows errors to be used to communicate true errors - i.e. illegal usage or medium defects. The use of events may help reduce the amount of error handling code in host software.

The implementation described here replaces the Asynchronous Event Notification defined in SCSI. AEN was not widely supported, as it would require a change in architecture of most OS to allow unsolicited messages from the peripheral. In particular, the OS would have to decide to which process an unsolicited message belonged. There were other inhibiting factors also. For example, there is no low level protocol for a peripheral to send an unsolicited message.

E-1.2 Command Use

The GET EVENT/STATUS NOTIFICATION command has two modes of operation. The first is the non-immediate mode. This is the preferred method of operation. Non-immediate mode means that the command will complete as soon as an event occurs. Effectively, a message can be sent at any time to the host because it has been solicited. However, this method of operation is not feasible if command queuing and overlap are not possible. Current ATAPI implementations do not support queuing nor overlap, so the immediate mode must be used.

The Immediate mode allows the host to periodically poll the device to find events and examine status. This technique should be used only in environments where queuing is not possible.

E-1.3 Implementation Hints

Events are not required to be queued, nor is generation of events blocked due to the occurrence of a new event. What this means is that an implementation can set aside an event variable and a status variable for each event class it supports. Each section of code that needs to generate an event can simply overwrite any event that exists in the same class.

E-1.4 Interactions with UNIT ATTENTION

The GET EVENT/STATUS NOTIFICATION command specifies that any associated UNIT ATTENTION not be cleared when an Event is reported to the host. Therefore, no changes to sense generation or reporting are required.

E-1.5 Sample Implementation of Events

The following code shows how events might be implemented in C.

```
typedef struct _sEventData {
    UInt8      Event;
    UInt8      Status;
    UInt16     EventData;
} sEventData;

sEventData EventData[8];          /* One per event class */

Set_Event(EventClass, Event, Status, EventData)
{
    EventData[EventClass].Event = Event
    EventData[EventClass].Status = Status;
    EventData[EventClass].EventData = EventData;
    Do_Synchronous_Event_Notification(EventClass);          /*This completes any
        pending GET EVENT/STATUS NOTIFICATION commands in the queue */
}
```

None of these routines checks for existing Events. Any old Event is simply replaced with the new one.

The GET EVENT/STATUS NOTIFICATION command would report the EventData structure for the highest priority (lowest number) requested event and then clear that Event.

Appendix F - Command Implementation Notes (Informative)

F-1 READ DISC INFORMATION or READ TRACK INFORMATION command

This section explains what information *shall* return when READ DISC INFORMATION or READ TRACK INFORMATION command is issued for media to a read-only logical unit.

The READ DISC INFORMATION and READ TRACK INFORMATION commands are originally designed for writable logical unit. A Read Only logical unit *shall* also return the information of the mounted media appropriately when READ DISC INFORMATION and READ TRACK INFORMATION command is issued.

F-1.1 Returned data for CD media

For Read Only logical unit, the interpretation of the status of CD media which has one or more complete session is based on followings:

- Disc Status is always treated as “Complete” even if there is incomplete session on the disc.
- Last Session is considered to be the Complete Session closed at the end even if there is an incomplete session exists following the complete session. The incomplete session which has not been closed by writable logical unit is not considered to return disc/track status. Only the information on Complete Session(s) on the disc *shall* be returned.
- Number of Session is the total of closed Complete Sessions.
- All the values of PMA are invalid because Read Only logical unit does not have capability to read PMA.

If the disc of which 1st session is not complete is inserted into Read Only logical unit, appropriate error *shall* be returned. And media access commands *shall* report BLANK CHECK when a Blank disc is loaded.

Figure 226 shows an example of CD recorded/stamped media. (Session 1 and session 2 are both completed. Session 3 is incomplete status. Each session has some tracks.)

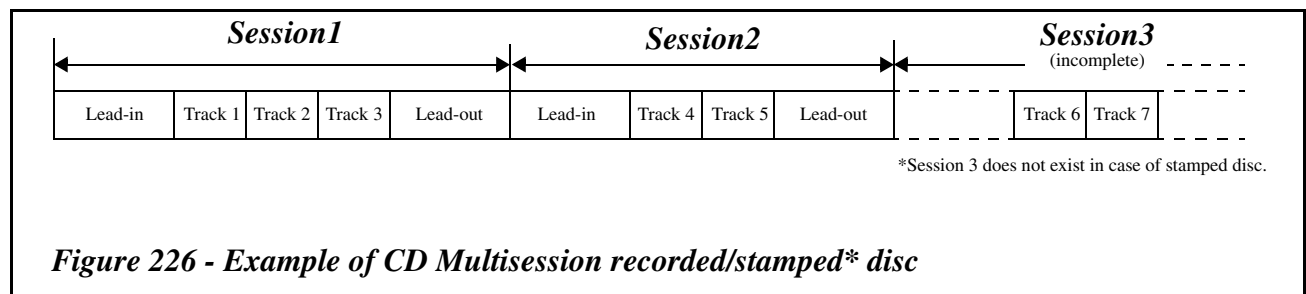


Table 851 shows the example of data returned, when the READ DISC INFORMATION command is issued for the above media.

Table 851 - Example of READ DISC Information returned for CD media

Inserted media Disc Information field	CD-ROM/R/RW disc
Erasable	0 or 1 ^a
Status of Last Session	11b (Complete Session)
Disc Status	10b (Complete Disc)
Number of First track on Disc	1 ^b
Number of Sessions	2 ^b
First Track Number in Last Session	4 ^b
Last Track Number in Last Session	5 ^b
DID_V	0
DBC_V	0
URU	invalid
Disc Type	from A0/PSEC field in the TOC of the first Session in which there is at least one data track
Disc Identification	invalid
Lead-in Start Time for Last Session (MSF)	FF:FF:FF
Last Possible Start Time for Start of Lead-out (MSF)	FF:FF:FF
Disc Bar Code	invalid

- a. If logical unit can detect the Erasable media, this field may be set to 1, otherwise the field is set to 0.
b. In the case of *"Figure 226 - Example of CD Multisession recorded/stamped* disc"* on page 965.

There are some kinds of writing method of recording data in CD media. Disc At Once, Session At Once, Track At Once, and Packet Writing are used as the method of recording CD media. The Packet Writing can be classified into Variable Packet Writing and Fixed Packet Writing.

The Packet layout for CD media is shown in Figure 3 - *Packet Layout* on page 79. Each packet starts with Link block followed by four Run-in blocks. The User data blocks are placed directly after the Run-in blocks. Finally two Run-out blocks are located following the User data blocks. In the case of Fixed packet writing, the size of User Data blocks is always constant in length.

For CD media, there are two kinds of addressing method. Except for the space within a Fixed Packet written track, the logical block number has a one-to-one relationship to the physical block number. Such kind of addressing method is called "Method 1 Addressing" and logical block numbers are also assigned to Link, Run-in, and Run-out blocks. On the other hand, in the Fixed Packet written track, the logical block number has a linear relationship to the physical block number using the special addressing method called "Method 2 Addressing". In this case, Logical Block numbers are not assigned to Link, Run-in, and Run-out blocks.

When the READ TRACK INFORMATION command is issued for CD media, Table 852 shows the example of data returned for the command.

Table 852 - Example of READ TRACK INFORMATION returned for CD media

Track type Track Information field	Stamped track/ DAO written track/ Audio track	TAO ^a written data track	Variable Packet written data track	Fixed Packet written data track
Damage	0	0	0	0
Copy	0	0	0	0
Track Mode	from Q sub-channel of this track			
RT	0 or 1 ^b	0 or 1	0 or 1	0 or 1
Blank	0	0	0	0
Packet	0	0	1	1
FP	0	0	0	1
Data Mode	Fh	1h or 2h	1h or 2h	1h or 2h
NWA_V	0	0	0	0
Track Start Address	from TOC	from TOC	from TOC	from TOC
Next Writable Address	0	0	0	0
Free Blocks	0	0	0	0
Fixed Packet Size	0	0	0	from TDB ^c
Track Size	See below			

- a. TAO: Track At Once recording
b. If it can be considered the disc as stamped disc, this field is set to 0.
c. TDB: Track Descriptor Block

Note: In order to distinguish if the medium is Disc At Once recorded/Stamped, the logical unit should read the pre-gap of the first data track. If a TDB is written, the media is Track At Once or Packet written media. If no TDB is written, the media is Disc At Once recorded or Stamped media.

The track size is different according to the difference of the writing method. The Track Size **shall** be computed as follows:

First, compute the Complete Track Size (CTS). For Read Only logical unit, CTS for the track which has a track number n is computed as follows.

$$CTS(n) = TrackStartAddress(n + 1) - TrackStartAddress(n)$$

Where $TrackStartAddress(n)$ means Track Start address of the track which has a track number n . The value is encoded in the TOC. If the track number n is the last track number of the session, $TrackStartAddress(n+1)$ means the Lead-out start address.

For Disc At Once written media, $TrackSize(n) = CTS(n)$

Where $TrackSize(n)$ means track size of the track which has a track number n .

For Track At Once written track or Variable packet written track, $TrackSize(n) = CTS(n) - PreGapLength(n + 1) - 2$

Where $PreGapLength(n)$ means the Pre-gap length of the track which has track number n . When the Pre-gap has no TDB or the logical unit does not read the TDB, $PreGapLength(n)$ is treated as always 150 even if the actual $PreGapLength(n)$ is not 150¹. If the track number n is the last track, $PreGapLength(n+1)$ is 0.

For Fixed Packet written track, $TrackSize(n) = \frac{CTS(n) - PreGapLength(n + 1) + 5}{PacketSize(n) + 7} \bullet PacketSize(n)$

1. This may cause an incorrectly computed result.

If $TrackStartAddress(n)$ is the last track start address of the session, then $TrackStartAddress(n+1)$ is start address of the Lead-out and $PreGapLength(n+1)$ is zero. $PacketSize(n)$ is the number of User Data Blocks in the fixed packet and is encoded in the Pre-gap as required by the Orange Book Part-II & Part-III¹. Figure 4 - *Example of Packet written Track layout* on page 80 shows example of the layout of packet written track.

F-1.2 Returned data for DVD media

The READ DISC INFORMATION and READ TRACK INFORMATION returned data includes the RZone/Border information for DVD media. However, there is no concept of RZone/Border in DVD-ROM/RAM media. For DVD-ROM or formatted DVD-RAM media, to respond to this command appropriately, the Data Area is considered to be one RZone which has RZone number one and the number of Border is considered to be one.

For Read Only logical unit, the interpretation of the status of DVD media which has one or more complete Border is based on followings:

- Disc Status is always treated as “Complete” even if there is incomplete Border on the disc.
- Last Border is considered to be the Complete Border closed at the end even if there is an incomplete Border exists following the complete Border. The incomplete Border which has not been closed by writable logical unit is not considered to return disc/RZone status. Only the information on Complete Border(s) on the disc *shall* be returned.
- The RZone number of the first RZone is one.
- Number of Border is the total of closed Complete Borders.

If the blank disc or the disc which has no complete Border is inserted into Read Only logical unit, appropriate error *shall* be returned. And media access commands *shall* report BLANK CHECK when a Blank disc is loaded.

Figure 227 shows one example of DVD-R recorded media. (Border 1 and Border 2 are both completed. Border 3 is incomplete status. Each Border has some RZones.)

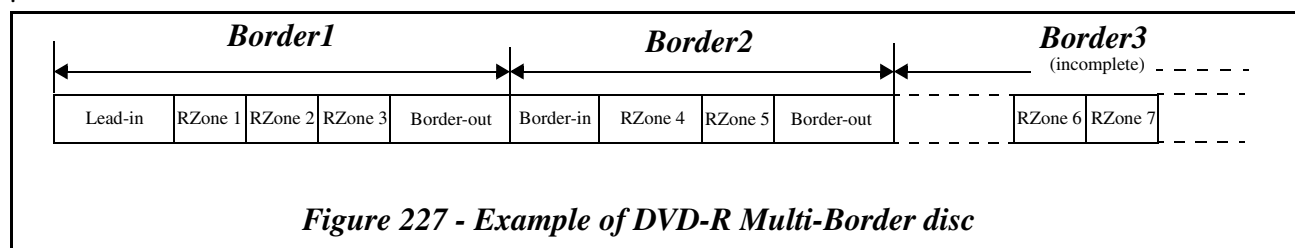


Table 853 shows the example of data returned, when the READ DISC INFORMATION command is issued for the above media. The returned data for DVD-ROM/-RAM disc are also shown in the same table.

Table 853 - Example of READ DISC Information returned for DVD media

Media Type Disc Information field	DVD-R disc	DVD-ROM disc	DVD-RAM disc
Erasable	0	0	1
Status of Last Session/Border	11b (Complete)	11b (Complete)	11b (Complete)
Disc Status	10b (Complete disc)	10b (Complete disc)	10b (Complete disc)
Number of First RZone on Disc	1	1	1
Number of Borders	2 ^a	1	1
First RZone Number in Last Border	4 ^a	1	1
Last RZone Number in Last Border	5 ^a	1	1

1. Specifications developed by Philips & Sony Corp.

Table 853 - Example of READ DISC INFORMATION returned for DVD media

Media Type Disc Information field	DVD-R disc	DVD-ROM disc	DVD-RAM disc
DID_V	0	0	0
DBC_V	0	0	0
URU	invalid	invalid	invalid
Disc Type	invalid	invalid	invalid
Disc Identification	invalid	invalid	invalid
Lead-in Start Time for Last Session (MSF)	invalid	invalid	invalid
Last Possible Start Time for Start of Lead-out (MSF)	invalid	invalid	invalid
Disc Bar Code	invalid	invalid	invalid

a. In the case of "Figure 227 - Example of DVD-R Multi-Border disc" on page 968.

To get the RZone status of DVD media, the READ TRACK INFORMATION command *shall* be used. There are two kinds of writing method of recording data in DVD-R media. Disc At Once and Incremental recording are used as the method of recording DVD media.

For Read Only logical unit, the interpretation of the RZone status is shown in Table 854.

Table 854 - Example of READ TRACK INFORMATION returned for DVD media

RZone type Track Information Field	DVD-ROM/DVD-RAM/ DAO written RZone	Incremental written RZone
Damage	0	0
Copy	invalid	invalid
Track Mode	invalid	invalid
RT	0 or 1 ^a	1
Blank	0	0
Packet/Inc	0	1
FP	invalid	invalid
Data Mode	invalid	invalid
NWA_V	0	0
RZone Start Address	0	from RMD in Border-out
Next Writable Address	invalid	invalid
Free Blocks	0	0
Blocking Factor	16	16
RZone Size	from Lead-in	from RMD in Border-out

a. If it can be considered the disc as ROM or RAM disc, this field is set to 0.

F-1.3 Returned data for HD DVD media

The READ DISC INFORMATION and READ TRACK INFORMATION returned data includes the RZone/Border information for HD DVD media. However, there is no concept of RZone/Border in HD DVD-ROM/RAM media. For HD DVD-ROM or formatted HD DVD-RAM media, to respond to this command appropriately, the Data Area is considered to be one RZone which has RZone number one and the number of Border is considered to be one. For HD DVD-R DL media, the number of Border is limited to one.

For Read Only logical unit, the interpretation of the status of HD DVD media which has one or more complete Border is based on followings:

- Disc Status is always treated as “Complete” even if there is incomplete Border on the disc.
- Last Border is considered to be the Complete Border closed at the end even if there is an incomplete Border exists following the complete Border. The incomplete Border which has not been closed by writable logical unit is not considered to return disc/RZone status. Only the information on Complete Border(s) on the disc *shall* be returned.
- The RZone number of the first RZone is one.
- Number of Border is the total of closed Complete Borders.

If the blank disc or the disc which has no complete Border is inserted into Read Only logical unit, appropriate error *shall* be returned. And media access commands *shall* report BLANK CHECK when a Blank disc is loaded.

Figure 228 shows one example of HD DVD-R SL recorded media. (Border 1 and Border 2 are both completed. Border 3 is incomplete status. Each Border has some RZones.)

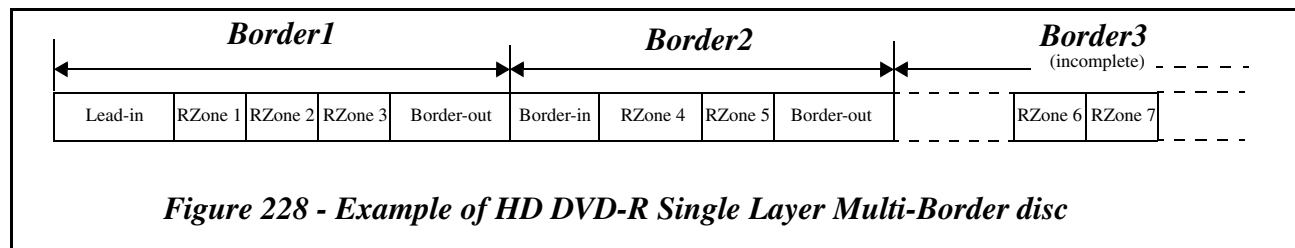


Table 855 shows the example of data returned, when the READ DISC INFORMATION command is issued for the above media. The Returned data for HD DVD-ROM/-RAM/-R disc are also shown in the same table.

Table 855 - READ DISC INFORMATION returned value for HD DVD media

Media Type Disc Information field	HD DVD-R SL disc	HD DVD-R DL disc	HD DVD-ROM disc	HD DVD-RAM disc
Erasable	0	0	0	1
Status of Last Session/Border	11b (Complete)	11b (Complete)	11b (Complete)	11b (Complete)
Disc Status	10b (Complete disc)	10b (Complete disc)	10b (Complete disc)	10b (Complete disc)
Number of First RZone on Disc	1 (Const)	1 (Const)	1 (Const)	1 (Const)
Number of Borders	A ^a	1 (Const)	1 (Const)	1 (Const)
First RZone Number in Last Border	B ^a	1 (Const)	1 (Const)	1 (Const)
Last RZone Number in Last Border	C ^a	D ^b	1 (Const)	1 (Const)
DID_V	invalid	invalid	invalid	invalid
DBC_V	invalid	invalid	invalid	invalid
URU	invalid	invalid	invalid	invalid
Disc Type	invalid	invalid	invalid	invalid
Disc Identification	invalid	invalid	invalid	invalid
Lead-in Start Time for Last Session (MSF)	invalid	invalid	invalid	invalid
Last Possible Start Time for Start of Lead-out (MSF)	invalid	invalid	invalid	invalid
Disc Bar Code	invalid	invalid	invalid	invalid

- a. In the case of "Figure 228 - Example of HD DVD-R Single Layer Multi-Border disc" on page 970, the value A is '2', B is '4', C is '5'.
- b. The value D is 'Last RZone Number'.

To get the RZone status of HD DVD media, the READ TRACK INFORMATION command *shall* be used.

For Read Only logical unit, the interpretation of the RZone status is shown in Table 856.

Table 856 - READ TRACK INFORMATION returned value for HD DVD media

RZone type Track Information Field	HD DVD-ROM/ HD DVD-RAM	HD DVD-R SL	HD DVD-R DL
Damage	0	0	0
Copy	invalid	invalid	invalid
Track Mode	invalid	invalid	invalid
RT	0	0	0
Blank	0	0	0
Packet/Inc	0	1	1
FP	invalid	invalid	invalid
Data Mode	invalid	invalid	invalid
NWA_V	0	0	0
RZone Start Address	0	from RMD in the last Border-out	from R-PFI in Data Lead-in
Next Writable Address	invalid	invalid	invalid
Free Blocks	0	0	0
Blocking Factor	32	32	32
RZone Size	from Lead-in	from RMD in the last Border-out	from R-PFI in Data Lead-in

F-2 GET PERFORMANCE command Performance (Type field = 00h)

This section explains what information should return when GET PERFORMANCE command Performance (Type field = 00h) is issued for media to a logical unit that supports writing on the mounted medium. Host may use the returned data to predict a burning time before start writing.

Table 857 is the returned value example of the 4X-6X CAV, 6X CLV combination CD-R writing speed profile.

Table 857 - 4X - 6X CAV, 6X CLV combination 650MB CD-R writing speed profile

Bit Byte	7	6	5	4	3	2	1	0
0 - 3	Performance Data Length =36							
4	Reserved						Write =1	Except =0
5 - 7	Reserved							
8 - 11	Start LBA =0							
12 - 15	Start Performance = 705600							
16 - 19	End LBA =88500							
20 - 23	End Performance =1058400							
24 - 27	Start LBA =88501							
28 - 31	Start Performance = 1058400							
32 - 35	End LBA =317381							
36 - 39	End Performance =1058400							

Table 858 is the returned value example of the 40X CAV CD-R writing speed profile.

Table 858 - 40X CAV 650MB CD-R writing speed profile

Bit Byte	7	6	5	4	3	2	1	0
0 - 3	Performance Data Length =20							
4	Reserved						Write =1	Except =0
5 - 7	Reserved							
8 - 11	Start LBA =0							
12 - 15	Start Performance = 3001700							
16 - 19	End LBA =317381							
20 - 23	End Performance =7060000							

Table 859 is the returned value example of the 10X-16X-20X-24X Zone CLV CD-R writing speed profile.

Table 859 - 10X-16X-20X-24X ZCLV 650MB CD-R writing speed profile

Bit Byte	7	6	5	4	3	2	1	0
0 - 3	Performance Data Length =68							
4	Reserved						Write =1	Except =0
5 - 7	Reserved							
8 - 11	Start LBA =0							
12 - 15	Start Performance = 1765000							
16 - 19	End LBA =73168							
20 - 23	End Performance =1765000							
24 - 27	Start LBA =73169							
28 - 31	Start Performance = 2824000							
32 - 35	End LBA =152665							
36 - 39	End Performance =2824000							
40 - 43	Start LBA =152666							
44 - 47	Start Performance = 3530000							
48 - 51	End LBA =249849							
52 - 55	End Performance =3530000							
56 - 59	Start LBA =249850							
60 - 63	Start Performance = 4236000							
64 - 67	End LBA =317381							
68 - 71	End Performance =4236000							

Table 860 is the returned value example of the 16X CAV DVD-R writing speed profile.

Table 860 - 16X CAV 4.7GB DVD-R writing speed profile

Bit Byte	7	6	5	4	3	2	1	0
0 - 3	Performance Data Length =20							
4	Reserved						Write =1	Except =0
5 - 7	Reserved							
8 - 11	Start LBA =0							
12 - 15	Start Performance = 9170000							
16 - 19	End LBA =2294921							
20 - 23	End Performance =22160000							

Table 859 is the returned value example of the 2X-4X-6X-8X Zone CLV DVD-R writing speed profile.

Table 861 - 2X-4X-6X-8X ZCLV 4.7GB DVD-R writing speed profile

Bit Byte	7	6	5	4	3	2	1	0
0 - 3	Performance Data Length =68							
4	Reserved						Write =1	Except =0
5 - 7	Reserved							
8 - 11	Start LBA =0							
12 - 15	Start Performance = 2770000							
16 - 19	End LBA =127754							
20 - 23	End Performance =2770000							
24 - 27	Start LBA =127755							
28 - 31	Start Performance = 5540000							
32 - 35	End LBA =877887							
36 - 39	End Performance =5540000							
40 - 43	Start LBA =877888							
44 - 47	Start Performance = 8310000							
48 - 51	End LBA =1927997							
52 - 55	End Performance =8310000							
56 - 59	Start LBA =1927998							
60 - 63	Start Performance = 11080000							
64 - 67	End LBA =2294921							
68 - 71	End Performance =11080000							

Appendix G - CD-Text Format in the Lead-in Area (Informative)

This annex explains the CD-Text information that is stored in the Lead-in Area as raw R-W Sub-channel data. The information here is stored in a memory and can be retrieved to the Initiator immediately.

G-1 General

The CD-Text information in the Lead-in Area is retrieved from raw R-W Sub-Channel data. The data format of RAW Sub-channel is explained in Table 577 - *P-W Raw* on page 727. 6 bits of each byte are R-W Raw data and are converted from 6 bits to 8 bits from the 1st bytes, thus making 4 chunks of 18 bytes of data each. Each 18 byte data block is called CD-Text Pack Data as shown in Table 862. CD-Text information is recorded repeatedly in the Lead-in Area and this one repeated data is called the Text Group. Each Text Group consists of up to 8 types of language Blocks. Each Block represents one language and consists of a maximum of 255 sets of Pack Data. Table 862 shows the contents of one Pack Data.

Table 862 - CD-Text Pack Data format for the Lead-in Area

Bit Byte	7	6	5	4	3	2	1	0
0	Pack Type Indicator							
1	EF	Track Number Indicator						
2	Sequence Number Indicator							
3	DBCC	Block Number			Character Position			
4	Text Data Field byte 0							
5	Text Data Field byte 1							
6	Text Data Field byte 2							
7	Text Data Field byte 3							
8	Text Data Field byte 4							
9	Text Data Field byte 5							
10	Text Data Field byte 6							
11	Text Data Field byte 7							
12	Text Data Field byte 8							
13	Text Data Field byte 9							
14	Text Data Field byte 10							
15	Text Data Field byte 11							
16	CRC Field byte 0 or Reserved							
17	CRC Field byte 1 or Reserved							

Each Data Pack consists of a four byte Header Field, twelve bytes of Text Data and a CRC Field.

The Pack Type Indicator has the value and descriptions defined in Table 863. Packs *shall* be encoded in the order of the items listed in the Table.

Table 863 - Pack Type Indicator Definitions

Pack Type	Description
80h	Title of Album name(ID2=00h) or Track Titles (ID2=01h...63h)
81h	Name(s) of the performer(s) (in ASCII)
82h	Name(s) of the songwriter(s) (in ASCII)
83h	Name(s) of the composer(s) (in ASCII)
84h	Name(s) of the arranger(s) (in ASCII)
85h	Message(s) from content provider and/or artist (in ASCII)
86h	Disc Identification information
87h	Genre Identification and Genre information
88h	Table of Content information
89h	Second Table of Content information
8Ah	Reserved
8Bh	Reserved
8Ch	Reserved
8Dh	Reserved for content provider only
8Eh	UPC/EAN code of the album and ISRC code of each track
8Fh	Size information of the Block

The Extension Flag (EF) bit is normally set to 0b. If it is set to 1b, the Pack is used for an extended application.

The Track Number Indicator field contains the Track Number or Pack Element Number. A Track Number is used when the Text Data Fields belongs to a track. If the Pack is independent of Tracks, this field indicates Pack Element Number which depends on the type of the Pack.

The Sequence Number Indicator is the number incrementally increased from the first Pack to the end in each Block. It starts from 00h to FFh.

The DBCC (Double Byte Character Code) bit, when set to one, indicates that the Text Data Field contains a Double Byte Character Code. When set to 0b, the Single Byte Character Code is used.

The Block Number field indicates the Block Number of the Block to which the Pack belongs. A Block is used to indicate a set of text information representing one particular language. Up to 8 can be used at the same time.

The Character Position field is the number of characters in the strings that belong to the Text Data Field in the previous Pack. The Character Position starts from 0 to 15, and 15 indicates that the first character belongs to the one before the previous Pack. When the character code is double byte code, a set of 2 bytes in the Text Data Field is counted at one.

A null code is also counted as a character, which indicates termination of each string.

Character Position is not used in Packs with ID1=88h, 89h and 8Fh. 00h *shall* be used in all these Packs.

A Text Data Field consists of 12 bytes. It contains either character strings or binary information depending on the type of Pack. All data in this field *shall* be transferred as recorded on the disc.

Packs except Pack Types 88h, 89h and 8Fh *shall* contain character strings in the Text Data Field. If Packs with Pack Type 80h to 85h, and 8Eh are used, a character string for each track *shall* be provided.

A character string consists of series of characters and a terminator (One null code for single byte, two null codes for double byte)

The size of a character string is recommended to be less than 160 bytes. If a character string does not fit in a Text Data Field of a Pack, it is continued onto the succeeding Packs. The succeeding character string will be encoded starting at the

next byte in the **Text Data Field** after the terminator of the current string. Unused bytes in the **Text Data Field** *shall* be filled with null codes.

In case the same character string is used for consecutive tracks, the Tab Indicator may be used to indicate the same as previous track. It is a single tab code (09h) for single byte codes, and two tab codes for double bytes character codes. It *shall not* be used for the first track.

Packs with ID1=86h, 87h, 88h, 89h and 8Fh contains binary information in the **Text Data Field**.

The CRC Field consists of 2 bytes. The host may use these bytes to check for errors in the Pack. The polynomial is $X^{16} + X^{12} + X^5 + 1$. All bits *shall* be inverted before recording. This field is not mandatory for supporting CD-Text data. This field *shall* be valid or set to 0000h.

Appendix H - Mt. Fuji revision history (Informative)

H-1 Changes from Mt. Fuji 1 to Mt. Fuji 2

1. Added support for DVD-RAM devices.
2. Numerous spelling, grammatical, and convention errors fixed. (Changed most occurrences of CD-E to CD-RW, Used “logical unit” in place of “C/DVD logical unit,” “drive,” “target,” and “device.”)
3. Added Feature Descriptors.
4. Added Profiles.
5. Added Regional Playback Control model and command support.
6. Added a DVD-RAM model section.
7. Added a DVD-R model section.
8. Added the SYNCHRONIZE CACHE (10) command.
9. Added the FORMAT UNIT command.
10. Added the GET CONFIGURATION command.
11. Removed the Feature Set Support & Version Page.
12. The GET EVENT/STATUS NOTIFICATION command *shall not* clear the UNIT ATTENTION condition.
13. Changed the definition of the NEA bit from “No Event available in the requested Class(es)” to “None of the requested Event Classes is supported.”
14. The “MediaChange” Event was added.
15. Added the GET PERFORMANCE command.
16. Allowed use of the EVPD bit in the INQUIRY command.
17. Updated the Audio Attenuation Levels in the CD Audio Control mode page.
18. Added the READ (10) command.
19. Added the READ BUFFER command.
20. Added READ DISC STRUCTURE Format 8h.
21. Added the READ FORMAT CAPACITIES command.
22. Added fabrication of data for DVD media to the READ TOC/PMA/ATIP command.
23. Added the Last Recorded Address, Track/RZone Number (MSB), Session/Border Number (MSB), and two reserved bytes to the READ TRACK INFORMATION command result data.
24. Added REPORT KEY Format 1000b for RPC state.
25. Added SEND KEY Format 110b for RPC.
26. Added the SET STREAMING command.
27. Added the VERIFY (10) command.
28. Added the WRITE (10) command.
29. Added the WRITE AND VERIFY (10) command.
30. Added the WRITE BUFFER command.

H-2 Changes from Mt. Fuji 2 to Mt. Fuji 3

1. Added support for CD-R, CD-RW, DVD-R, DVD+RW, and AS-MO logical units.
2. Added terms to 2.2, "*Definitions*" on page 55 for the added logical unit support.
3. Added parameters for new devices to Table 11 - *General Parameters of DVD discs* on page 84.
4. Added parameters for the Physical Information descriptor (Table 16 - *Physical format information in Control Data Block* on page 95) for the new logical units.
5. Added *DVD+RW model section*.
6. Added material to DVD-R model section to describe writing to DVD-R.
7. Added *AS-MO model section*.
8. Obsoleted the C/DVD Capabilities and Mechanical Status mode page and adjusted references to it to point to the appropriate Feature Descriptor instead.
9. Added Profiles for Obsolete, Obsolete, Obsolete, Obsolete, CD-R, CD-RW, and DVD-R Sequential recording to Profiles section.
10. Modified the DVD-RAM Feature (0012h) to include DVD+RW (description only).
11. Added the BLANK command.
12. Added the COMPARE command.
13. Added the ERASE (10) command.
14. Added the CLOSE TRACK/SESSION command.
15. Added descriptors 10h, 11h, 12h, and 20h to the FORMAT UNIT command for CD-RW and DVD+RW.
16. Added Incremental Streaming Writable, Obsolete (Sector Erasable), Write Once, Restricted Overwrite, CD Track at Once, CD Mastering, DVD-R Write, Logical unit Serial Number, and Disc Control Blocks Features.
17. Modified the Morphing Feature to describe the case of External Request Class Events.
18. Modified the Random Writable Feature to remove dependency on the Random Readable Feature (added bytes 8-15).
19. Added the Operational Change Request/Notification, External Request, and Multi-host Classes to the GET EVENT/STATUS NOTIFICATION command.
20. Added the Write Parameters mode page.
21. Added the Address field to the READ DISC STRUCTURE command.
22. Added structures 05h, 0Ch-0Fh, 30h, and FFh to the READ DISC STRUCTURE command.
23. Added result codes to the READ DISC STRUCTURE command for some fields for new media support.
24. Added format codes 10h-12h and 20h to the READ FORMAT CAPACITIES command.
25. Added format 5h for CD-Text to the READ TOC/PMA/ATIP command.
26. Added the REPAIR RZONE command.
27. Added the Key Class field to the REPORT KEY and SEND KEY commands.
28. Added the BLANK CHECK Sense Key to the REQUEST SENSE command.
29. Added the RESERVE TRACK command.
30. Added the SEND CUE SHEET command.
31. Added the SEND DISC STRUCTURE command.

32. Added the SEND EVENT command.
33. Added the SEND OPC INFORMATION command.
34. Obsoleted the SET C/DVD SPEED command.
35. Added use of the BlkVfy bit in the VERIFY (10) command.
36. Added descriptions on the use of the WRITE (10) command with sequentially written media.
37. Added *Appendix D - "IEEE 1394 Implementation Notes (Normative)"* on page 959.
38. Added *Appendix E - "Example Event Implementation Notes (Informative)"* on page 963
39. Added *Appendix F - "Command Implementation Notes (Informative)"* on page 965 for a description of using the READ DISC INFORMATION and READ TRACK INFORMATION commands.
40. Added *Appendix G - "CD-Text Format in the Lead-in Area (Informative)"* on page 975.
41. Added this Appendix.
42. Added *Appendix I - "Sample Applications of Events (Informative)"* on page 993.
43. Added *Appendix J - "UDF Key Structure (Informative)"* on page 1003 describing the use of the Mt. Fuji commands to enable reading UDF discs.

H-3 Changes from Mt. Fuji 3 to Mt. Fuji 4

1. Added support for DVD-RW devices.
2. READ BUFFER CAPACITY command is added.
3. The name of FLUSH CACHE command is changed to SYNCHRONIZE CACHE (10) command
4. Physical Interface Standard code for Fibre Channel is added in the Core Feature descriptor.
5. Data Block Type Supported field and description are added to Incremental Streaming Writable Feature Descriptor.
6. Data Block Type Supported field and description are added to CD Track at Once Feature Descriptor.
7. Descriptions for CD media are removed from REPAIR RZONE command.
8. Section 9.0 “Real-Time Stream recording/playback Model” is added.
9. Format Type = 01h (Spare Area Expansion) is added to FORMAT UNIT and READ FORMAT CAPACITIES commands.
10. Partial Certification for DVD-RAM is obsolete.
11. Hardware Defect Management Feature Descriptor is expanded and SSA bit is added.
12. Streaming Writing (SW) bit is defined in the Real-Time Streaming Feature Descriptor to support Stream recording operation.
13. GET PERFORMANCE command data is expanded to return Unusable Area data besides Performance data.
14. Definition in the Fault / Failure Reporting is changed.
15. Streaming bit is added to READ (12) command to support Stream playback operation.
16. Format codes for Spare Area Information (0Ah) is added to READ DISC STRUCTURE command.
17. WRITE (12) command with Streaming bit is added to support Streaming recording operation.
18. ASC/ASCQ = 5D/03 (FAILURE PREDICTION THRESHOLD EXCEEDED - Predicted Spare Area Exhaustion) is added.
19. Section 4.17.4.4 Silent Linking and Section 4.17.4.5 Buffer Under-run Free Recording are added to the DVD-R Model section.
20. Section 4.20 Recording/Reading for DVD-RW media is added.
21. DVD-RW Restricted Overwrite Profile (13h) is added.
22. Blanking Types for DVD-RW media are added to the BLANK command.
23. Close operation for DVD-RW intermediate state Bordered Area is defined to the CLOSE TRACK/SESSION command.
24. New Format Types for DVD-RW media are added to the FORMAT UNIT command and READ FORMAT CAPACITIES command.
25. DVD-RW Restricted Overwrite Feature (002Ch) is added.
26. New status of DVD-RW media is defined for the Status of Last Session field of READ DISC INFORMATION command.
27. Definition of the Last Recorded RMA Sector Number field of DVD Structure data (RMA) is changed to Start Sector Number of Valid Format 3 RMD Set field when restricted overwritten DVD-RW medium is loaded.
28. ASC = 51, ASCQ = 01, 'ERASE FAILURE - Incomplete erase operation detected' is added.
29. Section 12.0 Write Protection Model is added.

30. Write Protect Feature (04h) is added.
31. MECHANISM STATUS command is added to Embedded Changer Feature command.
32. The **Type** field value of 02h (GET PERFORMANCE command) is assigned for Defect Status data and Defect Status Header and Descriptor are defined.
33. **CWP_V** and **CWP** bits are added to Slot Table Response data format of MECHANISM STATUS command.
34. **Format code = C0h** (Write Protection status) and related descriptor are added to READ DISC STRUCTURE command.
35. **Format code = C0h** (Write Protection status) and related descriptor are added to SEND DISC STRUCTURE command.
36. DVD-RAM Medium status data is added to READ DISC STRUCTURE returned data (**Format Code 09h**).
37. **ASC/ASCQ** returned value is changed when a READ DISC STRUCTURE command with a **Format Code** field value of 08h is presented for a DVD media without the DDS Information.
38. **ASC = 27, ASCQ = 06, 'CONDITIONAL WRITE PROTECT'** is added.
39. **ASCIIButton** event codes of External Request are moved to 200h through 2FFh to avoid confliction. (GET EVENT/STATUS NOTIFICATION command)
40. **DSC** bit description is deleted from PLAY AUDIO (10), PLAY AUDIO MSF and SCAN commands.
41. When SEND DISC STRUCTURE command with **Format code** of 0h-BFh is issued on non-DVD media, **ASC = 30, ASCQ = 05 'CANNOT WRITE MEDIUM - INCOMPATIBLE FORMAT'** will be returned.
42. Appendix B-12.1 Operation Code Types is deleted.

H-4 Changes from Mt. Fuji 4 to Mt. Fuji 5

1. Descriptions, parameters and structures related with DVD-R for Authoring Ver.2.0 and DVD-R for General Ver.2.0 are added.
2. Descriptions of Sequential Recording mode for DVD-RW media is added.
3. The name of DVD-R Write Feature (2Fh) is changed to DVD-R/-RW Write Feature.
4. The name of DVD-R Profile (11h) is changed to DVD-R/-RW Profile.
5. The DVD-RW bit is added to DVD-R/-RW Write Feature Descriptor.
6. Delta list between Mt.Fuji 3 and Mt.Fuji 4 is added to Appendix H (this section).
7. Descriptions and parameters for DVD-RAM Ver.2.0 is updated to DVD-RAM Ver.2.1.
 - Descriptions for 80mm disc are added
 - Recording Type bit definition is added to Bit 28 of Data ID.
8. Descriptions for CPPM and CPRM are added to DVD Model section.
9. DVD CPRM Feature (010Bh) is added.
10. CP_SEC and CP_MOD fields are added to Copyright Management Information (05h) Format descriptor of READ DVD STRUCTURE command.
11. REPORT KEY command Format 10001b is added for AGID for CPRM.
12. CP_MOD field is added to Copyright Management Information (100b) Format descriptor of REPORT KEY command
13. High Speed CD-RW media recording model section is added.
14. SET CD SPEED command is revived with changes for CD-R/RW high speed recording.
15. CD-RW CAV Write Feature (0027h) is added.
16. C/DVD Capabilities & Mechanical Status Mode Page (2Ah) is revived with extension of page format.
17. READ DVD STRUCTURE command Format 06h and 07h are added for Media Identifier and Media Key Block
18. Disc Sub Type field definition of READ TOC/PMA/ATIP command Format 04h is changed.
19. The name of “Block Sync Guarantee Linking Loss (BSGLL)” is changed to “Block SYNC Guard Area (BSGA)”.
20. The name of “Extra Border-in”, “Extra-Border-out” is obsolete and these structures will simply be called “Extra Border Zone”. Some descriptions in the DVD model section were revised due to this change.
21. Some descriptions and parameters for DVD-R for General Ver.2.0 is added to DVD-R model section.
22. The name of “Silent Linking” is changed to “Lossless-Link”.
23. Some descriptions of Table - Error handling on Stream recording/playback operation is modified and clarified.
24. DVD-R/-RW Profile (11h) is separated into DVD-R Sequential recording Profile (11h) and DVD-RW Sequential recording Profile (14h).
25. The name of “DVD-RW Restricted Overwrite” Feature is changed to “Rigid Restricted Overwrite” Feature.
26. The Version field of CD Track at Once Feature is corrected.
27. SCS, MP2A, and WSPD bits are added to Real-Time Streaming Feature for High speed CD-RW recording support.
28. The GET PERFORMANCE command Type field value of 03h is added to return Write Speed Descriptors.
29. Reserved byte field is inserted into 26th byte of C/DVD Capabilities & Mechanical Status Mode Page (2Ah) returned data.

30. Disc Sub Type field definition of READ TOC/PMA/ATIP command is clarified.
31. The Sense Key for LOGICAL UNIT DOES NOT RESPOND TO SELECTION is changed to 4h.
32. The Sense Key for RANDOM POSITIONING ERROR is changed to 3h.
33. The Sense Key for MECHANICAL POSITIONING ERROR is changed to 3h.
34. Feature Descriptor version history is added to Annex H.
35. Block bit is added to READ BUFFER CAPACITY command and new return data format is defined.
36. RBCB bit is added to Real-time Streaming Feature Descriptor.
37. READ DVD STRUCTURE command Format 10h is added to identify the media between DVD-R for General and DVD-R for Authoring media.
38. READ DVD STRUCTURE and SEND DVD STRUCTURE command Format 05h is modified to read/set the ADP_TY field value in the CPR_MAI field of a sector.
39. BUF bit is added to CD Track at Once Feature, CD Mastering Feature Descriptor and “C/DVD Capabilities and Mechanical Status Page (2Ah)” to identify the buffer under-run free recording capable CD-R/RW logical units.
40. BUFE bit usage of Write Parameters Mode Page is extended to non DVD-R/-RW logical unit, specifically CD-R/RW logical unit.
41. PLAY CD command is deleted.
42. READ HEADER command is deleted.
43. BUF bit is added to Incremental Streaming Writable Feature Descriptor to identify the buffer under-run free recording capable CD-R/RW logical units.
44. Descriptions for Data Length field of GET PERFORMANCE command is amended.
45. READ DVD STRUCTURE command Format 0Bh is added for reading of Recording Type bit on DVD-RAM Ver.2.1 media.
46. “Delayed Feature reporting” section is added.
47. The definition for an event clearing condition is changed in GET EVENT/STATUS NOTIFICATION command.
48. “DVD Specifications” section is updated for 4x-speed DVD-R/2x-speed DVD-RW/3x-speed DVD-RAM media.
49. “Control Data Zone Sector Descriptions” section is updated for 3x-speed DVD-RAM media.
50. “RMD (Recording Management Data)” section is updated for 4x-speed DVD-R media.
51. “RMD Contents for DVD-RW media” section is updated for 2x-speed DVD-RW media.
52. “Error handling with Logical unit assisted software defect management” section is added.
53. Logical unit assisted software defect management model is added.
54. Description error in Section 14.3.1 Formatting on Format Type = 00h (Full Format) is corrected.
55. The name of “Defect management” Feature is changed to “Hardware Defect Management” Feature.
56. Enhanced Defect Reporting Feature (0029h) is added.
57. Firmware Information Feature (010Ch) is added.
58. The GET PERFORMANCE command Type field value of 04h and 05h are added to return DBI data and DBI cache zone information.
59. The EMCDR field is added in Read/Write Error Recovery Parameters Mode Page.
60. The description of the relation between PER bit and EMCDR field is added in Section 14.11.3.1.

61. The Page Length field value calculation formula of C/DVD Capabilities and Mechanical Status Mode Page is corrected.
62. Description for Rotation Control field and Write Speed Supported field of C/DVD Capabilities and Mechanical Status Mode Page are corrected.
63. Descriptions related to Enhanced Defect Reporting Feature is added to READ (10), READ (12), VERIFY (10), WRITE (10), WRITE (12), WRITE AND VERIFY (10) command sections.
64. Description for Rotation Control field of SET CD SPEED command is corrected.
65. The SET STREAMING command Type field value of 05h is added.
66. “Fatal error recovery model with Group 3 time-out” section is added.
67. “Recovery from fatal error of streaming” section is added
68. “RW media specific matters” section is added
69. Group 3 time-out model is added to “Time-outs” section.
70. Time-out Feature Descriptor is modified to add the Group 3 time-out functionality.
71. Group 3 time-out related fields are added to Time-out & Protect Mode Page (1Dh).
72. Group 3 time-out bit is added to VERIFY (10) command.
73. “Logical Unit Not Busy condition/Busy condition” section is added.
74. The 'DBEvent' bit is added to Core Feature Descriptor.
75. The OCEvent bit is added to Morphing Feature Descriptor.
76. The Operational Event format and Operational Request/Report code and some descriptions in “Operational Change Request/Notification Class Events” section is changed.
77. The Device Busy Event format and Device Busy Status code and some descriptions in “Device Busy Class Events” section is changed.
78. Example Device Busy Class Events implementations is added to Appendix I.

H-5 Changes from Mt. Fuji 5 to Mt. Fuji 6

1. Commands and model for DVD-R Dual Layer media were added.
2. The name of READ DVD STRUCTURE/SEND DVD STRUCTURE command was changed to READ DISC STRUCTURE/SEND DISC STRUCTURE command for the extension of its usage.
3. Commands and model for AACs were added.
4. The LJRS bit in Track Information Block was specified.
5. Some descriptions were updated to match DVD-R for General Ver. 2.1 and DVD-RW Ver. 1.2.
6. Commands and model for HD DVD media were added.
7. The name of CLOSE TRACK/RZONE/SESSION/BORDER command was changed to CLOSE TRACK/SESSION command to match with MMC.
8. The name of RESERVE TRACK/RZONE/RMZ command was changed to RESERVE TRACK command to match with MMC.
9. The name READ TRACK/RZONE INFORMATION command was changed to READ TRACK INFORMATION command to match with MMC.
10. RESERVE TRACK command descriptions for Address Mode reservation was added.
11. Parameters for DVD-ROM 3x disc are added.
12. The usage of the Layer Number field for Format Code = FFh of READ DISC STRUCTURE command is changed to Reserved.
13. Hybrid disc model, Feature are added and related commands are modified to handle Hybrid discs.
14. The name of HD DVD-Rewritable is changed to HD DVD-RAM.
15. The name of Fault / Failure Reporting Mode Page is changed to Informational Exceptions Control Mode Page.
16. The name of the Assigned Track information in READ DISC INFORMATION command is changed to the Track Resources information.
17. The name of the Appendable bit in READ TRACK INFORMATION command is changed to the Open bit.
18. The Write Protect Feature version is incremented by 2 and the DWP, WDCB bits are added.
19. The CD Read Feature version is incremented by 1 and the DAP bit is added.
20. The DAP bit is added to CDB of READ CD and READ CD MSF commands.
21. The name of the NWA bit in Incremental Streaming Writable Feature is changed to the TRIO bit.
22. The Formattable Feature version is incremented by 1 and the RENoSA, Expand, QCert, Cert and RRM bits are added.
23. The name of the Dual Layer bit in DVD-R/-RW Feature is changed to the RDL bit.
24. The size of the Allocation Length field of INQUIRY command is expanded to 2 bytes field to match with SPC.
25. The CmdDt bit of INQUIRY command is obsolete to match with SPC.
26. Inquiry data format is updated to match with SPC.
27. The LLBAA bit and Subpage Code field are added in MODE SENSE (10) CDB to match with SPC.
28. The Mode field of READ BUFFER command is expanded to 5 bits to match with SPC.
29. The Logical Block Address field is added in READ CAPACITY CDB.
30. The name of the Returned Data Type field in the Disc Information Block and Track Resource Information block

of the READ DISC INFORMATION command are changed to the Disc Information Data Type field.

31. The name of the Sub-command field in READ DISC STRUCTURE CDB is changed to the Media Type field.
32. The DESC bit is added to REQUEST SENSE command to match with SPC.
33. The name of the Sub-command field in SEND DISC STRUCTURE CDB is changed to the Media Type field.
34. The name of the Block Count field in SYNCHRONIZE CACHE CDB is changed to the Number of Blocks field.
35. The Mode field of WRITE BUFFER command is expanded to 5 bits to match with SPC.
36. The INQ2 bit is added to the Core Feature Descriptor indicate the support of 2 byte Allocation Length field and EVPD bit =1 in INQUIRY CDB and the Feature version is updated.
37. The M5 bit is added to Microcode Upgrade Feature Descriptor to indicate the support of 5-bits Mode field in READ BUFFER and WRITE BUFFER commands and the Feature version is updated.
38. The RelAdr bit is obsolete.
39. In HD DVD Read Feature, the READ DISC STRUCTURE command with Format Code =12h was missing and is added as mandatory support Format Code.
40. Error code for SEND DISC STRUCTURE Format Code 21h, 22h and 23h are corrected.
41. Error code for SEND OPC INFORMATION command is corrected.

H-6 Feature Descriptor version history

A Feature Descriptor has **Version** field to identify different version of the Feature Descriptor. If some changes are required to a Feature, and if they are backward compatible, the changes will be included in the Feature Descriptor and the **Version** field value will be incremented.

Table 864 shows the current version of each Feature and references for old Feature Descriptor versions.

Table 864 - Feature Descriptor Version

Feature Number	Feature Name	Current Version	References for old Feature Descriptor versions
0000h	Profile List	0	-
0001h	Core	2	See INF-8090i Rev. 5.5 for version 0 descriptor See Mt.Fuji Ver. 5 Revision 1.6 for version 1 descriptor
0002h	Morphing	1	See INF-8090i Rev. 5.5 for version 0 descriptor
0003h	Removable Medium	1	See INF-8090i Rev. 6.1 for version 0 descriptor
0004h	Write Protect	2	See INF-8090i Rev. 5.5 for version 0 descriptor See MMC for version 1 descriptor
0005h-000Fh	Reserved	Reserved	-
0010h	Random Readable	0	-
0011h-001Ch	Reserved	Reserved	-
001Dh	MultiRead	0	-
001Eh	CD Read	2	See Mt.Fuji Ver. 2 Revision 1.0 for version 0 descriptor See INF-8090i Rev. 5.5 for version 1 descriptor
001Fh	DVD Read	2	See INF-8090i Rev. 5.5 for version 0 descriptor See INF-8090i Rev. 6.1 for version 1 descriptor
0020h	Random Writable	1	See Mt.Fuji Ver. 2 Revision 1.0 for version 0 descriptor
0021h	Incremental Streaming Writable	3	See INF-8090i Rev. 3.6 ^a for version 0 descriptor See INF-8090i Rev. 5.1 for version 1 descriptor See INF-8090i Rev. 5.5 for version 2 descriptor
0022h	Sector Erasable	Obsolete	-
0023h	Formattable	2	See INF-8090i Rev. 5.5 for version 0 descriptor See INF-8090i Rev. 6.1 for version 1 descriptor
0024h	Hardware Defect Management	1	See INF-8090i Rev. 3.6 for version 0 descriptor
0025h	Write Once	0	-
0026h	Restricted Overwrite	0	-
0027h	CD-RW CAV Write	0	-
0028h	MRW	See MMC	See MMC
0029h	Enhanced Defect Reporting	0	-
002Ah	DVD+RW	See MMC	See MMC
002Bh	DVD+R	See MMC	See MMC
002Ch	Rigid Restricted Overwrite	0	-
002Dh	CD Track at Once	2	See INF-8090i Rev. 3.6 for version 0 descriptor See INF-8090i Rev. 5.1 for version 1 descriptor
002Eh	CD Mastering	1	See INF-8090i Rev. 5.1 for version 0 descriptor
002Fh	DVD-R/-RW Write	2	See INF-8090i Rev. 4.0 ^b for version 0 descriptor See INF-8090i Rev. 5.5 for version 1 descriptor
0030h-0032h	Reserved	Reserved	-

Table 864 - Feature Descriptor Version (continued)

Feature Number	Feature Name	Current Version	References for old Feature Descriptor versions
0033h	Layer Jump recording	0	-
0034h	LJ Rigid Restricted Overwrite	0	-
0035h	Stop Long Operation	0	-
0036h	Reserved	Reserved	
0037h	CD-RW Media Write Support	See MMC	See MMC
0038h	BD-R Pseudo Overwrite	See MMC	See MMC
0039h	Reserved	Reserved	-
003Ah	DVD+RW Dual Layer	See MMC	See MMC
003Bh	DVD+R Dual Layer	See MMC	See MMC
003Ch-003Fh	Reserved	Reserved	-
0040h	BD Read	See MMC	See MMC
0041h	BD Write	See MMC	See MMC
0042h	TSR	See MMC	See MMC
0043h-004Fh	Reserved	Reserved	-
0050h	HD DVD Read	1	See INF-8090i Rev. 6.1 for version 0 descriptor
0051h	HD DVD Write	1	See INF-8090i Rev. 6.1 for version 0 descriptor
0052h	HD DVD-RW Fragment Recording	0	-
0052h-007Fh	Reserved	Reserved	-
0080h	Hybrid disc	0	-
0081h-00FFh	Reserved	Reserved	-
0100h	Power Management	0	-
0101h	S.M.A.R.T.	0	-
0102h	Embedded Changer	0	-
0103h	CD Audio analog play	0	-
0104h	Microcode Upgrade	1	See INF-8090i Rev. 5.5 for version 0 descriptor
0105h	Timeout	1	See INF-8090i Rev. 5.4 for version 0 descriptor
0106h	DVD CSS	0	-
0107h	Real-Time Streaming	3	See INF-8090i Rev. 5.0 ^c for version 2 descriptor See INF-8090i Rev. 4.0 for version 1 descriptor See INF-8090i Rev. 3.6 for version 0 descriptor
0108h	Logical unit Serial Number	0	-
0109h	Media Serial Number	See MMC	See MMC
010Ah	Disc Control Blocks	See MMC	See MMC
010Bh	DVD CPRM	0	-
010Ch	Firmware Information	0	
010Dh	AACS	1	See INF-8090i Rev. 6.1 for version 0 descriptor
010Eh	DVD CSS Managed recording	0	-
010Fh	Reserved	Reserved	
0110h	VCPS	See MMC	See MMC
0111h-0112h	Reserved	Reserved	-
0113h	SecurDisc	0	-
0114h-FFFFh	Reserved	Reserved	-
FF00h-FFFFh	Vendor Unique	-	-

- a. INF-8090i Rev. 3.6 corresponds to Mt.Fuji Ver. 3 Revision 1.0.
- b. INF-8090i Rev. 4.0 corresponds to Mt.Fuji Ver. 4 Revision 1.0.
- c. INF-8090i Rev. 5.0 corresponds to Mt.Fuji Ver. 5 Revision 1.0.

Appendix I - Sample Applications of Events (Informative)

I-1 Overview

Events were designed to be a one-way pipe of information from the logical unit to the host. The original design intent for this functionality was to use Asynchronous Event Notification, where the logical unit would issue commands to the host to notify the host about asynchronous Events. This behavior cannot be implemented on ATAPI busses. In addition, the software driver stack on most operating systems does not allow for “target mode” operation. Changing the stacks to allow this behavior would require a large effort.

The GET EVENT/STATUS NOTIFICATION Command simply provides for asynchronous Event notification through the traditional command path. It is the “output” of the pipe.

Input to the pipe is generated by the logical unit in response to asynchronous Events within the logical unit. Operation of user controls (buttons, trays, magazines, etc.), resets, requests from other hosts, and power state changes due to timers are examples of Events that cause an Event Descriptor to be placed into the Event Queue (pipe).

An Event is generated when it is placed into the Event Queue. An Event is reported when the GET EVENT/STATUS NOTIFICATION Command is used to read it from the Queue. Unless a GET EVENT/STATUS NOTIFICATION Command was queued because an Event was requested for an empty Queue and the *Immed* bit was set to zero, there is no timing requirement between generating and reporting Events. For example, a new logical unit in a legacy system would generate Events and never report them.

The Multi-host behavior described here is for a co-operative type of shared use. This model is best suited for an occasionally shared environment, particularly use by a single user across multiple machines. It is not suited for frequent intermixed access.

I-2 Example logical unit implementation

Several commands are used by the host when utilizing Events. Examples given here show only a few of the possible sequences in which commands could be received. A logical unit should not need any state information for the implementation of Events and Morphing other than that explicitly described here. The following represents one basic model for implementation; it is not intended to be the only possible implementation.

The following is a list of state information that can be modified by a host. The list does not include commands that have secondary effects such as ejecting the medium. Some of the state information can be modified by the logical unit in addition to the host. The type of the state information is given in brackets.

1. Persistent Prevented [Boolean]
2. Persistent Prevented Owner [ID]
3. Prevented (one per host) [Boolean]
4. Event Queue (one queue per Class per host) [Event Data]
5. Sense Data (one per host) [SK/ASC/ASCQ]

I-2.1 Operation of the PREVENT ALLOW MEDIUM REMOVAL Command

I-2.1.1 Persistent Prevent

Normally, the logical unit performs each command as received, regardless of the source of each command. The PREVENT ALLOW MEDIUM REMOVAL Command is used to modify the state of the Persistent Prevented, Persistent Prevented Owner, and Prevented variables. These bits are checked by most commands to determine if and how that command operates.

While in the Persistent Prevented state, commands from other hosts that would affect the host owning the Persistent Prevent will fail. In addition to failing the command with CHECK CONDITION Status, 5/2C/05 PERSISTENT

PREVENT CONFLICT, the logical unit may send an External Request Class Event to the host owning the Persistent Prevent. Such Events *shall not* be generated for commands that require data transfer.

If a PREVENT ALLOW MEDIUM REMOVAL Command with the Persistent and Prevent bits set is received from the host that originally set the Persistent Prevented state, or the Persistent Prevented state is False, the logical unit *shall* set the Persistent Prevented state and the Persistent Prevented Owner *shall* be set to the ID of the issuing host. The logical unit *shall* generate Control Grant Event of the Multi-host Class for all other hosts.

If a PREVENT ALLOW MEDIUM REMOVAL Command with the Persistent and Prevent bits set is received from a host other than the one that set the Persistent Prevent state, the logical unit *shall* fail the command with CHECK CONDITION Status, 5/2C/05 PERSISTENT PREVENT CONFLICT. The logical unit *shall* generate a Control Request Event of the Multi-host Class for the host owning the Persistent Prevent.

If a PREVENT ALLOW MEDIUM REMOVAL Command with the Persistent bit set and the Prevent bit cleared is received from the host owning the Persistent Prevented state, or the logical unit is not in the Persistent Prevented state, the Persistent Prevented state *shall* be cleared. The logical unit *shall* generate a Control Release Event of the Multi-host Class for all other hosts.

If a PREVENT ALLOW MEDIUM REMOVAL Command with the Persistent bit set and the Prevent bit cleared is received from a host other than the one that originally set the Persistent Prevent state, the logical unit *shall* fail the command with CHECK CONDITION Status, 5/2C/05 PERSISTENT PREVENT CONFLICT. The logical unit *shall* generate a Control Request Event of the Multi-host Class for the logical unit owning the Persistent Prevent.

I-2.1.2 Legacy Prevent

The logical unit is in the Prevented state if any host has a Prevent in place.

If a PREVENT ALLOW MEDIUM REMOVAL Command with the Persistent bit cleared and the Prevent bit set is received from the host that originally set the Persistent Prevented state, or the Persistent Prevented state is False, the logical unit *shall* set the Prevented state for the issuing host.

If a PREVENT ALLOW MEDIUM REMOVAL Command with the Persistent bit cleared and the Prevent bit set is received from a host other than the one that set the Persistent Prevent state, the logical unit *shall* fail the command with CHECK CONDITION Status, 5/2C/05 PERSISTENT PREVENT CONFLICT.

If a PREVENT ALLOW MEDIUM REMOVAL Command with the Persistent bit cleared and the Prevent bit set is received, the logical unit *shall* clear the Prevent state for that host.

I-2.2 Operation of the GET CONFIGURATION Command

The GET CONFIGURATION Command result data is determined primarily by state information derived from the medium. This includes media type, presence of certain data types, write protect state, and many other variables not controllable directly through the interface.

The GET CONFIGURATION Command result data may be affected by the Persistent Prevented state. For example, Features that would interfere with logical unit operation as seen by the host owning the Persistent Prevented state might be marked as not Current. Determination of interfering Features is vendor unique. For example, a CD-R drive vendor might determine that reading interferes with the owning host's operation, but a CD-ROM drive vendor may not.

I-2.3 Operation of the GET EVENT/STATUS NOTIFICATION Command

In some implementations, the sole job of the GET EVENT/STATUS NOTIFICATION Command is to pop the next Event from the Event Queue (if any) and return it to the host. If no Event is in any of the requested Queues, the command either completes with the result data indicating No Event (*Immed* = 1) or is kept in the command Queue (*Immed* = 0) until an Event in one of the requested Classes occurs.

An implementation that locks the tray when the New Media Event is reported rather than when it is generated must either maintain a state variable to indicate reporting of the New Media Event or provide a function to peek into the Event Queue to see if a New Media Event is present in the Media Class Event Queue.

I-2.4 Operation of the START STOP UNIT Command

If a Prevent is in place for any host, all Eject requests *shall* fail.

If a Persistent Prevent is in place, all Eject requests from hosts other than the Persistent Prevent owner *shall* fail.

An Eject request from the host that owns the Persistent Prevent or if no Persistent Prevent is in place *shall* succeed.

I-2.5 Operation of the SEND EVENT Command

The SEND EVENT Command simply performs the requested function, if possible. The function will typically correspond to a function that can be requested from the front panel.

The logical unit *shall not* check to see if a corresponding Event had been reported. The logical unit simply determines if the requested function can be performed, and if so, performs the requested function.

If a host owns a Persistent Prevent, SEND EVENT Commands from other hosts *shall* fail.

I-2.6 Internal functions

A Generate Event function is called in many different situations, including from within commands and external Event monitors. It should take Class, Event, Status, Event Data, and host information as data. Host information includes the ID of a host and whether the Event is for that host, all hosts, or all hosts but the one identified. The routine that mounts new media would call this function with Media Class, NewMedia Event, Media Status 2, Start/End Slots 1 - 1, all hosts. The PREVENT ALLOW MEDIUM REMOVAL Command may call this function with Multi-host Class, Control Release Event, Multi-host Status Ready, Event Data 0, all hosts but the one issuing the command as parameters.

If a logical unit locks the tray when Persistent Prevented and the NewMedia Event of the Media Class is generated, the START STOP UNIT Command can simply check for the media mounted state and the Persistent Prevented state, since the media mounted state is entered at the same time that the Event is generated (by definition of the NewMedia Event).

If a logical unit locks the tray when Persistent Prevented and the NewMedia Event is reported, either a separate state variable is needed to track the Event reporting, or a Peek at Event Queue function is needed to determine if a NewMedia Event is still present (not yet reported). In this model, if a NewMedia Event is in the Queue, and the eject button is pressed, the logical unit *shall* remove the NewMedia Event from the Queue before ejecting the medium.

I-2.7 Summary

Table 865 represents logical unit behavior upon receipt of various commands. The Persistent Prevented state represents the state of the logical unit before receipt of the command. The same host column identifies commands that were received from the same host that owns the Persistent Prevent.

Table 865 - Persistent Prevent Behavior

Command	Persistent Prevented	Same host	Action
PREVENT ALLOW MEDIUM REMOVAL, Persistent = 1, Prevent = 0 (Persistent Allow)	N	X	Generate Control Release Event for all other hosts.
	Y	N	Fail the command
		Y	Y
PREVENT ALLOW MEDIUM REMOVAL, Persistent = 1, Prevent = 1	N	X	Enter the Persistent Prevented state (for that host). Generate Control Grant Event for all other hosts.
	Y	N	Fail the command, generate Control Request Event for the host that owns the Persistent Prevent.
		Y	Y
Any command that requires data transfer but doesn't affect logical unit operation (e.g., INQUIRY)	N	X	Perform the command
	Y	N	Perform the command
		Y	Y
Any command that requires data transfer and affects logical unit operation (e.g., MODE SELECT (10))	N	X	Perform the command
	Y	N	Fail the command
		Y	Y
Any command that does not require data transfer and does not affect logical unit operation (e.g., TEST UNIT READY)	N	X	Perform the command
	Y	N	Perform the command
		Y	Y
Any command that does not require data transfer but affects logical unit operation (e.g., START STOP UNIT)	N	X	Perform the command
	Y	N	Fail the command. May generate an External Request Notification Event.
		Y	Y

I-3 Example host implementations

The following examples are not meant to describe all applications and possibilities. They represent just a few possible implementations.

I-3.1 Host use of the Multi-host Class

In this model, a single host requests control of the logical unit via the Persistent Prevent command. If successful, the host can operate as if it were the only host. If not successful, most commands may fail. If the host requires use of the logical unit, the host should wait for a Control Release Event. After a reasonable timeout (user intervention is probably required on the owning host), the host may attempt another Persistent Prevent command (to trigger another Control Request Event to the owning host).

Note: The Control Release Event may never occur, especially if the owning host does not implement this protocol.

If a host owns the Persistent Prevent, it *shall* expect to receive Control Request Events. If a Control Request Event is received, the host should flush its buffers and unmount any file systems on that logical unit. If the unmounting is successful, the host should issue a PREVENT ALLOW MEDIUM REMOVAL Command, Persistent = 1, Prevent = 0. If the unmounting is unsuccessful, the host should notify the user about the attempted operation and the possible reason or reasons for its failure.

A host will generally not issue a PREVENT ALLOW MEDIUM REMOVAL Command, Persistent = 1, Prevent = 0 unless:

1. The user explicitly unmounts the logical unit.
2. The system is shut down.
3. It is responding to a Control Request Event.

In this model, it is not necessary to do a Persistent Allow when immediate needs are met; it is sufficient to do it when a request comes from another host.

This results in a ping-pong type behavior that is suited to a single user on several machines, or where a single resource is shared among co-operating users. This model is similar to that of a printer, where the “owner” can only change between “jobs.” The granularity is very coarse. This is necessary because mounting and unmounting file systems is a time consuming process, and should be performed only as often as required.

I-3.2 Host use of the Operational Change Request/Notification Class

The Operational Change Request/Notification Class was designed for “intelligent” peripherals that have front panel buttons and the ability to perform operations based on those buttons. For example, a logical unit that acts as both a CD-R and a standalone CD-R audio component may have “Record” and “Finalize” buttons, among others. Some buttons may have behavior that interferes with operations that the host may attempt. If the logical unit is in the Persistent Prevented state, such interference is not allowed.

However, it is desired that the front panel buttons continue to function. To allow this, the host is “put in the loop.” That is, instead of acting directly on the button, the logical unit generates Events to be reported to the host.

One implementation possibility is to not look for such Events, or to discard them as received. If a Persistent Prevent is issued, the controls on the front panel essentially are deactivated. If only selected Events are discarded, the corresponding buttons are deactivated.

An implementation that acts on Events may use the SEND EVENT Command to request that the logical unit handle the Event as it would if the Persistent Prevent were not in place. If the Event is one that is not known to the host, it should flush buffers and unmount the media before issuing the SEND EVENT Command because the operation to be performed is unknown. The same rule applies for known Events that depend on or modify the state of the medium.

Finally, an implementation may act upon the button presses itself. For example, if a software application is being used to play DVD-Video, it may act on a “Fast Forward” button press by sending a code to the application to perform a “Fast Forward” operation.

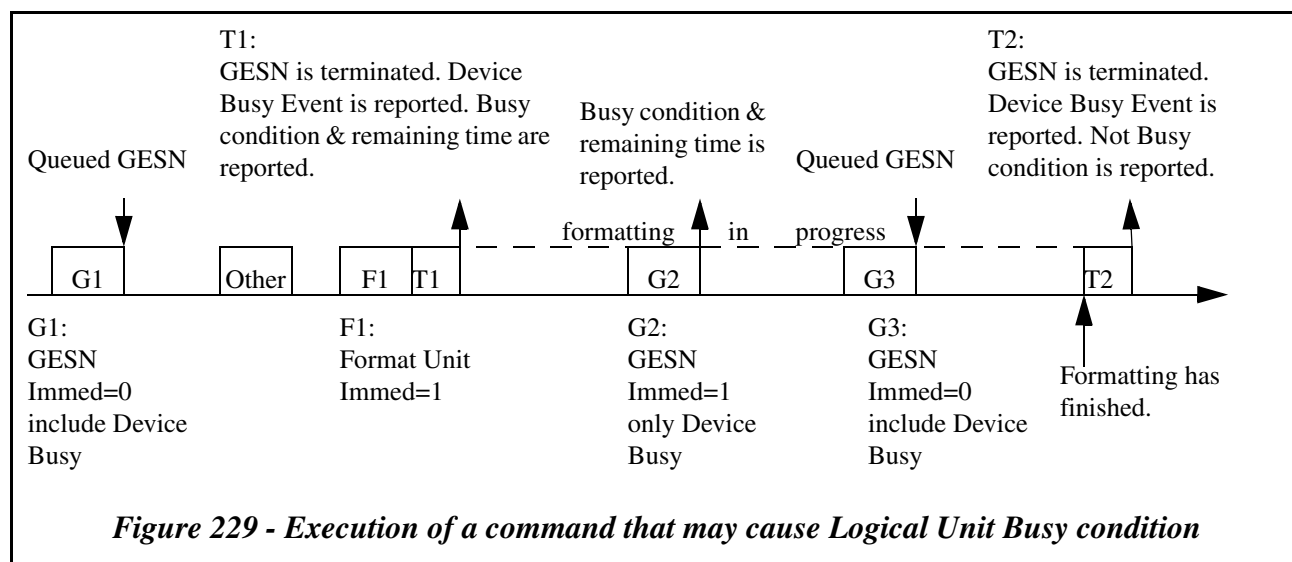
I-4 Example Device Busy Class Events implementations

The Immed bit of Command Descriptor Block specifies that the command should be terminated immediately before completion of the long time operation. The progress indication that shows the progress display of the long time operation in a device has the inaccuracy to some degree. This cannot be avoided. Here is an example that shows the reason of the inaccuracy.

Sometimes device takes very long time till the termination of the immediate command with Immed=1. Here is an example that shows the reason of the long time till the immediate command termination.

I-4.1 Example of Device Busy Class Events reporting

17.5.6, "Device Busy Class Events" on page 638 reports the condition change of 3.5, "Logical Unit Not Busy condition/ Busy condition" on page 77 and the predicted amount of time remaining for the logical unit to become not busy. This example explains the GET EVENT/STATUS NOTIFICATION command of Device Busy Class Events behavior using disc format process.



I-4.2 Time-unit progress indication implementation example

The time base progress indication may not show accurate information. It is because there are a lot of events that break the forecast. Here is a sample list that should reduce the accuracy of the information.

- Seek, Seek retry
- OPC, OPC retry
- Disc rotation speed control, disc spin-up time

These operations are affected by some mechanical randomness. Additional retry action may take additional time adding to the original assumed time. If some retry operations are taken, twice or three times longer time will be necessary. There are no way other than to accept this inaccuracy.

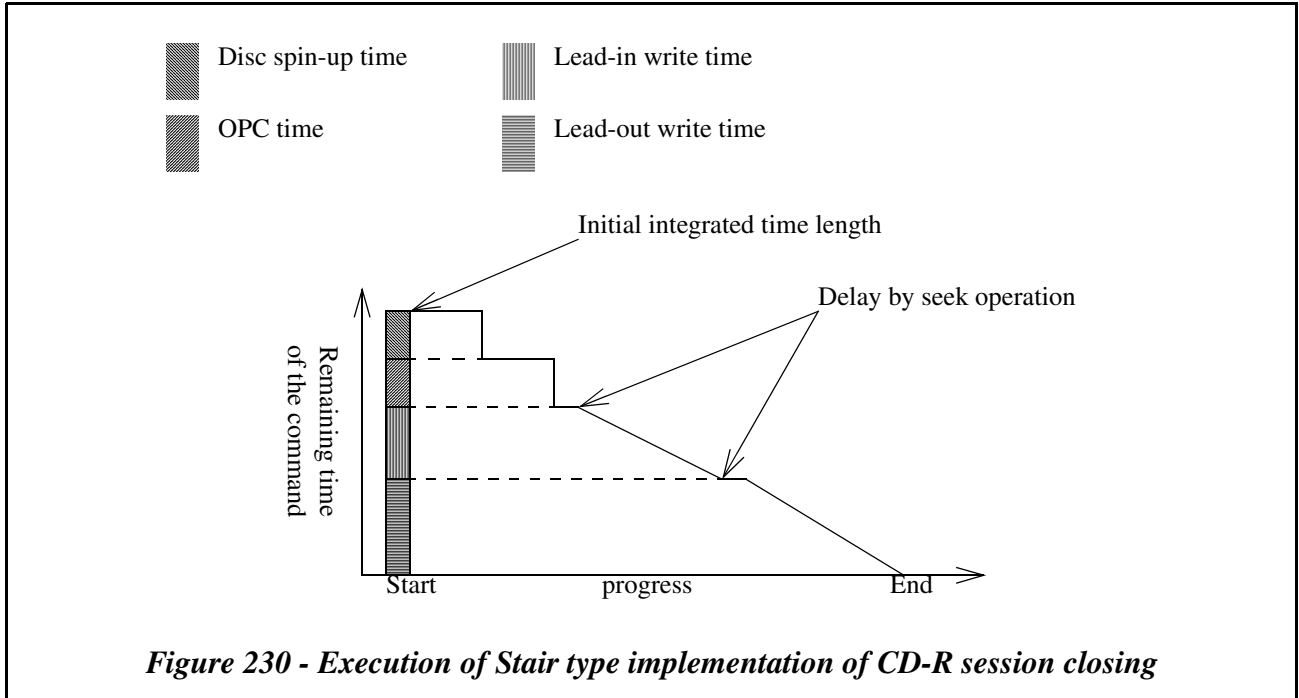
Device may assume a fixed time length for the above mechanical operation. Device may report the integrated time length of all operations in a Command at the beginning. For example, a Close Session Command to a CD- R consists of disc spin-up, OPC, (PMA write,) Lead-in write and Lead-out write. Also, the time of the initial OPC may be different with the time of the additional OPC. The initial OPC may take very longer time than the additional OPC. In case of ZCLV, one or more OPC operations may be performed between Lead-in writing and Lead-out writing. The time of additional OPC may be included in "Delay of seek operation" and "Adjustment".

Here are two typical implementation types. One is stairs type. When an operation is done the assigned time of the operation is subtracted from the remaining time of the command. The progress indication may be discontinuous like

stairs. Other is clock type. The remaining time of the command is started from the initial integrated time length. Then the remaining time is decreased by real time till the command end.

I-4.2.1 Example of stair type

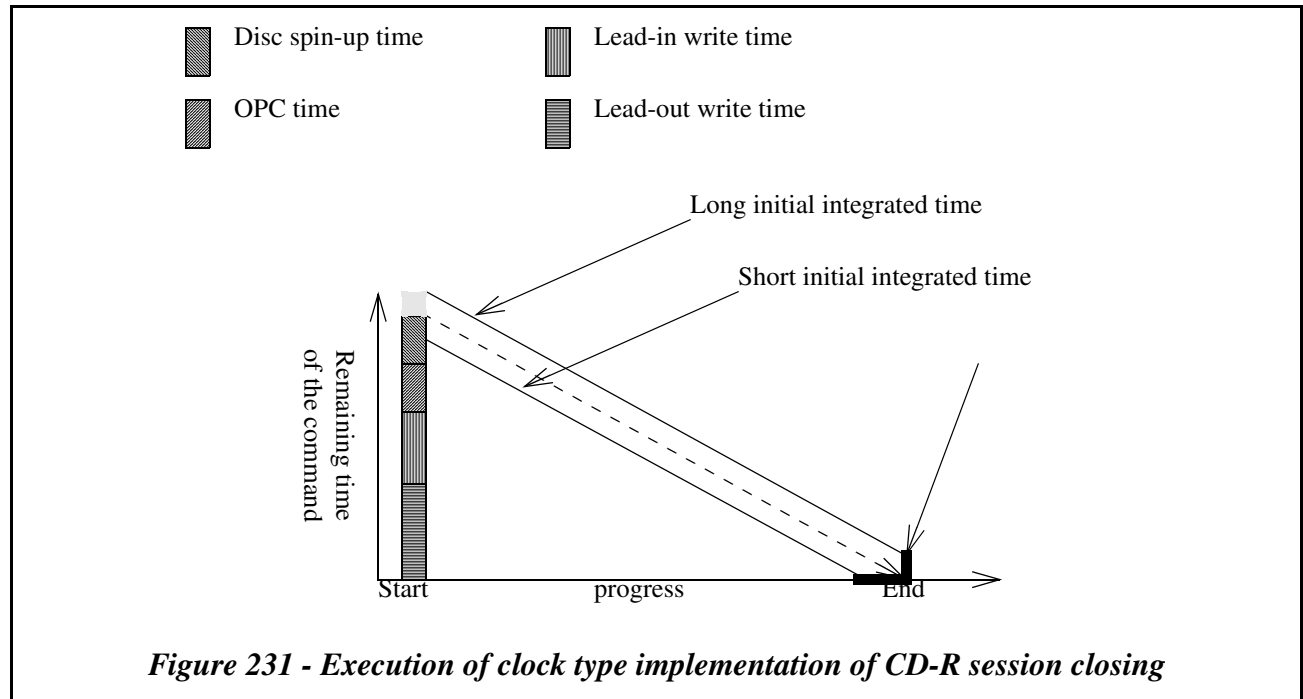
The progress indication may be discontinuous like stairs. If an operation e.g., OPC is finished, the corresponded time is decreased from the remaining time.



It is recommended to report not with the single step but with two or more steps for OPC or disc rotation speed control. For example, if OPC consists from two parts, each end of a part is regarded as a step for reducing the remaining time.

I-4.2.2 Example of clock type

The progress indication is linear with real-time clock.



Some adjustment of value may happen. The value of the time field *shall not* be negative.

It is recommended that the remaining time decrease monotonously unless a significant retry or change of operation happens.

I-4.3 Intermediate steps of long operation

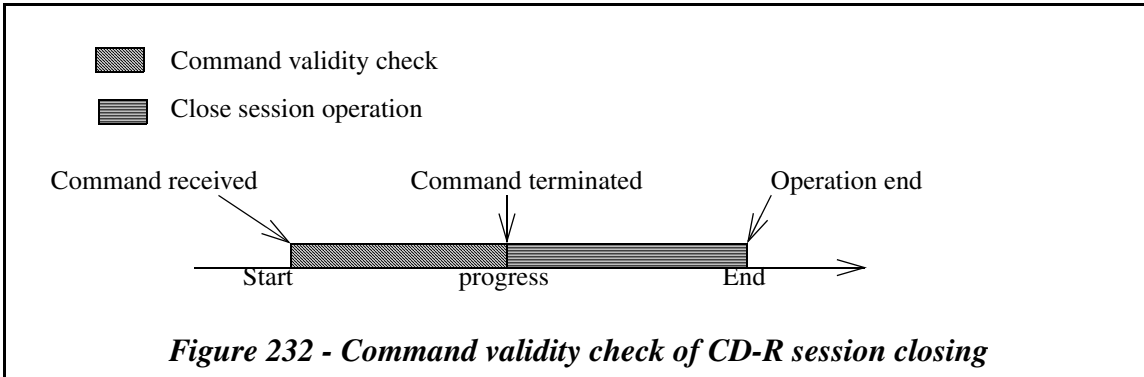
When host issued an immediate command that has Immed=1 device may not start the operation immediately. Usually an immediate command is terminated immediately. But sometimes the immediate command takes long time till the command termination. Device keeps its interface active. Or, sometimes long time operation of the immediate command takes several intermediate steps till the operation completion. The host needs to handle these status transactions of the device till the operation ending.

I-4.3.1 Long time of an immediate command till its termination

Some immediate commands need very long time till the command termination to check the command validity. During validity check, the immediate command should not be terminated, and then logical unit should occupy its interface bus. To eliminate this long time till the command termination, host should do an appropriate preparation before doing the operation.

For example, CLOSE TRACK/SESSION command with Immed=1, Session=1 that will close a CD-R session may take very long time to terminate the command. If a CD-R disc has 99 tracks in an open session, when device received a Session Close request (CLOSE TRACK/SESSION command with Immed=1, Session=1), logical unit checks that all of the tracks are closed. If any open tracks exist in the open session, logical unit terminates the CLOSE TRACK/SESSION command with CHECK CONDITION Status, 5/72/04 EMPTY OR PARTIALLY WRITTEN RESERVED TRACK.

To check this command validity, logical unit may take 45 - 90 seconds. Even if Immed bit is set to one, logical unit may not terminate the command for this check. To eliminate this issue, host should check the status of the all tracks using READ TRACK INFORMATION command by itself. Logical unit can detect all tracks status, then the time of the command validity becomes short.

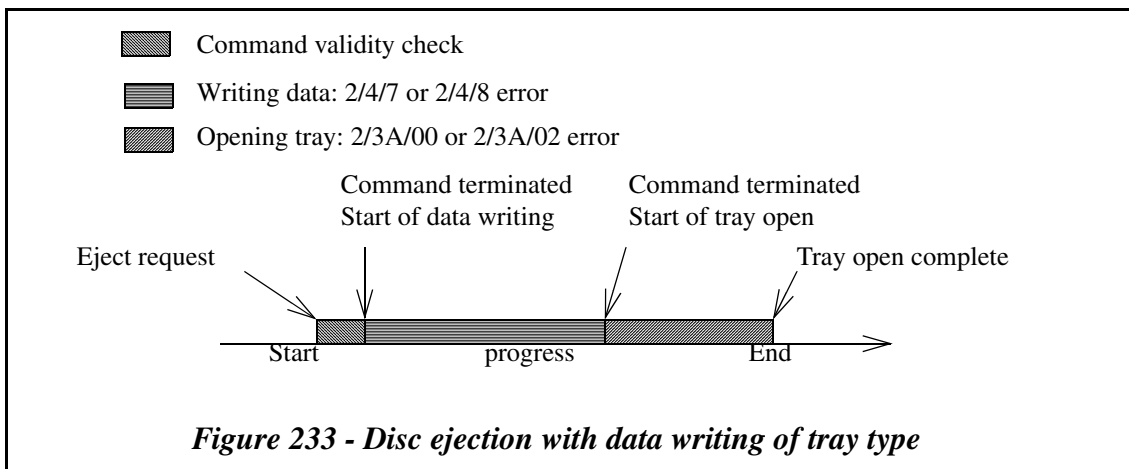


I-4.3.2 Multiple steps immediate operation

Some immediate commands cause several intermediate steps of the logical unit. Logical unit may report different error code to show the operation progress to READ DISC INFORMATION command. Host should wait the completion of the operation.

For example, START STOP UNIT command with Immed=1, Start=0, LoEj=1 that will eject a media may cause data writing before ejection. If logical unit has writable media, and logical unit has data in its buffer, the logical unit needs to write the data on the medium before disc ejection. Sometimes logical unit needs to update media specific information (e.g., PMA, RMA, FDCB) before disc ejection. In these cases, the logical unit may report 2/04/07 LOGICAL UNIT NOT READY, OPERATION IN PROGRESS or 2/04/08 LOGICAL UNIT NOT READY, LONG WRITE IN PROGRESS in response to later media access commands. After data writing completion, logical unit will start disc eject operation, and then logical unit will report no media error (e.g., 2/3A/00 MEDIUM NOT PRESENT or 2/3A/02 MEDIUM NOT PRESENT - TRAY OPEN).

Further, if START STOP UNIT command with Immed=0/1, Start=1, LoEj=1 that will close the tray is issued during the above described data writing operation of the disc ejection, the above immediate disc eject operation may be canceled. In this case, logical unit may not report Media Class Events and Unit Attention Condition of 6/28/00 NOT READY TO READY CHANGE, MEDIUM MAY HAVE CHANGED.



Appendix J - UDF Key Structure (Informative)

J-1 Introduction

OSTA Universal Disk Format (UDF) is the file system that is adopted as the standard DVD file system. OSTA UDF is a subset of the standard ECMA 167 3rd edition. The command set described in this document was designed to allow easy access to information required by a UDF implementation.

To read UDF written disc, following descriptors and sequences are used to get file structure.

- Volume Recognition Sequence (VRS)
- Anchor Volume Descriptor Pointer (AVDP)
- Volume Descriptor Sequence (VDS)
- File Set Descriptor (FSD)
- Root Directory ICB
- Root Directory file

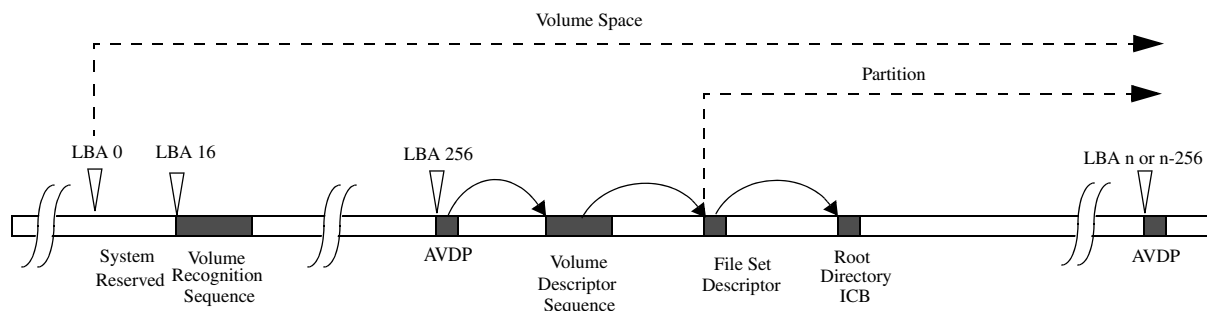


Figure 234 - Basic UDF Structure

For UDF sequential recording, following are also used.

- Virtual Allocation Table ICB (VAT ICB)
- Virtual Allocation Table (VAT)

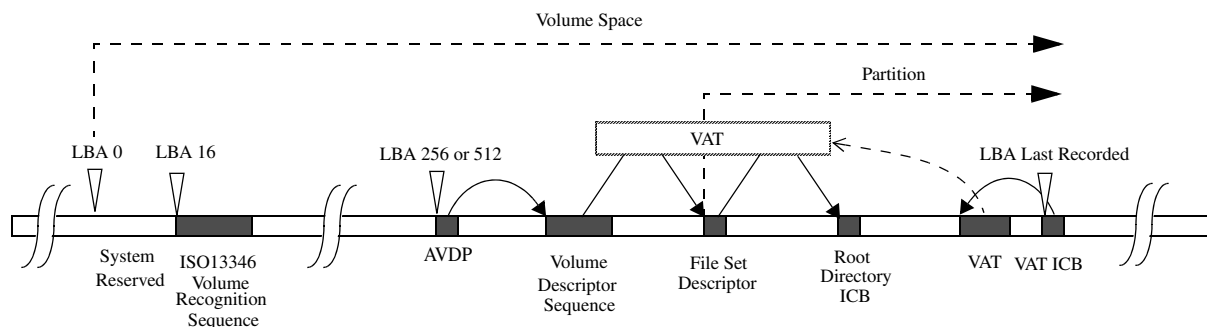


Figure 235 - Basic UDF Structure used on sequentially written media

VRS *shall* start at LBA 16. VRS contains information on whether the volume complies with ECMA 167. This sequence may contain ISO 9660 descriptors also. When Random access mode is used, a duplicate VRS may be recorded at sector n-16.

When the volume is sequentially written, a Virtual Allocation Table (VAT) is recorded to translate Virtual Addresses to Logical Addresses. To find the Virtual Allocation Table, the VAT ICB *shall* be written in the last user data sector.

AVDP *shall* be recorded at LBA 256, and LBA n or n-256, where n is the last LBA. For sequentially written media, AVDP can be located only at LBA 512 until closing the volume. AVDP contains pointer to the VDS.

The Volume Descriptor Sequence (VDS) is made up of several Volume Descriptors such as a Primary Volume Descriptor, a Logical Volume Descriptor, and a Partition Descriptor. The Logical Volume Descriptor contains pointer to the File Set Descriptor.

The File Set Descriptor contains pointer to the Root Directory ICB.

The Root Directory ICB contains either the Root Directory file or pointers to the Root Directory file.

For further information on UDF, refer to OSTA UDF specification, available from <http://www.osta.org/>

J-2 Read compatibility issue of AVDP and VAT ICB at end LBA

When DVD-R SL Ver. 2.1 or DVD-RW SL Ver. 1.2 medium is mounted, the host may not obtain correct disc capacity via READ CAPACITY command and READ TOC/PMA/ATIP command (LBA mode). Because DVD logical units that does not support these media format may read Outer limit of Data Recordable area field on DVD-R SL Ver. 2.1 or DVD-RW SL Ver. 1.2 media in reading the position End PSN of Data Area field of DVD-ROM media. The value reported by such DVD logical unit does not represent the END LBA. See Table 24 - *Data Area Allocation field definition* on page 98. The reported End LBA sector may be out of Lead-out Area and may be un-recorded. When a host fail to read the END LBA, the host should not attempt to retry reading to avoid repetitive Pick-up overrun error.

Implementation note:

To detect DVD-R SL Ver. 2.1/-RW SL Ver. 1.2 media compatibility of DVD logical unit, the following sequence is recommended:

1. Check READ CAPACITY Data returned by READ CAPACITY command and address of the End physical sector number of the Data area field returned by READ DISC STRUCTURE command with Format Code 00h.

If the READ CAPACITY Data and End physical sector number of the Data area - 30000h are the same value, there is possibility that the DVD read-only logical unit does not support reading of DVD-R SL Ver. 2.1/-RW SL Ver. 1.2 media format correctly.

2. Check if Format Code 0Ch of READ DISC STRUCTURE command is supported. To examine the supported DVD Structures, the READ DISC STRUCTURE command with Format Code FFh is used.

If a DVD read-only logical unit supports Format Code 0Ch of READ DISC STRUCTURE command, the logical unit supports multi-border reading and is able to read DVD-R SL Ver. 2.1/-RW SL Ver. 1.2 media format correctly.

J-3 Retrieval method of end LBA for read-only logical unit

For CD-R/RW media, when READ CAPACITY command is issued, read-only logical unit calculates capacity from Lead-out Track Start Address that is recorded in the last addressable TOC. This value is correct for CD-R/RW disc which is recorded by SAO/DAO. But for Packet/TAO recording method, this value may not be correct because Link sector and Run-out sectors may exist before Lead-out Track. In the case of Packet recorded disc, END LBA may be Lead-out Track Start Address - 3.

For DVD-R/RW media, the last sector address of user data is registered in Lead-in/Border-in. Then read-only logical unit can report correct address of END LBA via READ CAPACITY command. In the case of READ TOC/PMA/ATIP command, END LBA is Lead-out Track Start Address - 1.

