

Working Draft American National Standard



Project T10/1760-D



Revision 14
28 January 2008

Information technology - Serial Attached SCSI - 2 (SAS-2)



This is an internal working document of T10, a Technical Committee of Accredited Standards Committee INCITS (International Committee for Information Technology Standards). As such this is not a completed standard and has not been approved. The contents may be modified by the T10 Technical Committee. The contents are actively being modified by T10. This document is made available for review and comment only.

Permission is granted to members of INCITS, its technical committees, and their associated task groups to reproduce this document for the purposes of INCITS standardization activities without further permission, provided this notice is included. All other rights are reserved. Any duplication of this document for commercial or for-profit use is strictly prohibited.

T10 Technical Editor:

Robert C Elliott
Hewlett-Packard Corporation
MC 140801
PO Box 692000
Houston, TX 77269-2000
USA



Telephone: 281-518-5037
Email: elliott@hp.com



Reference number
ISO/IEC 14776-152:200x
ANSI INCITS ***-200x

Summary of Comments on Serial Attached SCSI - 2 (SAS-2) Standard

Page: i

Author: lsi-bbesmer

Subject: Note

Date: 6/30/2008 9:23:53 AM

ACCEPT - DONE (5/5 split the CONFIGURING bit into 2 bits so zoning and configuring cannot be confused. Make the zoning backoff procedure only look at the zoning reason, not the self-configuring reason. Look for other places where software needs to be advised to look at both bits, not just one.

Specifically, make the existing CONFIGURING bit the OR of the two reasons for best backwards compatibility, but add 2 extra bits explaining the reason for any software that cares.

See comments added in 10.4.3.4 to add the new bits.

)

The CONFIGURING bit is (unfortunately) overloaded by both zoning and the self-discovery process. There are several cases like:

...shall set the CONFIGURING bit to zero when...

That is not correct behavior when both processes are outstanding.

Author: lsi-bbesmer

Subject: Note

Date: 7/14/2008 7:52:22 PM

ACCEPT - DONE (7/14 review by Brad says r14c looks good. 5/5 use "current" everywhere, fix the few remaining "active"s. Add "current" prefix ahead of bare ZPT everywhere that it is important.)

Global:

I think we have a problem with the generic term "zone permission table". We have several "zone permission tables" defined:

- Current
- Shadow
- Default
- Saved

Collectively, all 4 of these may be referred to "zone permission tables".

I think most current usages are intended to be "current zone permission table".

There are also 2 instance of "active zone permission table", which is undefined and I think really are "current zone permission table".

This same concern applies to the term "active values".

The most obvious changes to me are:

- 1) Use "active" instead of "current" throughout when referring to zoning permission tables and zone manager password (I counted 25 occurrences that would need to be changed).
- 2) add "active" qualifier added to several instances of "zone permission table".

Author: RElliott

Subject: Note

Date: 9/4/2008 5:41:35 PM

Comments from page i continued on next page



Working Draft American National Standard



Project T10/1760-D



Revision 14
28 January 2008

Information technology - Serial Attached SCSI - 2 (SAS-2)



This is an internal working document of T10, a Technical Committee of Accredited Standards Committee INCITS (International Committee for Information Technology Standards). As such this is not a completed standard and has not been approved. The contents may be modified by the T10 Technical Committee. The contents are actively being modified by T10. This document is made available for review and comment only.

Permission is granted to members of INCITS, its technical committees, and their associated task groups to reproduce this document for the purposes of INCITS standardization activities without further permission, provided this notice is included. All other rights are reserved. Any duplication of this document for commercial or for-profit use is strictly prohibited.

T10 Technical Editor:

Robert C Elliott
Hewlett-Packard Corporation
MC 140801
PO Box 692000
Houston, TX 77269-2000
USA



Telephone: 281-518-5037
Email: elliott@hp.com



Reference number
ISO/IEC 14776-152:200x
ANSI INCITS ***-200x

 ACCEPT - DONE
Author

Total comments:
| Accept - Done:
| | Accept - Todo:
| | | Accept - Last:
| | | | Accept (only):
| | | | | Reject - Todo:
| | | | | Reject (only):
| | | | | Refer PHY:
| | | | | Refer PROTOCOL:
| | | | | Refer:
| | | | | Todo (only):
| | | | | Total worked:
| | | | | Left:

Chapter 0: 24 10 0 1 0 0 12 0 0 0 0 23 1
Chapter 1: 5 4 0 0 0 0 1 0 0 0 0 5 0
Chapter 10: 591 484 0 0 0 0 107 0 0 0 0 591 0
Chapter 11: 24 15 0 0 0 0 9 0 0 0 0 24 0
Chapter 12: 138 89 0 7 0 0 42 0 0 0 0 138 0
Chapter 13: 26 16 0 0 0 0 10 0 0 0 0 26 0
Chapter 2: 16 13 0 0 0 0 3 0 0 0 0 16 0
Chapter 3: 203 153 0 2 0 0 48 0 0 0 0 203 0
Chapter 4: 418 318 0 0 0 0 99 0 1 0 0 418 0
Chapter 5: 437 234 2 0 0 0 109 81 0 0 0 426 11
Chapter 6: 405 279 0 1 0 0 125 0 0 0 0 405 0
Chapter 7: 806 564 0 1 0 0 241 0 0 0 0 806 0
Chapter 8: 70 50 0 0 0 0 14 0 6 0 0 70 0
Chapter 9: 359 298 0 0 0 0 60 0 1 0 0 359 0
CoxA: 1 1 0 0 0 0 0 0 0 0 0 1 0
RElliott: 1603 1553 0 9 0 0 30 3 7 0 0 1602 1
elx-bmartin: 66 48 0 0 0 0 18 0 0 0 0 66 0
elx-nayalasomayajula: 2 0 0 0 0 0 2 0 0 0 0 2 0
hpq-bolawsky: 15 11 0 0 0 0 4 0 0 0 0 15 0
hpq-curtisb: 1 1 0 0 0 0 0 0 0 0 0 1 0
hpq-relliott: 59 48 1 0 0 0 5 4 1 0 0 59 0
ibm-jay-diepenbrock: 4 0 0 0 0 0 4 0 0 0 0 4 0
ibm-pcashman: 2 0 0 0 0 0 2 0 0 0 0 2 0
ibm-sandy-shirk-heath: 1 0 0 0 0 0 1 0 0 0 0 1 0
ibm-steve-wallace: 4 2 0 0 0 0 2 0 0 0 0 4 0
ibm-ted-vojnovich: 4 0 1 0 0 0 3 0 0 0 0 4 0
ifx-hnewman: 9 5 0 0 0 0 2 2 0 0 0 9 0
intc-mseidel: 43 19 0 0 0 0 21 3 0 0 0 43 0
ktek-dmoore: 16 13 0 0 0 0 3 0 0 0 0 16 0
lsi-bbesmer: 86 67 0 0 0 0 19 0 0 0 0 86 0
lsi-bday: 81 63 0 0 0 0 18 0 0 0 0 81 0
lsi-gpenokie: 519 278 0 2 0 0 226 13 0 0 0 519 0
lsi-jenkins: 16 5 0 0 0 0 11 0 0 0 0 16 0
mxim-kwitt: 45 7 0 0 0 0 1 26 0 0 0 34 11
mxim-mbari: 14 7 0 0 0 0 4 3 0 0 0 14 0
pmcs-gfortin: 33 13 0 0 0 0 6 14 0 0 0 33 0
pmcs-rhernandez: 1 0 0 0 0 0 1 0 0 0 0 1 0
pmcs-tsymons: 1 1 0 0 0 0 0 0 0 0 0 1 0
stx-alvin-cox: 25 16 0 0 0 0 9 0 0 0 0 25 0
stx-ghoulder: 148 75 0 0 0 0 73 0 0 0 0 148 0
wdc-mevans: 723 294 0 1 0 0 426 2 0 0 0 723 0

Author: RElliott
Subject: Note
Date: 9/4/2008 5:42:26 PM
 ACCEPT - DONE

Comments from page i continued on next page



Working Draft

American National Standard



Project T10/1760-D



Revision 14
28 January 2008

Information technology - Serial Attached SCSI - 2 (SAS-2)



This is an internal working document of T10, a Technical Committee of Accredited Standards Committee INCITS (International Committee for Information Technology Standards). As such this is not a completed standard and has not been approved. The contents may be modified by the T10 Technical Committee. The contents are actively being modified by T10. This document is made available for review and comment only.

Permission is granted to members of INCITS, its technical committees, and their associated task groups to reproduce this document for the purposes of INCITS standardization activities without further permission, provided this notice is included. All other rights are reserved. Any duplication of this document for commercial or for-profit use is strictly prohibited.

T10 Technical Editor:

Robert C Elliott
Hewlett-Packard Corporation
MC 140801
PO Box 692000
Houston, TX 77269-2000
USA



Telephone: 281-518-5037
Email: elliott@hp.com



Reference number
ISO/IEC 14776-152:200x
ANSI INCITS ***-200x

WARNING: comment statuses updated between Wed 5/21 10pm and Sat 5/24 9 am were lost as the Physical WG responses were merged on 5/24. For some reason, some of the imported comments had later dates in the .fdf than their updated duplicates, even though they were really older. Comment statuses were restored based on the 5/21 file, but some will be missed. New comments added between 5/21 and 5/24 appear to have survived.

NOTE: the 12 open comments are bogus (from the counting program)

Total comments: 3522
Accept - Done: 2527 (71.75%)
Accept - Last: 12 (0.34%)
Accept - Todo: 2 (0.06%)
Accept (only): 0 (0.00%)
Reject - Todo: 0 (0.00%)
Reject (only): 880 (24.99%)
Refer PHY: 81 (2.30%)
Refer PROTOCOL: 8 (0.23%)
Refer: 0 (0.00%)
Todo (only): 0 (0.00%)
Total worked: 3510 (99.66%)
Left: 12 (0.34%)

Author: RElliott
Subject: Note
Date: 6/30/2008 6:16:52 PM

 ACCEPT - DONE

Change the column widths of every Byte\Bit table to be:
0.7" for the Byte\Bit column
6.0" evenly distributed for the 7 .. 0 columns

except where this causes unpleasant text wrapping in any of the cells. In exceptions, use a combination of smaller fonts and uneven columns.

Author: RElliott
Subject: Note
Date: 7/14/2008 2:21:13 PM

 REJECT (7/14 WG wants to defer to SAS-2.1)

Incorporate 08-064 SAS-2 SPC-4 Differentiate between ACK/NAK timeout reasons

Author: RElliott
Subject: Note
Date: 6/30/2008 6:16:52 PM

 ACCEPT - DONE

Change " - " to " " whenever it used for a range. This avoids confusion with the minus sign (for mathematical expressions) and the hyphen, en dash, and em dash (grammatical conjunction), which look the same.

Author: ibm-pcashman
Subject: Note
Date: 5/6/2008 4:07:47 PM

 REJECT (The hard reset sequence - a link reset sequence with a HARD_RESET primitive - sends a SCSI "hard reset" to an end device (target or initiator). That's the deepest reset available in the protocol. Expanders ignore it; there is no sequence you can send to one phy of an expander to mess up all the other phys. Resetting an embedded SES logical unit inside an expander might have the effect of resetting the switch functionality as well (that's vendor-specific))

At the enterprise level there is a need to have an attached SAS device perform a deep reset, where all device software or firmware is re-initialised. [Typically in this scenario, enterprise would ask for a debug dump to be taken for future analysis too.] This would equate to a reset at the protocol level. This reset should apply to all devices, expanders, drives etc.
I don't see how is this done in SAS?

Comments from page i continued on next page



Working Draft

American National Standard



Project T10/1760-D



Revision 14
28 January 2008

Information technology - Serial Attached SCSI - 2 (SAS-2)



This is an internal working document of T10, a Technical Committee of Accredited Standards Committee INCITS (International Committee for Information Technology Standards). As such this is not a completed standard and has not been approved. The contents may be modified by the T10 Technical Committee. The contents are actively being modified by T10. This document is made available for review and comment only.

Permission is granted to members of INCITS, its technical committees, and their associated task groups to reproduce this document for the purposes of INCITS standardization activities without further permission, provided this notice is included. All other rights are reserved. Any duplication of this document for commercial or for-profit use is strictly prohibited.

T10 Technical Editor:

Robert C Elliott
Hewlett-Packard Corporation
MC 140801
PO Box 692000
Houston, TX 77269-2000
USA



Telephone: 281-518-5037
Email: elliott@hp.com



Reference number
ISO/IEC 14776-152:200x
ANSI INCITS ***-200x

Author: ibm-pcashman

Subject: Note

Date: 5/25/2008 4:29:51 PM

 REJECT (5/5 EPOW = early power off warning. See NOTIFY (POWER LOSS EXPECTED) is for)

At the enterprise level and possibly for other environments, there is also a need to specify behaviour for EPOW. SAS seems to have no method of indicating EPOW to devices, potentially leaving disk systems with 'damaged' sectors that will then fail on array rebuilds, causing data loss. This is unacceptable for the enterprise market and some method of signalling EPOW is required.

Author: ibm-sandy-shirk-heath

Subject: Note

Date: 5/25/2008 4:31:06 PM

 REJECT (Those are items that would go in the SFF specs for the connectors, not in this standard)

Proposal posted with items that need to be covered:

08-186r0.pdf

Points of Contact

International Committee for Information Technology Standards (INCITS) T10 Technical Committee

T10 Chair

John B. Lohmeyer
LSI Corporation
4420 ArrowsWest Drive
Colorado Springs, CO 80907-3444
USA

Telephone: (719) 533-7560
Email: lohmeier@t10.org

T10 Vice-Chair

Mark S. Evans
Western Digital Corporation
5836 Rue Ferrari
San Jose, CA 95138
USA

Telephone: (408) 363-5257
Email: mark.evans@wdc.com

T10 Web Site: <http://www.t10.org>

T10 E-mail reflector:

Server: majordomo@t10.org

To subscribe send e-mail with 'subscribe' in message body

To unsubscribe send e-mail with 'unsubscribe' in message body

INCITS Secretariat

Suite 200
1250 Eye Street, NW
Washington, DC 20005
USA

Telephone: 202-737-8888
Web site: <http://www.incits.org>
Email: incits@itic.org

Information Technology Industry Council

Web site: <http://www.itic.org>

Document Distribution

INCITS Online Store
managed by Techstreet
1327 Jones Drive
Ann Arbor, MI 48105
USA

Web site: <http://www.techstreet.com/incits.html>
Telephone: (734) 302-7801 or (800) 699-9277

Global Engineering Documents, an IHS Company
15 Inverness Way East
Englewood, CO 80112-5704
USA

Web site: <http://global.ihs.com>
Telephone: (303) 397-7956 or (303) 792-2181 or (800) 854-7179

This page contains no comments

American National Standard
for Information Technology

Serial Attached SCSI - 2 (SAS-2)

Secretariat
Information Technology Industry Council

Approved mm.dd.yy
American National Standards Institute, Inc.

ABSTRACT

This standard specifies the functional requirements for the Serial Attached SCSI (SAS) physical interconnect, which is compatible with the Serial ATA physical interconnect. It also specifies three transport protocols, one to transport SCSI commands, another to transport Serial ATA commands to multiple SATA devices, and a third to support interface management. This standard is intended to be used in conjunction with SCSI and ATA command set standards.

Author: intc-mseidel

Subject: Highlight

Date: 5/25/2008 4:33:04 PM

T REJECT (close enough for an abstract)

Is SAS always intended to be compatible with SATA physical interconnect? There are issues of keying, and perhaps there are conditions for some blocks that don't support SATA 6G that may not meet their performance. It is a goal, but SATA 6G is a moving target.

American National Standard

Approval of an American National Standard requires verification by ANSI that the requirements for due process, consensus, and other criteria for approval have been met by the standards developer. Consensus is established when, in the judgment of the ANSI Board of Standards Review, substantial agreement has been reached by directly and materially affected interests. Substantial agreement means much more than a simple majority, but not necessarily unanimity. Consensus requires that all views and objections be considered, and that effort be made towards their resolution.

The use of American National Standards is completely voluntary; their existence does not in any respect preclude anyone, whether he has approved the standards or not, from manufacturing, marketing, purchasing, or using products, processes, or procedures not conforming to the standards.

The American National Standards Institute does not develop standards and will in no circumstances give interpretation on any American National Standard. Moreover, no person shall have the right or authority to issue an interpretation of an American National Standard in the name of the American National Standards Institute. Requests for interpretations should be addressed to the secretariat or sponsor whose name appears on the title page of this standard.

CAUTION NOTICE: This American National Standard may be revised or withdrawn at any time. The procedures of the American National Standards Institute require that action be taken periodically to reaffirm, revise, or withdraw this standard. Purchasers of American National Standards may receive current information on all standards by calling or writing the American National Standards Institute.

CAUTION: The developers of this standard have requested that holders of patents that may be required for the implementation of the standard, disclose such patents to the publisher. However, neither the developers nor the publisher have undertaken a patent search in order to identify which, if any, patents may apply to this standard.

As of the date of publication of this standard, following calls for the identification of patents that may be required for the implementation of the standard, notice of one or more claims has been received.

By publication of this standard, no position is taken with respect to the validity of this claim or of any rights in connection therewith. The known patent holder(s) has (have), however, filed a statement of willingness to grant a license under these rights on reasonable and nondiscriminatory terms and conditions to applicants desiring to obtain such a license. Details may be obtained from the publisher.

No further patent search is conducted by the developer or the publisher in respect to any standard it processes. No representation is made or implied that licenses are not required to avoid infringement in the use of this standard.

Published by

**American National Standards Institute
11 W. 42nd Street, New York, New York 10036**

Copyright © 2008 by Information Technology Industry Council (ITI). All rights reserved.

No part of this publication may be reproduced in any form, in an electronic retrieval system or otherwise, without prior written permission of ITI, 1250 Eye Street NW, Suite 200, Washington, DC 20005.

Printed in the United States of America

This page contains no comments

Contents

	Page
1 Scope	1
2 Normative references	3
2.1 Normative references	3
2.2 Approved references	3
2.3 References under development	3
2.4 Other references	4
3 Definitions, symbols, abbreviations, keywords, and conventions	5
3.1 Definitions	5
3.2 Symbols and abbreviations	21
3.3 Keywords	25
3.4 Editorial conventions	26
3.5 Class diagram and object diagram conventions	27
3.6 State machine conventions	31
3.6.1 State machine conventions overview	31
3.6.2 Transitions	31
3.6.3 Messages, requests, indications, confirmations, responses, and event notifications	32
3.6.4 State machine counters, timers, and variables	32
3.6.5 State machine arguments	32
3.7 Bit and byte ordering	33
3.8 Notation for procedures and functions	33
4 General	34
4.1 Architecture	34
4.1.1 Architecture overview	34
4.1.2 Physical links and phys	35
4.1.3 Logical links	40
4.1.4 Ports (narrow ports and wide ports)	40
4.1.5 Application clients and device servers	43
4.1.6 SAS devices	44
4.1.7 Expander devices	45
4.1.8 Service delivery subsystem	46
4.1.9 Domains	46
4.1.10 Expander device topologies	49
4.1.10.1 Expander device topology overview	49
4.1.10.2 Expander device topologies	49
4.1.11 Pathways	51
4.1.12 Connections	51
4.1.13 Broadcasts	53
4.2 Names and identifiers	55
4.2.1 Names and identifiers overview	55
4.2.2 NAA IEEE Registered format identifier	56
4.2.3 Hashed SAS addresses	57
4.2.4 Device names and expander device SAS addresses	57
4.2.5 Device name for SATA devices with world wide names	58
4.2.6 Port names	58
4.2.7 Port identifiers and SAS port SAS addresses	58
4.2.8 Phy identifiers	59
4.3 State machines	59
4.3.1 State machine overview	59
4.3.2 Transmit data path	60
4.3.3 Receive data path	65
4.3.4 State machines and SAS Device, SAS Port, and SAS Phy classes	68

Page: v

Author: intc-mseidel

Subject: Highlight

Date: 5/25/2008 4:33:30 PM

TREJECT (the wraparound are all reasonably formatted in the table. FrameMaker has been known to have anomalies where it doesn't place the page number on the right any more, but that is not the case here)

Fix long section names so that the wrap-around does not clutter the page number portion.

4.4 Resets	69
4.4.1 Reset overview	69
4.4.2 Hard reset	71
4.4.2.1 Hard reset overview	71
4.4.2.2 Additional hard reset processing by SAS ports	71
4.4.2.3 Additional hard reset processing by expander ports	71
4.5 I_T nexus loss	71
4.6 Expander device model	72
4.6.1 Expander device model overview	72
4.6.2 Expander ports.....	73
4.6.3 Expander connection manager (ECM).....	74
4.6.4 Expander connection router (ECR).....	74
4.6.5 Broadcast propagation processor (BPP)	75
4.6.6 Expander device interfaces.....	75
4.6.6.1 Expander device interface overview.....	75
4.6.6.2 Expander device interfaces detail	77
4.6.6.3 ECM interface.....	78
4.6.6.4 ECR interface	79
4.6.6.5 BPP interface	80
4.6.7 Expander device routing	82
4.6.7.1 Routing attributes and routing methods	82
4.6.7.2 Connection request routing	82
4.6.7.3 Expander route table	83
4.6.7.3.1 Expander route table overview	83
4.6.7.3.2 Phy-based expander route table.....	84
4.6.7.3.3 Expander-based expander route table	85
4.6.8 Expander device reduced functionality	85
4.7 Discover process	86
4.7.1 Discover process overview	86
4.7.2 Discover process in a self-configuring expander device	88
4.7.3 Enabling multiplexing	89
4.8 Configuration subprocess.....	89
4.8.1 Configuration subprocess overview	89
4.8.2 Allowed topologies	89
4.8.3 Route table optimization	90
4.8.4 Expander route index order	91
4.9 Zoning.....	97
4.9.1 Zoning overview.....	97
4.9.2 Zoning expander device requirements.....	101
4.9.3 Zoning operation	103
4.9.3.1 Zone phy information.....	103
4.9.3.2 Zone groups	106
4.9.3.3 Zone permission table	106
4.9.3.4 Zoning expander route table	108
4.9.3.5 Source zone group and destination zone group determination	108
4.9.4 Zone phy information and link reset sequences	110
4.9.5 Broadcast processing in a zoning expander device with zoning enabled	112
4.9.6 Zone configuration	113
4.9.6.1 Zone configuration overview	113
4.9.6.2 Lock step	113
4.9.6.3 Load step.....	114
4.9.6.4 Activate step.....	114
4.9.6.5 Unlock step.....	115
4.9.6.6 Zone lock inactivity timer	115
4.9.6.7 Enable a zoning expander device	116
4.10 Phy test functions	116
4.11 Phy events.....	116

This page contains no comments

5 Physical layer	121
5.1 Physical layer overview	121
5.2 Passive interconnect	121
5.2.1 SATA connectors and cable assemblies	121
5.2.2 SAS connectors and cables	121
5.2.3 Connectors	126
5.2.3.1 Connectors overview	126
5.2.3.2 SAS internal connectors	127
5.2.3.2.1 SAS Drive connectors	127
5.2.3.2.1.1 SAS Drive plug connector	127
5.2.3.2.1.2 SAS Drive cable receptacle connector	127
5.2.3.2.1.3 SAS Drive backplane receptacle connector	128
5.2.3.2.1.4 SAS Drive connector pin assignments	129
5.2.3.2.2 SAS 4i connectors	131
5.2.3.2.2.1 SAS 4i cable receptacle connector	131
5.2.3.2.2.2 SAS 4i plug connector	131
5.2.3.2.2.3 SAS 4i connector pin assignments	132
5.2.3.2.3 Mini SAS 4i connectors	134
5.2.3.2.3.1 Mini SAS 4i cable plug connector	134
5.2.3.2.3.2 Mini SAS 4i receptacle connector	134
5.2.3.2.3.3 Mini SAS 4i connector pin assignments	135
5.2.3.3 SAS external connectors	137
5.2.3.3.1 SAS 4x connectors	137
5.2.3.3.1.1 SAS 4x cable plug connector	137
5.2.3.3.1.2 SAS 4x receptacle connector	137
5.2.3.3.1.3 SAS 4x connector pin assignments	139
5.2.3.3.2 Mini SAS 4x connectors	139
5.2.3.3.2.1 Mini SAS 4x cable plug connector	139
5.2.3.3.2.2 Mini SAS 4x receptacle connector	141
5.2.3.3.2.3 Mini SAS 4x connector pin assignments	144
5.2.4 Cable assemblies	144
5.2.4.1 SAS internal cable assemblies	144
5.2.4.1.1 SAS Drive cable assemblies	144
5.2.4.1.2 SAS internal symmetric cable assemblies	145
5.2.4.1.2.1 SAS internal symmetric cable assemblies overview	145
5.2.4.1.2.2 SAS internal symmetric cable assembly - SAS 4i	146
5.2.4.1.2.3 SAS internal symmetric cable assembly - Mini SAS 4i	147
5.2.4.1.2.4 SAS internal symmetric cable assembly - SAS 4i to Mini SAS 4i with vendor-specific sidebands	148
5.2.4.1.2.5 SAS internal symmetric cable assembly - SAS 4i controller to Mini SAS 4i backplane with SGPIO	150
5.2.4.1.2.6 SAS internal symmetric cable assembly - Mini SAS 4i controller to SAS 4i backplane with SGPIO	151
5.2.4.1.3 SAS internal fanout cable assemblies	152
5.2.4.1.3.1 SAS internal fanout cable assemblies overview	152
5.2.4.1.3.2 SAS internal controller-based fanout cable assemblies	153
5.2.4.1.3.3 SAS internal backplane-based fanout cable assemblies	155
5.2.4.2 SAS external cable assemblies	156
5.2.4.2.1 SAS external cable assemblies overview	156
5.2.4.2.2 SAS external cable assembly - SAS 4x	157
5.2.4.2.3 SAS external cable assembly - Mini SAS 4x	158
5.2.4.2.4 SAS external cable assembly - SAS 4x to Mini SAS 4x	160
5.2.5 Backplanes	160
5.2.6 Cable assembly and backplane specifications	161
5.3 Transmitter and receiver device electrical characteristics	163
5.3.1 Compliance points	163
5.3.2 Test loads	171

This page contains no comments

5.3.2.1 Test loads overview.....	171
5.3.2.2 Zero-length test load	171
5.3.2.3 TCTF test load.....	173
5.3.2.4 Low-loss TCTF test load	177
5.3.2.5 Reference transmitter test load	178
5.3.3 General electrical characteristics	180
5.3.3.1 General electrical characteristics overview	180
5.3.3.2 Transmitter device general electrical characteristics.....	180
5.3.3.3 TxRx connection characteristics.....	181
5.3.3.3.1 TxRx connection characteristics overview	181
5.3.3.3.2 TxRx connection characteristics for 1.5 Gbps and 3 Gbps.....	181
5.3.3.3.3 TxRx connection characteristics for 6 Gbps	181
5.3.3.4 Receiver device general electrical characteristics.....	182
5.3.4 Transmitter and receiver device transients	183
5.3.5 Eye masks and the jitter transfer function (JTF)	184
5.3.5.1 Eye masks overview.....	184
5.3.5.2 Jitter transfer function (JTF)	184
5.3.5.3 Transmitter device eye mask	185
5.3.5.4 Receiver device eye mask	186
5.3.5.5 Receiver device jitter tolerance eye mask.....	186
5.3.6 Transmitter device characteristics	188
5.3.6.1 Transmitter device characteristics overview.....	188
5.3.6.2 Transmitter device signal output characteristics as measured with the zero-length test load... 188	
5.3.6.3 Transmitter device signal output characteristics as measured with each test load.....	189
5.3.6.4 Transmitter device maximum jitter	190
5.3.6.5 Transmitter device signal output characteristics for 6 Gbps.....	192
5.3.6.5.1 Transmitter device signal output characteristics for 6 Gbps overview	192
5.3.6.5.2 Transmitter device S-parameters	193
5.3.6.5.3 Recommended transmitter device settings for interoperability	195
5.3.6.5.4 Reference transmitter device characteristics.....	196
5.3.6.5.5 Transmitter equalization measurement	196
5.3.6.6 Transmitter device signal output for OOB signals	197
5.3.7 Receiver device characteristics	198
5.3.7.1 Receiver device characteristics overview.....	198
5.3.7.2 OOB delivered signal characteristics	199
5.3.7.3 Delivered signal (receiver device signal tolerance) characteristics	199
5.3.7.4 Receiver device and delivered signal (receiver device signal tolerance) characteristics for 6 Gbps	
200	
5.3.7.4.1 Receiver device characteristics	200
5.3.7.4.2 Receiver device S-parameters	201
5.3.7.4.3 Reference receiver device	202
5.3.7.4.4 Receiver device physical testing.....	203
5.3.7.4.4.1 Receiver device physical testing overview	203
5.3.7.4.4.2 Test signal characteristics and calibration	205
5.3.7.4.4.3 Transmit waveform calibration	205
5.3.7.4.4.4 ISI generator calibration	205
5.3.7.4.4.5 ISI generator pulse response	205
5.3.7.4.4.6 Crosstalk calibration	205
5.3.7.4.4.7 Jitter tolerance.....	205
5.3.7.4.4.8 Link dispersion penalty signal processing algorithm	206
5.3.7.5 Maximum delivered jitter	206
5.3.7.6 Receiver device jitter tolerance	207
5.3.8 Spread spectrum clocking (SSC).....	207
5.3.8.1 SSC overview.....	207
5.3.8.2 Transmitter SSC modulation	209
5.3.8.3 Receiver SSC modulation tolerance	210
5.3.8.4 Expander device center-spreading tolerance buffer.....	210

This page contains no comments

5.3.9 Non-tracking clock architecture.....	211
5.4 READY LED signal electrical characteristics.....	211
6 Phy layer	213
6.1 Phy layer overview	213
6.2 8b10b coding.....	213
6.2.1 8b10b coding overview	213
6.2.2 8b10b coding introduction.....	213
6.2.3 8b10b coding notation conventions	213
6.3 Character encoding and decoding.....	214
6.3.1 Introduction	214
6.3.2 Transmission order	214
6.3.3 Data and control characters.....	215
6.3.4 Encoding characters in the transmitter	221
6.3.5 Decoding characters in the receiver	222
6.4 Dwords, primitives, data dwords, and invalid dwords.....	222
6.5 Bit order	222
6.6 Out of band (OOB) signals	224
6.6.1 OOB signals overview.....	224
6.6.2 Transmitting OOB signals	225
6.6.3 Receiving OOB signals	228
6.6.4 Transmitting the SATA port selection signal.....	230
6.7 Phy reset sequences	230
6.7.1 Phy reset sequences overview	230
6.7.2 SATA phy reset sequence	231
6.7.2.1 SATA OOB sequence	231
6.7.2.2 SATA speed negotiation sequence	232
6.7.3 SAS to SATA phy reset sequence	232
6.7.4 SAS to SAS phy reset sequence	233
6.7.4.1 SAS OOB sequence.....	233
6.7.4.2 SAS speed negotiation sequence	236
6.7.4.2.1 SAS speed negotiation sequence overview	236
6.7.4.2.2 SAS speed negotiation sequence timing specifications	237
6.7.4.2.3 Speed negotiation window (SNW) definitions.....	238
6.7.4.2.3.1 SNW definitions overview	238
6.7.4.2.3.2 SNW-1, SNW-2, and Final-SNW.....	238
6.7.4.2.3.3 SNW-3.....	239
6.7.4.2.3.4 Train-SNW	243
6.7.4.2.4 SAS speed negotiation sequence.....	245
6.7.4.3 Multiplexing sequence.....	252
6.7.5 Phy reset sequence after devices are attached.....	253
6.8 SP (phy layer) state machine	254
6.8.1 SP state machine overview.....	254
6.8.2 SP transmitter and receiver	256
6.8.3 OOB sequence states.....	258
6.8.3.1 OOB sequence states overview	258
6.8.3.2 SP0:OOB_COMINIT state.....	259
6.8.3.2.1 State description	259
6.8.3.2.2 Transition SP0:OOB_COMINIT to SP1:OOB_AwaitCOMX.....	259
6.8.3.2.3 Transition SP0:OOB_COMINIT to SP3:OOB_AwaitCOMINIT_Sent.....	260
6.8.3.2.4 Transition SP0:OOB_COMINIT to SP4:OOB_COMSAS.....	260
6.8.3.3 SP1:OOB_AwaitCOMX state	260
6.8.3.3.1 State description	260
6.8.3.3.2 Transition SP1:OOB_AwaitCOMX to SP0:OOB_COMINIT.....	260
6.8.3.3.3 Transition SP1:OOB_AwaitCOMX to SP4:OOB_COMSAS	260
6.8.3.4 SP2:OOB_NoCOMSASTimeout state.....	260
6.8.3.4.1 State description	260

This page contains no comments

6.8.3.4.2	Transition SP2:OOB_NoCOMSASTimeout to SP0:OOB_COMINIT	261
6.8.3.4.3	Transition SP2:OOB_NoCOMSASTimeout to SP4:OOB_COMSAS	261
6.8.3.5	SP3:OOB_AwaitCOMINIT_Sent state	261
6.8.3.5.1	State description	261
6.8.3.5.2	Transition SP3:OOB_AwaitCOMINIT_Sent to SP4:OOB_COMSAS	261
6.8.3.6	SP4:OOB_COMSAS state	261
6.8.3.6.1	State description	261
6.8.3.6.2	Transition SP4:OOB_COMSAS to SP5:OOB_AwaitCOMSAS_Sent	261
6.8.3.6.3	Transition SP4:OOB_COMSAS to SP6:OOB_AwaitNoCOMSAS	261
6.8.3.6.4	Transition SP4:OOB_COMSAS to SP7:OOB_AwaitCOMSAS	262
6.8.3.7	SP5:OOB_AwaitCOMSAS_Sent state	262
6.8.3.7.1	State description	262
6.8.3.7.2	Transition SP5:OOB_AwaitCOMSAS_Sent to SP6:OOB_AwaitNoCOMSAS	262
6.8.3.8	SP6:OOB_AwaitNoCOMSAS state	262
6.8.3.8.1	State description	262
6.8.3.8.2	Transition SP6:OOB_AwaitNoCOMSAS to SP0:OOB_COMINIT	262
6.8.3.8.3	Transition SP6:OOB_AwaitNoCOMSAS to SP8:SAS_Start	262
6.8.3.9	SP7:OOB_AwaitCOMSAS state	262
6.8.3.9.1	State description	262
6.8.3.9.2	Transition SP7:OOB_AwaitCOMSAS to SP2:OOB_NoCOMSASTimeout	262
6.8.3.9.3	Transition SP7:OOB_AwaitCOMSAS to SP6:OOB_AwaitNoCOMSAS	262
6.8.3.9.4	Transition SP7:OOB_AwaitCOMSAS to SP16:SATA_COMWAKE	263
6.8.3.9.5	Transition SP7:OOB_AwaitCOMSAS to SP26:SATA_SpinupHold	263
6.8.4	SAS speed negotiation states	263
6.8.4.1	SAS speed negotiation states overview	263
6.8.4.2	SP8:SAS_Start state	265
6.8.4.2.1	State description	265
6.8.4.2.2	Transition SP8:SAS_Start to SP0:OOB_COMINIT	266
6.8.4.2.3	Transition SP8:SAS_Start to SP1:OOB_AwaitCOMX	266
6.8.4.2.4	Transition SP8:SAS_Start to SP9:SAS_WindowNotSupported	266
6.8.4.2.5	Transition SP8:SAS_Start to SP10:SAS_AwaitALIGN	266
6.8.4.2.6	Transition SP8:SAS_Start to SP27:SAS_Settings	266
6.8.4.3	SP9:SAS_WindowNotSupported state	266
6.8.4.3.1	State description	266
6.8.4.3.2	Transition SP9:SAS_WindowNotSupported to SP14:SAS_Fail	266
6.8.4.4	SP10:SAS_AwaitALIGN state	267
6.8.4.4.1	State description	267
6.8.4.4.2	Transition SP10:SAS_AwaitALIGN to SP0:OOB_COMINIT	267
6.8.4.4.3	Transition SP10:SAS_AwaitALIGN to SP11:SAS_AwaitALIGN1	267
6.8.4.4.4	Transition SP10:SAS_AwaitALIGN to SP12:SAS_AwaitSNW	267
6.8.4.4.5	Transition SP10:SAS_AwaitALIGN to SP14:SAS_Fail	267
6.8.4.5	SP11:SAS_AwaitALIGN1 state	267
6.8.4.5.1	State description	267
6.8.4.5.2	Transition SP11:SAS_AwaitALIGN1 to SP0:OOB_COMINIT	267
6.8.4.5.3	Transition SP11:SAS_AwaitALIGN1 to SP12:SAS_AwaitSNW	267
6.8.4.5.4	Transition SP11:SAS_AwaitALIGN1 to SP14:SAS_Fail	267
6.8.4.6	SP12:SAS_AwaitSNW state	268
6.8.4.6.1	State description	268
6.8.4.6.2	Transition SP12:SAS_AwaitSNW to SP0:OOB_COMINIT	268
6.8.4.6.3	Transition SP12:SAS_AwaitSNW to SP13:SAS_Pass	268
6.8.4.7	SP13:SAS_Pass state	268
6.8.4.7.1	State description	268
6.8.4.7.2	Transition SP13:SAS_Pass to SP0:OOB_COMINIT	268
6.8.4.7.3	Transition SP13:SAS_Pass to SP8:SAS_Start	268
6.8.4.7.4	Transition SP13:SAS_Pass to SP15:SAS_PHY_Ready	268
6.8.4.8	SP14:SAS_Fail state	268
6.8.4.8.1	State description	268

This page contains no comments

6.8.4.8.2	Transition SP14:SAS_Fail to SP1:OOB_AwaitCOMX.....	268
6.8.4.8.3	Transition SP14:SAS_Fail to SP8:SAS_Start.....	269
6.8.4.9	SP15:SAS_PHY_Ready state.....	269
6.8.4.9.1	State description.....	269
6.8.4.9.2	Transition SP15:SAS_PHY_Ready to SP0:OOB_COMINIT	269
6.8.4.10	SP27:SAS_Settings state.....	269
6.8.4.10.1	State description.....	269
6.8.4.10.2	Transition SP27:SAS_Settings to SP0:OOB_COMINIT	270
6.8.4.10.3	Transition SP27:SAS_Settings to SP1:OOB_AwaitCOMX.....	270
6.8.4.10.4	Transition SP27:SAS_Settings to SP8:SAS_Start	270
6.8.4.10.5	Transition SP27:SAS_Settings to SP28:SAS_TrainSetup	270
6.8.4.11	SP28:SAS_TrainSetup.....	270
6.8.4.11.1	State description.....	270
6.8.4.11.2	Transition SP28:SAS_TrainSetup to SP0:OOB_COMINIT	270
6.8.4.11.3	Transition SP28:SAS_TrainSetup to SP29:SAS_Train	270
6.8.4.12	SP29:SAS_Train state	271
6.8.4.12.1	State description.....	271
6.8.4.12.2	Transition SP29:SAS_Train to SP0:OOB_COMINIT.....	271
6.8.4.12.3	Transition SP29:SAS_Train to SP1:OOB_AwaitCOMX	271
6.8.4.12.4	Transition SP29:SAS_Train to SP30:SAS_TrainingDone	271
6.8.4.12.5	Transition SP29:SAS_Train to SP28:SAS_TrainSetup	271
6.8.4.13	SP30:SAS_TrainingDone state	271
6.8.4.13.1	State description.....	271
6.8.4.13.2	Transition SP30:SAS_TrainingDone to SP0:OOB_COMINIT	272
6.8.4.13.3	Transition SP30:SAS_TrainingDone to SP1:OOB_AwaitCOMX	272
6.8.4.13.4	Transition SP30:SAS_TrainingDone to SP28:SAS_TrainSetup.....	272
6.8.4.13.5	Transition SP30:SAS_TrainingDone to SP15:SAS_PHY_Ready.....	272
6.8.5	SATA host emulation states.....	272
6.8.5.1	SATA host emulation states overview.....	272
6.8.5.2	SP16:SATA_COMWAKE state	274
6.8.5.2.1	State description.....	274
6.8.5.2.2	Transition SP16:SATA_COMWAKE to SP17:SATA_AwaitCOMWAKE	274
6.8.5.3	SP17:SATA_AwaitCOMWAKE state.....	274
6.8.5.3.1	State description.....	274
6.8.5.3.2	Transition SP17:SATA_AwaitCOMWAKE to SP0:OOB_COMINIT	274
6.8.5.3.3	Transition SP17:SATA_AwaitCOMWAKE to SP18:SATA_AwaitNoCOMWAKE	274
6.8.5.4	SP18:SATA_AwaitNoCOMWAKE state	274
6.8.5.4.1	State description.....	274
6.8.5.4.2	Transition SP18:SATA_AwaitNoCOMWAKE to SP0:OOB_COMINIT	274
6.8.5.4.3	Transition SP18:SATA_AwaitNoCOMWAKE to SP19:SATA_AwaitALIGN.....	274
6.8.5.5	SP19:SATA_AwaitALIGN state.....	274
6.8.5.5.1	State description.....	274
6.8.5.5.2	Transition SP19:SATA_AwaitALIGN to SP0:OOB_COMINIT	274
6.8.5.5.3	Transition SP19:SATA_AwaitALIGN to SP20:SATA_AdjustSpeed.....	275
6.8.5.6	SP20:SATA_AdjustSpeed state	275
6.8.5.6.1	State description.....	275
6.8.5.6.2	Transition SP20:SATA_AdjustSpeed to SP0:OOB_COMINIT	275
6.8.5.6.3	Transition SP20:SATA_AdjustSpeed to SP21:SATA_TransmitALIGN	275
6.8.5.7	SP21:SATA_TransmitALIGN state.....	275
6.8.5.7.1	State description.....	275
6.8.5.7.2	Transition SP21:SATA_TransmitALIGN to SP0:OOB_COMINIT	275
6.8.5.7.3	Transition SP21:SATA_TransmitALIGN to SP22:SATA_PHY_Ready	275
6.8.5.8	SP22:SATA_PHY_Ready state.....	275
6.8.5.8.1	State description.....	275
6.8.5.8.2	Transition SP22:SATA_PHY_Ready to SP0:OOB_COMINIT	276
6.8.5.8.3	Transition SP22:SATA_PHY_Ready to SP23:SATA_PM_Partial	276
6.8.5.8.4	Transition SP22:SATA_PHY_Ready to SP24:SATA_PM_Slumber	276

This page contains no comments

6.8.5.9 SP23:SATA_PM_Partial state	276
6.8.5.9.1 State description	276
6.8.5.9.2 Transition SP23:SATA_PM_Partial to SP0:OOB_COMINIT	276
6.8.5.9.3 Transition SP23:SATA_PM_Partial to SP16:SATA_COMWAKE	276
6.8.5.9.4 Transition SP23:SATA_PM_Partial to SP18:SATA_AwaitNoCOMWAKE	276
6.8.5.10 SP24:SATA_PM_Slumber state	276
6.8.5.10.1 State description	276
6.8.5.10.2 Transition SP24:SATA_PM_Slumber to SP0:OOB_COMINIT	276
6.8.5.10.3 Transition SP24:SATA_PM_Slumber to SP16:SATA_COMWAKE	277
6.8.5.10.4 Transition SP24:SATA_PM_Slumber to SP18:SATA_AwaitNoCOMWAKE	277
6.8.6 SATA port selector state SP25:SATA_PortSel	277
6.8.6.1 State description	277
6.8.6.2 Transition SP25:SATA_PortSel to SP1:OOB_AwaitCOMX	277
6.8.7 SATA spinup hold state SP26:SATA_SpinupHold	278
6.8.7.1 State description	278
6.8.7.2 Transition SP26:SATA_SpinupHold to SP0:OOB_COMINIT	278
6.9 SP_DWS (phy layer dword synchronization) state machine	278
6.9.1 SP_DWS state machine overview	278
6.9.2 SP_DWS receiver	280
6.9.3 SP_DWS0:AcquireSync state	281
6.9.3.1 State description	281
6.9.3.2 Transition SP_DWS0:AcquireSync to SP_DWS1:Valid1	281
6.9.4 SP_DWS1:Valid1 state	281
6.9.4.1 State description	281
6.9.4.2 Transition SP_DWS1:Valid1 to SP_DWS0:AcquireSync	281
6.9.4.3 Transition SP_DWS1:Valid1 to SP_DWS2:Valid2	282
6.9.5 SP_DWS2:Valid2 state	282
6.9.5.1 State description	282
6.9.5.2 Transition SP_DWS2:Valid2 to SP_DWS0:AcquireSync	282
6.9.5.3 Transition SP_DWS2:Valid2 to SP_DWS3:SyncAcquired	282
6.9.6 SP_DWS3:SyncAcquired state	282
6.9.6.1 State description	282
6.9.6.2 Transition SP_DWS3:SyncAcquired to SP_DWS0:AcquireSync	282
6.9.6.3 Transition SP_DWS3:SyncAcquired to SP_DWS4:Lost1	282
6.9.7 SP_DWS4:Lost1 state	282
6.9.7.1 State description	282
6.9.7.2 Transition SP_DWS4:Lost1 to SP_DWS0:AcquireSync	282
6.9.7.3 Transition SP_DWS4:Lost1 to SP_DWS5:Lost1Recovered	282
6.9.7.4 Transition SP_DWS4:Lost1 to SP_DWS6:Lost2	283
6.9.8 SP_DWS5:Lost1Recovered state	283
6.9.8.1 State description	283
6.9.8.2 Transition SP_DWS5:Lost1Recovered to SP_DWS0:AcquireSync	283
6.9.8.3 Transition SP_DWS5:Lost1Recovered to SP_DWS3:SyncAcquired	283
6.9.8.4 Transition SP_DWS5:Lost1Recovered to SP_DWS6:Lost2	283
6.9.9 SP_DWS6:Lost2 state	283
6.9.9.1 State description	283
6.9.9.2 Transition SP_DWS6:Lost2 to SP_DWS0:AcquireSync	283
6.9.9.3 Transition SP_DWS6:Lost2 to SP_DWS7:Lost2Recovered	283
6.9.9.4 Transition SP_DWS6:Lost2 to SP_DWS8:Lost3	283
6.9.10 SP_DWS7:Lost2Recovered state	283
6.9.10.1 State description	283
6.9.10.2 Transition SP_DWS7:Lost2Recovered to SP_DWS0:AcquireSync	283
6.9.10.3 Transition SP_DWS7:Lost2Recovered to SP_DWS4:Lost1	284
6.9.10.4 Transition SP_DWS7:Lost2Recovered to SP_DWS8:Lost3	284
6.9.11 SP_DWS8:Lost3 state	284
6.9.11.1 State description	284
6.9.11.2 Transition SP_DWS8:Lost3 to SP_DWS0:AcquireSync	284

This page contains no comments

6.9.11.3 Transition SP_DWS8:Lost3 to SP_DWS9:Lost3Recovered	284
6.9.12 SP_DWS9:Lost3Recovered state	284
6.9.12.1 State description.....	284
6.9.12.2 Transition SP_DWS9:Lost3Recovered to SP_DWS0:AcquireSync.....	284
6.9.12.3 Transition SP_DWS9:Lost3Recovered to SP_DWS6:Lost2	284
6.10 Multiplexing.....	284
6.11 Spin-up	286
7 Link layer.....	287
7.1 Link layer overview	287
7.2 Primitives	287
7.2.1 Primitives overview	287
7.2.2 Primitive summary	288
7.2.3 Primitive encodings.....	293
7.2.4 Primitive sequences.....	298
7.2.4.1 Primitive sequences overview	298
7.2.4.2 Single primitive sequence	298
7.2.4.3 Repeated primitive sequence.....	298
7.2.4.4 Continued primitive sequence	299
7.2.4.5 Extended primitive sequence	299
7.2.4.6 Triple primitive sequence	299
7.2.4.7 Redundant primitive sequence.....	300
7.2.5 Deletable primitives.....	301
7.2.5.1 ALIGN.....	301
7.2.5.2 MUX (Multiplex).....	302
7.2.5.3 NOTIFY	303
7.2.5.3.1 NOTIFY overview	303
7.2.5.3.2 NOTIFY (ENABLE SPINUP).....	303
7.2.5.3.3 NOTIFY (POWER LOSS EXPECTED).....	304
7.2.6 Primitives not specific to type of connections	305
7.2.6.1 AIP (Arbitration in progress)	305
7.2.6.2 BREAK	305
7.2.6.3 BREAK_REPLY	305
7.2.6.4 BROADCAST	305
7.2.6.5 CLOSE	306
7.2.6.6 EOAF (End of address frame).....	306
7.2.6.7 ERROR	307
7.2.6.8 HARD_RESET	307
7.2.6.9 OPEN_ACCEPT.....	307
7.2.6.10 OPEN_REJECT	307
7.2.6.11 SOAF (Start of address frame).....	310
7.2.6.12 TRAIN.....	310
7.2.6.13 TRAIN_DONE	310
7.2.7 Primitives used only inside SSP and SMP connections	310
7.2.7.1 ACK (Acknowledge)	310
7.2.7.2 CREDIT_BLOCKED	310
7.2.7.3 DONE	310
7.2.7.4 EOF (End of frame)	311
7.2.7.5 NAK (Negative acknowledgement)	311
7.2.7.6 RRDY (Receiver ready).....	311
7.2.7.7 SOF (Start of frame).....	312
7.2.8 Primitives used only inside STP connections and on SATA physical links.....	312
7.2.8.1 SATA_ERROR	312
7.2.8.2 SATA_PMACK, SATA_PMNAK, SATA_PMREQ_P, and SATA_PMREQ_S (Power management acknowledgements and requests)	312
7.2.8.3 SATA_HOLD and SATA_HOLD_A (Hold and hold acknowledge).....	312
7.2.8.4 SATA_R_RDY and SATA_X_RDY (Receiver ready and transmitter ready).....	312

This page contains no comments

7.2.8.5 Other primitives used inside STP connections and on SATA physical links	312
7.3 Physical link rate tolerance management.....	313
7.3.1 Physical link rate tolerance management overview.....	313
7.3.2 Phys originating dwords.....	315
7.3.3 Expander phys forwarding dwords.....	315
7.4 Idle physical links.....	316
7.5 CRC.....	316
7.5.1 CRC overview	316
7.5.2 CRC generation	317
7.5.3 CRC checking	319
7.6 Scrambling.....	320
7.7 Bit order of CRC and scrambler	322
7.8 Address frames	325
7.8.1 Address frames overview.....	325
7.8.2 IDENTIFY address frame.....	327
7.8.3 OPEN address frame.....	330
7.9 Identification and hard reset sequence.....	333
7.9.1 Identification and hard reset sequence overview	333
7.9.2 SAS initiator device rules	335
7.9.3 Expander device rules	336
7.9.4 SL_IR (link layer identification and hard reset) state machines	336
7.9.4.1 SL_IR state machines overview	336
7.9.4.2 SL_IR transmitter and receiver.....	338
7.9.4.3 SL_IR_TIR (transmit IDENTIFY or HARD_RESET) state machine	338
7.9.4.3.1 SL_IR_TIR state machine overview	338
7.9.4.3.2 SL_IR_TIR1:Idle state	338
7.9.4.3.2.1 State description	338
7.9.4.3.2.2 Transition SL_IR_TIR1:Idle to SL_IR_TIR2:Transmit_Identify	339
7.9.4.3.2.3 Transition SL_IR_TIR1:Idle to SL_IR_TIR3:Transmit_Hard_Reset.....	339
7.9.4.3.3 SL_IR_TIR2:Transmit_Identify state.....	339
7.9.4.3.3.1 State description	339
7.9.4.3.3.2 Transition SL_IR_TIR2:Transmit_Identify to SL_IR_TIR4:Completed.....	339
7.9.4.3.4 SL_IR_TIR3:Transmit_Hard_Reset state	339
7.9.4.3.4.1 State description	339
7.9.4.3.4.2 Transition SL_IR_TIR3:Transmit_Hard_Reset to SL_IR_TIR4:Completed	339
7.9.4.3.5 SL_IR_TIR4:Completed state.....	339
7.9.4.4 SL_IR_RIF (receive IDENTIFY address frame) state machine.....	339
7.9.4.4.1 SL_IR_RIF state machine overview	339
7.9.4.4.2 SL_IR_RIF1:Idle state	340
7.9.4.4.2.1 State description	340
7.9.4.4.2.2 Transition SL_IR_RIF1:Idle to SL_IR_RIF2:Receive_Identify_Frame	340
7.9.4.4.3 SL_IR_RIF2:Receive_Identify_Frame state	340
7.9.4.4.3.1 State description	340
7.9.4.4.3.2 Transition SL_IR_RIF2:Receive_Identify_Frame to SL_IR_RIF3:Completed	340
7.9.4.4.4 SL_IR_RIF3:Completed state.....	340
7.9.4.5 SL_IR_IRC (identification and hard reset control) state machine	341
7.9.4.5.1 SL_IR_IRC state machine overview	341
7.9.4.5.2 SL_IR_IRC1:Idle state	341
7.9.4.5.2.1 State description	341
7.9.4.5.2.2 Transition SL_IR_IRC1:Idle to SL_IR_IRC2:Wait	341
7.9.4.5.3 SL_IR_IRC2:Wait state.....	341
7.9.4.5.3.1 State description	341
7.9.4.5.3.2 Transition SL_IR_IRC2:Wait to SL_IR_IRC3:Completed	342
7.9.4.5.4 SL_IR_IRC3:Completed state	342
7.10 Power management	342
7.11 SAS domain changes (Broadcast (Change) usage).....	342
7.12 Connections.....	343

This page contains no comments

7.12.1	Connections overview	343
7.12.2	Opening a connection	344
7.12.2.1	Connection request	344
7.12.2.2	Results of a connection request	346
7.12.3	Arbitration fairness	346
7.12.4	Arbitration inside an expander device	347
7.12.4.1	Expander phy arbitration requirements	347
7.12.4.2	ECM arbitration requirements	348
7.12.4.2.1	ECM arbitration requirements overview	348
7.12.4.2.2	Arbitrating confirmations	348
7.12.4.2.3	Arb Won confirmation	349
7.12.4.2.4	Arb Lost confirmation	349
7.12.4.2.5	Arb Reject confirmation	350
7.12.4.3	Arbitration status	350
7.12.4.4	Partial Pathway Timeout timer	351
7.12.4.5	Pathway recovery	351
7.12.5	BREAK handling	352
7.12.6	Aborting a connection request	352
7.12.7	Closing a connection	354
7.12.8	Breaking a connection	355
7.13	Rate matching	356
7.14	SL (link layer for SAS logical phys) state machines	358
7.14.1	SL state machines overview	358
7.14.2	SL transmitter and receiver	360
7.14.3	SL_RA (receive OPEN address frame) state machine	361
7.14.4	SL_CC (connection control) state machine	362
7.14.4.1	SL_CC state machine overview	362
7.14.4.2	SL_CC0:Idle state	363
7.14.4.2.1	State description	363
7.14.4.2.2	Transition SL_CC0:Idle to SL_CC1:ArbSel	364
7.14.4.2.3	Transition SL_CC0:Idle to SL_CC2:Selected	364
7.14.4.3	SL_CC1:ArbSel state	364
7.14.4.3.1	State description	364
7.14.4.3.2	Transition SL_CC1:ArbSel to SL_CC0:Idle	365
7.14.4.3.3	Transition SL_CC1:ArbSel to SL_CC2:Selected	365
7.14.4.3.4	Transition SL_CC1:ArbSel to SL_CC3:Connected	366
7.14.4.3.5	Transition SL_CC1:ArbSel to SL_CC5:BreakWait	366
7.14.4.3.6	Transition SL_CC1:ArbSel to SL_CC6:Break	366
7.14.4.4	SL_CC2:Selected state	366
7.14.4.4.1	State description	366
7.14.4.4.2	Transition SL_CC2:Selected to SL_CC0:Idle	367
7.14.4.4.3	Transition SL_CC2:Selected to SL_CC3:Connected	367
7.14.4.4.4	Transition SL_CC2:Selected to SL_CC5:BreakWait	368
7.14.4.4.5	Transition SL_CC2:Selected to SL_CC6:Break	368
7.14.4.5	SL_CC3:Connected state	368
7.14.4.5.1	State description	368
7.14.4.5.2	Transition SL_CC3:Connected to SL_CC4:DisconnectWait	368
7.14.4.5.3	Transition SL_CC3:Connected to SL_CC5:BreakWait	368
7.14.4.5.4	Transition SL_CC3:Connected to SL_CC6:Break	368
7.14.4.5.5	Transition SL_CC3:Connected to SL_CC7:CloseSTP	368
7.14.4.6	SL_CC4:DisconnectWait state	369
7.14.4.6.1	State description	369
7.14.4.6.2	Transition SL_CC4:DisconnectWait to SL_CC0:Idle	369
7.14.4.6.3	Transition SL_CC4:DisconnectWait to SL_CC5:BreakWait	369
7.14.4.6.4	Transition SL_CC4:DisconnectWait to SL_CC6:Break	369
7.14.4.7	SL_CC5:BreakWait state	369
7.14.4.7.1	State description	369

This page contains no comments

7.14.4.7.2 Transition SL_CC5:BreakWait to SL_CC0:Idle	370
7.14.4.8 SL_CC6:Break state.....	370
7.14.4.8.1 State description.....	370
7.14.4.8.2 Transition SL_CC6:Break to SL_CC0:Idle.....	370
7.14.4.9 SL_CC7:CloseSTP state.....	370
7.14.4.9.1 State description.....	370
7.14.4.9.2 Transition SL_CC7:CloseSTP to SL_CC0:Idle.....	370
7.15 XL (link layer for expander logical phys) state machine	371
7.15.1 XL state machine overview	371
7.15.2 XL transmitter and receiver.....	375
7.15.3 XL0:Idle state	376
7.15.3.1 State description.....	376
7.15.3.2 Transition XL0:Idle to XL1:Request_Path	376
7.15.3.3 Transition XL0:Idle to XL5:Forward_Open	377
7.15.4 XL1:Request_Path state	377
7.15.4.1 State description.....	377
7.15.4.2 Transition XL1:Request_Path to XL0:Idle	378
7.15.4.3 Transition XL1:Request_Path to XL2:Request_Open.....	378
7.15.4.4 Transition XL1:Request_Path to XL4:Open_Reject	378
7.15.4.5 Transition XL1:Request_Path to XL5:Forward_Open	378
7.15.4.6 Transition XL1:Request_Path to XL9:Break.....	378
7.15.5 XL2:Request_Open state.....	379
7.15.5.1 State description.....	379
7.15.5.2 Transition XL2:Request_Open to XL3:Open_Confirm_Wait	379
7.15.6 XL3:Open_Confirm_Wait state	379
7.15.6.1 State description.....	379
7.15.6.2 Transition XL3:Open_Confirm_Wait to XL0:Idle	380
7.15.6.3 Transition XL3:Open_Confirm_Wait to XL1:Request_Path	380
7.15.6.4 Transition XL3:Open_Confirm_Wait to XL5:Forward_Open	380
7.15.6.5 Transition XL3:Open_Confirm_Wait to XL7:Connected.....	380
7.15.6.6 Transition XL3:Open_Confirm_Wait to XL9:Break.....	380
7.15.6.7 Transition XL3:Open_Confirm_Wait to XL10:Break_Wait.....	380
7.15.7 XL4:Open_Reject state.....	381
7.15.7.1 State description.....	381
7.15.7.2 Transition XL4:Open_Reject to XL0:Idle	381
7.15.7.3 Transition XL4:Open_Reject to XL5:Forward_Open.....	381
7.15.8 XL5:Forward_Open state.....	381
7.15.8.1 State description.....	381
7.15.8.2 Transition XL5:Forward_Open to XL6:Open_Response_Wait.....	381
7.15.9 XL6:Open_Response_Wait state.....	381
7.15.9.1 State description.....	381
7.15.9.2 Transition XL6:Open_Response_Wait to XL0:Idle.....	383
7.15.9.3 Transition XL6:Open_Response_Wait to XL1:Request_Path.....	383
7.15.9.4 Transition XL6:Open_Response_Wait to XL2:Request_Open	383
7.15.9.5 Transition XL6:Open_Response_Wait to XL7:Connected	383
7.15.9.6 Transition XL6:Open_Response_Wait to XL9:Break	383
7.15.9.7 Transition XL6:Open_Response_Wait to XL10:Break_Wait	383
7.15.10 XL7:Connected state	383
7.15.10.1 State description.....	383
7.15.10.2 Transition XL7:Connected to XL8:Close_Wait	384
7.15.10.3 Transition XL7:Connected to XL9:Break	384
7.15.10.4 Transition XL7:Connected to XL10:Break_Wait.....	384
7.15.11 XL8:Close_Wait state	384
7.15.11.1 State description.....	384
7.15.11.2 Transition XL8:Close_Wait to XL0:Idle.....	385
7.15.11.3 Transition XL8:Close_Wait to XL9:Break	385
7.15.11.4 Transition XL8:Close_Wait to XL10:Break_Wait.....	385

This page contains no comments

7.15.12 XL9:Break state	385
7.15.12.1 State description.....	385
7.15.12.2 Transition XL9:Break to XLO:Idle.....	385
7.15.13 XL10:Break_Wait state	385
7.15.13.1 State description.....	385
7.15.13.2 Transition XL10:Break_Wait to XLO:Idle	386
7.16 SSP link layer	386
7.16.1 Opening an SSP connection.....	386
7.16.2 Full duplex.....	386
7.16.3 SSP frame transmission and reception.....	386
7.16.4 SSP flow control.....	387
7.16.5 Interlocked frames	387
7.16.6 Breaking an SSP connection	389
7.16.7 Closing an SSP connection	389
7.16.8 SSP (link layer for SSP phys) state machines	390
7.16.8.1 SSP state machines overview	390
7.16.8.2 SSP transmitter and receiver	393
7.16.8.3 SSP_TIM (transmit interlocked frame monitor) state machine.....	394
7.16.8.4 SSP_TCM (transmit frame credit monitor) state machine.....	395
7.16.8.5 SSP_D (DONE control) state machine.....	395
7.16.8.6 SSP_TF (transmit frame control) state machine	397
7.16.8.6.1 SSP_TF state machine overview.....	397
7.16.8.6.2 SSP_TF1:Connected_Idle state	397
7.16.8.6.2.1 State description	397
7.16.8.6.2.2 Transition SSP_TF1:Connected_Idle to SSP_TF2:Tx_Wait.....	397
7.16.8.6.2.3 Transition SSP_TF1:Connected_Idle to SSP_TF4:Transmit_DONE.....	397
7.16.8.6.3 SSP_TF2:Tx_Wait state	397
7.16.8.6.3.1 State description	397
7.16.8.6.3.2 Transition SSP_TF2:Tx_Wait to SSP_TF3:Transmit_Frame.....	397
7.16.8.6.3.3 Transition SSP_TF2:Tx_Wait to SSP_TF4:Transmit_DONE.....	398
7.16.8.6.4 SSP_TF3:Transmit_Frame state	398
7.16.8.6.4.1 State description	398
7.16.8.6.4.2 Transition SSP_TF3:Transmit_Frame to SSP_TF1:Connected_Idle.....	398
7.16.8.6.5 SSP_TF4:Transmit_DONE state	398
7.16.8.7 SSP_RF (receive frame control) state machine	399
7.16.8.8 SSP_RCM (receive frame credit monitor) state machine.....	399
7.16.8.9 SSP_RIM (receive interlocked frame monitor) state machine.....	400
7.16.8.10 SSP_TC (transmit credit control) state machine	400
7.16.8.11 SSP_TAN (transmit ACK/NAK control) state machine.....	401
7.17 STP link layer	401
7.17.1 STP frame transmission and reception.....	401
7.17.2 STP flow control.....	402
7.17.3 Continued primitive sequence.....	405
7.17.4 Affiliations.....	406
7.17.5 Opening an STP connection	408
7.17.6 Closing an STP connection.....	410
7.17.7 STP connection management examples	410
7.17.8 STP (link layer for STP phys) state machines	413
7.17.9 SMP target port support.....	413
7.18 SMP link layer.....	413
7.18.1 SMP frame transmission and reception	413
7.18.2 SMP flow control.....	413
7.18.3 Opening an SMP connection	413
7.18.4 Closing an SMP connection.....	413
7.18.5 SMP (link layer for SMP phys) state machines	414
7.18.5.1 SMP state machines overview	414
7.18.5.2 SMP transmitter and receiver.....	414

This page contains no comments

7.18.5.3 SMP_IP (link layer for SMP initiator phys) state machine	414
7.18.5.3.1 SMP_IP state machine overview	414
7.18.5.3.2 SMP_IP1:Idle state	415
7.18.5.3.2.1 State description	415
7.18.5.3.2.2 Transition SMP_IP1:Idle to SMP_IP2:Transmit_Frame	415
7.18.5.3.3 SMP_IP2:Transmit_Frame state	416
7.18.5.3.3.1 State description	416
7.18.5.3.3.2 Transition SMP_IP2:Transmit_Frame to SMP_IP3:Receive_Frame	416
7.18.5.3.4 SMP_IP3:Receive_Frame state	416
7.18.5.4 SMP_TP (link layer for SMP target phys) state machine	417
7.18.5.4.1 SMP_TP state machine overview	417
7.18.5.4.2 SMP_TP1:Receive_Frame state	417
7.18.5.4.2.1 State description	417
7.18.5.4.2.2 Transition SMP_TP1:Receive_Frame to SMP_TP2:Transmit_Frame	418
7.18.5.4.3 SMP_TP2:Transmit_Frame state	418
8 Port layer	419
8.1 Port layer overview	419
8.2 PL (port layer) state machines	419
8.2.1 PL state machines overview	419
8.2.2 PL_OC (port layer overall control) state machine	421
8.2.2.1 PL_OC state machine overview	421
8.2.2.2 PL_OC1:Idle state	423
8.2.2.2.1 PL_OC1:Idle state description	423
8.2.2.2.2 Transition PL_OC1:Idle to PL_OC2:Overall_Control	424
8.2.2.3 PL_OC2:Overall_Control state	424
8.2.2.3.1 PL_OC2:Overall_Control state overview	424
8.2.2.3.2 PL_OC2:Overall_Control state establishing connections	425
8.2.2.3.3 PL_OC2:Overall_Control state connection established	428
8.2.2.3.4 PL_OC2:Overall_Control state unable to establish a connection	428
8.2.2.3.5 PL_OC2:Overall_Control state connection management	429
8.2.2.3.6 PL_OC2:Overall_Control state frame transmission	430
8.2.2.3.7 PL_OC2:Overall_Control state frame transmission cancellations	431
8.2.2.3.8 Transition PL_OC2:Overall_Control to PL_OC1:Idle	432
8.2.3 PL_PM (port layer phy manager) state machine	432
8.2.3.1 PL_PM state machine overview	432
8.2.3.2 PL_PM1:Idle state	434
8.2.3.2.1 PL_PM1:Idle state description	434
8.2.3.2.2 Transition PL_PM1:Idle to PL_PM2:Req_Wait	435
8.2.3.2.3 Transition PL_PM1:Idle to PL_PM3:Connected	435
8.2.3.3 PL_PM2:Req_Wait state	435
8.2.3.3.1 PL_PM2:Req_Wait state overview	435
8.2.3.3.2 PL_PM2:Req_Wait establishing a connection	435
8.2.3.3.3 PL_PM2:Req_Wait connection established	435
8.2.3.3.4 PL_PM2:Req_Wait unable to establish a connection	436
8.2.3.3.5 PL_PM2:Req_Wait connection management	437
8.2.3.3.6 Transition PL_PM2:Req_Wait to PL_PM1:Idle	437
8.2.3.3.7 Transition PL_PM2:Req_Wait to PL_PM3:Connected	437
8.2.3.3.8 Transition PL_PM2:Req_Wait to PL_PM4:Wait_For_Close	437
8.2.3.4 PL_PM3:Connected state	437
8.2.3.4.1 PL_PM3:Connected state description	437
8.2.3.4.2 Transition PL_PM3:Connected to PL_PM1:Idle	440
8.2.3.5 PL_PM4:Wait_For_Close state	440
8.2.3.5.1 PL_PM4:Wait_For_Close state description	440
8.2.3.5.2 Transition PL_PM4:Wait_For_Close to PL_PM1:Idle	441
9 Transport layer	442

This page contains no comments

9.1 Transport layer overview	442
9.2 SSP transport layer	443
9.2.1 SSP frame format	443
9.2.2 Information units	446
9.2.2.1 COMMAND frame - Command information unit.....	446
9.2.2.2 TASK frame - Task Management Function information unit	448
9.2.2.3 XFER_RDY frame - Transfer Ready information unit	450
9.2.2.4 DATA frame - Data information unit	451
9.2.2.5 RESPONSE frame - Response information unit	452
9.2.2.5.1 RESPONSE frame - Response information unit overview	452
9.2.2.5.2 Response information unit - NO_DATA format.....	453
9.2.2.5.3 Response information unit - RESPONSE_DATA format.....	453
9.2.2.5.4 Response information unit - SENSE_DATA format.....	454
9.2.3 Sequences of SSP frames.....	455
9.2.3.1 Sequences of SSP frames overview	455
9.2.3.2 Task management function sequence of SSP frames	455
9.2.3.3 Non-data command sequence of SSP frames	455
9.2.3.4 Write command sequence of SSP frames	456
9.2.3.5 Read command sequence of SSP frames	456
9.2.3.6 Bidirectional command sequence of SSP frames	457
9.2.4 SSP transport layer handling of link layer errors.....	457
9.2.4.1 SSP transport layer handling of link layer errors overview.....	457
9.2.4.2 COMMAND frame - handling of link layer errors.....	458
9.2.4.3 TASK frame - handling of link layer errors	458
9.2.4.4 XFER_RDY frame - handling of link layer errors.....	459
9.2.4.4.1 XFER_RDY frame overview	459
9.2.4.4.2 XFER_RDY frame with transport layer retries enabled	459
9.2.4.4.3 XFER_RDY frame with transport layer retries disabled.....	459
9.2.4.5 DATA frame - handling of link layer errors	460
9.2.4.5.1 DATA frame overview.....	460
9.2.4.5.2 DATA frame with transport layer retries enabled.....	460
9.2.4.5.3 DATA frame with transport layer retries disabled	460
9.2.4.6 RESPONSE frame - handling of link layer errors.....	461
9.2.5 SSP transport layer error handling summary.....	461
9.2.5.1 SSP transport layer error handling summary introduction.....	461
9.2.5.2 SSP initiator port transport layer error handling summary	461
9.2.5.3 SSP target port transport layer error handling summary.....	462
9.2.6 ST (transport layer for SSP ports) state machines	463
9.2.6.1 ST state machines overview	463
9.2.6.2 ST_I (transport layer for SSP initiator ports) state machines	464
9.2.6.2.1 ST_I state machines overview	464
9.2.6.2.2 ST_IFR (initiator frame router) state machine	466
9.2.6.2.2.1 ST_IFR state machine overview	466
9.2.6.2.2.2 Processing transport protocol service requests	466
9.2.6.2.2.3 Processing Frame Received confirmations.....	467
9.2.6.2.2.4 Processing Transmission Complete and Reception Complete messages.....	468
9.2.6.2.2.5 Processing miscellaneous requests.....	469
9.2.6.2.3 ST_ITS (initiator transport server) state machine	470
9.2.6.2.3.1 ST_ITS state machine overview	470
9.2.6.2.3.2 ST_ITS1:Initiator_Start state	471
9.2.6.2.3.2.1 State description	471
9.2.6.2.3.2.2 Transition ST_ITS1:Initiator_Start to ST_ITS3:Prepare_Command.....	471
9.2.6.2.3.2.3 Transition ST_ITS1:Initiator_Start to ST_ITS4:Prepare_Task	471
9.2.6.2.3.3 ST_ITS2:Initiator_Send_Frame state.....	471
9.2.6.2.3.3.1 Transition ST_ITS2:Initiator_Send_Frame to ST_ITS1:Initiator_Start	475
9.2.6.2.3.3.2 Transition ST_ITS2:Initiator_Send_Frame to ST_ITS5:Prepare_Data_Out.....	475
9.2.6.2.3.3.3 Transition ST_ITS2:Initiator_Send_Frame to ST_ITS6:Process_Data_In	475

This page contains no comments

9.2.6.2.3.4 ST_ITS3:Prepare_Command state	476
9.2.6.2.3.4.1 State description	476
9.2.6.2.3.4.2 Transition ST_ITS3:Prepare_Command to ST_ITS2:Initiator_Send_Frame	476
9.2.6.2.3.5 ST_ITS4:Prepare_Task state	476
9.2.6.2.3.5.1 State description	476
9.2.6.2.3.5.2 Transition ST_ITS4:Prepare_Task to ST_ITS2:Initiator_Send_Frame	477
9.2.6.2.3.6 ST_ITS5:Prepare_Data_Out state	477
9.2.6.2.3.6.1 State description	477
9.2.6.2.3.6.2 Transition ST_ITS5:Prepare_Data_Out to ST_ITS2:Initiator_Send_Frame	478
9.2.6.2.3.7 ST_ITS6:Receive_Data_In state	478
9.2.6.2.3.7.1 State description	478
9.2.6.2.3.7.2 Transition ST_ITS6:Receive_Data_In to ST_ITS1:Initiator_Start	479
9.2.6.2.3.7.3 Transition ST_ITS6:Receive_Data_In to ST_ITS2:Initiator_Send_Frame	479
9.2.6.3 ST_T (transport layer for SSP target ports) state machines	479
9.2.6.3.1 ST_T state machines overview	479
9.2.6.3.2 ST_TFR (target frame router) state machine	482
9.2.6.3.2.1 ST_TFR state machine overview	482
9.2.6.3.2.2 Processing Frame Received confirmations	482
9.2.6.3.2.3 Processing transport protocol service requests and responses	484
9.2.6.3.2.4 Processing miscellaneous requests and confirmations	487
9.2.6.3.3 ST_TTS (target transport server) state machine	487
9.2.6.3.3.1 ST_TTS state machine overview	487
9.2.6.3.3.2 ST_TTS1:Target_Start state	488
9.2.6.3.3.2.1 State description	488
9.2.6.3.3.2.2 Transition ST_TTS1:Target_Start to ST_TTS3:Prepare_Data_In	489
9.2.6.3.3.2.3 Transition ST_TTS1:Target_Start to ST_TTS4:Prepare_Xfer_Rdy	489
9.2.6.3.3.2.4 Transition ST_TTS1:Target_Start to ST_TTS5:Receive_Data_Out	489
9.2.6.3.3.2.5 Transition ST_TTS1:Target_Start to ST_TTS7:Prepare_Response	489
9.2.6.3.3.3 ST_TTS2:Target_Send_Frame state	489
9.2.6.3.3.3.1 State description	489
9.2.6.3.3.3.2 Transition ST_TTS2:Target_Send_Frame to ST_TTS1:Target_Start	493
9.2.6.3.3.3.3 Transition ST_TTS2:Target_Send_Frame to ST_TTS3:Prepare_Data_In	493
9.2.6.3.3.3.4 Transition ST_TTS2:Target_Send_Frame to ST_TTS5:Receive_Data_Out	494
9.2.6.3.3.4 ST_TTS3:Prepare_Data_In state	494
9.2.6.3.3.4.1 State description	494
9.2.6.3.3.4.2 Transition ST_TTS3:Prepare_Data_In to ST_TTS2:Target_Send_Frame	495
9.2.6.3.3.5 ST_TTS4:Prepare_Xfer_Rdy state	495
9.2.6.3.3.5.1 State description	495
9.2.6.3.3.5.2 Transition ST_TTS4:Prepare_Xfer_Rdy to ST_TTS2:Target_Send_Frame	496
9.2.6.3.3.6 ST_TTS5:Receive_Data_Out state	496
9.2.6.3.3.6.1 State description	496
9.2.6.3.3.6.2 Transition ST_TTS5:Receive_Data_Out to ST_TTS1:Target_Start	497
9.2.6.3.3.6.3 Transition ST_TTS5:Receive_Data_Out to ST_TTS4:Prepare_Xfer_Rdy	497
9.2.6.3.3.7 ST_TTS6:Prepare_Response state	498
9.2.6.3.3.7.1 State description	498
9.2.6.3.3.7.2 Transition ST_TTS6:Prepare_Response to ST_TTS2:Target_Send_Frame	499
9.3 STP transport layer	499
9.3.1 Initial FIS	499
9.3.2 BIST Activate FIS	499
9.3.3 TT (transport layer for STP ports) state machines	499
9.4 SMP transport layer	500
9.4.1 SMP transport layer overview	500
9.4.2 SMP_REQUEST frame	501
9.4.3 SMP_RESPONSE frame	501
9.4.4 Sequence of SMP frames	502
9.4.5 MT (transport layer for SMP ports) state machines	502
9.4.5.1 SMP transport layer state machines overview	502

This page contains no comments

9.4.5.2 MT_IP (transport layer for SMP initiator ports) state machine	502
9.4.5.2.1 MT_IP state machine overview.....	502
9.4.5.2.2 MT_IP1:Idle state.....	503
9.4.5.2.2.1 State description	503
9.4.5.2.2.2 Transition MT_IP1:Idle to MT_IP2:Send	503
9.4.5.2.3 MT_IP2:Send state	504
9.4.5.2.3.1 State description	504
9.4.5.2.3.2 Transition MT_IP2:Send to MT_IP1:Idle	504
9.4.5.2.3.3 Transition MT_IP2:Send to MT_IP3:Receive	504
9.4.5.2.4 MT_IP3:Receive state	504
9.4.5.2.4.1 State description	504
9.4.5.2.4.2 Transition MT_IP3:Receive to MT_IP1:Idle	504
9.4.5.3 MT_TP (transport layer for SMP target ports) state machine.....	504
9.4.5.3.1 MT_TP state machine overview	504
9.4.5.3.2 MT_TP1:Idle state	505
9.4.5.3.2.1 State description	505
9.4.5.3.2.2 Transition MT_TP1:Idle to MT_TP2:Respond.....	505
9.4.5.3.3 MT_TP2:Respond state.....	506
9.4.5.3.3.1 State description	506
9.4.5.3.3.2 Transition MT_TP2:Respond to MT_TP1:Idle.....	506
10 Application layer.....	507
10.1 Application layer overview	507
10.2 SCSI application layer	507
10.2.1 SCSI transport protocol services	507
10.2.1.1 SCSI transport protocol services overview.....	507
10.2.1.2 Send SCSI Command transport protocol service.....	509
10.2.1.3 SCSI Command Received transport protocol service	509
10.2.1.4 Send Command Complete transport protocol service.....	510
10.2.1.5 Command Complete Received transport protocol service	511
10.2.1.6 Send Data-In transport protocol service.....	512
10.2.1.7 Data-In Delivered transport protocol service	513
10.2.1.8 Receive Data-Out transport protocol service	513
10.2.1.9 Data-Out Received transport protocol service	514
10.2.1.10 Terminate Data Transfer transport protocol service.....	514
10.2.1.11 Data Transfer Terminated transport protocol service.....	515
10.2.1.12 Send Task Management Request transport protocol service	515
10.2.1.13 Task Management Request Received transport protocol service.....	515
10.2.1.14 Task Management Function Executed transport protocol service	516
10.2.1.15 Received Task Management Function Executed transport protocol service	517
10.2.2 Application client error handling.....	518
10.2.3 Device server error handling.....	519
10.2.4 Task router and task manager error handling.....	519
10.2.5 SCSI transport protocol event notifications.....	520
10.2.6 SCSI commands.....	520
10.2.6.1 INQUIRY command.....	520
10.2.6.2 MODE SELECT and MODE SENSE commands	520
10.2.6.3 LOG SELECT and LOG SENSE commands	520
10.2.6.4 SEND DIAGNOSTIC and RECEIVE DIAGNOSTIC RESULTS commands.....	520
10.2.6.5 START STOP UNIT command.....	520
10.2.7 SCSI mode parameters	521
10.2.7.1 SCSI mode parameters overview.....	521
10.2.7.2 Disconnect-Reconnect mode page	521
10.2.7.2.1 Disconnect-Reconnect mode page overview	521
10.2.7.2.2 BUS INACTIVITY TIME LIMIT field	522
10.2.7.2.3 MAXIMUM CONNECT TIME LIMIT field.....	523
10.2.7.2.4 MAXIMUM BURST SIZE field	523

This page contains no comments

10.2.7.2.5 FIRST BURST SIZE field.....	523
10.2.7.3 Protocol-Specific Logical Unit mode page.....	524
10.2.7.4 Protocol-Specific Port mode page.....	524
10.2.7.5 Phy Control And Discover mode page.....	526
10.2.7.6 Shared Port Control mode page.....	529
10.2.7.7 SAS-2 Phy mode page.....	529
10.2.8 SCSI log parameters.....	532
10.2.8.1 Protocol-Specific Port log page.....	532
10.2.9 SCSI diagnostic parameters.....	536
10.2.9.1 SCSI diagnostic parameters overview.....	536
10.2.9.2 Protocol-Specific diagnostic page.....	536
10.2.9.3 Enclosure Control diagnostic page.....	542
10.2.9.4 Enclosure Status diagnostic page.....	543
10.2.9.5 Additional Element Status diagnostic page.....	543
10.2.10 SCSI power conditions.....	543
10.2.10.1 SCSI power conditions overview.....	543
10.2.10.2 SA_PC (SCSI application layer power condition) state machine.....	543
10.2.10.2.1 SA_PC state machine overview.....	543
10.2.10.2.2 SA_PC_0:Powered_On state.....	544
10.2.10.2.2.1 State description.....	544
10.2.10.2.2.2 Transition SA_PC_0:Powered_On to SA_PC_4:Stopped.....	544
10.2.10.2.2.3 Transition SA_PC_0:Powered_On to SA_PC_5:Active_Wait.....	545
10.2.10.2.3 SA_PC_1:Active state.....	545
10.2.10.2.3.1 State description.....	545
10.2.10.2.3.2 Transition SA_PC_1:Active to SA_PC_2:Idle.....	545
10.2.10.2.3.3 Transition SA_PC_1:Active to SA_PC_3:Standby.....	545
10.2.10.2.3.4 Transition SA_PC_1:Active to SA_PC_4:Stopped.....	545
10.2.10.2.4 SA_PC_2:Idle state.....	545
10.2.10.2.4.1 State description.....	545
10.2.10.2.4.2 Transition SA_PC_2:Idle to SA_PC_1:Active.....	545
10.2.10.2.4.3 Transition SA_PC_2:Idle to SA_PC_3:Standby.....	545
10.2.10.2.4.4 Transition SA_PC_2:Idle to SA_PC_4:Stopped.....	546
10.2.10.2.5 SA_PC_3:Standby state.....	546
10.2.10.2.5.1 State description.....	546
10.2.10.2.5.2 Transition SA_PC_3:Standby to SA_PC_4:Stopped.....	546
10.2.10.2.5.3 Transition SA_PC_3:Standby to SA_PC_5:Active_Wait.....	546
10.2.10.2.5.4 Transition SA_PC_3:Standby to SA_PC_6:Idle_Wait.....	546
10.2.10.2.6 SA_PC_4:Stopped state.....	546
10.2.10.2.6.1 State description.....	546
10.2.10.2.6.2 Transition SA_PC_4:Stopped to SA_PC_3:Standby.....	546
10.2.10.2.6.3 Transition SA_PC_4:Stopped to SA_PC_5:Active_Wait.....	546
10.2.10.2.6.4 Transition SA_PC_4:Stopped to SA_PC_6:Idle_Wait.....	547
10.2.10.2.7 SA_PC_5:Active_Wait state.....	547
10.2.10.2.7.1 State description.....	547
10.2.10.2.7.2 Transition SA_PC_5:Active_Wait to SA_PC_1:Active.....	547
10.2.10.2.7.3 Transition SA_PC_5:Active_Wait to SA_PC_3:Standby.....	547
10.2.10.2.7.4 Transition SA_PC_5:Active_Wait to SA_PC_4:Stopped.....	547
10.2.10.2.7.5 Transition SA_PC_5:Active_Wait to SA_PC_6:Idle_Wait.....	547
10.2.10.2.8 SA_PC_6:Idle_Wait state.....	548
10.2.10.2.8.1 State description.....	548
10.2.10.2.8.2 Transition SA_PC_6:Idle_Wait to SA_PC_2:Idle.....	548
10.2.10.2.8.3 Transition SA_PC_6:Idle_Wait to SA_PC_3:Standby.....	548
10.2.10.2.8.4 Transition SA_PC_6:Idle_Wait to SA_PC_4:Stopped.....	548
10.2.10.2.8.5 Transition SA_PC_6:Idle_Wait to SA_PC_5:Active_Wait.....	548
10.2.11 SCSI vital product data (VPD).....	549
10.2.11.1 SCSI vital product data (VPD) overview.....	549
10.2.11.2 Device Identification VPD page.....	549

This page contains no comments

10.2.11.3 Protocol-Specific Logical Unit Information VPD page	550
10.3 ATA application layer.....	552
10.4 Management application layer.....	552
10.4.1 READY LED signal behavior	552
10.4.2 Management protocol services	554
10.4.3 SMP functions.....	554
10.4.3.1 SMP functions overview	554
10.4.3.2 SMP function request frame format.....	556
10.4.3.2.1 SMP function request frame format overview.....	556
10.4.3.2.2 SMP FRAME TYPE field	556
10.4.3.2.3 FUNCTION field	556
10.4.3.2.4 ALLOCATED RESPONSE LENGTH field	556
10.4.3.2.5 REQUEST LENGTH field.....	557
10.4.3.2.6 Additional request bytes	557
10.4.3.2.7 Fill bytes.....	557
10.4.3.2.8 CRC field.....	557
10.4.3.3 SMP function response frame format.....	558
10.4.3.3.1 SMP function response frame format overview	558
10.4.3.3.2 SMP FRAME TYPE field	558
10.4.3.3.3 FUNCTION field	558
10.4.3.3.4 FUNCTION RESULT field	558
10.4.3.3.5 RESPONSE LENGTH field.....	566
10.4.3.3.6 Additional response bytes.....	566
10.4.3.3.7 Fill bytes.....	566
10.4.3.3.8 CRC field.....	566
10.4.3.4 REPORT GENERAL function.....	566
10.4.3.5 REPORT MANUFACTURER INFORMATION function	573
10.4.3.6 REPORT SELF-CONFIGURATION STATUS function	577
10.4.3.6.1 REPORT SELF-CONFIGURATION STATUS function overview	577
10.4.3.6.2 REPORT SELF-CONFIGURATION STATUS request	577
10.4.3.6.3 REPORT SELF-CONFIGURATION STATUS response	578
10.4.3.6.4 Self-configuration status descriptor	580
10.4.3.7 REPORT ZONE PERMISSION TABLE function.....	582
10.4.3.7.1 REPORT ZONE PERMISSION TABLE function overview	582
10.4.3.7.2 REPORT ZONE PERMISSION TABLE request.....	582
10.4.3.7.3 REPORT ZONE PERMISSION TABLE response	583
10.4.3.7.4 Zone permission descriptor	584
10.4.3.8 REPORT ZONE MANAGER PASSWORD function.....	585
10.4.3.9 REPORT BROADCAST function	586
10.4.3.9.1 REPORT BROADCAST function overview.....	586
10.4.3.9.2 REPORT BROADCAST request	587
10.4.3.9.3 REPORT BROADCAST response.....	588
10.4.3.9.4 REPORT BROADCAST response broadcast descriptor	589
10.4.3.10 DISCOVER function.....	590
10.4.3.11 REPORT PHY ERROR LOG function.....	604
10.4.3.12 REPORT PHY SATA function.....	607
10.4.3.13 REPORT ROUTE INFORMATION function	610
10.4.3.14 REPORT PHY EVENT function	613
10.4.3.14.1 REPORT PHY EVENT function overview.....	613
10.4.3.14.2 REPORT PHY EVENT request	613
10.4.3.14.3 REPORT PHY EVENT response.....	614
10.4.3.14.4 REPORT PHY EVENT response phy event descriptor	615
10.4.3.15 DISCOVER LIST function	615
10.4.3.15.1 DISCOVER LIST function overview.....	615
10.4.3.15.2 DISCOVER LIST request	616
10.4.3.15.3 DISCOVER LIST response.....	617
10.4.3.15.4 DISCOVER LIST response SHORT FORMAT descriptor	619

This page contains no comments

10.4.3.16 REPORT PHY EVENT LIST function.....	620
10.4.3.16.1 REPORT PHY EVENT LIST function overview	620
10.4.3.16.2 REPORT PHY EVENT LIST request.....	620
10.4.3.16.3 REPORT PHY EVENT LIST response	622
10.4.3.16.4 REPORT PHY EVENT LIST response phy event list descriptor	623
10.4.3.17 REPORT EXPANDER ROUTE TABLE LIST function	624
10.4.3.17.1 REPORT EXPANDER ROUTE TABLE LIST function overview.....	624
10.4.3.17.2 REPORT EXPANDER ROUTE TABLE LIST request	624
10.4.3.17.3 REPORT EXPANDER ROUTE TABLE LIST response.....	625
10.4.3.17.4 REPORT EXPANDER ROUTE TABLE descriptor	626
10.4.3.18 CONFIGURE GENERAL function	627
10.4.3.19 ENABLE DISABLE ZONING function	630
10.4.3.20 ZONED BROADCAST function.....	632
10.4.3.21 ZONE LOCK function.....	635
10.4.3.22 ZONE ACTIVATE function	637
10.4.3.23 ZONE UNLOCK function	638
10.4.3.24 CONFIGURE ZONE MANAGER PASSWORD function	640
10.4.3.25 CONFIGURE ZONE PHY INFORMATION function.....	642
10.4.3.25.1 CONFIGURE ZONE PHY INFORMATION function overview	642
10.4.3.25.2 CONFIGURE ZONE PHY INFORMATION request.....	642
10.4.3.25.3 Zone phy configuration descriptor	643
10.4.3.25.4 CONFIGURE ZONE PHY INFORMATION response	644
10.4.3.26 CONFIGURE ZONE PERMISSION TABLE function	644
10.4.3.26.1 CONFIGURE ZONE PERMISSION TABLE function overview	644
10.4.3.26.2 CONFIGURE ZONE PERMISSION TABLE request	645
10.4.3.26.3 Zone permission configuration descriptor.....	646
10.4.3.26.4 CONFIGURE ZONE PERMISSION TABLE response	648
10.4.3.27 CONFIGURE ROUTE INFORMATION function	648
10.4.3.28 PHY CONTROL function.....	650
10.4.3.29 PHY TEST FUNCTION function.....	656
10.4.3.30 CONFIGURE PHY EVENT function.....	659
10.4.3.30.1 CONFIGURE PHY EVENT function overview	659
10.4.3.30.2 CONFIGURE PHY EVENT request.....	660
10.4.3.30.3 CONFIGURE PHY EVENT request phy event configuration descriptor	661
10.4.3.30.4 CONFIGURE PHY EVENT response	661
Annex A Jitter tolerance patterns	663
A.1 Jitter tolerance pattern (JTPAT)	663
A.2 Compliant jitter tolerance pattern (CJTPAT)	665
A.3 Considerations for a phy transmitting JTPAT and CJTPAT	671
A.4 Considerations for a phy receiving JTPAT and CJTPAT	671
Annex B Signal performance measurements.....	673
B.1 Signal performance measurements overview	673
B.2 Simple physical link.....	673
B.2.1 Simple physical link overview	673
B.2.2 Assumptions for the structure of the transmitter device and the receiver device	674
B.2.3 Definition of receiver sensitivity and receiver device sensitivity	675
B.3 Measurement architecture requirements	676
B.3.1 General.....	676
B.3.2 Relationship between signal compliance measurements at interoperability points and operation in systems.....	676
B.4 De-embedding connectors in test fixtures.....	677
B.5 Measurement conditions for signal output at the transmitter device	677
B.6 Measurement conditions for signal tolerance at the transmitter device	678
B.7 Measurement conditions for signal output at the receiver device	679
B.8 Measurement conditions for signal tolerance at the receiver device	680

This page contains no comments

B.9 S-parameter measurements	681
B.9.1 S-parameter overview	681
B.9.2 S-parameter naming conventions.....	681
B.9.3 Use of single-ended instrumentation in differential applications.....	682
B.9.4 Measurement configurations for physical link elements	684
B.9.4.1 Measurement configuration overview	684
B.9.4.2 Transmitter device S_{11} measurements	684
B.9.4.3 Receiver device S_{11} measurements	685
B.9.4.4 TxRx connection S_{11} measurements at IT or CT.....	685
B.9.4.5 TxRx connection S_{22} measurements at IR or CR.....	686
B.9.5 Summary for S-parameter measurements	687
B.10 Calibration of jitter measurement devices (JMDs)	687
B.10.1 Calibration of JMDs overview	687
B.10.2 JMD Calibration Procedure	689
Annex C SAS to SAS phy reset sequence examples	691
Annex D CRC.....	696
D.1 CRC generator and checker implementation examples	696
D.2 CRC implementation in C	696
D.3 CRC implementation with XORs.....	697
D.4 CRC examples.....	699
Annex E SAS address hashing	700
E.1 SAS address hashing overview	700
E.2 Hash collision probability.....	700
E.3 Hash generation.....	701
E.4 Hash implementation in C.....	701
E.5 Hash implementation with XORs	702
E.6 Hash examples	703
Annex F Scrambling.....	706
F.1 Scrambler implementation example	706
F.2 Scrambler implementation in C	706
F.3 Scrambler implementation with XORs.....	707
F.4 Scrambler examples.....	708
Annex G ATA architectural notes.....	709
G.1 STP differences from Serial ATA (SATA)	709
G.2 STP differences from Serial ATA II.....	709
G.3 Affiliation policies	709
G.3.1 Affiliation policies overview	709
G.3.2 Affiliation policy for static STP initiator port to STP target port mapping.....	710
G.3.3 Affiliation policy with SATA queued commands and multiple STP initiator ports	710
G.3.4 Applicability of affiliation for STP target ports.....	710
G.4 SATA port selector considerations	710
G.5 SATA device not transmitting initial Register Device-to-Host FIS	710
Annex H Minimum deletable primitive insertion rate summary	712
Annex I Zone permission configuration descriptor examples.....	713
Annex J Expander device handling of connections.....	716
J.1 Expander device handling of connections overview	716
J.2 Connection request - OPEN_ACCEPT.....	718
J.3 Connection request - OPEN_REJECT by end device.....	719
J.4 Connection request - OPEN_REJECT by expander device	720

This page contains no comments

J.5 Connection request - arbitration lost.....	721
J.6 Connection request - backoff and retry.....	722
J.7 Connection request - backoff and reverse path.....	723
J.8 Connection close - single step.....	724
J.9 Connection close - simultaneous.....	725
J.10 BREAK handling during path arbitration when the BREAK_REPLY method is disabled	726
J.11 BREAK handling during connection when the BREAK_REPLY method is disabled	727
J.12 BREAK handling during path arbitration when the BREAK_REPLY method is enabled	728
J.13 BREAK handling during connection when BREAK_REPLY method is enabled.....	729
J.14 STP connection - originated by STP initiator port.....	730
J.15 STP connection - originated by STP target port in an STP/SATA bridge	731
J.16 STP connection close - originated by STP initiator port	732
J.17 STP connection close - originated by STP target port in an STP/SATA bridge.....	733
J.18 Connection request - XL1:Request_Path to XL5:Forward_Open transition	734
J.19 Pathway blocked and pathway recovery example.....	735
Annex K Primitive encoding	737
Annex L Discover process example implementation	740
L.1 Discover process example implementation overview.....	740
L.2 Header file	740
L.3 Source file.....	757
Annex M SAS icons	778

This page contains no comments

Tables

	Page
1 Standards bodies	3
2 Numbering conventions	26
3 Multiplicity notation in class diagrams	28
4 Data dword containing a value	33
5 Data dword containing four one-byte fields	33
6 Logical links	40
7 Broadcast types	54
8 Names and identifiers	56
9 SAM-4 attribute mapping	56
10 NAA IEEE Registered format	56
11 Hashed SAS address code parameter	57
12 Device name created from the IDENTIFY (PACKET) DEVICE world wide name	58
13 Expander logical phy to ECM requests	78
14 Expander logical phy to ECM responses	78
15 ECM to expander logical phy confirmations	78
16 Expander logical phy to ECR to expander logical phy requests and indications	79
17 Expander logical phy to ECR to expander logical phy responses and confirmations	80
18 Expander logical phy to BPP requests	81
19 BPP to expander logical phy indications	81
20 Routing attributes and routing methods	82
21 Expander route table types	83
22 Expander route table levels for externally configurable expander device R phy A	95
23 Expander route table levels for externally configurable expander device N	95
24 Expander route entries for externally configurable expander device E0 phy 1	96
25 Expander route entries for externally configurable expander device F phy 0	97
26 Zone manager password	100
27 Zoning expander device zoning configuration after power on	101
28 Zone phy information	104
29 Zone phy information usage	104
30 Zone groups	106
31 Zone permission table	107
32 Zone permission table granting minimal permissions	107
33 Source zone group determination	109
34 Destination zone group determination	109
35 Zone phy information fields after a link reset sequence	111
36 Events that cause the ZONE GROUP field to be reset when the ZONE GROUP PERSISTENT bit set to zero ..	112
37 PHY EVENT SOURCE field	117
38 Connectors	126
39 SAS Drive connector pin assignments	130
40 Controller SAS 4i connector pin assignments and physical link usage	132
41 Backplane SAS 4i connector pin assignments and physical link usage	133
42 Controller Mini SAS 4i connector pin assignments and physical link usage	135
43 Backplane Mini SAS 4i connector pin assignments and physical link usage	136
44 SAS 4x cable plug connector icons	137
45 SAS 4x receptacle connector icons	138
46 SAS 4x connector pin assignments and physical link usage	139
47 Mini SAS 4x cable plug connector icons and key slot positions	140
48 Mini SAS 4x receptacle connector icons and key positions	142
49 Mini SAS 4x connector pin assignments and physical link usage	144
50 General characteristics of cable assemblies and backplanes	161
51 S-parameters of cable assemblies and backplanes	162
52 Compliance points	163
53 General electrical characteristics	180
54 Transmitter device general electrical characteristics	180
55 Transmitter device termination characteristics	180

Author: intc-mseidel
Subject: Highlight
Date: 5/6/2008 4:07:47 PM
REJECT



Fix long table and figure names so that the wrap-around does not clutter the page number portion or the table/figure number portion.

56 Receiver device general electrical characteristics	182
57 Receiver device termination characteristics	183
58 Transmitter device signal output characteristics as measured with the zero-length test load at transmitter device compliance points IT and CT	189
59 Transmitter device signal output characteristics as measured with each test load at transmitter device compliance points IT and CT	190
60 Transmitter device maximum jitter as measured with each test load at transmitter device compliance points IT and CT	191
61 Transmitter device signal output characteristics for 6 Gbps at IT and CT	192
62 Transmitter device common mode voltage limit characteristics	193
63 S-parameters at the transmitter device compliance point IT_s or CT_s	194
64 Recommended transmitter device settings at IT and CT	195
65 Reference transmitter device characteristics at IT and CT	196
66 Transmitter device OOB signal output characteristics	198
67 OOB delivered signal characteristics	199
68 Delivered signal characteristics as measured with the zero length test load at receiver device compliance points IR and CR	199
69 Receiver device delivered signal characteristics at IR and CR	201
70 S-parameters at the receiver device compliance point IR_s or CR_s	201
71 Number of bits received per number of errors for BER confidence level of 95 %	203
72 Stressed receiver sensitivity test characteristics	204
73 Maximum delivered jitter at receiver device compliance points IR and CR	206
74 Receiver device jitter tolerance at receiver device compliance points IR and CR	207
75 SSC modulation types	208
76 SAS phy transmitter SSC modulation	209
77 Expander phy transmitter SSC modulation types	209
78 Receiver SSC modulation tolerance	210
79 Expander device center-spreading tolerance buffer	210
80 Output characteristics of the READY LED signal	212
81 Bit designations	213
82 Conversion from byte notation to character name example	214
83 Data characters	216
84 Control characters	221
85 Control character usage	221
86 Delayed code violation example	222
87 OOB signal timing specifications	225
88 OOB signal transmitter device requirements	225
89 OOB signal receiver device burst time detection requirements	228
90 OOB signal receiver device idle time detection requirements	228
91 OOB signal receiver device negation time detection requirements	228
92 SATA port selection signal transmitter device requirements	230
93 Phy reset sequence timing specifications	231
94 SATA speed negotiation sequence timing specifications	232
95 SAS speed negotiation sequence timing specifications	237
96 SNW rates used in SNW-1, SNW-2, and Final-SNW	239
97 SNW-3 phy capabilities bit	240
98 SNW-3 phy capabilities	240
99 Requested logical link rate	241
100 Multiplexing negotiation	241
101 Supported settings bit priorities	242
102 Example SNW-3 phy capabilities values	243
103 Training patterns	244
104 SP state machine timers	256
105 SP_DWS timers	279
106 Primitive format	287
107 Deletable primitives	288
108 Primitives not specific to type of connection	289

Page: xxviii

● Author: RElliott

Subject: Highlight

Date: 6/30/2008 6:16:52 PM

T ACCEPT - DONE (moved ITs or CTs earlier in the title so the title ends with normal text)

fix font in table of tables for table title ending in subscript

194

● Author: intc-mseidel

Subject: Highlight

Date: 5/25/2008 4:35:30 PM

T ACCEPT - DONE (moved IRs or CRs earlier in the title so the title ends with normal text. Then, changed IR to CR since those were the wrong names - kept the new word order, though, for consistency with table 70)

Fix the format on the page number for Table 70 to be the same font size as the rest of the page numbers.

109 Primitives used only inside SSP and SMP connections	291
110 Primitives used only inside STP connections and on SATA physical links	292
111 Primitive encoding for deletable primitives	293
112 Primitive encoding for primitives not specific to type of connection	294
113 Primitive encoding for primitives used only inside SSP and SMP connections	296
114 Primitive encoding for primitives used only inside STP connections and on SATA physical links	297
115 Primitive sequences	298
116 ALIGN primitives	302
117 MUX primitives	302
118 NOTIFY primitives	303
119 AIP primitives	305
120 BROADCAST primitives	306
121 CLOSE primitives	306
122 Abandon-class OPEN_REJECT primitives	308
123 Retry-class OPEN_REJECT primitives	309
124 DONE primitives	311
125 NAK primitives	311
126 RRDY primitives	312
127 Physical link rate tolerance management deletable primitive insertion requirement	315
128 CRC notation and definitions	316
129 Scrambling for different data dword types	320
130 Address frame format	326
131 ADDRESS FRAME TYPE field	326
132 IDENTIFY address frame format	327
133 DEVICE TYPE field	327
134 REASON field	328
135 OPEN address frame format	330
136 PROTOCOL field	331
137 FEATURES field	331
138 CONNECTION RATE field	331
139 ARBITRATION WAIT TIME field	333
140 SL_IR_IRC timers	336
141 Connection Results of a connection request	346
142 Arbitration priority for OPEN address frames passing on a physical link	347
143 Arbitration priority for contending Request Path requests in the ECM when all requests have Retry Priority Status arguments of NORMAL	349
144 Arbitration priority for contending Request Path requests in the ECM among requests with Retry Priority Status arguments of IGNORE AWT	349
145 Pathway recovery priority	351
146 Results of aborting a connection request	352
147 Results of closing a connection	354
148 Results of breaking a connection	355
149 Rate matching deletable primitive insertion requirements	356
150 SL_CC timers	363
151 SL_CC state machine variables	363
152 OPEN_REJECT Received message to Open Failed confirmation mapping	365
153 XL timers	371
154 SSP frame interlock requirements	387
155 SSP link layer timers	391
156 STP link layer differences from SATA link layer during an STP connection	402
157 Affiliation policies	406
158 Affiliation context relative identifier example	408
159 PL_OC state machine timers	422
160 Confirmations from Unable To Connect or Retry Open messages	429
161 PL_PM state machine timers	432
162 Messages from Open Failed confirmations	436
163 SSP frame format	443

This page contains no comments

164 FRAME TYPE field	444
165 COMMAND frame - Command information unit	447
166 TASK ATTRIBUTE field	448
167 TASK frame - Task Management Function information unit	448
168 TASK MANAGEMENT FUNCTION field	449
169 XFER_RDY frame - Transfer Ready information unit	450
170 DATA frame - Data information unit	451
171 RESPONSE frame - Response information unit	452
172 DATAPRES field	453
173 RESPONSE DATA field	453
174 RESPONSE CODE field	454
175 Sequences of SSP frames	455
176 Confirmations sent to the SCSI application layer if a frame transmission or reception error occurs	469
177 ST_ITS state machine variables	470
178 ST_ITS state machine arguments	471
179 Messages sent to the ST_IFR state machine	473
180 Transmission Complete messages for XFER_RDY frame verification failures	474
181 Reception Complete messages for read DATA frame verification failures	478
182 ST_T state machine timers	480
183 Task Management Function Executed Service Response argument mapping to Request (Send Transport Response) service response argument	485
184 Confirmations sent to the SCSI application layer	486
185 ST_TTS state machine variables	488
186 ST_TTS state machine arguments	488
187 Messages sent to the ST_TFR state machine	492
188 Additional messages sent to the ST_TFR state machine	493
189 Reception Complete message for write DATA frame verification failures	496
190 Request argument to RESPONSE frame response data field mapping	498
191 SMP frame format	500
192 SMP FRAME TYPE field	500
193 SMP_REQUEST frame format	501
194 SMP_RESPONSE frame format	501
195 MT_TP time limits	505
196 SCSI architecture mapping	508
197 Send SCSI Command transport protocol service arguments	509
198 SCSI Command Received transport protocol service arguments	510
199 Send Command Complete transport protocol service arguments	511
200 Command Complete Received transport protocol service arguments	512
201 Send Data-In transport protocol service arguments	513
202 Data-In Delivered transport protocol service arguments	513
203 Receive Data-Out transport protocol service arguments	514
204 Data-Out Received transport protocol service arguments	514
205 Terminate Data Transfer transport protocol service arguments	514
206 Data Transfer Terminated transport protocol service arguments	515
207 Send Task Management Request transport protocol service arguments	515
208 Task Management Request Received transport protocol service arguments	516
209 Task Management Function Executed transport protocol service arguments	517
210 Received Task Management Function Executed transport protocol service arguments	518
211 Delivery Result to additional sense code mapping	519
212 SCSI transport protocol events	520
213 SSP target port mode pages	521
214 Disconnect-Reconnect mode page for SSP	522
215 Protocol-Specific Logical Unit mode page for SAS SSP	524
216 Protocol-Specific Port mode page for SAS SSP	525
217 I_T NEXUS LOSS TIME field	526
218 Phy Control And Discover mode page	527
219 SAS phy mode descriptor	528

This page contains no comments

220 Shared Port Control mode page	529
221 SAS-2 Phy mode page	530
222 SAS-2 phy mode descriptor	531
223 Protocol-Specific Port log page for SAS SSP	532
224 Protocol-Specific Port log parameter for SAS	533
225 Parameter control byte in the Protocol-Specific Port log parameter for SAS	534
226 SAS phy log descriptor	534
227 SSP target port diagnostic pages	536
228 Diagnostic pages affected by zoning	536
229 Protocol-Specific diagnostic page for SAS SSP	537
230 PHY TEST FUNCTION field	538
231 PHY TEST PATTERN field	539
232 PHY TEST PATTERN SSC field	540
233 PHY TEST PATTERN PHYSICAL LINK RATE field	540
234 PHY TEST PATTERN DWORDS CONTROL field	541
235 TWO_DWORDS phy test pattern examples	542
236 VPD pages with special requirements for SAS SSP	549
237 Device Identification VPD page designation descriptors for the SAS target port	549
238 Device Identification VPD page designation descriptors for the SAS target device	550
239 Protocol-Specific Logical Unit Information VPD page for SAS SSP	551
240 Logical unit information descriptor for SAS SSP	552
241 READY LED signal behavior	553
242 SMP functions (FUNCTION field)	554
243 SMP request frame format	556
244 SMP response frame format	558
245 FUNCTION RESULT field	558
246 Function result priority	562
247 REPORT GENERAL request	567
248 REPORT GENERAL response	567
249 NUMBER OF ZONE GROUPS field	571
250 REPORT MANUFACTURER INFORMATION request	573
251 REPORT MANUFACTURER INFORMATION response	575
252 REPORT SELF-CONFIGURATION STATUS request	577
253 REPORT SELF-CONFIGURATION STATUS response	578
254 Self-configuration status descriptor	580
255 STATUS TYPE field	580
256 REPORT ZONE PERMISSION TABLE request	582
257 REPORT TYPE field	582
258 REPORT ZONE PERMISSION TABLE response	583
259 Zone permission descriptor for a source zone group (i.e., s) with 128 zone groups	584
260 Zone permission descriptor for a source zone group (i.e., s) with 256 zone groups	584
261 Zone permission descriptor bit requirements	585
262 REPORT ZONE MANAGER PASSWORD request	585
263 REPORT ZONE MANAGER PASSWORD response	586
264 REPORT BROADCAST request	587
265 REPORT BROADCAST response	588
266 Broadcast descriptor	589
267 BROADCAST REASON field	590
268 DISCOVER request	591
269 DISCOVER response	592
270 ATTACHED DEVICE TYPE field	595
271 NEGOTIATED LOGICAL LINK RATE field	595
272 ATTACHED SATA PORT SELECTOR and ATTACHED SATA DEVICE bits	596
273 PROGRAMMED MINIMUM PHYSICAL LINK RATE and PROGRAMMED MAXIMUM PHYSICAL LINK rate fields	598
274 HARDWARE MINIMUM PHYSICAL LINK RATE and HARDWARE MAXIMUM PHYSICAL LINK RATE fields	599
275 ROUTING ATTRIBUTE field	600
276 ATTACHED DEVICE NAME field	601

This page contains no comments

277 SELF-CONFIGURATION STATUS field	602
278 SELF-CONFIGURATION LEVELS COMPLETED field	602
279 NEGOTIATED PHYSICAL LINK RATE field	603
280 REPORT PHY ERROR LOG request	605
281 REPORT PHY ERROR LOG response	606
282 REPORT PHY SATA request	607
283 REPORT PHY SATA response	608
284 REPORT ROUTE INFORMATION request	611
285 REPORT ROUTE INFORMATION response	612
286 REPORT PHY EVENT request	613
287 REPORT PHY EVENT response	614
288 Phy event descriptor	615
289 DISCOVER LIST request	616
290 PHY FILTER field	617
291 DESCRIPTOR TYPE field	617
292 DISCOVER LIST response	617
293 SHORT FORMAT descriptor	619
294 REPORT PHY EVENT LIST request	620
295 REPORT PHY EVENT LIST response	622
296 Phy event list descriptor	623
297 REPORT EXPANDER ROUTE TABLE LIST request	624
298 REPORT EXPANDER ROUTE TABLE LIST response	625
299 REPORT EXPANDER ROUTE TABLE descriptor	626
300 CONFIGURE GENERAL request	628
301 STP SMP I_T NEXUS LOSS TIME field	629
302 CONFIGURE GENERAL response	630
303 ENABLE DISABLE ZONING request	631
304 SAVE field	631
305 ENABLE DISABLE ZONING field	632
306 ENABLE DISABLE ZONING response	632
307 ZONED BROADCAST request	633
308 BROADCAST TYPE field	634
309 ZONED BROADCAST response	634
310 ZONE LOCK request	635
311 ZONE LOCK response	636
312 ZONE ACTIVATE request	637
313 ZONE ACTIVATE response	638
314 ZONE UNLOCK request	639
315 ZONE UNLOCK response	639
316 CONFIGURE ZONE MANAGER PASSWORD request	640
317 SAVE field	641
318 CONFIGURE ZONE MANAGER PASSWORD response	641
319 CONFIGURE ZONE PHY INFORMATION request	642
320 SAVE field	643
321 Zone phy configuration descriptor	643
322 CONFIGURE ZONE PHY INFORMATION response	644
323 CONFIGURE ZONE PERMISSION TABLE request	645
324 NUMBER OF ZONE GROUPS field	646
325 SAVE field	646
326 Zone permission configuration descriptor for source zone group (i.e., s) for 128 zone groups	646
327 Zone permission configuration descriptor for source zone group (i.e., s) for 256 zone groups	647
328 Zone permission configuration descriptor bit requirements	647
329 CONFIGURE ZONE PERMISSION TABLE response	648
330 CONFIGURE ROUTE INFORMATION request	649
331 CONFIGURE ROUTE INFORMATION response	650
332 PHY CONTROL request	651
333 PHY OPERATION field	652

This page contains no comments

334 PROGRAMMED MINIMUM PHYSICAL LINK RATE and PROGRAMMED MAXIMUM PHYSICAL LINK RATE fields	655
335 PHY CONTROL response	656
336 PHY TEST FUNCTION request	657
337 PHY TEST FUNCTION field	658
338 PHY TEST PATTERN PHYSICAL LINK RATE field	659
339 PHY TEST FUNCTION response	659
340 CONFIGURE PHY EVENT request	660
341 Phy event configuration descriptor	661
342 CONFIGURE PHY EVENT response	661
A.1 JTPAT for RD+	663
A.2 JTPAT for RD-	664
A.3 JTPAT for RD+ and RD-	665
A.4 CJTPAT	667
A.5 CJTPAT with fixed content	671
D.1 CRC examples	699
E.1 Monte-Carlo simulation results	700
E.2 Hash results for simple SAS addresses	703
E.3 Hash results for realistic SAS addresses	703
E.4 Hash results for a walking ones pattern	704
E.5 Hash results for a walking zeros pattern	705
F.1 Scrambler examples	708
H.1 Minimum deletable primitive insertion rate examples	712
I.1 Zone permission table example initial value	713
I.2 CONFIGURE ZONE PERMISSION TABLE request example	714
I.3 Zone permission table after processing the first zone permission configuration descriptor	715
I.4 Zone permission table after processing the second zone permission configuration descriptor	715
J.1 Column descriptions for connection examples	717
K.1 Primitives with Hamming distance of 8	737
K.2 Primitives without Hamming distance of 8	739
L.1 C program files	740

This page contains no comments

Figures

	Page
1 SCSI document relationships	1
2 ATA document relationships	2
3 Classes in class diagrams	27
4 Association relationships in class diagrams	28
5 Aggregation relationships in class diagrams	29
6 Generalization relationships in class diagrams	29
7 Dependency relationships in class diagrams	30
8 Objects in object diagrams	30
9 State machine conventions	31
10 SAS Domain class diagram	35
11 Physical links and phys	36
12 Phy class diagram	37
13 SAS phy object diagram	38
14 Expander phy object diagram	39
15 Ports (narrow ports and wide ports)	41
16 Port class diagram	42
17 Port object diagram	43
18 SAS devices	44
19 Expander device	45
20 Expander Device class diagram	46
21 Domains	46
22 SAS domain bridging to ATA domains	47
23 SAS domains bridging to ATA domains with SATA port selectors	48
24 Devices spanning SAS domains	49
25 Single expander device topology example	49
26 Multiple expander device topologies	50
27 Potential pathways	51
28 Multiple connections on wide ports	53
29 State machines for SAS devices	59
30 State machines for expander devices	60
31 Transmit data path in a SAS phy	61
32 SSP link, port, SSP transport, and SCSI application layer state machines	62
33 SMP link, port, SMP transport, and management application layer state machines	63
34 STP link, port, STP transport, and ATA application layer state machines	64
35 Transmit data path and state machines in an expander phy	65
36 Receive data path in a SAS phy	66
37 Receive data path in an expander phy	67
38 State machines and SAS Device classes	68
39 State machines and Expander Device classes	69
40 Reset terminology	70
41 Expander device model	73
42 Expander device interfaces	76
43 Expander device interface detail	77
44 Phy-based expander route table	84
45 Expander-based expander route table	85
46 Level-order traversal example	87
47 Examples of invalid topologies	90
48 Externally configurable expander device and table-to-table attachment	93
49 Expander route index levels example	94
50 Expander route index order example	96
51 One ZPSDS example	98
52 Zone manager location examples	99
53 Three ZPSDSes example	100
54 Extending a ZPSDS example	102
55 Overtaking a ZPSDS example	103

This page contains no comments

56 Zoning expander route table	108
57 Example of a ZPSDS	110
58 SATA connectors and cables	121
59 SAS Drive cable environments	122
60 SAS Drive backplane environment	122
61 SAS external cable environment	123
62 SAS internal symmetric cable environment - controller to backplane	123
63 SAS internal symmetric cable environment - controller to controller	124
64 SAS internal controller-based fanout cable environment	124
65 SAS internal backplane-based fanout cable environment	125
66 SAS Drive plug connector	127
67 Single-port SAS Drive cable receptacle connector	127
68 Dual-port SAS Drive cable receptacle connector	128
69 SAS Drive backplane receptacle connector	128
70 SAS 4i cable receptacle connector	131
71 SAS 4i plug connector	131
72 Mini SAS 4i cable plug connector	134
73 Mini SAS 4i receptacle connector	134
74 SAS 4x cable plug connector	137
75 SAS 4x receptacle connector	138
76 Mini SAS 4x cable plug connector	140
77 Mini SAS 4x cable plug connector that attaches to an enclosure out port	141
78 Mini SAS 4x cable plug connector that attaches to an enclosure in port	141
79 Mini SAS 4x receptacle connector	142
80 Mini SAS 4x receptacle connector - end device or enclosure universal port	143
81 Mini SAS 4x receptacle connector - enclosure out port	143
82 Mini SAS 4x receptacle connector - enclosure in port	143
83 Single-port SAS Drive cable assembly	145
84 Dual-port SAS Drive cable assembly	145
85 SAS internal symmetric cable assembly - SAS 4i	146
86 SAS internal symmetric cable assembly - Mini SAS 4i	147
87 SAS internal symmetric cable assembly - SAS 4i to Mini SAS 4i with vendor-specific sidebands	148
88 SAS internal symmetric cable assembly - SAS 4i controller to Mini SAS 4i backplane with SGPIO	150
89 SAS internal symmetric cable assembly - Mini SAS 4i controller to SAS 4i backplane with SGPIO	151
90 SAS internal controller-based fanout cable assembly - SAS 4i	153
91 SAS internal controller-based fanout cable assembly - Mini SAS 4i	154
92 SAS internal backplane-based fanout cable assembly - SAS 4i	155
93 SAS internal backplane-based fanout cable assembly - Mini SAS 4i	156
94 SAS external cable assembly - SAS 4x	157
95 SAS external cable assembly - Mini SAS 4x	158
96 SAS external cable assembly with Mini SAS 4x cable plug connectors	159
97 SAS external cable assembly - SAS 4x to Mini SAS 4x	160
98 SAS 4x and Mini SAS 4x cable assembly CT and CR compliance points	164
99 Backplane with SAS Drive connector IT and IR compliance points	165
100 Backplane with SAS Drive connector compliance points with SATA phy attached	166
101 SAS 4i and Mini SAS 4i cable assembly IT and IR compliance points	167
102 SAS 4i and Mini SAS 4i cable assembly and backplane IT and IR compliance points	168
103 SAS 4i or Mini SAS 4i cable assembly and backplane IT and IR compliance points with SATA device attached	169
104 SAS Drive cable assembly IT and IR compliance points	170
105 Zero-length test load for transmitter device compliance point	171
106 Zero-length test load for receiver device compliance point	172
107 Zero-length test load S_{DD21}	173
108 TCTF test load	173
109 TCTF test load S_{DD21} and ISI loss requirements at IT at 3 Gbps	174
110 TCTF test load S_{DD21} and ISI loss requirements at CT at 3 Gbps	175
111 TCTF test load S_{DD21} and ISI loss requirements at IT at 1.5 Gbps	176

Author: intc-mseidel

Subject: Highlight

Date: 5/25/2008 4:35:57 PM

T ACCEPT - DONE (added "requirements" on the end of the title so it ends in normal text)

Fix the format on the page number for Figure 107 to be the same font size as the rest of the page numbers.

112 TCTF test load S_{DD21} and ISI loss requirements at CT at 1.5 Gbps	177
113 Low-loss TCTF test load	177
114 Low-loss TCTF test load S_{DD21} and ISI loss requirements	178
115 Reference transmitter test load physical characterization	179
116 Example 6 Gbps TxRx connection compliance testing	182
117 Transmitter device transient test circuit	184
118 Receiver device transient test circuit	184
119 Transmitter device eye mask	185
120 Receiver device eye mask	186
121 Deriving a receiver device jitter tolerance eye mask	187
122 Applied sinusoidal jitter	188
123 Transmitter device common mode voltage limit	193
124 S-parameter values	194
125 Transmitter device S_{CC22} and S_{DD22} limits	195
126 Transmitter device S_{CD22} limits	195
127 Transmitter equalization measurement	197
128 Receiver device S_{CC11} and S_{DD11} limits	202
129 Receiver device S_{CD11} limits	202
130 Reference receiver device	203
131 Stressed receiver sensitivity test block diagram	204
132 Jitter tolerance test block diagram	206
133 Center-spreading tolerance buffer	211
134 SAS bit transmission logic	223
135 SAS bit reception logic	224
136 OOB signal transmission	227
137 OOB signal detection	229
138 SATA port selection signal	230
139 SATA OOB sequence	231
140 SATA speed negotiation sequence	232
141 SAS to SATA OOB sequence	233
142 SAS to SAS OOB sequence	235
143 SNW-1, SNW-2, and Final-SNW	238
144 SNW-3	239
145 Train-SNW	244
146 SAS speed negotiation sequence SNW flowchart	245
147 SAS speed negotiation sequence (phy A: SNW-1 through SNW-3, phy B: SNW-2 only)	247
148 SAS speed negotiation sequence (both phys SNW-1 through SNW-3)	248
149 SAS speed negotiation sequence - phy reset problem in Final-SNW	249
150 SAS speed negotiation sequence - phy reset problem in SNW-3	250
151 SAS speed negotiation sequence - phy reset problem in Train-SNW	251
152 SAS speed negotiation sequence - multiple Train-SNWs	252
153 Hot-plug and the phy reset sequence	254
154 SP (phy layer) state machine - OOB sequence states	258
155 SP (phy layer) state machine - SAS speed negotiation states	264
156 SP (phy layer) state machine - SAS speed negotiation states for SNW-3 and Train-SNW	265
157 SP (phy layer) state machine - SATA host emulation states	273
158 SP (phy layer) state machine – SATA port selector state	277
159 SP (phy layer) state machine - SATA spinup hold state	278
160 SP_DWS (phy layer dword synchronization) state machine	280
161 Multiplexing disabled	285
162 Multiplexing enabled	285
163 Transmitting a repeated primitive sequence	298
164 Receiving a repeated primitive sequence	299
165 Extended primitive sequences	299
166 Triple primitive sequences	300
167 Redundant primitive sequences	301
168 Elasticity buffer	314

This page contains no comments

169 Address frame, SSP frame, and SMP frame CRC bit ordering	318
170 STP frame CRC bit ordering	319
171 Transmit path bit ordering	322
172 Receive path bit ordering	323
173 STP transmit path bit ordering	324
174 STP receive path bit ordering	325
175 Address frame transmission	325
176 Identification sequence	334
177 Hard reset sequence	335
178 SL_IR (link layer identification and hard reset) state machines	337
179 Example simultaneous connection recommendations for wide ports	345
180 Aborting a connection request with BREAK	353
181 Connection request timeout example	354
182 Closing a connection example	355
183 Rate matching example	357
184 SL (link layer for SAS logical phys) state machines (part 1)	359
185 SL (link layer for SAS logical phys) state machines (part 2)	360
186 XL (link layer for expander logical phys) state machine (part 1)	372
187 XL (link layer for expander logical phys) state machine (part 2)	373
188 XL (link layer for expander logical phys) state machine (part 3)	374
189 SSP frame transmission	386
190 Interlocked frames	388
191 Non-interlocked frames with the same tag	388
192 Non-interlocked frames with different tags	389
193 Closing an SSP connection example	390
194 SSP (link layer for SSP phys) state machines (part 1 - frame transmission)	392
195 SSP (link layer for SSP phys) state machines (part 2 - frame reception)	393
196 STP frame transmission	401
197 STP flow control	404
198 Transmitting a continued primitive sequence	405
199 Receiving a continued primitive sequence	406
200 Example simultaneous connection recommendations for an expander device	409
201 STP initiator port opening an STP connection	411
202 STP target port opening an STP connection	412
203 SMP frame transmission	413
204 SMP_IP (link layer for SMP initiator phys) state machine	415
205 SMP_TP (link layer for SMP target phys) state machine	417
206 Port layer examples	420
207 PL_OC (port layer overall control) state machine	423
208 PL_PM (port layer phy manager) state machine (part 1)	433
209 PL_PM (port layer phy manager) state machine (part 2)	434
210 Task management function sequence of SSP frames	455
211 Non-data command sequence of SSP frames	455
212 Write command sequence of SSP frames	456
213 Read command sequence of SSP frames	456
214 Bidirectional command sequence of SSP frames	457
215 ST_I (transport layer for SSP initiator ports) state machines	465
216 ST_T (transport layer for SSP target ports) state machines	481
217 Sequence of SMP frames	502
218 MT_IP (transport layer for SMP initiator ports) state machine	503
219 MT_TP (transport layer for SMP target ports) state machine	505
220 SA_PC (SCSI application layer power condition) state machine for SAS	544
A.1 CJTPAT pre-scrambling	666
B.1 A simple physical link	673
B.2 Transmitter device details	674
B.3 Receiver device details	675
B.4 De-embedding of connectors in test fixtures	677

This page contains no comments

B.5 Measurement conditions for signal output at the transmitter device	678
B.6 Transmitter device signal output measurement test fixture details	678
B.7 Measurement conditions for signal tolerance at the transmitter device	679
B.8 Calibration of test fixture for signal tolerance at the transmitter device	679
B.9 Measurement conditions for signal output at the receiver device	679
B.10 Measurement conditions for signal tolerance at the receiver device	680
B.11 Calibration of test fixture for signal tolerance at the receiver device	680
B.12 S-parameter port naming conventions	682
B.13 Four single-ended port or two differential port element	683
B.14 S-parameters for single-ended and differential systems	683
B.15 Measurement conditions for S_{22} at the transmitter device connector	684
B.16 Measurement conditions for S_{11} at the receiver device connector	685
B.17 Measurement conditions for S_{11} at IT or CT	686
B.18 Measurement conditions for S_{22} at IR or CR	687
C.1 SAS speed negotiation sequence (phy A: SNW-1 only, phy B: SNW-1 only)	691
C.2 SAS speed negotiation sequence (phy A: SNW-1, SNW-2, phy B: SNW-1, SNW-2)	692
C.3 SAS speed negotiation sequence (phy A: SNW-1, SNW-2, SNW-3, phy B: SNW-1, SNW-2)	693
C.4 SAS speed negotiation sequence (phy A: SNW-2, SNW-3, phy B: SNW-1, SNW-2)	694
C.5 SAS speed negotiation sequence (phy A: SNW-1 only, phy B: SNW-2 only)	695
D.1 CRC generator example	696
D.2 CRC checker example	696
E.1 BCH(69, 39, 9) code generator	701
F.1 Scrambler	706
J.1 Example topology	716
J.2 Connection request - OPEN_ACCEPT	718
J.3 Connection request - OPEN_REJECT by end device	719
J.4 Connection request - OPEN_REJECT by expander device	720
J.5 Connection request - arbitration lost	721
J.6 Connection request - backoff and retry	722
J.7 Connection request - backoff and reverse path	723
J.8 Connection close - single step	724
J.9 Connection close - simultaneous	725
J.10 BREAK handling during path arbitration when the BREAK_REPLY method is disabled	726
J.11 BREAK handling during a connection when the BREAK_REPLY method is disabled	727
J.12 BREAK handling during path arbitration when the BREAK_REPLY method is enabled	728
J.13 BREAK handling during a connection when the BREAK_REPLY method is enabled	729
J.14 STP connection - originated by STP initiator port	730
J.15 STP connection - originated by STP target port in an STP/SATA bridge	731
J.16 STP connection close - originated by STP initiator port	732
J.17 STP connection close - originated by STP target port in an STP/SATA bridge	733
J.18 XL1:Request_Path to XL5:Forward_Open transition	734
J.19 Partial pathway recovery	735
M.1 SAS primary icon	778
M.2 SAS alternate icon	778
M.3 SAS alternate icon with SAS letters	779

This page contains no comments

Revision Information

R.1 Revision sas2r00 (1 October 2005)

First release of SAS-2. The project proposal was 05-060r0.

Incorporated these changes per the January 2005 CAP WG (05-035r0) and T10 plenary (05-036r2):

- a) 04-372r2 SAM-4 SPC-4 SAS-2 I_T NEXUS RESET task management function (Rob Elliott, HP)
- b) 04-297r2 SAM-4 SAS-2 FCP-3 Retry delay (George Penokie, IBM)

No changes were approved in the March 2005 T10 plenary (05-097r0) or the May 2005 T10 plenary (05-165r1).

Incorporated these changes per the July 2005 SAS protocol WG (05-272r0) and T10 plenary (05-275r0):

- a) 05-167r5 SAS-2 New NOTIFY to indicate imminent power failure (George Penokie, IBM)

Incorporated these changes per the September 2005 SAS protocol WG (05-335r0) and T10 plenary (05-338r0):

- a) 05-299r1 Correct log page format tables in SPC-4, SBC-3, and SAS-2 (Ralph Weber, ENDL)
- b) 05-305r0 Maximum SMP response time (Rob Elliott, HP)
- c) 05-307r0 SAS-2 Modifications to NOTIFY to indicate imminent power failure (Mark Evans, Maxtor), dropping the proposed note that just restates the rule being added.

R.2 Revision sas2r01 (13 November 2005)

Incorporated these changes per the November 2005 SAS protocol WG (05-417r0) and T10 plenary (05-420r0):

- a) 04-222r6 SAS-2 More phy test patterns (Rob Elliott, HP). Added the PHY TEST PATTERN DWORDS CONTROL and PHY TEST PATTERN DWORDS fields to the SMP PHY TEST FUNCTION function.
- b) 05-306r2 SAS-2 STP connection time limits and STP/SMP I_T nexus loss (Rob Elliott, HP). Corrected all the length field values.
- c) 05-412r0 SAS-2 revision 0 minor corrections (Rob Elliott, HP)
- d) 05-370r2 SAS-2 NOTIFY (POWER FAILURE EXPECTED) fixes (George Penokie, IBM). Included a PROTOCOL IDENTIFIER field in the new subpage to follow the convention of the Protocol-Specific mode pages
- e) Changed the ST_ITS3 and ST_ITS4 states to set the TARGET PORT TRANSFER TAG field to FFFFh rather than zero (for COMMAND and TASK frames) to agree with the definition of the field in 9.2.1 (found by Ron Roberts, Broadcom)

R.3 Revision sas2r02 (18 January 2006)

Incorporated these changes per the January 2006 SAS protocol WG (06-038r0) and T10 plenary (06-041r0):

- a) 06-055r0 (aka 04-172r4) SAS-2 More counters (Rob Elliott, HP)
- b) 05-309r3 SAS-2 Add device name to IDENTIFY address frame (Rob Elliott, HP)
- c) 06-028r1 SAS-2 Redundant primitive sequence handling (Steve Gorshe, PMC-Sierra)
- d) 06-054r1 SAS-2 Expander issue resolutions (Rob Elliott, HP) covering issues raised by 05-373r2 SAS-2 Expander issues (Craig Stoops, Expert I/O)

R.4 Revision sas2r03 (20 March 2006)

Incorporated these changes per the March 2006 SAS protocol WG (06-124r0) and T10 plenary (06-127r0):

- a) 06-122r2 SAS-2 zoning - phy features (Ralph Weber, ENDL). Conflicts with 06-082r2 about whether the SMP function contains source or destination zone group numbers, especially related to the zone address resolved method, are described with editor's notes. How source zone group 2 is handled was not mentioned; made it based on the zone permission table like all other source zone groups and included an editor's note that more rewrite may be forthcoming. Vague rule about not sending "zoning information" out certain phys tagged with an editor's note. Included editor's notes by each reference to an SMP zone configuration function that is not yet defined.
- b) 06-130r1 SAS-2 sticky zone groups (Kevin Marks, Dell)

● Author: Isi-gpenokie

Subject: Sticky Note

Date: 6/30/2008 2:29:51 PM

 ACCEPT - LAST (remove revision that is forwarded)

The revision information needs to be removed.

- c) 06-082r2 SAS-2 zoning-related SMP functions (Ralph Weber, ENDL and Steve Johnson, LSI Logic) - adds the ORIGINATE BROADCAST PRIMITIVES function. Changed name of the function to ZONED BROADCAST.
- d) 06-083r1 SAS-2 Handle STP CLOSE and SATA_X_RDY crossing on the wire (Bob Sheffield, Intel)
- e) 06-099r0 SAS-2 Transitions from SL_CC1:ArbSel (Brian Day, LSI Logic). Used "SOAF/Data Dwords/EOAF Transmitted message" instead of "transmitted the OPEN address frame", and changed two more instances of "transmitted the OPEN address frame" in Transition SL_CC1 to SL_CC2 and Transition SL_CC1 to SL_CC3.
- f) 06-101r0 SAS-2 Minor corrections to STP flow control formula (Brian Day, LSI Logic)
- g) 06-134r0 SAS-2 Renumber phy event information codes (Rob Elliott, HP). Also renumbered "Received SMP frame error count" from 62h to 63h to leave room for a possible "Transmitted SMP frame error count" value at 62h.
- h) In the edge expander device rules, changed "no phy using the subtractive routing method is available" to "...exists" for generation of Arb Reject (No Destination).

R.5 Revision sas2r03a (22 April 2006)

Incorporated these changes per the 23 March 2006 SAS physical WG teleconference (06-171r0) and the 20 April 2006 SAS zoning WG (06-205r0) (subsequently approved by the May T10 plenary (06-233r0)):

- a) 06-181r2 SAS-2 Zone group values after a link reset sequence (Kevin Marks, Dell)
- b) 06-165r0 SAS-2 Change SMP ZONE VIOLATION code values (Rob Elliott, HP)
- c) 06-167r1 SAS-2 Filtering OPEN content based on ZONE PARTICIPATING bit (Rob Elliott, HP)
- d) 06-168r1 SAS-2 OPEN address frame SOURCE ZONE GROUP field definition (Rob Elliott, HP)
- e) 06-166r4 SAS-2 Restrict access to SMP ZONED BROADCAST function (Rob Elliott, HP)
- f) 06-176r2 SAS-2 Add phy zone information to SMP DISCOVER (Tim Symons, PMC-Sierra and Rob Elliott, HP)
- g) 06-169r1 SAS-2 Correct receiver device jitter table footnotes (Rob Elliott, HP)
- h) added SAM-4 and SPC-4 to references list; changed SAM-3 reference to SAM-4 for the RETRY DELAY TIMER field in the SSP RESPONSE frame (did not change any others yet)
- i) added dword counts to each JTPAT table, and the INFORMATION UNIT field name to the left column of the CJTPAT table

R.6 Revision sas2r04 (16 May 2006)

Incorporated these changes per the May 2006 SAS protocol WG (06-230r1) and T10 plenary (06-233r0):

- a) 06-161r0 SAS-2 Alternate icon (Rob Elliott, HP)
- b) 06-119r2 SAS-2 BREAK_REPLY (Tim Hogle, LSI Logic)
- c) 06-164r2 SAS-2 Require expanders transmit three AIPs (Rob Elliott, HP)
- d) 06-199r1 SAS-2 No BROADCASTs before link reset sequence completes (Luben Tuikov, Vitesse and Rob Elliott, HP)
- e) 06-044r3 SAS-2 BROADCAST (ASYNCHONOUS EVENT) (Steve Fairchild, HP)
- f) 06-177r3 SAS-2 ZONED BROADCAST clarification (Ed D'Avignon, Vitesse and Rob Elliott, HP)
- g) 06-097r4 SAS-2 Discovery - Configuring bit (Tim Symons, PMC-Sierra)
- h) 06-212r1 SAS-2 Zone group of an expander's SMP (Ed D'Avignon, Vitesse). Placed the rule in the zone phy information section defining the zone group field rather than in the zone permission table section.
- i) Changed RX1/RX2/RX3/RX4 to Rx 0/Rx 1/Rx 2/Rx 3 in the table of Additional requirements for SAS 4x cable assemblies
- j) Changed RXn to Rx n and TXn to Tx n in the table of Additional requirements for SAS 4i cable assemblies
- k) Normalized the table formatting for descriptor lists
- l) Changed COMPONENT REVISION ID to COMPONENT REVISION LEVEL in the REPORT MANUFACTURER INFORMATION response table to match the usage below the table
- m) Changed "not enabled" to "disabled" globally (just two times, all related to first burst)
- n) Changed "forwarded OPEN_REJECTs" to "OPEN_REJECTs in response to forwarded OPEN address frames" in the phy event information sources 22h and 24h
- o) Added "An SSP initiator port does not reuse a tag until it receives indication from the SSP target port that the tag is no longer in use (see 9.2.4, 9.2.5, and 10.2.2)." in 9.2.1 definition of the TAG field.

This page contains no comments

R.7 Revision sas2r04a (25 June 2006)

Incorporated these changes per the 20 June 2006 SAS zoning WG (06-290r0) (subsequently approved by the July T10 plenary (06-319r0)):

- a) 06-197r3 SAS-2 Add expander change count to most SMP functions (Rob Elliott, HP)
- b) 06-208r2 SAS-2 Restrict access to SMP write functions (Rob Elliott, HP)
- c) 06-213r2 SAS-2 REPORT GENERAL additions for zoning and self configuration (Steve Johnson, LSI Logic)
- d) 06-037r7 SAS-2 DISCOVER LIST function (Steve Johnson, LSI Logic). Throughout the standard, wherever DISCOVER was referenced, added mention of DISCOVER LIST if it is equally appropriate.
- e) 06-078r3 SAS-2 REPORT ROUTE TABLE function (Steve Johnson, LSI Logic). Updated the model to support this function. Defined two types of expander route tables - phy-based (accessed with the old functions, indexed by numbers dictated by the discover process) and expander-based (accessed with this function, indexed by "routed SAS address"). The latter is called a zoning expander route table in a zoning expander device. 06-078r4 was posted after approval, correcting byte numbers in the REPORT EXPANDER ROUTE TABLE descriptor. The fields in the descriptor were substantially rearranged during incorporation, rendering those changes moot.
- f) Changed "zoning expander device" to mean zoning is supported, not necessarily enabled. Sprinkled "if zoning is enabled" throughout.
- g) In 4.8.1, tweaked introduction from "Every phy in a ZPSDS belongs to a zone group" to "Every phy in the SAS domain may belong to a zone group." Mentioned that phys within the ZPSDS are in zone group 1, phys attached to the boundary pick up their zone groups from the zone phy information of the expander device to which they are attached, and phys beyond the boundary are in zone groups if the address resolved method is being used.

R.8 Revision sas2r05 (21 July 2006)

Incorporated these changes per the July 2006 SAS protocol WG (06-316r0), SAS physical WG (06-348r0), and T10 plenary (06-319r0):

- a) 05-322r4 SAS-2 Wide SSP target port simultaneous connection rules (Rob Elliott, HP)
- b) 06-187r2 SAS-2 Self-configuring expander status (Rob Elliott, HP)
- c) 06-273r1 SAS-2 Bus Inactivity Timer is Broken (Steve Finch, STMicroelectronics). Also changed all the timer-related unordered lists into ordered lists.
- d) 06-302r1 SAS-2 Multiple broadcasts on reset (George Penokie, IBM)
- e) 06-189r3 SAS-2 Allow table-to-table expander attachment (Rob Elliott, HP)
- f) 06-304r2 SAS-2 SMP function result priority (Zenta Darnell, Vitesse). Deleted PHY VACANT from the list of DISCOVER LIST responses; it can appear in the full DISCOVER responses but not in the outer DISCOVER LIST response itself. Added SMP ZONE VIOLATION to CONFIGURE GENERAL, PHY CONTROL, PHY TEST FUNCTION, and CONFIGURE PHY EVENT INFORMATION, with a priority just below PHY VACANT.
- g) 06-210r4 SAS-2 Reporting ZONE PARTICIPATING CAPABLE in the IDENTIFY address frame (Kevin Marks, Dell). Renamed ZONE PARTICIPATING in bit names to INSIDE ZPSDS to help the DISCOVER response table fit on the page (still requires a drop in font size).
- h) 06-332r1 SAS-2 PL_PM3 fixes (George Penokie, IBM)
- i) 06-259r1 SAM-4 et. al. making linked commands obsolete (Mark Evans, Maxtor)
- j) 06-323r1 SAM-4 et. al. Multiple service delivery subsystem editorial tweaks (Rob Elliott, HP). Updated all references to SAM-3 to SAM-4, SPC-3 to SPC-4, SBC-2 to SBC-3, and ATA/ATAPI-7 V1 to ATA8-AAM and ATA8-ACS. In the Protocol-Specific Port log parameter, merged the LBIN and LP bits into a FORMAT AND LINKING field, added a DS bit and an SPF bit in byte 0, and marked the DS bit in the parameter control byte obsolete to agree with SPC-4.
- k) corrected dword numbers in JTPAT tables
- l) fixed ms to μ s in the STP BUS INACTIVITY TIME LIMIT field and STP MAXIMUM CONNECT TIME LIMIT field descriptions (Symbol font was not preserved when 05-306r2 was incorporated)
- m) use "management device server" rather than "SMP target port" where appropriate in chapter 10
- n) added OPEN_REJECT (ZONE VIOLATION) handling throughout the state machines, generally wherever OPEN_REJECT (PROTOCOL NOT SUPPORTED) is handled. Add Arb Reject (Zone Violation) as lower priority than Arb Reject (Bad Connection Rate).

This page contains no comments

- o) added OPEN_REJECT (RESERVED ...) handling throughout the state machines wherever their "process as" peers are handled
- p) 05-251r0 requested deletion in SAS-1.1 of the last three words of "shall not complete the [START STOP UNIT] command with GOOD status" in the Power Condition state machine transition state descriptions, but that change was missed. 06-299r1 requests the same change again.
- q) Added "The ADDITIONAL RESPONSE BYTES may be present but shall be ignored." to SMP function results of INVALID EXPANDER CHANGE COUNT, PHY EVENT INFORMATION SOURCE NOT SUPPORTED, and SMP ZONE VIOLATION. Although the functions that return those don't yet return ADDITIONAL RESPONSE BYTES, functions could do so in the future and that general rule is intended to apply.
- r) Added a figure in front of the CJTPAT table showing how pre-scrambling the desired pattern results in the desired pattern on the wire.

R.9 sas2r05a (21 July 2006)

Incorporated the following proposals per the July SAS zoning WG (06-349r0)(r3 of each was subsequently approved by the September 2006 T10 plenary (06-417r0):

- a) 06-279r2 SAS-2 Allow more than one ZPSDS in a SAS domain (Rob Elliott, HP)
- b) 06-281r2 SAS-2 Enable and disable zoning (Rob Elliott, HP)

R.10 sas2r05b (1 September 2006)

Incorporated the following proposals per the August SAS zoning WG (06-376r1)(subsequently approved by the September 2006 T10 plenary (06-417r0)):

- a) 06-201r6 SAS-2 SMP CONFIGURE ZONE PHY INFORMATION function (Tim Symons, PMC-Sierra)
- b) 06-203r6 SAS-2 SMP REPORT ZONE PERMISSION TABLE function (Tim Symons, PMC-Sierra)
- c) 06-279r3 SAS-2 Allow more than one ZPSDS in a SAS domain (Rob Elliott, HP)
- d) 06-281r3 SAS-2 Enable and disable zoning (Rob Elliott, HP)
- e) 06-286r5 SAS-2 SMP ZONE LOCK function (Tim Symons, PMC-Sierra)
- f) 06-288r6 SAS-2 SMP ZONE ACTIVATE function (Tim Symons, PMC-Sierra)
- g) 06-289r6 SAS-2 SMP ZONE UNLOCK function (Tim Symons, PMC-Sierra)
- h) 06-377r1 SAS-2 Broadcast (Zone Activate) (Tim Symons, PMC-Sierra)
- i) Corrected "To" columns for BROADCAST primitives
- j) Renamed Arb Reject (Bad Connection Rate) to Arb Reject (Connection Rate Not Supported)
- k) Added function response priorities for ENABLE DISABLE ZONING
- l) In DISCOVER LIST SHORT FORMAT descriptor, defined the PHY IDENTIFIER field as always valid (from Douglas Gilbert). In the SHORT FORMAT descriptor, defined what to do with the remaining fields if the FUNCTION RESULT field is PHY VACANT or PHY DOES NOT EXIST.
- m) Added definitions on UNKNOWN DESCRIPTOR TYPE (renamed from UNKNOWN DESCRIPTOR LIST) and UNKNOWN PHY FILTER for the DISCOVER LIST function
- n) Renamed PHY EVENT INFORMATION NOT SUPPORTED to UNKNOWN PHY EVENT INFORMATION to match other "not supported" function result names
- o) Changed IDENTIFY address frame FEATURES field from "shall be set to zero" to a table showing 0h as the only defined value and all others as reserved. This should help people realize that non-zero values must be checked and treated as an error.
- p) Added footnotes to tables containing values that are a multiple of OOB1 indicating the nominal times they represent.

R.11 Revision sas2r06 (22 September 2006)

Incorporated these changes per the September 2006 SAS protocol WG (06-414r0), SAS physical WG (06-432r0), and T10 plenary (06-417r0):

- a) 06-202r9 SAS-2 SMP CONFIGURE ZONE PERMISSION function (Tim Symons, PMC-Sierra)
- b) 06-263r6 SAS-2 Spread spectrum clocking (Rob Elliott, HP)
- c) 06-299r1 SAS-2 Clarifications of the SCSI power conditions in SAS (Chris Owens and Kevin Marks, Dell)
- d) 06-326r2 SAS-2 SMP zone lock timer (Tim Symons, PMC-Sierra)
- e) 06-358r5 SAS-2 Zone configuration model (Tim Symons, PMC-Sierra)
- f) 06-384r1 SAS-2 OPEN_REJECT RETRY during zoning changes (Rob Elliott, HP)

This page contains no comments

- g) 06-402r0 SAS-2 Changes to ATTACHED SATA DEVICE bit (Brian Day, LSI Logic)
- h) 06-405r0 SAS-2 Transport layer retries fix (George Penokie, IBM)
- i) 06-408r1 SAS-2 Race condition for transition out of SP12:SAS_Fail state (Bill Martin, Sierra Logic)
- j) 06-409r1 SAS-2 IDENTIFY address frame REASON field (Rob Elliott, HP)
- k) 06-418r1 SAS-2 ENABLE DISABLE ZONING revision (Tim Symons, PMC-Sierra)

R.12 Revision sas2r07 (15 November 2006)

Incorporated these changes per the November 2006 SAS protocol WG (06-485r0), SAS physical WG (06-501r0), and T10 plenary (06-488r0):

- a) 05-381r7 SAS-2 Multiplexing (Rob Elliott, HP). Moved the model section from chapter 7 (link layer) to chapter 6, since it's negotiated in the phy layer now. Split the model section into 2 parts, the multiplexing sequence described in the phy reset sequence section and multiplexing overall described at the 6.xx level. Assign MUX (LOGICAL LINK 0) to a different primitive encoding than proposed, since BREAK_REPLY has already been assigned that encoding. Made most of the states in SP_DWS sensitive to Incorrect Mux.
- b) 06-473r0 SAS-2 REPORT EXPANDER ROUTE TABLE descriptor layout change (Rob Elliott, HP)
- c) 06-474r1 SAS-2 Broadcast (Zone Activate) only by ZONED BROADCAST (Rob Elliott, HP)
- d) 06-463r3 SAS-2 OOB transmission requirements (Alvin Cox, Seagate)
- e) 06-464r0 SAS-2 COMWAKE detection requirements (Alvin Cox, Seagate)
- f) Fixed location of "within 1 ms" phrase in NOTIFY (POWER LOSS EXPECTED) section per 05-307r0.
- g) Editorial changes from 06-489r0 SAS-2 Target transport layer read DATA flowchart (George Penokie, IBM)

R.13 Revision sas2r08 (26 January 2007)

Incorporated these changes per the January 2007 SAS protocol WG (07-031r0), SAS physical WG (07-043r0), and T10 plenary (07-034r0):

- a) 06-515r0 SAS-2 Modifications to SAS Speed Negotiation (Steve Finch, ST Microelectronics and Amr Wassal, PMC-Sierra) [which was a continuation of 06-324 and 06-295]
- b) 06-188r3 SAS-2 Support multiple STP affiliations (Rob Elliott, HP)
- c) 06-275r0 SAS-2 ALIGN insertion rate during STP connections (Rob Elliott, HP)
- d) 06-322r4 SAS-2 Response to abandon-class OPEN_REJECT (Rob Elliott, HP)
- e) 06-451r6 SAS-2 SAM-4 Miscellaneous state machine fixes (George Penokie, IBM)
- f) 06-466r1 SAS-2 OPEN_REJECT RETRY during self-configuration changes (Rob Elliott, HP)
- g) 06-470r4 SAS-2 Transport layer read data flowchart (George Penokie, IBM)
- h) 06-471r1 SAS-2 Change to phy reset sequence 10ms rule (Brian Day, LSI Logic)
- i) Changed ISO/IEC number for ATA/ATAPI-7 from 14776 to 27439

R.14 Revision sas2r09 (22 March 2007)

Incorporated these changes per the March 2007 SAS protocol WG (07-114r0), CAP WG (07-116r0), SAS physical WG (07-140r0), and T10 plenary (07-117r0):

- a) 06-467r3 SAS-2 Initiator handling of retransmit read DATA frames (Bob Sheffield, Intel)
- b) 06-478r2 SAS-2 Changes to NEGOTIATED PHYSICAL LINK RATE (Brian Day, LSI Logic). Assigned NEGOTIATED PHYSICAL LINK RATE field value of 6h for UNSUPPORTED_PHY_ATTACHED.
- c) 07-008r8 SAS-2 Expander notification of temporary shutdown (George Penokie, IBM) with these exceptions:
 - A) Changed "reduced function" to "reduced functionality"
 - B) Changed the "time to reduced function timer" to "reduced functionality delay" timer
 - C) In the OPEN_REJECT (RETRY) definition, added "c) an expander device in the pathway has reduced functionality (see 4.6.8)"
 - D) In the ECM Arb Reject confirmation rules, added "Arb Reject (Retry) if the expander device is unable to process the connection request because it has reduced functionality (see 4.6.8)"
- d) 07-027r2 SAS-2 Enabling and disabling Transport Layer Retries (Chris Martin and Rob Elliott, HP)
- e) 07-028r1 SAS-2 Remove address resolved zoning (Tim Symons, PMC-Sierra)
- f) 07-058r3 SAS-2 OOB and SSC (Steve Finch, STMicroelectronics)
- g) 07-059r1 SAS-2 Update SATA references to Serial ATA 2.6 (Rob Elliott, HP)
- h) 07-066r1 SAM-4 SAS-2 QUERY TASK SET task management function (Rob Elliott, HP)

This page contains no comments

- i) 07-076r1 SAM-4 SAS-2 QUERY UNIT ATTENTION task management function (Rob Elliott, HP)
- j) 07-082r1 SAS-2 Fix target device name PIV bit (Rob Elliott, HP)
- k) 07-083r0 SAS-2 Mini SAS 4i to SAS 4i cable assemblies with SGPIO (Barry Olawsky and Rob Elliott, HP)
- l) 07-084r1 SAS-2 Add ATTACHED REASON field (Rob Elliott, HP)
- m) 07-085r0 SAS-2 Change mode page subpage names (Rob Elliott, HP)
- n) 07-087r1 SAS-2 SES-2 Enclosure Connector Information (Brad Besmer, LSI Logic)
- o) 07-108r1 SAS-2 Transport level read fixes (George Penokie, IBM) with these exceptions:
 - A) In ST_TTS3, applied the "Read Data Frames Transmitted/ACKed to zero" to both the "with a Retry argument" lists, not the "without a Retry argument" list.
 - B) In ST_TTS2, added "minus the Data-In Application Client Buffer Offset argument" in two more places where the Read Data Offset variable was being compared to the Data-In Request Byte Count argument.
 - C) In ST_TTS3, noted two places where "plus the Data-In Application Client Buffer Offset argument" still needs to be added.
- p) 07-121r1 SAS-2 Add REASON field to DISCOVER and DISCOVER LIST (Steve Johnson, LSI Logic)
- q) Eliminated use of the word "comprise"
- r) Clarified in the SNW-3 REQUESTED LOGICAL LINK RATE field that bit 4 is the MSB; bit 7 is the LSB. Corrected the parity bit value in the example with rate of 9h; added another example with rate of 8h which highlights the endianness.
- s) Corrected cross-references relating to RETRANSMIT bit set to one for XFER_RDY and RESPONSE frames in ST_TTS and for TASK frames in ST_ITS

R.15 Revision sas2r09a (23 April 2007)

Incorporated these changes per the April 2007 SAS protocol WG (07-183r0). The SAS physical WG (07-183r0) did not recommend anything. Proposals are not yet approved by a T10 plenary:

- a) 07-124r0 SAS-2 Remove Messages Between State Machines annex (Rob Elliott, HP)
- b) 07-128r0 SAS-2 Target handling of retransmitted write DATA frames (Bob Sheffield, Intel)
- c) 07-167r0 SAS-2 Add SNTT timer to SP27:SAS_Settings (Bob Sheffield, Intel)
- d) 07-154r1 SAS-2 ATTACHED SAS ADDRESS for virtual phys (Bob Sheffield, Intel)
- e) 07-176r1 SAS-2 SMP function result for incomplete descriptor lists (Rob Elliott, HP)
- f) 07-178r0 SAS-2 Connection request livelock avoidance (Rob Elliott, HP)
- g) 07-155r0 SAS-2 Add expander reduced functionality to REASON field (Rob Elliott, HP)

R.16 Revision sas2r10 (15 May 2007)

Incorporated these changes per the May 2007 SAS protocol WG (07-210r0), SAS physical WG (07-243r0), and T10 plenary (07-213r0):

- a) 06-373r3 SAS-2 Zone manager key (Rob Elliott, HP). Assigned CONFIGURE ZONE MANAGER PASSWORD to function code 89h.
- b) 06-476r2 SAS-2 WWN-based Attached Device Name for SATA (Rob Elliott, HP)
- c) 07-017r2 SAS-2 SAS-2 More zone groups (Steve Johnson, LSI Logic)
- d) 07-094r2 SAS-2 UML changes for logical phys (George Penokie, IBM)
- e) 07-166r2 SAS-2 Clarify scope of retransmitted XFER_RDY (Bob Sheffield, Intel)
- f) 07-177r2 SAS-2 Port layer wide port ordering (Rob Elliott, HP)
- g) 07-209r0 SAS-2 Mini SAS 4x cable plug pull tab color (Rob Elliott, HP and Jay Neer, Molex)
- h) 07-228r0 SAS-2 ResetStatus port selector fixes (Brian Day, LSI)
- i) 07-233r0 SAS-2 Function result for 256 zone support (Tim Symons, PMC-Sierra). Renamed the value ZONE GROUP OUT OF RANGE and let the result continue to be applied to the CONFIGURE ZONE PHY INFORMATION function if the ZONE GROUP field is too large.
- j) Changed some uses of "detected" to "received"
- k) Corrected DJ CR 3 Gbps footnote to point to the measurement bandwidth of 1 800 kHz to 1 500 MHz, which was correct in sas-r05 but broken in SAS-1.1 when the table cells were rearranged.
- l) In class and object diagrams, changed class and attribute names to mixed cases to parallel a change planned for SAM-4 revision 11.
- m) In class and object diagrams, shaded class name cells tan and object name cells blue; removed any shading from attribute and operation cells.

Author: hpq-relliott
Subject: Highlight
Date: 5/6/2008 4:07:47 PM
ACCEPT - DONE

07-076r1
s/b
07-067r1

- n) Added some multiplexing examples to the “Multiple connections on wide ports” figure
- o) Deleted “and in the SMP DISCOVER LIST response” from numerous places. It was not mentioned everywhere that DISCOVER was mentioned, so rather than imply different behavior with inconsistency, just removed the phrase.
- p) Define that the link layer SSP transmitter and the SMP transmitter are responsibly for inserting the CRC at the end of the frame (not the port layer or transport layer).
- q) Added the SMP Port class to the “State machines and Expander Device classes” class diagram with Port Layer and Transport Layer classes underneath it, paralleling the Port class diagram

R.17 Revision sas2r11 (23 July 2007)

Incorporated these changes per the July 2007 SAS protocol WG (07-313r0), SAS physical WG (07-338r0), CAP WG (07-315r0), and T10 plenary (07-316r0):

- a) 07-039r4 SAS-2 Self-Configuration Status Updates (Tyson Hartshorn and Stephen Johnson, LSI)
- b) 07-075r5 SAS-2 SMP REPORT BROADCAST function (George Penokie, IBM). Assigned function number 06h, since 05h is already taken.
- c) 07-091r3 SAS-2 SMP DISCOVER support for SNW-3 phy capabilities (Rob Elliott, HP). Placed the NEGOTIATED SSC bit in the DISCOVER response in byte 95, since byte 94 bit 4 is now taken by the REASON field.
- d) 07-102r3 SAS-2 Changes to Report Phy Event logging and reporting (Tyson Hartshorn, LSI). Assigned DISCOVER LIST to 20h, REPORT PHY EVENT INFORMATION LIST to 21h, and REPORT SELF-CONFIGURATION STATUS LIST to 22h.
- e) 07-130r4 SAS-2 CRC fixes (Luben Tuikov, Vitesse). Addressed preliminary letter ballot comments.
- f) 07-153r1 SAS-2 SPC-4 Protocol-Specific VPD pages (Rob Elliott, HP)
- g) 07-214r1 SAS-2 Mode and log page support for SNW-3 phy capabilities (Rob Elliott, HP)
- h) 07-277r0 SAS-2 SMP PHY CONTROL and affiliations (Rob Elliott, HP). Assigned AFFILIATION VIOLATION to 1Ah rather than 1Bh, since 07-287 deletes the assignment of 1Ah to LOGICAL LINK RATE NOT SUPPORTED.
- i) 07-280r1 SAS-2 SMP DISCOVER virtual phy clarifications (Rob Elliott, HP)
- j) 07-284r0 SAS-2 OPEN_REJECT_ZONE VIOLATION priority (Rob Elliott, HP)
- k) 07-285r0 SAS-2 STP bus inactivity time limit clarification (Rob Elliott, HP)
- l) 07-287r0 SAS-2 SMP function result tweaks (Rob Elliott, HP)
- m) 07-288r0 SAS-2 TARGET PORT TRANSFER TAG ST_T state machine fix (Brian Day, LSI)
- n) 07-293r0 SAS-2 Zoning interaction with enclosure services (Rob Elliott, HP)
- o) 07-297r1 SAS-2 CJTPAT usage (Rob Elliott, HP)
- p) 07-300r1 SAS-2 Configurable expander table-to-table error handling (Rob Elliott, HP)
- q) 07-306r1 SAS-2 Route table discovery process (Tim Symons, PMC-Sierra)
- r) 07-307r1 SAS-2 Zone group valid bit (Tim Symons, PMC-Sierra)
- s) 07-311r1 SAS-2 More Transport Layer Retries Fixes (George Penokie, IBM)
- t) 07-312r2 SAS-2 Zone route table entries for subtractive ports (Tim Symons, PMC-Sierra). Merged the sentiments of the last proposed paragraph into item b).
- u) Corrected maximum COMMAND frame size from 284 to 280 bytes (Brian Day, LSI)
- v) Added NOTE in discover process section that old expander devices don't implement DISCOVER LIST.
- w) In the SAS phy transmitter SSC modulation table footnote on “None or downspreading”, fixed “attach to SAS” to “support being attached to SATA devices”, added the ppm range for SAS downspreading as an i.e., changed the SATA ppm range to not include +/- 350 ppm, and made other changes to try to address concerns from Doug Loree, Toshiba
- x) Fixed “hexadecimal” column for OPEN_REJECT

R.18 Revision sas2r12 (28 September 2007)

Incorporated these changes per the September 2007 SAS protocol WG (07-394r0) and T10 plenary (07-396r0):

- a) 07-317r2 SAS-2 Target transport layer write flowcharts (George Penokie, IBM)
- b) 07-334r2 SAS-2 Add minimum number of dwords after IDENTIFY frame (Gerry Houlder, Seagate)
- c) 07-388r1 SAS-2 Only issue BROADCAST (Change) for initial spinup hold (Brian Day, LSI)
- d) 07-401r0 SAS-2 SMP DISCOVER LIST field alignment (Brad Besmer, LSI)

This page contains no comments

- e) 07-305r3 SAS-2 Zone phy information clarifications (Rob Elliott, HP)
- f) In REPORT ZONE PERMISSION TABLE, renamed SOURCE INDEX DOES NOT EXIST to SOURCE ZONE GROUP DOES NOT EXIST and assigned it function result code 28h (missed while incorporating 06-203r6 into sas2r05b)
- g) Corrected last scrambler output in CJTPAT table (the one XORed with the CRC).
- h) Corrected header and CRC for CJTPAT with fixed content (the header with mostly zeros is not the desired output on the physical link)
- i) Redrew the CJTPAT scrambling figure to show the frame header and CRC not being pre-scrambled. Changed the column order in the tables to have pre-scrambled values on the left and physical link values on the right.
- j) In REPORT GENERAL response, changed the minimum increment rule for the EXPANDER CHANGE COUNT field from REPORT GENERAL responses to any SMP response frame containing an EXPANDER CHANGE COUNT field
- k) In REPORT GENERAL response, changed the note about wrapping to discuss 65 535 rather than 65 536 increments, since the field now wraps to 0001h rather than 0000h.
- l) In Arbitration status section, changed “transmitting” to “originating” in the rule about transmitting at least one AIP every 128 dwords. This does not apply to dwords that are being forwarded (e.g. after originating AIP (WAITING ON DEVICE)).
- m) In the phy event information source description of 05h elasticity buffer overflows, added “outside of phy reset sequences” (as is done in 01h and 02h). Elasticity buffer overflows might occur during Train-SNW (since it doesn’t send ALIGNs) but are irrelevant.
- n) In the list of reasons for a Service Response of SERVICE DELIVERY OR TARGET FAILURE for the Command Complete Received transport protocol service arguments, added “ or the ST_IFR state machine detects an error as described in 9.2.6.2.2.3 and 9.2.6.2.2.4” to cover additional cases where the initiator port reports the error on its own.
- o) Renamed “phy event information” to “phy event” throughout (inconsistent in sas2r11; the shorter name seems adequate). This affects function names REPORT PHY EVENT INFORMATION, REPORT PHY EVENT INFORMATION LIST, and CONFIGURE PHY EVENT INFORMATION and one function result name.

R.19 Revision sas2r13 (16 November 2007)

Incorporated these changes per the November 2007 SAS protocol WG (07-473r0), SAS physical WG (07-502r0), and T10 plenary (07-476r0):

- a) 07-304r3 SAS-2 Zero-length test load (Barry Olawsky, HP). Since this required drawing a new S_{DD21} graph, also redrew the TCTF test load graphs based on Excel plots of the real equations. Separated IT and CT graphs into separate figures since they have different curvatures.
- b) 07-090r3 SAS-2 Transmit IDENTIFY three times (Rob Elliott, HP)
- c) 07-392r2 SAS-2 Remove AWT reset on receipt of OPEN_REJECT (RETRY) (George Penokie, IBM)
- d) 07-482r1 SAS-2 PHY CHANGE COUNT increment due to zoning changes (Brad Besmer, LSI)
- e) 07-424r1 SAS-2 Initiator Side Transport layer write flowcharts (George Penokie, IBM)
- f) 07-103r3 SAS-2 Changes to Report Phy Broadcast Counts logging and retrieval method (Tyson Hartshorn, LSI)
- g) 07-480r0 SAS-2 More phy test patterns - TRAIN, TRAIN_DONE, and idle dwords (Rob Elliott, HP)
- h) Added more cross-references in the definitions section when using other defined terms
- i) Added subsections to the expander route table section to isolate phy-based and expander-based sentences
- j) Moved the paragraphs in 7.9.2 SAS initiator device rules (for handling the identification sequence) about Broadcast (Expander) handling into 4.6.8 Expander reduced functionality

R.20 Revision sas2r14 (28 January 2008)

Incorporated these changes per the January 2008 SAS protocol WG (08-059r0), SAS physical WG (08-072r0), and T10 plenary (08-062r0):

- a) 07-339r9 SAS-2 6 Gbps PHY specification (Alvin Cox, Seagate)
- b) 07-391r3 SAS-2 Limiting SAS target response to OPEN_REJECT (RETRY) (George Penokie). Put the REJECT TO OPEN LIMIT field in bytes 8-9 rather than 10-11. Put the STP REJECT TO OPEN LIMIT field in bytes 18-19 rather than 17-18 (unaligned).

This page contains no comments

- c) 07-397r3 SAS-2 Indeterminate response length to an SMP REPORT GENERAL function (George Penokie).
- d) 07-403r2 SAS-2 Add SMP REPORT GENERAL open response while configuring (Brad Besmer, LSI). Named the field OPEN REJECT RETRY SUPPORTED which fits better in the table.
- e) 07-443r1 SAS-2 Calibration of jitter measurement devices (Alvin Cox, Seagate and Chuck Hill, Alta Engineering)
- f) 07-471r3 SAS-2 Proposed cable tables (Greg McSorley, Amphenol)
- g) 07-479r2 SAS-2 Phy test pattern transmitter controls (Rob Elliott, HP)
- h) 07-484r2 SAS-2 Interconnect Signal-to-Noise Ratio study (Barry Olawsky, HP)
- i) 07-486r3 SAS-2 Receiver Device physical testing (Kevin Witt and Mahbubul Bari, Maxim)
- j) 08-005r0 SAS-2 Mode page tweaks (Rob Elliott, HP). Also added the "minimum" wording to the STP SMP I_T NEXUS LOSS TIME field in the REPORT GENERAL/CONFIGURE GENERAL functions.
- k) 08-009r1 SAS-2 Elasticity buffer clarifications (Rob Elliott, HP)
- l) 08-010r1 SP State Machine - SL State Machine interaction issue (Bill Martin, Emulex)
- m) 08-011r0 SAS-2 XL Forward Dword correction (Rob Elliott, HP)
- n) 08-014r4 SAS-2 Remove restrictions for SSC (Gerry Houlder and Alvin Cox, Seagate)
- o) 08-032r4 SAS-2 Proposed modifications to SSC profile definition (Guillaume Fortin, PMC-Sierra)
- p) 08-040r0 SAS-2 SMP DISCOVER Self-Configuration Levels Completed (Brad Besmer, LSI)
- q) 08-041r1 Use period as decimal separator in T10 standards (Rob Elliott, HP)
- r) Corrected Protocol-Specific Logical Unit VPD page section (07-153r1, incorporated into sas2r11, mixed up the VPD page table with the logical unit information descriptor table).
- s) In various UML figures, changed 127 to 128 since the number represents a count (0=not present, 1..256 mean that many objects) not an identifier (e.g. phy identifier 0 through 127) (Dennis Moore, KnowledgeTek).
- t) Changed -3.8 dB to -3.7 dB in the low-loss TCTF equation for > 3 GHz to match the value of the equation for < 3 GHz with f=3 GHz.
- u) In SP8, deleted the "upon entry" verbage about sending Set Rate message of 1.5 Gbps or a SAS SNW Rate argument. This is handled by the next paragraphs dealing with the Current SNW state machine variable.

This revision is undergoing T10 letter ballot.

R.21 Pending changes

These physical layer proposals/changes are pending acceptance by the appropriate WG(s) and the T10 plenary:

- a) resolve letter ballot comments

This page contains no comments

Foreword (This foreword is not part of this standard)

This standard defines the Serial Attached SCSI (SAS) interconnect and three transport protocols that use the SAS interconnect:

- a) Serial SCSI Protocol (SSP): a mapping of SCSI supporting multiple initiators and targets;
- b) Serial ATA Tunneled Protocol (STP): a mapping of Serial ATA expanded to support multiple initiators and targets; and
- c) Serial Management Protocol (SMP): a management protocol.

Requests for interpretation, suggestions for improvement and addenda, or defect reports are welcome. They should be sent to the INCITS Secretariat, International Committee for Information Technology Standards, Information Technology Institute, 1250 Eye Street, NW, Suite 200, Washington, DC 20005-3922.

This standard was processed and approved for submittal to ANSI by the International Committee for Information Technology Standards (INCITS). Committee approval of the standard does not necessarily imply that all committee members voted for approval. At the time it approved this standard, INCITS had the following members:

INCITS Technical Committee T10 on Lower Level Interfaces, which developed and reviewed this standard, had the following members:

John B. Lohmeyer, Chair Mark S. Evans, Vice-Chair Ralph O. Weber, Secretary

This page contains no comments

Introduction

This standard defines the Serial Attached SCSI (SAS) interconnect and three transport protocols that use the SAS interconnect:

- a) Serial SCSI Protocol (SSP): a mapping of SCSI supporting multiple initiators and targets;
- b) Serial ATA Tunneled Protocol (STP): a mapping of Serial ATA expanded to support multiple initiators and targets; and
- c) Serial Management Protocol (SMP): a management protocol.

The standard is organized as follows:

Clause 1 (Scope) describes the relationship of this standard to the SCSI and ATA families of standards.

Clause 2 (Normative references) provides references to other standards and documents.

Clause 3 (Definitions, symbols, abbreviations, keywords, and conventions) defines terms and conventions used throughout this standard.

Clause 4 (General) describes architecture, names and identifiers, state machines, resets, I_T nexus loss, and provides an expander device model.

Clause 5 (Physical layer) describes the physical layer. It describes passive interconnect components (connectors, cables, and backplanes) and defines the transmitter and receiver electrical characteristics.

Clause 6 (Phy layer) describes the phy layer. It describes 8b10b encoding, bit order, out of band (OOB) signals, phy reset sequences, phy layer state machines, and spin-up.

Clause 7 (Link layer) describes the link layer. It describes primitives, physical link rate tolerance management, idle physical links, CRC, scrambling, address frames, the identification sequence and its state machine, power management, SAS domain changes, connections, rate matching, and SSP, STP, and SMP connection rules and link layer state machines.

Clause 8 (Port layer) describes the port layer, which sits between one or more link layers and one or more transport layers. It includes port layer state machines.

Clause 9 (Transport layer) describes the transport layer. It includes SSP, STP, and SMP frame definitions and transport layer state machines.

Clause 10 (Application layer) describes the application layer. It describes SCSI protocol services, mode parameters, log parameters, and power conditions, ATA specifics, and SMP functions.

Normative Annex A (Jitter tolerance patterns) describes the jitter tolerance patterns.

Normative Annex B (Signal performance measurements) describes signal measurement techniques.

Informative Annex C (SAS to SAS phy reset sequence examples) provides additional phy reset sequence examples.

Informative Annex D (CRC) provides information and example implementations of the CRC algorithm.

Informative Annex E (SAS address hashing) provides information and example implementations of the hashing algorithm.

Informative Annex F (Scrambling) provides information and example implementations of the scrambling algorithm.

Informative Annex G (ATA architectural notes) describes ATA architectural differences from Serial ATA and Serial ATA II.

Informative Annex H (Minimum deletable primitive insertion rate summary) describes the minimum ALIGN and/or NOTIFY insertion rates for physical link rate tolerance management and rate matching.

Informative Annex J (Expander device handling of connections) describes expander device behavior in a variety of connection examples.

Informative Annex K (Primitive encoding) lists the primitive encodings available for future versions of this standard.

Informative Annex L (Discover process example implementation) provides an example implementation of the discover process.

Informative Annex M (SAS icons) defines the SAS icons.

Page: il

● Author: wdc-mevans
Subject: Highlight
Date: 5/25/2008 4:36:51 PM

T REJECT
layer. It describes
s/b
layer, including definition of the

● Author: wdc-mevans
Subject: Cross-Out
Date: 5/25/2008 4:37:18 PM

~~**T**~~ ACCEPT - DONE
defines
[Delete this word.]

● Author: wdc-mevans
Subject: Highlight
Date: 5/25/2008 4:36:55 PM

T REJECT
layer. It describes
s/b
layer, including definition of the

● Author: wdc-mevans
Subject: Highlight
Date: 5/25/2008 4:36:59 PM

T REJECT
layer. It describes
s/b
layer, including definition of the

● Author: wdc-mevans
Subject: Highlight
Date: 5/25/2008 4:37:02 PM

T REJECT
layer. It describes
s/b
layer, including definition of the

● Author: wdc-mevans
Subject: Highlight
Date: 5/25/2008 4:37:07 PM

T REJECT
layer. It describes
s/b
layer, including definition of the

The following figure shows the organization of the layers of this standard.

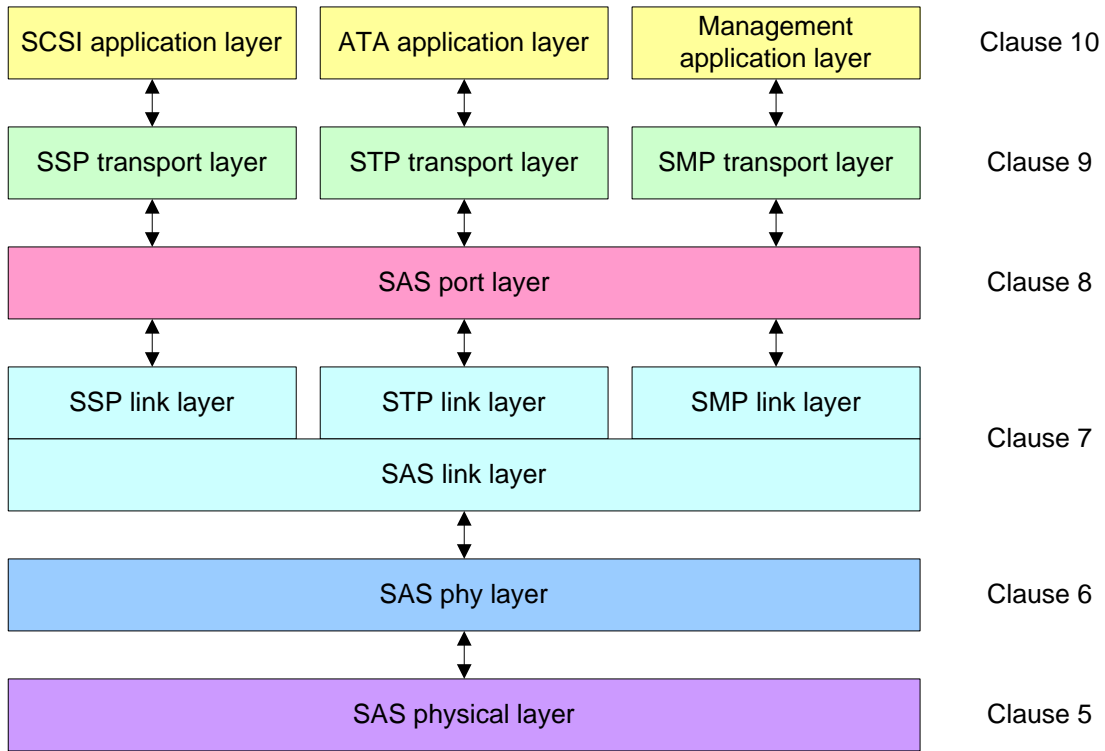

Organization of this standard

This page contains no comments

**American National Standard
for Information Technology -**

Serial Attached SCSI - 2 (SAS-2)

1 Scope

The SCSI family of standards provides for many different transport protocols that define the rules for exchanging information between different SCSI devices. This standard defines the rules for exchanging information between SCSI devices using a serial interconnect. Other SCSI transport protocol standards define the rules for exchanging information between SCSI devices using other interconnects.

Figure 1 shows the relationship of this standard to the other standards and related projects in the SCSI family of standards.

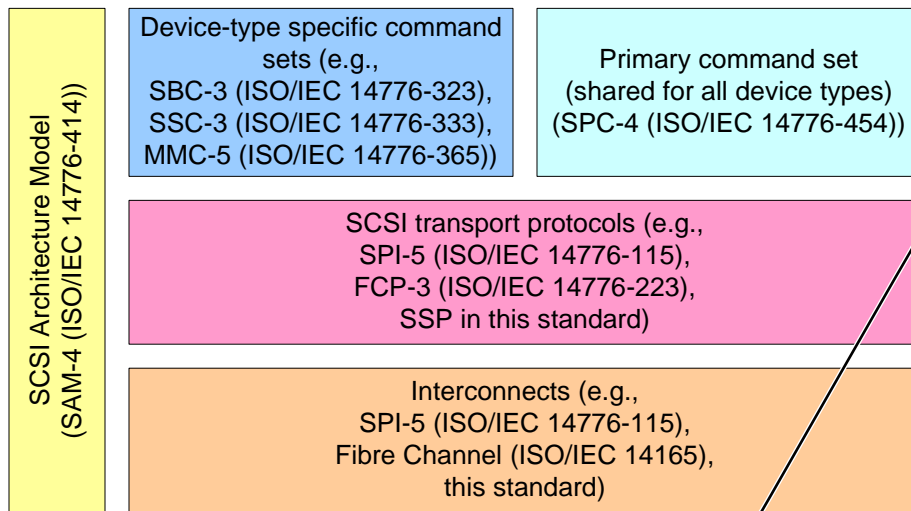

Figure 1 — SCSI document relationships

This standard also defines the rules for exchanging information between ATA hosts and ATA devices using the same serial interconnect. Other ATA transport protocol standards define the rules for exchanging information between ATA hosts and ATA devices using other interconnects.

Author: Isi-bbesmer

Subject: Highlight

Date: 5/25/2008 4:38:04 PM

T ACCEPT - DONE (split SBC into its own box, and added SAT-2 and ATA8-ACS above it. Also see Isi-bbesmer comment in 2.3)

Should SAT be included in this? SAT-2 Figure 3 indicates how SAT fits in overall.

Figure 2 shows the relationship of this standard to other standards and related projects in the ATA family of standards.

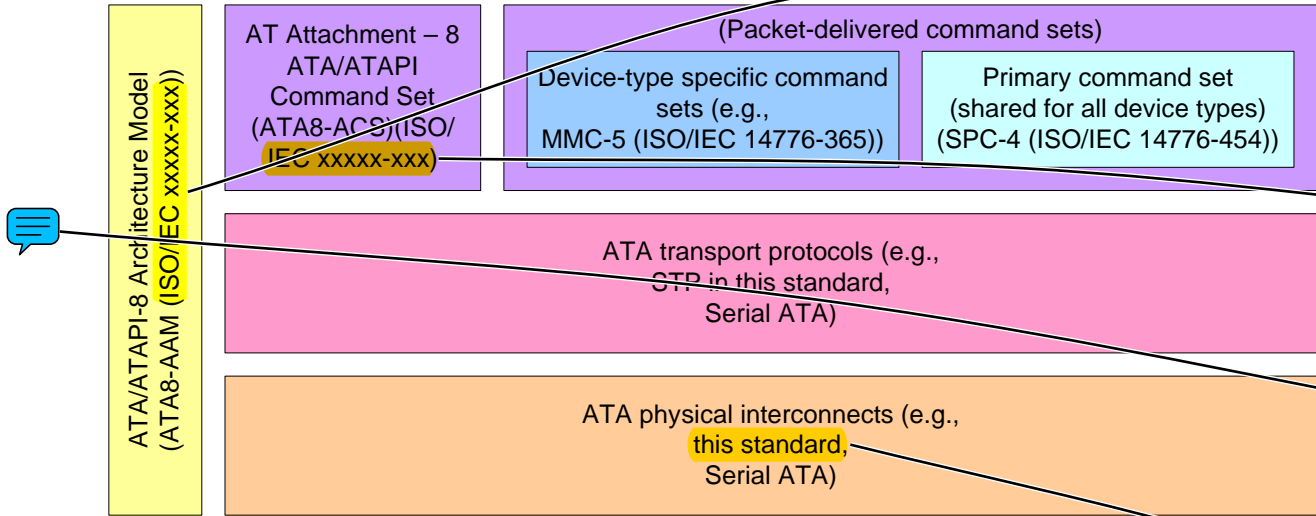



Figure 2 — ATA document relationships

Figure 1 and figure 2 show the general relationship of the documents to one another, and do not imply a relationship such as a hierarchy, protocol stack or system architecture.

These standards specify the interfaces, functions and operations necessary to ensure interoperability between conforming implementations. This standard is a functional description. Conforming implementations may employ any design technique that does not violate interoperability.

Page: 2

● Author: Isi-gpenokie
Subject: Highlight
Date: 6/30/2008 5:38:32 PM
 ACCEPT - DONE (Per June T13 meeting, ATA8-AAM will be 24739-100)

I don't think putting an unknown standard here is a good idea. It looks like a TBD. Either delete it or get a real number. ISO/IEC xxxxx-xxx

● Author: Isi-gpenokie
Subject: Highlight
Date: 6/30/2008 4:55:12 PM
 ACCEPT - DONE (Per June T13 meeting, ATA8-ACS will be 24739-200)

I don't think putting an unknown standard here is a good idea. It looks like a TBD. Either delete it or get a real number. IEC xxxxx-xxx

● Author: stx-goulder
Subject: Note
Date: 6/30/2008 5:38:57 PM
 ACCEPT - DONE (waiting on real number from T13 for AAM. Per June T13 meeting, ATA8-AAM will be 24739-100 and ATA8-ACS will be 24739-200)

ATA8-AAM and ATA8-ACS do not have correct ISO/IEC numbers.

● Author: elx-bmartin
Subject: Highlight
Date: 5/6/2008 4:07:47 PM
 REJECT (The SAS physical layer is the physical interconnect used for STP, which carries ATA.)

this standard

What part of this standard defines the ATA physical interconnect?

2 Normative references

2.1 Normative references

Referenced standards and specifications contain provisions that, by reference in the text, constitute provisions of this standard. At the time of publication, the editions indicated were valid. All standards are subject to revision, and parties to agreements based on this standard are encouraged to investigate the possibility of applying the most recent editions of the standards listed below.

Copies of the following documents may be obtained from ANSI:

- a) approved ANSI standards;
- b) approved and draft international and regional standards (e.g., ISO, IEC); and
- c) approved and draft foreign standards (e.g., JIS and DIN).

For further information, contact ANSI Customer Service Department at 212-642-4900 (phone), 212-302-1286 (fax) or via the World Wide Web at <http://www.ansi.org>.

Additional availability contact information is provided below as needed.

Table 1 shows standards bodies and their web sites.

Table 1 — Standards bodies

Abbreviation	Standards body	Web site
ANSI	American National Standards Institute	http://www.ansi.org
DIN	German Institute for Standardization	http://www.din.de
IEC	International Engineering Consortium	http://www.iec.ch
IEEE	Institute of Electrical and Electronics Engineers	http://www.ieee.org
INCITS	International Committee for Information Technology Standards	http://www.incits.org
ISO	International Standards Organization	http://www.iso.ch
ITI	Information Technology Industry Council	http://www.itic.org
JIS	Japanese Industrial Standards Committee	http://www.jisc.org
T10	INCITS T10 SCSI storage interfaces	http://www.t10.org
T11	INCITS T11 Fibre Channel interfaces	http://www.t11.org
T13	INCITS T13 ATA storage interface	http://www.t13.org

2.2 Approved references

At the time of publication, the following referenced standards or technical reports were approved:

ANSI INCITS TR-35-2004, *Methodologies for Jitter and Signal Quality Specification (MJSQ)*. When MJSQ is referenced from this standard, the FC Port terminology used within MJSQ should be substituted with SAS phy terminology.

2.3 References under development

At the time of publication, the following referenced standards were still under development. For information on the current status of the document, or regarding availability, contact the relevant standards body or other organization as indicated.

ISO/IEC xxxxx-xxx, *ATA Attachment-8 ATA/ATAPI Architecture Model (ATA8-AAM)* (T13/1700-D)

ISO/IEC xxxxx-xxx, *ATA Attachment-8 ATA/ATAPI Command Set (ATA8-ACS)* (T13/1699-D)

Page: 3

● Author: Isi-bday
Subject: Highlight
Date: 5/6/2008 4:07:47 PM

T REJECT (SATA IO is an industry consortium, not an accredited standards body. That's why references to it go in the "Other references" section, not the "Normative references" section. Thus, it doesn't fit in this list as currently worded.)

Should this table include the SATA IO organization?

● Author: RElliott
Subject: Note
Date: 9/3/2008 12:02:49 PM

 ACCEPT - DONE (as notes under table 1)

Need to add some (R) symbols and a section listing which terms are registered trademarks

ANSI is a registered trademark of American National Standards Institute
ISO is a registered trademark of the International Organization for Standardization
IEC is a registered trademark of the International Electrotechnical Commission.
IEEE is a registered trademark of the Institute of Electrical Electronics Engineers, Inc.

Don't add:

Unified Modeling Language is an unregistered trademark of OMG. See http://www.omg.org/legal/tm_list.htm. They'd like to see a TM used.

INCITS is an unregistered service mark (incits.org uses the unofficial SM label).

● Author: RElliott
Subject: Highlight
Date: 9/3/2008 11:26:59 AM

T ACCEPT - DONE

International Engineering Consortium
s/b
International Electrotechnical Commission

● Author: RElliott
Subject: Highlight
Date: 9/3/2008 11:27:10 AM

T ACCEPT - DONE

International Standards Organization
s/b
International Organization for Standardization

● Author: RElliott
Subject: Highlight
Date: 9/3/2008 11:27:28 AM

T ACCEPT - DONE

<http://www.jisc.org>
s/b
<http://www.jisc.co.jp>

● Author: wdc-mevans
Subject: Highlight
Date: 5/6/2008 4:07:47 PM

Comments from page 3 continued on next page

2 Normative references

2.1 Normative references

Referenced standards and specifications contain provisions that, by reference in the text, constitute provisions of this standard. At the time of publication, the editions indicated were valid. All standards are subject to revision, and parties to agreements based on this standard are encouraged to investigate the possibility of applying the most recent editions of the standards listed below.

Copies of the following documents may be obtained from ANSI:

- a) approved ANSI standards;
- b) approved and draft international and regional standards (e.g., ISO, IEC); and
- c) approved and draft foreign standards (e.g., JIS and DIN).

For further information, contact ANSI Customer Service Department at 212-642-4900 (phone), 212-302-1286 (fax) or via the World Wide Web at <http://www.ansi.org>.

Additional availability contact information is provided below as needed.

Table 1 shows standards bodies and their web sites.

Table 1 — Standards bodies

Abbreviation	Standards body	Web site
ANSI	American National Standards Institute	http://www.ansi.org
DIN	German Institute for Standardization	http://www.din.de
IEC	International Engineering Consortium	http://www.iec.ch
IEEE	Institute of Electrical and Electronics Engineers	http://www.ieee.org
INCITS	International Committee for Information Technology Standards	http://www.incits.org
ISO	International Standards Organization	http://www.iso.ch
ITI	Information Technology Industry Council	http://www.itic.org
JIS	Japanese Industrial Standards Committee	http://www.jisc.org
T10	INCITS T10 SCSI storage interfaces	http://www.t10.org
T11	INCITS T11 Fibre Channel interfaces	http://www.t11.org
T13	INCITS T13 ATA storage interface	http://www.t13.org

2.2 Approved references

At the time of publication, the following referenced standards or technical reports were approved:

ANSI INCITS TR-35-2004, *Methodologies for Jitter and Signal Quality Specification (MJSQ)*. When MJSQ is referenced from this standard, the FC Port terminology used within MJSQ should be substituted with SAS phy terminology.

2.3 References under development

At the time of publication, the following referenced standards were still under development. For information on the current status of the document, or regarding availability, contact the relevant standards body or other organization as indicated.

ISO/IEC xxxxx-xxx, *ATA Attachment-8 ATA/ATAPI Architecture Model (ATA8-AAM)* (T13/1700-D)

ISO/IEC xxxxx-xxx, *ATA Attachment-8 ATA/ATAPI Command Set (ATA8-ACS)* (T13/1699-D)

TREJECT (physical layer engineers have not complained).

the FC Port terminology used within MJSQ should be substituted with SAS phy terminology.

s/b

[There should be more about how to do this, at the very least a couple of "e.g."s would be helpful.]

● Author: stx-goulder

Subject: Highlight

Date: 6/30/2008 5:38:10 PM

TACCEPT - DONE (Per June T13 meeting, ATA8-AAM will be 24739-100)

xxxxx-xxx, This is incorrect ISO number.

● Author: lsi-gpenokie

Subject: Highlight

Date: 6/30/2008 5:38:15 PM

TACCEPT - DONE (Per June T13 meeting, ATA8-AAM will be 24739-100)

I don't think putting an unknown standard here is a good idea. It looks like a TBD. Either delete it or get a real number. ISO/IEC
xxxxx-xxx,

● Author: stx-goulder

Subject: Highlight

Date: 6/30/2008 4:55:37 PM

TACCEPT - DONE (Per June T13 meeting, ATA8-ACS will be 24739-200)

xxxxx-xxx This is incorrect ISO number.

● Author: lsi-gpenokie

Subject: Highlight

Date: 6/30/2008 4:55:31 PM

TACCEPT - DONE (Per June T13 meeting, ATA8-ACS will be 24739-200)

I don't think putting an unknown standard here is a good idea. It looks like a TBD. Either delete it or get a real number. ISO/IEC
xxxxx-xxx,

ISO/IEC 14776-414, *SCSI Architecture Model-4 (SAM-4)* (T10/1683-D)

ISO/IEC 14776-454, *SCSI Primary Commands-4 (SPC-4)* (T10/1731-D)

ISO/IEC 14776-323, *SCSI Block Commands-3 (SBC-3)* (T10/1799-D)

ISO/IEC 14776-372, *SCSI Enclosure Services-2 (SES-2)* (T10/1559-D)

NOTE 1 - For more information on the current status of these documents, contact the INCITS Secretariat at 202-737-8888 (phone), 202-638-4922 (fax) or via Email at incits@itic.org. To obtain copies of these documents, contact Global Engineering at 15 Inverness Way, East Englewood, CO 80112-5704 at 303-792-2181 (phone), 800-854-7179 (phone), or 303-792-2192 (fax) or see <http://www.incits.org>.

2.4 Other references

For information on the current status of the listed documents, or regarding availability, contact the indicated organization.

Serial ATA 2.6 (SATA-2): February 2007

NOTE 2 - For information on the current status of Serial ATA documents, see the Serial ATA International Organization at <http://www.sata-io.org>.

SFF-8086, *Compact Multilane Series: Common Elements*

SFF-8087, *Compact Multilane Series: Unshielded*

SFF-8088, *Compact Multilane Series: Shielded*

SFF-8223, *2.5" Drive Form Factor with Serial Connector*

SFF-8323, *3.5" Drive Form Factor with Serial Connector*

SFF-8523, *5.25" Drive Form Factor with Serial Connector*

SFF-8410, *HSS Copper Testing and Performance Requirements*

SFF-8416, *Measurement and Performance Requirements for HPEI Bulk Cable*

SFF-8460, *HSS Backplane Design Guidelines*

SFF-8470, *Shielded High Speed Multilane Copper Connector*

SFF-8482, *Unshielded Dual Port Serial Attachment Connector*

SFF-8484, *Multi-Lane Unshielded Serial Attachment Connectors*

SFF-8485, *Serial GPIO (SGPIO) Bus*

NOTE 3 - For more information on the current status of SFF document, contact the SFF Committee at 408-867-6630 (phone), or 408-867-2115 (fax). To obtain copies of these documents, contact the SFF Committee at 14426 Black Walnut Court, Saratoga, CA 95070 at 408-867-6630 (phone) or 408-741-1600 (fax) or see <http://www.sffcommittee.org>.

OMG *Unified Modeling Language (UML) Specification*. Version 1.5, March 2003.

NOTE 4 - For more information on the UML specification, contact the Object Modeling Group at <http://www.omg.org>.

PANTONE® Color Formula Guide

NOTE 5 - Pantone® and PANTONE MATCHING SYSTEM® are registered trademarks of Pantone, Inc. For more information on Pantone colors, contact Pantone, Inc. at <http://www.pantone.com>.

Page: 4

● Author: lsi-bbesmer
Subject: Highlight
Date: 5/25/2008 4:40:18 PM

T ACCEPT - DONE (only standards that are referenced go here; SAT is not currently referenced. Since almost all SAS initiators include a SATL, though, it should be. Added "ISO/IEC 14776-922, *SCSI/ATA Translation-2 (SAT-2) (T10/1826-D)*" here, added SAT-2 to figure 1 showing SCSI standards, and added "A SCSI to ATA translation layer (see SAT-2) may be implemented to enable SCSI application clients to communicate with ATA devices." in 4.1.5.)

Add SAT-2 to this list?

● Author: ktek-dmoore
Subject: Highlight
Date: 5/16/2008 1:00:20 PM

T ACCEPT - DONE (This is leftover from when SATA was multiple specifications - SATA-1, SATA-2 extensions, SATA port selector, etc. It also does help differentiate references to the SATA specification from SATA overall. However, that nuance seems unnecessary. Replaced "SATA-2" with "SATA" everywhere. Changed "defined by SATA (see SATA-2)" to "defined by SATA".)

SATA-2 s/b SATA rev 2.6 Global change. The SATA-IO organization says there is no such thing as SATA-2 and does not want the term used. Maybe a definition of "SATA" equals "Serial ATA 2.6" in this standard and make a global change of SATA-2 to SATA.

● Author: lsi-bday
Subject: Highlight
Date: 5/6/2008 4:07:47 PM

T ACCEPT - DONE (keeping the parenthetical term, which is needed for references)

Serial ATA 2.6 (SATA-2).
s/b
Serial ATA Revision 2.6.

● Author: RElliott
Subject: Note
Date: 7/17/2008 5:21:55 PM

 ACCEPT - DONE (7/15)

Add reference to SATA 3.0

● Author: RElliott
Subject: Note
Date: 9/3/2008 6:25:50 PM

 ACCEPT - DONE

Add reference for AWG:

ASTM Standard B 258-02, 2002, Standard specification for standard nominal diameters and cross-sectional areas of AWG sizes of solid round wires used as electrical conductors, ASTM International, West Conshohocken, PA, USA.

NOTE: For more information on ASTM International standards, see www.astm.org.

● Author: mxim-mbari
Subject: Note
Date: 6/6/2008 1:27:08 PM

 REJECT (not appropriate for this section. We can refer to web sites in the main body.)

Should StatEye (www.stateye.org) need to be added to the list of other references?

3 Definitions, symbols, abbreviations, keywords, and conventions

3.1 Definitions

3.1.1 8b10b coding: A coding scheme that represents an 8-bit byte (i.e., a control byte or data byte) as a 10-bit character (i.e., a control character or data character). See 6.2.

3.1.2 8b10b encoding: Encoding an 8-bit byte (i.e., a control byte or data byte) into a 10-bit character (i.e., a control character or data character). See 6.2.

3.1.3 10b8b decoding: Decoding a 10-bit character (i.e., a control character or data character) into an 8-bit byte (i.e., a control byte or data byte). See 6.2.

3.1.4 actual lock time (ALT): The time during Train-SNW at which a phy locks on received ALIGN (0)s and/or ALIGN (1)s and changes from transmitting ALIGN (0) to ALIGN (1) (see 6.7.4.2.3.4).

3.1.5 actual training time (ATT): The time during Train-SNW at which training (see 3.1.278) is complete (see 6.7.4.2.3.4).

3.1.6 active zone manager: The zone manager (see 3.1.301) that successfully locked a zoning expander device (see 3.1.305). See 4.9.6.

3.1.7 affiliation: The STP target port (see 3.1.267) state of limiting acceptance of connection requests to those from one or more STP initiator ports (see 3.1.262). See 7.17.4.

3.1.8 affiliation context: A set of ATA task file registers maintained by an STP target port for an STP initiator port holding an affiliation. See 7.17.4.

3.1.9 aggregation: When referring to classes (see 3.1.29), a form of association (see 3.1.11) that defines a whole-part relationship between the whole (i.e., aggregate) class (see 3.1.28) and its parts. See 3.5.

3.1.10 application client: An object that is the source of SCSI commands and task management function requests (see SAM-4), ATA commands (see ATA8-AAM), or management function requests. See 4.1.5.

3.1.11 association: When referring to classes (see 3.1.29), a relationship between two or more classes (see 3.1.28) that specifies connections among their objects (see 3.1.151) (i.e., a relationship that specifies that objects of one class are connected to objects of another class). See 3.5.

3.1.12 attached SAS address: The SAS address (see 3.1.196) of the attached phy (e.g., received by a logical phy in the incoming IDENTIFY address frame during the initialization sequence (see 4.1.2)), or the SAS address of the STP target port in an STP/SATA bridge (see 4.6.2).

3.1.13 attribute: When referring to classes (see 3.1.29) or objects (see 3.1.152), a named property of a class (see 3.1.28) that describes the range of values that its objects (see 3.1.151) may hold. See 3.5.

3.1.14 AT Attachment (ATA): A standard for the internal attachment of storage devices to hosts. See ATA8-AAM.

3.1.15 ATA device: A storage peripheral (analogous to a SCSI target device). See ATA8-AAM.

3.1.16 ATA domain: An I/O system consisting of an ATA host and one or more ATA devices that communicate with one another by means of a service delivery subsystem (see 3.1.233). See ATA8-AAM.

3.1.17 ATA host: A host device that originates requests to be processed by an ATA device (analogous to a SCSI initiator device). See ATA8-AAM.

Page: 5

Author: intc-mseidel

Subject: Highlight

Date: 9/4/2008 2:32:33 PM

T ACCEPT - DONE (added: The part of DJ (see 3.1.59) not aligned in time with the signal being measured. Specifically, BUJ excludes ISI (see 3.1.117) and duty cycle distortion. See MJSQ.

from 08-202r1 - made a definition rather than a footnote)

"jitter, bounded uncorrelated (BUJ)" should appear in the list of definitions.

Author: intc-mseidel

Subject: Highlight

Date: 5/16/2008 1:02:03 PM

T ACCEPT - DONE

The definition for ALT does not conform to that in Table 95. Table 95 is correct.

Author: lsi-bday

Subject: Highlight

Date: 5/6/2008 4:07:47 PM

T ACCEPT - DONE

Train-SNW

s/b

SNW-1, SNW-2, or Final-SNW

Author: lsi-bday

Subject: Highlight

Date: 5/6/2008 4:07:47 PM

T ACCEPT - DONE (and moved earlier in the sentence)

(see 6.7.4.2.3.4).

s/b

6.7.4.2.3.2

Author: elx-bmartin

Subject: Highlight

Date: 5/6/2008 4:07:47 PM

T ACCEPT - DONE (Moved this one earlier after "Train-SNW". The algorithm is: if the reference applies to the whole term, a new See x.y sentence is added. If the reference is for some of the words in the sentence, it goes in the sentence after those words.)

(see 6.7.4.2.3.4).

Make see references at the end of definitions consistent either (see x.y) or See x.y.

Author: elx-bmartin

Subject: Highlight

Date: 5/26/2008 6:55:00 PM

T REJECT (there's no context here to define which zoning expander device is "the" one. "a" is better for this section.)

a

s.b.

the

a implies any zoning expander, while this refers to the zone manager that locked the zoning expander device that is being referenced.

Author: wdc-mevans

Subject: Highlight

Date: 5/17/2008 1:44:43 PM

Comments from page 5 continued on next page

3 Definitions, symbols, abbreviations, keywords, and conventions

3.1 Definitions

3.1.1 8b10b coding: A coding scheme that represents an 8-bit byte (i.e., a control byte or data byte) as a 10-bit character (i.e., a control character or data character). See 6.2.

3.1.2 8b10b encoding: Encoding an 8-bit byte (i.e., a control byte or data byte) into a 10-bit character (i.e., a control character or data character). See 6.2.

3.1.3 10b8b decoding: Decoding a 10-bit character (i.e., a control character or data character) into an 8-bit byte (i.e., a control byte or data byte). See 6.2.

3.1.4 actual lock time (ALT): The time during Train-SNW at which a phy locks on received ALIGN (0)s and/or ALIGN (1)s and changes from transmitting ALIGN (0) to ALIGN (1) (see 6.7.4.2.3.4).

3.1.5 actual training time (ATT): The time during Train-SNW at which training (see 3.1.278) is complete (see 6.7.4.2.3.4).

3.1.6 active zone manager: The zone manager (see 3.1.301) that successfully locked a zoning expander device (see 3.1.305). See 4.9.6.

3.1.7 affiliation: The STP target port (see 3.1.267) state of limiting acceptance of connection requests to those from one or more STP initiator ports (see 3.1.262). See 7.17.4.

3.1.8 affiliation context: A set of ATA task file registers maintained by an STP target port for an STP initiator port holding an affiliation. See 7.17.4.

3.1.9 aggregation: When referring to classes (see 3.1.29), a form of association (see 3.1.11) that defines a whole-part relationship between the whole (i.e., aggregate) class (see 3.1.28) and its parts. See 3.5.

3.1.10 application client. An object that is the source of SCSI commands and task management function requests (see SAM-4), ATA commands (see ATA8-AAM), or management function requests. See 4.1.5.

3.1.11 association: When referring to classes (see 3.1.29), a relationship between two or more classes (see 3.1.28) that specifies connections among their objects (see 3.1.151) (i.e., a relationship that specifies that objects of one class are connected to objects of another class). See 3.5.

3.1.12 attached SAS address: The SAS address (see 3.1.196) of the attached phy (e.g., received by a logical phy in the incoming IDENTIFY address frame during the initialization sequence (see 4.1.2)), or the SAS address of the STP target port in an STP/SATA bridge (see 4.6.2).

3.1.13 attribute: When referring to classes (see 3.1.29) or objects (see 3.1.152), a named property of a class (see 3.1.28) that describes the range of values that its objects (see 3.1.151) may hold. See 3.5.

3.1.14 AT Attachment (ATA): A standard for the internal attachment of storage devices to hosts. See ATA8-AAM.

3.1.15 ATA device: A storage peripheral (analogous to a SCSI target device). See ATA8-AAM.

3.1.16 ATA domain: An I/O system consisting of an ATA host and one or more ATA devices that communicate with one another by means of a service delivery subsystem (see 3.1.233). See ATA8-AAM.

3.1.17 ATA host: A host device that originates requests to be processed by an ATA device (analogous to a SCSI initiator device). See ATA8-AAM.

T REJECT (a field is not an object that can be "maintained"; literally changing "task file register" to "field" doesn't work in most cases. SATA 2.6 uses the term "register" for many things, including the names of the Register - Host to Device and Register - Device to Host FISes. So, changing most instances of "task file" to plain "register". Rewording some of them to "affiliation context".)

task file registers
s/b
fields [this is how they are defined in ATA8-ACS]

Author: RElliott
Subject: Highlight
Date: 6/30/2008 6:16:52 PM

T ACCEPT - DONE

classes (see 3.1.29)
s/b
classes (see 3.1.28)
and delete the 3.1.28 reference later

3.1.29 refers to "class diagrams", which this definition used to refer to, but no longer does.

Author: Isi-gpenokie
Subject: Highlight
Date: 5/25/2008 5:14:24 PM

T REJECT (only including a cross-reference by "object" when it closely tied to UML. This could be generic English)

If you insist on all things be cross referenced then there needs to be one here . << An object that is >>

Author: Isi-gpenokie
Subject: Sticky Note
Date: 5/25/2008 5:31:19 PM

 REJECT (some judgement was applied to whether they are useful or not. For example, when referring to UML terms (which sound like standard English terms), the cross-references are often included.)

I have pointed out a few missing cross-references to other glossary entries. I question the benefits of adding in cross-references to within section 3.1.xx as is see on way to get them all. I recommend removing them all.

Author: RElliott
Subject: Highlight
Date: 6/30/2008 6:16:52 PM

T ACCEPT - DONE

classes (see 3.1.29)
s/b
classes (see 3.1.28)
and delete the 3.1.28 reference later

3.1.29 refers to "class diagrams", which this definition used to refer to, but no longer does.

Author: RElliott
Subject: Highlight
Date: 6/30/2008 6:16:52 PM

T ACCEPT - DONE

classes (see 3.1.29) or objects (see 3.1.152)
s/b
classes (see 3.1.28) or objects (see 3.1.151)

Author: elx-bmartin
Subject: Highlight

Comments from page 5 continued on next page

3 Definitions, symbols, abbreviations, keywords, and conventions

3.1 Definitions

3.1.1 8b10b coding: A coding scheme that represents an 8-bit byte (i.e., a control byte or data byte) as a 10-bit character (i.e., a control character or data character). See 6.2.

3.1.2 8b10b encoding: Encoding an 8-bit byte (i.e., a control byte or data byte) into a 10-bit character (i.e., a control character or data character). See 6.2.

3.1.3 10b8b decoding: Decoding a 10-bit character (i.e., a control character or data character) into an 8-bit byte (i.e., a control byte or data byte). See 6.2.

3.1.4 actual lock time (ALT): The time during Train-SNW at which a phy locks on received ALIGN (0)s and/or ALIGN (1)s and changes from transmitting ALIGN (0) to ALIGN (1) (see 6.7.4.2.3.4).

3.1.5 actual training time (ATT): The time during Train-SNW at which training (see 3.1.278) is complete (see 6.7.4.2.3.4).

3.1.6 active zone manager: The zone manager (see 3.1.301) that successfully locked a zoning expander device (see 3.1.305). See 4.9.6.

3.1.7 affiliation: The STP target port (see 3.1.267) state of limiting acceptance of connection requests to those from one or more STP initiator ports (see 3.1.262). See 7.17.4.

3.1.8 affiliation context: A set of ATA task file registers maintained by an STP target port for an STP initiator port holding an affiliation. See 7.17.4.

3.1.9 aggregation: When referring to classes (see 3.1.29), a form of association (see 3.1.11) that defines a whole-part relationship between the whole (i.e., aggregate) class (see 3.1.28) and its parts. See 3.5.

3.1.10 application client: An object that is the source of SCSI commands and task management function requests (see SAM-4), ATA commands (see ATA8-AAM), or management function requests. See 4.1.5.

3.1.11 association: When referring to classes (see 3.1.29), a relationship between two or more classes (see 3.1.28) that specifies connections among their objects (see 3.1.151) (i.e., a relationship that specifies that objects of one class are connected to objects of another class). See 3.5.

3.1.12 attached SAS address: The SAS address (see 3.1.196) of the attached phy (e.g., received by a logical phy in the incoming IDENTIFY address frame during the initialization sequence (see 4.1.2)), or the SAS address of the STP target port in an STP/SATA bridge (see 4.6.2).

3.1.13 attribute: When referring to classes (see 3.1.29) or objects (see 3.1.152), a named property of a class (see 3.1.28) that describes the range of values that its objects (see 3.1.151) may hold. See 3.5.

3.1.14 AT Attachment (ATA): A standard for the internal attachment of storage devices to hosts. See ATA8-AAM.

3.1.15 ATA device: A storage peripheral (analogous to a SCSI target device). See ATA8-AAM.

3.1.16 ATA domain: An I/O system consisting of an ATA host and one or more ATA devices that communicate with one another by means of a service delivery subsystem (see 3.1.233). See ATA8-AAM.

3.1.17 ATA host: A host device that originates requests to be processed by an ATA device (analogous to a SCSI initiator device). See ATA8-AAM.

Date: 5/25/2008 5:30:13 PM

 ACCEPT - DONE (from ATA8-AAM's definition of "device", added "that processes ATA commands and device management functions". ATA8-AAM defines "device", "ATA device", and "ATAPI" device; SAS is trying to use "ATA device" to mean ATA8-AAM's "device", since that definition conflicts with SCSI's definition of "device".)

A storage peripheral (analogous to a SCSI target device).

Clarify this as a storage device that processes requests originated by an ATA host.

Author: RElliott

Subject: Note

Date: 6/30/2008 6:16:52 PM

 ACCEPT - DONE

Add "Analogous to a SCSI domain."

3.1.18 baud rate: The signaling speed, expressed as the maximum number of times per second that the signal (see 3.1.234) may change the state of the physical link (see 3.1.164). Each state change produces a transition (i.e., signal edge). The baud rate is the reciprocal of the UI (i.e., $f_{\text{baud}} = 1 / \text{UI}$) (see 3.1.291).

3.1.19 big-endian: A format for storage or transmission of binary data in which the most significant byte appears first. In a multi-byte value, the byte containing the most significant bit is stored in the lowest memory address and transmitted first, and the byte containing the least significant bit is stored in the highest memory address and transmitted last (e.g., for the value 0080h, the byte containing 00h is stored in the lowest memory address, and the byte containing 80h is stored in the highest memory address).

3.1.20 bit cell time (BCT): The time for transmitting a phy capabilities bit during SNW-3 (see 6.7.4.2.3.3).

3.1.21 bit error ratio (BER): The number of logical bits output from a receiver circuit that differ from the correct transmitted logical bits, divided by the number of transmitted logical bits. The BER is usually expressed as a coefficient and a power of 10 (e.g., 2 erroneous bits out of 100 000 bits transmitted is expressed as 2 out of 10^5 or 2×10^{-5}). See MJSQ.

3.1.22 Broadcast: Information about an event in the SAS domain, communicated between phys with the BROADCAST primitive sequence (see 7.2.6.4) and/or the SMP ZONED BROADCAST function (see 10.4.3.20). See 4.1.13.

3.1.23 Broadcast propagation processor (BPP): An object within an expander function (see 3.1.78) that manages Broadcasts (see 3.1.22). See 4.6.5.

3.1.24 burst time: The part of an OOB signal (see 3.1.156) where the OOB burst (see 3.1.153) is transmitted. See 6.6.

3.1.25 byte: A sequence of eight contiguous bits considered as a unit. A byte is encoded as a character (see 3.1.27) using 8b10b coding (see 6.2).

3.1.26 cable assembly: Bulk cable plus a separable connector at each end plus any retention, backshell, or shielding features. See 5.2.4.

3.1.27 character: A sequence of ten contiguous bits considered as a unit. A byte (see 3.1.25) is encoded as a character using 8b10b coding (see 6.2).

3.1.28 class: A description of a set of objects (see 3.1.151) that share the same attributes (see 3.1.13), operations (see 3.1.157), relationships, and semantics. Classes may have attributes and may support operations.

3.1.29 class diagram: A diagram that shows a collection of classes (see 3.1.28) and their contents and relationships. See 3.5.

3.1.30 clock data recovery (CDR): The function provided by the receiver circuit responsible for producing a regular clock signal (i.e., the recovered clock) from the received signal and for aligning the recovered clock to the symbols (i.e., bits) being transmitted with the signal. The CDR uses the recovered clock to recover the bits. See MJSQ.

3.1.31 command descriptor block (CDB): A structure used to communicate a command from a SCSI application client to a SCSI device server. See SAM-4.

3.1.32 common SSC transmit clock: An implementation that employs a single transmit clock for multiple transmitter devices and enables or disables SSC (see 5.3.8) on the transmit clock signal to all transmitter devices in common rather than allowing each transmitter device to independently control SSC.

3.1.33 compliance point: An interoperability point where interoperability specifications are met. See 5.3.1.

Page: 6

● Author: wdc-mevans
Subject: Highlight
Date: 5/6/2008 4:07:47 PM

T REJECT (without the comma, could be interpreted as A that differ from (B divided by C). It needs to be interpreted as (A that differ from B) divided by C.)

bits, divided
s/b
bits divided

● Author: intc-mseidel
Subject: Highlight
Date: 5/25/2008 4:43:37 PM

T REJECT (that's how all such references are done; e.g. to SAM-4 or SPC-4 or SATA)

The directive "See MJSQ." is not well-defined in this context. It should point to a section number ("See MJSQ in 2.2."). There are other occurrences of this phrase in the standard.

● Author: wdc-mevans
Subject: Highlight
Date: 5/17/2008 1:47:47 PM

T REJECT

domain, communicated
s/b
domain communicated

● Author: lsi-gpenokie
Subject: Highlight
Date: 5/25/2008 5:14:31 PM

T REJECT (only including a cross-reference by "object" when it closely tied to UML. This could be generic English)

If you insist on all things be cross referenced then there needs to be one here . << An object within an >>

3.1.34 compliant jitter tolerance pattern (CJTPAT): A test pattern for jitter testing. See 5.3.5.5 and A.2.

3.1.35 configuration subprocess: A subprocess invoked from the discover process (see 3.1.62) to configure an externally configurable expander device (see 3.1.86). See 4.7.

3.1.36 confirmation: Information passed from a lower layer state machine to a higher layer state machine, usually responding to a request (see 3.1.187) from that higher layer state machine, and sometimes relaying a response (see 3.1.189) from a peer higher layer state machine. See 3.6.

3.1.37 connection: A temporary association between a SAS initiator port (see 3.1.201) and a SAS target port (see 3.1.207) using a pathway (see 3.1.159). See 7.12.

3.1.38 connection rate: The effective rate of dwords through the pathway (see 3.1.159) between a SAS initiator phy and a SAS target phy, established through the connection request.

3.1.39 connection request: A request to establish a connection originated by a SAS initiator port (see 3.1.201) or a SAS target port using an OPEN address frame (see 7.8.3). See 7.12.2.1.

3.1.40 connector: Electro-mechanical components consisting of a receptacle and a plug that provide a separable interface between two transmission segments. See 5.2.3.

3.1.41 constraint: When referring to classes (see 3.1.29) and objects (see 3.1.152), a mechanism for specifying semantics or conditions that are maintained as true between entities (e.g., a required condition between associations (see 3.1.11)). See 3.5.

3.1.42 control byte: A byte containing control information defined in table 84 (see 6.2).

3.1.43 control character (Kxx.y): A character containing control information defined in table 84 (see 6.2).

3.1.44 cumulative distribution function (CDF): The probability that jitter is less than a given value. See MJSQ.

3.1.45 cyclic redundancy check (CRC): An error checking mechanism that checks data integrity by computing a polynomial algorithm based checksum. See 7.5.

3.1.46 D.C. idle: A differential signal level that is nominally 0 V(P-P), used during the idle time (see 3.1.108) and negation time (see 3.1.147) of an OOB signal (see 3.1.156). See 5.3.6.

3.1.47 data byte: A byte containing data information defined in table 83 (see 6.2).

3.1.48 data character (Dxx.y): A character containing data information defined in table 83 (see 6.2).

3.1.49 data dword: A dword containing four data bytes, or four data characters with correct disparity.

3.1.50 deadlock: A condition in which two or more processes (e.g., connection requests) are waiting on the others to complete, resulting in none of the processes completing.

3.1.51 decibel (dB): One-tenth of the common logarithm (i.e., \log_{10}) of the ratio of relative powers.

NOTE 6 - The ratio of powers P_1 and P_2 in dB is $10 \times \log_{10}(P_1 / P_2)$. If $P_1 = V_1^2 / R_1$, $P_2 = V_2^2 / R_2$, and $R_1 = R_2$, then this ratio is equivalent to one-twentieth of the common logarithm of the relative voltage ratio (i.e., $\text{dB} = 20 \times \log_{10}(V_1 / V_2)$) (e.g., $20 \times \log_{10}(1) = 0 \text{ dB}$, $20 \times \log_{10}(0.5) = -6 \text{ dB}$).

3.1.52 dB millivolts (dBmV): The decibel ratio of an rms voltage value relative to 1 mV.

NOTE 7 - 20 mV(rms) is equal to $20 \times \log_{10}(20 \text{ mV} / 1 \text{ mV}) = 26 \text{ dBmV}$. This does not depend on the impedance level.

Page: 7

● Author: Isi-gpenokie
Subject: Highlight
Date: 5/26/2008 7:02:01 PM

T REJECT (this is describing how in an expander, a response from one phy gets converted into a confirmation by the outgoing phy - part of the 4 step request -> indication -> response -> confirmation process. Added "(e.g., see figure 42 in 4.6.6.1)" which might help)

I have no clue what this statement is trying to tell me << and sometimes relaying a response (see 3.1.189) from a peer higher layer state machine. >> and there is nothing in section 3.6 that would help. I suggest it be deleted.

● Author: wdc-mevans
Subject: Highlight
Date: 5/26/2008 7:02:24 PM

T REJECT (No other SCSI device is involved. This is describing how in an expander, a response from one phy gets converted into a confirmation by the outgoing phy - part of the 4 step request -> indication -> response -> confirmation process. Added "(e.g., see figure 42 in 4.6.6.1)" which might help)

from a peer higher layer state machine.

s/b

from a peer higher layer state machine in a different SCSI device.

● Author: RElliott
Subject: Underline
Date: 6/30/2008 6:16:52 PM

T ACCEPT - DONE

Remove cross-references from:

SAS initiator port (see 3.1.201) and a SAS target port (see 3.1.207)

● Author: Isi-gpenokie
Subject: Highlight
Date: 6/3/2008 5:17:38 PM

T REJECT (there are about 250 cross references now. It's not a good idea to blindly delete them all, as some of them were added upon request. It's not worth the effort to rejudge whether each one is individually better left in or out. References are usually included when it's an unusual term, or being used as a building block for another definition. In this case, the terms "SAS initiator phy" and "SAS target phy" are somewhat secondary in the definition, so I think it reads better without the references. The term "pathway" is referenced since it is strange; "dword" and "connection request" are not.)

If you insist on all things be cross referenced then there needs to be one here . <<SAS initiator phys >>

● Author: Isi-gpenokie
Subject: Highlight
Date: 6/3/2008 5:16:48 PM

T REJECT (see other comment on this sentence)

If you insist on all things be cross referenced then there needs to be one here . << SAS target phy >>

● Author: RElliott
Subject: Underline
Date: 6/30/2008 6:16:52 PM

T ACCEPT - DONE

SAS initiator port (see 3.1.201) or a SAS target port

s/b

SAS phy (see 3.1.200)

Initiator and target were mentioned separately to try to hint that expanders are different, but that's not really necessary. Phy should be used rather than port here, too.

Comments from page 7 continued on next page

3.1.34 compliant jitter tolerance pattern (CJTPAT): A test pattern for jitter testing. See 5.3.5.5 and A.2.

3.1.35 configuration subprocess: A subprocess invoked from the discover process (see 3.1.62) to configure an externally configurable expander device (see 3.1.86). See 4.7.

3.1.36 confirmation: Information passed from a lower layer state machine to a higher layer state machine, usually responding to a request (see 3.1.187) from that higher layer state machine, and sometimes relaying a response (see 3.1.189) from a peer higher layer state machine. See 3.6.

3.1.37 connection: A temporary association between a SAS initiator port (see 3.1.201) and a SAS target port (see 3.1.207) using a pathway (see 3.1.159). See 7.12.

3.1.38 connection rate: The effective rate of dwords through the pathway (see 3.1.159) between a SAS initiator phy and a SAS target phy, established through the connection request.

3.1.39 connection request: A request to establish a connection, originated by a SAS initiator port (see 3.1.201) or a SAS target port using an OPEN address frame (see 7.8.3). See 7.12.2.1.

3.1.40 connector: Electro-mechanical components consisting of a receptacle and a plug that provide a separable interface between two transmission segments. See 5.2.3.

3.1.41 constraint: When referring to classes (see 3.1.29) and objects (see 3.1.152), a mechanism for specifying semantics or conditions that are maintained as true between entities (e.g., a required condition between associations (see 3.1.11)). See 3.5.

3.1.42 control byte: A byte containing control information defined in table 84 (see 6.2).

3.1.43 control character (Kxx.y): A character containing control information defined in table 84 (see 6.2).

3.1.44 cumulative distribution function (CDF): The probability that jitter is less than a given value. See MJSQ.

3.1.45 cyclic redundancy check (CRC): An error checking mechanism that checks data integrity by computing a polynomial algorithm based checksum. See 7.5.

3.1.46 D.C. idle: A differential signal level that is nominally 0 V(P-P), used during the idle time (see 3.1.108) and negation time (see 3.1.147) of an OOB signal (see 3.1.156). See 5.3.6.

3.1.47 data byte: A byte containing data information defined in table 83 (see 6.2).

3.1.48 data character (Dxx.y): A character containing data information defined in table 83 (see 6.2).

3.1.49 data dword: A dword containing four data bytes, or four data characters with correct disparity.

3.1.50 deadlock: A condition in which two or more processes (e.g., connection requests) are waiting on the others to complete, resulting in none of the processes completing.

3.1.51 decibel (dB): One-tenth of the common logarithm (i.e., \log_{10}) of the ratio of relative powers.

NOTE 6 - The ratio of powers P_1 and P_2 in dB is $10 \times \log_{10}(P_1 / P_2)$. If $P_1 = V_1^2 / R_1$, $P_2 = V_2^2 / R_2$, and $R_1 = R_2$, then this ratio is equivalent to one-twentieth of the common logarithm of the relative voltage ratio (i.e., $\text{dB} = 20 \times \log_{10}(V_1 / V_2)$) (e.g., $20 \times \log_{10}(1) = 0 \text{ dB}$, $20 \times \log_{10}(0.5) = -6 \text{ dB}$).

3.1.52 dB millivolts (dBmV): The decibel ratio of an rms voltage value relative to 1 mV.

NOTE 7 - 20 mV(rms) is equal to $20 \times \log_{10}(20 \text{ mV} / 1 \text{ mV}) = 26 \text{ dBmV}$. This does not depend on the impedance level.

Author: RElliott
Subject: Highlight
Date: 6/30/2008 6:16:52 PM

 ACCEPT - DONE

frame(
s/b
frame (

Author: Isi-gpenokie
Subject: Highlight
Date: 5/25/2008 5:35:31 PM

 REJECT (but changed definition instead)

If you insist on all things be cross referenced then there needs to be one here .<< SAS target port >>

Author: RElliott
Subject: Highlight
Date: 6/30/2008 6:16:52 PM

 ACCEPT - DONE

classes (see 3.1.29) and objects (see 3.1.152)
s/b
classes (see 3.1.28) or objects (see 3.1.148)

Author: intc-mseidel
Subject: Highlight
Date: 5/6/2008 4:07:47 PM

 ACCEPT - DONE (keeping note 6 as a note. If definitions get too long, people complain. I don't want to create a whole section defining decibel, but do want to include the equations for power and voltage and some explanation of why 10 and 20 are used at different times, so a long note seems like a good compromise)

A dB is ten times the common log of the power ratio, not one-tenth. It also should incorporate Note 6.

Author: Isi-gpenokie
Subject: Highlight
Date: 5/6/2008 4:07:47 PM

 REJECT (This is mathematically wrong, and should be "Twenty times". Fixed it that way.)

This << one-twentieth >> should be expressed mathematically.

Author: RElliott
Subject: Note
Date: 6/30/2008 6:16:52 PM

 ACCEPT - DONE

List three example ratios: positive, negative, and 1.0.

Author: intc-mseidel
Subject: Highlight
Date: 5/6/2008 4:07:47 PM

 REJECT (see comment on dB)

Notes 7 and 8 should be incorporated into the definitions of dBmv and dBm.

3.1.53 dB milliWatts (dBm): The decibel ratio of a power value relative to 1 mW.

NOTE 8 - 20 mW is equal to $10 \times \log_{10}(20 \text{ mW} / 1 \text{ mW}) = 13 \text{ dBm}$. If power is measured with a 50 ohm impedance level, 20 mW is equivalent to $(0.02 \text{ W} \times 50 \text{ ohm})^{(1/2)} = 1 \text{ V}$ or 60 dBmV. If power is measured with a 25 ohm impedance level (i.e., the reference impedance for common mode measurements), 20 mW is equivalent to $(0.02 \text{ W} \times 25 \text{ ohm})^{(1/2)} = 0.707 \text{ V}$ or 57 dBmV.

3.1.54 decision feedback equalizer (DFE): A nonlinear equalizer that uses a feedback loop based on previously decoded symbols.

3.1.55 deletable primitive: An ALIGN (see 7.2.5.1), NOTIFY (see 7.2.5.3), or MUX (see 7.2.5.2), which may be deleted by a receiver instead of being placed into its elasticity buffer (see 7.3). See 7.2.5.

3.1.56 dependency: When referring to classes (see 3.1.29), a relationship between two classes (see 3.1.28) where a change to one class (i.e., the independent class) may cause a change in the other class (i.e., the dependent class). See 3.5.

3.1.57 device name: A worldwide unique name for a device within a transport protocol. See 4.2.4.

3.1.58 device server: An object that processes SCSI tasks (see SAM-4), ATA commands (see ATA8-AAM), or management functions. See 4.1.5.

3.1.59 direct current (D.C.): The non-A.C. component of a signal. In this standard, all frequency components below 100 kHz.

3.1.60 direct routing attribute: The attribute of an expander phy that indicates it may be used by the ECM (see 3.1.75) to route a connection request to an end device. See 4.6.7.1.

3.1.61 direct routing method: The method the ECM (see 3.1.75) uses to route connection requests to an attached end device or an attached expander device (see 3.1.77). See 4.6.7.1.

3.1.62 discover process: The process performed by a management application client to discover all the SAS devices (see 3.1.197) and expander devices (see 3.1.77) in the SAS domain (see 3.1.193) that invokes the configuration subprocess (see 3.1.35) as needed. See 4.7.

3.1.63 disparity: The difference between the number of ones and zeros in a character (see 6.2).

3.1.64 dispersion: Signal pulse broadening and distortion from all causes.

3.1.65 domain: A SAS domain (see 3.1.198), a SCSI domain (see 3.1.219), or an ATA domain (see 3.1.16).

3.1.66 dword: A sequence of four contiguous bytes or four contiguous characters considered as a unit. The meaning depends on the context (e.g., when discussing the bits being transmitted over a physical link, dword represents four characters (i.e., 40 bits). When discussing the contents of a frame after 10b8b decoding (see 3.1.3), dword represents four bytes (i.e., 32 bits)).

3.1.67 dword synchronization: Detection of an incoming stream of dwords from a physical link by a phy. See 6.9.

3.1.68 electromagnetic interference (EMI): Any electromagnetic disturbance that interrupts, obstructs, or otherwise degrades or limits the effective performance of electronics/electrical equipment.

3.1.69 enclosure: The box, rack, or set of boxes providing the powering, cooling, mechanical protection, EMI protection, and external electronic interfaces for one or more end device(s) (see 3.1.73) and/or expander device(s) (see 3.1.77). The enclosure provides the outermost electromagnetic boundary and acts as an EMI barrier. An enclosure is not a class (see 3.1.28) in this standard.

Page: 8

Author: RElliott
Subject: Highlight
Date: 6/30/2008 6:16:52 PM
T ACCEPT - DONE

milliWatts
s/b
milliwatts

per SI brochure

Author: elx-bmartin
Subject: Highlight
Date: 5/25/2008 4:45:33 PM
T REJECT (who else's could it be? There are no other nouns in the sentence that could be thought of as having a buffer.)

its
s.b.
the receiver's

Author: RElliott
Subject: Highlight
Date: 6/30/2008 6:16:52 PM
T ACCEPT - DONE

classes (see 3.1.29)
s/b
classes (see 3.1.28)

Author: RElliott
Subject: Highlight
Date: 6/30/2008 6:16:52 PM
T ACCEPT - DONE

it
s/b
that the expander phy

to match wdc-mevans comments on subtractive and table routing attributes

Author: RElliott
Subject: Underline
Date: 6/30/2008 6:16:52 PM
T ACCEPT - DONE

Delete crossreference in:
expander device (see 3.1.77).

Author: elx-bmartin
Subject: Highlight
Date: 5/25/2008 5:37:52 PM
T ACCEPT - DONE (moved the reference to the configuration subprocess into a new sentence instead)

The process performed by a management application client to discover all the SAS devices (see 3.1.197) and expander devices (see 3.1.77) in the SAS domain (see 3.1.198) that invokes the configuration subprocess (see 3.1.35) as needed. See 4.7.

add comas as shown

The process performed by a management application client, to discover all the SAS devices (see 3.1.197) and expander devices (see 3.1.77) in the SAS domain (see 3.1.198), that invokes the configuration subprocess (see 3.1.35) as needed. See 4.7.

Comments from page 8 continued on next page

3.1.53 dB milliWatts (dBm): The decibel ratio of a power value relative to 1 mW.

NOTE 8 - 20 mW is equal to $10 \times \log_{10}(20 \text{ mW} / 1 \text{ mW}) = 13 \text{ dBm}$. If power is measured with a 50 ohm impedance level, 20 mW is equivalent to $(0.02 \text{ W} \times 50 \text{ ohm})^{(1/2)} = 1 \text{ V}$ or 60 dBmV. If power is measured with a 25 ohm impedance level (i.e., the reference impedance for common mode measurements), 20 mW is equivalent to $(0.02 \text{ W} \times 25 \text{ ohm})^{(1/2)} = 0.707 \text{ V}$ or 57 dBmV.

3.1.54 decision feedback equalizer (DFE): A nonlinear equalizer that uses a feedback loop based on previously decoded symbols.

3.1.55 deletable primitive: An ALIGN (see 7.2.5.1), NOTIFY (see 7.2.5.3), or MUX (see 7.2.5.2), which may be deleted by a receiver instead of being placed into its elasticity buffer (see 7.3). See 7.2.5.

3.1.56 dependency: When referring to classes (see 3.1.29), a relationship between two classes (see 3.1.28) where a change to one class (i.e., the independent class) may cause a change in the other class (i.e., the dependent class). See 3.5.

3.1.57 device name: A worldwide unique name for a device within a transport protocol. See 4.2.4.

3.1.58 device server: An object that processes SCSI tasks (see SAM-4), ATA commands (see ATA8-AAM), or management functions. See 4.1.5.

3.1.59 direct current (D.C.): The non-A.C. component of a signal. In this standard, all frequency components below 100 kHz.

3.1.60 direct routing attribute: The attribute of an expander phy that indicates it may be used by the ECM (see 3.1.75) to route a connection request to an end device. See 4.6.7.1.

3.1.61 direct routing method: The method the ECM (see 3.1.75) uses to route connection requests to an attached end device or an attached expander device (see 3.1.77). See 4.6.7.1.

3.1.62 discover process: The process performed by a management application client to discover all the SAS devices (see 3.1.197) and expander devices (see 3.1.77) in the SAS domain (see 3.1.198) that invokes the configuration subprocess (see 3.1.35) as needed. See 4.7.

3.1.63 disparity: The difference between the number of ones and zeros in a character (see 6.2).

3.1.64 dispersion: Signal pulse broadening and distortion from all causes.

3.1.65 domain: A SAS domain (see 3.1.198), a SCSI domain (see 3.1.219), or an ATA domain (see 3.1.195).

3.1.66 dword: A sequence of four contiguous bytes or four contiguous characters considered as a unit. The meaning depends on the context (e.g., when discussing the bits being transmitted over a physical link, dword represents four characters (i.e., 40 bits). When discussing the contents of a frame after 10b8b decoding (see 3.1.3), dword represents four bytes (i.e., 32 bits)).

3.1.67 dword synchronization: Detection of an incoming stream of dwords from a physical link by a phy. See 6.9.

3.1.68 electromagnetic interference (EMI): Any electromagnetic disturbance that interrupts, obstructs, or otherwise degrades or limits the effective performance of electronics/electrical equipment.

3.1.69 enclosure: The box, rack, or set of boxes providing the powering, cooling, mechanical protection, EMI protection, and external electronic interfaces for one or more end device(s) (see 3.1.73) and/or expander device(s) (see 3.1.77). The enclosure provides the outermost electromagnetic boundary and acts as an EMI barrier. An enclosure is not a class (see 3.1.28) in this standard.

Author: RElliott

Subject: Note

Date: 6/30/2008 6:16:52 PM

 ACCEPT - DONE

In the discover process definition, delete crossreferences for SAS device, expander device, and SA domain

Author: lsi-bbesmer

Subject: Highlight

Date: 5/17/2008 1:52:44 PM

 ACCEPT - DONE ("before 8b10b encoding or after 10b8b decoding")

This implies dword is only on the receive path. Also applies prior to 8b10b encoding (ie. when transmitting a dword).

Author: lsi-gpenokie

Subject: Highlight

Date: 5/17/2008 1:55:18 PM

 REJECT (this directly from the ANSI ATIS glossary. See <http://www.atis.org/glossary/definition.aspx?id=7584>)

This << electronics/electrical equipment. >> should be << electronics or electrical equipment. >>

3.1.70 enclosure in port: A set of expander phys with subtractive routing attributes using the same external connector (see 5.2.3.3). See 4.6.2.

3.1.71 enclosure out port: A set of expander phys with table routing attributes in an expander device that does not support table-to-table attachment using the same external connector (see 5.2.3.3). See 4.6.2.

3.1.72 enclosure universal port: A set of expander phys with table routing attributes in an expander device that supports table-to-table attachment using the same external connector (see 5.2.3.3). See 4.6.2.

3.1.73 end device: A SAS device (see 3.1.197) or SATA device (see 3.1.210) that is not contained within an expander device (see 3.1.77).

3.1.74 event notification: Information passed from the transport layer to the application layer notifying the application layer that a SCSI event has occurred. See SAM-4.

3.1.75 expander connection manager (ECM): An object within an expander function (see 3.1.78) that manages routing. See 4.6.3.

3.1.76 expander connection router (ECR): The portion of an expander function (see 3.1.78) that routes messages between expander phys. See 4.6.4.

3.1.77 expander device: A device that is part of a service delivery subsystem (see 3.1.233), facilitates communication between SAS devices (see 3.1.197) and SATA devices (see 3.1.210), and is either an externally configurable expander device (see 3.1.86) or a self-configuring expander device (see 3.1.227). See 4.1.7.

3.1.78 expander function: An object within an expander device (see 3.1.77) that contains an expander connection manager (see 3.1.75), expander connection router (see 3.1.76), and Broadcast propagation processor (see 3.1.23). See 4.6.1.

3.1.79 expander logical phy: An expander phy (see 3.1.80) or a multiplexed portion of an expander phy. See 4.1.2.

3.1.80 expander phy: A phy in an expander device (see 3.1.77) that interfaces to a service delivery subsystem (see 3.1.233).

3.1.81 expander port: An expander device object that interfaces to a service delivery subsystem (see 3.1.233) and to SAS ports in other devices. See 4.6.2.

3.1.82 expander route entry: A SAS address and an enable/disable bit in an expander route table (see 3.1.84).

3.1.83 expander route index: A value used in combination with a phy identifier to select an expander route entry in an expander route table (see 3.1.84) in an externally configurable expander device (see 3.1.86). See 4.6.7.3.

3.1.84 expander route table: A table of expander route entries (see 3.1.82) within an expander device (see 3.1.77). The table is used by the expander function (see 3.1.78) to resolve connection requests. See 4.6.7.3.

3.1.85 external connector: A bulkhead connector (see 3.1.40), whose purpose is to carry signals into and out of an enclosure (see 3.1.69), that exits the enclosure with only minor compromise to the shield effectiveness of the enclosure (e.g., a SAS 4x receptacle or Mini SAS 4x receptacle). See 5.2.3.3.

3.1.86 externally configurable expander device: A non-self-configuring expander device (see 3.1.77) that contains an expander route table (see 3.1.84) that is configurable with the SMP CONFIGURE ROUTE INFORMATION function (see 10.4.3.27). See 4.1.7.

Page: 9

● Author: stx-goulder
Subject: Highlight
Date: 5/6/2008 4:07:48 PM
T ACCEPT - DONE

application layer
should be "SCSI application layer".

● Author: RElliott
Subject: Highlight
Date: 6/30/2008 6:16:52 PM
T ACCEPT - DONE

transport layer
s/b
SSP transport layer

● Author: RElliott
Subject: Highlight
Date: 6/30/2008 6:16:52 PM
T ACCEPT - DONE

application
s/b
SCSI application

● Author: stx-goulder
Subject: Highlight
Date: 5/6/2008 4:07:47 PM
T REJECT (Broadcast is capitalized everywhere, including when it is used as part of the name of an object.)

Broadcast -- why is this capitalized but none of the other objects within an expander are capitalized?

3.1.87 eye contour: The locus of points in a signal level versus time eye diagram where the CDF of 10^{-12} in the actual signal population exists. Comparison of the measured eye contour to the jitter eye mask determines whether a jitter eye mask violation has occurred. See 5.3.5 and MJSQ.

3.1.88 fall time: The time interval for the falling signal edge to transit between specified percentages of the signal amplitude. In this standard, the measurement points are the 80 % and 20 % voltage levels. Also see rise time (see 3.1.191).

3.1.89 fanout cable assembly: A cable assembly that attaches a wide connector on one end to multiple narrow connectors on the other end. See 5.2.4.1.3.

3.1.90 far-end crosstalk: Crosstalk that is propagated in a disturbed channel in the same direction as the propagation of a signal in the disturbing channel. The terminals of the disturbed channel, at which the far-end crosstalk is present, and the energized terminals of the disturbing channel are usually remote from each other.

3.1.91 field: A group of one or more contiguous bits.

3.1.92 frame: A sequence of data dwords between a start of frame primitive (i.e., SOF, SOAF, or SATA_SOF) and an end of frame primitive (i.e., EOF, EOAF, or SATA_EOF).

3.1.93 frame information structure (FIS): The SATA frame format. See SATA-2.

3.1.94 generalization: When referring to classes (see 3.1.29), a relationship among classes (see 3.1.28) where one class (i.e., the superclass) shares the attributes (see 3.1.13) and operations (see 3.1.157) of one or more other classes (i.e., the subclasses). See 3.5.

3.1.95 golden phase lock loop (golden PLL): A function that conforms to the jitter timing reference frequency response requirements in MJSQ that extracts the jitter timing reference from the data stream under test to be used as the timing reference for the instrument used for measuring the jitter in the signal under test. See MJSQ.

3.1.96 hard reset: A SAS device or expander device action in response to a reset event in which the device performs the operations described in 4.4.

3.1.97 hard reset sequence: A sequence that causes a hard reset (see 4.4).

3.1.98 hardware maximum physical link rate: The maximum physical link rate capability of a phy.

3.1.99 hardware minimum physical link rate: The minimum physical link rate capability of a phy.

3.1.100 hash function: A mathematical function that maps values from a larger set of values into a smaller set of values, reducing a long value into a shorter hashed value.

3.1.101 I_T nexus: When referring to SAS ports (see 3.1.204), a nexus between a SAS initiator port and a SAS target port. When referring to SCSI ports (see 3.1.222), a nexus between a SCSI initiator port and a SCSI target port. See SAM-4.

3.1.102 I_T nexus loss: When referring to SAS ports (see 3.1.204), a condition where a SAS port determines that another SAS port is no longer available. See 4.5. When referring to SCSI ports (see 3.1.222)(e.g., SSP ports), a condition resulting from the events defined by SAM-4 in which the SCSI device performs the I_T nexus loss operations described in SAM-4, SPC-4, and the appropriate command standards. See SAM-4.

3.1.103 I_T_L nexus: A nexus that exists between a SCSI initiator port, a SCSI target port, and a logical unit. This relationship extends the prior I_T nexus. See SAM-4.

Page: 10

Author: elx-bmartin
Subject: Highlight

Date: 6/3/2008 5:24:29 PM

T ACCEPT - DONE (changed to "with one connector on one end and multiple connectors on the other end", avoiding that term and providing a more accurate definition. A fanout cable assembly in SAS-2.1 could easily be 8x on one side to two 4x on the other side.)

wide connector

There is no definition of "wide connector" modify this reference to refer to multiple phys or something of that nature.

Author: elx-bmartin
Subject: Highlight

Date: 6/3/2008 5:24:44 PM

T ACCEPT - DONE (see previous response in this sentence)

narrow connectors

There is no definition of "narrow connector" modify this reference to refer to single phy or something of that nature.

Author: elx-bmartin
Subject: Highlight

Date: 5/6/2008 4:07:48 PM

T REJECT (fields can be 1 bit, and in some standards there are tables with "Field" headers that list both 1-bit and multi-bit fields. Not sure if SAS does that right now, but it should be able to.)

one
s.b.
two

We never refer to a one bit field, we always refer to that as a bit.

Author: intc-mseidel
Subject: Highlight

Date: 5/17/2008 1:56:10 PM

T ACCEPT - DONE (changed to "See SATA" to agree with other comments on SATA-2 references)

"SATA-2" is not defined in this standard, but is in the list of abbreviations. The pointer should be to a section number (2.4).
There may be other occurrences of this phrase in the standard.

Author: RElliott
Subject: Highlight

Date: 6/30/2008 6:16:52 PM

T ACCEPT - DONE

classes (see 3.1.29)
s/b
classes (see 3.1.28)

Author: wdc-mevans
Subject: Highlight

Date: 5/17/2008 1:58:07 PM

T REJECT (this is a generic definition. 4.2.5 and Annex E are very specific implementations of hashing)

value.
s/b
value (see Annex E).

Comments from page 10 continued on next page

3.1.87 eye contour: The locus of points in a signal level versus time eye diagram where the CDF of 10^{-12} in the actual signal population exists. Comparison of the measured eye contour to the jitter eye mask determines whether a jitter eye mask violation has occurred. See 5.3.5 and MJSQ.

3.1.88 fall time: The time interval for the falling signal edge to transit between specified percentages of the signal amplitude. In this standard, the measurement points are the 80 % and 20 % voltage levels. Also see rise time (see 3.1.191).

3.1.89 fanout cable assembly: A cable assembly that attaches a wide connector on one end to multiple narrow connectors on the other end. See 5.2.4.1.3.

3.1.90 far-end crosstalk: Crosstalk that is propagated in a disturbed channel in the same direction as the propagation of a signal in the disturbing channel. The terminals of the disturbed channel, at which the far-end crosstalk is present, and the energized terminals of the disturbing channel are usually remote from each other.

3.1.91 field: A group of one or more contiguous bits.

3.1.92 frame: A sequence of data dwords between a start of frame primitive (i.e., SOF, SOAF, or SATA_SOF) and an end of frame primitive (i.e., EOF, EOAF, or SATA_EOF).

3.1.93 frame information structure (FIS): The SATA frame format. See SATA-2.

3.1.94 generalization: When referring to classes (see 3.1.29), a relationship among classes (see 3.1.28) where one class (i.e., the superclass) shares the attributes (see 3.1.13) and operations (see 3.1.157) of one or more other classes (i.e., the subclasses). See 3.5.

3.1.95 golden phase lock loop (golden PLL): A function that conforms to the jitter timing reference frequency response requirements in MJSQ that extracts the jitter timing reference from the data stream under test to be used as the timing reference for the instrument used for measuring the jitter in the signal under test. See MJSQ.

3.1.96 hard reset: A SAS device or expander device action in response to a reset event in which the device performs the operations described in 4.4.

3.1.97 hard reset sequence: A sequence that causes a hard reset (see 4.4).

3.1.98 hardware maximum physical link rate: The maximum physical link rate capability of a phy.

3.1.99 hardware minimum physical link rate: The minimum physical link rate capability of a phy.

3.1.100 hash function: A mathematical function that maps values from a larger set of values into a smaller set of values, reducing a long value into a shorter hashed value.

3.1.101 I_T nexus: When referring to SAS ports (see 3.1.204), a nexus between a SAS initiator port and a SAS target port. When referring to SCSI ports (see 3.1.222), a nexus between a SCSI initiator port and a SCSI target port. See SAM-4.

3.1.102 I_T nexus loss: When referring to SAS ports (see 3.1.204), a condition where a SAS port determines that another SAS port is no longer available. See 4.5. When referring to SCSI ports (see 3.1.222)(e.g., SSP ports), a condition resulting from the events defined by SAM-4 in which the SCSI device performs the I_T nexus loss operations described in SAM-4, SPC-4, and the appropriate command standards. See SAM-4.

3.1.103 I_T_L nexus: A nexus that exists between a SCSI initiator port, a SCSI target port, and a logical unit. This relationship extends the prior I_T nexus. See SAM-4.

● Author: wdc-mevans
Subject: Cross-Out
Date: 5/25/2008 4:48:04 PM
~~T~~ ACCEPT - DONE

that exists

[Delete these words here or add them in the other nexus definitions.]

● Author: elx-bmartin
Subject: Cross-Out
Date: 5/17/2008 2:06:06 PM
~~T~~ ACCEPT - DONE (deleted whole sentence, which is no longer included in the SAM-4 definition of this term)

prior

This term is unnecessary and is confusing as I_T nexus is 2 definitions above this one.

3.1.104 I_T_L_Q nexus: A nexus between a SCSI initiator port, a SCSI target port, a logical unit, and a task. This relationship extends the ~~prior I_T nexus or I_T_L nexus~~. See SAM-4.

3.1.105 IDENTIFY (PACKET) DEVICE data: IDENTIFY DEVICE data from an ATA device, or IDENTIFY PACKET DEVICE data from an ATAPI device. See ATA8-ACS.

3.1.106 identification sequence: A sequence where phys exchange IDENTIFY address frames. See 7.9.

3.1.107 idle dword: A vendor-specific data dword that is scrambled and is transmitted outside a frame. See 7.4.

3.1.108 idle time: The part of an OOB signal (see 3.1.156) where D.C. idle (see 5.3.6) is being transmitted ~~interleaved with OOB burst (see 3.1.153)~~. See 6.6.

3.1.109 indication: Information passed from a lower layer state machine to a higher layer state machine, usually relaying a request (see 3.1.187) from a peer higher layer state machine. See 3.6.

3.1.110 information unit (IU): The portion of an SSP frame that carries command, task management function, data, response, or transfer ready information. See 9.2.2.

3.1.111 insertion loss: The ratio, usually expressed in dB, of incident power to delivered power. The dB magnitude of S_{12} or S_{21} is the negative of insertion loss in dB. See B.9.

3.1.112 intersymbol interference (ISI): Reduction in the distinction of a pulse caused by overlapping energy from neighboring pulses. Neighboring pulses are pulses that are close enough to have significant energy overlapping and does not imply or exclude adjacent pulses (i.e., many bit times may separate the pulses, especially in the case of reflections). ISI may result in DDJ and vertical eye closure. Several mechanisms produce ISI (e.g., dispersion, reflections, and circuits that lead to baseline wander). See MJSQ.

3.1.113 invalid character: A character that is not a control character (see 3.1.43) or a data character (see 3.1.48).

3.1.114 invalid dword: A dword that is not a data dword (see 3.1.49) or a primitive (see 3.1.172) (i.e., in the character context, a dword that contains an invalid character, a control character in other than the first character position, a control character other than K28.3 or K28.5 in the first character position, or one or more characters with a running disparity error).

3.1.115 jitter: The collection of instantaneous deviations of signal edge times at a defined signal level of the signal from the reference times (e.g., as defined by the jitter timing reference) for those events. See MJSQ.

3.1.116 jitter, data dependent (DDJ): Jitter that is added when the transmission pattern is changed from a clock-like to a non-clock-like pattern. See MJSQ.

3.1.117 jitter, deterministic (DJ): Jitter with non-Gaussian distribution. See MJSQ.

3.1.118 jitter, random, (RJ): Jitter that is characterized by a Gaussian distribution and is unbounded. See MJSQ.

3.1.119 jitter, sinusoidal (SJ): Single frequency jitter applied during signal tolerance testing. See MJSQ.

3.1.120 jitter, total (TJ): Jitter from all sources. See MJSQ.

3.1.121 jitter timing reference: The signal used as the basis for calculating the jitter in the signal under test. See MJSQ.

Page: 11

● Author: Isi-gpenokie
Subject: Highlight
Date: 5/6/2008 4:07:48 PM
T ACCEPT - DONE (global change)

The term << task >> in most cases should be changed to << command >>

● Author: elx-bmartin
Subject: Cross-Out
Date: 5/17/2008 2:06:21 PM
T ACCEPT - DONE (deleted whole sentence, which is no longer included in the SAM-4 definition of this term)

prior

This term is unnecessary and is confusing as to what is meant by prior. Prior in time or what?

● Author: wdc-mevans
Subject: Highlight
Date: 5/25/2008 4:48:30 PM
T REJECT (this is not two clauses logically ORed, this is joining two independent clauses)

device, or
s/b
device or

● Author: RElliott
Subject: Highlight
Date: 6/30/2008 6:16:52 PM
T ACCEPT - DONE

(see 5.3.6) is
should refer to the D.C. idle definition in 3.1.xx

● Author: wdc-mevans
Subject: Cross-Out
Date: 5/6/2008 4:07:48 PM
T ACCEPT - DONE

interleaved with OOB burst (see 3.1.153).
[Delete the unnecessary words.]

● Author: wdc-mevans
Subject: Highlight
Date: 5/26/2008 7:02:35 PM
T REJECT (this is describing how in an expander, a response from one phy gets converted into a confirmation by the outgoing phy - part of the 4 step request -> indication -> response -> confirmation process. Added "(e.g., see figure 42 in 4.6.6.1)" which might help)

from a peer higher layer state machine.
s/b
from a peer higher layer state machine in a different SCSI device.

● Author: stx-ghoulder
Subject: Highlight
Date: 5/6/2008 4:07:48 PM
T REJECT (the peer relationship is between the higher layer state machine on the initiator and on the target. The initiator application layer sends something using a request, the target application layer receives it in an indication.)

usually relaying a request (see 3.1.187) from a peer higher layer state machine.
-- the "peer higher layer" phrase totally loses me. If you are a lower level machine passing a message to a higher layer machine,

Comments from page 11 continued on next page

3.1.104 I_T_L_Q nexus: A nexus between a SCSI initiator port, a SCSI target port, a logical unit, and a task. This relationship extends the ~~prior~~ I_T nexus or I_T_L nexus. See SAM-4.

3.1.105 IDENTIFY (PACKET) DEVICE data: IDENTIFY DEVICE data from an ATA device, or IDENTIFY PACKET DEVICE data from an ATAPI device. See ATA8-ACS.

3.1.106 identification sequence: A sequence where phys exchange IDENTIFY address frames. See 7.9.

3.1.107 idle dword: A vendor-specific data dword that is scrambled and is transmitted outside a frame. See 7.4.

3.1.108 idle time: The part of an OOB signal (see 3.1.156) where D.C. idle (see 5.3.6) is being transmitted ~~interleaved with OOB burst (see 3.1.153)~~. See 6.6.

3.1.109 indication: Information passed from a lower layer state machine to a higher layer state machine, usually relaying a request (see 3.1.187) ~~from a peer higher layer state machine~~. See 3.6.

3.1.110 information unit (IU): The portion of an SSP frame that carries command, task management function, data, response, or transfer ready information. See 9.2.2.

3.1.111 insertion loss: The ratio, usually expressed in dB, of incident power to delivered power. The dB magnitude of S_{12} or S_{21} is the negative of insertion loss in dB. See B.9.

3.1.112 intersymbol interference (ISI): Reduction in the distinction of a pulse caused by overlapping energy from neighboring pulses. Neighboring pulses are pulses that are close enough to have significant energy overlapping and does not imply or exclude adjacent pulses (i.e., many bit times may separate the pulses, especially in the case of reflections). ISI may result in DDJ and vertical eye closure. Several mechanisms produce ISI (e.g., dispersion, reflections, and circuits that lead to baseline wander). See MJSQ.

3.1.113 invalid character: A character that is not a control character (see 3.1.43) or a data character (see 3.1.48).

3.1.114 invalid dword: A dword that is not a data dword (see 3.1.49) or a primitive (see 3.1.172) (i.e., in the character context, a dword that contains an invalid character, a control character in other than the first character position, a control character other than K28.3 or K28.5 in the first character position, or one or more characters with a running disparity error).

3.1.115 jitter: The collection of instantaneous deviations of signal edge times at a defined signal level of the signal from the reference times (e.g., as defined by the jitter timing reference) for these events. See MJSQ.

3.1.116 jitter, data dependent (DDJ): Jitter that is added when the transmission pattern is changed from a clock-like to a non-clock-like pattern. See MJSQ.

3.1.117 jitter, deterministic (DJ): Jitter with non-Gaussian distribution. See MJSQ.

3.1.118 jitter, random, (RJ): Jitter that is characterized by a Gaussian distribution and is unbounded. See MJSQ.

3.1.119 jitter, sinusoidal (SJ): Single frequency jitter applied during signal tolerance testing. See MJSQ.

3.1.120 jitter, total (TJ): Jitter from all sources. See MJSQ.

3.1.121 jitter timing reference: The signal used as the basis for calculating the jitter in the signal under test. See MJSQ.

how can there be a peer higher layer machine to the lower layer machine? I think this entire phrase should be deleted.

Author: RElliott
Subject: Cross-Out
Date: 7/17/2008 4:57:40 PM
 ACCEPT - DONE

Delete this unused acronym:
(IU)

Author: Isi-gpenokie
Subject: Highlight
Date: 5/6/2008 4:07:48 PM
 REJECT (the value defined by "insertion loss" is not required to be described in dB. The definition would be incorrect if it insisted on that. S-parameter files used by physical layer designers can be in 3 different formats, only one of which uses dB)

Is there any case in this standard when it is expressed in something other than dB? I think not so the << usually >> term should be deleted.

Author: Isi-gpenokie
Subject: Highlight
Date: 5/25/2008 4:49:44 PM
 ACCEPT - DONE

This should be << data dependent jitter >>

Author: elx-bmartin
Subject: Highlight
Date: 5/25/2008 4:49:12 PM
 ACCEPT - DONE

3.1.116 jitter, data dependent

Change 3.1.116 to 3.1.120 to be the proper name not "jitter, qualifier" (e.g., "data dependent jitter" not "jitter, data dependent").

Author: Isi-gpenokie
Subject: Highlight
Date: 5/6/2008 4:07:48 PM
 ACCEPT - DONE

This should be << deterministic jitter >>

Author: wdc-mevans
Subject: Highlight
Date: 5/6/2008 4:07:48 PM
 ACCEPT - DONE

random, (RJ):
s/b
random (RJ):

Author: Isi-gpenokie
Subject: Highlight
Date: 5/6/2008 4:07:48 PM
 ACCEPT - DONE

This should be << random jitter >> and the second , should be deleted.

Author: Isi-gpenokie
Subject: Sticky Note
Date: 5/6/2008 4:07:48 PM
 ACCEPT - DONE

If I'm going to the glossary to look for any of these types of jitter I would not look in the j's I would look in d, r, or s and not find it.

Author: Isi-gpenokie
Subject: Highlight

Comments from page 11 continued on next page

3.1.104 I_T_L_Q nexus: A nexus between a SCSI initiator port, a SCSI target port, a logical unit, and a task. This relationship extends the ~~prior~~ I_T nexus or I_T_L nexus. See SAM-4.

3.1.105 IDENTIFY (PACKET) DEVICE data: IDENTIFY DEVICE data from an ATA device, or IDENTIFY PACKET DEVICE data from an ATAPI device. See ATA8-ACS.

3.1.106 identification sequence: A sequence where phys exchange IDENTIFY address frames. See 7.9.

3.1.107 idle dword: A vendor-specific data dword that is scrambled and is transmitted outside a frame. See 7.4.

3.1.108 idle time: The part of an OOB signal (see 3.1.156) where D.C. idle (see 5.3.6) is being transmitted ~~interleaved with OOB burst (see 3.1.153)~~. See 6.6.

3.1.109 indication: Information passed from a lower layer state machine to a higher layer state machine, usually relaying a request (see 3.1.187) from a peer higher layer state machine. See 3.6.

3.1.110 information unit (IU): The portion of an SSP frame that carries command, task management function, data, response, or transfer ready information. See 9.2.2.

3.1.111 insertion loss: The ratio, usually expressed in dB, of incident power to delivered power. The dB magnitude of S_{12} or S_{21} is the negative of insertion loss in dB. See B.9.

3.1.112 intersymbol interference (ISI): Reduction in the distinction of a pulse caused by overlapping energy from neighboring pulses. Neighboring pulses are pulses that are close enough to have significant energy overlapping and does not imply or exclude adjacent pulses (i.e., many bit times may separate the pulses, especially in the case of reflections). ISI may result in DDJ and vertical eye closure. Several mechanisms produce ISI (e.g., dispersion, reflections, and circuits that lead to baseline wander). See MJSQ.

3.1.113 invalid character: A character that is not a control character (see 3.1.43) or a data character (see 3.1.48).

3.1.114 invalid dword: A dword that is not a data dword (see 3.1.49) or a primitive (see 3.1.172) (i.e., in the character context, a dword that contains an invalid character, a control character in other than the first character position, a control character other than K28.7 or K28.5 in the first character position, or one or more characters with a running disparity error).

3.1.115 jitter: The collection of instantaneous deviations of signal edge times at a defined signal level of the signal from the reference times (e.g., as defined by the jitter timing reference) for those events. See MJSQ.

3.1.116 jitter, data dependent (DDJ): Jitter that is added when the transmission pattern is changed from a clock-like to a non-clock-like pattern. See MJSQ.

3.1.117 jitter, deterministic (DJ): Jitter with non-Gaussian distribution. See MJSQ.

3.1.118 jitter, random, (RJ): Jitter that is characterized by a Gaussian distribution and is unbounded. See MJSQ.

3.1.119 jitter, sinusoidal (SJ): Single frequency jitter applied during signal tolerance testing. See MJSQ.

3.1.120 jitter, total (TJ): Jitter from all sources. See MJSQ.

3.1.121 jitter timing reference: The signal used as the basis for calculating the jitter in the signal under test. See MJSQ.

Date: 5/6/2008 4:07:48 PM

T ACCEPT - DONE

This should be << sinusoidal jitter >>

Author: lsi-gpenokie

Subject: Highlight

Date: 5/6/2008 4:07:48 PM

T ACCEPT - DONE

This should be << total jitter >>

3.1.122 jitter tolerance: The ability of the receiver device to recover transmitted bits in an incoming data stream in the presence of specified jitter in the signal applied to the receiver device compliance point. See MJSQ.

3.1.123 jitter tolerance pattern (JTPAT): A test pattern for jitter testing. See 5.3.5.5 and A.1.

3.1.124 least mean square (LMS): An algorithm for adaptively adjusting the tap coefficients of a DFE (see 3.1.54) based on the difference between the desired and actual signal.

3.1.125 least significant bit (LSB): In a binary code, the bit or bit position with the smallest numerical weighting in a group of bits that, when taken as a whole, represent a numerical value (e.g., in the number 0001b, the bit that is set to one).

3.1.126 link reset: Performing the link reset sequence (see 3.1.127).

3.1.127 link reset sequence: For SATA, a phy reset sequence (see 3.1.163). For SAS, a phy reset sequence followed by an identification sequence (see 3.1.106), or a phy reset sequence followed by a hard reset sequence (see 3.1.97), another phy reset sequence, and an identification sequence. See 4.4.

3.1.128 little-endian: A format for storage or transmission of binary data in which the least significant byte appears first. In a multi-byte value, the byte containing the least significant bit is stored in the lowest memory address and transmitted first, and the byte containing the most significant bit is stored in the highest memory address and transmitted last (e.g., for the value 0080h, the byte containing 80h is stored in the lowest memory address, and the byte containing 00h is stored in the highest memory address).

3.1.129 livelock: A condition where two or more processes (e.g., connection requests) continually change their state in response to changes in other processes, resulting in none of the processes completing.

3.1.130 locked zoning expander device: A zoning expander device (see 3.1.305) that has been locked by a zone manager (see 3.1.301). See 4.9.6.2.

3.1.131 logical link: A physical link (see 3.1.164) or a multiplexed portion of a physical link. See 4.1.3.

3.1.132 logical link rate: A link rate between two logical phys established as a result of speed negotiation and multiplexing negotiation between the physical phys containing those logical phys.

3.1.133 logical phy: A phy (see 3.1.161) or a multiplexed portion of a phy. See 4.1.2.

3.1.134 logical unit: An externally addressable entity within a SCSI target device that implements a SCSI device model and contains a device server. See SAM-4.

3.1.135 logical unit number (LUN): An identifier for a logical unit (see 3.1.134). See SAM-4.

3.1.136 maximum training time (MTT): The maximum time during Train-SNW for a phy receiver to complete training (see 3.1.278) (see 6.7.4.2.3.4).

3.1.137 maximum Train-SNW window time (MTWT): The maximum duration of Train-SNW (see 6.7.4.2.3.4).

3.1.138 media: Plural of medium (see 3.1.139).

3.1.139 medium: The material on which data is stored (e.g., a magnetic disk).

3.1.140 message: Information sent between state machines. See 3.6.

Author: elx-bmartin

Subject: Highlight

Date: 5/6/2008 4:07:48 PM

T ACCEPT - DONE (moved latter after "Train-SNW")

(see 3.1.278) (see 6.7.4.2.3.4).

do not put two parenthetical references next to each other.

3.1.141 most significant bit (MSB): In a binary code, the bit or bit position with the largest numerical weighting in a group of bits that, when taken as a whole, represent a numerical value (e.g., in the number 1000b, the bit that is set to one).

3.1.142 multiplexing: Dividing a physical link into two logical links, and dividing a phy into two logical phys, by interleaving dwords. See 6.10.

3.1.143 multiplicity: When referring to **classes (see 3.1.29)**, an indication of the range of allowable instances of an object (see 3.1.151) or an attribute (see 3.1.13). See 3.5.

3.1.144 narrow link: A physical link that attaches a narrow port to another narrow port. See 4.1.4.

3.1.145 narrow port: A port that contains exactly one phy. See 4.1.4.

3.1.146 near-end crosstalk (NEXT): Crosstalk that is propagated in a disturbed channel in the opposite direction as the propagation of a signal in the disturbing channel. The terminals of the disturbed channel, at which the near-end crosstalk is present, and the energized terminals of the disturbing channel are usually near each other.

3.1.147 negation time: The part of an OOB signal (see 3.1.156) during which D.C. idle (see 3.1.46) is transmitted after the last OOB burst (see 3.1.153). See 6.6.

3.1.148 negotiated logical link rate: The current operational logical link rate (see 3.1.132).

3.1.149 negotiated physical link rate: The current operational physical link rate (see 3.1.165).

3.1.150 nexus: When referring to SAS ports (see 3.1.204), a relationship between a SAS initiator port and a SAS target port. When referring to SCSI ports (see 3.1.222), a relationship between a SCSI initiator port and a SCSI target port that may extend to a logical unit and a task. See SAM-4.

3.1.151 object: An entity with a well-defined boundary and identity that encapsulates state and behavior. All objects are instances of classes (see 3.1.28)(i.e., a concrete manifestation of a class is an object).

3.1.152 object diagram: A diagram that encompasses objects and their relationships at a point in time. See 3.5.

3.1.153 OOB burst: The transmission of signal transitions for a burst time (see 3.1.24). See 6.6.1.

3.1.154 OOB interval: The time basis for burst times (see 3.1.24), idle times (see 3.1.108), negation times (see 3.1.147), and signal times (see 3.1.237) used to create OOB signals (see 3.1.156). See 6.6.1.

3.1.155 OOB sequence: A sequence where two phys exchange OOB signals (see 3.1.156). See 6.7.2.1 and 6.7.4.1.

3.1.156 OOB signal: A pattern of idle time (see 3.1.108), burst time (see 3.1.24), and negation time (see 3.1.147) used during the link reset sequence. See 6.6.

3.1.157 operation: When referring to **classes (see 3.1.29)**, a service that may be requested from any object (see 3.1.151) of the class (see 3.1.28) in order to effect behavior. Operations describe what a class is allowed to do and may be a request or a query. A request may change the state of the object but a query should not. See 3.5.

3.1.158 partial pathway: The set of logical links participating in a connection request that have not yet conveyed a connection response. See 4.1.11.

3.1.159 pathway: A set of logical links between a SAS initiator phy and a SAS target phy being used by a connection (see 3.1.37). See 4.1.11.

Author: RElliott
Subject: Highlight
Date: 6/30/2008 6:16:52 PM

T ACCEPT - DONE

classes (see 3.1.29)
s/b
classes (see 3.1.28)

Author: lsi-gpenokie
Subject: Highlight
Date: 5/17/2008 2:10:07 PM

T ACCEPT - DONE (rewritten based on sam4r14 definition: "When referring to SAS devices (see 3.1.195), a relationship between two SAS devices, and the SAS initiator port and the SAS target port objects within those SAS devices. When referring to SCSI devices (see 3.1.214), a relationship between two SCSI devices, and the SCSI initiator port and the SCSI target port objects within those SCSI devices. See SAM-4.")

This is not a good definition for nexus. How about << When referring to SAS devices, a relationship between SAS ports. When referring to SCSI devices, a relationship between a SCSI ports that may extend to a logical unit and a command.

Author: wdc-mevans
Subject: Highlight
Date: 5/6/2008 4:07:48 PM

T ACCEPT - DONE

Global
task
s/b
command
[as based on the most recent changes in SAM-4]

Author: RElliott
Subject: Highlight
Date: 6/30/2008 6:16:52 PM

T ACCEPT - DONE

classes (see 3.1.29)
s/b
classes (see 3.1.28)

3.1.160 pathway blocked count: The number of times the port has retried this connection request due to receiving OPEN_REJECT (PATHWAY BLOCKED), OPEN_REJECT (RESERVED STOP 0), or OPEN_REJECT (RESERVED STOP 1).

3.1.161 phy: A object in a device that is used to interface to other devices (e.g., an expander phy (see 3.1.80) or a SAS phy (see 3.1.202)). See 4.1.2.

3.1.162 phy identifier: The value by which a phy is identified within a device. See 4.2.8.

3.1.163 phy reset sequence: An OOB sequence (see 3.1.155) followed by a speed negotiation sequence (see 3.1.248). See 4.4.

3.1.164 physical link: Two differential signal pairs, one pair in each direction, that connect two physical phys (see 3.1.166). See 4.1.2.

3.1.165 physical link rate: A link rate between two physical phys established as a result of speed negotiation between those phys.

3.1.166 physical phy: A phy (see 3.1.161) that contains a transceiver (see 3.1.281) and electrically interfaces to a physical link to communicate with another physical phy. See 4.1.2.

3.1.167 port: A SAS port (see 3.1.204) or an expander port (see 3.1.81). Each port contains one or more phys (see 3.1.161). See 4.1.4.

3.1.168 port identifier: The value by which a port is identified within a domain. See 4.2.7.

3.1.169 port name: A worldwide unique name for a port within a transport protocol. See 4.2.6.

3.1.170 potential pathway: A set of logical links between a SAS initiator phy and a SAS target phy. See 4.1.11.

3.1.171 power on: Power being applied.

3.1.172 primitive: A dword containing a 7Ch or BCh control byte followed by three data bytes, or a K28.3 or K28.5 control character with correct disparity followed by three data characters with correct disparity. See 7.2.

3.1.173 primitive sequence: A set of primitives treated as a single entity. See 7.2.4.

3.1.174 probe point: Physical position in a test load where signal characteristics for compliance points are measured See 5.3.2.

3.1.175 programmed maximum physical link rate: The maximum operational physical link rate of a phy (e.g., as programmed via the SMP PHY CONTROL function (see 10.4.3.28) or the Phy Control and Discover mode page (see 10.2.7.5)).

3.1.176 programmed minimum physical link rate: The minimum operational physical link rate of a phy (e.g., as programmed via the SMP PHY CONTROL function (see 10.4.3.28) or the Phy Control and Discover mode page (see 10.2.7.5)).

3.1.177 protocol: Either SSP (see 3.1.232), SMP (see 3.1.231), or STP (see 3.1.229).

3.1.178 rate: Data transfer rate of a physical or logical link (e.g., 1.5 Gbps, 3 Gbps, or 6 Gbps).

3.1.179 rate change delay time (RCDT): The time between rates during the speed negotiation sequence (see 6.7.4.2).

Author: hpq-relliott

Subject: Note

Date: 5/17/2008 2:12:16 PM

 ACCEPT - DONE (5/5 WG: Mark Evans does want this changed. The "may" level is appropriate.

Worded as: "For a phy that supports being attached to SATA phy, a dword containing a 7Ch or BCh control byte followed by three data bytes, or a K28.3 or K28.5 control character with correct disparity followed by three data characters with correct disparity. For a phy that does not support being attached to SATA phy, a dword containing a BCh control byte followed by three data bytes, or a K28.5 control character with correct disparity followed by three data characters with correct disparity.")

An end device that does not support being attached to SATA (e.g., a SAS disk drive) should be allowed to consider K28.3 based dwords as not being primitives, and thus treat them as illegal dwords.

Add this somewhere:

An end device that does not support STP or SATA may consider a dword containing 7Ch control byte or K28.3 control character as an invalid dword.

3.1.180 read data: Data transferred to the SCSI application client's data-in buffer from the SCSI device server, as requested by the Send Data-In transport protocol service (see 10.2.1.6).

3.1.181 receiver circuit: An electronic circuit that converts an analog serial input signal to a logic signal.

3.1.182 receiver device (Rx): The device downstream from an IR or CR compliance point containing a portion of the physical link and a receiver circuit (see 3.1.181).

3.1.183 reference receiver device: A set of parameters defining electrical performance characteristics that provide a set of minimum electrical performance requirements for a receiver device and that are also used in mathematical modeling to determine compliance of a TxRx connection or transmitter device. See 5.3.7.4.3.

3.1.184 reference transmitter device: A set of parameters defining electrical performance characteristics of a transmitter device that are used in mathematical modeling to determine compliance of a TxRx connection. See 5.3.6.5.4.

3.1.185 reference transmitter test load: A set of S-parameters defining the electrical characteristics of a TxRx connection used as the basis for transmitter device and receiver device performance evaluation through mathematical modeling. See 5.3.2.5.

3.1.186 reflection coefficient (ρ): The ratio of reflected voltage to incident voltage.

3.1.187 request: Information passed from a higher layer state machine to a lower layer state machine, usually to initiate some action. See 3.6.

3.1.188 reset event: An event that triggers a hard reset (see 4.4.2) in a SAS device.

3.1.189 response: Information passed from a higher layer state machine to a lower layer state machine, usually in response to an indication (see 3.1.109). See 3.6.

3.1.190 return loss: The ratio, usually expressed in dB, of incident power to reflected power. The dB magnitude of S_{11} or S_{22} is the negative of return loss in dB. See B.9.

3.1.191 rise time: The time interval for the rising signal edge to transit between specified percentages of the signal amplitude. In this standard, the measurement points are the 20 % and 80 % voltage levels. Also see fall time (see 3.1.88).

3.1.192 role: When referring to classes (see 3.1.29) and objects (see 3.1.152), a label at the end of an association (see 3.1.11) or aggregation (see 3.1.9) that defines a relationship to the class on the other side of the association or aggregation. See 3.5.

3.1.193 route table optimization: A configuration subprocess (see 3.1.35) algorithm that reduces the number of entries required in an expander route table (see 3.1.84) in an externally configurable expander device (see 3.1.86). See 4.8.3.

3.1.194 run length: Number of consecutive identical bits in the transmitted signal (e.g., the pattern 0011111010 includes the following run lengths: five 1s, one 0, one 1, and indeterminate run lengths of 0s at the start and end).

3.1.195 running disparity (RD): A binary parameter with a negative (-) or positive (+) value indicating the cumulative encoded signal imbalance between the one and zero signal state of all characters since dword synchronization has been achieved. See 6.2.

3.1.196 SAS address: A worldwide unique NAA IEEE Registered format identifier assigned to a SAS port (see 3.1.204) or expander device (see 3.1.77). See 4.2.2.

3.1.197 SAS device: A SAS initiator device, SAS target device, or SAS target/initiator device.

Page: 15

● Author: wdc-mevans
Subject: Highlight
Date: 5/17/2008 2:14:39 PM
T REJECT

server, as
s/b
server as

● Author: elx-bmartin
Subject: Highlight
Date: 6/3/2008 6:37:40 PM
T ACCEPT - DONE (see reply to comment on transmitter device (Tx) definition)

IR or CR compliance point

There is no definition of these points. They are mentioned in the text but only as points with no textual description that I can find.

● Author: Isi-gpenokie
Subject: Highlight
Date: 5/6/2008 4:07:48 PM
T REJECT (See response to "insertion loss" comment)

Is there any case in this standard when it is expressed in something other than dB? I think not so the << usually >> term should be deleted.

● Author: RElliott
Subject: Highlight
Date: 6/30/2008 6:16:52 PM
T ACCEPT - DONE

classes (see 3.1.29) and objects (see 3.1.152)
s/b
classes (see 3.1.28) or objects (see 3.1.152)

● Author: RElliott
Subject: Underline
Date: 6/30/2008 6:16:52 PM
T ACCEPT - DONE

See 6.2.

point to new RD section

● Author: RElliott
Subject: Highlight
Date: 6/30/2008 6:16:52 PM
T ACCEPT - DONE

A worldwide unique NAA IEEE Registered format identifier
s/b
An identifier

to allow for NAA Locally Administered (see comment in 4.2.2)

● Author: RElliott
Subject: Highlight
Date: 6/30/2008 6:16:52 PM
T ACCEPT - DONE

Comments from page 15 continued on next page

3.1.180 read data: Data transferred to the SCSI application client's data-in buffer from the SCSI device server, as requested by the Send Data-In transport protocol service (see 10.2.1.6).

3.1.181 receiver circuit: An electronic circuit that converts an analog serial input signal to a logic signal.

3.1.182 receiver device (Rx): The device downstream from an IR or CR compliance point containing a portion of the physical link and a receiver circuit (see 3.1.181).

3.1.183 reference receiver device: A set of parameters defining electrical performance characteristics that provide a set of minimum electrical performance requirements for a receiver device and that are also used in mathematical modeling to determine compliance of a TxRx connection or transmitter device. See 5.3.7.4.3.

3.1.184 reference transmitter device: A set of parameters defining electrical performance characteristics of a transmitter device that are used in mathematical modeling to determine compliance of a TxRx connection. See 5.3.6.5.4.

3.1.185 reference transmitter test load: A set of S-parameters defining the electrical characteristics of a TxRx connection used as the basis for transmitter device and receiver device performance evaluation through mathematical modeling. See 5.3.2.5.

3.1.186 reflection coefficient (ρ): The ratio of reflected voltage to incident voltage.

3.1.187 request: Information passed from a higher layer state machine to a lower layer state machine, usually to initiate some action. See 3.6.

3.1.188 reset event: An event that triggers a hard reset (see 4.4.2) in a SAS device.

3.1.189 response: Information passed from a higher layer state machine to a lower layer state machine, usually in response to an indication (see 3.1.109). See 3.6.

3.1.190 return loss: The ratio, usually expressed in dB, of incident power to reflected power. The dB magnitude of S_{11} or S_{22} is the negative of return loss in dB. See B.9.

3.1.191 rise time: The time interval for the rising signal edge to transit between specified percentages of the signal amplitude. In this standard, the measurement points are the 20 % and 80 % voltage levels. Also see fall time (see 3.1.88).

3.1.192 role: When referring to classes (see 3.1.29) and objects (see 3.1.152), a label at the end of an association (see 3.1.11) or aggregation (see 3.1.9) that defines a relationship to the class on the other side of the association or aggregation. See 3.5.

3.1.193 route table optimization: A configuration subprocess (see 3.1.35) algorithm that reduces the number of entries required in an expander route table (see 3.1.84) in an externally configurable expander device (see 3.1.86). See 4.8.3.

3.1.194 run length: Number of consecutive identical bits in the transmitted signal (e.g., the pattern 0011111010 includes the following run lengths: five 1s, one 0, one 1, and indeterminate run lengths of 0s at the start and end).

3.1.195 running disparity (RD): A binary parameter with a negative (-) or positive (+) value indicating the cumulative encoded signal imbalance between the one and zero signal state of all characters since dword synchronization has been achieved. See 6.2.

3.1.196 SAS address: A worldwide unique NAA IEEE Registered format identifier assigned to a SAS port (see 3.1.204) or expander device (see 3.1.77). See 4.2.2.

3.1.197 SAS device: A SAS initiator device, SAS target device, or SAS target/initiator device.

See 4.2.2.

needs to allow for NAA Locally Assigned (see comment in 4.2.2)

Author: Isi-gpenokie

Subject: Highlight

Date: 5/25/2008 4:51:26 PM

T ACCEPT - DONE (changed to "A SAS initiator device and/or a SAS target device.")

There should be no such thing as a << SAS target/initiator device >> delete it here and everywhere else where it appears.

- 3.1.198 SAS domain:** The I/O system defined by this standard that may serve as a SCSI domain. See 4.1.9.
- 3.1.199 SAS initiator device:** A device containing SSP, STP, and/or SMP initiator ports in a SAS domain. See 4.1.6.
- 3.1.200 SAS initiator phy:** A logical phy (see 3.1.133) in a SAS initiator device.
- 3.1.201 SAS initiator port:** An SSP initiator port (see 3.1.254), STP initiator port (see 3.1.262), and/or SMP initiator port (see 3.1.240) in a SAS domain.
- 3.1.202 SAS phy:** A phy in a SAS device that interfaces to a service delivery subsystem (see 3.1.233).
- 3.1.203 SAS logical phy:** A SAS phy (see 3.1.202) or a multiplexed portion of a SAS phy. See 4.1.2.
- 3.1.204 SAS port:** A SAS initiator port (see 3.1.201), SAS target port (see 3.1.207), or SAS target/initiator port (see 3.1.209).
- 3.1.205 SAS target device:** A device containing SSP, STP, and/or SMP target ports in a SAS domain. See 4.1.6.
- 3.1.206 SAS target phy:** A logical phy (see 3.1.133) in a SAS target device.
- 3.1.207 SAS target port:** An SSP target port (see 3.1.258), STP target port (see 3.1.267), and/or SMP target port (see 3.1.244) in a SAS domain.
- ~~**3.1.208 SAS target/initiator device:** A device that has all the characteristics of a SAS target device and a SAS initiator device.~~
- ~~**3.1.209 SAS target/initiator port:** A port that has all the characteristics of a SAS target port and a SAS initiator port in a SAS domain.~~
- 3.1.210 SATA device:** An ATA device that contains a SATA device port in an ATA domain (analogous to a SCSI target device).
- 3.1.211 SATA device port:** An ATA device object that interfaces to a service delivery subsystem (see 3.1.233) with SATA. Analogous to a SCSI target port.
- 3.1.212 SATA host:** An ATA host that contains a SATA host port in an ATA domain (analogous to a SCSI initiator device).
- 3.1.213 SATA host port:** An ATA host object that interfaces to a service delivery subsystem (see 3.1.233) with SATA. Analogous to a SCSI initiator port.
- 3.1.214 SATA phy:** A phy in a SATA device or SATA port selector that interfaces to a service delivery subsystem (see 3.1.233). Analogous to a SAS phy.
- 3.1.215 SATA port selector:** A device that attaches to two SATA host ports (i.e., two ATA domains) and one SATA device port, and provides the means for one SATA host to access the device at any given time (see SATA-2).
- 3.1.216 saturating counter:** A counter that remains at its maximum value after reaching its maximum value.
- 3.1.217 scrambling:** Modifying data by XORing each bit with a pattern generated by a linear feedback shift register to minimize repetitive character patterns. See 7.6.
- 3.1.218 SCSI device:** A device that contains one or more SCSI ports that are connected to a service delivery subsystem (see 3.1.233) and supports a SCSI application protocol. See SAM-4.

Page: 16

● Author: Isi-gpenokie
Subject: Highlight
Date: 5/25/2008 4:52:07 PM
T ACCEPT - DONE (using "and/or")

This << port (see 3.1.201), SAS target port >> should be << port (see 3.1.201) or SAS target port >>

● Author: Isi-gpenokie
Subject: Highlight
Date: 5/25/2008 4:51:53 PM
T ACCEPT - DONE (using "and/or")

There should be no such thing as a << SAS target/initiator port >> delete it here and everywhere else where it appears.

● Author: Isi-gpenokie
Subject: Cross-Out
Date: 5/25/2008 4:52:20 PM
~~**T** ACCEPT - DONE~~
~~There should be no such thing~~

● Author: Isi-gpenokie
Subject: Cross-Out
Date: 5/25/2008 4:52:26 PM
~~**T** ACCEPT - DONE~~
~~There should be no such thing~~

● Author: RElliott
Subject: Highlight
Date: 6/30/2008 6:16:52 PM
T ACCEPT - DONE
SCSI target device
s/b
SAS target device

● Author: RElliott
Subject: Highlight
Date: 6/30/2008 6:16:52 PM
T ACCEPT - DONE
SCSI target port
s/b
SAS target port

● Author: RElliott
Subject: Highlight
Date: 6/30/2008 6:16:52 PM
T ACCEPT - DONE
SCSI initiator device
s/b
SAS initiator device

● Author: Isi-gpenokie
Subject: Highlight
Date: 5/25/2008 5:18:13 PM
T ACCEPT - DONE (globally)

You have to ways of stating this, one in ()s and the other in a sentence. Change all ()s to sentences so there read << SATA. Analogous to a SCSI thing. >>.

● Author: RElliott
Subject: Note
Date: 6/30/2008 6:16:52 PM

Comments from page 16 continued on next page

- 3.1.198 SAS domain:** The I/O system defined by this standard that may serve as a SCSI domain. See 4.1.9.
- 3.1.199 SAS initiator device:** A device containing SSP, STP, and/or SMP initiator ports in a SAS domain. See 4.1.6.
- 3.1.200 SAS initiator phy:** A logical phy (see 3.1.133) in a SAS initiator device.
- 3.1.201 SAS initiator port:** An SSP initiator port (see 3.1.254), STP initiator port (see 3.1.262), and/or SMP initiator port (see 3.1.240) in a SAS domain.
- 3.1.202 SAS phy:** A phy in a SAS device that interfaces to a service delivery subsystem (see 3.1.233).
- 3.1.203 SAS logical phy:** A SAS phy (see 3.1.202) or a multiplexed portion of a SAS phy. See 4.1.2.
- 3.1.204 SAS port:** A SAS initiator port (see 3.1.201), SAS target port (see 3.1.207), or SAS target/initiator port (see 3.1.209).
- 3.1.205 SAS target device:** A device containing SSP, STP, and/or SMP target ports in a SAS domain. See 4.1.6.
- 3.1.206 SAS target phy:** A logical phy (see 3.1.133) in a SAS target device.
- 3.1.207 SAS target port:** An SSP target port (see 3.1.258), STP target port (see 3.1.267), and/or SMP target port (see 3.1.244) in a SAS domain.
- ~~**3.1.208 SAS target/initiator device:** A device that has all the characteristics of a SAS target device and a SAS initiator device.~~
- ~~**3.1.209 SAS target/initiator port:** A port that has all the characteristics of a SAS target port and a SAS initiator port in a SAS domain.~~
- 3.1.210 SATA device:** An ATA device that contains a SATA device port in an ATA domain (analogous to a SCSI target device).
- 3.1.211 SATA device port:** An ATA device object that interfaces to a service delivery subsystem (see 3.1.233) with SATA. Analogous to a SCSI target port.
- 3.1.212 SATA host:** An ATA host that contains a SATA host port in an ATA domain (analogous to a SCSI initiator device).
- 3.1.213 SATA host port:** An ATA host object that interfaces to a service delivery subsystem (see 3.1.233) with SATA. Analogous to a SCSI initiator port. 
- 3.1.214 SATA phy:** A phy in a SATA device or SATA port selector that interfaces to a service delivery subsystem (see 3.1.233). Analogous to a SAS phy.
- 3.1.215 SATA port selector:** A device that attaches to two SATA host ports (i.e., two ATA domains) and one SATA device port, and provides the means for one SATA host to access the device at any given time (see SATA-2).
- 3.1.216 saturating counter:** A counter that remains at its maximum value after reaching its maximum value.
- 3.1.217 scrambling:** Modifying data by XORing each bit with a pattern generated by a linear feedback shift register to minimize repetitive character patterns. See 7.6.
- 3.1.218 SCSI device:** A device that contains one or more SCSI ports that are connected to a service delivery subsystem (see 3.1.233) and supports a SCSI application protocol. See SAM-4.

 ACCEPT - DONE
SCSI initiator port
s/b
SAS initiator port

3.1.219 SCSI domain: An I/O system consisting of a set of SCSI devices that communicate with one another by means of a service delivery subsystem (see 3.1.233). See SAM-4.

3.1.220 SCSI initiator device: A SCSI device containing SCSI application clients and SCSI initiator ports that originates device service and task management requests to be processed by a SCSI target device and receives device service and task management responses from SCSI target devices. See SAM-4.

3.1.221 SCSI initiator port: A SCSI initiator device object that acts as the connection between SCSI application clients and a service delivery subsystem (see 3.1.233) through which indications and responses are routed. See SAM-4.

3.1.222 SCSI port: A SCSI initiator port, SCSI target port, or SCSI target/initiator port. See SAM-4.

3.1.223 SCSI target device: A SCSI device containing logical units and SCSI target ports that receives device service and task management requests for processing and sends device service and task management responses to SCSI initiator devices. See SAM-4.

3.1.224 SCSI target port: A SCSI target device object that contains a task router and acts as the connection between SCSI device servers and task managers and a service delivery subsystem (see 3.1.233) through which requests and confirmations are routed. See SAM-4.

~~**3.1.225 SCSI target/initiator device:** A device that has all the characteristics of a SCSI target device and a SCSI initiator device. See SAM-4.~~

~~**3.1.226 SCSI target/initiator port:** A SCSI target/initiator device object that has all the characteristics of a SCSI target port and a SCSI initiator port. See SAM-4.~~

3.1.227 self-configuring expander device: An expander device (see 3.1.77) containing an SMP initiator port and a management application client to perform the discover process (see 3.1.62) to configure its own expander route table (see 3.1.84). See 4.7.2.

3.1.228 Serial ATA (SATA): The protocol defined by SATA-2 (see 2.3).

3.1.229 Serial ATA Tunneled Protocol (STP): The protocol defined in this standard used by STP initiator ports (see 3.1.262) to communicate with STP target ports (see 3.1.267) in a SAS domain. See 7.17 and 9.3.

3.1.230 Serial Attached SCSI (SAS): The set of protocols and the interconnect defined by this standard.

3.1.231 Serial Management Protocol (SMP): The protocol defined in this standard used by SMP initiator ports (see 3.1.240) to communicate with SMP target ports (see 3.1.244) in a SAS domain. See 7.18 and 9.4.

3.1.232 Serial SCSI Protocol (SSP): The protocol defined in this standard used by SSP initiator ports (see 3.1.254) to communicate with SSP target ports (see 3.1.258) in a SAS domain. See 7.16 and 9.2.

3.1.233 service delivery subsystem: The part of a SCSI I/O system that transmits information between a SCSI initiator port and a SCSI target port, or the part of an ATA I/O system that transmits information between an ATA host and an ATA device, or the part of a SAS I/O system that transmits information between a SAS initiator port and a SAS target port.

~~**3.1.234 signal:** The entire voltage waveform during transmission.~~

3.1.235 signal amplitude: A property of the overall signal (see 3.1.234) that describes the peak or peak-to-peak values of the signal level (see 3.1.236).

3.1.236 signal level: The instantaneous intensity of a signal (see 3.1.234) measured in volts.

Page: 17

Author: RElliott
Subject: Highlight
Date: 6/30/2008 6:16:52 PM

T ACCEPT - DONE
indications and responses
s/b
requests and confirmations

since right now, SAM-4 does not define indications and responses on the initiator side (it does so only on the target side). This matches the SAM-4 post-letter ballot definition.

Author: RElliott
Subject: Highlight
Date: 6/30/2008 6:16:52 PM

T ACCEPT - DONE
A SCSI initiator port, SCSI target port, or SCSI target/initiator port.
s/b
A SCSI initiator port and/or a SCSI target port.

since SAM-4 got rid of "SCSI target/initiator port"

Author: Isi-gpenokie
Subject: Highlight
Date: 5/25/2008 5:24:42 PM

T ACCEPT - DONE
This should be << through which requests, indications, responses, and confirmations are routed. >>

Author: Isi-gpenokie
Subject: Cross-Out
Date: 5/25/2008 4:53:10 PM

~~**T**~~ ACCEPT - DONE
There is no such thing.

Author: Isi-gpenokie
Subject: Cross-Out
Date: 5/25/2008 4:53:16 PM

~~**T**~~ ACCEPT - DONE
There is not such thing.

Author: elx-bmartin
Subject: Highlight
Date: 5/6/2008 4:07:48 PM

T ACCEPT - DONE (changed 2.3 to 2.4, but kept in parenthesis)
(see 2.3).

s.b.

See 2.4

Author: intc-mseidel
Subject: Highlight
Date: 5/6/2008 4:07:48 PM

T ACCEPT - DONE
The listing of "SATA-2" is in 2.4, not 2.3.

Author: elx-bmartin

Comments from page 17 continued on next page

3.1.219 SCSI domain: An I/O system consisting of a set of SCSI devices that communicate with one another by means of a service delivery subsystem (see 3.1.233). See SAM-4.

3.1.220 SCSI initiator device: A SCSI device containing SCSI application clients and SCSI initiator ports that originates device service and task management requests to be processed by a SCSI target device and receives device service and task management responses from SCSI target devices. See SAM-4.

3.1.221 SCSI initiator port: A SCSI initiator device object that acts as the connection between SCSI application clients and a service delivery subsystem (see 3.1.233) through which indications and responses are routed. See SAM-4.

3.1.222 SCSI port: A SCSI initiator port, SCSI target port, or SCSI target/initiator port. See SAM-4.

3.1.223 SCSI target device: A SCSI device containing logical units and SCSI target ports that receives device service and task management requests for processing and sends device service and task management responses to SCSI initiator devices. See SAM-4.

3.1.224 SCSI target port: A SCSI target device object that contains a task router and acts as the connection between SCSI device servers and task managers and a service delivery subsystem (see 3.1.233) through which requests and confirmations are routed. See SAM-4.

~~**3.1.225 SCSI target/initiator device:** A device that has all the characteristics of a SCSI target device and a SCSI initiator device. See SAM-4.~~

~~**3.1.226 SCSI target/initiator port:** A SCSI target/initiator device object that has all the characteristics of a SCSI target port and a SCSI initiator port. See SAM-4.~~

3.1.227 self-configuring expander device: An expander device (see 3.1.77) containing an SMP initiator port and a management application client to perform the discover process (see 3.1.62) to configure its own expander route table (see 3.1.84). See 4.7.2.

3.1.228 Serial ATA (SATA): The protocol defined by SATA-2 (see 2.3).

3.1.229 Serial ATA Tunneled Protocol (STP): The protocol defined in this standard used by STP initiator ports (see 3.1.262) to communicate with STP target ports (see 3.1.267) in a SAS domain. See 7.17 and 9.3.

3.1.230 Serial Attached SCSI (SAS): The set of protocols and the interconnect defined by this standard.

3.1.231 Serial Management Protocol (SMP): The protocol defined in this standard used by SMP initiator ports (see 3.1.240) to communicate with SMP target ports (see 3.1.244) in a SAS domain. See 7.18 and 9.4.

3.1.232 Serial SCSI Protocol (SSP): The protocol defined in this standard used by SSP initiator ports (see 3.1.254) to communicate with SSP target ports (see 3.1.258) in a SAS domain. See 7.16 and 9.2.

3.1.233 service delivery subsystem: The part of a SCSI I/O system that transmits information between a SCSI initiator port and a SCSI target port, or the part of an ATA I/O system that transmits information between an ATA host and an ATA device, or the part of a SAS I/O system that transmits information between a SAS initiator port and a SAS target port.

~~**3.1.234 signal:** The entire voltage waveform during transmission.~~

3.1.235 signal amplitude: A property of the overall signal (see 3.1.234) that describes the peak or peak-to-peak values of the signal level (see 3.1.236).

3.1.236 signal level: The instantaneous intensity of a signal (see 3.1.234) measured in volts.

Subject: Cross-Out
Date: 6/9/2008 2:34:14 PM

TACCEPT - DONE (This definition came from FC-PI. Preface with "When referring to the physical layer, ..." to avoid confusion with other meanings.

Use the first of these from <http://www.atis.org/glossary/>, the ANSI T1 glossary (changing "can be" to "is"):
signal: 1. Detectable transmitted energy that can be used to carry information. 2. A time-dependent variation of a characteristic of a physical phenomenon, used to convey information. 3. As applied to electronics, any transmitted electrical impulse. [JP1] 4. Operationally, a type of message, the text of which consists of one or more letters, words, characters, signal flags, visual displays, or special sounds, with prearranged meaning and which is conveyed or transmitted by visual, acoustical, or electrical means. [JP1]
)

3.1.234 signal: The entire voltage waveform during transmission.

The term signal is used in its normal dictionary definition as well as this narrow definition. I would suggest deleting this definition as the meaning of signal is well understood in context where it is used or possibly replace it with transmission signal.

Author: elx-bmartin
Subject: Highlight
Date: 6/9/2008 2:52:34 PM
TREJECT (see "signal" response)

signal

see comment on 3.1.234

Author: elx-bmartin
Subject: Highlight
Date: 6/9/2008 2:52:40 PM
TREJECT (see "signal" response)

signal

see comment on 3.1.234

- 3.1.237 signal time:** The time of an OOB signal (see 3.1.156), consisting of six burst times (see 3.1.24), six idle times (see 3.1.108), and one negation time (see 3.1.147). See 6.6.
- 3.1.238 signal tolerance:** The ability of the receiver device to recover transmitted bits in an incoming data stream with maximum jitter and minimum amplitude. See MJSQ.
- 3.1.239 SMP initiator phy:** A SAS initiator phy (see 3.1.200) in an SMP initiator port (see 3.1.240).
- 3.1.240 SMP initiator port:** A SAS initiator device object in a SAS domain that interfaces to a service delivery subsystem with SMP.
- 3.1.241 SMP phy:** A SAS logical phy (see 3.1.203) in an SMP port.
- 3.1.242 SMP port:** An SMP initiator port (see 3.1.240), SMP target port (see 3.1.244), ~~or SMP target/initiator port (see 3.1.245).~~
- 3.1.243 SMP target phy:** A SAS target phy (see 3.1.206) in an SMP target port (see 3.1.244).
- 3.1.244 SMP target port:** A SAS target device object in a SAS domain that interfaces to a service delivery subsystem (see 3.1.233) with SMP.
- ~~**3.1.245 SMP target/initiator port:** A port that has all the characteristics of an SMP initiator port and an SMP target port.~~
- 3.1.246 SMP zone configuration function:** An SMP function that configures zoning expander shadow values (see 3.1.307) and is only accepted by a locked zoning expander device (see 3.1.130). See 4.9.6.3.
- 3.1.247 speed negotiation lock time (SNLT):** The maximum time during an SNW (see 3.1.250) for a transmitter to reply with ALIGN (1) (see 6.7.4.2).
- 3.1.248 speed negotiation sequence:** A sequence in which two phys negotiate the operational physical link rate. See 6.7.2.2 and 6.7.4.2.
- 3.1.249 speed negotiation transmit time (SNTT):** The time during which ALIGN (0) or ALIGN (1) is transmitted during the speed negotiation sequence (see 6.7.4.2).
- 3.1.250 speed negotiation window (SNW):** A portion of the SAS speed negotiation sequence (see 3.1.248). See 6.7.4.2.3.
- 3.1.251 speed negotiation window time (SNWT):** The duration of an SNW (see 3.1.251). See 6.7.4.2.3.
- 3.1.252 spread spectrum clocking (SSC):** The technique of modulating the operating frequency of a transmitted signal (i.e., the physical link rate) to reduce the measured peak amplitude of radiated emissions. See 5.3.8.
- 3.1.253 SSP initiator phy:** A SAS initiator phy (see 3.1.200) in an SSP initiator port (see 3.1.254).
- 3.1.254 SSP initiator port:** A SCSI initiator port in a SAS domain that implements SSP.
- 3.1.255 SSP phy:** A SAS logical phy (see 3.1.203) in an SSP port.
- 3.1.256 SSP port:** An SSP initiator port (see 3.1.254), SSP target port (see 3.1.258), ~~or SSP target/initiator port (see 3.1.259).~~
- 3.1.257 SSP target phy:** A SAS target phy (see 3.1.206) in an SSP target port (see 3.1.258).
- 3.1.258 SSP target port:** A SCSI target port in a SAS domain that implements SSP.

Page: 18

● Author: lsi-gpenokie
Subject: Cross-Out
Date: 5/25/2008 4:53:58 PM
 ACCEPT - DONE (you mean "should be no such thing." Used "and/or" instead)

There is no such thing as a << SMP target/initiator port >>

● Author: lsi-gpenokie
Subject: Cross-Out
Date: 5/25/2008 4:54:09 PM
 ACCEPT - DONE (you mean "should be no such thing.")

The is no such thing.

● Author: intc-mseidel
Subject: Highlight
Date: 5/25/2008 4:56:32 PM
 ACCEPT - DONE

The definition for SNTT does not conform to that in Table 95. Table 95 is correct.

● Author: lsi-gpenokie
Subject: Cross-Out
Date: 5/25/2008 4:56:47 PM
 ACCEPT - DONE (you mean "should be no such thing." Use "and/or" instead)

This should be deleted as there is not such thing.

~~3.1.259 SSP target/initiator port: A port that has all the characteristics of an SSP initiator port and an SSP target port.~~

3.1.260 state machine variable: A variable that exists within the context of a state machine that may log status determined in one state that is used in another state of the same state machine affecting subsequent state transitions or state machine outputs.

3.1.261 STP initiator phy: A SAS initiator phy (see 3.1.200) in an STP initiator port (see 3.1.262).

3.1.262 STP initiator port: A SAS initiator device object in a SAS domain that interfaces to a service delivery subsystem (see 3.1.233) with STP.

3.1.263 STP phy: A SAS logical phy (see 3.1.203) in an STP port.

3.1.264 STP port: An STP initiator port (see 3.1.262), STP target port (see 3.1.267), ~~or STP target/initiator port (see 3.1.268).~~

3.1.265 STP primitive: A primitive used only inside STP connections and on SATA physical links. See 7.2.2.

3.1.266 STP target phy: A SAS target phy (see 3.1.206) in an STP target port (see 3.1.267).

3.1.267 STP target port: A SAS target device object in a SAS domain that interfaces to a service delivery subsystem (see 3.1.233) with STP.

~~3.1.268 STP target/initiator port: A port that has all the characteristics of an STP initiator port and an STP target port.~~

3.1.269 STP/SATA bridge: An expander device object containing an STP target port, a SATA host port, and the functions required to forward information between the STP target port and SATA host port to enable STP initiator ports in a SAS domain to communicate with SATA devices in an ATA domain.

3.1.270 subtractive routing attribute: The attribute of an expander phy that indicates it may be used by the ECM (see 3.1.75) to route connection requests to an attached expander device that were not resolved using the direct routing method or table routing method. See 4.6.7.1.

3.1.271 subtractive routing method: The method the ECM (see 3.1.75) uses to route connection requests not resolved using the direct routing method or table routing method to an attached expander device (see 3.1.77). See 4.6.7.1.

3.1.272 symbol: The smallest unit of data transmission on a physical link (i.e., a bit). A symbol represents a single transition if the maximum transition rate (i.e., a 0101b pattern) is occurring.

3.1.273 table routing attribute: The attribute of an expander phy that indicates it may be used by the ECM (see 3.1.75) to route connection requests using an expander route table (see 3.1.84). See 4.6.7.1.

3.1.274 table routing method: The method the ECM (see 3.1.75) uses to route connection requests to an attached expander device (see 3.1.77) using an expander route table (see 3.1.84). See 4.6.7.1.

~~3.1.275 task: An object within the logical unit representing the work associated with a command. See SAM-4.~~

3.1.276 task management function: A task manager service capable of being requested by a SCSI application client to affect the processing of one or more tasks. See SAM-4.

3.1.277 task manager: An object within a SCSI target device that controls the sequencing of SCSI commands and processes SCSI task management functions. See SAM-4.

3.1.278 training: The process of adapting equalization circuitry in a receiver device to an incoming pattern.

Page: 19

● Author: lsi-gpenokie
Subject: Cross-Out
Date: 5/25/2008 4:56:59 PM
 ACCEPT - DONE (you mean "should be no such thing.")

This should be deleted as there is no such thing.

● Author: lsi-gpenokie
Subject: Highlight
Date: 5/25/2008 4:58:22 PM
 ACCEPT - DONE
This should be << state machine that may contain status from one state that is used in another state

● Author: lsi-gpenokie
Subject: Cross-Out
Date: 5/25/2008 4:58:34 PM
 ACCEPT - DONE (you mean "should be no such thing." Use "and/or" instead)

No such thing exists.

● Author: lsi-gpenokie
Subject: Cross-Out
Date: 5/25/2008 4:58:47 PM
 ACCEPT - DONE

There should be no such thing.

● Author: wdc-mevans
Subject: Highlight
Date: 5/25/2008 4:58:59 PM
 ACCEPT - DONE (that the expander phy)
it
s/b
that the phy

● Author: wdc-mevans
Subject: Highlight
Date: 5/25/2008 4:59:12 PM
 ACCEPT - DONE (that the expander phy)
it
s/b
that the phy

● Author: RElliott
Subject: Cross-Out
Date: 6/30/2008 6:16:52 PM
 ACCEPT - DONE (and changed "task" to "command" throughout, where appropriate)

3.1.275 task: An object within the logical unit representing the work associated with a command. See SAM-4.

3.1.279 training lock time (TLT): The maximum time during Train-SNW for a receiver to complete training (see 3.1.278) and transmit TRAIN_DONE patterns instead of TRAIN patterns (see 6.7.4.2.3.4).

3.1.280 Train-SNW window time (TWT): The actual duration of Train-SNW (see 6.7.4.2.3.4).

3.1.281 transceiver: A physical entity that contains both a transmitter device (see 3.1.284) and a receiver device (see 3.1.182).

3.1.282 transmitter circuit: An electronic circuit that converts a logic signal to an analog serial output signal.

3.1.283 transmitter compliance transfer function (TCTF): The mathematical statement of the transfer function through which the transmitter shall be capable of producing acceptable signals as defined by a receive mask. See 5.3.6.1.

3.1.284 transmitter device (Tx): The device upstream from an IT or CT compliance point containing a portion of the physical link and a transmitter circuit (see 3.1.282).

3.1.285 transport protocol service confirmation: Information passed from the transport layer to the application layer (i.e., from the SSP initiator port to the SCSI application client) that notifies the application layer that a SCSI transport protocol service has completed.

3.1.286 transport protocol service indication: Information passed from the transport layer to the application layer notifying the application layer (i.e., from the SSP target port to the SCSI device server) to begin a SCSI transport protocol service.

3.1.287 transport protocol service request: Information passed from the SCSI application layer to the SSP transport layer (i.e., from the SCSI application client to the SCSI initiator port) to begin a SCSI transport protocol service.

3.1.288 transport protocol service response: Information passed from the application layer to the transport layer (i.e., from the SCSI device server to the SSP target port) that completes the SCSI transport protocol service.

3.1.289 TxRx connection: The complete simplex signal path between the transmitter circuit (see 3.1.282) and receiver circuit (see 3.1.181). See 5.3.3.

3.1.290 TxRx connection segment: That portion of a TxRx connection (see 3.1.289) delimited by separable connectors or changes in the conductive material. See 5.3.3.

3.1.291 unit interval (UI): The normalized, dimensionless, nominal duration of a symbol (see 3.1.272) (e.g., 666.6 ps at 1.5 Gbps, 333.3 ps at 3 Gbps, and 166.6 ps at 6 Gbps). The UI is the reciprocal of the baud rate (i.e., $UI = 1 / f_{\text{baud}}$) (see 3.1.18).

3.1.292 valid character: A character that is a control character (see 3.1.43) or a data character (see 3.1.48).

3.1.293 valid dword: A dword that is a data dword (see 3.1.49) or a primitive (see 3.1.172).

3.1.294 virtual phy: A phy (see 3.1.161) that interfaces with a vendor-specific interface to another virtual phy inside the same device. See 4.1.2.

3.1.295 voltage modulation amplitude (VMA): The difference in electrical voltage of a signal (see 3.1.234) between the stable one level and the stable zero level.

3.1.296 wide link: A group of physical links that attaches a wide port to another wide port. See 4.1.4.

3.1.297 wide port: A port that contains more than one phy. See 4.1.4.

Page: 20

Author: RElliott
Subject: Highlight
Date: 6/30/2008 6:16:52 PM
ACCEPT - DONE

(see 6.7.4.2.3.4).
move earlier in the sentence

Author: elx-bmartin
Subject: Highlight
Date: 6/3/2008 6:37:04 PM

ACCEPT - DONE (added four entries to the acronym list:
IR intra-enclosure (i.e., internal) receiver device compliance point (see 5.3.1)
IT intra-enclosure (i.e., internal) transmitter device compliance point (see 5.3.1)
CR inter-enclosure (i.e., cabinet) receiver device compliance point (see 5.3.1)
CT inter-enclosure (i.e., cabinet) transmitter device compliance point (see 5.3.1)

and changed this to "a transmitter device compliance point (see 3.1.xx)" since there's no need to use the acronyms here.

"compliance point" is already a defined term, pointing to 5.3.1.
)

IT or CT compliance point

These are not defined.

Author: elx-bmartin
Subject: Highlight
Date: 5/6/2008 4:07:48 PM

ACCEPT - DONE

transport
s.b.
SSP transport

Author: RElliott
Subject: Highlight
Date: 6/30/2008 6:16:52 PM

ACCEPT - DONE
application

s/b
SCSI application

Author: RElliott
Subject: Highlight
Date: 6/30/2008 6:16:52 PM

ACCEPT - DONE
application

s/b
SCSI application

Author: elx-bmartin
Subject: Comment on Text
Date: 5/6/2008 4:07:48 PM

ACCEPT - DONE

transport
s.b.
SSP transport

Comments from page 20 continued on next page

3.1.279 training lock time (TLT): The maximum time during Train-SNW for a receiver to complete training (see 3.1.278) and transmit TRAIN_DONE patterns instead of TRAIN patterns (see 6.7.4.2.3.4).

3.1.280 Train-SNW window time (TWT): The actual duration of Train-SNW (see 6.7.4.2.3.4).

3.1.281 transceiver: A physical entity that contains both a transmitter device (see 3.1.284) and a receiver device (see 3.1.182).

3.1.282 transmitter circuit: An electronic circuit that converts a logic signal to an analog serial output signal.

3.1.283 transmitter compliance transfer function (TCTF): The mathematical statement of the transfer function through which the transmitter shall be capable of producing acceptable signals as defined by a receive mask. See 5.3.6.1.

3.1.284 transmitter device (Tx): The device upstream from an IT or CT compliance point containing a portion of the physical link and a transmitter circuit (see 3.1.282).

3.1.285 transport protocol service confirmation: Information passed from the transport layer to the application layer (i.e., from the SSP initiator port to the SCSI application client) that notifies the application layer that a SCSI transport protocol service has completed.

3.1.286 transport protocol service indication: Information passed from the transport layer to the application layer notifying the application layer (i.e., from the SSP target port to the SCSI device server) to begin a SCSI transport protocol service.

3.1.287 transport protocol service request: Information passed from the SCSI application layer to the SSP transport layer (i.e., from the SCSI application client to the SCSI initiator port) to begin a SCSI transport protocol service.

3.1.288 transport protocol service response: Information passed from the application layer to the transport layer (i.e., from the SCSI device server to the SSP target port) that completes the SCSI transport protocol service.

3.1.289 TxRx connection: The complete simplex signal path between the transmitter circuit (see 3.1.282) and receiver circuit (see 3.1.181). See 5.3.3.

3.1.290 TxRx connection segment: That portion of a TxRx connection (see 3.1.289) delimited by separable connectors or changes in the conductive material. See 5.3.3.

3.1.291 unit interval (UI): The normalized, dimensionless, nominal duration of a symbol (see 3.1.272) (e.g., 666.6 ps at 1.5 Gbps, 333.3 ps at 3 Gbps, and 166.6 ps at 6 Gbps). The UI is the reciprocal of the baud rate (i.e., $UI = 1 / f_{\text{baud}}$) (see 3.1.18).

3.1.292 valid character: A character that is a control character (see 3.1.43) or a data character (see 3.1.48).

3.1.293 valid dword: A dword that is a data dword (see 3.1.49) or a primitive (see 3.1.172).

3.1.294 virtual phy: A phy (see 3.1.161) that interfaces with a vendor-specific interface to another virtual phy inside the same device. See 4.1.2.

3.1.295 voltage modulation amplitude (VMA): The difference in electrical voltage of a signal (see 3.1.234) between the stable one level and the stable zero level.

3.1.296 wide link: A group of physical links that attaches a wide port to another wide port. See 4.1.4.

3.1.297 wide port: A port that contains more than one phy. See 4.1.4.

● Author: RElliott
Subject: Highlight
Date: 6/30/2008 6:16:52 PM
T ACCEPT - DONE
application
s/b
SCSI application

● Author: stx-ghoulder
Subject: Highlight
Date: 5/6/2008 4:07:48 PM
T ACCEPT - DONE (also in 3.1.285, 3.1.287, and 3.1.288)
application layer
should this be "SCSI application layer"?

● Author: RElliott
Subject: Highlight
Date: 6/30/2008 6:16:52 PM
T ACCEPT - DONE
application
s/b
SCSI application

● Author: elx-bmartin
Subject: Comment on Text
Date: 5/6/2008 4:07:48 PM
T ACCEPT - DONE
transport
s.b.
SSP transport

3.1.298 wrapping counter: A counter that wraps back to zero after reaching its maximum value.

3.1.299 write data: Data transferred from the SCSI application client's data-out buffer to the SCSI device server, as requested by the Request Data-Out transport protocol service (see 10.2.1.8).

3.1.300 zone group: A set of phys in a ZPSDS (see 3.1.303) that all have the same access permission. See 4.9.

3.1.301 zone manager: The entity responsible for configuring a ZPSDS (see 3.1.303). See 4.9.1.

3.1.302 zone permission table: The table that defines access permission between the zone group of a source phy and the zone group of the destination phy. See 4.9.3.3.

3.1.303 zoned portion of a service delivery subsystem (ZPSDS): A group of zoning expander devices (see 3.1.305) that cooperate to control access between phys. The ZPSDS may include all or part of a service delivery subsystem (see 3.1.233). See 4.9.

3.1.304 zoning expander active values: The active zone permission table (see 3.1.302) and zone phy information in a zoning expander device (see 3.1.305). See 4.9.6.

3.1.305 zoning expander device: An expander device (see 3.1.77) that supports zoning. See 4.9.

3.1.306 zoning expander phy: An expander phy in a zoning expander device (see 3.1.305).

3.1.307 zoning expander shadow values: The shadow zone permission table (see 3.1.302) and zone phy information in a zoning expander device, which are changed by SMP zone configuration functions (see 3.1.246) but do not become active until the activate step (see 4.9.6.4) is performed. See 4.9.6.

3.2 Symbols and abbreviations

See 2.1 for abbreviations of standards bodies (e.g., ISO). Units and abbreviations used in this standard:

Abbreviation	Meaning
AA	ATA application layer (see 10.3)
A.C.	alternating current
ACK	acknowledge primitive (see 7.2.7.1)
AIP	arbitration in progress primitive (see 7.2.6.1)
ALT	actual lock time (see 3.1.4)
ATA	AT attachment (see 3.1.14)
ATAPI	AT attachment packet interface
ATA8-AAM	AT Attachment - 8 ATA/ATAPI Architecture Model standard (see 2.3)
ATA8-ACS	AT Attachment - 8 ATA/ATAPI Command Set standard (see 2.3)
ATT	actual training time (see 3.1.5)
AWG	American wire gauge
AWT	arbitration wait time
BCH	Bose, Chaudhuri and Hocquenghem code (see 4.2.3)
BCT	bit cell time (see 3.1.20)
BER	bit error ratio (see 3.1.21)
BIST	built in self test
BPP	broadcast propagation processor (see 3.1.23)
CDB	command descriptor block (see 3.1.31)

Page: 21

● Author: wdc-mevans
Subject: Highlight
Date: 5/17/2008 2:14:52 PM
 REJECT

server, as
s/b
server as

● Author: RElliott
Subject: Highlight
Date: 6/30/2008 6:16:52 PM
 ACCEPT - DONE (global)

zoning expander active values
s/b
zoning expander current values
(global)
to match Isi-bbesmer comment on page i

● Author: Isi-bbesmer
Subject: Highlight
Date: 5/16/2008 10:57:33 AM
 ACCEPT - DONE

active
s/b
current

(unless global comment to change current to active is accepted)

● Author: RElliott
Subject: Note
Date: 6/30/2008 6:16:52 PM
 ACCEPT - DONE

Add:
ACA auto contingent allegiance (see SAM-4)

● Author: RElliott
Subject: Note
Date: 9/4/2008 10:57:41 AM
 ACCEPT - DONE (GPIO, Gbps, ID, SGPIO, SMA, mA were already in or have been added to the list. plusminus already in; added |v| and circle-r; added <=, >= since those are FrameMaker variables (whose font could be lost); not adding <, >, +, or - since those are in the base ASCII character set.

Added normative reference to this standard that apparently covers all math symbols:
ISO 80000-2, *Quantities and units -- Part 2: Mathematical signs and symbols to be used in the natural sciences and technology.*
)

(from Ralph Weber, ENDL)

I have completed processing on SAS-1.1 ISO, except for the references. As a result, I have the following late Letter Ballot comments for SAS-2.

The following abbreviations should be added: ASIC, GPIO, Gbit, Gbps, (note: MBps is already defined), ID, SGPIO, SMA (sub-miniature A connector),

Comments from page 21 continued on next page

3.1.298 wrapping counter: A counter that wraps back to zero after reaching its maximum value.

3.1.299 write data: Data transferred from the SCSI application client's data-out buffer to the SCSI device server, as requested by the Request Data-Out transport protocol service (see 10.2.1.8).

3.1.300 zone group: A set of phys in a ZPSDS (see 3.1.303) that all have the same access permission. See 4.9.

3.1.301 zone manager: The entity responsible for configuring a ZPSDS (see 3.1.303). See 4.9.1.

3.1.302 zone permission table: The table that defines access permission between the zone group of a source phy and the zone group of the destination phy. See 4.9.3.3.

3.1.303 zoned portion of a service delivery subsystem (ZPSDS): A group of zoning expander devices (see 3.1.305) that cooperate to control access between phys. The ZPSDS may include all or part of a service delivery subsystem (see 3.1.233). See 4.9.

3.1.304 zoning expander active values: The active zone permission table (see 3.1.302) and zone phy information in a zoning expander device (see 3.1.305). See 4.9.6.

3.1.305 zoning expander device: An expander device (see 3.1.77) that supports zoning. See 4.9.

3.1.306 zoning expander phy: An expander phy in a zoning expander device (see 3.1.305).

3.1.307 zoning expander shadow values: The shadow zone permission table (see 3.1.302) and zone phy information in a zoning expander device, which are changed by SMP zone configuration functions (see 3.1.246) but do not become active until the activate step (see 4.9.6.4) is performed. See 4.9.6.

3.2 Symbols and abbreviations

See 2.1 for abbreviations of standards bodies (e.g., ISO). Units and abbreviations used in this standard:

Abbreviation	Meaning
AA	ATA application layer (see 10.3)
A.C.	alternating current
ACK	acknowledge primitive (see 7.2.7.1)
AIP	arbitration in progress primitive (see 7.2.6.1)
ALT	actual lock time (see 3.1.4)
ATA	AT attachment (see 3.1.14)
ATAPI	AT attachment packet interface
ATA8-AAM	AT Attachment - 8 ATA/ATAPI Architecture Model standard (see 2.3)
ATA8-ACS	AT Attachment - 8 ATA/ATAPI Command Set standard (see 2.3)
ATT	actual training time (see 3.1.5)
AWG	American wire gauge
AWT	arbitration wait time
BCH	Bose, Chaudhuri and Hocquenghem code (see 4.2.3)
BCT	bit cell time (see 3.1.20)
BER	bit error ratio (see 3.1.21)
BIST	built in self test
BPP	broadcast propagation processor (see 3.1.23)
CDB	command descriptor block (see 3.1.31)

and mA.

The following symbols should be added: plus-or-minus, greater than, greater than or equal to, less than, less than or equal to, and |v| ... absolute value of v.

● Author: RElliott
Subject: Note
Date: 9/4/2008 9:49:20 AM
 ACCEPT - DONE

Add a reference for SMA connectors:
IEC 60169-15, 1979. Radio-frequency connectors. Part 15: R.F. coaxial connectors with inner diameter of outer conductor 4.13 mm (0.163 in) with screw coupling — Characteristic impedance 50 ohms (Type SMA). International Standard

● Author: RElliott
Subject: Note
Date: 7/9/2008 10:05:27 AM
 ACCEPT - DONE

Add:

ID identifier
GPIO general purpose input/output
mA milliampere (i.e., 10^{-3} amperes)
SGPIO serial GPIO (see 2.4)
SMA subminiature version A connector

(from Ralph Weber, ENDL)

● Author: RElliott
Subject: Highlight
Date: 9/3/2008 6:26:29 PM
 ACCEPT - DONE

After:
American wire gauge
add:
(see ASTM Standard B 258-02 (see 2.4))

referring to the new reference in Other references

● Author: stx-ghoulder
Subject: Highlight
Date: 5/6/2008 4:07:48 PM

 ACCEPT - DONE ("Broadcast" is always supposed to be capitalized with mixed case, since it specifically represents both BROADCAST primitives and ZONED BROADCAST address frames. "broadcast" could be used as a verb. Corrected all instances, including "broadcast count", "broadcast source zone group", and "broadcast descriptor".)

broadcast propagation processor -- why is the word Broadcast capitalized in all other occurrences of this phrase but not here? I actually think none should be capitalized unless it is the first word of a sentence.

Abbreviation	Meaning
CDF	cumulative distribution function (see 3.1.44)
CDR	clock data recovery (see 3.1.30)
CJTPAT	compliant jitter tolerance pattern (see 3.1.34)
CRC	cyclic redundancy check (see 3.1.45)
dB	decibel (see 3.1.51)
dBm	decibel milliWatts (see 3.1.53)
dBmV	decibel milliVolts (see 3.1.52)
D.C.	direct current (see 3.1.59)
Dxx.y	data character (see 3.1.48)
DDJ	data dependent jitter (see 3.1.116)
DFE	decision feedback equalizer (see 3.1.54)
DJ	deterministic jitter (see 3.1.117)
e	2.718 28..., the base of the natural (i.e., hyperbolic) system of logarithms
ECM	expander connection manager (see 3.1.75)
ECR	expander connection router (see 3.1.76)
EMI	electromagnetic interference (see 3.1.68)
EOAF	end of address frame primitive (see 7.2.6.6)
EOF	end of frame primitive (see 7.2.7.4)
ESD	electrostatic discharge
Final-SNW	final speed negotiation window for 1.5 or 3 Gbps without training (see 6.7.4.2.3.2)
FIS	frame information structure (see 3.1.93)
G1	generation 1 physical link rate (1.5 Gbps)
G2	generation 2 physical link rate (3 Gbps)
G3	generation 3 physical link rate (6 Gbps)
G4	generation 4 physical link rate (defined in a future version of this standard)
Gbps	gigabits per second (10^9 bits per second)
Gen1i	SATA generation 1 physical link rate (1.5 Gbps) (see SATA-2)
Gen1x	SATA generation 1 physical link rate (1.5 Gbps) , extended length (see SATA-2)
Gen2i	SATA generation 2 physical link rate (3 Gbps) (see SATA-2)
Gen2x	SATA generation 2 physical link rate (3 Gbps) , extended length (see SATA-2)
GHz	gigahertz (10^9 cycles per second)
Hz	hertz (cycles per second)
ISI	intersymbol interference (see 3.1.112)
IU	information unit (see 3.1.110)
JMD	jitter measurement device
JTF	jitter transfer function (see 5.3.5.2)
JTPAT	jitter tolerance pattern (see 3.1.123)
kHz	kilohertz (10^3 cycles per second)
Kxx.y	control character (see 3.1.43)
LED	light-emitting diode
LMS	least mean square (see 3.1.124)

Page: 22

● Author: RElliott
Subject: Note
Date: 6/30/2008 6:16:52 PM
 ACCEPT - DONE

Add:
CRN command reference number (see SAM-4)

since sam4r14 uses that acronym for its protocol services argument

● Author: RElliott
Subject: Highlight
Date: 6/30/2008 6:16:52 PM
 ACCEPT - DONE

milliWatts
s/b
milliwatts

per SI brochure

● Author: RElliott
Subject: Highlight
Date: 6/30/2008 6:16:52 PM
 ACCEPT - DONE

milliVolts
s/b
millivolts

per SI brochure

● Author: wdc-mevans
Subject: Highlight
Date: 5/17/2008 2:17:52 PM
 ACCEPT - DONE

(1.5
s/b
(i.e., 1.5

● Author: wdc-mevans
Subject: Highlight
Date: 5/17/2008 2:17:56 PM
 ACCEPT - DONE

(3
s/b
(i.e., 3

● Author: wdc-mevans
Subject: Highlight
Date: 5/17/2008 2:18:00 PM
 ACCEPT - DONE

(6
s/b
(i.e., 6

● Author: RElliott
Subject: Cross-Out
Date: 7/9/2008 2:47:49 PM

Comments from page 22 continued on next page

Abbreviation	Meaning
CDF	cumulative distribution function (see 3.1.44)
CDR	clock data recovery (see 3.1.30)
CJTPAT	compliant jitter tolerance pattern (see 3.1.34)
CRC	cyclic redundancy check (see 3.1.45)
dB	decibel (see 3.1.51)
dBm	decibel milliWatts (see 3.1.53)
dBmV	decibel milliVolts (see 3.1.52)
D.C.	direct current (see 3.1.59)
Dxx.y	data character (see 3.1.48)
DDJ	data dependent jitter (see 3.1.116)
DFE	decision feedback equalizer (see 3.1.54)
DJ	deterministic jitter (see 3.1.117)
e	2.718 28..., the base of the natural (i.e., hyperbolic) system of logarithms
ECM	expander connection manager (see 3.1.75)
ECR	expander connection router (see 3.1.76)
EMI	electromagnetic interference (see 3.1.68)
EOAF	end of address frame primitive (see 7.2.6.6)
EOF	end of frame primitive (see 7.2.7.4)
ESD	electrostatic discharge
Final-SNW	final speed negotiation window for 1.5 or 3 Gbps without training (see 6.7.4.2.3.2)
FIS	frame information structure (see 3.1.93)
G1	generation 1 physical link rate (1.5 Gbps)
G2	generation 2 physical link rate (3 Gbps)
G3	generation 3 physical link rate (6 Gbps)
G4	generation 4 physical link rate (defined in a future version of this standard)
Gbps	gigabits per second (10^9 bits per second)
Gen1i	SATA generation 1 physical link rate (1.5 Gbps) (see SATA-2)
Gen1x	SATA generation 1 physical link rate (1.5 Gbps), extended length (see SATA-2)
Gen2i	SATA generation 2 physical link rate (3 Gbps) (see SATA-2)
Gen2x	SATA generation 2 physical link rate (3 Gbps), extended length (see SATA-2)
GHz	gigahertz (10^9 cycles per second)
Hz	hertz (cycles per second)
ISI	intersymbol interference (see 3.1.112)
IU	information unit (see 3.1.110)
JMD	jitter measurement device
JTF	jitter transfer function (see 5.3.5.2)
JTPAT	jitter tolerance pattern (see 3.1.123)
kHz	kilohertz (10^3 cycles per second)
Kxx.y	control character (see 3.1.43)
LED	light-emitting diode
LMS	least mean square (see 3.1.124)

 ACCEPT - DONE

Delete unused abbreviation:

G4 generation 4 physical link rate (defined in a future version of this standard)

● Author: wdc-mevans
Subject: Highlight
Date: 5/17/2008 2:18:37 PM

 ACCEPT - DONE
(1.5
s/b
(i.e., 1.5

● Author: wdc-mevans
Subject: Highlight
Date: 5/17/2008 2:18:41 PM

 ACCEPT - DONE
(1.5
s/b
(i.e., 1.5

● Author: wdc-mevans
Subject: Highlight
Date: 5/17/2008 2:18:45 PM

 ACCEPT - DONE
(3
s/b
(i.e., 3

● Author: wdc-mevans
Subject: Highlight
Date: 5/17/2008 2:18:51 PM

 ACCEPT - DONE
(3
s/b
(i.e., 3

● Author: RElliott
Subject: Note
Date: 6/30/2008 6:16:52 PM

 ACCEPT - DONE

Add another i.e. on these lines:

Hz (i.e., s⁻¹)

kHz (i.e., s⁻³)

MHz (i.e., s⁻⁶)

GHz (i.e., s⁻⁹)

to match the primary SI definition. ("unit cycles per second" is also used in the SI brochure.)

● Author: wdc-mevans
Subject: Highlight
Date: 5/25/2008 5:00:58 PM

 ACCEPT - DONE
(10
s/b
(i.e., 10

● Author: wdc-mevans
Subject: Highlight
Date: 5/25/2008 5:01:07 PM

 ACCEPT - DONE
(cycles
s/b

Comments from page 22 continued on next page

Abbreviation	Meaning
CDF	cumulative distribution function (see 3.1.44)
CDR	clock data recovery (see 3.1.30)
CJTPAT	compliant jitter tolerance pattern (see 3.1.34)
CRC	cyclic redundancy check (see 3.1.45)
dB	decibel (see 3.1.51)
dBm	decibel milliWatts (see 3.1.53)
dBmV	decibel milliVolts (see 3.1.52)
D.C.	direct current (see 3.1.59)
Dxx.y	data character (see 3.1.48)
DDJ	data dependent jitter (see 3.1.116)
DFE	decision feedback equalizer (see 3.1.54)
DJ	deterministic jitter (see 3.1.117)
e	2.718 28..., the base of the natural (i.e., hyperbolic) system of logarithms
ECM	expander connection manager (see 3.1.75)
ECR	expander connection router (see 3.1.76)
EMI	electromagnetic interference (see 3.1.68)
EOAF	end of address frame primitive (see 7.2.6.6)
EOF	end of frame primitive (see 7.2.7.4)
ESD	electrostatic discharge
Final-SNW	final speed negotiation window for 1.5 or 3 Gbps without training (see 6.7.4.2.3.2)
FIS	frame information structure (see 3.1.93)
G1	generation 1 physical link rate (1.5 Gbps)
G2	generation 2 physical link rate (3 Gbps)
G3	generation 3 physical link rate (6 Gbps)
G4	generation 4 physical link rate (defined in a future version of this standard)
Gbps	gigabits per second (10^9 bits per second)
Gen1i	SATA generation 1 physical link rate (1.5 Gbps)(see SATA-2)
Gen1x	SATA generation 1 physical link rate (1.5 Gbps), extended length (see SATA-2)
Gen2i	SATA generation 2 physical link rate (3 Gbps)(see SATA-2)
Gen2x	SATA generation 2 physical link rate (3 Gbps), extended length (see SATA-2)
GHz	gigahertz (10^9 cycles per second)
Hz	hertz (cycles per second)
ISI	intersymbol interference (see 3.1.112)
IU	information unit (see 3.1.110)
JMD	jitter measurement device
JTF	jitter transfer function (see 5.3.5.2)
JTPAT	jitter tolerance pattern (see 3.1.123)
kHz	kilohertz (10³ cycles per second)
Kxx.y	control character (see 3.1.43)
LED	light-emitting diode
LMS	least mean square (see 3.1.124)

(i.e., cycles)

● Author: RElliott
Subject: Cross-Out
Date: 7/17/2008 4:57:01 PM
~~T~~ ACCEPT - DONE

Delete this unused acronym:
IU information unit (see 3.1.110)

● Author: wdc-mevans
Subject: Highlight
Date: 5/25/2008 5:01:16 PM
T ACCEPT - DONE

(10
s/b
(i.e., 10

Abbreviation	Meaning
LSB	least significant bit (see 3.1.125)
LUN	logical unit number (see 3.1.135)
μ A	microampere (10^{-6} amperes)
μ s	microsecond (10^{-6} seconds)
MA	management application layer (see 10.4)
MBps	megabytes per second (10^6 bytes per second)
MHz	megahertz (10^6 cycles per second)
MSB	most significant bit (see 3.1.141)
ms	millisecond (10^{-3} seconds)
MT	SMP transport layer state machines (see 9.4)
MTT	maximum training time (see 3.1.136)
MTWT	maximum Train-SNW window time (see 3.1.137)
mV	millivolt (10^{-3} volts)
N/A	not applicable
NAA	name address authority (see 4.2)
NAK	negative acknowledge primitive (see 7.2.7.5)
NEXT	near-end crosstalk (see 3.1.146)
nF	nanofarad (10^{-9} Farads)
ns	nanosecond (10^{-9} seconds)
NVRAM	non-volatile random-access memory
OOB	out-of-band
OOBI	out-of-band interval (see 3.1.154)
OUI	organizationally unique identifier (i.e., company identifier)
PCB	printed circuit board
PL	port layer state machines (see 8.2)
PLL	phase lock loop
P-P	peak-to-peak
ppm	parts per million (10^{-6})
ps	picosecond (10^{-12} seconds)
RCDT	rate change delay time (see 3.1.179)
RD	running disparity (see 3.1.195)
RJ	random jitter (see 3.1.118)
rms	root mean square (i.e., quadratic mean)
RRDY	receiver ready primitive (see 7.2.7.6)
Rx	receiver device (see 3.1.182)
RTTL	reference transmitter test load (see 3.1.185)
SA	SCSI application layer (see 10.2)
SAM-4	SCSI Architecture Model - 4 standard (see 2.3)
SAS	Serial Attached SCSI (see 3.1.230)
SATA	Serial ATA (see 3.1.228)
SATA-2	Serial ATA 2.6 specification (see 2.4)

● Author: wdc-mevans
Subject: Highlight
Date: 5/25/2008 5:01:39 PM
T ACCEPT - DONE
(10
s/b
(i.e., 10

● Author: wdc-mevans
Subject: Highlight
Date: 5/25/2008 5:01:43 PM
T ACCEPT - DONE
(10
s/b
(i.e., 10

● Author: wdc-mevans
Subject: Highlight
Date: 5/25/2008 5:01:47 PM
T ACCEPT - DONE
(10
s/b
(i.e., 10

● Author: wdc-mevans
Subject: Highlight
Date: 5/25/2008 5:01:50 PM
T ACCEPT - DONE
(10
s/b
(i.e., 10

● Author: wdc-mevans
Subject: Highlight
Date: 5/25/2008 5:01:53 PM
T ACCEPT - DONE
(10
s/b
(i.e., 10

● Author: wdc-mevans
Subject: Highlight
Date: 5/25/2008 5:01:56 PM
T ACCEPT - DONE
(10
s/b
(i.e., 10

● Author: wdc-mevans
Subject: Highlight
Date: 5/25/2008 5:02:08 PM
T ACCEPT - DONE
(10
s/b
(i.e., 10

● Author: RElliott
Subject: Highlight
Date: 6/30/2008 6:16:52 PM
T ACCEPT - DONE

Abbreviation	Meaning
LSB	least significant bit (see 3.1.125)
LUN	logical unit number (see 3.1.135)
μ A	microampere (10^{-6} amperes)
μ s	microsecond (10^{-6} seconds)
MA	management application layer (see 10.4)
MBps	megabytes per second (10^6 bytes per second)
MHz	megahertz (10^6 cycles per second)
MSB	most significant bit (see 3.1.141)
ms	millisecond (10^{-3} seconds)
MT	SMP transport layer state machines (see 9.4)
MTT	maximum training time (see 3.1.136)
MTWT	maximum Train-SNW window time (see 3.1.137)
mV	millivolt (10^{-3} volts)
N/A	not applicable
NAA	name address authority (see 4.2)
NAK	negative acknowledge primitive (see 7.2.7.5)
NEXT	near-end crosstalk (see 3.1.146)
nF	nanofarad (10^{-9} Farads)
ns	nanosecond (10^{-9} seconds)
NVRAM	non-volatile random-access memory
OOB	out-of-band
OOBI	out-of-band interval (see 3.1.154)
OUI	organizationally unique identifier (i.e., company identifier)
PCB	printed circuit board
PL	port layer state machines (see 8.2)
PLL	phase lock loop
P-P	peak-to-peak
ppm	parts per million (10^{-6})
ps	picosecond (10^{-12} seconds)
RCDT	rate change delay time (see 3.1.179)
RD	running disparity (see 3.1.195)
RJ	random jitter (see 3.1.118)
rms	root mean square (i.e., quadratic mean)
RRDY	receiver ready primitive (see 7.2.7.6)
Rx	receiver device (see 3.1.182)
RTTL	reference transmitter test load (see 3.1.185)
SA	SCSI application layer (see 10.2)
SAM-4	SCSI Architecture Model - 4 standard (see 2.3)
SAS	Serial Attached SCSI (see 3.1.230)
SATA	Serial ATA (see 3.1.228)
SATA-2	Serial ATA 2.6 specification (see 2.4)

Farads
s/b
farads

per SI brochure

● Author: wdc-mevans
Subject: Highlight
Date: 5/25/2008 5:02:11 PM
T ACCEPT - DONE
(10
s/b
(i.e., 10

● Author: wdc-mevans
Subject: Highlight
Date: 5/25/2008 5:02:13 PM
T ACCEPT - DONE
(10
s/b
(i.e., 10

● Author: wdc-mevans
Subject: Highlight
Date: 5/25/2008 5:02:16 PM
T ACCEPT - DONE
(10
s/b
(i.e., 10

Abbreviation	Meaning
SBC-3	SCSI Block Commands - 3 standard (see 2.3)
SCSI	Small Computer System Interface family of standards
S _{ij}	S-parameter for port j to port i (see B.9)
S _{CCij}	S-parameter for common-mode to common-mode port j to port i (see B.9)
S _{CDij}	S-parameter for differential to common-mode port j to port i (see B.9)
S _{DCij}	S-parameter for common-mode to differential port j to port i (see B.9)
S _{DDij}	S-parameter for differential to differential port j to port i (see B.9)
SJ	sinusoidal jitter (see 3.1.119)
SL	link layer for SAS phys state machines (see 7.14)
SL_IR	link layer identification and hard reset state machines (see 7.9.4)
SMP	Serial Management Protocol (see 3.1.231), or link layer for SMP phys state machines (see 7.18.5)
SNLT	speed negotiation lock time (see 3.1.247)
SNTT	speed negotiation transmit time (see 3.1.249)
SNW	speed negotiation window (see 3.1.250)
SNW-1	speed negotiation window for 1.5 Gbps without training (see 6.7.4.2.3.2)
SNW-2	speed negotiation window for 3 Gbps without training (see 6.7.4.2.3.2)
SNW-3	speed negotiation window negotiating physical link rates with training (see 6.7.4.2.3.3)
SNWT	speed negotiation window time (see 3.1.251)
SOAF	start of address frame primitive (see 7.2.6.11)
SOF	start of frame primitive (see 7.2.7.7)
SP	phy layer state machine (see 6.8)
SP_DWS	phy layer dword synchronization state machine (see 6.9)
SPC-4	SCSI Primary Commands - 4 standard (see 2.3)
SSP	Serial SCSI Protocol (see 3.1.232), or link layer for SSP phys state machines (see 7.16.8)
ST	SSP transport layer state machines (see 9.2)
STP	Serial ATA Tunneled Protocol (see 3.1.229), or link layer for STP phys state machines (see 7.17.8)
s	second (unit of time)
TCTF	transmitter compliance transfer function (see 3.1.283)
TDNA	time domain network analyzer (i.e., TDR/TDT plus analysis software that performs a VNA-style output)
TDR	time domain reflectometer
TDT	time domain transmission
TJ	total jitter (see 3.1.120)
TLT	training lock time (see 3.1.279)
Train-SNW	speed negotiation window with training (see 6.7.4.2.3.4)
TT	STP transport layer state machines (see 9.3)
TWT	Train-SNW window time (see 3.1.280)
Tx	transmitter device (see 3.1.284)
UI	unit interval (see 3.1.291)

Author: wdc-mevans

Subject: Highlight

Date: 5/25/2008 5:02:37 PM

TREJECT (we use N ms, N us, N ns, and N ps a lot, which are derived from s. You are not supposed to mix SI symbols and names in one document; I'd rather use the symbols than spell all those out. The cases where s is used that are not preceded by a number clearly do not mean "seconds". Nobody has ever complained about a byte number "m" in a table being interpreted as "meter")

s second (unit of time)

s/b

[This is a problematic abbreviation because "s" is used in so many places in the draft as something like "source zone group". I could find only two places where "s" is used in the draft to mean "second". Search for "gigasymbols/s" and look in the table defining LED behavior. Because of this problematic nature, I recommend deleting this definition and replacing the occurrences of where "s" is used to mean "second" by using the words "second" or "seconds" as appropriate.]

Abbreviation	Meaning
V	volt
VMA	voltage modulation amplitude (see 3.1.295)
VNA	vector network analyzer
VPD	vital product data (see 10.2.11)
XL	link layer for expander phys state machine (see 7.15)
XOR	exclusive logical OR
ZP[s, d]	Zone permission bit for a source zone group (i.e., s) and a destination zone group (i.e., d) in the zone permission table (see 4.9.3.3)
ZPSDS	Zoned portion of a service delivery subsystem (see 3.1.303)
Δ (Delta)	difference operator
ϕ (phi)	phase
π (pi)	3.141 59... , the ratio of any circle's circumference to its diameter
ρ (rho)	reflection coefficient (see 3.1.186)
\wedge	exclusive logical OR
x	multiplication
/	division

3.3 Keywords

3.3.1 invalid: A keyword used to describe an illegal or unsupported bit, byte, word, field or code value. Receipt of an invalid bit, byte, word, field or code value shall be reported as an error.

3.3.2 mandatory: A keyword indicating an item that is required to be implemented as defined in this standard.

3.3.3 may: A keyword that indicates flexibility of choice with no implied preference (equivalent to "may or may not").

3.3.4 may not: Keywords that indicate flexibility of choice with no implied preference (equivalent to "may or may not").

3.3.5 obsolete: A keyword indicating that an item was defined in prior standards but has been removed from this standard.

3.3.6 optional: A keyword that describes features that are not required to be implemented by this standard. However, if any optional feature defined in this standard is implemented, then it shall be implemented as defined in this standard.

3.3.7 reserved: A keyword referring to bits, bytes, words, fields and code values that are set aside for future standardization. A reserved bit, byte, word or field shall be set to zero, or in accordance with a future extension to this standard. Recipients are not required to check reserved bits, bytes, words or fields for zero values. Receipt of reserved code values in defined fields shall be reported as an error.

3.3.8 restricted: A keyword referring to bits, bytes, words, and fields that are set aside for use in other standards or for other data structures in this standard. A restricted bit, byte, word, or field shall be treated as a reserved bit, byte, word or field for the purposes of the requirements defined in this standard.

3.3.9 shall: A keyword indicating a mandatory requirement. Designers are required to implement all such mandatory requirements to ensure interoperability with other products that conform to this standard.

Page: 25

● Author: wdc-mevans
Subject: Highlight
Date: 5/25/2008 5:02:55 PM
T REJECT (acronyms/symbols don't use i.e.)
(Delta)
s/b
(i.e., Delta)

● Author: wdc-mevans
Subject: Highlight
Date: 5/25/2008 5:03:02 PM
T REJECT (acronyms/symbols don't use i.e.)
(phi)
s/b
(i.e., phi)

● Author: RElliott
Subject: Highlight
Date: 7/9/2008 2:45:02 PM
T ACCEPT - DONE

any circle's circumference
s/b
the circumference of a circle

● Author: wdc-mevans
Subject: Highlight
Date: 5/25/2008 5:03:12 PM
T REJECT (acronyms/symbols don't use i.e.)
(pi)
s/b
(i.e., pi)

● Author: wdc-mevans
Subject: Highlight
Date: 5/25/2008 5:03:06 PM
T REJECT (acronyms/symbols don't use i.e.)
(rho)
s/b
(i.e., rho)

● Author: RElliott
Subject: Highlight
Date: 7/9/2008 2:35:42 PM
T ACCEPT - DONE

Ensure that char-xmultiply variable is used everywhere rather than a lowercase x

● Author: stx-goulder
Subject: Highlight
Date: 8/31/2008 5:44:25 PM
T REJECT (
8/31 "valid/invalid SNW" is too ingrained, and is reasonable wording. A "valid" SNW-3 can still have bad parity - calling it "successful" would be more confusing. The keyword definition doesn't specifically mention SNWs (just bit... code value), so it doesn't necessarily apply. Leaving as is.

7/14 keep "shall" here as is since 3 other keywords also use it. Change the SNW terminology.

5/5 I agree - there should be no "shalls" in the keywords. SNWs are the main violator of this, and can be changed to "successful" and "unsuccessful")

Comments from page 25 continued on next page

Abbreviation	Meaning
V	volt
VMA	voltage modulation amplitude (see 3.1.295)
VNA	vector network analyzer
VPD	vital product data (see 10.2.11)
XL	link layer for expander phys state machine (see 7.15)
XOR	exclusive logical OR
ZP[s, d]	Zone permission bit for a source zone group (i.e., s) and a destination zone group (i.e., d) in the zone permission table (see 4.9.3.3)
ZPSDS	Zoned portion of a service delivery subsystem (see 3.1.303)
Δ (Delta)	difference operator
ϕ (phi)	phase
π (pi)	3.141 59... , the ratio of any circle's circumference to its diameter
ρ (rho)	reflection coefficient (see 3.1.186)
\wedge	exclusive logical OR
x	multiplication
/	division

3.3 Keywords

3.3.1 invalid: A keyword used to describe an illegal or unsupported bit, byte, word, field or code value. Receipt of an invalid bit, byte, word, field or code value shall be reported as an error.

3.3.2 mandatory: A keyword indicating an item that is required to be implemented as defined in this standard.

3.3.3 may: A keyword that indicates flexibility of choice with no implied preference (equivalent to "may or may not").

3.3.4 may not: Keywords that indicate flexibility of choice with no implied preference (equivalent to "may or may not").

3.3.5 obsolete: A keyword indicating that an item was defined in prior standards but has been removed from this standard.

3.3.6 optional: A keyword that describes features that are not required to be implemented by this standard. However, if any optional feature defined in this standard is implemented, then it shall be implemented as defined in this standard.

3.3.7 reserved: A keyword referring to bits, bytes, words, fields and code values that are set aside for future standardization. A reserved bit, byte, word or field shall be set to zero, or in accordance with a future extension to this standard. Recipients are not required to check reserved bits, bytes, words or fields for zero values. Receipt of reserved code values in defined fields shall be reported as an error.

3.3.8 restricted: A keyword referring to bits, bytes, words, and fields that are set aside for use in other standards or for other data structures in this standard. A restricted bit, byte, word, or field shall be treated as a reserved bit, byte, word or field for the purposes of the requirements defined in this standard.

3.3.9 shall: A keyword indicating a mandatory requirement. Designers are required to implement all such mandatory requirements to ensure interoperability with other products that conform to this standard.

shall be

s/b is usually ... there are cases where invalid dwords or frames are just counted or ignored rather than "reported as an error". Also SNW-final makes assumption of "non-support" rather than error for invalid SNW windows.

● Author: wdc-mevans

Subject: Highlight

Date: 5/25/2008 5:03:52 PM

T REJECT (see no reason to follow SAM-4 down that path)

preference (equivalent to "may or may not").

s/b

preference. "May" is synonymous with the phrase "may or may not". [see SAM-4]

● Author: wdc-mevans

Subject: Highlight

Date: 5/25/2008 5:03:58 PM

T REJECT (see no reason to follow SAM-4 down that path)

preference (equivalent to "may or may not").

s/b

preference. "May not" is synonymous with the phrase "may or may not". [see SAM-4]

3.3.10 should: A keyword indicating flexibility of choice with a strongly preferred **alternative (equivalent to "is strongly recommended")**.

3.3.11 vendor specific: ~~Something (e.g., a bit, field, or code value) that is not defined by this standard and may be used differently in various implementations~~

3.4 Editorial conventions

Certain words and terms used in this standard have a specific meaning beyond the normal English meaning. These words and terms are defined either in clause 3 or in the text where they first appear.

Names of signals, address frames, primitives and primitive sequences, SMP functions, state machines, SCSI and ATA commands, SCSI statuses, SCSI sense keys, and SCSI additional sense codes are in all uppercase (e.g., REQUEST SENSE command).

Names of messages, requests, confirmations, indications, responses, event notifications, timers, SCSI diagnostic pages, SCSI mode pages, and SCSI log pages are in mixed case (e.g., Disconnect-Reconnect mode page).

Names of fields are in small uppercase (e.g., DESTINATION SAS ADDRESS). Normal case is used when the contents of a field are being discussed. ~~Fields containing only one bit are usually referred to as the NAME bit instead of the NAME field.~~

Normal case is used for words having the normal English meaning.

A binary number is represented in this standard by any sequence of digits consisting of only the Western-Arabic numerals 0 and 1 immediately followed by a lower-case b (e.g., 0101b). Underscores or spaces may be included between characters in binary number representations to increase readability or delineate field boundaries (e.g., 0 0101 1010b or 0_0101_1010b).

A hexadecimal number is represented in this standard by any sequence of digits consisting of only the Western-Arabic numerals 0 through 9 and/or the upper-case English letters A through F immediately followed by a lower-case h (e.g., FA23h). Underscores or spaces may be included between characters in hexadecimal number representations to increase readability or delineate field boundaries (e.g., B FD8C FA23h or B_FD8C_FA23h).

A decimal number is represented in this standard by any sequence of digits consisting of only the Arabic numerals 0 through 9 not immediately followed by a lower-case b or lower-case h (e.g., 25).

This standard uses the following conventions for representing decimal numbers:

- a) the decimal separator (i.e., separating the integer and fractional portions of the number) is a period;
- b) the thousands separator (i.e., separating groups of three digits in a portion of the number) is a space; and
- c) the thousands separator is used in both the integer portion and the fraction portion of a number.

Table 2 shows some examples of decimal numbers using various numbering conventions.

Table 2 — Numbering conventions

French	English	This standard
0,6	0.6	0.6
3,141 592 65	3.14159265	3.141 592 65
1 000	1,000	1 000
1 323 462,95	1,323,462.95	1 323 462.95

A decimal number represented in this standard with an overline over one or more digits following the decimal point is a number where the overlined digits are infinitely repeating (e.g., $666.\overline{6}$ means 666.666 666... or $666 \frac{2}{3}$, and $12.142 \overline{857}$ means 12.142 857 142 857... or $12 \frac{1}{7}$).

Page: 26

● Author: wdc-mevans

Subject: Highlight

Date: 5/25/2008 5:04:18 PM

T REJECT (that diverges from the wording in other standards)

alternative (equivalent to "is strongly recommended").

s/b

alternative. "Should" is used in cases where the defined instance is strongly recommended.

● Author: stx-goulder

Subject: Highlight

Date: 5/6/2008 4:07:48 PM

T REJECT (per a SAS-1.0 letter ballot comment from the T10 chair, vendor-specific is used as an adjective modifying some other obvious noun, and vendor specific is used as a noun).

vendor specific:

Most references to "vendor specific" in this document use a hyphen (i.e. vendor-specific) but this instance and a handful of others don't. We should be consistent -- always use the hyphen or always use space.

● Author: elx-bmartin

Subject: Cross-Out

Date: 5/6/2008 4:07:48 PM

T REJECT (see response on "field" definition)

Fields containing only one bit are usually referred to as the NAME bit instead of the NAME field.

Unless there is a place where we refer to a one bit value as a field remove this sentence.

Lists sequenced by letters (e.g., a) red, b) blue, c) green) show no ordering relationship between the listed items. Lists sequenced by numbers (e.g., 1) red, 2) blue, 3) green) show an ordering relationship between the listed items.

In the event of conflicting information the precedence for requirements defined in this standard is:

- 1) text;
- 2) tables; then
- 3) figures.

Notes do not constitute any requirements for implementers.

3.5 Class diagram and object diagram conventions

The notation used in class diagrams and object diagrams is based on the Unified Modeling Language (UML) specification.

Figure 3 shows the notation used for classes in class diagrams.

Notation for a class with no attributes or operations:



Notation for a class with attributes and no operations:

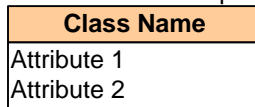

Notation for a class with operations and no attributes:

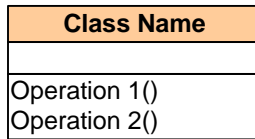

Notation for a class with attributes and operations:

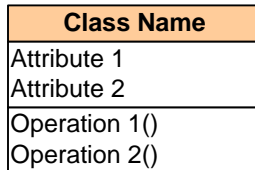

Notation for a class with attributes showing multiplicity and operations:

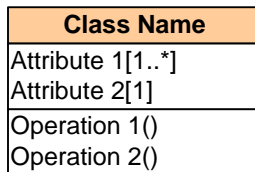

Figure 3 — Classes in class diagrams

Page: 27

● Author: wdc-mevans
Subject: Highlight
Date: 5/25/2008 5:04:45 PM

T REJECT (I do not endorse the SCSI style guide. This wording matches the wording used by SAM-4 and SPC-4. The wording currently in SBC-3 seems to be mistakenly incorporating editor instructions like "list shall have a semicolon here, etc.", not reader guidelines. There should be no "shall"s in this section.)

Lists

s/b

[Expand this paragraph to something more like the example shown in the SCSI style guide.]

● Author: RElliott
Subject: Highlight
Date: 6/30/2008 6:16:52 PM

T ACCEPT - DONE

then

s/b

and

to match several lsi-gpenokie comments on other ordered lists throughout the document.

This page contains no comments

Figure 5 defines the notation used for aggregation relationships between classes.

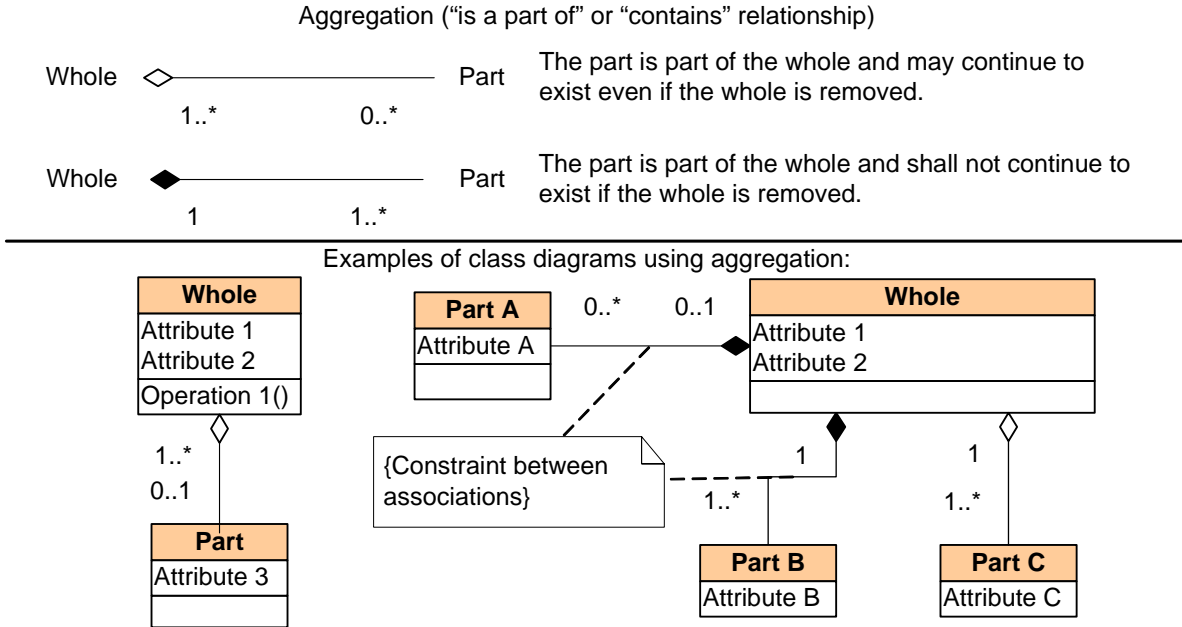

Figure 5 — Aggregation relationships in class diagrams

Figure 6 defines the notation used for generalization relationships between classes.

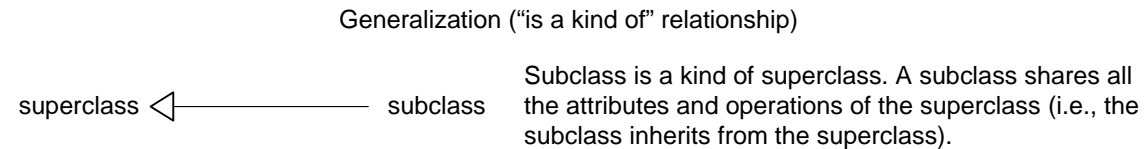

Figure 6 — Generalization relationships in class diagrams

This page contains no comments

Figure 7 defines the notation used for dependency relationships between classes.

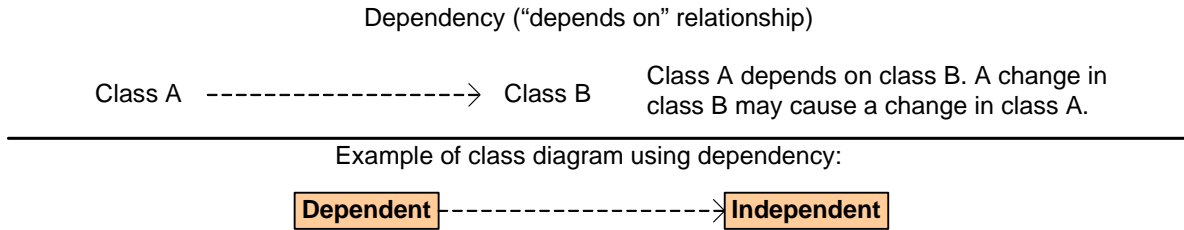
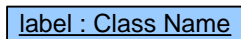

Figure 7 — Dependency relationships in class diagrams

Figure 8 defines the notation used for objects in object diagrams.

Notation for a named object with no attributes:



Notation for a named object with attributes:

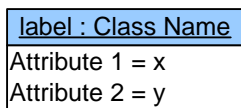

Notation for an anonymous object with no attributes:

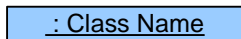

Notation for an anonymous object with attributes:

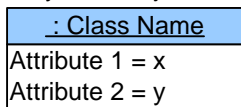



Figure 8 — Objects in object diagrams

A constraint is specified in a class diagram or an object diagram as text encapsulated with a { } notation within a box. See figure 5 for an example of a constraint.

A note is specified in a class diagram or an object diagram as text within a box. See figure 6 for an example of a note.

This page contains no comments

● Author: RElliott
Subject: Note
Date: 8/31/2008 5:44:56 PM
 ACCEPT - LAST (Visio wavy lines - unknown how to fix)

Fix wavy lines



● Author: wdc-mevans
Subject: Highlight
Date: 8/31/2008 5:44:45 PM
 ACCEPT - LAST (Visio wavy lines - unknown what causes this or what can be done to fix it)

Figure 9 — State machine conventions

s/b

[Fix the squiggly lines on the right hand side of both inner boxes in the figure.]

● Author: wdc-mevans
Subject: Highlight
Date: 5/25/2008 5:05:29 PM
 REJECT (That would change the meaning, since the latter phrase is just a definition of "transition label". Changed to an i.e. instead)

label, a

s/b

label, and may include a

If the state transition leaves the page, the transition label goes to or from a state designator label with double underlines rather than to or from a state.

The conditions and actions are described fully in the transition description text. In case of a conflict between a figure and the text, the text shall take precedence.

Upon entry into a state, all actions to be processed in that state are processed. If a state is re-entered from itself, all actions to be processed in the state are processed again. A state may be entered and exited in zero time if the conditions for exiting the state are valid upon entry into the state. Transitions between states are instantaneous.

3.6.3 Messages, requests, indications, confirmations, responses, and event notifications

Messages passed between state machines are shown with dashed lines labeled with a message name. When messages are passed between state machines within the same layer of the protocol, they are identified by either:

- a) a dashed line to or from a state machine name label with double underlines and/or state name label with double underlines, if the destination is in a different figure from the source;
- b) a dashed line to or from a state in another state machine in the same figure; or
- c) a dashed line from a state machine name label with double underlines to a "(to all states)" label, if the destination is every state in the state machine.

The meaning of each message is described in the state description text.

Requests, indications, confirmations, responses, and event notifications are shown with curved dashed lines originating from or going toward the top or bottom of the figure. Each request, indication, confirmation, response, and event notification is labeled. The meaning of each request, indication, confirmation, response, and event notification is described in the state description text.

Messages with unfilled arrowheads are passed to or from the state machine's transmitter or receiver, not shown in the state machine figures, and are directly related to data being transmitted on or received from the physical link.

The state machine description text for each state wholly defines the messages sent while the state machine is in that state. If a state machine in one state repeatedly sending a message transitions to another state, it stops repeatedly sending that message unless stated otherwise in the new state.

3.6.4 State machine counters, timers, and variables

State machines may contain counters, timers, and variables that affect the operation of the state machine. The following properties apply to counters, timers, and variables:

- a) Their scope is the state machine itself;
- b) They are created and deleted with the state machines with which they are associated;
- c) Their initialization and modification is specified in the state descriptions and the transition descriptions; and
- d) Their current values may be used to determine the behavior of a state and select the transition out of a state.

State machine timers may continue to run while a state machine is in a given state, and a timer may cause a state transition upon reaching a defined threshold value (e.g., zero for a timer that counts down).

3.6.5 State machine arguments

State machines may contain an argument received in a message or confirmation as a state machine argument. The following properties apply to state machine arguments:

- a) the state machine that sends the argument owns that argument's value;
- b) the state machine that receives the argument shall not modify those argument's values;
- c) the state machine that sends the argument may resend those arguments with different values;
- d) the scope of a state machine argument is the state machine itself; and
- e) state machine argument usage is described in the state descriptions and the transition descriptions.

Page: 32

Author: wdc-mevans

Subject: Highlight

Date: 5/17/2008 2:22:14 PM

T ACCEPT - DONE (as "If the state transition in one figure goes to or comes from a state machine or state in a different figure, then the transition is shown going to or coming from a state machine name or a state designator label with double underlines.")

If the state transition leaves the page, the transition label goes to or from a state designator label with double underlines rather than to or from a state.

s/b

If a state transition shown in one figure goes to or comes from a state machine or state in a different figure, then the state machine name or state designator label is shown in the first figure including the state machine name or state designator label with double underlines.

Author: wdc-mevans

Subject: Cross-Out

Date: 5/25/2008 5:05:43 PM

T REJECT

fully

s/b

[Delete the unnecessary word.]

Author: wdc-mevans

Subject: Cross-Out

Date: 5/25/2008 5:06:34 PM

T REJECT (this is a necessary word)

wholly

s/b

[Delete the unnecessary word.]

Author: wdc-mevans

Subject: Highlight

Date: 5/25/2008 5:06:16 PM

T REJECT (first noun/subject convention, but added "then")

it

s/b

then the state machine

Author: RElliott

Subject: Highlight

Date: 6/30/2008 6:16:52 PM

T ACCEPT - DONE

state repeatedly

s/b

state that is repeatedly

Author: RElliott

Subject: Underline

Date: 6/30/2008 6:16:52 PM

T ACCEPT - DONE

Their

s/b

their

(part of global change to lowercase a)b)c) list entries)

Comments from page 32 continued on next page

If the state transition leaves the page, the transition label goes to or from a state designator label with double underlines rather than to or from a state.

The conditions and actions are described fully in the transition description text. In case of a conflict between a figure and the text, the text shall take precedence.

Upon entry into a state, all actions to be processed in that state are processed. If a state is re-entered from itself, all actions to be processed in the state are processed again. A state may be entered and exited in zero time if the conditions for exiting the state are valid upon entry into the state. Transitions between states are instantaneous.

3.6.3 Messages, requests, indications, confirmations, responses, and event notifications

Messages passed between state machines are shown with dashed lines labeled with a message name. When messages are passed between state machines within the same layer of the protocol, they are identified by either:

- a) a dashed line to or from a state machine name label with double underlines and/or state name label with double underlines, if the destination is in a different figure from the source;
- b) a dashed line to or from a state in another state machine in the same figure; or
- c) a dashed line from a state machine name label with double underlines to a "(to all states)" label, if the destination is every state in the state machine.

The meaning of each message is described in the state description text.

Requests, indications, confirmations, responses, and event notifications are shown with curved dashed lines originating from or going toward the top or bottom of the figure. Each request, indication, confirmation, response, and event notification is labeled. The meaning of each request, indication, confirmation, response, and event notification is described in the state description text.

Messages with unfilled arrowheads are passed to or from the state machine's transmitter or receiver, not shown in the state machine figures, and are directly related to data being transmitted on or received from the physical link.

The state machine description text for each state wholly defines the messages sent while the state machine is in that state. If a state machine in one state repeatedly sending a message transitions to another state, it stops repeatedly sending that message unless stated otherwise in the new state.

3.6.4 State machine counters, timers, and variables

State machines may contain counters, timers, and variables that affect the operation of the state machine. The following properties apply to counters, timers, and variables:

- a) Their scope is the state machine itself;
- b) They are created and deleted with the state machines with which they are associated;
- c) Their initialization and modification is specified in the state descriptions and the transition descriptions; and
- d) Their current values may be used to determine the behavior of a state and select the transition out of a state.

State machine timers may continue to run while a state machine is in a given state, and a timer may cause a state transition upon reaching a defined threshold value (e.g., zero for a timer that counts down).

3.6.5 State machine arguments

State machines may contain an argument received in a message or confirmation as a state machine argument. The following properties apply to state machine arguments:

- a) the state machine that sends the argument owns that argument's value;
- b) the state machine that receives the argument shall not modify those argument's values;
- c) the state machine that sends the argument may resend those arguments with different values;
- d) the scope of a state machine argument is the state machine itself; and
- e) state machine argument usage is described in the state descriptions and the transition descriptions.

Author: RElliott
Subject: Underline
Date: 6/30/2008 6:16:52 PM
 ACCEPT - DONE

They
s/b
they

(part of global change to lowercase a)b)c) list entries)

Author: RElliott
Subject: Underline
Date: 6/30/2008 6:16:52 PM
 ACCEPT - DONE

Their
s/b
their

(part of global change to lowercase a)b)c) list entries)

Author: RElliott
Subject: Underline
Date: 6/30/2008 6:16:52 PM
 ACCEPT - DONE

Their
s/b
their

(part of global change to lowercase a)b)c) list entries)

Author: wdc-mevans
Subject: Cross-Out
Date: 5/25/2008 5:07:05 PM
 REJECT (this defines the awkward term "state machine argument")

as a state machine arguments
s/b
[Delete the unnecessary words.]

Author: wdc-mevans
Subject: Highlight
Date: 5/25/2008 5:06:45 PM
 ACCEPT - DONE

an argument
s/b
one or more state machine arguments

Author: stx-ghoulder
Subject: Highlight
Date: 5/6/2008 4:07:48 PM
 ACCEPT - DONE

arguments
s/b "argument" (not plural).

Author: wdc-mevans
Subject: Highlight
Date: 5/25/2008 5:07:26 PM
 ACCEPT - DONE

the

If the state transition leaves the page, the transition label goes to or from a state designator label with double underlines rather than to or from a state.

The conditions and actions are described fully in the transition description text. In case of a conflict between a figure and the text, the text shall take precedence.

Upon entry into a state, all actions to be processed in that state are processed. If a state is re-entered from itself, all actions to be processed in the state are processed again. A state may be entered and exited in zero time if the conditions for exiting the state are valid upon entry into the state. Transitions between states are instantaneous.

3.6.3 Messages, requests, indications, confirmations, responses, and event notifications

Messages passed between state machines are shown with dashed lines labeled with a message name. When messages are passed between state machines within the same layer of the protocol, they are identified by either:

- a) a dashed line to or from a state machine name label with double underlines and/or state name label with double underlines, if the destination is in a different figure from the source;
- b) a dashed line to or from a state in another state machine in the same figure; or
- c) a dashed line from a state machine name label with double underlines to a "(to all states)" label, if the destination is every state in the state machine.

The meaning of each message is described in the state description text.

Requests, indications, confirmations, responses, and event notifications are shown with curved dashed lines originating from or going toward the top or bottom of the figure. Each request, indication, confirmation, response, and event notification is labeled. The meaning of each request, indication, confirmation, response, and event notification is described in the state description text.

Messages with unfilled arrowheads are passed to or from the state machine's transmitter or receiver, not shown in the state machine figures, and are directly related to data being transmitted on or received from the physical link.

The state machine description text for each state wholly defines the messages sent while the state machine is in that state. If a state machine in one state repeatedly sending a message transitions to another state, it stops repeatedly sending that message unless stated otherwise in the new state.

3.6.4 State machine counters, timers, and variables

State machines may contain counters, timers, and variables that affect the operation of the state machine. The following properties apply to counters, timers, and variables:

- a) Their scope is the state machine itself;
- b) They are created and deleted with the state machines with which they are associated;
- c) Their initialization and modification is specified in the state descriptions and the transition descriptions; and
- d) Their current values may be used to determine the behavior of a state and select the transition out of a state.

State machine timers may continue to run while a state machine is in a given state, and a timer may cause a state transition upon reaching a defined threshold value (e.g., zero for a timer that counts down).

3.6.5 State machine arguments

State machines may contain an argument received in a message or confirmation as a state machine argument. The following properties apply to state machine arguments:

- a) the state machine that sends the argument owns that argument's value;
- b) the state machine that receives the argument shall not modify those argument's values;
- c) the state machine that sends the argument may resend those arguments with different values;
- d) the scope of a state machine argument is the state machine itself; and
- e) state machine argument usage is described in the state descriptions and the transition descriptions.

s/b
an

● Author: stx-goulder
Subject: Highlight
Date: 5/25/2008 5:07:59 PM
T ACCEPT - DONE
values

s/b "value" (not plural)

● Author: stx-goulder
Subject: Highlight
Date: 5/25/2008 5:08:10 PM
T ACCEPT - DONE ("that")

those

s/b "the".

● Author: wdc-mevans
Subject: Highlight
Date: 5/25/2008 5:07:37 PM
T ACCEPT - DONE

the
s/b
an

● Author: stx-goulder
Subject: Highlight
Date: 5/25/2008 5:07:50 PM
T ACCEPT - DONE
different values

s/b "a different value" (not plural)

● Author: stx-goulder
Subject: Highlight
Date: 5/17/2008 2:23:28 PM
T ACCEPT - DONE (as "that argument" per wdc-mevans comment)

those arguments

s/b "the argument"

● Author: wdc-mevans
Subject: Highlight
Date: 5/17/2008 2:23:17 PM
T ACCEPT - DONE

those arguments
s/b
that argument

● Author: wdc-mevans
Subject: Highlight
Date: 5/25/2008 5:07:31 PM
T ACCEPT - DONE

the
s/b
an

3.7 Bit and byte ordering

In a field in a table ~~consisting of more than one bit~~ that contains a single value (e.g., a number), the least significant bit (LSB) is shown on the right and the most significant bit (MSB) is shown on the left (e.g., in a byte, bit 7 is the MSB and is shown on the left; bit 0 is the LSB and is shown on the right). The MSB and LSB are not labeled if the field consists of 8 or fewer bits.

In a field in a table consisting of more than one byte that contains a single value (e.g., a number), the byte containing the MSB is stored at the lowest address and the byte containing the LSB is stored at the highest address (i.e., big-endian byte ordering). The MSB and LSB are labeled.

NOTE 9 - SATA numbers bits within fields the same as this standard, but uses little-endian byte ordering.

In a field in a table consisting of more than one byte that contains multiple fields each with their own values (e.g., a descriptor), there is no MSB and LSB of the field itself and thus there are no MSB and LSB labels. Each individual field has an MSB and LSB, but they are not labeled.

In a field containing a text string (e.g., ASCII or UTF-8), the MSB label is the MSB of the first character and the LSB label is the LSB of the last character.

Multiple byte fields are represented with only two rows, with the non-sequentially increasing byte number indicating the presence of additional bytes.

A data dword consists of 32 bits. Table 4 shows a data dword containing a single value, where the MSB is on the left in bit 31 and the LSB is on the right in bit 0.

Table 4 — Data dword containing a value

31	30	29	28	27	26	25	24	23	22	21	20	19	18	17	16	15	14	13	12	11	10	9	8	7	6	5	4	3	2	1	0	
MSB																	Value															LSB

Table 5 shows a data dword containing four one-byte fields, where byte 0 (the first byte) is on the left and byte 3 (the fourth byte) is on the right. Each byte has an MSB on the left and an LSB on the right.

Table 5 — Data dword containing four one-byte fields

31	30	29	28	27	26	25	24	23	22	21	20	19	18	17	16	15	14	13	12	11	10	9	8	7	6	5	4	3	2	1	0
MSB		Byte 0 (First byte)				LSB		MSB		Byte 1 (Second byte)				LSB		MSB		Byte 2 (Third byte)				LSB		MSB		Byte 3 (Fourth byte)				LSB	

3.8 Notation for procedures and functions

In this standard, the model for functional interfaces between objects is the callable procedure. Such interfaces are specified using the following notation:

[Result =] Procedure Name (IN ([input-1] [,input-2] ...), OUT ([output-1] [,output-2] ...))

where:

- Result: A single value representing the outcome of the procedure or function.
- Procedure Name: A descriptive name for the function to be performed.
- IN (Input-1, Input-2, ...): A comma-separated list of names identifying caller-supplied input data objects.
- OUT (Output-1, Output-2, ...): A comma-separated list of names identifying output data objects to be returned by the procedure.
- [...]: Brackets enclose optional or conditional parameters and arguments.

This notation allows data objects to be specified as inputs and outputs.

Page: 33

● Author: elx-bmartin
Subject: Cross-Out
Date: 5/6/2008 4:07:48 PM
T REJECT (see response to "field" definition)

consisting of more than one bit

see other comments on one bit fields

● Author: wdc-mevans
Subject: Highlight
Date: 5/25/2008 5:08:34 PM

T REJECT
rows, with
s/b
rows with

● Author: RElliott
Subject: Highlight
Date: 6/30/2008 6:16:52 PM

T ACCEPT - DONE

with
s/b
by

● Author: RElliott
Subject: Highlight
Date: 6/30/2008 6:16:52 PM

T ACCEPT - DONE

non-sequentially increasing byte number
indicating
s/b
where a non-sequentially increasing byte number indicates

Since a 2-byte field will still have sequential increasing byte numbers, this needs to be worded to still cover that case.

● Author: wdc-mevans
Subject: Highlight
Date: 5/25/2008 5:08:46 PM

T ACCEPT - DONE
bit 31 and
s/b
bit 31, and

● Author: wdc-mevans
Subject: Highlight
Date: 5/25/2008 5:08:59 PM

T ACCEPT - DONE
left and
s/b
left, and

4 General

4.1 Architecture

4.1.1 Architecture overview

A SAS domain (see 4.1.9) contains one or more SAS devices and a service delivery subsystem. A SAS domain may be a SCSI domain (see SAM-4).

A SAS device (see 4.1.6) contains one or more SAS ports (see 4.1.4). A SAS device may be a SCSI device (see SAM-4).

A SAS port (see 4.1.4) contains one or more phys (see 4.1.2). A SAS port may be a SCSI port (see SAM-4).

The service delivery subsystem (see 4.1.8) in a SAS domain may contain expander devices (see 4.1.7).

Expander devices contain expander ports (see 4.1.4) and one SMP port.

An expander port contains one or more phys (see 4.1.2).

An expander device shares its phys with the SAS device(s) contained within the expander device.

This page contains no comments

Figure 10 shows the class diagram for a SAS domain, showing the relationships between SAS Domain, SCSI Domain, Service Delivery Subsystem, Expander Device, Expander Port, SAS Device, SCSI Device, SAS Port, SCSI Port, and Phy classes. Not all attributes are shown.

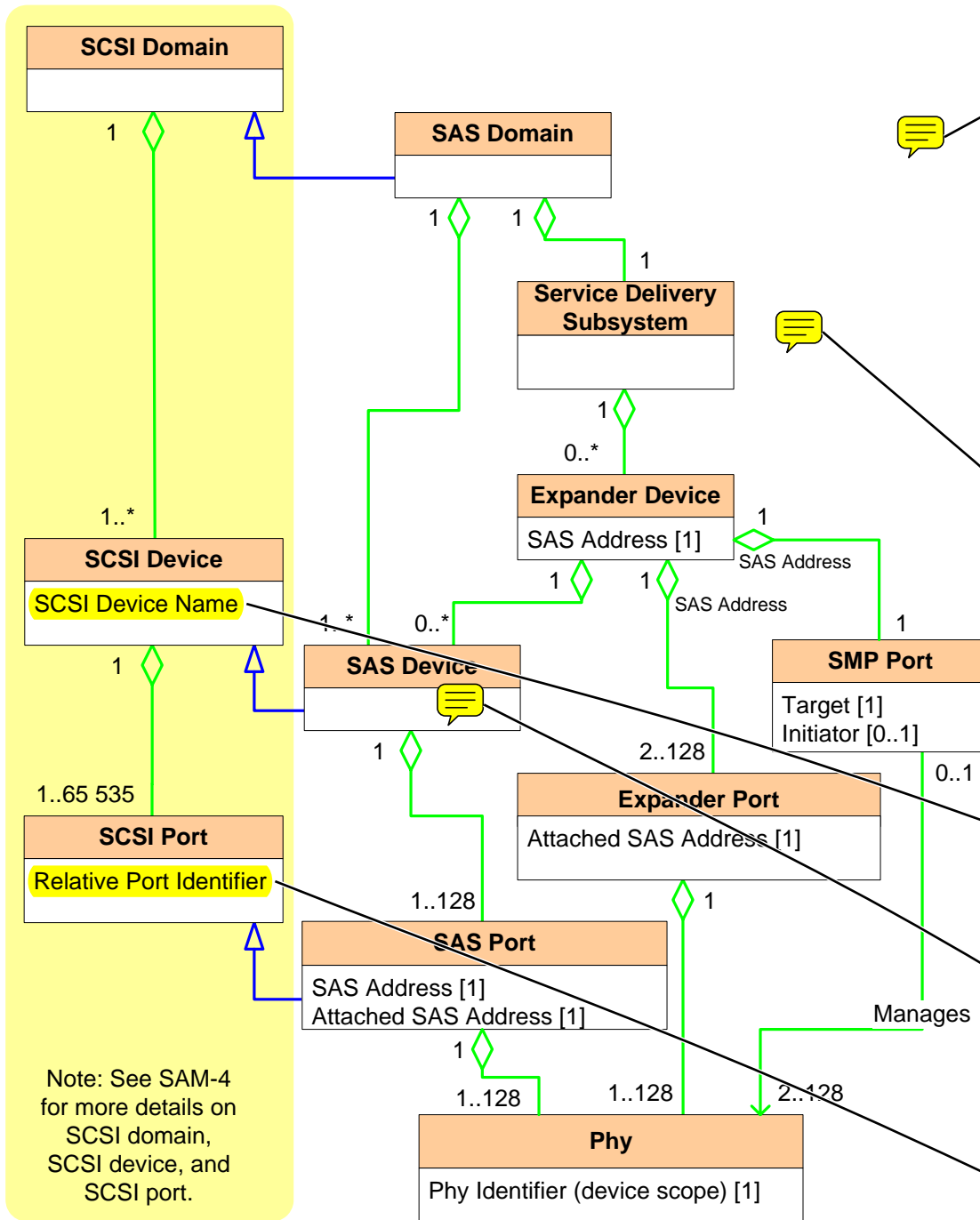

Figure 10 — SAS Domain class diagram

4.1.2 Physical links and phys

A physical link is a set of four wires used as two differential signal pairs. One differential signal transmits in one direction while the other differential signal transmits in the opposite direction. Data may be transmitted in both directions **simultaneously**.



A physical phy contains a transceiver which electrically interfaces to a physical link, which attaches to another physical phy. A virtual phy contains a vendor-specific interface to another virtual phy.

Page: 35

● Author: Isi-bbesmer

Subject: Note

Date: 5/25/2008 5:39:55 PM

 ACCEPT - DONE (This means phy identifiers are 0 through 254 with identifier 255 reserved, representing 1 through 255 possible phys.

figure 10: changed 1..128 to 1..255

figure 10: changed 2.. to 2..255

figure 16: changed [0..128] to [0..255] (zero to 255 possible phys)

figure 16: changed 2..128 to 2..255

also figure 38: 0..128 to 0..255

also figure 38: 1..128 to 1..255

also figure 39: 1..128 to 1..255

also figure 39: 0..128 to 0..255

in figure 50, not table 50: 128 to 255, deleted two unnecessary sentences

)

I suggest we increase the number of allowed expander phys to 255.

Note: We need to reserve PhyIdentifier 0xFF (255) for SMP REPORT BROADCASTS special usage.

Changes needed:

Figure 10

Figure 16

Section 4.2.8 Phy identifiers shall be greater than or equal to 00h and less than 80h

Table 8 (7-bit value)

Table 50

● Author: RElliott

Subject: Note

Date: 6/30/2008 6:16:52 PM

 ACCEPT - DONE

extend yellow underneath Service Delivery Subsystem, since that class is also defined in SAM-4. Add to Note in bottom of yellow.

● Author: RElliott

Subject: Highlight

Date: 6/30/2008 6:16:52 PM

 ACCEPT - DONE

SCSI Device Name

add [1] to emphasize that SAS requires this attribute

● Author: RElliott

Subject: Note

Date: 6/30/2008 6:16:52 PM

 ACCEPT - DONE

add a Device Name [1] attribute to the SAS Device class

● Author: RElliott

Subject: Highlight

Date: 6/30/2008 6:16:52 PM

 ACCEPT - DONE

Relative Port Identifier

Comments from page 35 continued on next page

Figure 10 shows the class diagram for a SAS domain, showing the relationships between SAS Domain, SCSI Domain, Service Delivery Subsystem, Expander Device, Expander Port, SAS Device, SCSI Device, SAS Port, SCSI Port, and Phy classes. Not all attributes are shown.

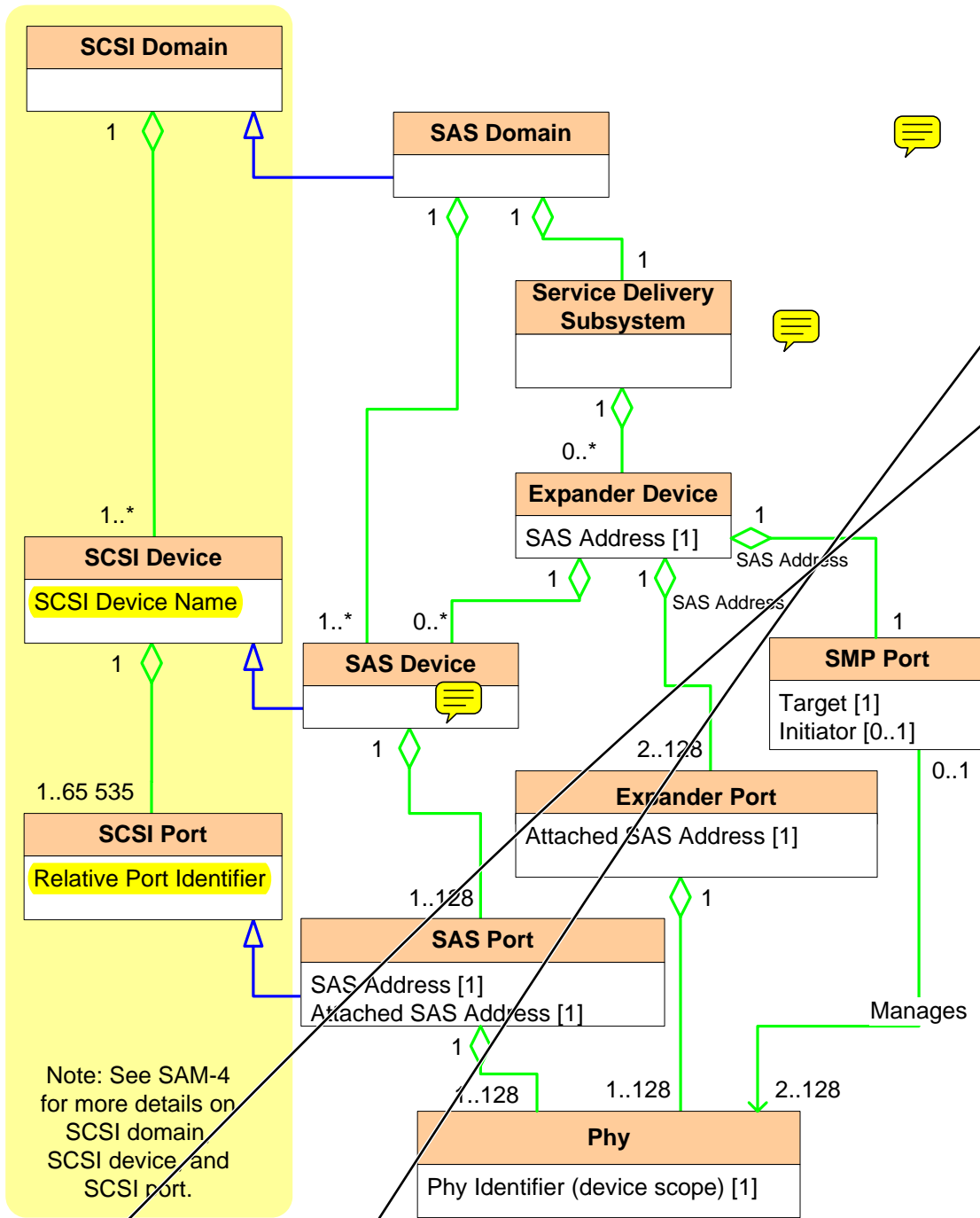

Figure 10 — SAS Domain class diagram

4.1.2 Physical links and phys

A physical link is a set of four wires, used as two differential signal pairs. One differential signal transmits in one direction while the other differential signal transmits in the opposite direction. Data may be transmitted in both directions **simultaneously**.

A physical phy contains a transceiver which electrically interfaces to a physical link, which attaches to another physical phy. A virtual phy contains a vendor-specific interface to another virtual phy.

add [1] to emphasize that SAS requires this attribute

● Author: wdc-mevans

Subject: Highlight

Date: 5/25/2008 5:40:28 PM

 REJECT (why replace one word with four that have the exact same dictionary meaning?)

simultaneously

s/b

at the same time

● Author: RElliott

Subject: Note

Date: 6/30/2008 6:16:52 PM

 ACCEPT - DONE

Add:

Virtual phys have vendor-specific variations of the state machines defined in this standard; the interface to other state machines complies with this standard, but the vendor-specific interface is different.

so the UML diagrams can just claim there is [1] SL_IR and XL state machine in an expander logical phy, rather than use [0..1] and cause confusion.

Phys are contained in ports (see 4.1.4). Phys interface to a service delivery subsystem (see 4.1.8).

Figure 11 shows two phys attached with a physical link.

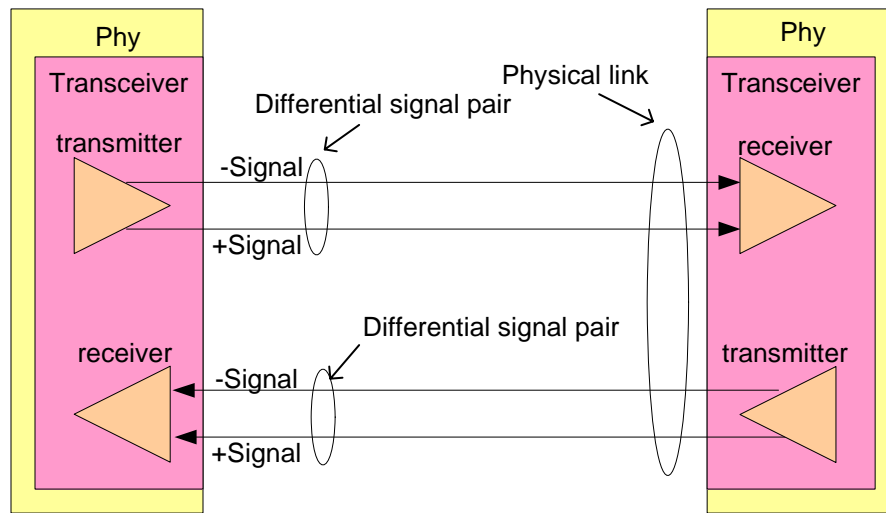

Figure 11 — Physical links and phys

An attached phy is the phy to which a phy is attached over a physical link.

A device (i.e., a SAS device (see 4.1.6) or expander device (see 4.1.7)) contains one or more phys.

Each phy has:

- a SAS address (see 4.2.2), inherited from the SAS port (see 4.1.4) or expander device;
- a phy identifier (see 4.2.8) which is unique within the device;
- optionally, support for being an SSP initiator phy;
- optionally, support for being an STP initiator phy;
- optionally, support for being an SMP initiator phy;
- optionally, support for being an SSP target phy;
- optionally, support for being an STP target phy; and
- optionally, support for being an SMP target phy.

A phy may be used as one or two logical phys based on multiplexing (see 6.10).

During the identification sequence (see 7.9), a logical phy:

- transmits an IDENTIFY address frame including the device type (i.e., end device or expander device) of the device containing the phy, the SAS address of the SAS port or expander device containing the logical phy, and other information; and
- receives an IDENTIFY address frame containing the same set of information from the attached logical phy, including the attached device type, the attached SAS address, the attached device name, and other attached information.

The transceiver follows the electrical specifications defined in 5.3. Phys transmit and receive bits at physical link rates defined in 5.3. The physical link rates supported by a phy are specified or indicated by the following fields in the SMP DISCOVER response (see 10.4.3.10), the SMP PHY CONTROL request (see 10.4.3.28), and the Phy Control and Discover mode page (see 10.2.7.5):

- the NEGOTIATED PHYSICAL LINK RATE field;
- the HARDWARE MINIMUM PHYSICAL LINK RATE field;
- the HARDWARE MAXIMUM PHYSICAL LINK RATE field;
- the PROGRAMMED MINIMUM PHYSICAL LINK RATE field; and
- the PROGRAMMED MAXIMUM PHYSICAL LINK RATE field.

The bits are part of dwords (see 6.2.1), each of which has been encoded using 8b10b coding into four 10-bit characters (see 6.2).

Author: RElliott
Subject: Underline
Date: 6/30/2008 6:16:52 PM

TACCEPT - DONE

The bits are part of dwords (see 6.2.1), each of which has been encoded using 8b10b coding into four 10-bit characters (see 6.2).

s/b

The bits are parts of 10-bit characters (see 6.3), which are parts of dwords (see 6.4).

Figure 12 defines the Phy classes, showing the relationships between the following classes:

- a) Phy;
- b) Logical Phy;
- c) SAS phy;
- d) Logical SAS Phy;
- e) Expander Phy;
- f) Logical Expander Phy;
- g) SAS Initiator Phy;
- h) SAS Target Phy;
- i) SSP Phy;
- j) STP Phy; and
- k) SMP Phy.

SATA phys are also referenced in this standard but are defined by SATA (see SATA-2).

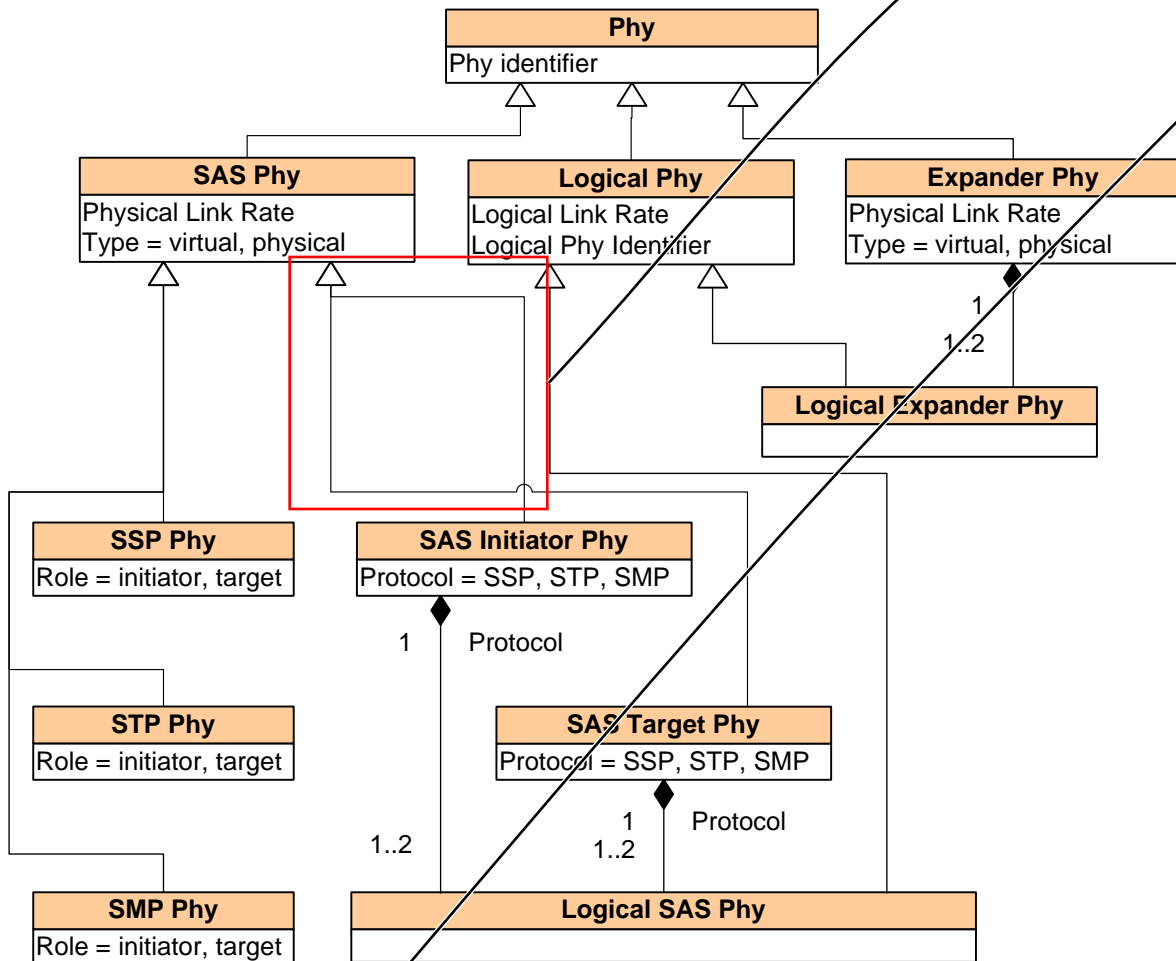



Figure 12 — Phy class diagram

Figure 13 shows example objects instantiated from the SAS Phy class, including:

- a) SSP initiator phy;
- b) SSP target phy;
- c) virtual SMP initiator phy;
- d) virtual SMP target phy;
- e) STP initiator phy;
- f) logical SAS phy.

● Author: Isi-gpenokie
Subject: Rectangle
Date: 5/25/2008 6:36:54 PM
 ACCEPT - DONE

This should be fixed so the line merge with no hop.

● Author: RElliott
Subject: Highlight
Date: 7/9/2008 9:59:38 AM
 ACCEPT - DONE

,
s/b
;

(from Ralph Weber, ENDL)

A SAS phy is represented by one of these objects during each connection. A SAS phy may be represented by different phy objects in different connections.

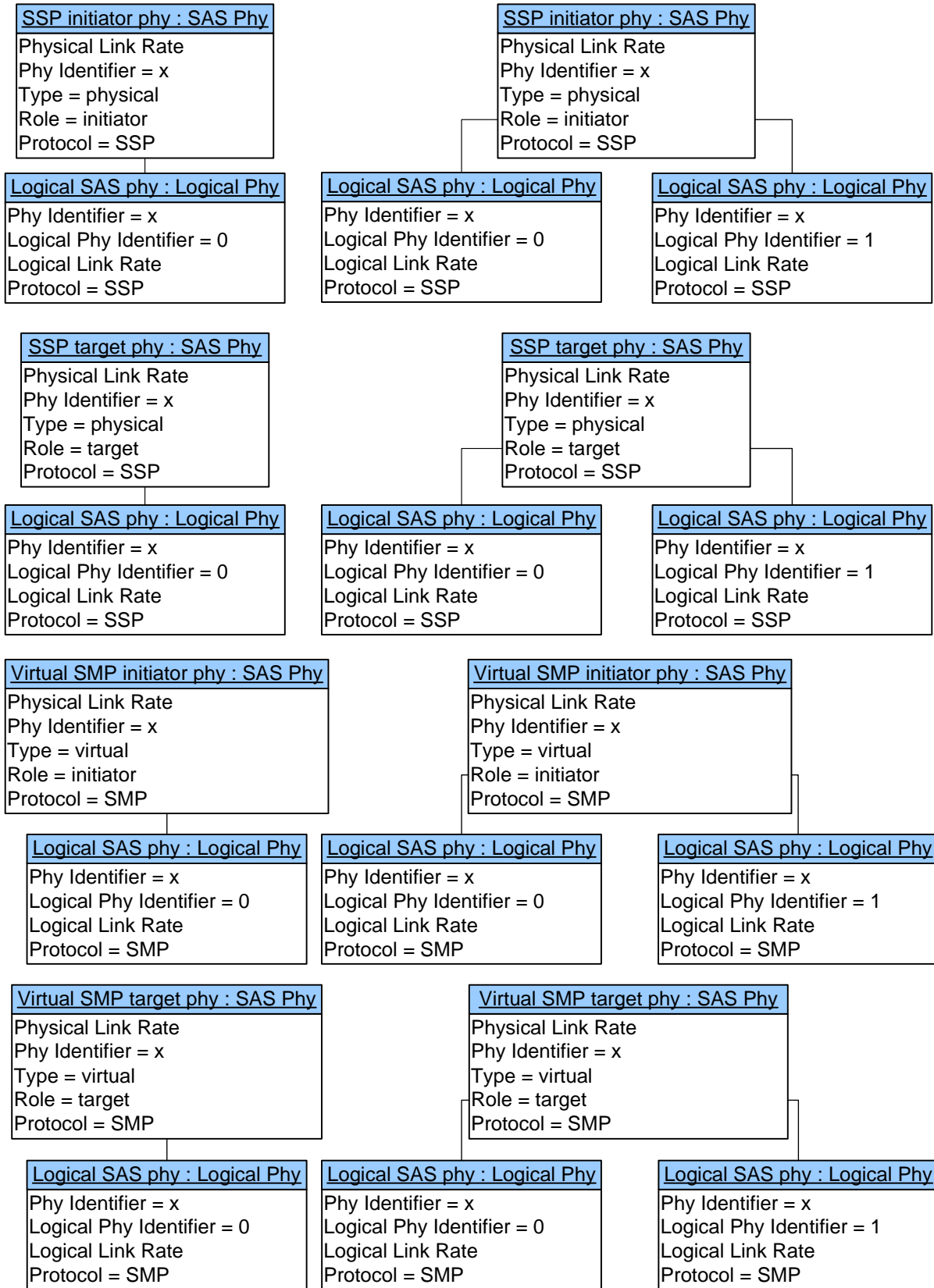

Figure 13 — SAS phy object diagram

This page contains no comments

Figure 3 shows the objects instantiated from the Expander Phy class, including:

- a) expander phy;
- b) virtual expander phy; and
- c) logical expander phy.

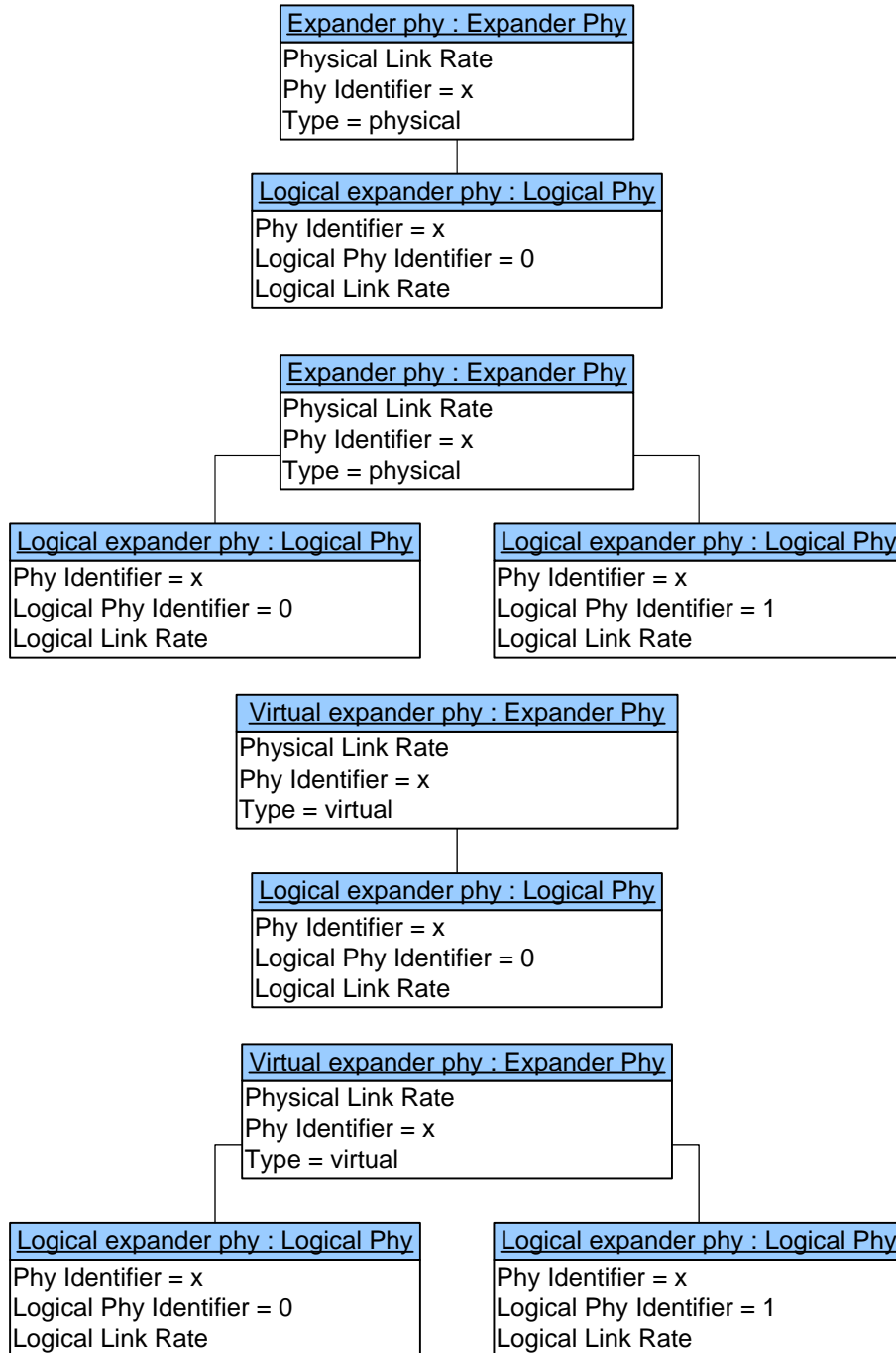

Figure 14 — Expander phy object diagram

This page contains no comments

4.1.3 Logical links

A physical link with a physical link rate greater than 1.5 Gbps may be multiplexed into two logical links as defined in table 6.

Table 6 — Logical links

Physical link rate	Logical link(s)
6 Gbps	One 6 Gbps logical link
	Two 3 Gbps logical links
3 Gbps	One 3 Gbps logical link
	Two 1.5 Gbps logical links
1.5 Gbps	One 1.5 Gbps logical link

Multiplexing is defined in 6.10.

4.1.4 Ports (narrow ports and wide ports)

A port contains one or more phys. Ports in a device are associated with physical phys based on the identification sequence (see 7.9). Ports are associated with virtual phys based on the design of the device.

A port is created from one or more physical phys if, during the identification sequence (see 7.9), they:

- transmitted the same SAS address (see 4.2) that the other physical phys in that port also transmitted in their outgoing IDENTIFY address frames (i.e., the SAS address is the same); and
- received the same SAS address that the other physical phys in that port also received in their incoming IDENTIFY address frames (i.e., the attached SAS address is the same).

A port is a wide port if there are more than one phy in the port. A port is a narrow port if there is only one phy in the port.

A wide link is the set of physical links that attach a wide port to another wide port. A narrow link is the physical link that attaches a narrow port to another narrow port.

Attaching phys within a wide port to other phys in the same wide port (i.e., the SAS address transmitted in the outgoing IDENTIFY address frame is the same as the SAS address received in the incoming IDENTIFY address frame) is outside the scope of this standard.

Phys that are able to become part of the same wide port shall set the DEVICE TYPE field, BREAK_REPLY CAPABLE bit, SSP INITIATOR PORT bit, STP INITIATOR PORT bit, SMP INITIATOR PORT bit, SSP TARGET PORT bit, STP TARGET PORT bit, SMP TARGET PORT bit, and SAS ADDRESS field in the IDENTIFY address frame (see 7.8.2) transmitted during the identification sequence to the same set of values on each phy in the wide port. Recipient wide ports are not required to check the consistency of these fields across their phys.

Page: 40

● Author: elx-bmartin
Subject: Highlight
Date: 5/25/2008 5:43:07 PM

T ACCEPT - DONE
are
s.b.
is

● Author: lsi-bday
Subject: Highlight
Date: 5/25/2008 5:43:00 PM

T ACCEPT - DONE
are
s/b
is

● Author: wdc-mevans
Subject: Highlight
Date: 5/25/2008 5:41:35 PM

T ACCEPT - DONE (you read what on the Internet? "it" is totally unclear based on other comments :-))

there are more than one
s/b
there is more than one
[I read it on the internet.]

● Author: elx-bmartin
Subject: Highlight
Date: 5/25/2008 5:42:30 PM

T ACCEPT - DONE ("Attaching a phy within a wide port to another phy in the same port")
wide

why is this only for wide ports shouldn't this be for wide or narrow? If removing this wide, remove the next wide in this sentence.

● Author: RElliott
Subject: Highlight
Date: 6/30/2008 6:16:52 PM

T ACCEPT - DONE

bit,

add "the" several times in this paragraph

Figure 15 shows examples of narrow ports and wide ports, with a representation of the SAS address transmitted during the identification sequence. Although several phys on the left transmit SAS addresses of B, only phys attached to the same SAS addresses become part of the same ports. The set of phys with SAS address B attached to the set of phys with SAS address Y become one port, while the set of phys with SAS address B attached to the set of phys with SAS address Z become another port.

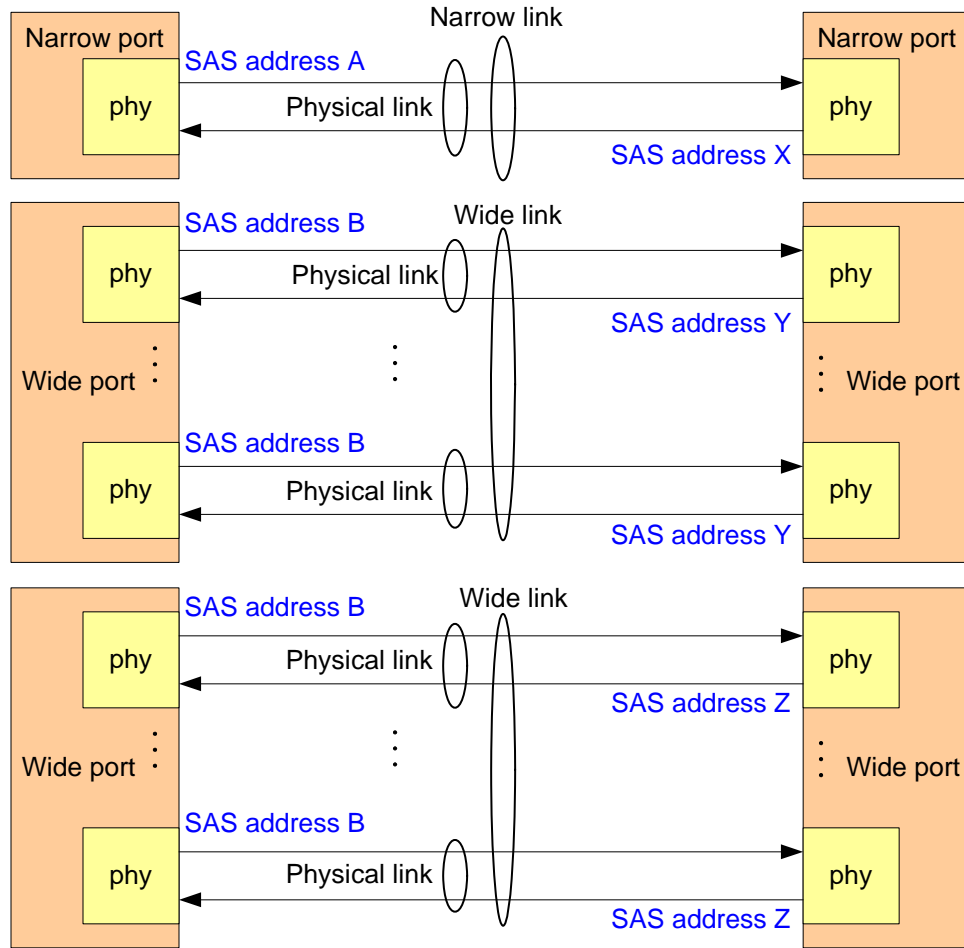

Each horizontal line represents a differential signal pair

Figure 15 — Ports (narrow ports and wide ports)

In figures in this standard that show ports but not phys, the phy level of detail is not shown; however, each port always contains one or more phys.

Figure 16 defines the Port classes, showing the relationships between the following classes:

- a) Port;
- b) Expander Port;
- c) SAS Port;
- d) SAS Initiator Port;
- e) SAS Target Port;
- f) SSP Port;
- g) STP Port; and
- h) SMP Port.

Author: Isi-gpenokie

Subject: Highlight

Date: 5/17/2008 2:24:59 PM

TREJECT (joining them with a semicolon strengthens the fact that this is still discussing the subset of "figures in this standard that show ports but not phys")

Should be << detail is not shown. However, each port

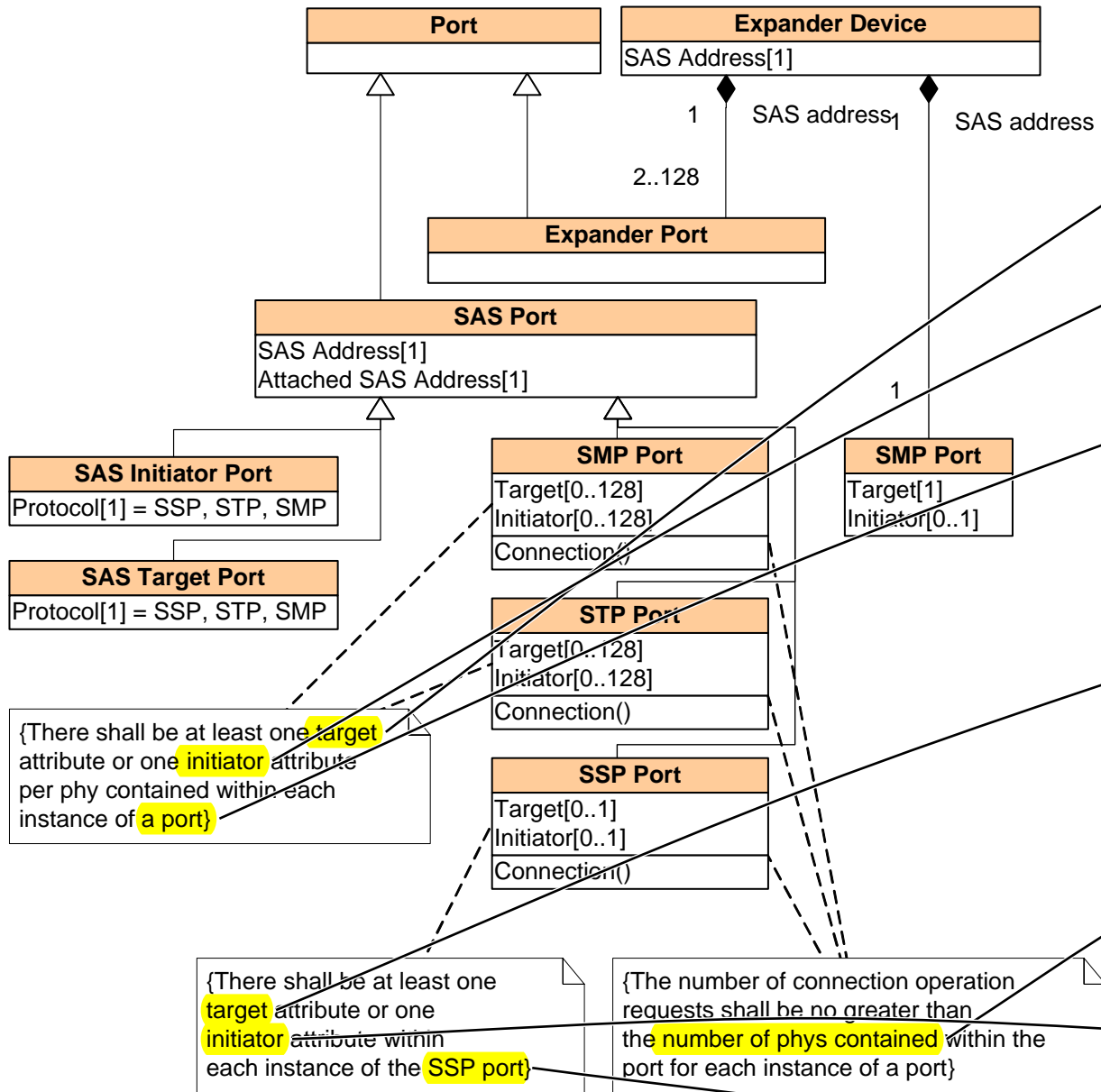

Figure 16 — Port class diagram

Figure 17 shows the objects instantiated from the Port classes:

- a) SAS Target Port class (i.e., SSP target port, STP target port, SMP target port);
- b) SAS Initiator Port class (i.e., SSP initiator port, STP initiator port, SMP initiator port);
- c) STP Port class (i.e., STP initiator port, STP target port, STP port);
- d) SMP Port class (i.e., SMP initiator port, SMP target port, SMP port);
- e) SSP Port class (i.e., SSP initiator port, SSP target port, SSP port);
- f) Expander Device SMP Port class (i.e., SMP target port, SMP port); and
- g) Expander Port class (i.e., expander port).

● Author: RElliott
Subject: Highlight
Date: 6/30/2008 6:16:52 PM
T ACCEPT - DONE
target s/b Target

● Author: RElliott
Subject: Highlight
Date: 6/30/2008 6:16:52 PM
T ACCEPT - DONE
initiator s/b Initiator

● Author: RElliott
Subject: Highlight
Date: 6/30/2008 6:16:52 PM
T ACCEPT - DONE
a port

Since this constraint is on the SMP Port and STP Port classes, not the Port class, this word should be "an SMP Port" or "an STP Port". Split the constraint into two so they can be distinguished.

● Author: RElliott
Subject: Highlight
Date: 6/30/2008 6:16:52 PM
T ACCEPT - DONE
target
s/b
Target

● Author: ktek-dmoore
Subject: Highlight
Date: 5/25/2008 5:43:30 PM
T ACCEPT - DONE (deleting this constraint altogether. The Connection() operation is not defined anywhere and doesn't seem necessary here.)
number of phys contained
Is it necessary to indicate logical?

● Author: RElliott
Subject: Highlight
Date: 6/30/2008 6:16:52 PM
T ACCEPT - DONE
initiator s/b Initiator

● Author: RElliott
Subject: Highlight
Date: 6/30/2008 6:16:52 PM
T ACCEPT - DONE
SSP port s/b SSP Port

Port objects remain instantiated even when no connection is open on any of the phys within the port.

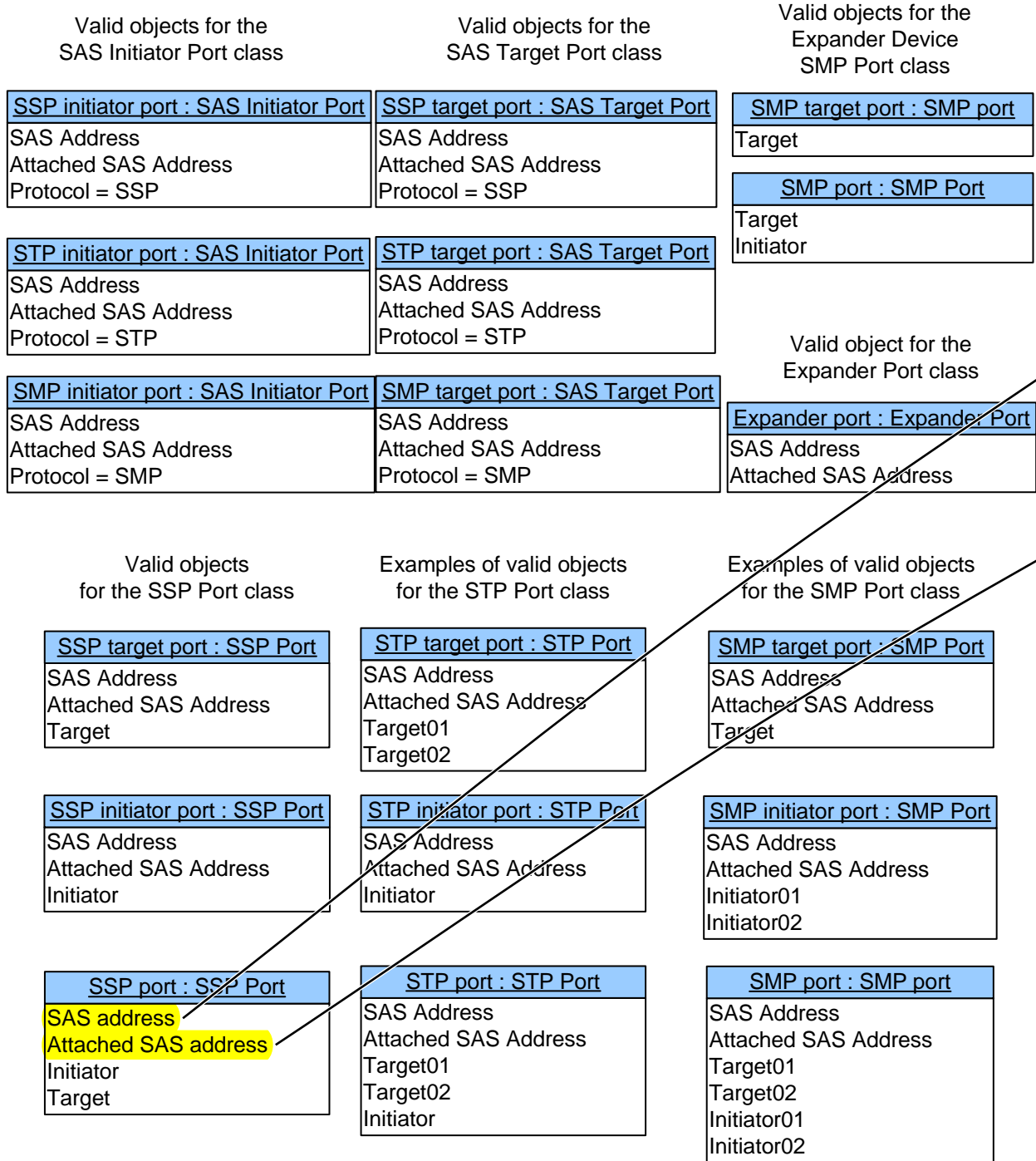

Figure 17 — Port object diagram

4.1.5 Application clients and device servers

This standard defines the following application clients:

- a) a SCSI application client (see SAM-4) is the source of SCSI commands and task management function requests. A SCSI application client uses an SSP initiator port to interface to a service delivery subsystem;

● Author: RElliott
Subject: Highlight
Date: 6/30/2008 6:16:52 PM
T ACCEPT - DONE

when
s/b
while

● Author: RElliott
Subject: Highlight
Date: 6/30/2008 6:16:52 PM
T ACCEPT - DONE

SAS address
s/b
SAS Address

● Author: RElliott
Subject: Highlight
Date: 6/30/2008 6:16:52 PM
T ACCEPT - DONE

Attached SAS address
s/b
Attached SAS Address

- b) an ATA application client (see ATA8-AAM) is the source of ATA commands and device management operation requests. An ATA application client uses an STP initiator port to interface to a service delivery subsystem; and
- c) a management application client is the source of management function requests. A management application client uses an SMP initiator port to interface to a service delivery subsystem.

This standard defines the following device servers:

- a) a SCSI device server (see SAM-4) processes SCSI commands. A SCSI device server uses an SSP target port to interface to a service delivery subsystem;
- b) an ATA device server (see ATA8-AAM) processes ATA commands. An device server uses an STP target port to interface to a service delivery subsystem; and
- c) a management device server processes management functions. A management device server uses an SMP target port to interface to a service delivery subsystem;



4.1.6 SAS devices

A SAS device contains one or more SAS ports, each containing one or more phys (i.e., a SAS port may be a narrow port or a wide port).

Figure 18 shows examples of SAS devices with different port and phy configurations.

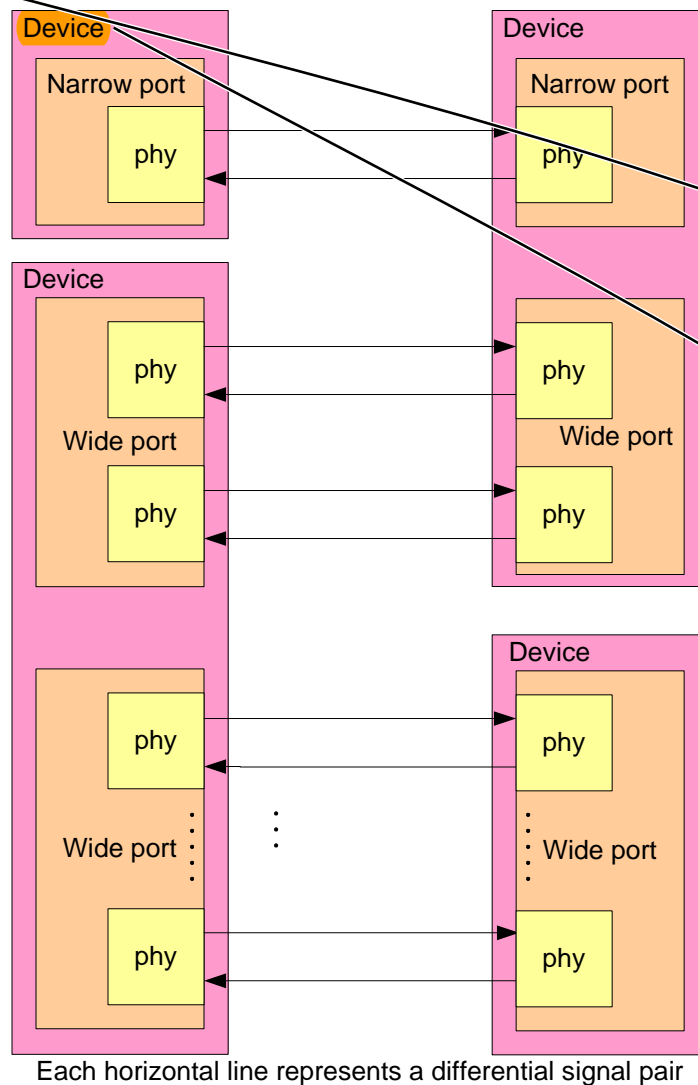



Figure 18 — SAS devices

Page: 44

Author: elx-bmartin
Subject: Highlight
Date: 5/6/2008 4:07:48 PM
 ACCEPT - DONE

An device

s.b.

An ATA device

Author: RElliott
Subject: Highlight
Date: 6/30/2008 6:16:52 PM
 ACCEPT - DONE

;
s/b
.

Author: RElliott
Subject: Note
Date: 6/30/2008 6:16:52 PM
 ACCEPT - DONE

Add

A SCSI to ATA translation layer (see SAT-2) may be implemented to enable SCSI application clients to communicate with ATA devices.

per lsi-bbesmer comment in 2.3

Author: stx-ghoulder
Subject: Highlight
Date: 5/25/2008 5:44:19 PM



 REJECT (figure 18 shows devices, while figure 15 limits itself to ports. In some sense the phys could be removed from this figure to avoid including multiple levels of hierarchy, but that would be less useful.)

Figure 18 shows

Figure 18 is the same as figure 15 except that it shows less detail in some respects. Why can't this figure be deleted and the reference changed to figure 15?

Author: RElliott
Subject: Highlight
Date: 6/30/2008 6:16:52 PM
 ACCEPT - DONE

Device

s/b

SAS device

4 times in figure 18

An end device is a SAS device that is not contained in an expander device (see 4.1.7).

4.1.7 Expander devices

Expander devices are part of a service delivery subsystem and facilitate communication between multiple SAS devices. Expander devices contain two or more external expander ports. Each expander device contains one SMP target port and one management device server, contains one SMP initiator port and one management application client if it is self-configuring and may contain one SMP initiator port and one management application client if it is not self-configuring, and may contain SAS devices (e.g., an expander device may include an SSP target port for access to a logical unit with a peripheral device type set to 0Dh (i.e., enclosure services device) (see SPC-4 and SES-2)).

Figure 19 shows an expander device.

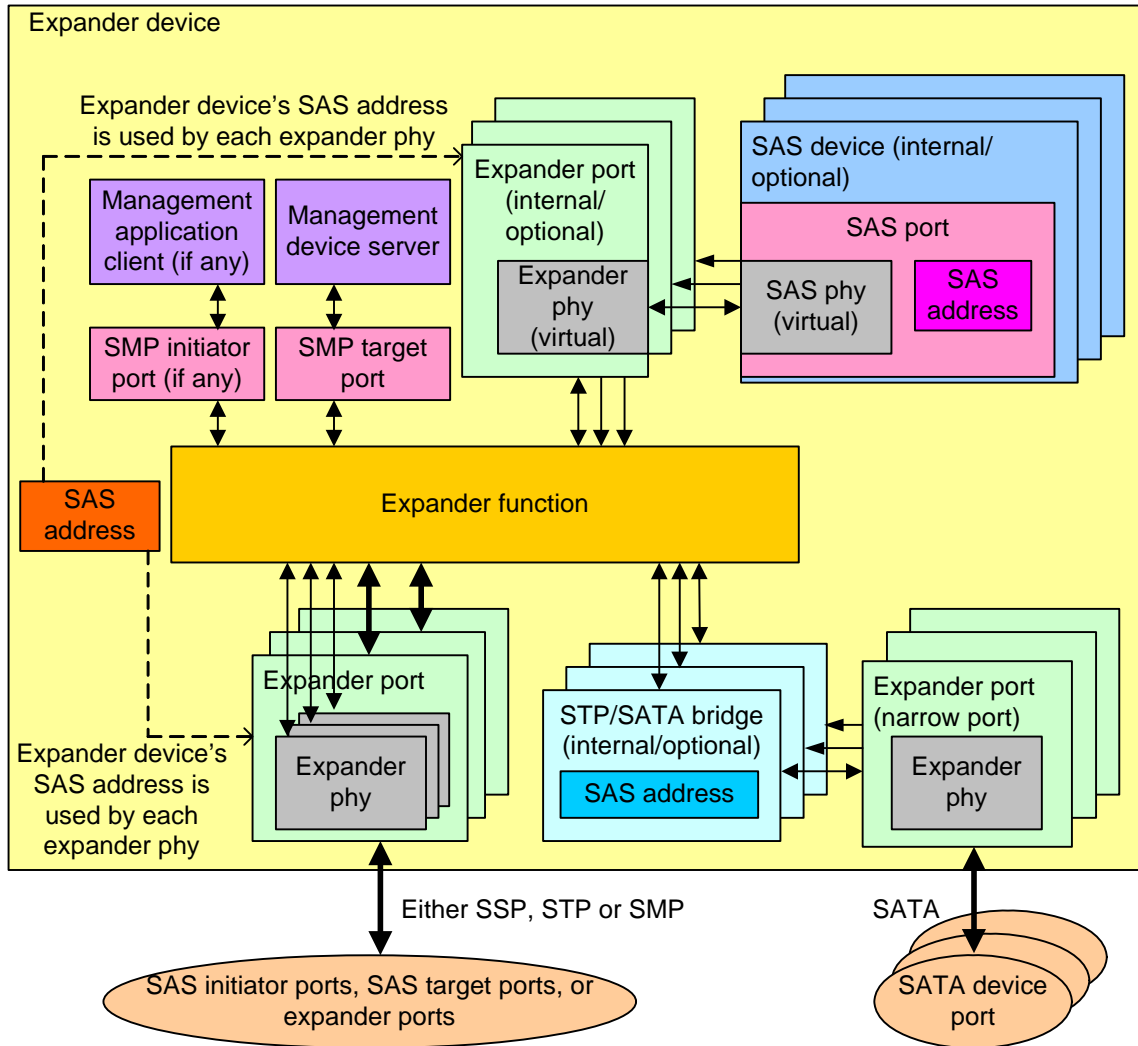

Figure 19 — Expander device

See 4.6 for a detailed model of an expander device.

Author: elx-bmartin
Subject: Highlight
Date: 5/8/2008 6:25:03 PM

T ACCEPT - DONE (changing "it" per Mark's comment)

Each expander device contains one SMP target port and one management device server, contains one SMP initiator port and one management application client if it is self-configuring and may contain one SMP initiator port and one management application client if it is not self-configuring, and may contain SAS devices (e.g., an expander device may include an SSP target port for access to a logical unit with a peripheral device type set to 0Dh (i.e., enclosure services device) (see SPC-4 and SES-2)).

Make this an a) b) list

Each expander device:

- a) contains one SMP target port and one management device server;
- b) contains one SMP initiator port and one management application client if it is self-configuring;
- c) may contain one SMP initiator port and one management application client if it is not self-configuring; and
- d) may contain SAS devices (e.g., an expander device may include an SSP target port for access to a logical unit with a peripheral device type set to 0Dh (i.e., enclosure services device) (see SPC-4 and SES-2)).

Author: wdc-mevans
Subject: Highlight
Date: 5/25/2008 5:45:47 PM

T ACCEPT - DONE

Each expander device contains one SMP target port and one management device server, contains one SMP initiator port and one management application client if it is self-configuring and may contain one SMP initiator port and one management application client if it is not self-configuring, and may contain SAS devices (e.g., an expander device may include an SSP target port for access to a logical unit with a peripheral device type set to 0Dh (i.e., enclosure services device) (see SPC-4 and SES-2)).

s/b

Each expander device:

- a) contains one SMP target port and one management device server;
 - b) contains one SMP initiator port and one management application client, if the expander device is self-configuring;
 - c) may contain one SMP initiator port and one management application client, if the expander device is not self-configuring; and
 - d) may contain SAS devices (e.g., an expander device may include an SSP target port for access to a logical unit with a peripheral device type set to 0Dh (i.e., enclosure services device) (see SPC-4 and SES-2)).
-

Figure 20 defines the Expander Device class.

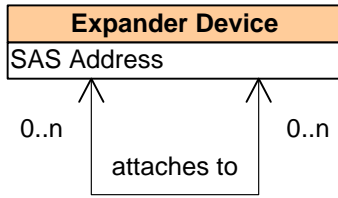

Figure 20 — Expander Device class diagram

Each expander phy has one of the following routing attributes (see 4.6.7.1):

- a) direct routing attribute;
- b) table routing attribute; or
- c) subtractive routing attribute.

Expander devices **with** expander phys with the table routing attribute **contain** an expander route table (see 4.6.7.3). An externally configurable expander device depends on a management application client within the SAS domain to use the discover process (see 4.7) and the configuration subprocess (see 4.8) to configure the expander route table. A self-configuring expander device contains a management application client and an SMP initiator port to perform the discover process (see 4.7) to configure its own expander route table.

4.1.8 Service delivery subsystem

A service delivery subsystem is either:

- a) a set of physical links between a SAS initiator port and a SAS target port; or
- b) a set of physical links and expander devices, supporting more than two SAS ports.

See 4.1.10 for rules on constructing service delivery subsystems from multiple expander devices.

4.1.9 Domains

Figure 21 shows examples of SAS domains and ATA domains.

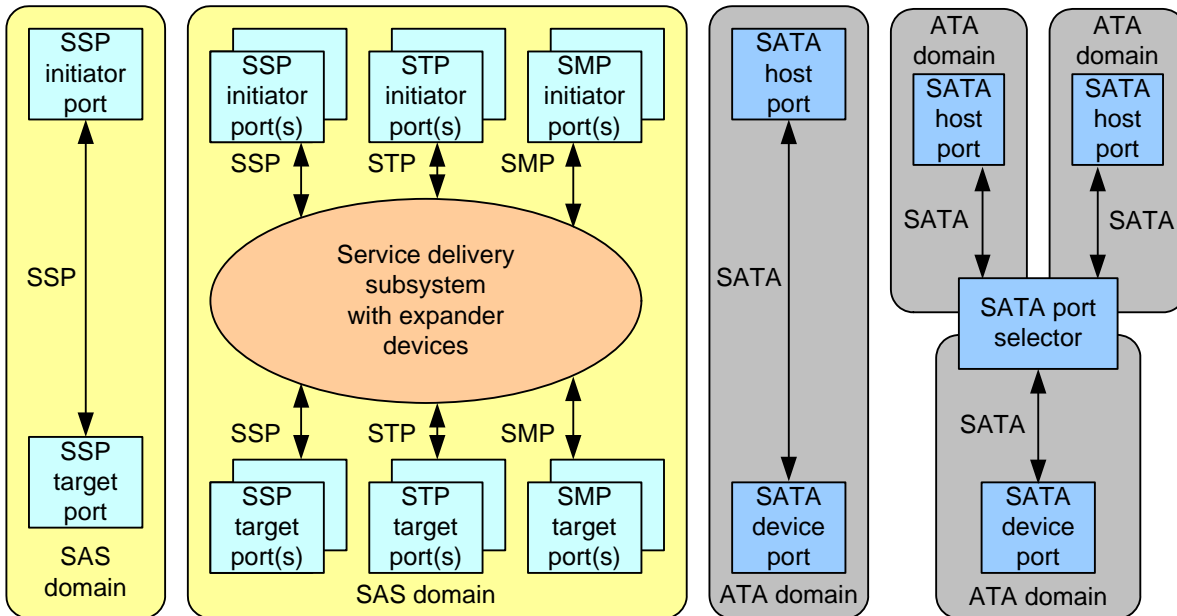

Note: When expander devices are present, SAS target ports may be located in SAS devices contained in expander devices.

Figure 21 — Domains

● Author: RElliott
Subject: Cross-Out
Date: 6/30/2008 6:16:52 PM
 ACCEPT - DONE

Delete Figure 20 — Expander Device class diagram

This is not useful any more, now that fanout/edge expanders are gone. There is no "attaches to" link shown for SAS Devices in any other figure, so there is no need to show that for Expander Devices.

● Author: wdc-mevans
Subject: Highlight
Date: 5/25/2008 5:46:19 PM
 ACCEPT - DONE

contain
s/b
also contain

● Author: wdc-mevans
Subject: Highlight
Date: 5/25/2008 5:46:09 PM
 ACCEPT - DONE

with
s/b
containing

Figure 22 shows a SAS domain bridging to one or more ATA domains.

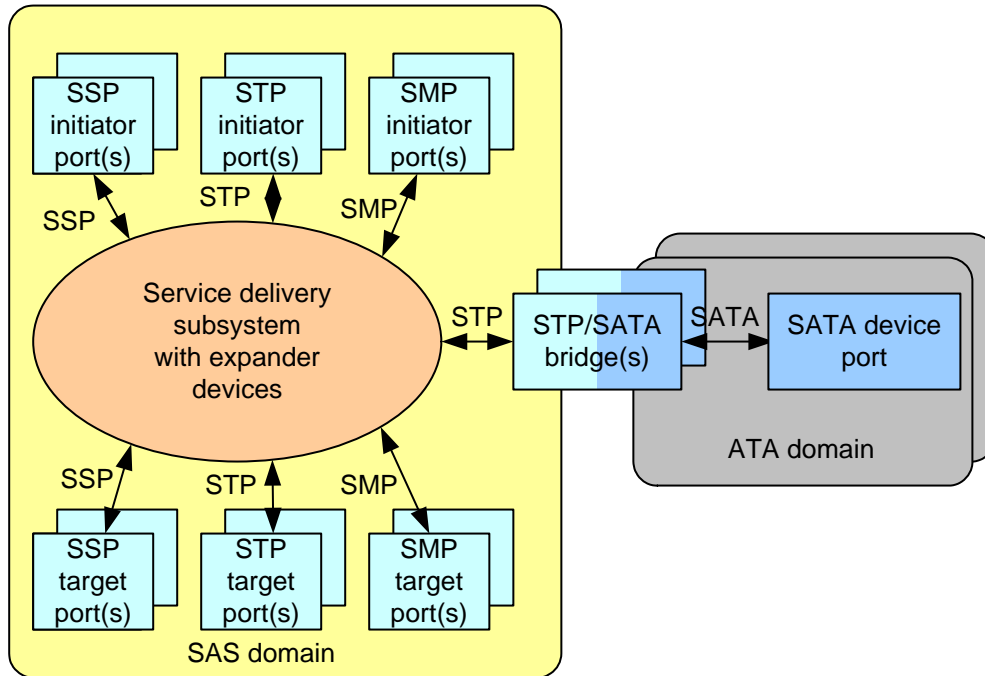

Figure 22 — SAS domain bridging to ATA domains

This page contains no comments

Figure 23 shows two SAS domains bridging to one or more ATA domains containing SATA devices with SATA port selectors.

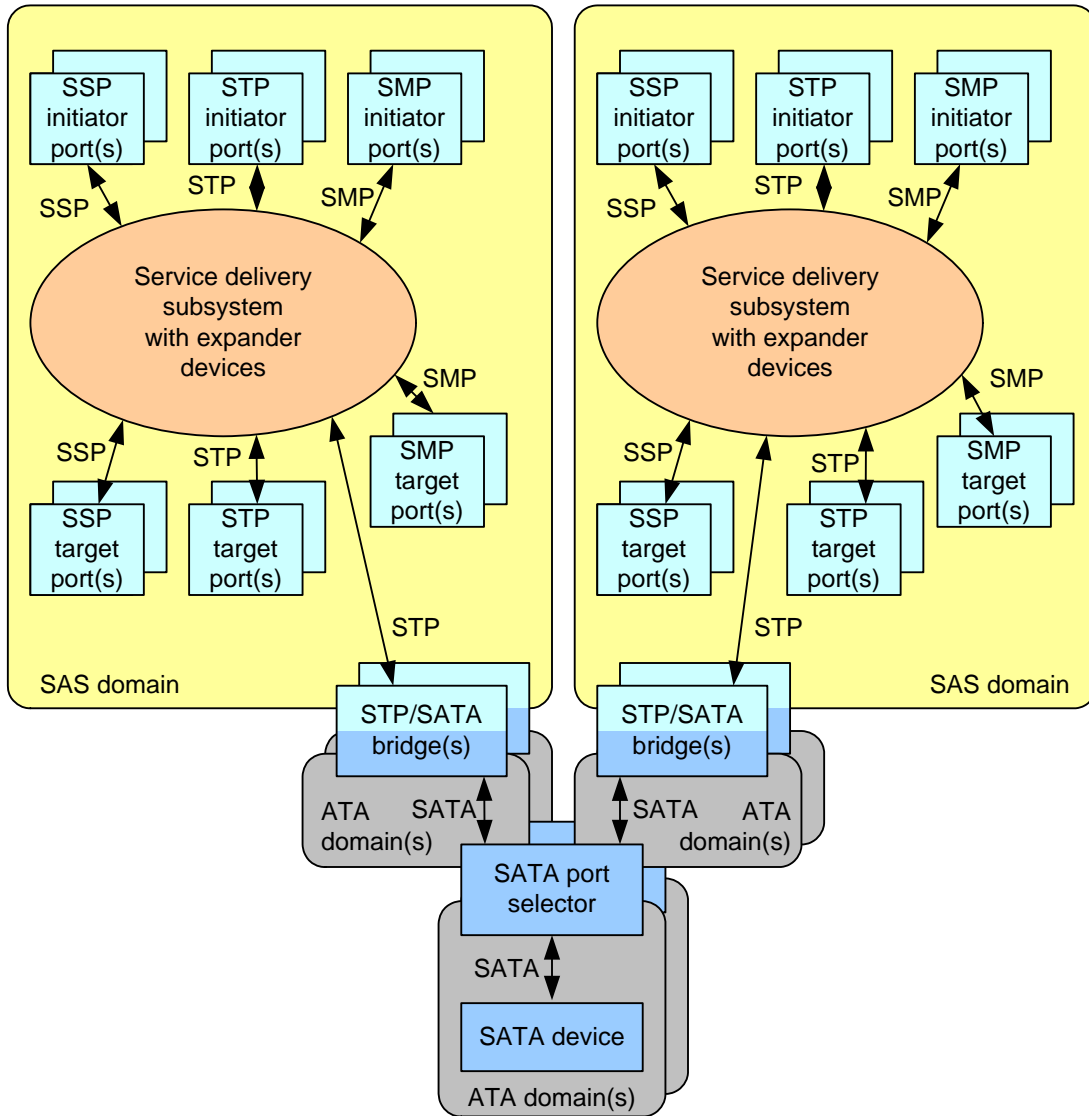

Figure 23 — SAS domains bridging to ATA domains with SATA port selectors

This page contains no comments

Figure 24 shows SAS initiator devices and SAS target devices with SAS ports in the same SAS domains and in different SAS domains. When a SAS device has ports in different SAS domains, the ports may have the same SAS address (see 4.2); when its ports are in the same SAS domain, they shall have different SAS addresses.

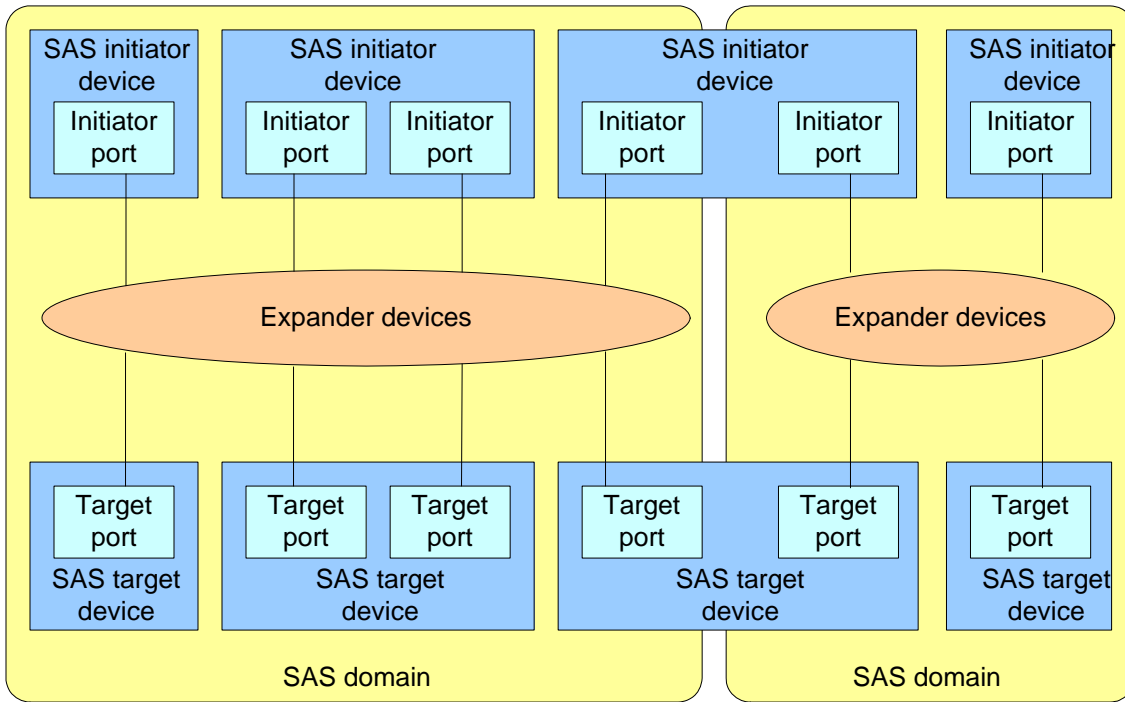

Figure 24 — Devices spanning SAS domains

4.1.10 Expander device topologies

4.1.10.1 Expander device topology overview

More than one expander device may be part of a service delivery subsystem.

To avoid an overflow of an expander route index during the configuration subprocess (see 4.8), a SAS domain containing an externally configurable expander device shall be constructed such that the number of expander route indexes available for each expander phy with the table routing attribute is greater than or equal to the number of SAS addresses addressable through that expander phy.

4.1.10.2 Expander device topologies

Figure 25 shows an example of an expander topology with one expander device.

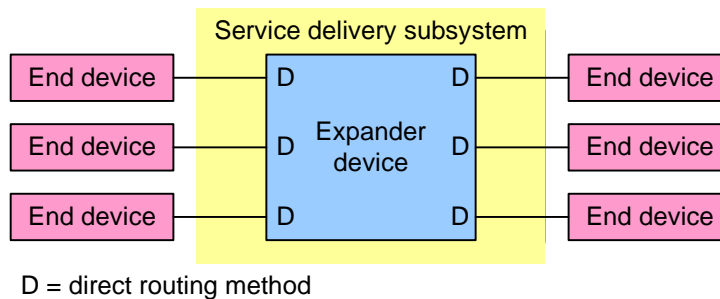

Figure 25 — Single expander device topology example

This page contains no comments

Figure 26 shows examples of expander topologies with multiple expander devices.

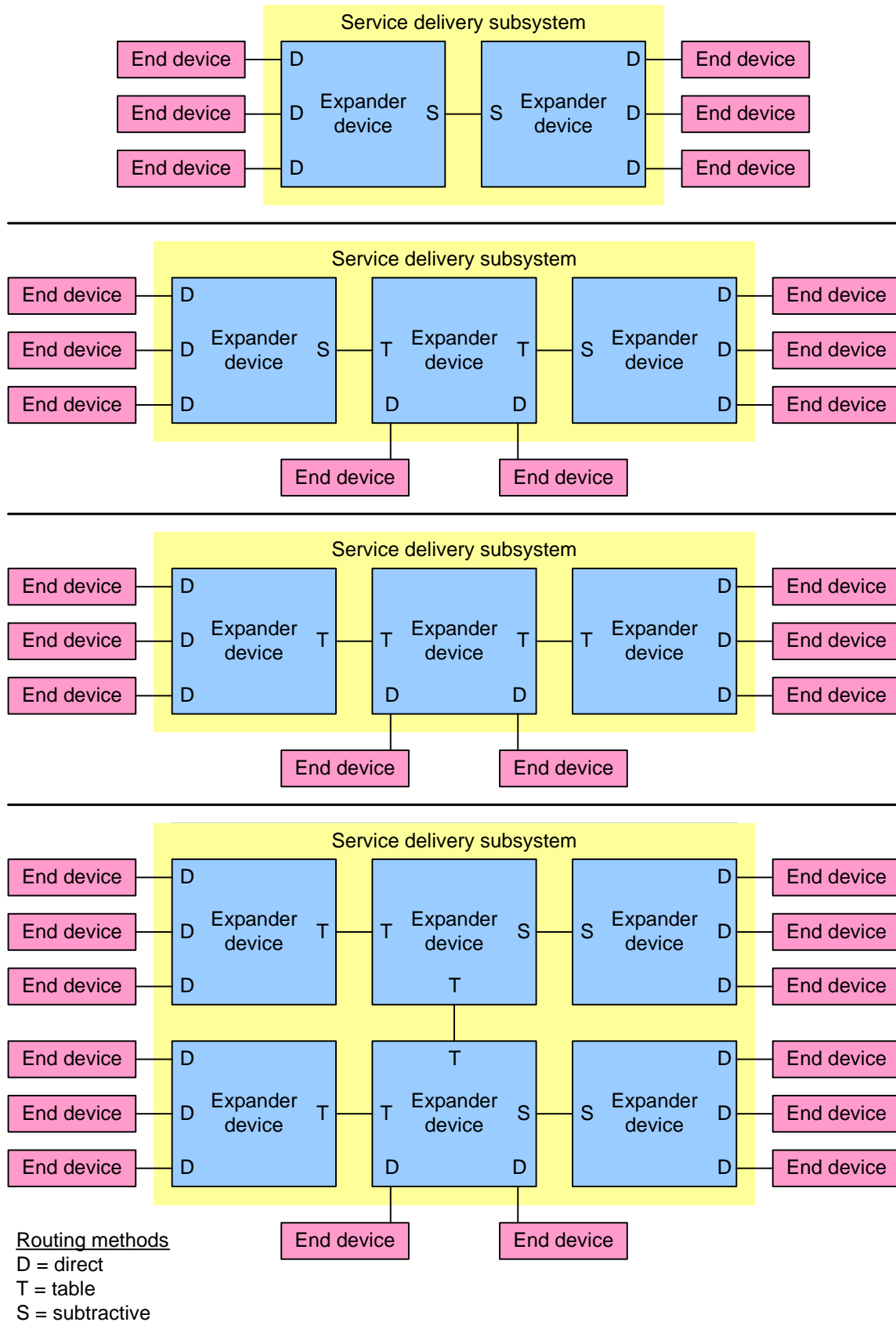

Figure 26 — Multiple expander device topologies

This page contains no comments

4.1.11 Pathways

A potential pathway is a set of logical links between a SAS initiator phy and a SAS target phy. When a SAS initiator phy is directly attached to a SAS target phy with a non-multiplexed physical link, there is one potential pathway. When the physical link is multiplexed or there are expander devices between a SAS initiator phy and a SAS target phy, it is possible that there is more than one potential pathway, each consisting of a set of logical links between the SAS initiator phy and the SAS target phy. The physical links may or may not be using the same physical link rate.

A pathway is a set of logical links between a SAS initiator phy and a SAS target phy being used by a connection (see 4.1.12).

Figure 27 shows examples of potential pathways.

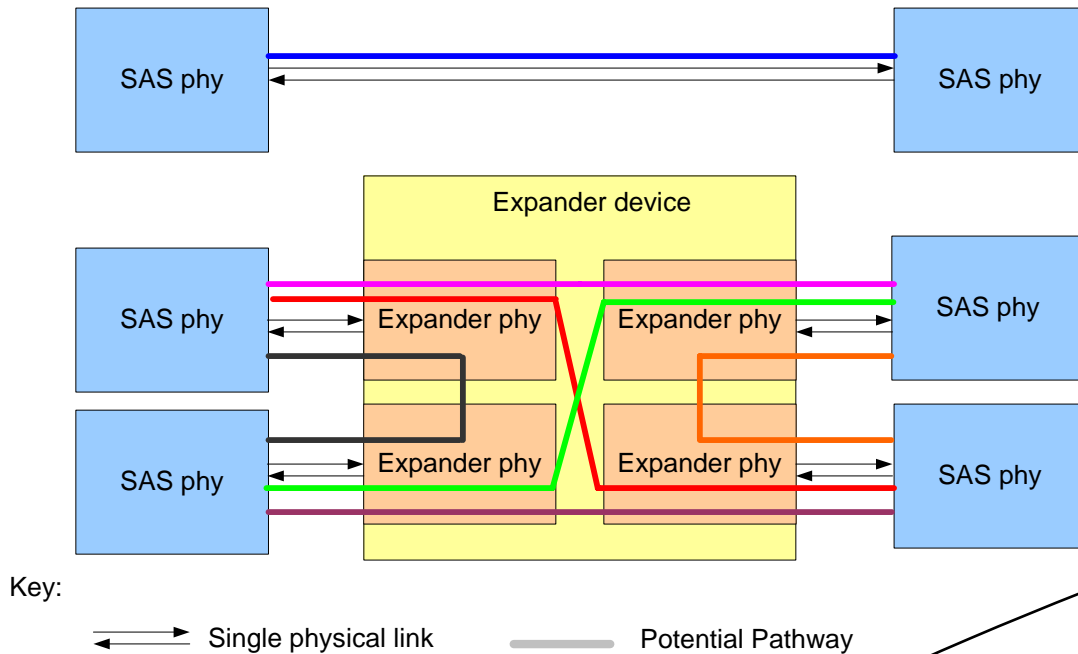

Figure 27 — Potential pathways

A partial pathway is the set of logical links participating in a connection request that have not yet conveyed a connection response (see 7.12).

A partial pathway is blocked when path resources it requires are held by another partial pathway (see 7.12).

4.1.12 Connections

A connection is a temporary association between a SAS initiator phy and a SAS target phy. During a connection all dwords from the SAS initiator phy are forwarded to the SAS target phy, and all dwords from the SAS target phy are forwarded to the SAS initiator phy.

A connection is pending when an OPEN address frame has been delivered along a completed pathway to the destination phy but the destination phy has not yet responded to the connection request. A connection is established when an OPEN_ACCEPT is received by the source phy.

A connection enables communication for one protocol: SSP, STP, or SMP. For SSP and STP, connections may be opened and closed multiple times during the processing of a command (see 7.12).

The connection rate is the effective rate of dwords through the pathway between a SAS initiator phy and a SAS target phy, established through the connection request. Every logical phy shall support a 1.5 Gbps connection rate regardless of its logical link rate.

No more than one connection is active on a logical link at a time. If the connection is an SSP or SMP connection and there are no dwords to transmit associated with that connection, idle dwords are transmitted.

Author: wdc-mevans

Subject: Highlight

Date: 6/3/2008 7:05:57 PM

T REJECT (There are 22 uses of "directly." Both "directly attached" and "attached directly" appear. Arguably, some of them could be dropped. However, some of them provide emphasis that they're discussing devices directly attached vs attached behind some (other) expander. I'm inclined to leave them alone.)

Global

directly attached to a SAS target phy with a non-multiplexed physical link

s/b

attached to a SAS target phy via a non-multiplexed physical link (i.e., without any expander devices in the service delivery subsystem)

[It might be best to put "directly attached" in the definitions clause. These terms are used often, and never clearly defined.]

Author: lsi-bbesmer

Subject: Highlight

Date: 5/25/2008 5:48:07 PM

T REJECT (waiting on a fully established connection is not considered "blocked" - that's only for partials waiting on partials)

another partial pathway

s/b

another pathway or partial pathway

or perhaps

another connection or partial pathway

Author: RElliott

Subject: Highlight

Date: 6/30/2008 6:16:52 PM

T ACCEPT - DONE

it

s/b

that it

Author: lsi-bday

Subject: Highlight

Date: 8/27/2008 6:44:05 PM

T ACCEPT - DONE (yes - ", all dwords... that are not deletable primitives", twice in the sentence)

dwords

Does this sentence need a small caveat to allow for deletable primitives to not be forwarded?

Author: lsi-bbesmer

Subject: Highlight

Date: 6/3/2008 7:24:50 PM

T ACCEPT - DONE (" , all non-deletable dwords")

Not all dwords are necessarily forwarded (ie. all Deletable Primitives, Broadcast Primitives, etc).

Author: wdc-mevans

Subject: Highlight

Date: 5/25/2008 5:48:28 PM

T REJECT (added sentence instead: "A source phy transmits an OPEN address frame (see 7.8.3) specifying the SAS address of a destination phy to attempt to establish a connection.")

OPEN address frame

s/b

OPEN address frame (see [insert cross reference]) from a phy attempting to establish a connection (i.e., the source phy)

4.1.11 Pathways

A potential pathway is a set of logical links between a SAS initiator phy and a SAS target phy. When a SAS initiator phy is directly attached to a SAS target phy with a non-multiplexed physical link, there is one potential pathway. When the physical link is multiplexed or there are expander devices between a SAS initiator phy and a SAS target phy, it is possible that there is more than one potential pathway, each consisting of a set of logical links between the SAS initiator phy and the SAS target phy. The physical links may or may not be using the same physical link rate.

A pathway is a set of logical links between a SAS initiator phy and a SAS target phy being used by a connection (see 4.1.12).

Figure 27 shows examples of potential pathways.

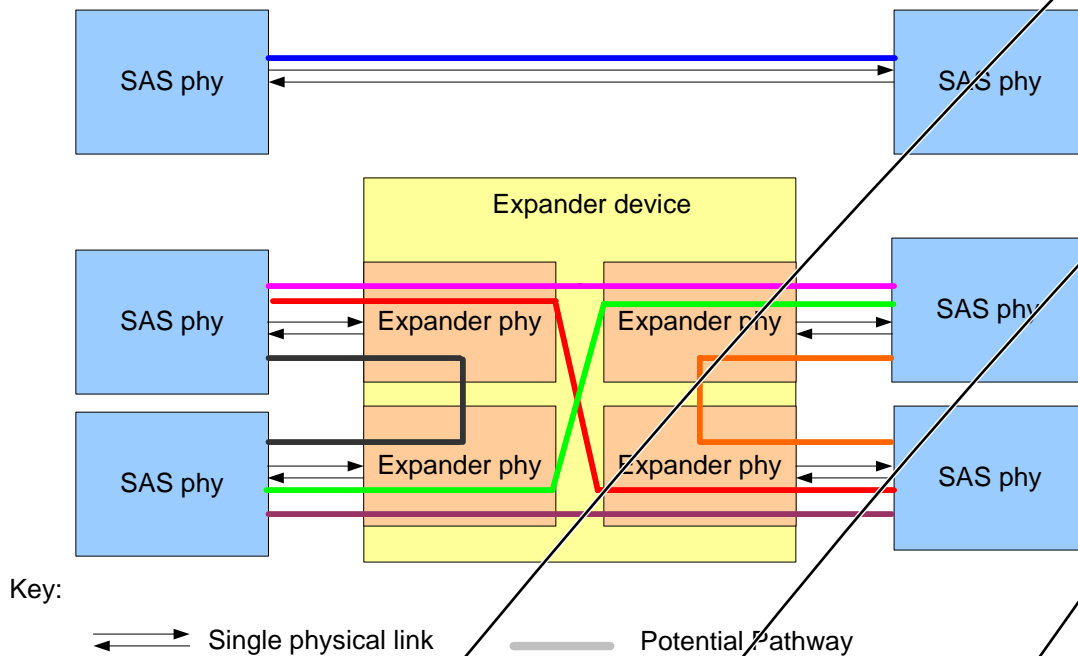

Figure 27 — Potential pathways

A partial pathway is the set of logical links participating in a connection request that have not yet conveyed a connection response (see 7.12).

A partial pathway is blocked when path resources it requires are held by another partial pathway (see 7.12).

4.1.12 Connections

A connection is a temporary association between a SAS initiator phy and a SAS target phy. During a connection all dwords from the SAS initiator phy are forwarded to the SAS target phy, and all dwords from the SAS target phy are forwarded to the SAS initiator phy.

A connection is pending when an OPEN address frame has been delivered along a completed pathway to the destination phy but the destination phy has not yet responded to the connection request. A connection is established when an OPEN_ACCEPT is received by the source phy.

A connection enables communication for one protocol: SSP, STP, or SMP. For SSP and STP, connections may be opened and closed multiple times during the processing of a command (see 7.12).

The connection rate is the effective rate of dwords through the pathway between a SAS initiator phy and a SAS target phy, established through the connection request. Every logical phy shall support a 1.5 Gbps connection rate regardless of its logical link rate.

No more than one connection is active on a logical link at a time. If the connection is an SSP or SMP connection and there are no dwords to transmit associated with that connection, idle dwords are transmitted.

Author: wdc-mevans

Subject: Highlight

Date: 5/25/2008 5:48:54 PM

T REJECT (Added a sentence instead - "A source phy transmits an OPEN address frame (see 7.8.3) specifying the SAS address of a destination phy to attempt to establish a connection.")

destination phy

s/b

phy with which the source phy is attempting to establish a connection (i.e., the destination phy),

Author: wdc-mevans

Subject: Highlight

Date: 5/25/2008 5:48:42 PM

T ACCEPT - DONE (Changed to "when the source phy receives an OPEN_ACCEPT (see 7.x) from the destination phy.")

OPEN_ACCEPT

s/b

OPEN_ACCEPT (see [insert cross reference]) transmitted from the destination phy

Author: wdc-mevans

Subject: Highlight

Date: 5/25/2008 5:49:14 PM

T REJECT (this is section 4.1.12, just a broad introduction to the concept of connections; the details are in chapter 7)

through the connection request.

s/b

during the connection request (i.e., the connection rate value contained in the OPEN address frame)...

Author: lsi-gpenokie

Subject: Highlight

Date: 5/25/2008 5:49:37 PM

T REJECT (Yes, this is still true. This is the connection rate (covered by chapter 7 rate matching), not the physical link rate (covered by chapter 5 physical layer - SAS-2 does still require 1.5 Gbps be supported) or the logical link rate (covered by chapter 6 multiplexing). The connection rate of 1.5 Gbps will probably be required forever.)

Is this still true in SAS-2? Even it is, this does not seem like the correct place to specify it as there a many more words in the physical sections.

If the connection is an STP connection and there are no dwords to transmit associated with that connection, then SATA_SYNCs, SATA_CONTs, or vendor-specific scrambled data dwords are transmitted as defined in SATA-2. If there is no connection on a logical link then idle dwords are transmitted.

The number of connections established by a SAS port shall not exceed the number of SAS logical phys within the SAS port (i.e., only one connection per SAS logical phy is allowed). There shall be a separate connection on each logical link.

If multiple potential pathways exist between the SAS initiator port(s) and the SAS target port(s), multiple connections may be established by a SAS port between the following:

- a) one SAS initiator port to multiple SAS target ports;
- b) one SAS target port to multiple SAS initiator ports; or
- c) one SAS initiator port to one SAS target port.

Once a connection is established, the pathway used for that connection shall not be changed (i.e., all the logical links that make up the pathway remain dedicated to the connection until it is closed).

Figure 28 shows examples of connections between wide and narrow ports. All the connections shown may occur simultaneously. Additionally,

- a) the connections labeled A and B are an example of one SAS initiator port with connections to multiple SAS target ports;
- b) the connections labeled A and C are an example of one SAS target port with connections to multiple SAS initiator ports;
- c) the connections labeled E and F are an example of multiple connections between one SAS initiator port and one SAS target port; and
- d) the connections labeled C, D, E, and F are an example of one SAS initiator port with connections to multiple SAS target ports with one of those SAS target ports having multiple connections with that SAS initiator port.

Page: 52

● Author: RElliott
Subject: Highlight
Date: 6/30/2008 6:16:52 PM

T ACCEPT - DONE
it
s/b
the connection

● Author: wdc-mevans
Subject: Highlight
Date: 5/25/2008 5:50:41 PM

T REJECT
Additionally
s/b
In addition:

● Author: wdc-mevans
Subject: Highlight
Date: 5/25/2008 5:49:58 PM

T REJECT (why replace one word with 4 that have the exact same dictionary meaning?)
simultaneously
s/b
at the same time

● Author: stx-goulder
Subject: Highlight
Date: 5/6/2008 4:07:48 PM

T ACCEPT - DONE (A, B, and C all originate from one initiator port, so should all be listed)
A and B

A and B seem to be examples of one initiator port attached to one target port (wide link). I think you mean B and C as an example of one initiator port attached to multiple target ports.

● Author: stx-goulder
Subject: Highlight
Date: 5/6/2008 4:07:48 PM

T ACCEPT - DONE (deleting this item, since it is no longer accurate after the figure was changed for multiplexing)
A and C

This seems to illustrate one SAS initiator port with connections to multiple SAS target ports. D and E illustrates connection to multiple initiator phys, but they might still be the same initiator port.

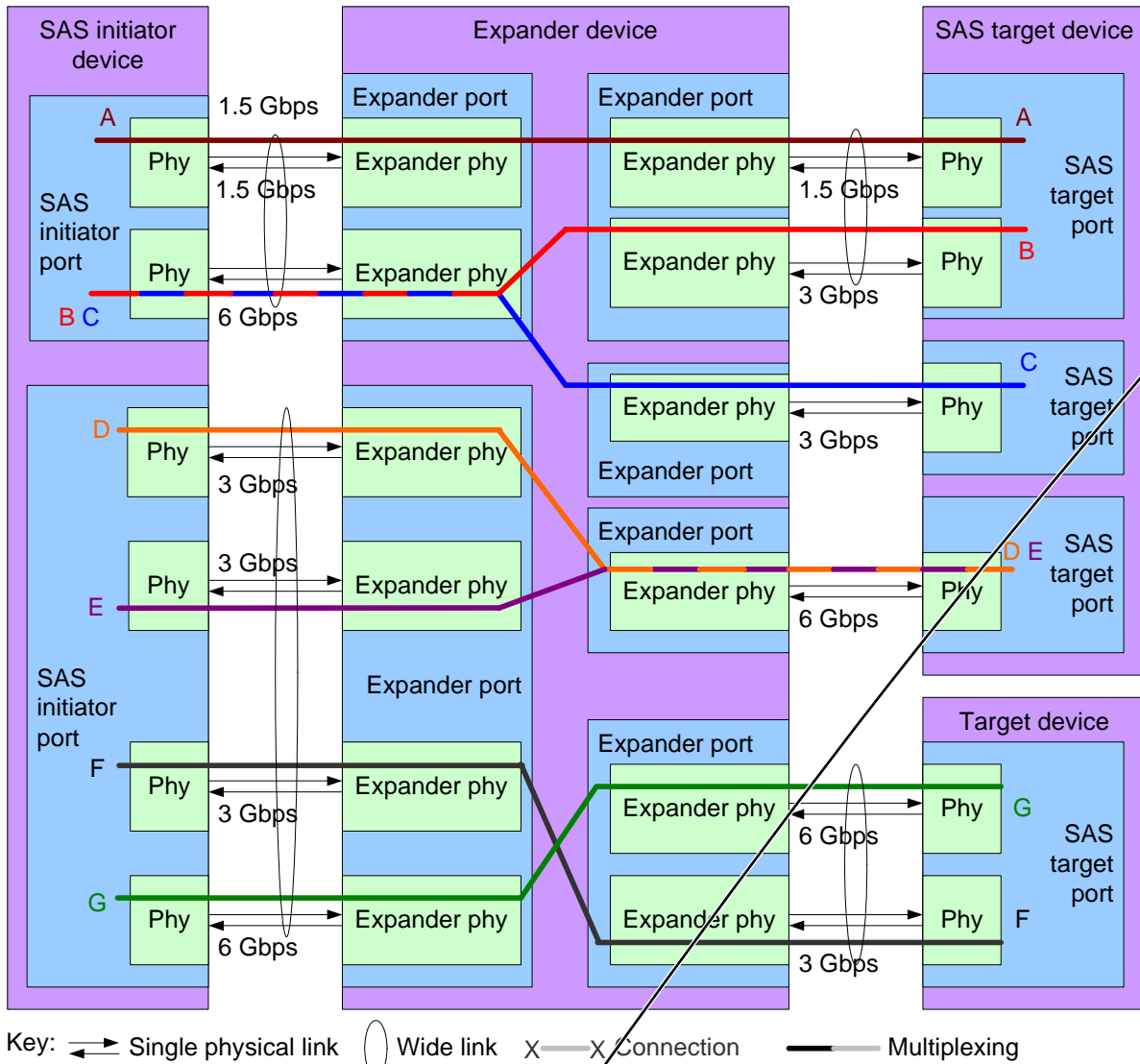

Figure 28 — Multiple connections on wide ports

4.1.13 Broadcasts

Broadcasts are used to notify all phys in the SAS domain about certain events. Broadcasts are transmitted using BROADCAST (see 7.2.6.4) and/or the SMP ZONED BROADCAST function (see 10.4.3.20).

Author: Isi-bbesmer

Subject: Highlight

Date: 5/25/2008 5:51:17 PM

T ACCEPT - DONE (changed "all phys" to "SAS ports and expander devices").

An expander device only needs to forward a Broadcast on one phy of a wide port, so "phys" is too narrow.

The term "ports" covers both "SAS ports" (which is correct) and "expander ports" (which is incorrect) - if expander A forwards a Broadcast to expander B, it is not necessarily going to reach every expander port in expander B. The expander device (specifically the BPP) is the terminus.

With zoning, the word "all" is no longer true, as only ports in affected zones will receive Broadcasts. Deleting the word "all" seems sufficient to fix this.

Also making a similar change in 7.2.6.4

)
logical phys??

ports??

Table 7 defines the Broadcast types.

Table 7 — Broadcast types (part 1 of 2)

Broadcast	Primitive ^a	Description
Broadcast (Change)	yes	Originated by an expander device to notify SAS initiator ports that a SAS domain change has occurred (see 7.11). May also be originated by SAS initiator ports. Ignored by SAS target ports.
Broadcast (Reserved Change 0)	yes	Reserved. SAS ports (i.e, SAS initiator ports and SAS target ports) shall process this Broadcast the same as Broadcast (Change).
Broadcast (Reserved Change 1)	yes	Reserved. SAS ports shall process this Broadcast the same as Broadcast (Change).
Broadcast (SES)	yes	Originated by a logical unit with a peripheral device type set to 0Dh (i.e., enclosure services device) (see SPC-4 and SES-2) accessible through a SAS target port in the SAS domain to notify SAS initiator ports of an asynchronous event. SSP initiator ports should poll all the logical units in the SAS domain with peripheral device types set to 0Dh to determine the source. SAS target ports shall ignore this Broadcast.
Broadcast (Expander)	yes	Originated by an expander device to notify SAS initiator ports that an expander event has occurred, including: a) the expander device is temporarily going to have reduced functionality for a period of time (see 4.6.8); b) a phy event peak value detector has reached its threshold value, or c) a phy event peak value detector has been cleared by an SMP CONFIGURE PHY EVENT function (see 10.4.3.30). Expander events do not include SAS domain changes, which are communicated with Broadcast (Change).
Broadcast (Asynchronous Event)	yes	Originated by an SSP target port when an event occurs that causes one or more unit attention conditions to be established for one or more logical units accessible through the SSP target port. An SSP target port shall only originate one Broadcast (Asynchronous Event) for each event that affects multiple logical units accessible through the SSP target port (e.g., only one Broadcast (Asynchronous Event) is originated when a hard reset occurs).
^a All Broadcasts are supported by the SMP ZONED BROADCAST function (see 10.4.3.20), which defines additional reserved Broadcast types. Broadcasts labeled “yes” are also transmitted via BROADCAST primitive sequences (see 7.2.6.4).		

Page: 54

● Author: Isi-bbesmer
Subject: Highlight
Date: 5/25/2008 6:38:06 PM
T ACCEPT - DONE

Ignored by SAS target ports.
s/b
SAS target ports shall ignore this Broadcast.

(Same as Broadcast(SES))

● Author: wdc-mevans
Subject: Highlight
Date: 5/25/2008 5:51:35 PM

T REJECT (Deletable primitives are not required to make it across the elasticity buffer; that is not the case for BROADCAST primitives. "Ignored" just means the state machines ignore them. Broadcasts don't always arrive in primitives, either, with the ZONED BROADCAST function - that's why they're mixed case Broadcasts rather than all-caps BROADCASTs now. Defining their handling as the same as deletable primitives wouldn't make sense.)

Global
Ignored by SAS target ports.
s/b

SAS target ports shall ignore this primitive (i.e., a target port shall process the primitive the same as a deletable primitive).
[There are several places in this table where it is defined that a port shall ignore a primitive when what is meant is that the port shall process the primitive the same as a deletable primitive. There are several solutions:

- a) add the "i.e." as in this recommended change for each occurrence;
- b) replace "ignored" with "process the same as a deletable primitive"; or
- c) add the keyword "ignored" and define it as "process the same as a deletable primitive".

Item (b) is probably the safest as you wouldn't know how or where else "ignored" may be used without a big search, and item (b) would require fewer words overall.]

● Author: elx-bmartin
Subject: Highlight
Date: 5/25/2008 5:51:51 PM

T ACCEPT - DONE (changed to "A SCSI application client should..." as it's not something that the port layer or SSP link layer does on its own.)

SSP initiator ports should poll all the logical units in the SAS domain with peripheral device types set to 0Dh to determine the source.

Why should SSP initiator ports poll? Isn't this the responsibility of a specific management application?

● Author: wdc-mevans
Subject: Highlight
Date: 5/25/2008 5:52:39 PM

T ACCEPT - DONE (just deleting temporarily, leaving "going to have reduced". It has not actually started reducing anything yet.)

temporarily going to have reduced
s/b
reducing

● Author: Isi-bbesmer
Subject: Note
Date: 5/25/2008 5:52:58 PM

ACCEPT - DONE (For Broadcast (Asynchronous Event), added "SAS ports other than SSP initiator ports shall ignore this Broadcast." For Broadcast (Expander), added "SAS target ports shall ignore this Broadcast.")

Should this also have this text?

SAS target ports shall ignore this Broadcast.

Comments from page 54 continued on next page

Table 7 defines the Broadcast types.

Table 7 — Broadcast types (part 1 of 2)

Broadcast	Primitive ^a	Description
Broadcast (Change)	yes	Originated by an expander device to notify SAS initiator ports that a SAS domain change has occurred (see 7.11). May also be originated by SAS initiator ports. Ignored by SAS target ports.
Broadcast (Reserved Change 0)	yes	Reserved. SAS ports (i.e, SAS initiator ports and SAS target ports) shall process this Broadcast the same as Broadcast (Change).
Broadcast (Reserved Change 1)	yes	Reserved. SAS ports shall process this Broadcast the same as Broadcast (Change).
Broadcast (SES)	yes	Originated by a logical unit with a peripheral device type set to 0Dh (i.e., enclosure services device) (see SPC-4 and SES-2) accessible through a SAS target port in the SAS domain to notify SAS initiator ports of an asynchronous event. SSP initiator ports should poll all the logical units in the SAS domain with peripheral device types set to 0Dh to determine the source. SAS target ports shall ignore this Broadcast.
Broadcast (Expander)	yes	Originated by an expander device to notify SAS initiator ports that an expander event has occurred, including: a) the expander device is temporarily going to have reduced functionality for a period of time (see 4.6.8); b) a phy event peak value detector has reached its threshold value; or c) a phy event peak value detector has been cleared by an SMP CONFIGURE PHY EVENT function (see 10.4.3.30). Expander events do not include SAS domain changes, which are communicated with Broadcast (Change).
Broadcast (Asynchronous Event)	yes	Originated by an SSP target port when an event occurs that causes one or more unit attention conditions to be established for one or more logical units accessible through the SSP target port. An SSP target port shall only originate one Broadcast (Asynchronous Event) for each event that affects multiple logical units accessible through the SSP target port (e.g., only one Broadcast (Asynchronous Event) is originated when a hard reset occurs).
^a All Broadcasts are supported by the SMP ZONED BROADCAST function (see 10.4.3.20), which defines additional reserved Broadcast types. Broadcasts labeled “yes” are also transmitted via BROADCAST primitive sequences (see 7.2.6.4).		

Author: RElliott
Subject: Highlight
Date: 6/30/2008 6:16:52 PM

 ACCEPT - DONE

event occurs

s/b

event occurs (e.g., a hard reset)

to help alleviate an lsi-bbesmer comment on 4.4.2

Author: RElliott
Subject: Note
Date: 6/30/2008 6:16:52 PM

 ACCEPT - DONE

fix formatting of last paragraph in Broadcast (Asynchronous Event) description

Table 7 — Broadcast types (part 2 of 2)

Broadcast	Primitive ^a	Description
Broadcast (Reserved 3)	yes	Reserved. SAS ports shall ignore this Broadcast.
Broadcast (Reserved 4)	yes	Reserved. SAS ports shall ignore this Broadcast.
Broadcast (Zone Activate)	no	Initiates the zone activate step (see 4.9.6.4). Devices that are not locked zoning expander devices shall ignore this Broadcast.
^a All Broadcasts are supported by the SMP ZONED BROADCAST function (see 10.4.3.20), which defines additional reserved Broadcast types. Broadcasts labeled “yes” are also transmitted via BROADCAST primitive sequences (see 7.2.6.4).		

When an expander port receives a Broadcast, the BPP (see 4.6.5) shall forward the Broadcast on at least one phy in each other expander port if zoning is disabled, or forward the Broadcast as described in 4.9.5 if zoning is enabled.

An expander device is not required to queue multiple identical Broadcasts for the same expander port. If a second identical Broadcast is requested before the first Broadcast has been transmitted, the second Broadcast may be ignored.

A SAS device or an expander device is not required to maintain originated Broadcast count information in non-volatile storage or across reset events.

A SAS device or expander device may implement counters for Broadcasts it originates and report them in the REPORT BROADCAST response (see 10.4.3.9). If supported, the SAS device or expander device shall, for each combination of Broadcast type and Broadcast reason that the SAS device or expander device supports.

- a) if the Broadcast is related to a phy, then maintain a separate broadcast counter for each phy; and
- b) if the Broadcast is not related to a phy, then maintain one originated broadcast counter.

Broadcast (Change)s originated by an expander device are counted and reported in the REPORT GENERAL response (see 10.4.3.4) and other SMP response frames containing an EXPANDER CHANGE COUNT field.

An expander device may implement counters for Broadcasts received from attached end devices and report them in the REPORT BROADCAST response (see 10.4.3.9).

See 4.11 for details on phy events.

4.2 Names and identifiers

4.2.1 Names and identifiers overview

Device names are worldwide unique names for devices within a transport protocol. Port names are worldwide unique names for ports within a transport protocol. Port identifiers are the values by which ports are identified within a domain. Phy identifiers are the values by which phys are identified within a device.

Page: 55

● Author: Isi-bbesmer
Subject: Note
Date: 5/25/2008 5:53:18 PM
 REJECT ("or forward... as described in 4.9.5" covers that)

This does not specify the special broadcast zoning rules specified in 4.9.5

● Author: RElliott
Subject: Highlight
Date: 6/30/2008 6:16:52 PM
 ACCEPT - DONE
the
s/b
then the

● Author: Isi-bbesmer
Subject: Note
Date: 5/25/2008 5:53:30 PM
 ACCEPT - DONE

This paragraph should be located after the counters themselves are described (ie. just before the See 4.11 paragraph).

● Author: wdc-mevans
Subject: Highlight
Date: 5/25/2008 5:53:50 PM
 REJECT ("it" is better, referring to the subject of the sentence "A SAS device or expander device" without restating it incorrectly as "the device")

it
s/b
that the device

● Author: RElliott
Subject: Highlight
Date: 6/30/2008 6:16:52 PM
 ACCEPT - DONE
the
s/b
then the

● Author: Isi-gpenokie
Subject: Highlight
Date: 5/6/2008 4:07:48 PM
 ACCEPT - DONE

This is a << or >> as both cases can't be true at the same time.

Table 8 describes the definitions of names and identifiers for SAS.

Table 8 — Names and identifiers

Attribute	Format	SAS usage	Reference
Device name	NAA IEEE Registered format (see 4.2.2) for: a) SAS devices and expander devices; and b) SATA devices with worldwide names	Reported in: a) the IDENTIFY address frame (see 7.8.2) DEVICE NAME field; b) the Device Identification VPD page (see 10.2.11.2); and c) the DISCOVER response (SEE 4.0 4.3.10) ATTACHED DEVICE NAME field.	4.2.4 and 4.2.5
Port name	Not defined		4.2.6
Port identifier	NAA IEEE Registered format (see 4.2.2)	Reported in the IDENTIFY address frame (see 7.8.2) for SAS ports.	4.2.7
Phy identifier	7-bit value	Phy identifier	4.2.8

Table 9 describes how various SAM-4 attributes are implemented in SSP.

Table 9 — SAM-4 attribute mapping

SAM-4 attribute	SSP implementation
Initiator port identifier	SAS address of an SSP initiator port
Initiator port name	Not defined
Target port identifier	SAS address of an SSP target port
Target port name	Not defined
SCSI device name	Device name of SAS device containing an SSP port

4.2.2 NAA IEEE Registered format identifier

Table 10 defines the NAA IEEE Registered format identifier used by device names and port identifiers. This format is the same as that defined in SPC-4.

Table 10 — NAA IEEE Registered format

Byte/Bit	7	6	5	4	3	2	1	0
0	NAA (5h)				(MSB)			
1	IEEE COMPANY ID							
2								
3	(LSB)							
4	VENDOR-SPECIFIC IDENTIFIER							
5								
6								
7								

The NAA field contains 5h.

Page: 56

● Author: RElliott
Subject: Highlight
Date: 6/30/2008 6:16:52 PM
T ACCEPT - DONE

NAA IEEE Registered format for SAS devices and expander devices; and SATA devices with worldwide names

s/b

SAS address (see new section) for SAS devices and expander devices.

NAA IEEE Registered Extended format (see 4.2.2) for SATA devices with worldwide names.

● Author: RElliott
Subject: Highlight
Date: 6/30/2008 6:16:52 PM
T ACCEPT - DONE

(SEE

turn off smallcaps

● Author: Isi-bbesmer
Subject: Note
Date: 5/25/2008 5:54:23 PM
ACCEPT - DONE (added a table footnote to "SATA devices with worldwide names" that says "For SATA devices without worldwide names, a device name may be set in the PHY CONTROL request (see 10.4.3.28) attached device name field.")

Also used in SMP Phy Control request.

● Author: ktek-dmoore
Subject: Highlight
Date: 5/25/2008 5:54:39 PM
T ACCEPT - DONE (yes, added)

Reported in the IDENTIFY address frame (see 7.8.2) for SAS ports.

Isn't this also in VPD 83h?

● Author: RElliott
Subject: Highlight
Date: 6/30/2008 6:16:52 PM
T ACCEPT - DONE

NAA IEEE Registered format

s/b

SAS address (see new section)

● Author: RElliott
Subject: Highlight
Date: 6/30/2008 6:16:52 PM
T ACCEPT - DONE

7-bit value

s/b

8-bit value

Comments from page 56 continued on next page

Table 8 describes the definitions of names and identifiers for SAS.

Table 8 — Names and identifiers

Attribute	Format	SAS usage	Reference
Device name	NAA IEEE Registered format (see 4.2.2) for: a) SAS devices and expander devices; and b) SATA devices with worldwide names	Reported in: a) the IDENTIFY address frame (see 7.8.2) DEVICE NAME field; b) the Device Identification VPD page (see 10.2.11.2); and c) the DISCOVER response (SEE 10.4.3.10) ATTACHED DEVICE NAME field.	4.2.4 and 4.2.5
Port name	Not defined		4.2.6
Port identifier	NAA IEEE Registered format (see 4.2.2)	Reported in the IDENTIFY address frame (see 7.8.2) for SAS ports.	4.2.7
Phy identifier	7-bit value	Phy identifier	4.2.8

Table 9 describes how various SAM-4 attributes are implemented in SSP.

Table 9 — SAM-4 attribute mapping

SAM-4 attribute	SSP implementation
Initiator port identifier	SAS address of an SSP initiator port
Initiator port name	Not defined
Target port identifier	SAS address of an SSP target port
Target port name	Not defined
SCSI device name	Device name of SAS device containing an SSP port

4.2.2 NAA IEEE Registered format identifier

Table 10 defines the NAA IEEE Registered format identifier used by device names and port identifiers. This format is the same as that defined in SPC-4.

Table 10 — NAA IEEE Registered format

Byte/Bit	7	6	5	4	3	2	1	0
0	NAA (5h)				(MSB)			
1					IEEE COMPANY ID			
2								
3					(LSB)			
4								
5					VENDOR-SPECIFIC IDENTIFIER			
6								
7								

The NAA field contains 5h.

per lsi-bbesmer comment on figure 10

Author: RElliott
Subject: Highlight
Date: 6/30/2008 6:16:52 PM
ACCEPT - DONE

contains 5h

s/b

is set to the value defined in table 10.

The IEEE COMPANY ID field contains a 24-bit canonical form company identifier (i.e., organizationally unique identifier or OUI) assigned by the IEEE.

Bit 5 of byte 1, which serves as the UNIVERSALLY/LOCALLY ADMINISTERED ADDRESS bit, shall be set to zero.

Bit 4 of byte 1, which serves as the INDIVIDUAL/GROUP ADDRESS bit, shall be set to zero.

NOTE 10 - Information about IEEE company identifiers may be obtained from the IEEE Registration Authority web site at <http://standards.ieee.org/regauth/oui>.

The VENDOR-SPECIFIC IDENTIFIER field contains a 36-bit value that is assigned by the organization associated with the company identifier in the IEEE COMPANY ID field. The VENDOR-SPECIFIC IDENTIFIER field shall be assigned so the NAA IEEE Registered format identifier is worldwide unique.

An identifier value of 00000000_00000000h indicates an invalid identifier.

4.2.3 Hashed SAS addresses

SSP frames include hashed versions of SAS addresses of SAS ports (i.e., NAA IEEE Registered format identifiers for SAS ports) to provide an additional level of verification of proper frame routing.

The code used for the hashing algorithm is a cyclic binary Bose, Chaudhuri, and Hocquenghem (BCH) (63, 39, 9) code. Table 11 lists the parameters for the code.

Table 11 — Hashed SAS address code parameter

Parameter	Value
Number of bits per codeword	63
Number of data bits	39
Number of redundant bits	24
Minimum distance of the code	9

The generator polynomial for this code is:

$$G(x) = (x^6 + x + 1) (x^6 + x^4 + x^2 + x + 1) (x^6 + x^5 + x^2 + x + 1) (x^6 + x^3 + 1)$$

After multiplication of the factors, the generator polynomial is:

$$G(x) = x^{24} + x^{23} + x^{22} + x^{20} + x^{19} + x^{17} + x^{16} + x^{13} + x^{10} + x^9 + x^8 + x^6 + x^5 + x^4 + x^2 + x + 1$$

Annex E contains additional information on SAS address hashing.

4.2.4 Device names and expander device SAS addresses

Each expander device, SAS initiator device, SAS target device, and SAS target/initiator device shall include an NAA IEEE Registered format identifier (see 4.2.2) as its device name. The device name of an expander device is called its SAS address. An NAA IEEE Registered format identifier used as a device name shall not be used as any other name or identifier (e.g., a device name, port name, port identifier, or logical unit name (see SAM-4)).

SAS devices and expander devices report their device names in the IDENTIFY address frame (see 7.8.2).

NOTE 11 - When a set of expander phys transmit the same SAS address in the identification sequence but receive different SAS addresses, indicating they are attached to separate SAS ports or expander ports, they become part of separate expander ports in the same domain.

Logical units accessed through SSP target ports report SAS target device names through SCSI vital product data (see 10.2.11).

Page: 57

Author: wdc-mevans

Subject: Highlight

Date: 5/25/2008 5:55:08 PM

 ACCEPT - DONE (as "identifier (OUI))" since that's how acronyms are introduced)

identifier or OUI)

s/b

identifier, or OUI)

Author: RElliott

Subject: Note

Date: 6/30/2008 6:16:52 PM

 ACCEPT - DONE (moved into new section for SAS address)

The sentence about 00000000_00000000h doesn't belong in a subsection where NAA is defined as containing 5h. NAA is really 0h in that identifier.

Author: RElliott

Subject: Highlight

Date: 6/30/2008 6:16:52 PM

 ACCEPT - DONE

00000000_00000000h

should use a space like most numbers

(_ is allowed, but should be used only where it helps readability)

Author: hpq-relliott

Subject: Note

Date: 5/25/2008 5:55:30 PM

 ACCEPT - DONE

(Added the NAA Locally Assigned format per SPC-4 as 4.2.3.

Added this as a new SAS address section:

4.2.4 SAS address

A SAS address is an identifier using either:

a) the NAA IEEE Registered format (see 4.2.2); or

b) the NAA Locally Assigned format (see 4.2.3).

A SAS address should use the NAA IEEE Registered format (see 4.2.2).

and made other adjustments to match (noted in other editor comments)

)

Allow NAA=3h for software-generated SAS addresses?

(from Doug Gilbert)

Author: RElliott

Subject: Cross-Out

Date: 6/30/2008 6:16:52 PM

 ACCEPT - DONE

delete (i.e., NAA IEEE Registered format identifiers for SAS ports)

to allow for NAA Locally Assigned as well. This i.e. is not necessary anyway.

Author: RElliott

Subject: Highlight

Date: 6/30/2008 6:16:52 PM

 ACCEPT - DONE

Comments from page 57 continued on next page

The IEEE COMPANY ID field contains a 24-bit canonical form company identifier (i.e., organizationally unique identifier or OUI) assigned by the IEEE.

Bit 5 of byte 1, which serves as the UNIVERSALLY/LOCALLY ADMINISTERED ADDRESS bit, shall be set to zero.

Bit 4 of byte 1, which serves as the INDIVIDUAL/GROUP ADDRESS bit, shall be set to zero.

NOTE 10 - Information about IEEE company identifiers may be obtained from the IEEE Registration Authority web site at <http://standards.ieee.org/regauth/oui>.

The VENDOR-SPECIFIC IDENTIFIER field contains a 36-bit value that is assigned by the organization associated with the company identifier in the IEEE COMPANY ID field. The VENDOR-SPECIFIC IDENTIFIER field shall be assigned so the NAA IEEE Registered format identifier is worldwide unique.

An identifier value of 00000000_00000000h indicates an invalid identifier.

4.2.3 Hashed SAS addresses

SSP frames include hashed versions of SAS addresses of SAS ports (i.e., NAA IEEE Registered format identifiers for SAS ports) to provide an additional level of verification of proper frame routing.

The code used for the hashing algorithm is a cyclic binary Bose, Chaudhuri, and Hocquenghem (BCH) (63, 39, 9) code. Table 11 lists the parameters for the code.

Table 11 — Hashed SAS address code parameter

Parameter	Value
Number of bits per codeword	63
Number of data bits	39
Number of redundant bits	24
Minimum distance of the code	9

The generator polynomial for this code is:

$$G(x) = (x^6 + x + 1) (x^6 + x^4 + x^2 + x + 1) (x^6 + x^5 + x^2 + x + 1) (x^6 + x^2 + 1)$$

After multiplication of the factors, the generator polynomial is:

$$G(x) = x^{24} + x^{23} + x^{22} + x^{20} + x^{19} + x^{17} + x^{16} + x^{13} + x^{10} + x^8 + x^6 + x^5 + x^4 + x^2 + x + 1$$

Annex E contains additional information on SAS address hashing.

4.2.4 Device names and expander device SAS addresses

Each expander device, SAS initiator device, SAS target device, and SAS target/initiator device shall include an NAA IEEE Registered format identifier (see 4.2.2) as its device name. The device name of an expander device is called its SAS address. An NAA IEEE Registered format identifier used as a device name shall not be used as any other name or identifier (e.g., a device name, port name, port identifier, or logical unit name (see SAM-4)).

SAS devices and expander devices report their device names in the IDENTIFY address frame (see 7.8.2).

NOTE 11 - When a set of expander phys transmit the same SAS address in the identification sequence but receive different SAS addresses, indicating they are attached to separate SAS ports or expander ports, they become part of separate expander ports in the same domain.

Logical units accessed through SSP target ports report SAS target device names through SCSI vital product data (see 10.2.11).

parameter
s/b
parameters

● Author: Isi-gpenokie
Subject: Highlight
Date: 5/25/2008 5:55:53 PM
T ACCEPT - DONE (as "Each expander device and SAS device shall...")

This << device, SAS target device, and SAS target/initiator device shall include >> should be << device, and SAS target device shall include >>

● Author: RElliott
Subject: Highlight
Date: 6/30/2008 6:16:52 PM
T ACCEPT - DONE

an NAA IEEE Registered format identifier (see 4.2.2)
s/b
a SAS address (see new section)

● Author: RElliott
Subject: Highlight
Date: 6/30/2008 6:16:52 PM
T ACCEPT - DONE

An NAA IEEE Registered format identifier
s/b
A SAS address

● Author: RElliott
Subject: Highlight
Date: 6/30/2008 6:16:52 PM
T ACCEPT - DONE

This is too broad a statement.
Add:
, except:
a) the SAS address of an expander device is the same as the SAS address of the SMP port in that expander device.

4.2.5 Device name for SATA devices with world wide names

Table 12 defines the NAA IEEE Registered format identifier used by device names for SATA devices that provide world wide names in their IDENTIFY (PACKET) DEVICE data.

Table 12 — Device name created from the IDENTIFY (PACKET) DEVICE world wide name

Subformat field name (see table 10)	Specific bits in	Contents ^a
NAA	Byte 0 bits 7:4	IDENTIFY (PACKET) DEVICE data word 108 bits 15:12 ^b
IEEE COMPANY_ID	Byte 0 bits 3:0	IDENTIFY (PACKET) DEVICE data word 108 bits 11:8
	Byte 1	IDENTIFY (PACKET) DEVICE data word 108 bits 7:0
	Byte 2	IDENTIFY (PACKET) DEVICE data word 109 bits 15:8
	Byte 3 bits 7:4	IDENTIFY (PACKET) DEVICE data word 109 bits 7:4
VENDOR SPECIFIC IDENTIFIER	Byte 3 bits 3:0	IDENTIFY (PACKET) DEVICE data word 109 bits 3:0
	Byte 4	IDENTIFY (PACKET) DEVICE data word 110 bits 15:8
	Byte 5	IDENTIFY (PACKET) DEVICE data word 110 bits 7:0
	Byte 6	IDENTIFY (PACKET) DEVICE data word 111 bits 15:8
	Byte 7	IDENTIFY (PACKET) DEVICE data word 111 bits 7:0

^a IDENTIFY (PACKET) DEVICE data words 108-111 contain the world wide name field (see ATA8-ACS).
^b This 4-bit field is required to be set to 5h (i.e., IEEE Registered) by ATA8-ACS.

4.2.6 Port names

Port names are not defined in SAS.

NOTE 12 - The SAS addresses used by SAS ports in different SAS domains may be the same (e.g., when a set of phys transmit the same SAS address in the identification sequence but receive different SAS addresses, indicating they are attached to two separate SAS domains) so the SAS address serves as a port identifier (see 4.2.7) rather than a port name.

4.2.7 Port identifiers and SAS port SAS addresses

Each SAS initiator port, SAS target port (e.g., including the STP target port in each STP/SATA bridge), and SAS target/initiator port shall include an NAA IEEE Registered format identifier (see 4.2.2) as its port identifier. The port identifier of a SAS port is called its SAS address. An NAA IEEE Registered format identifier used as a port identifier shall not be used as any other name or identifier (e.g., a device name, port name, or logical unit name (see SAM-4)) except as a port identifier in one or more other SAS domains (see 4.1.4).

Expander ports do not have port identifiers. 

SAS ports in end devices report their port identifiers in the IDENTIFY address frame (see 7.8.2). Expander devices containing SAS ports (e.g., SAS ports attached to virtual phys, or STP target ports in STP/SATA bridges) report the port identifiers of those SAS ports in the SMP DISCOVER response (see 10.4.3.10).

NOTE 13 - When a set of SAS phys transmit the same SAS address in the identification sequence but receive different SAS addresses, indicating they are attached to more than one SAS domain, they become part of separate SAS ports in separate domains. Each SAS port shares the same SAS address.

Port identifiers are used as source and destination SAS addresses in the OPEN address frame (see 7.8.3).

Logical units accessed through SSP target ports report SAS target port identifiers through SCSI vital product data (see 10.2.11).

Author: RElliott
Subject: Highlight
Date: 6/30/2008 6:16:52 PM
T ACCEPT - DONE

name (see table 10)
s/b
name (see table 10 in 4.2.2)

Author: lsi-gpenokie
Subject: Highlight
Date: 5/25/2008 5:56:28 PM
T ACCEPT - DONE (as "Each SAS port shall...")

This << SAS initiator port, SAS target port (e.g., including the STP target port in each STP/SATA bridge), and SAS target/initiator port shall >> should be << SAS initiator port and SAS target port (e.g., including the STP target port in each STP/SATA bridge) shall >>

Author: RElliott
Subject: Highlight
Date: 6/30/2008 6:16:52 PM
T ACCEPT - DONE

an NAA IEEE Registered format identifier (see 4.2.2)
s/b
a SAS Address (see new section)

Author: RElliott
Subject: Highlight
Date: 6/30/2008 6:16:52 PM
T ACCEPT - DONE

An NAA IEEE Registered format identifier
s/b
A SAS address

Author: RElliott
Subject: Highlight
Date: 6/30/2008 6:16:52 PM
T ACCEPT - DONE

except

To be correct, also add:
; and
the SAS address of an SMP port in an expander device is the same as the SAS address of the expander device containing that SMP port.

Author: lsi-bbesmer
Subject: Note
Date: 5/25/2008 5:56:57 PM
ACCEPT - DONE (added "NOTE: The SMP port in an expander device has a port identifier that is the same as the device name of the expander device (see 4.6.2), and is used for addressing an expander device. Expander ports are not individually addressed.")

Section 4.6.2 has the "shall".
)

Need to explain why this statement is being made? (because they use device name instead).

Author: elx-bmartin

4.2.5 Device name for SATA devices with world wide names

Table 12 defines the NAA IEEE Registered format identifier used by device names for SATA devices that provide world wide names in their IDENTIFY (PACKET) DEVICE data.

Table 12 — Device name created from the IDENTIFY (PACKET) DEVICE world wide name

Subformat field name (see table 10)	Specific bits in	Contents ^a
NAA	Byte 0 bits 7:4	IDENTIFY (PACKET) DEVICE data word 108 bits 15:12 ^b
IEEE COMPANY_ID	Byte 0 bits 3:0	IDENTIFY (PACKET) DEVICE data word 108 bits 11:8
	Byte 1	IDENTIFY (PACKET) DEVICE data word 108 bits 7:0
	Byte 2	IDENTIFY (PACKET) DEVICE data word 109 bits 15:8
	Byte 3 bits 7:4	IDENTIFY (PACKET) DEVICE data word 109 bits 7:4
VENDOR SPECIFIC IDENTIFIER	Byte 3 bits 3:0	IDENTIFY (PACKET) DEVICE data word 109 bits 3:0
	Byte 4	IDENTIFY (PACKET) DEVICE data word 110 bits 15:8
	Byte 5	IDENTIFY (PACKET) DEVICE data word 110 bits 7:0
	Byte 6	IDENTIFY (PACKET) DEVICE data word 111 bits 15:8
	Byte 7	IDENTIFY (PACKET) DEVICE data word 111 bits 7:0
^a IDENTIFY (PACKET) DEVICE data words 108-111 contain the world wide name field (see ATA8-ACS). ^b This 4-bit field is required to be set to 5h (i.e., IEEE Registered) by ATA8-ACS.		

4.2.6 Port names

Port names are not defined in SAS.

NOTE 12 - The SAS addresses used by SAS ports in different SAS domains may be the same (e.g., when a set of phys transmit the same SAS address in the identification sequence but receive different SAS addresses, indicating they are attached to two separate SAS domains) so the SAS address serves as a port identifier (see 4.2.7) rather than a port name.

4.2.7 Port identifiers and SAS port SAS addresses

Each SAS initiator port, SAS target port (e.g., including the STP target port in each STP/SATA bridge), and SAS target/initiator port shall include an NAA IEEE Registered format identifier (see 4.2.2) as its port identifier. The port identifier of a SAS port is called its SAS address. An NAA IEEE Registered format identifier used as a port identifier shall not be used as any other name or identifier (e.g., a device name, port name, or logical unit name (see SAM-4)) except as a port identifier in one or more other SAS domains (see 4.1.4).

Expander ports do not have port identifiers. 

SAS ports in end devices report their port identifiers in the IDENTIFY address frame (see 7.8.2). Expander devices containing SAS ports (e.g., SAS ports attached to virtual phys, or STP target ports in STP/SATA bridges) report the port identifiers of those SAS ports in the SMP DISCOVER response (see 10.4.3.10).

NOTE 13 - When a set of SAS phys transmit the same SAS address in the identification sequence but receive different SAS addresses, indicating they are attached to more than one SAS domain, they become part of separate SAS ports in separate domains. Each SAS port shares the same SAS address.

Port identifiers are used as source and destination SAS addresses in the OPEN address frame (see 7.8.3).

Logical units accessed through SSP target ports report SAS target port identifiers through SCSI vital product data (see 10.2.11).

Subject: Comment on Text
Date: 5/25/2008 5:57:11 PM

T ACCEPT - DONE (yes, that is an issue - "don't do that" is the basic answer. Adding "See figure 46 in 4.8.2 for an example of what happens if they are not in separate SAS domains." That section advises the configuration subprocess to disable phys if it detects a multi-path problem/loop introduced by doing this.)

Can't this also be a configuration issue where they are attached to two different expanders in the same SAS domain? What mechanism is there to determine that they are in different SAS domains?

Author: RElliott
Subject: Highlight
Date: 6/30/2008 6:16:52 PM

T ACCEPT - DONE

domains

s/b

SAS domains

4.2.8 Phy identifiers

Each SAS phy and expander phy shall be assigned an identifier called a phy identifier that is unique within the SAS device and/or expander device. Each SAS logical phy within a SAS phy shall use the same phy identifier. Each expander logical phy within an expander phy shall use the same phy identifier. The phy identifier is used for management functions (see 10.4).

Phy identifiers shall be greater than or equal to 00h and less than 80h, and should be numbered starting with 00h. In an expander device or in a SAS device containing an SMP target port, phy identifiers shall be less than the value of the NUMBER OF PHYS field in the SMP REPORT GENERAL response (see 10.4.3.4). In a SAS device containing an SSP target port, phy identifiers shall be less than the value of the NUMBER OF PHYS field in the Phy Control And Discover mode page (see 10.2.7.5).

4.3 State machines

4.3.1 State machine overview

Figure 29 shows the state machines for SAS devices, their relationships to each other and to the SAS Device, SAS Port, and SAS Phy classes.

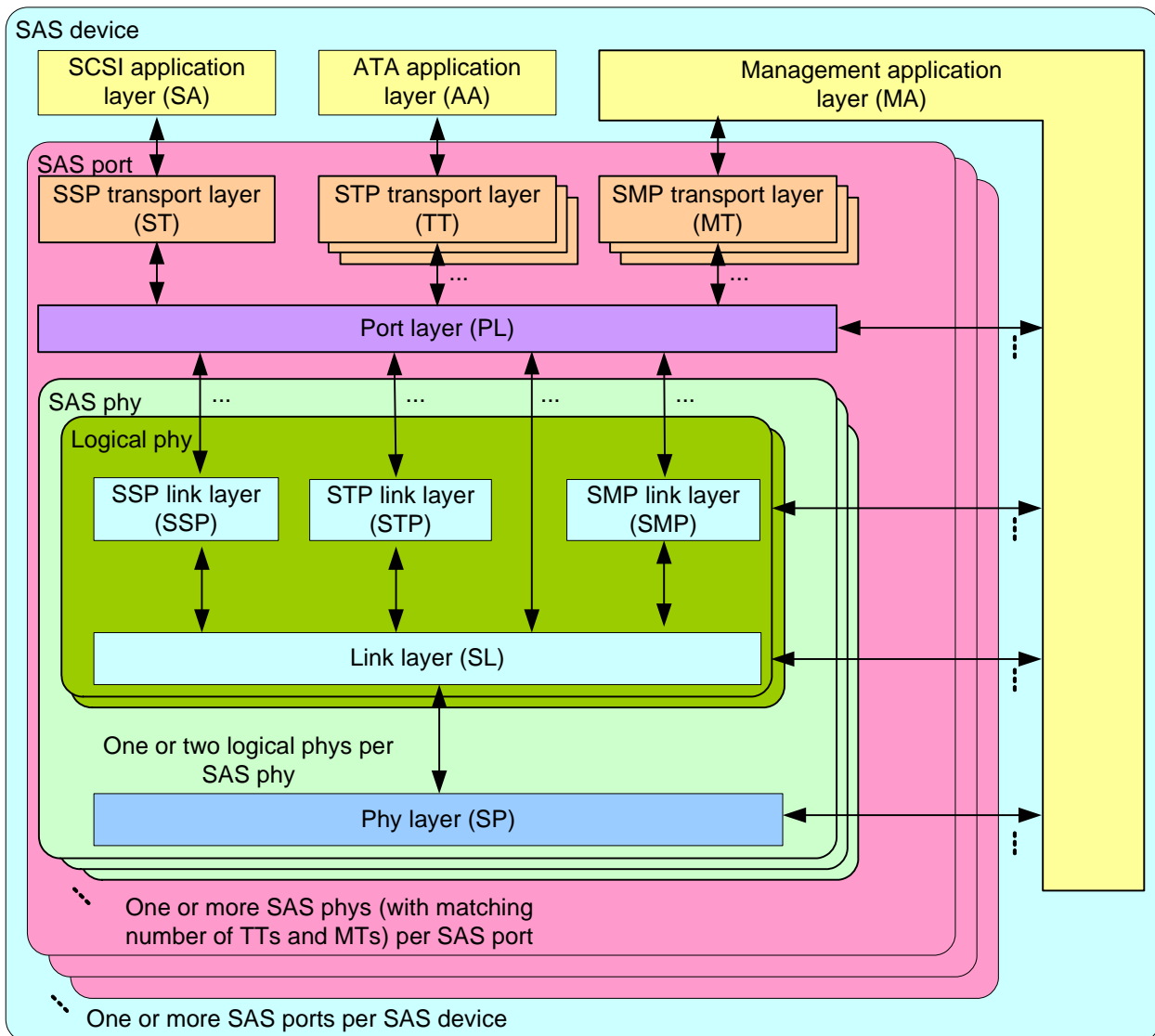

Figure 29 — State machines for SAS devices

Author: RElliott
Subject: Highlight
Date: 6/30/2008 6:16:52 PM
ACCEPT - DONE

less than 80h

s/b

less than or equal to FEh

per lsi-bbesmer comment on figure 10

Figure 30 shows the state machines for expander devices, their relationships to each other and to the Expander Device, Expander Port, and Expander Phy classes. Expander function state machines are not defined in this standard, but the interface to the expander function is defined in 4.6.6.

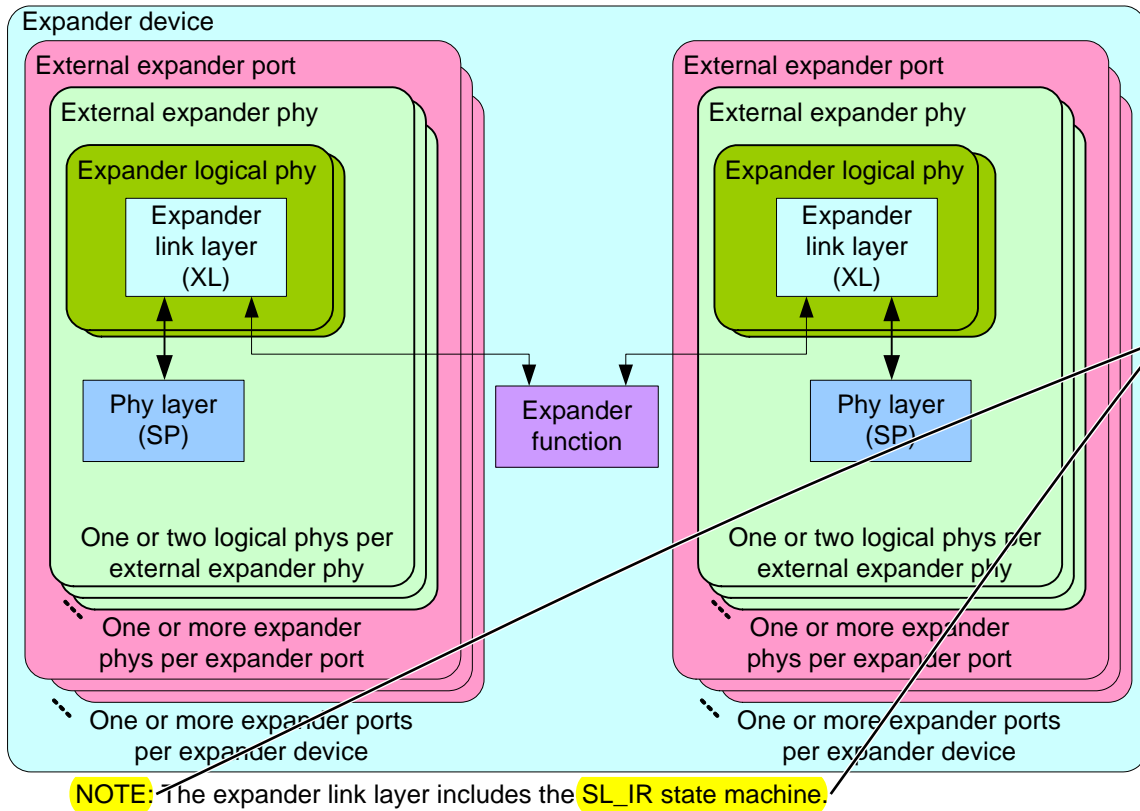

Figure 30 — State machines for expander devices

4.3.2 Transmit data path

Figure 31 shows the transmit data path in a SAS phy, showing the relationship between:

- the SP state machine (see 6.8) and the SP transmitter (see 6.8.2);
- multiplexing (see 6.10);
- the SL_IR state machines (see 7.9.4) and the SL_IR transmitter (see 7.9.4.2);
- physical link rate tolerance management (see 7.3);
- the SL state machines (see 7.14) and the SL transmitter (see 7.14.2);
- rate matching (see 7.13); and
- the SSP transmit data path (see figure 32), SMP transmit data path (see figure 33), and STP transmit data path (see figure 34).

● Author: RElliott
Subject: Highlight
Date: 6/30/2008 6:16:52 PM
T ACCEPT - DONE

SL_IR state machine
s/b
SL_IR state machines

● Author: RElliott
Subject: Highlight
Date: 8/27/2008 9:54:47 AM
T ACCEPT - DONE

NOTE
s/b
Note

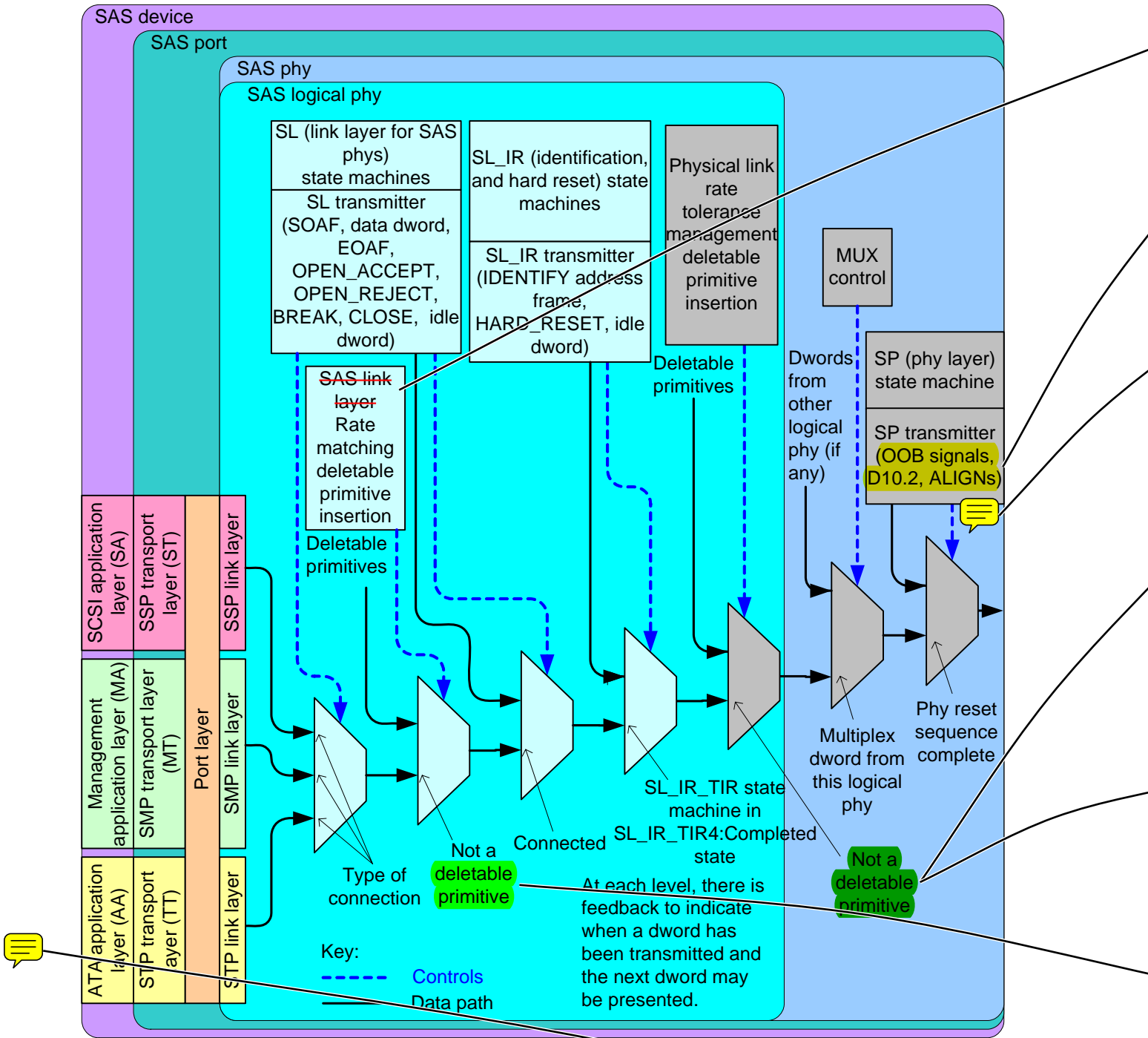



Figure 31 — Transmit data path in a SAS phy

Figure 32 shows the transmit data path for the SSP link layer, including the SSP state machines and the SSP

Page: 61

● Author: RElliott
Subject: Cross-Out
Date: 6/30/2008 6:16:52 PM
 ACCEPT - DONE

SAS link layer

● Author: intc-mseidel
Subject: Highlight
Date: 5/25/2008 5:57:59 PM
 ACCEPT - DONE (included in this list)

The diagram should make clear that TRAIN and TRAIN_DONE primitives are among the last ones to enter the datastream. If they are not, then the training patterns can be incorrect and not deterministic.

● Author: RElliott
Subject: Note
Date: 8/31/2008 5:52:20 PM
 ACCEPT - DONE

ALIGNs
s/b
ALIGN

● Author: lsi-bday
Subject: Highlight
Date: 5/25/2008 6:38:39 PM
 ACCEPT - DONE ("Not a physical link rate tolerance management deletable primitive")

Not a
deletable
primitive

This isn't true from the earlier rate matching insertion in the path.

● Author: stx-goulder
Subject: Highlight
Date: 5/25/2008 5:58:14 PM
 ACCEPT - DONE ("Not a physical link rate tolerance management deletable primitive")

Not a deletable primitive

3 levels up, the SAS link layer inserts rate matching deletable primitives. Therefore there can be deletable primitives in this path when rate matching.

● Author: RElliott
Subject: Highlight
Date: 6/30/2008 6:16:52 PM
 ACCEPT - DONE

deletable primitive
s/b
rate matching deletable primitive

● Author: hpq-relliott
Subject: Note
Date: 6/11/2008 11:31:00 AM

Comments from page 61 continued on next page

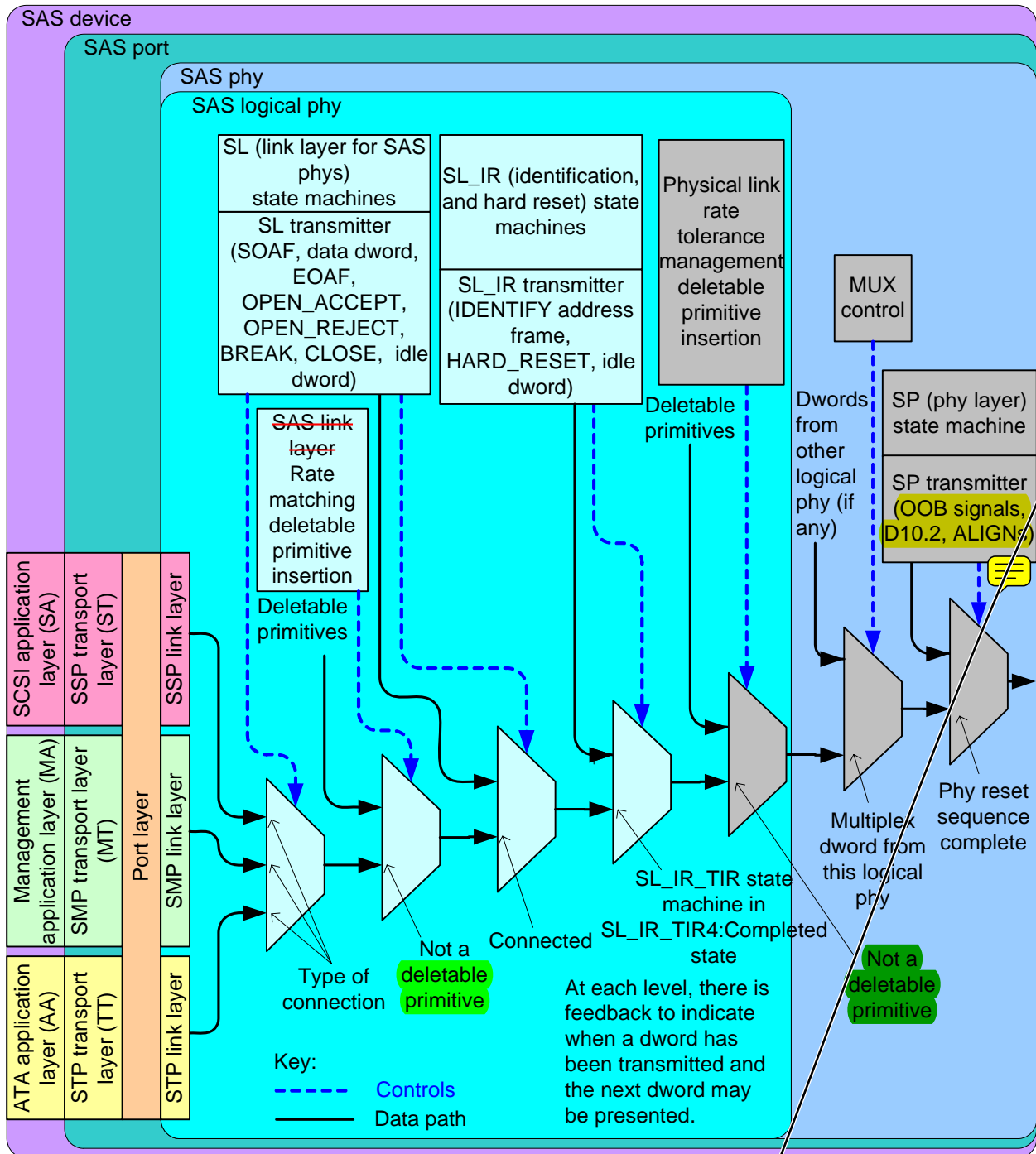

Figure 31 — Transmit data path in a SAS phy

Figure 32 shows the transmit data path for the SSP link layer, including the SSP state machines and the SSP

 REJECT (6/11 call)

Add more specific MUX controls in the Transmit data path figure

● Author: intc-mseidel

Subject: Highlight

Date: 8/31/2008 5:51:35 PM

 ACCEPT - DONE (added TRAIN pattern and TRAIN_DONE pattern, which include 00h scrambled. Also in expander device figure.)

The Speed Negotiation primitives (e.g., TRAIN, TRAIN_DONE, random scrambled data) should be included with the SP transmitter box.

transmitter (see 7.16.8 and 7.16.8.2), and the communication to the port layer, SSP transport layer, and SCSI application layer. Only the SSP link layer (i.e., not the port, transport, or application layer) transmits dwords.

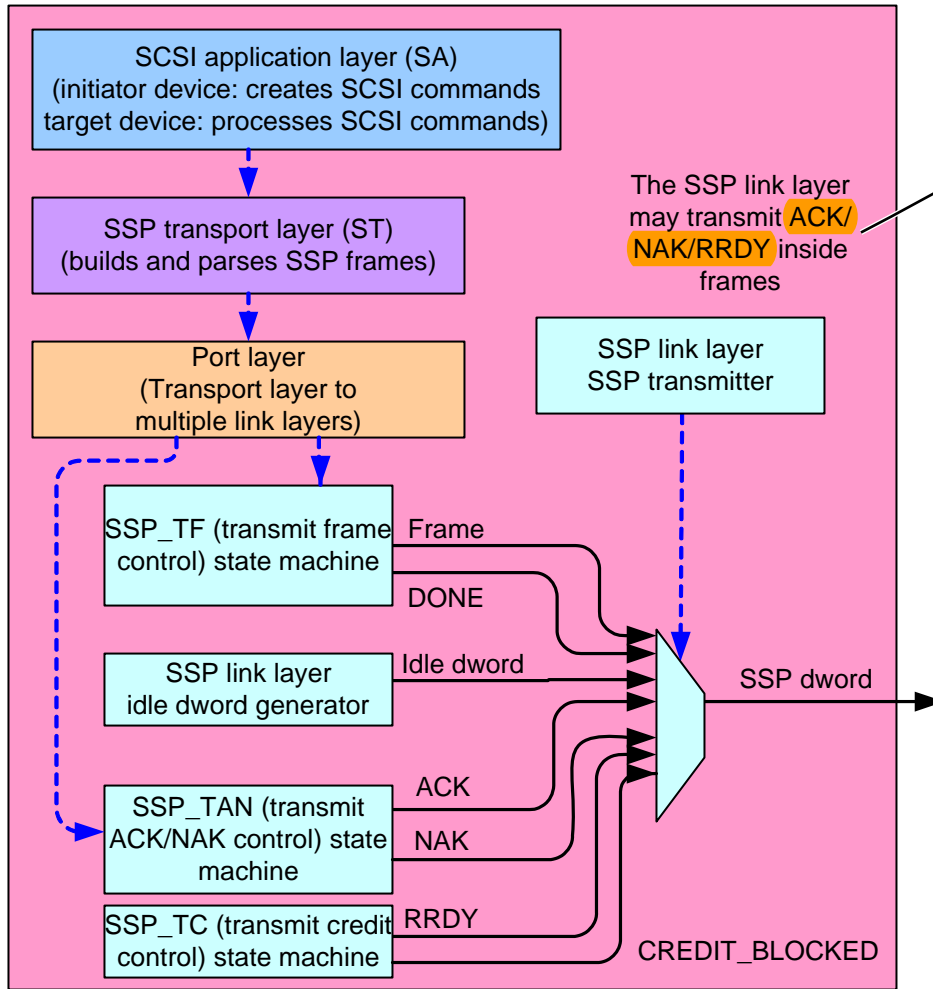

Figure 32 — SSP link, port, SSP transport, and SCSI application layer state machines

Figure 33 shows the transmit data path for the SMP link layer, including the SMP state machines and the SMP

Author: Isi-bday
Subject: Highlight
Date: 5/6/2008 4:07:48 PM

T ACCEPT - DONE

ACK/NAK/RRDY

needs to include CREDIT_BLOCKED

transmitter (see 7.18.5 and 7.18.5.2), and the communication to the port layer, SMP transport layer, and management application layer. Only the SMP link layer (i.e., not the port, transport, or application layer) transmits dwords.

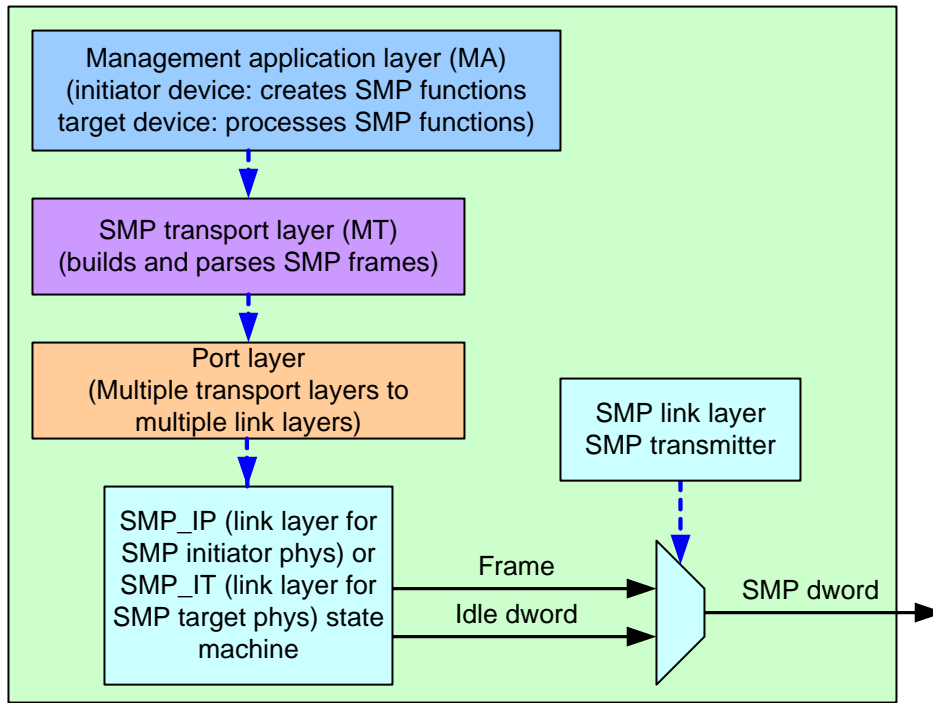

Figure 33 — SMP link, port, SMP transport, and management application layer state machines

Figure 34 shows the transmit data path for the STP link layer, including the SSP state machines and the SSP

This page contains no comments

transmitter (see 7.17.8), and communication to the port layer, STP transport layer, and ATA application layer. Only the STP link layer (i.e., not the port, transport, or application layer) transmits dwords.

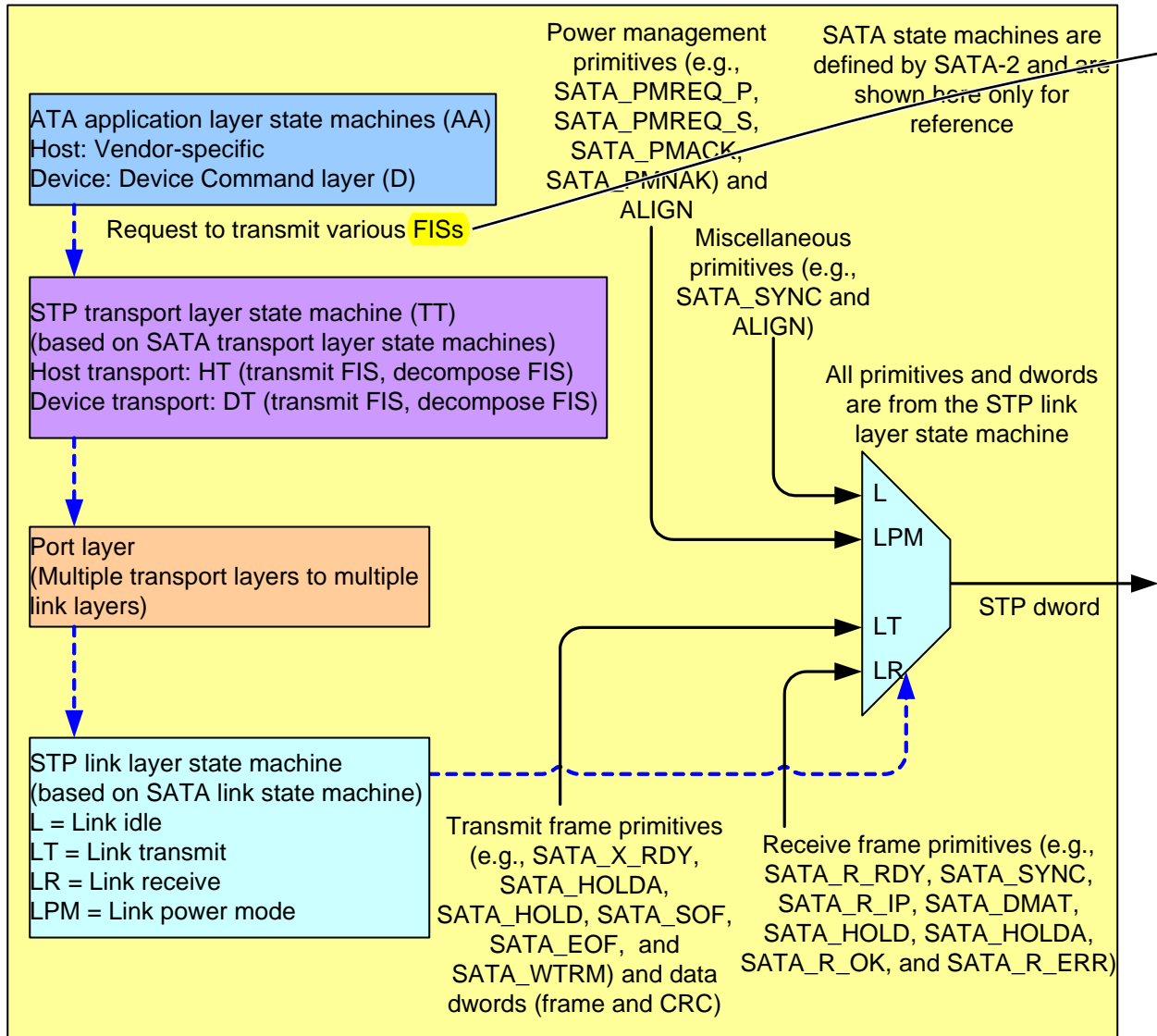

Figure 34 — STP link, port, STP transport, and ATA application layer state machines

Figure 35 shows the transmit data path in an expander phy, showing the relationship between:

- the SP state machine (see 6.8) and the SP transmitter (see 6.8.2);
- multiplexing (see 6.10);
- the SL_IR state machines (see 7.9.4) and the SL_IR transmitter (see 7.9.4.2);
- physical link rate tolerance management (see 7.3); and

● Author: Isi-bbesmer
Subject: Highlight
Date: 5/6/2008 4:07:48 PM

T ACCEPT - DONE

FISs

s/b

FISes

(FISes used in several other locations)

e) the XL state machines (see 7.15) and the XL transmitter (see 7.15.2).

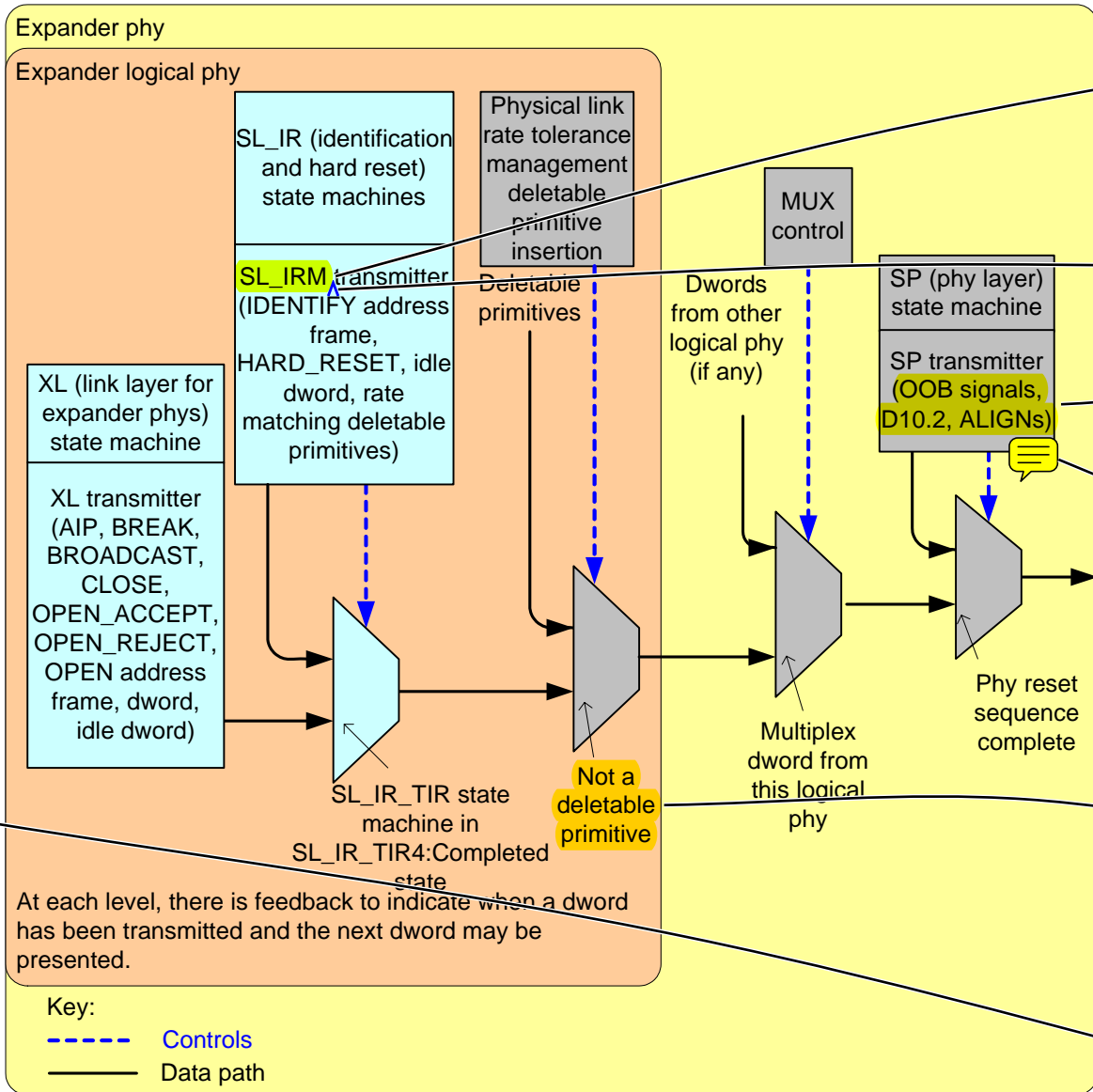

Figure 35 — Transmit data path and state machines in an expander phy

4.3.3 Receive data path

The SP_DWS receiver (see 6.9.2) establishes dword synchronization and sends dwords to the SP_DWS state machine (see 6.9) and to the link layer state machine receivers.

If multiplexing (see 6.10) is enabled (see table 100 in 6.7.4.2.3.3), the SP_DWS receiver uses incoming MUX primitives to determine the logical link numbers and route the dwords to the appropriate link layer receivers.

Figure 36 shows the receive data path in a SAS phy, showing the relationship between:

- the SP_DWS state machine (see 6.9) and the SP_DWS receiver (see 6.9.2);
- the SL_IR state machines (see 7.9.4) and the SL_IR receiver (see 7.9.4.2);
- the SL state machines (see 7.14) and the SL receiver (see 7.14.2); and
- the SSP receiver (see 7.16.8.2), SMP receiver (see 7.18.5.2), and STP receiver (see 7.17.8).

Page: 65

● Author: ktek-dmoore
Subject: Highlight
Date: 5/6/2008 4:07:48 PM
 ACCEPT - DONE (just SL_IR)

SL_IRM

s/b: SL_IR or SL_IR_TIR

● Author: mxim-mbari
Subject: Inserted Text
Date: 5/6/2008 4:07:48 PM
 ACCEPT - DONE
SL_IRM is mentioned, but is not described anywhere. (SL_IR is through out the document)

● Author: RElliott
Subject: Highlight
Date: 8/31/2008 5:51:53 PM
 ACCEPT - DONE
OOB signals, D10.2, ALIGNs

Add TRAIN pattern and TRAIN_DONE pattern to the list to match intc-mseidel comment on figure 31

● Author: RElliott
Subject: Note
Date: 8/31/2008 5:52:10 PM
 ACCEPT - DONE

ALIGNs
s/b
ALIGN

● Author: RElliott
Subject: Highlight
Date: 6/30/2008 6:16:52 PM
 ACCEPT - DONE

Not a deletable primitive
s/b
Not a physical link rate tolerance management deletable primitive

● Author: hpq-relliott
Subject: Note
Date: 6/11/2008 11:31:17 AM
 REJECT (6/11)

Add more specific MUX controls in the Transmit data path for expander phy figure

● Author: RElliott
Subject: Highlight
Date: 6/30/2008 6:16:52 PM
 ACCEPT - DONE

the
s/b
then the

See figure 168 in 7.3.1 for more information about the elasticity buffer, which is not shown in figure 36.

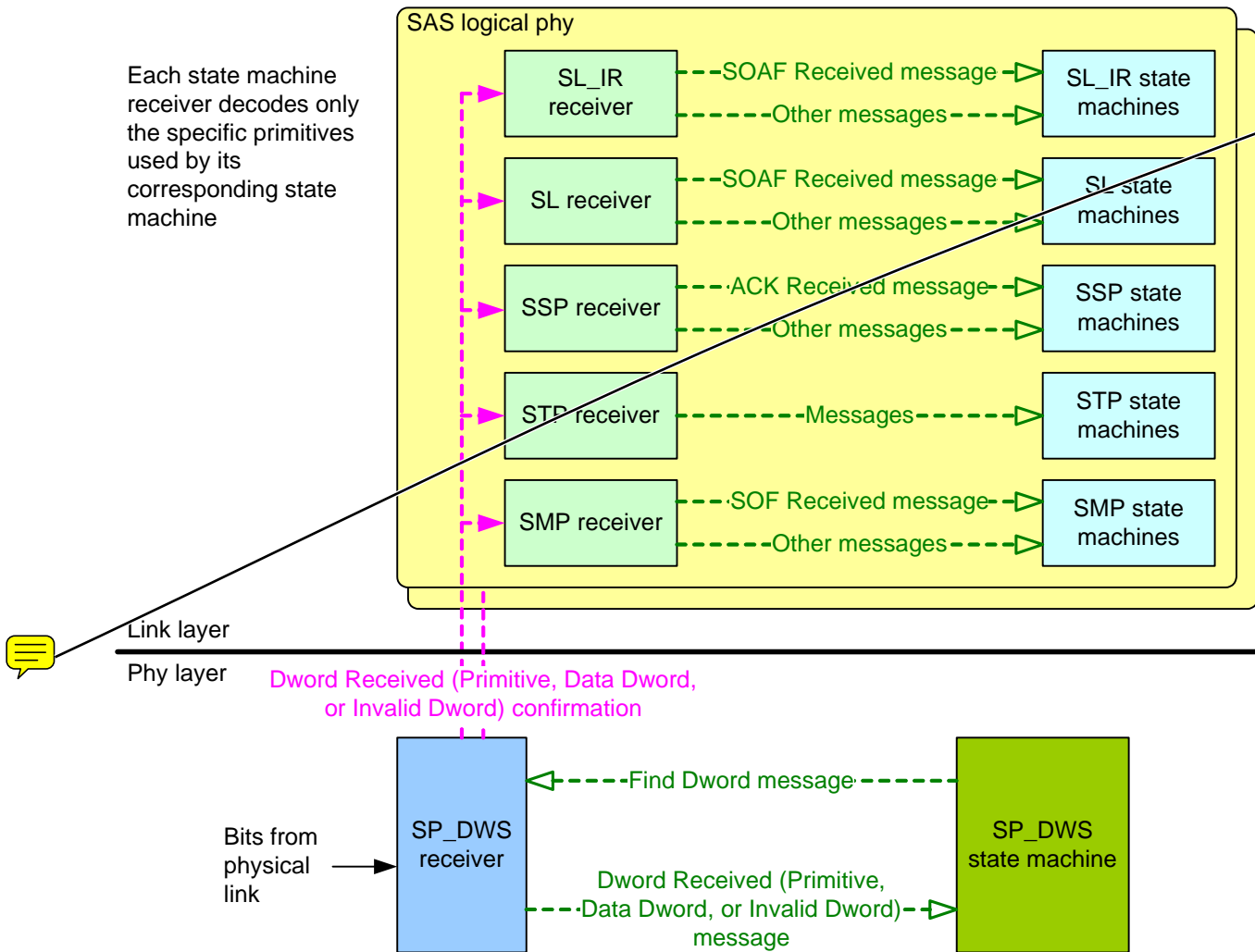

Figure 36 — Receive data path in a SAS phy

Figure 37 shows the receive data path in an expander phy showing the relationship between:

- a) the SP_DWS state machine (see 6.9) and the SP_DWS receiver (see 6.9.2);
- b) the SL_IR state machines (see 7.9.4) and the SL_IR receiver (see 7.9.4.2); and
- c) the XL state machines (see 7.15) and the XL receiver (see 7.15.2).

Author: RElliott

Subject: Note

Date: 6/30/2008 6:16:52 PM

 ACCEPT - DONE

Add messages to figure 35 Receive data path:

1. Add message from the SW_DWS to SP_DWS receiver:

Sync Acquired: this lets the SP_DWS receiver know when to start sending Dword Received confirmations to the link layer. Find Dword tells it when to stop.

2. Add the SP receiver and SP state machine

3. Add messages from the SP_DWS to SP receiver

Sync Acquired: the lets it know when to start sending ALIGN Received, TRAIN_DONE Received, and Dword Received messages to the SP state machine

Sync Lost: this lets it know when to stop sending them

4. Add messages from the SP state machine to the SP receiver:

ALIGN Received

TRAIN_DONE Received

Dword Received

Other messages

See figure 168 in 7.3.1 for more information about the elasticity buffer, which is not shown in figure 37.

Each state machine receiver decodes only the specific primitives used by its corresponding state machine

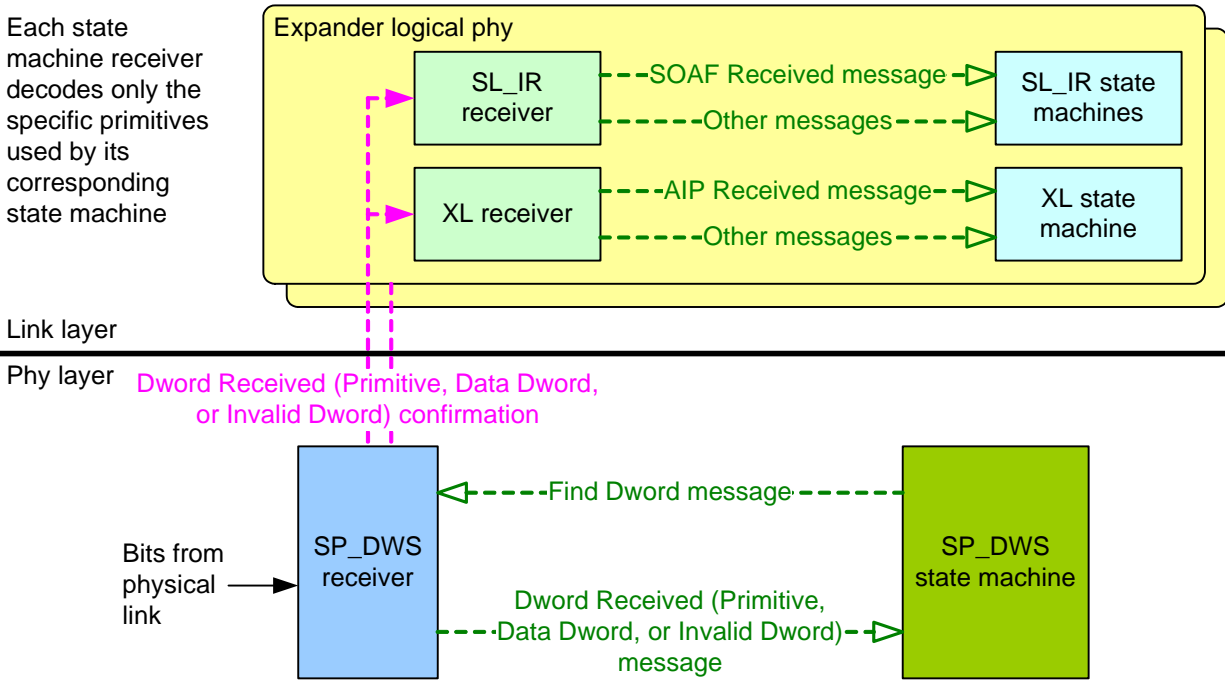

Figure 37 — Receive data path in an expander phy

This page contains no comments

4.3.4 State machines and SAS Device, SAS Port, and SAS Phy classes

Figure 38 shows which state machines are contained within the SAS Device, SAS Port, and SAS Phy classes.

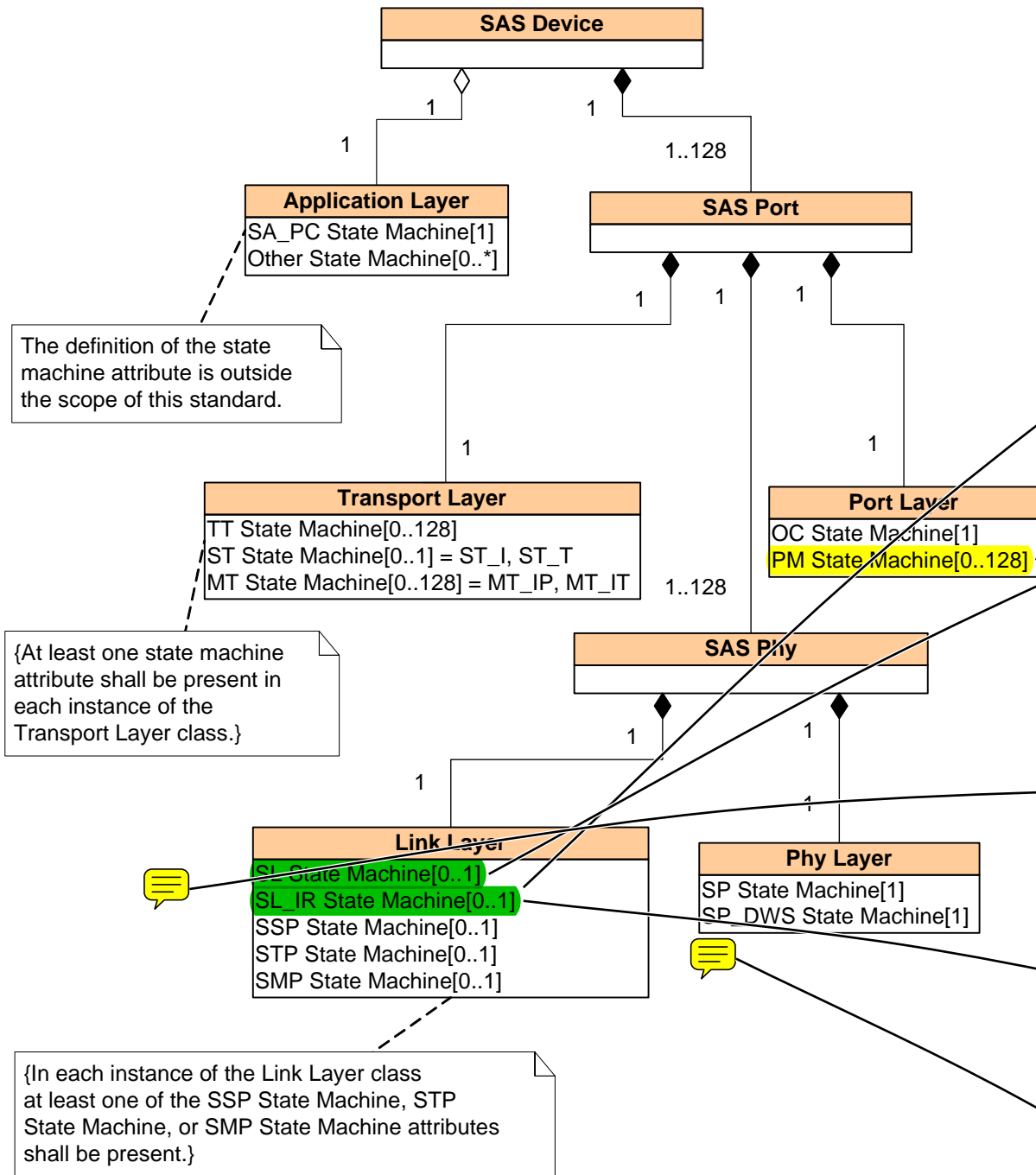



Figure 38 — State machines and SAS Device classes

Page: 68

Author: ktek-dmoore

Subject: Highlight

Date: 5/25/2008 5:59:32 PM

 REJECT (no, a SAS port can exist with all its phys gone. Notice how PL_OC has a message called Transmission Status(No Phys In Port). This is different than an expander port (covered by the next figure), however, which must always have a phy.)

PM State Machine[0..128]

Shouldn't this be 1...128? If you have a port you must have at least one PM?

Author: ktek-dmoore

Subject: Highlight

Date: 6/5/2008 6:37:12 PM

 ACCEPT - DONE (added a SAS Logical Phy class with 1..2 of them per SAS Phy.)

SL State Machine[0..1]

SL_IR State Machine[0..1]

I don't understand, shouldn't there be at least one of each of these and two if muxing is enabled?

Author: stx-goulder

Subject: Highlight

Date: 6/5/2008 7:38:32 PM

 ACCEPT - DONE (added sentence in 4.1.2 explaining the general concept; changed these to [1]. That's simpler than trying to represent this concept in UML. 5/5 virtual SAS phys don't necessarily have SL. Add a note, not a constraint, to the UML diagram explaining that virtual phys use 0. Add 0.. to the phy layer attributes. Check elsewhere to ensure that there is no statement that an SL must be present.)

SL State Machine[0..1]

It appear to me that every link layer shall include SL state machine, so the brackets should be [1].

Author: RElliott

Subject: Note

Date: 6/30/2008 6:16:52 PM

 ACCEPT - DONE

SL, SL_IR, SSP, and SMP should be plural Machines rather than Machine, since there are more than one in each (e.g., SL really consists of SL_RA and SL_CC). STP state machines are not defined, but for consistency, make it plural as well.

Also fix the note.

Author: stx-goulder

Subject: Highlight

Date: 6/9/2008 4:09:32 PM

 ACCEPT - DONE (virtual SAS phys don't necessarily have SL_IR. However, for simplicity of the UML model, changed this to [1]. See response to stx-goulder comment on SL State Machine[0..1])

SL_IR State Machine[0..1]

It appear to me that every link layer shall include SL_IR state machine, so the brackets should be [1].

Author: RElliott

Subject: Note

Date: 6/30/2008 6:16:52 PM

 ACCEPT - DONE (added sentence in 4.1.2 explaining that general concept)

virtual SAS phys don't necessarily have SP and SP_DWS

Figure 39 shows which state machines are contained within the Expander Device, Expander Port, and Expander Phy classes.

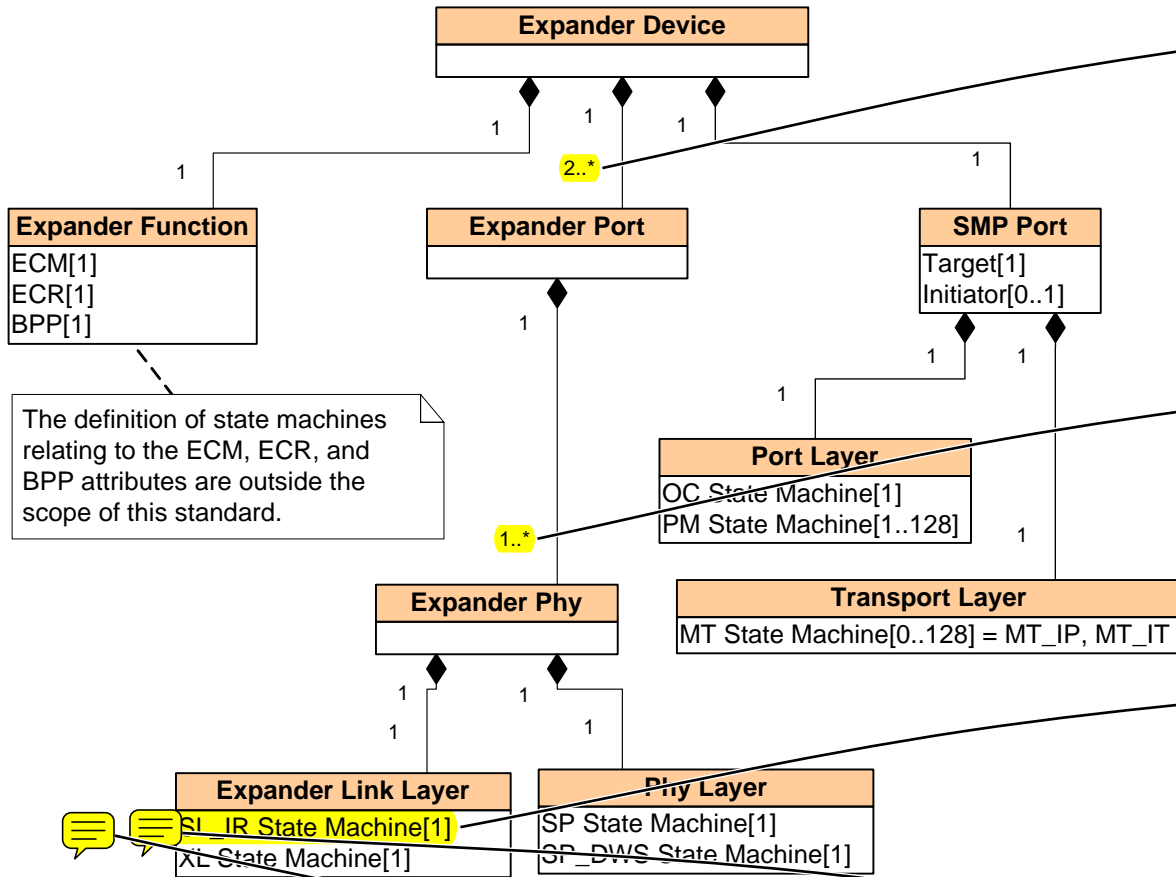

Figure 39 — State machines and Expander Device classes

4.4 Resets

4.4.1 Reset overview

Figure 40 illustrates the reset terminology used in this standard:

- link reset sequence;
- phy reset sequence (see 6.7);
- SATA OOB sequence (see 6.7.2.1);
- SATA speed negotiation sequence (see 6.7.2.2);
- SAS OOB sequence (see 6.7.4.1);
- SAS speed negotiation sequence (see 6.7.4.2);
- hard reset sequence (see 7.9); and
- identification sequence (see 7.9).

Page: 69

Author: RElliott
Subject: Highlight
Date: 6/30/2008 6:16:52 PM
 ACCEPT - DONE

2..*
s/b
2..255

since there are not unlimited phys in an expander device, there are not unlimited ports. Per Isi-bbesmer comment, the number of phys is growing to 255 (max phy identifier 254). Therefore, this should be 2..254.

Author: RElliott
Subject: Highlight
Date: 6/30/2008 6:16:52 PM
 ACCEPT - DONE

1..*
s/b
1..255

since the number of phys is not unbounded.

Author: ktek-dmoore
Subject: Highlight
Date: 6/5/2008 7:31:18 PM
 ACCEPT - DONE (added Expander Logical Phy class, 1..2 of them per Expander Phy.)

SL_IR State Machine[1]

If phy is muxing capable, is this [1..2]?

What about the XL state machine?

Author: RElliott
Subject: Note
Date: 6/30/2008 6:16:52 PM
 ACCEPT - DONE
SL_IR State Machine
s/b
SL_IR State Machines

Author: RElliott
Subject: Note
Date: 6/30/2008 6:16:52 PM
 ACCEPT - DONE (added sentence in 4.1.2 about this general issue)

virtual expander phys don't necessarily have XL and SL_IR, or SP and SP_DWS

Author: hpq-relliott
Subject: Highlight
Date: 5/6/2008 4:07:48 PM
 ACCEPT - DONE
machine s
s/b
machines

Author: wdc-mevans
Subject: Highlight
Date: 5/6/2008 4:07:48 PM

Comments from page 69 continued on next page

Figure 39 shows which state machines are contained within the Expander Device, Expander Port, and Expander Phy classes.

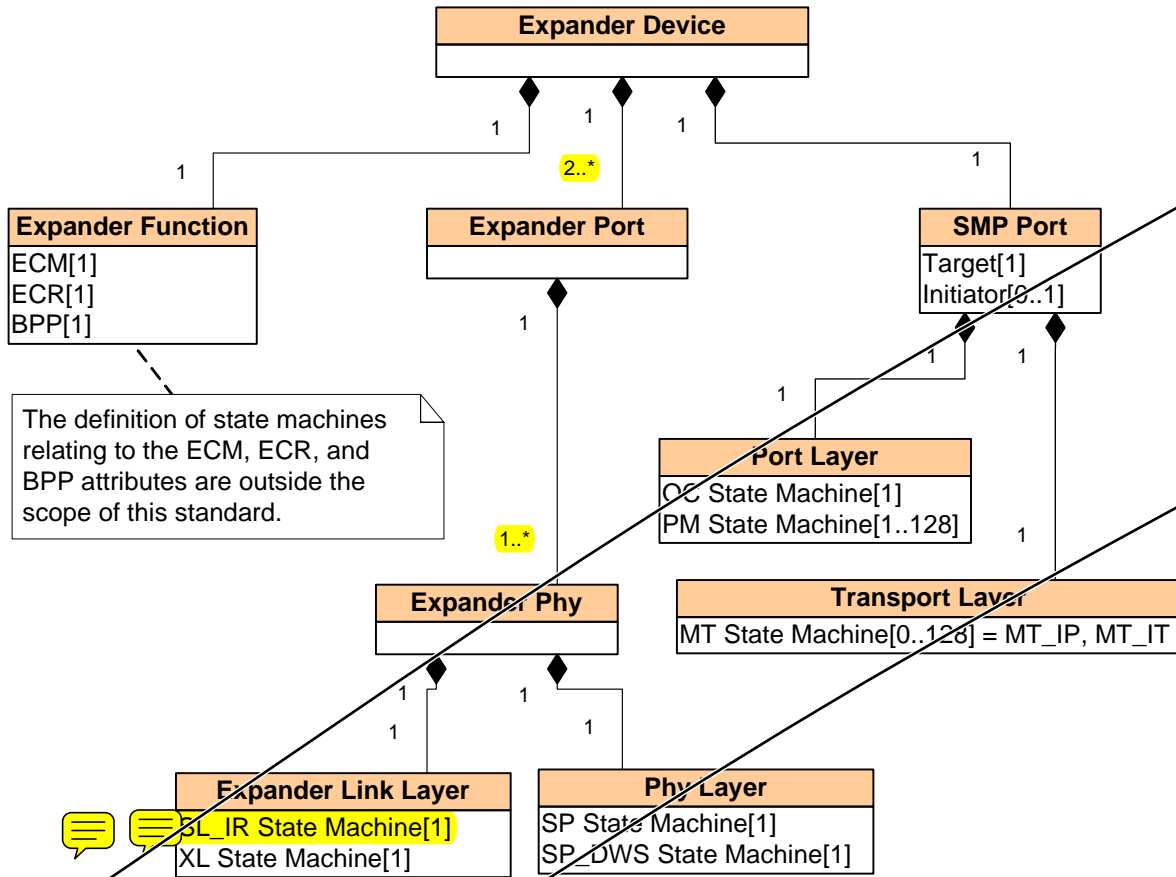

Figure 39 — State machines and Expander Device classes

4.4 Resets

4.4.1 Reset overview

Figure 40 illustrates the reset terminology used in this standard:

- link reset sequence;
- phy reset sequence (see 6.7);
- SATA OOB sequence (see 6.7.2.1);
- SATA speed negotiation sequence (see 6.7.2.2);
- SAS OOB sequence (see 6.7.4.1);
- SAS speed negotiation sequence (see 6.7.4.2);
- hard reset sequence (see 7.9); and
- identification sequence (see 7.9).

T ACCEPT - DONE
machine s
s/b
machines

● Author: hpq-relliott
Subject: Note
Date: 6/23/2008 6:30:40 PM

 ACCEPT - DONE (added SMP Phy, SMP Logical Phy, and Link Layer. SMP Phy contains Phy Layer (sharing it with Expander Phy))

This figure does not show an SMP phy and associated link layer state machines below the SMP Port since figure 16 does not do so. If the expander allows more than one connection at a time to its SMP target port, then it's effectively a wide SMP port and has multiple phys and link layers. If it only allows one at a time, then it's effectively a narrow SMP port and only has one phy and link layer.

● Author: RElliott
Subject: Highlight
Date: 7/17/2008 6:01:44 PM

T ACCEPT - DONE (7/15 global change "illustrates" to "shows" in cases like this.)

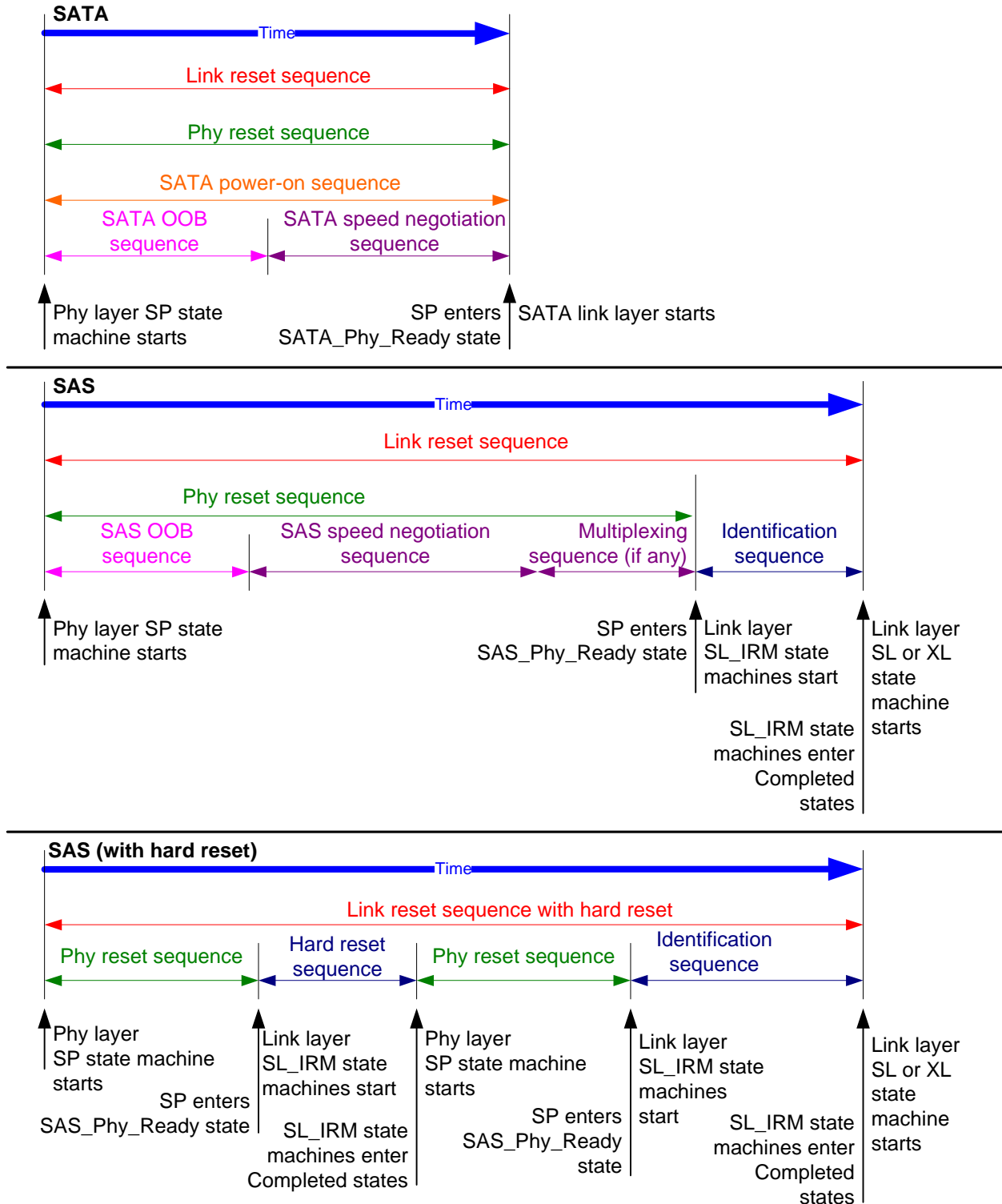

Figure 40 — Reset terminology

The phy reset sequences, including the OOB sequence, the speed negotiation sequence, and the multiplexing sequence, if any, are implemented by the SP state machine and are described in 6.7 and 6.8. The hard reset sequence and identification sequence are implemented by the SL_IR state machine and are described in 7.9.

Author: RElliott
Subject: Highlight
Date: 6/30/2008 6:16:52 PM

T ACCEPT - DONE

SP state machine... in 6.7 and 6.8

s/b

SP state machine and the SP_DWS state machine... in 6.7, 6.8, and 6.9

because SP_DWS is also very involved

The link reset sequence has no effect on the transport layer and application layer. The HARD_RESET primitive sequence may be used during the identification sequence to initiate a hard reset. The link reset sequence serves as a hard reset for SATA devices (see SATA-2).

4.4.2 Hard reset

4.4.2.1 Hard reset overview

After the phy reset sequence, if a phy receives a HARD_RESET primitive before an IDENTIFY address frame, **it shall be considered a reset event and initiate a hard reset of the port containing that phy.**

When a port processes a hard reset, it shall stop transmitting valid dwords on each of the phys contained in that port. Each phy may then participate in new phy reset sequences (e.g., respond to incoming COMINITs) and shall originate a new link reset sequence if one is not detected. The hard reset shall not affect any other ports in the device.

If a SAS device is contained in an expander device, its SSP ports, STP ports, and/or SATA ports shall initiate a hard reset when an SMP PHY CONTROL function with a phy operation of HARD_RESET and phy identifier specifying a virtual expander phy attached to such a SAS port is processed (see 10.4.3.28).

4.4.2.2 Additional hard reset processing by SAS ports

If the port processing the hard reset is an SSP port, **the** hard reset causes a Transport Reset event notification to the SCSI application layer (see 10.2.5), and the SCSI device shall perform the actions defined for hard reset in SAM-4. After processing the hard reset, each logical unit to which the SSP target port has access shall establish a unit attention condition for all SSP initiator ports with the additional sense code set to SCSI BUS RESET OCCURRED (see SAM-4 and SPC-4).

If the port processing the hard reset is an STP port in an STP/SATA bridge, **the** SATA host port shall originate a link reset sequence.

If the port processing the hard reset is an STP port that is not in an STP/SATA bridge, **the** STP target device shall perform the actions defined for power-on or hardware reset in ATA8-AAM.

4.4.2.3 Additional hard reset processing by expander ports

If the port processing a hard reset is an expander port, **the** expander device shall not originate a hard reset sequence on any of its other phys.

If the port processing a hard reset is an expander port, **the** expander function and other expander ports in the expander device shall not be affected by hard reset. SAS devices contained in the expander device shall not be affected by hard resets received by external expander ports in the expander device.

4.5 I_T nexus loss

When a SAS port receives OPEN_REJECT (NO DESTINATION), OPEN_REJECT (PATHWAY BLOCKED), OPEN_REJECT (RESERVED INITIALIZE 0), OPEN_REJECT (RESERVED INITIALIZE 1), OPEN_REJECT (RESERVED STOP 0), OPEN_REJECT (RESERVED STOP 1), or an Open Timeout timer expires (see 7.12.2) in response to a connection request, **it** shall retry the connection request until:

- a) the connection is established;
- b) for SSP target ports, the time indicated by the I_T NEXUS LOSS TIME field in the Protocol-Specific Port mode page (see 10.2.7.4) expires; or
- c) the I_T nexus loss timer, if any, expires (see 4.7.1, 8.2.2.1, 10.2.7.4, and 10.4.3.18).

An I_T nexus loss occurs in a SAS port when:

- a) the I_T nexus loss timer expires; or
- b) the SAS port receives an abandon-class OPEN_REJECT (see table 122 in 7.2.6.10).

I_T nexus loss is handled by the port layer state machines (see 8.2.2.3). In some cases, the I_T nexus loss timer is overridden for connection requests through self-configuring expander devices as described in 4.7.1.

Page: 71

Author: RElliott
Subject: Underline
Date: 6/30/2008 6:16:52 PM
ACCEPT - DONE

The HARD_RESET primitive sequence may be used during the identification sequence to initiate a hard reset.

s/b

A hard reset sequence replaces the identification sequence to initiate a hard reset.

to not change levels (this section is not talking about IDENTIFY address frames, so should not be talking about HARD_RESET primitives)

Author: wdc-mevans
Subject: Highlight
Date: 5/22/2008 4:40:38 PM

ACCEPT - DONE (as "then the phy shall consider this to be a reset event causing a hard reset of the port containing that phy...").
Also see similar wording in 7.9.1)

it shall be considered a reset event and initiate a hard reset of the port containing that phy.

s/b

then this shall be considered a reset event, and the port containing the phy shall process a hard reset.

Author: RElliott
Subject: Highlight
Date: 6/30/2008 6:16:52 PM
ACCEPT - DONE

the

s/b

then the

Author: wdc-mevans
Subject: Highlight
Date: 5/6/2008 4:07:48 PM
ACCEPT - DONE

to the

s/b

to be sent to the

Author: Isi-bbesmer
Subject: Note
Date: 5/25/2008 6:00:53 PM

REJECT (I don't think so. SAM defines that hard reset causes a unit attention condition and SAS already steps on its toes by repeating the additional sense code in this paragraph. Other parts of SAS explains that unit attention conditions beget Broadcast (Asynchronous Event)s. In the definition of Broadcast (Asynchronous Event), though, I will add an "(e.g. hard reset)" to the definition)

Should BROADCAST(ASYNC) be mentioned here?

Author: RElliott
Subject: Highlight
Date: 6/30/2008 6:16:52 PM
ACCEPT - DONE

the

s/b

then the

Author: RElliott
Subject: Highlight
Date: 6/30/2008 6:16:52 PM

The link reset sequence has no effect on the transport layer and application layer. The HARD_RESET primitive sequence may be used during the identification sequence to initiate a hard reset. The link reset sequence serves as a hard reset for SATA devices (see SATA-2).

4.4.2 Hard reset

4.4.2.1 Hard reset overview

After the phy reset sequence, if a phy receives a HARD_RESET primitive before an IDENTIFY address frame, **it shall be considered a reset event and initiate a hard reset of the port containing that phy.**

When a port processes a hard reset, it shall stop transmitting valid dwords on each of the phys contained in that port. Each phy may then participate in new phy reset sequences (e.g., respond to incoming COMINITs) and shall originate a new link reset sequence if one is not detected. The hard reset shall not affect any other ports in the device.

If a SAS device is contained in an expander device, its SSP ports, STP ports, and/or SATA ports shall initiate a hard reset when an SMP PHY CONTROL function with a phy operation of HARD_RESET and phy identifier specifying a virtual expander phy attached to such a SAS port is processed (see 10.4.3.28).

4.4.2.2 Additional hard reset processing by SAS ports

If the port processing the hard reset is an SSP port, **the** hard reset causes a Transport Reset event notification **to the** SCSI application layer (see 10.2.5), and the SCSI device shall perform the actions defined for hard reset in SAM-4. After processing the hard reset, each logical unit to which the SSP target port has access shall establish a unit attention condition for all SSP initiator ports with the additional sense code set to SCSI BUS RESET OCCURRED (see SAM-4 and SPC-4). 

If the port processing the hard reset is an STP port in an STP/SATA bridge, **the** SATA host port shall originate a link reset sequence.

If the port processing the hard reset is an STP port that is not in an STP/SATA bridge, **the** STP target device shall perform the actions defined for power-on or hardware reset in ATA8-AKM.

4.4.2.3 Additional hard reset processing by expander ports

If the port processing a hard reset is an expander port, **the** expander device shall not originate a hard reset sequence on any of its other phys.

If the port processing a hard reset is an expander port, **the** expander function and other expander ports in the expander device shall not be affected by hard reset. SAS devices contained in the expander device shall not be affected by hard resets received by external expander ports in the expander device.

4.5 I_T nexus loss

When a SAS port receives OPEN_REJECT (NO DESTINATION), OPEN_REJECT (PATHWAY BLOCKED), OPEN_REJECT (RESERVED INITIALIZE 0), OPEN_REJECT (RESERVED INITIALIZE 1), OPEN_REJECT (RESERVED STOP 0), OPEN_REJECT (RESERVED STOP 1), or an Open Timeout timer expires (see 7.12.2) in response to a connection request, **it** shall retry the connection request until:

- a) the connection is established;
- b) for SSP target ports, the time indicated by the I_T NEXUS LOSS TIME field in the Protocol-Specific Port mode page (see 10.2.7.4) expires; or
- c) the I_T nexus loss timer, if any, expires (see 4.7.1, 8.2.2.1, 10.2.7.4, and 10.4.3.18).

An I_T nexus loss occurs in a SAS port when:

- a) the I_T nexus loss timer expires; or
- b) the SAS port receives an abandon-class OPEN_REJECT (see table 122 in 7.2.6.10).

I_T nexus loss is handled by the port layer state machines (see 8.2.2.3). In some cases, the I_T nexus loss timer is overridden for connection requests through self-configuring expander devices as described in 4.7.1.

T ACCEPT - DONE
the
s/b
then the

● Author: RElliott
Subject: Highlight
Date: 6/30/2008 6:16:52 PM
T ACCEPT - DONE
the
s/b
then the

● Author: RElliott
Subject: Highlight
Date: 6/30/2008 6:16:52 PM
T ACCEPT - DONE
the
s/b
then the

● Author: wdc-mevans
Subject: Highlight
Date: 5/25/2008 6:01:12 PM
T REJECT (first noun/subject convention)
it
s/b
the SAS port

If an I_T nexus loss occurs in an SSP port, then the port shall send a Nexus Loss event notification to the SCSI application layer (see 10.2.5) and the SCSI device shall perform the actions defined for I_T nexus loss in SAM-4. If an I_T nexus loss occurs in an SSP initiator port, a SCSI application client should send an I_T NEXUS RESET task management function to the SSP target port when it reestablishes communication.

If an I_T nexus loss occurs in an STP initiator port, then the STP initiator port shall send a Transport Event Notification (Nexus Loss, [Device]) indication to the ATA application client (i.e., create a nexus loss event)(see ATA8-AAM). The ATA application client shall consider any commands for the lost STP target port to be completed with an error.

If an I_T nexus loss occurs in an STP target port, then the ATA device server shall abort all outstanding commands for the lost STP initiator port. If the STP target port is in an STP/SATA bridge, the STP/SATA bridge shall originate a link reset sequence to the SATA device so the ATA device server in the SATA device aborts all outstanding commands.

If an I_T nexus loss occurs in an SMP initiator port, then the port shall stop attempting to establish connections to the lost SMP target port.

If an I_T nexus loss occurs in an initiator port due to I_T nexus loss timer expiration, then a management application client should cause a link reset sequence on the phy(s) attached to the lost target port (e.g, if directly attached, the phys in the initiator port; if attached via expander device(s), the phys in the expander device closest to and attached to the target port).

4.6 Expander device model

4.6.1 Expander device model overview

An expander device shall contain the following:

- a) an expander function containing:
 - A) expander connection manager (ECM)(see 4.6.3);
 - B) expander connection router (ECR)(see 4.6.4); and
 - C) Broadcast propagation processor (BPP)(see 4.6.5);
- b) two or more physical expander phys. For the maximum number of phys, see 4.1.7;
- c) an expander port available per phy; and
- d) an SMP target port and a management device server.

An expander device may contain:

- a) an SMP initiator port and a management application client; and/or
- b) SAS devices with SSP ports, STP ports, and/or SMP ports and their associated device servers and/or application clients.

Page: 72

● Author: wdc-mevans
Subject: Highlight
Date: 5/6/2008 4:07:48 PM
T REJECT (only 2 things being ANDED)
10.2.5) and
s/b
10.2.5), and

● Author: wdc-mevans
Subject: Highlight
Date: 5/25/2008 6:01:35 PM
T ACCEPT - DONE (as "during the next connection between that SSP initiator port and that SSP target port." Especially need to send this if the target opens the initiator; this wording is a bit less initiator-biased.)

it reestablishes communication.
s/b
the initiator port next establishes a connection with that target port.

● Author: RElliott
Subject: Highlight
Date: 6/30/2008 6:16:52 PM
T ACCEPT - DONE
the
s/b
then the

● Author: RElliott
Subject: Highlight
Date: 6/30/2008 6:16:52 PM
T ACCEPT - DONE
the
s/b
then the

● Author: RElliott
Subject: Highlight
Date: 6/30/2008 6:16:52 PM
T ACCEPT - DONE
the
s/b
then the

● Author: lsi-bbesmer
Subject: Cross-Out
Date: 5/6/2008 4:07:48 PM
T ACCEPT - DONE
closest to and

● Author: wdc-mevans
Subject: Highlight
Date: 5/6/2008 4:07:48 PM
T ACCEPT - DONE
expander
s/b
an expander

Comments from page 72 continued on next page

If an I_T nexus loss occurs in an SSP port, then the port shall send a Nexus Loss event notification to the SCSI application layer (see 10.2.5) and the SCSI device shall perform the actions defined for I_T nexus loss in SAM-4. If an I_T nexus loss occurs in an SSP initiator port, a SCSI application client should send an I_T NEXUS RESET task management function to the SSP target port when it reestablishes communication.

If an I_T nexus loss occurs in an STP initiator port, then the STP initiator port shall send a Transport Event Notification (Nexus Loss, [Device]) indication to the ATA application client (i.e., create a nexus loss event) (see ATA8-AAM). The ATA application client shall consider any commands for the lost STP target port to be completed with an error.

If an I_T nexus loss occurs in an STP target port, then the ATA device server shall abort all outstanding commands for the lost STP initiator port. If the STP target port is in an STP/SATA bridge, the STP/SATA bridge shall originate a link reset sequence to the SATA device so the ATA device server in the SATA device aborts all outstanding commands.

If an I_T nexus loss occurs in an SMP initiator port, then the port shall stop attempting to establish connections to the lost SMP target port.

If an I_T nexus loss occurs in an initiator port due to I_T nexus loss timer expiration, then a management application client should cause a link reset sequence on the phy(s) attached to the lost target port (e.g, if directly attached, the phys in the initiator port; if attached via expander device(s), the phys in the expander device ~~closest to and~~ attached to the target port).

4.6 Expander device model

4.6.1 Expander device model overview

An expander device shall contain the following:

- a) an expander function containing:
 - A) expander connection manager (ECM)(see 4.6.3);
 - B) expander connection router (ECR)(see 4.6.4); and
 - C) Broadcast propagation processor (BPP)(see 4.6.5);
- b) two or more physical expander phys. For the maximum number of phys, see 4.1.7;
- c) an expander port available per phy; and
- d) an SMP target port and a management device server.

An expander device may contain:

- a) an SMP initiator port and a management application client; and/or
- b) SAS devices with SSP ports, STP ports, and/or SMP ports and their associated device servers and/or application clients.

● Author: wdc-mevans
Subject: Highlight
Date: 5/6/2008 4:07:48 PM
T ACCEPT - DONE
expander
s/b
an expander

● Author: wdc-mevans
Subject: Highlight
Date: 5/6/2008 4:07:48 PM
T ACCEPT - DONE
Broadcast
s/b
a Broadcast

● Author: elx-bmartin
Subject: Comment on Text
Date: 5/25/2008 6:02:13 PM
T ACCEPT - DONE (deleting this. It was probably once pointing to the phy identifier section, but lost its way. Since the definition of SAS port does not mention there is an implied maximum number of phys in a port, it seems safe to drop that here too.)

4.1.7 does not specify a maximum number of phys in the expander.

● Author: lsi-bbesmer
Subject: Highlight
Date: 5/25/2008 6:40:01 PM
T ACCEPT - DONE (see response to elx-bmartin comment)

maximum number of phys is not specified in 4.1.7

Figure 41 shows a model of an expander device showing the state machines in each expander port. The internal SMP ports are not shown.

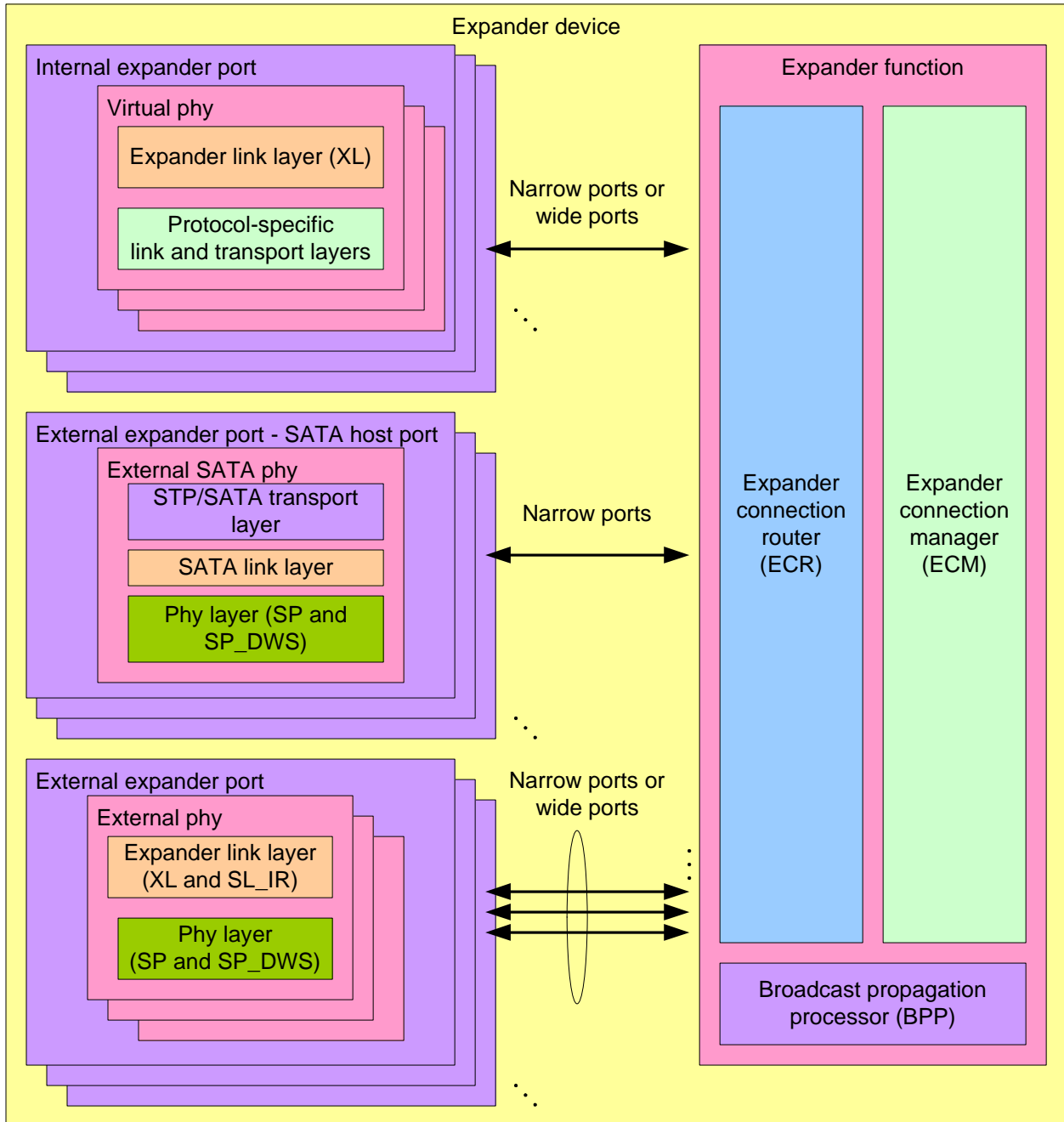

Figure 41 — Expander device model

4.6.2 Expander ports

An external expander port contains one or more physical phys (see 4.1.2). Since each phy in the expander device has the same SAS address, expander ports are created based on the attached SAS addresses (see 4.1.4).

Each phy in an expander port shall have the same routing attribute (see 4.6.7.1). The management device server shall return the same value in the ROUTING ATTRIBUTE field for each phy in an expander port in the SMP DISCOVER response (see 10.4.3.10).

This page contains no comments

Each phy in an expander port containing phys with table routing attributes in an externally configurable expander device shall have the same number of routing table entries (see 4.6.7.3).

A set of expander phys with table routing attributes in an expander device not supporting table-to-table attachments using the same external connector (see 5.2.3.3) is called an enclosure out port. A set of expander phys with subtractive routing attributes using the same external connector is called an enclosure in port. A set of expander phys with table routing attributes in an expander device supporting table-to-table attachments using the same external connector is called an enclosure universal port.

Each phy in an expander port shall have the same zone phy information (see 4.9.3.1). The zone phy information associated with each of the phys in an expander port is treated as the zoning properties of the expander port.

~~Each expander logical phy contains an expander link layer with an XL state machine (see 7.15) and an SL_IR state machine (see 7.9.4). The XL state machine in each expander logical phy within an expander port processes connection requests independently of the XL state machines in other expander logical phys.~~

An internal expander port contains a virtual phy with an expander link layer and a protocol-specific transport layer (e.g., to provide access as an SSP target port to a logical unit with a peripheral device type set to 0Dh (i.e., enclosure services device) (see SPC-4 and SES-2)).

Each expander device shall include one internal SMP port using the expander device's SAS address.

Any additional internal SAS ports shall be inside SAS devices contained in the expander **device, and thus have SAS addresses different** from that of the expander device. These SAS ports shall be attached to internal expander ports with virtual phys.

Each STP/SATA bridge shall have a unique SAS address. This SAS address is reported in the ATTACHED SAS ADDRESS field in the SMP DISCOVER response (see 10.4.3.10) for the expander phy containing the STP/SATA bridge (i.e., the expander phy attached to the SATA device or SATA port selector).

4.6.3 Expander connection manager (ECM)

The ECM performs the following functions:

- a) maps a destination SAS address in a connection request to a destination phy using direct, subtractive, or table routing methods;
- b) arbitrates and assigns or denies path resources for connection requests following SAS arbitration and pathway recovery rules; and
- c) configures the ECR.

4.6.4 Expander connection router (ECR)

The ECR routes messages between pairs of expander logical phys as configured by the ECM. Enough routing resources shall be provided to support at least one connection.

~~When forwarding dwords during a connection from a **source** phy with a higher **physical** link rate to a **destination** phy with a lower **physical** link rate, rate matching (see 7.13) ensures the dwords are at a connection rate equal to or less than the lower **physical** link rate. However, the ECR may be requested to forward more dwords than the **destination** phy is able to accept if:~~

- a) an invalid dword occurs during a deletable primitive;
- b) an invalid dword occurs during a CLOSE; or
- c) multiple invalid dwords occur during a BREAK.

The ECR may discard dwords if needed and count them as elasticity buffer overflows (see 4.11).

When forwarding dwords from a SATA physical link with a higher physical link rate to a SAS logical link with a lower logical link rate, the SATA host port in the STP/SATA bridge shall throttle incoming FISes with SATA_HOLD (see 7.17.2).

NOTE 14 - If SATA_HOLD is **deasserted for n dwords, the SATA device sends** up to (21+n) more data dwords. SATA_HOLD does not affect primitives (see SATA-2). The STP/SATA bridge may expand or contract repeated and continued primitives without changing their functional meaning.

Page: 74

Author: RElliott
Subject: Highlight
Date: 6/30/2008 6:16:52 PM

T REJECT (general rule added in 4.1.2 that virtual phys have vendor-specific variations of state machines should suffice)

Each expander logical phy contains an expander link layer with an XL state machine (see 7.15) and an SL_IR state machine (see 7.9.4).

This is not necessarily true for virtual phys, where this interface is vendor-specific. It has to behave as if it has an XL state machine, forwarding connection requests internally, but they're not transmitted as frames by an XL transmitter. The meaning of SL_IR is simply that it must know the attached SAS address.

Author: RElliott
Subject: Note
Date: 6/30/2008 6:16:52 PM

 ACCEPT - DONE

an SL_IR state machine
s/b
one set of SL_IR state machines

Author: Isi-gpenokie
Subject: Highlight
Date: 5/25/2008 6:02:42 PM

T REJECT ("thus" implies this rule is a derivative of some other rules. Without that word (or some phrase like "therefore" or "because of that"), it sounds like there might be an option to not do this. Technically the clause could be omitted, but that would be very confusing, requiring the reader to realize what "inside SAS devices contained in" implies. It could be a NOTE, but you are already complaining about too many NOTEs (like Emperor Joseph II to Mozart))

This << device, and thus have SAS addresses different >> should be << device, and shall have a SAS addresses different >>

Author: wdc-mevans
Subject: Cross-Out
Date: 5/25/2008 6:03:04 PM

T ACCEPT - DONE

source
s/b
[Delete this word, as the phy with the higher physical rate may be either the source or destination phy.]

Author: Isi-bbesmer
Subject: Highlight
Date: 5/6/2008 4:07:48 PM

T ACCEPT - DONE

physical
s/b
logical

Author: RElliott
Subject: Note
Date: 6/30/2008 6:16:52 PM

 ACCEPT - DONE

Mark's comments assume that "source" always means source of the OPEN. That is usually true, except for some other specific terms like "crosstalk source." Annotated a few changes in 7.12.8 and other places where a bare "source" should be reworded.

Author: wdc-mevans
Subject: Cross-Out
Date: 5/25/2008 6:40:28 PM

Comments from page 74 continued on next page

Each phy in an expander port containing phys with table routing attributes in an externally configurable expander device shall have the same number of routing table entries (see 4.6.7.3).

A set of expander phys with table routing attributes in an expander device not supporting table-to-table attachments using the same external connector (see 5.2.3.3) is called an enclosure out port. A set of expander phys with subtractive routing attributes using the same external connector is called an enclosure in port. A set of expander phys with table routing attributes in an expander device supporting table-to-table attachments using the same external connector is called an enclosure universal port.

Each phy in an expander port shall have the same zone phy information (see 4.9.3.1). The zone phy information associated with each of the phys in an expander port is treated as the zoning properties of the expander port.

Each expander logical phy contains an expander link layer with an XL state machine (see 7.15) and an SL_IF state machine (see 7.9.4). The XL state machine in each expander logical phy within an expander port processes connection requests independently of the XL state machines in other expander logical phys.

An internal expander port contains a virtual phy with an expander link layer and a protocol-specific transport layer (e.g., to provide access as an SSP target port to a logical unit with a peripheral device type set to 0Dh (i.e., enclosure services device) (see SPC-4 and SES-2)).

Each expander device shall include one internal SMP port using the expander device's SAS address.

Any additional internal SAS ports shall be inside SAS devices contained in the expander device, and thus have SAS addresses different from that of the expander device. These SAS ports shall be attached to internal expander ports with virtual phys.

Each STP/SATA bridge shall have a unique SAS address. This SAS address is reported in the ATTACHED SAS ADDRESS field in the SMP DISCOVER response (see 10.4.3.10) for the expander phy containing the STP/SATA bridge (i.e., the expander phy attached to the SATA device or SATA port selector).

4.6.3 Expander connection manager (ECM)

The ECM performs the following functions:

- a) maps a destination SAS address in a connection request to a destination phy using direct, subtractive, or table routing methods;
- b) arbitrates and assigns or denies path resources for connection requests following SAS arbitration and pathway recovery rules; and
- c) configures the ECR.

4.6.4 Expander connection router (ECR)

The ECR routes messages between pairs of expander logical phys as configured by the ECM. Enough routing resources shall be provided to support at least one connection.

When forwarding dwords during a connection from a source phy with a higher physical link rate to a destination phy with a lower physical link rate, rate matching (see 7.13) ensures the dwords are at a connection rate equal to or less than the lower physical link rate. However, the ECR may be requested to forward more dwords than the destination phy is able to accept if:

- a) an invalid dword occurs during a deletable primitive;
- b) an invalid dword occurs during a CLOSE; or
- c) multiple invalid dwords occur during a BREAK.

The ECR may discard dwords if needed and count them as elasticity buffer overflows (see 4.11).

When forwarding dwords from a SATA physical link with a higher physical link rate to a SAS logical link with a lower logical link rate, the SATA host port in the STP/SATA bridge shall throttle incoming FISes with SATA_HOLD (see 7.17.2).

NOTE 14 If SATA_HOLD is deasserted for n dwords, the SATA device sends up to (21+n) more data dwords. SATA_HOLD does not affect primitives (see SATA-2). The STP/SATA bridge may expand or contract repeated and continued primitives without changing their functional meaning.

TACCEPT - DONE

destination

[Delete this word, as the phy with the higher physical rate may be either the source or destination phy.]

● Author: lsi-bbesmer
Subject: Highlight
Date: 5/6/2008 4:07:48 PM

TACCEPT - DONE

physical

s/b

logical

● Author: lsi-bbesmer
Subject: Highlight
Date: 5/6/2008 4:07:48 PM

TACCEPT - DONE

physical

s/b

logical

● Author: wdc-mevans
Subject: Highlight
Date: 5/25/2008 6:03:18 PM

TACCEPT - DONE

destination

s/b

receiving

● Author: RElliott
Subject: Highlight
Date: 6/30/2008 6:16:52 PM

TACCEPT - DONE

sends

s/b

is allowed to transmit

● Author: ktek-dmoore
Subject: Highlight
Date: 5/6/2008 4:07:48 PM

TACCEPT - DONE (changed to "detected", the word used in chapter 7 to represent a receiver receiving a continued primitive sequence such as SATA_HOLD. Off-topic: In physical layer specs, "deasserted" generally means to stop driving/tristate, while "negated" generally means to actively drive to the tristated value (1) - that was used in later parallel SCSI standards to avoid the long rise times provided by SCSI terminators.)

deasserted s/b negated

Last time I checked Webster's 'deasserted' was not a word.

● Author: lsi-gpenokie
Subject: Highlight
Date: 5/6/2008 4:07:48 PM

TACCEPT - DONE

This << deasserted for n dwords, the SATA device >> should be << deasserted for n dwords, then the SATA device >>

● Author: lsi-gpenokie
Subject: Highlight
Date: 5/6/2008 4:07:48 PM

TREJECT (the first sentence is explaining something defined in SATA, not under control of this standard. This second is just commentary on why it works.)

This looks like it should not be in a note.

Comments from page 74 continued on next page

Each phy in an expander port containing phys with table routing attributes in an externally configurable expander device shall have the same number of routing table entries (see 4.6.7.3).

A set of expander phys with table routing attributes in an expander device not supporting table-to-table attachments using the same external connector (see 5.2.3.3) is called an enclosure out port. A set of expander phys with subtractive routing attributes using the same external connector is called an enclosure in port. A set of expander phys with table routing attributes in an expander device supporting table-to-table attachments using the same external connector is called an enclosure universal port.

Each phy in an expander port shall have the same zone phy information (see 4.9.3.1). The zone phy information associated with each of the phys in an expander port is treated as the zoning properties of the expander port.

Each expander logical phy contains an expander link layer with an XL state machine (see 7.15) and an SL_IR state machine (see 7.9.4). The XL state machine in each expander logical phy within an expander port processes connection requests independently of the XL state machines in other expander logical phys.

An internal expander port contains a virtual phy with an expander link layer and a protocol-specific transport layer (e.g., to provide access as an SSP target port to a logical unit with a peripheral device type set to 0Dh (i.e., enclosure services device) (see SPC-4 and SES-2)).

Each expander device shall include one internal SMP port using the expander device's SAS address.

Any additional internal SAS ports shall be inside SAS devices contained in the expander device, and thus have SAS addresses different from that of the expander device. These SAS ports shall be attached to internal expander ports with virtual phys.

Each STP/SATA bridge shall have a unique SAS address. This SAS address is reported in the ATTACHED SAS ADDRESS field in the SMP DISCOVER response (see 10.4.3.10) for the expander phy containing the STP/SATA bridge (i.e., the expander phy attached to the SATA device or SATA port selector).

4.6.3 Expander connection manager (ECM)

The ECM performs the following functions:

- a) maps a destination SAS address in a connection request to a destination phy using direct, subtractive, or table routing methods;
- b) arbitrates and assigns or denies path resources for connection requests following SAS arbitration and pathway recovery rules; and
- c) configures the ECR.

4.6.4 Expander connection router (ECR)

The ECR routes messages between pairs of expander logical phys as configured by the ECM. Enough routing resources shall be provided to support at least one connection.

When forwarding dwords during a connection from a source phy with a higher physical link rate to a destination phy with a lower physical link rate, rate matching (see 7.13) ensures the dwords are at a connection rate equal to or less than the lower physical link rate. However, the ECR may be requested to forward more dwords than the destination phy is able to accept if:

- a) an invalid dword occurs during a deletable primitive;
- b) an invalid dword occurs during a CLOSE; or
- c) multiple invalid dwords occur during a BREAK.

The ECR may discard dwords if needed and count them as elasticity buffer overflows (see 4.11).

When forwarding dwords from a SATA physical link with a higher physical link rate to a SAS logical link with a lower logical link rate, the SATA host port in the STP/SATA bridge shall throttle incoming FISes with SATA_HOLD (see 7.17.2).

NOTE 14 - If SATA_HOLD is deasserted for n dwords, the SATA device sends up to (21+n) more data dwords. SATA_HOLD does not affect primitives (see SATA-2). The STP/SATA bridge may expand or contract repeated and continued primitives without changing their functional meaning.

When forwarding dwords from a SAS logical link with a lower logical link rate to a SATA physical link with a higher physical link rate, the SATA host port in the STP/SATA bridge shall perform a process similar to rate matching (see 7.13) by inserting ALIGN (0) and/or SATA_HOLD on the SATA physical link whenever it underflows.

NOTE 15 - SATA requires that ALIGN 0 be sent in pairs (see SATA-2).

4.6.5 Broadcast propagation processor (BPP)

The BPP receives Broadcasts from each expander logical phy or from the management device server on behalf of an expander logical phy and requests transmission of those Broadcasts on all expander ports except the expander port from which the Broadcast was received.

In a zoning expander device with zoning enabled (see 4.9.2), Broadcasts are forwarded as described in 4.9.5.

4.6.6 Expander device interfaces

4.6.6.1 Expander device interface overview

The expander device arbitrates and routes between expander logical phys. All routing occurs between expander logical phys, not expander ports. The interaction between an XL state machine and the expander function consists of requests, confirmations, indications, and responses. This interaction is called the expander device interface.

● Author: RElliott
Subject: Highlight
Date: 6/30/2008 6:16:52 PM
T ACCEPT - DONE

sent
s/b
transmitted

● Author: Isi-bday
Subject: Highlight
Date: 5/6/2008 4:07:48 PM
T ACCEPT - DONE

0)
s/b
(0)

● Author: Isi-gpenokie
Subject: Highlight
Date: 5/6/2008 4:07:48 PM
T ACCEPT - DONE

This is a missing << (>>. It should << ALIGN (0) be sent >>

Figure 42 describes the interfaces present within an expander device.

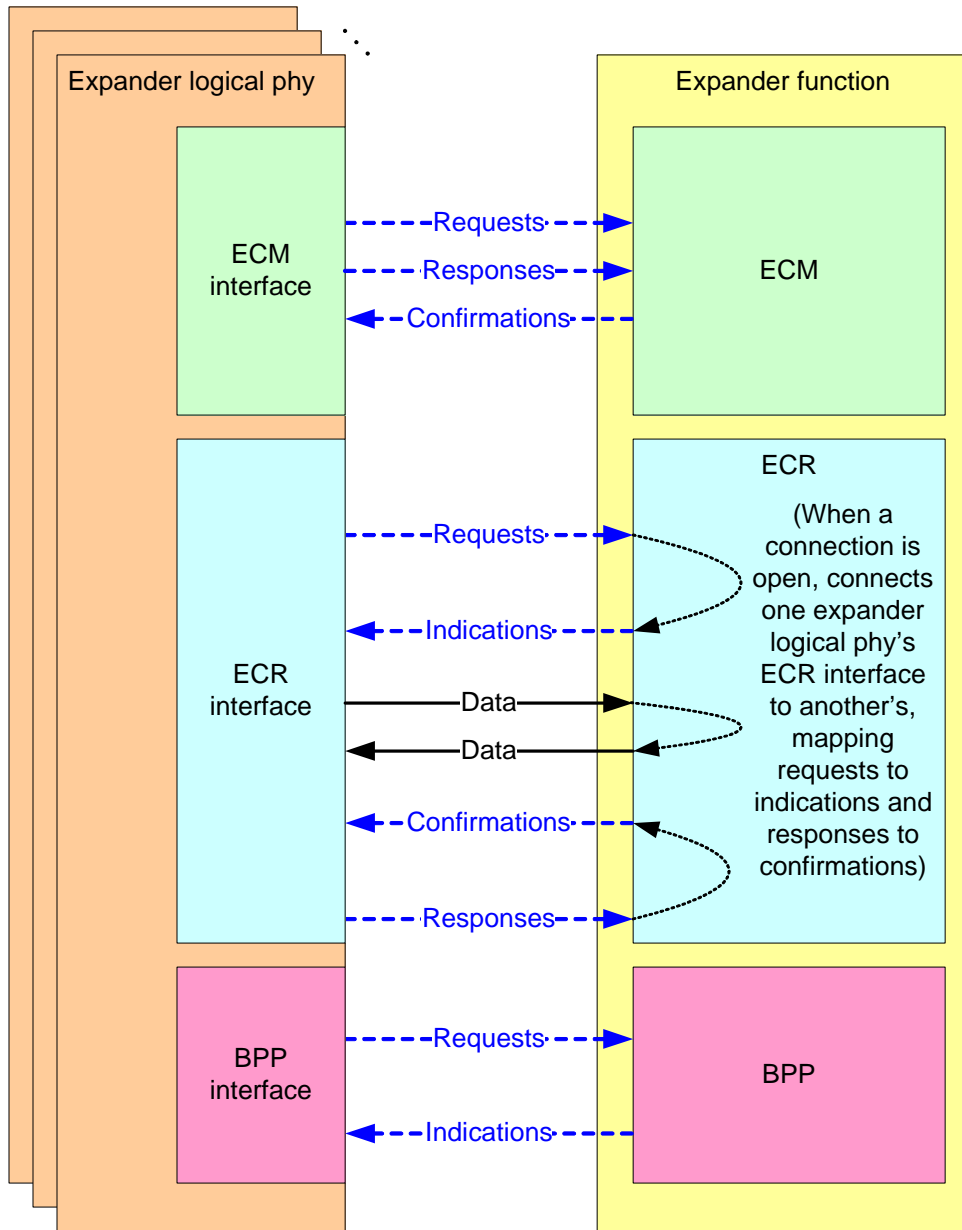

Figure 42 — Expander device interfaces

This page contains no comments

4.6.6.2 Expander device interfaces detail

Figure 43 shows the interface requests, confirmations, indications, and responses used by an expander device to manage connections.

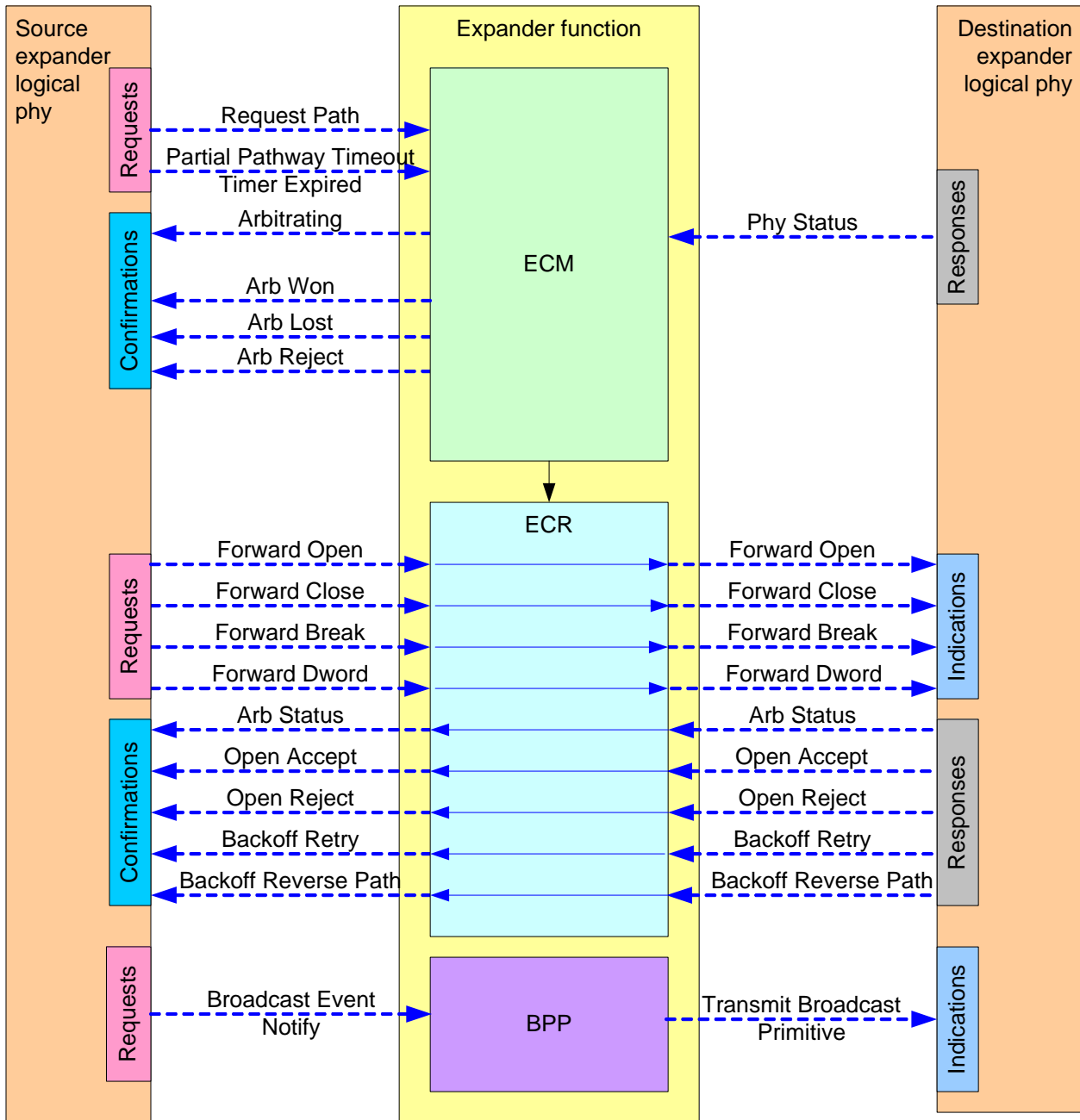

Figure 43 — Expander device interface detail

This page contains no comments

4.6.6.3 ECM interface

Table 13 describes the requests from an expander logical phy to the ECM. The XL state machine (see 7.15) defines ~~specifically~~ when each request is sent.

Table 13 — Expander logical phy to ECM requests

Request	Description
Request Path (arguments)	Request for a connection.
Partial Pathway Timeout Timer Expired	The Partial Pathway Timeout Timer expired.

Table 14 describes the responses from an expander logical phy to the ECM. The XL state machine (see 7.15) defines ~~specifically~~ when each response is sent.

Table 14 — Expander logical phy to ECM responses

Response	Description
Phy Status (Partial Pathway)	Response meaning that an expander logical phy: a) is being used for an unblocked partial pathway; or b) is waiting on another expander logical phy being used for a partial pathway.
Phy Status (Blocked Partial Pathway)	Response meaning that an expander logical phy: a) is being used for a blocked partial pathway; or b) is waiting on another expander logical phy being used for a blocked partial pathway.
Phy Status (Connection)	Response meaning that an expander logical phy: a) is being used for a connection; or b) is waiting on another expander logical phy being used for a connection.

Table 15 describes the confirmations from the ECM to an expander logical phy. These confirmations are sent in confirmation of a Request Path request. See 7.12.4 for specific definitions for when each confirmation is sent.

Table 15 — ECM to expander logical phy confirmations (part 1 of 2)

Confirmation	Description
Arbitrating (Normal)	Confirmation that the ECM has received the Request Path request.
Arbitrating (Waiting On Partial)	Confirmation that the ECM is waiting on a partial pathway (see 4.1.11).
Arbitrating (Blocked On Partial)	Confirmation that the ECM is waiting on a blocked partial pathway (see 4.1.11).
Arbitrating (Waiting On Connection)	Confirmation that the ECM is waiting for a connection to complete (see 4.1.12).
Arb Won	Confirmation that an expander logical phy has won path arbitration.
Arb Lost	Confirmation that an expander logical phy has lost path arbitration.

● Author: wdc-mevans

Subject: Cross-Out

Date: 5/6/2008 4:07:48 PM

 REJECT (matches "specific" after table 14)

specifically

s/b

[Delete the unnecessary word.]

● Author: wdc-mevans

Subject: Cross-Out

Date: 5/6/2008 4:07:48 PM

 REJECT (matches "specific" after table 14)

specifically

s/b

[Delete the unnecessary word.]

Table 15 — ECM to expander logical phy confirmations (part 2 of 2)

Confirmation	Description
Arb Reject (No Destination)	Confirmation that the request is rejected because the expander device is not configuring (see 4.8) and there is no path to the destination.
Arb Reject (Bad Destination)	Confirmation that the request is rejected because the path to the destination maps back to the requesting expander port.
Arb Reject (Connection Rate Not Supported)	Confirmation that the request is rejected because there is a destination port capable of routing to the requested destination SAS address but no phys within the destination port are configured to support the requested connection rate.
Arb Reject (Zone Violation)	Confirmation that the request is rejected because the expander device is not locked and there is a zoning violation (see 4.9.3).
Arb Reject (Pathway Blocked)	Confirmation that the request is rejected because the requesting expander logical phy needs to back off according to SAS pathway recovery rules.
Arb Reject (Retry)	Confirmation that the request is rejected because: <ul style="list-style-type: none"> a) the expander device is configuring (see 4.7.2) and the ECM would otherwise have returned Arb Reject (No Destination); b) the expander device is locked (see 4.9.6.2) and the ECM would otherwise have returned Arb Reject (Zone Violation); or c) the expander device has reduced functionality (see 4.6.8 and 7.12.4.2.5).

4.6.6.4 ECR interface

Table 16 describes the requests from an expander logical phy to the ECR and the corresponding indications from the ECR to another expander logical phy. The XL state machine (see 7.15) defines specifically when each request is sent.

Table 16 — Expander logical phy to ECR to expander logical phy requests and indications

Request/indication	Description
Forward Open (arguments)	Request/indication to forward an OPEN address frame.
Forward Close	Request/indication to forward a CLOSE.
Forward Break	Request/indication to forward a BREAK.
Forward Dword	Request/indication to forward a dword.

● Author: RElliott
Subject: Highlight
Date: 6/30/2008 6:16:52 PM
T ACCEPT - DONE

configuring (see 4.8)
s/b
configuring (see 4.7.2)

which covers the discover process in a self-configuring expander, not just the configuration subprocess.

Table 17 describes the responses from an expander logical phy to the ECR and the corresponding confirmations from the ECR to another expander logical phy. These responses are sent in response to a Forward Open indication. The XL state machine (see 7.15) defines ~~specifically~~ when each response is sent.

Table 17 — Expander logical phy to ECR to expander logical phy responses and confirmations

Response/confirmation	Description
Arb Status (Normal)	Confirmation/response that AIP (NORMAL) has been received.
Arb Status (Waiting On Partial)	Confirmation/response that AIP (WAITING ON PARTIAL) has been received.
Arb Status (Waiting On Connection)	Confirmation/response that AIP (WAITING ON CONNECTION) has been received.
Arb Status (Waiting On Device)	Confirmation/response that either: a) AIP (WAITING ON DEVICE) has been received; or b) the expander logical phy has completed the forwarding of an OPEN address frame and has entered the XL6:Open_Response_Wait state.
Open Accept	Confirmation/response that OPEN_ACCEPT has been received.
Open Reject	Confirmation/response that OPEN_REJECT has been received.
Backoff Retry	Confirmation/response that: a) a higher priority OPEN address frame has been received (see 7.12.3); and b) the source SAS address and connection rate of the received OPEN address frame are not equal to the destination SAS address and connection rate of the transmitted OPEN address frame.
Backoff Reverse Path	Confirmation/response that: a) a higher priority OPEN address frame has been received (see 7.12.3); and b) the source SAS address and connection rate of the received OPEN address frame are equal to the destination SAS address and connection rate of the transmitted OPEN address frame.

4.6.6.5 BPP interface

Table 18 describes the requests from an expander logical phy to the BPP. Requests from the management device server about SMP ZONED BROADCAST requests received from the SMP target port in zoning

Author: wdc-mevans

Subject: Cross-Out

Date: 5/6/2008 4:07:48 PM

 REJECT (matches "specific" after table 14)

 specifically

s/b

[Delete the unnecessary word.]

expander devices with zoning enabled are not described. See 4.9.5 for more information on how zoning expander devices with zoning enabled handle Broadcasts.

Table 18 — Expander logical phy to BPP requests

Request	Description
Broadcast Event Notify (Phy Not Ready)	Request to originate a Broadcast (Change) because the expander logical phy's SP state machine transitioned from the SP15:SAS_PHY_Ready or SP22:SATA_PHY_Ready state to the SP0:OOB_COMINIT state (see 6.8).
Broadcast Event Notify (SATA Spinup Hold)	Request to originate a Broadcast (Change) because the SATA spinup hold state has been reached (see 6.8 and 6.11) by the expander phy.
Broadcast Event Notify (Identification Sequence Complete)	Request to originate a Broadcast (Change) because the expander logical phy has completed the identification sequence (see 7.9).
Broadcast Event Notify (SATA Port Selector Change)	Request to originate a Broadcast (Change) because the expander phy detected that a SATA port selector appeared or disappeared.
Broadcast Event Notify (Change Received)	Request to forward a Broadcast (Change) because the expander logical phy received a Broadcast (Change). See 7.11 and 7.15.
Broadcast Event Notify (Reserved Change 0 Received)	Request to forward a Broadcast (Reserved Change 0) because the expander logical phy received a Broadcast (Reserved Change 0). See 7.11 and 7.15.
Broadcast Event Notify (Reserved Change 1 Received)	Request to forward a Broadcast (Reserved Change 1) because the expander logical phy received a Broadcast (Reserved Change 1). See 7.11 and 7.15.
Broadcast Event Notify (SES Received)	Request to forward a Broadcast (SES) because the expander logical phy received a Broadcast (SES). See 7.15.
Broadcast Event Notify (Expander Received)	Request to forward a Broadcast (Expander) because the expander logical phy received a Broadcast (Expander). See 7.15.
Broadcast Event Notify (Asynchronous Event Received)	Request to forward a Broadcast (Asynchronous Event) because the expander logical phy received a Broadcast (Asynchronous Event). See 7.15.
Broadcast Event Notify (Reserved 3 Received)	Request to forward a Broadcast (Reserved 3) because the expander logical phy received a Broadcast (Reserved 3). See 7.15.
Broadcast Event Notify (Reserved 4 Received)	Request to forward a Broadcast (Reserved 4) because the expander logical phy received a Broadcast (Reserved 4). See 7.15.

Table 19 describes the indications from the BPP to an expander logical phy. Indications to the management application client to generate SMP ZONED BROADCAST functions from the SMP initiator port in a zoning expander device with zoning enabled are not described. See 4.9.5 for more information on how zoning expander devices with zoning enabled handle Broadcasts.

Table 19 — BPP to expander logical phy indications

Message	Description
Transmit Broadcast (type)	Indication to transmit a BROADCAST with the specified type.

● Author: Isi-gpenokie
Subject: Highlight
Date: 5/6/2008 4:07:48 PM

T REJECT (nothing wrong with "because")

Change all the << because ... ed...>> terms to << as a result of ing...>> in this table. For example << Broadcast (Change) as a result of the expander phy detecting that a SATA port

● Author: Isi-gpenokie
Subject: Highlight
Date: 5/6/2008 4:07:48 PM

T ACCEPT - DONE

This << are not described. See >> should be << are not described by this standard. See >>

4.6.7 Expander device routing

4.6.7.1 Routing attributes and routing methods

Each expander phy in an expander device shall support one of the following routing attributes:

- a) direct routing attribute;
- b) table routing attribute; or
- c) subtractive routing attribute.

The routing attributes allow the ECM to determine which routing method to use when routing connection requests to the expander logical phys in the expander phy.

- a) the table routing method routes connection requests to attached expander devices using an expander route table;
- b) the subtractive routing method routes unresolved connection requests to an attached expander device; or
- c) the direct routing method routes connection requests to attached end devices, the SMP port of an attached expander device, or SAS devices contained in the expander device.

Table 20 describes the routing methods that the ECM uses based on the routing attributes of an expander phy.

Table 20 — Routing attributes and routing methods

Routing attribute of an expander phy	Routing method used by ECM for the expander phy
Direct	Direct ^a
Table	Direct, if attached to an end device
	Direct, if attached to an expander device, for the SAS address of the expander device
	Table, if attached to an expander device, for SAS addresses beyond the expander device
Subtractive	Direct, if attached to an end device
	Subtractive, if attached to an expander device
^a If attached to an expander device, the ECM is only able to route to the expander device itself through a phy with the direct routing attribute	

An expander device may have zero or more phys with the table routing attribute.

An expander device shall have at most one defined port containing phys with the subtractive routing attribute.

An expander device that does not support table-to-table attachment shall only use phys with the table routing attribute to attach to phys with the subtractive routing attribute in other expander devices.

If multiple phys within an expander device have subtractive routing attributes and are attached to expander devices, they shall attach to phys with identical SAS addresses (i.e., the same expander port).

If multiple phys within an expander device have subtractive routing attributes and are attached to expander devices that do not have identical SAS addresses, the application client that is performing the discover process (see 4.7) shall report an error in a vendor-specific manner.

4.6.7.2 Connection request routing

The ECM shall determine how to route a connection request from a source expander logical phy to a destination expander logical phy in a different expander port if the destination expander logical phy is enabled, operating at a valid logical link rate (e.g., the SMP DISCOVER response reports a NEGOTIATED LOGICAL LINK

Page: 82

● Author: wdc-mevans
Subject: Highlight
Date: 5/6/2008 4:07:48 PM
 ACCEPT - DONE
direct
s/b
a direct

● Author: wdc-mevans
Subject: Highlight
Date: 5/6/2008 4:07:48 PM
 ACCEPT - DONE
table
s/b
a table

● Author: wdc-mevans
Subject: Highlight
Date: 5/6/2008 4:07:48 PM
 ACCEPT - DONE
subtractive
s/b
a subtractive

● Author: RElliott
Subject: Note
Date: 6/30/2008 6:16:52 PM
 ACCEPT - DONE

Add columns for:
If attached to an end device
If attached to an expander device

and compact this into 3 rows

● Author: RElliott
Subject: Note
Date: 6/30/2008 6:16:52 PM
 ACCEPT - DONE (Table redrawn with per other comment, implementing this change. 5/5 direct routing, so fix the table to have 2 rows instead of 1 for the Subtractive/Subtractive row)

Does subtractive attribute mean use the direct routing method to the SAS address of the expander device?

table says no, c) above says yes

● Author: RElliott
Subject: Highlight
Date: 6/30/2008 6:16:52 PM
 ACCEPT - DONE
the
s/b
then the

● Author: RElliott
Subject: Highlight
Date: 6/30/2008 6:16:52 PM
 ACCEPT - DONE

attribute
s/b

Comments from page 82 continued on next page

4.6.7 Expander device routing

4.6.7.1 Routing attributes and routing methods

Each expander phy in an expander device shall support one of the following routing attributes:

- a) **direct** routing attribute;
- b) **table** routing attribute; or
- c) **subtractive** routing attribute.

The routing attributes allow the ECM to determine which routing method to use when routing connection requests to the expander logical phys in the expander phy:

- a) the table routing method routes connection requests to attached expander devices using an expander route table;
- b) the subtractive routing method routes unresolved connection requests to an attached expander device; or
- c) the direct routing method routes connection requests to attached end devices, the SMP port of an attached expander device, or SAS devices contained in the expander device.

Table 20 describes the routing methods that the ECM uses based on the routing attributes of an expander phy.

Table 20 — Routing attributes and routing methods

Routing attribute of an expander phy	Routing method used by ECM for the expander phy
Direct	Direct ^a
Table	Direct, if attached to an end device
	Direct, if attached to an expander device, for the SAS address of the expander device
	Table, if attached to an expander device, for SAS addresses beyond the expander device
Subtractive	Direct, if attached to an end device
	Subtractive, if attached to an expander device
^a If attached to an expander device, the ECM is only able to route to the expander device itself through a phy with the direct routing attribute	

An expander device may have zero or more phys with the table routing attribute.

An expander device shall have at most one defined port containing phys with the subtractive routing attribute.

An expander device that does not support table-to-table attachment shall only use phys with the table routing attribute to attach to phys with the subtractive routing attribute in other expander devices.

If multiple phys within an expander device have subtractive routing attributes and are attached to expander devices, they shall attach to phys with identical SAS addresses (i.e., the same expander port).

If multiple phys within an expander device have subtractive routing attributes and are attached to expander devices that do not have identical SAS addresses, the application client that is performing the discover process (see 4.7) shall report an error in a vendor-specific manner.

4.6.7.2 Connection request routing

The ECM shall determine how to route a connection request from a source expander logical phy to a destination expander logical phy in a different expander port if the destination expander logical phy is enabled, operating at a valid logical link rate (e.g., the SMP DISCOVER response reports a NEGOTIATED LOGICAL LINK

attribute.

Author: RElliott
Subject: Underline
Date: 6/30/2008 6:16:52 PM
 ACCEPT - DONE

Reword this as:

If an expander device that does not support table-to-table attachment, its table-routing phys shall not be attached to table routing phys in other expander devices (e.g., they may be attached to subtractive routing phys).

and place into the new section

Author: lsi-bbesmer
Subject: Highlight
Date: 6/9/2008 4:38:08 PM

 ACCEPT - DONE (True. Added pointer to REPORT GENERAL, and to DISCOVER itself (which is oddly missing):
"The SMP REPORT GENERAL function (see 10.4.3.4) reports whether or not the expander device is self-configuring and supports table-to-table attachment. The SMP DISCOVER function (see 10.4.3.10) reports the routing attribute of each expander phy (see 10.4.3.4)."

Added " A self-configuring expander device may support table-to-table attachment (i.e., having its table routing phys attached to the table routing phys of other expander devices). An externally configurable expander device shall not support table-to-table attachment." to the zero or more phys paragraph.
)

REPORT GENERAL adds a rule that table-to-table attachment is ONLY allowed in a self-configuring expander:

A TABLE TO TABLE SUPPORTED bit set to one indicates that the expander device is a self-configuring expander device that supports its table routing phys being attached to table routing phys in other expander devices. The TABLE TO TABLE SUPPORTED bit shall only be set to one if the EXTERNALLY CONFIGURABLE ROUTE TABLE bit is set to zero. A TABLE TO TABLE SUPPORTED bit set to zero indicates that the expander device is not a self-configuring expander device that supports its table routing phys being attached to table routing phys in other expander devices.

Author: RElliott
Subject: Note
Date: 6/30/2008 6:16:52 PM
 ACCEPT - DONE

Create a section "Expander device topology routing attribute restrictions" for the rules about how expanders are hooked together (vs. the rules for how each is individually constructed)

Author: RElliott
Subject: Underline
Date: 6/30/2008 6:16:52 PM
 ACCEPT - DONE

port
s/b
device

although both are true, the earlier part of the sentence refers to expander devices, so that is the better level to discuss

Author: RElliott
Subject: Highlight
Date: 6/30/2008 6:16:52 PM
 ACCEPT - DONE

shall attach
s/b
shall be attached

4.6.7 Expander device routing

4.6.7.1 Routing attributes and routing methods

Each expander phy in an expander device shall support one of the following routing attributes:

- a) direct routing attribute;
- b) table routing attribute; or
- c) subtractive routing attribute.

The routing attributes allow the ECM to determine which routing method to use when routing connection requests to the expander logical phys in the expander phy:

- a) the table routing method routes connection requests to attached expander devices using an expander route table;
- b) the subtractive routing method routes unresolved connection requests to an attached expander device; or
- c) the direct routing method routes connection requests to attached end devices, the SMP port of an attached expander device, or SAS devices contained in the expander device

Table 20 describes the routing methods that the ECM uses based on the routing attributes of an expander phy.

Table 20 — Routing attributes and routing methods

Routing attribute of an expander phy	Routing method used by ECM for the expander phy
Direct	Direct ^a
Table	Direct, if attached to an end device
	Direct, if attached to an expander device, for the SAS address of the expander device
	Table, if attached to an expander device, for SAS addresses beyond the expander device
Subtractive	Direct, if attached to an end device
	Subtractive, if attached to an expander device
^a If attached to an expander device, the ECM is only able to route to the expander device itself through a phy with the direct routing attribute	

An expander device may have zero or more phys with the table routing attribute.

An expander device shall have at most one defined port containing phys with the subtractive routing attribute.

An expander device that does not support table-to-table attachment shall only use phys with the table routing attribute to attach to phys with the subtractive routing attribute in other expander devices.

If multiple phys within an expander device have subtractive routing attributes and are attached to expander devices, they shall attach to phys with identical SAS addresses (i.e., the same expander port).

If multiple phys within an expander device have subtractive routing attributes and are attached to expander devices that do not have identical SAS addresses, the application client that is performing the discover process (see 4.7) shall report an error in a vendor-specific manner.

4.6.7.2 Connection request routing

The ECM shall determine how to route a connection request from a source expander logical phy to a destination expander logical phy in a different expander port if the destination expander logical phy is enabled, operating at a valid logical link rate (e.g., the SMP DISCOVER response reports a NEGOTIATED LOGICAL LINK

● Author: wdc-mevans

Subject: Highlight

Date: 5/25/2008 6:05:21 PM

T REJECT (but added "then" even though it wasn't requested)

they

s/b

the phys in the expander device

● Author: RElliott

Subject: Highlight

Date: 6/30/2008 6:16:52 PM

T ACCEPT - DONE

the

s/b

then the

RATE field set to G1 (i.e., 8h), G2 (i.e., 9h), or G3 (i.e., Ah)), and not excluded because of zoning (see 4.9.2) using the following precedence:

- 1) route to an expander logical phy with the direct routing attribute or table routing attribute when the destination SAS address matches the attached SAS address;
- 2) route to an expander logical phy with the table routing attribute when the destination SAS address matches an enabled SAS address in the expander route table;
- 3) route to an expander logical phy with the subtractive routing attribute; and
- 4) return an Arb Reject confirmation (see 4.6.6.3) to the source expander logical phy.

If the destination expander logical phy only matches an expander logical phy in the same expander port from which the connection request originated, then the ECM shall return an Arb Reject confirmation (see 4.6.6.3).

If the destination SAS address of a connection request matches a disabled SAS address in an expander route table, then the ECM shall ignore the match.

4.6.7.3 Expander route table

4.6.7.3.1 Expander route table overview

An expander device that supports the table routing method shall contain an expander route table. The expander route table is a structure that provides an association between destination SAS addresses (i.e., routed SAS addresses) and the expander phys to which connection requests to those destination SAS addresses are forwarded.

Zoning expander devices include additional fields in their expander route tables (see 4.9.3.4).

Table 21 defines the types of expander route tables.

Table 21 — Expander route table types

Type	SMP functions to access	Reference
Phy-based	REPORT ROUTE INFORMATION (see 10.4.3.13) and CONFIGURE ROUTE INFORMATION (see 10.4.3.27)	4.6.7.3.2
Expander-based	REPORT EXPANDER ROUTE TABLE LIST (see 10.4.3.17)	4.6.7.3.3

Page: 83

● Author: Isi-gpenokie

Subject: Highlight

Date: 5/25/2008 6:05:36 PM

T REJECT (nothing wrong with "because")

Change to << as a result of >>

● Author: Isi-gpenokie

Subject: Highlight

Date: 5/6/2008 4:07:48 PM

T REJECT (ordered list, they all must be considered)

This is an << or >> as you cannot route to all. Only one of the items will be valid.

4.6.7.3.2 Phy-based expander route table

Figure 44 shows a representation of a phy-based expander route table.

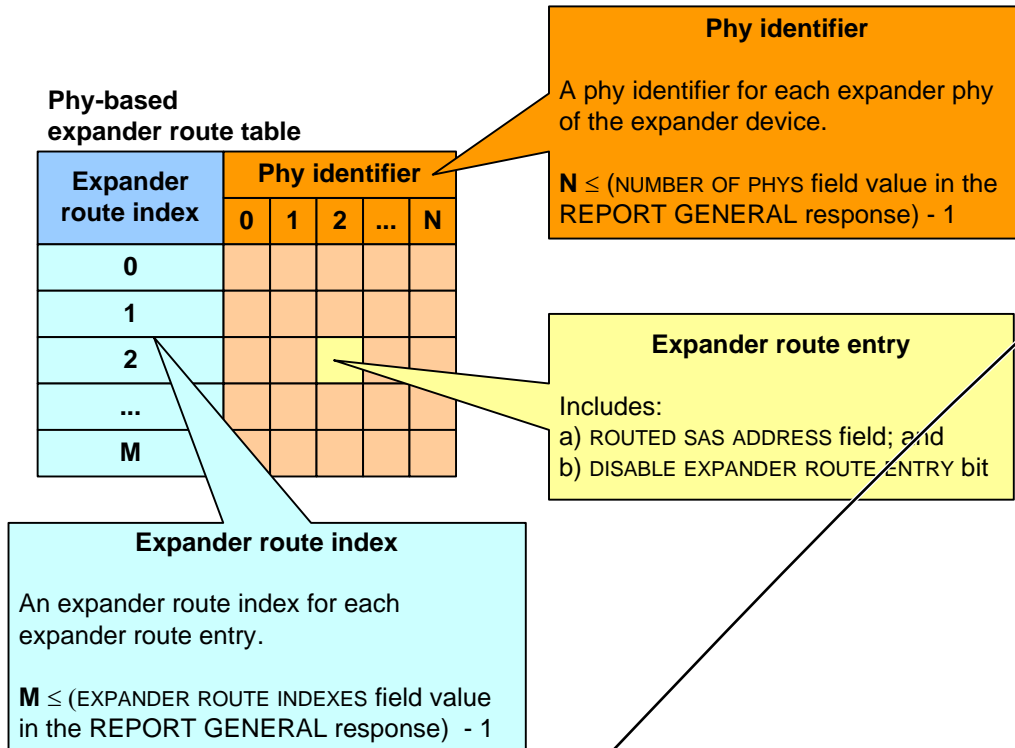

Figure 44 — Phy-based expander route table

For each expander route index and phy identifier combination, the phy-based expander route table contains an expander route entry containing a ROUTED SAS ADDRESS field and a DISABLE EXPANDER ROUTE ENTRY bit.

A management application client may access a specific expander route entry within a phy-based expander route table with the SMP REPORT ROUTE INFORMATION function (see 10.4.3.13) and the SMP CONFIGURE ROUTE INFORMATION function (see 10.4.3.27).

An expander device reports the maximum expander route index in the EXPANDER ROUTE INDEXES field and indicates if the phy-based expander route table is configurable in the CONFIGURABLE ROUTE TABLE bit in the SMP REPORT GENERAL response (see 10.4.3.4).

Each expander route entry shall be disabled after power on.

Author: Isi-gpenokie
Subject: Highlight
Date: 5/6/2008 4:07:48 PM
ACCEPT - DONE



This << SAS>> is in regular caps when it should be in small caps.

4.6.7.3.3 Expander-based expander route table

Figure 45 shows a representation of an expander-based expander route table.

Routed SAS address	Phy bit map				
	0	1	2	...	N
SAS address A					
SAS address B					
SAS address C					
...					

Indicates the expander phy(s) to which connection requests to the routed SAS address may be forwarded.

1 indicates the expander phy is used for forwarding connection requests, 0 indicates it is not

Figure 45 — Expander-based expander route table

For each routed SAS address, the expander-based expander route table contains a phy bit map.

A management application client may access an expander-based expander route table with the SMP REPORT EXPANDER ROUTE TABLE LIST function (see 10.4.3.17).

An expander device reports the size of its expander-based expander route table in the MAXIMUM NUMBER OF ROUTED SAS ADDRESSES field in the SMP REPORT GENERAL response (see 10.4.3.4).

4.6.8 Expander device reduced functionality

An expander device shall originate a Broadcast (Expander) to indicate that it is going to temporarily have reduced functionality for a period of time (e.g., if during a microcode update, it disables the ECM and ECR access to its SMP target port or to one or more expander phys, or if it experiences reduced performance). The maximum period of time that the expander device is going to have reduced functionality is indicated:

- in the REPORT SUPPORTED OPERATION CODES command parameter data (see SPC-4) for the WRITE BUFFER command reported by a logical unit with a peripheral device type set to 0Dh (i.e., enclosure services device) accessed via an SSP target port contained in the expander device; and
- from the contents of the MAXIMUM REDUCED FUNCTIONALITY TIME field in the REPORT GENERAL response (see 10.4.3.4).

After the expander device originates a Broadcast (Expander) it shall:

- set the REDUCED FUNCTIONALITY bit to one in the REPORT GENERAL response (see 10.4.3.4);
- initialize the reduced functionality delay timer to the value indicated by the INITIAL REDUCED FUNCTIONALITY DELAY field in the REPORT GENERAL response (see 10.4.3.4) and start the reduced functionality delay timer;
- wait for the reduced functionality delay timer to expire before reducing any expander functions; and
- not stop or restart the reduced functionality delay timer until after the expander device enters the reduced functionality condition.

If the expander device receives a connection request that maps to an expander phy or its SMP target port that is not accessible because of the reduced functionality, then the expander device shall respond with an OPEN REJECT (RETRY) until the operation that caused the expander device to have reduced functionality is complete.

Page: 85

● Author: lsi-gpenokie
Subject: Highlight
Date: 5/25/2008 6:40:55 PM
 REJECT (number looks better for a figure)

Change to << one >> to be consistent with how we talk about bit settings.

● Author: lsi-gpenokie
Subject: Highlight
Date: 5/25/2008 6:41:01 PM
 REJECT (number looks better for a figure)

Change to << zero >> to be consistent with how we talk about bit settings.

● Author: hpq-relliott
Subject: Note
Date: 5/17/2008 2:27:48 PM
 ACCEPT - DONE (added "Routed SAS addresses are not necessarily sorted in any particular order. ")

Add a note that the addresses in the expander-based expander route table are not sorted in any particular order.

● Author: wdc-mevans
Subject: Highlight
Date: 5/25/2008 6:06:09 PM
 ACCEPT - DONE (just deleting temporarily, leaving "going to have reduced". It has not actually started reducing anything yet.)

going to temporarily have reduced
s/b
reducing

● Author: hpq-relliott
Subject: Note
Date: 9/4/2008 9:36:31 AM
 ACCEPT - DONE (created a 4.6.9 Broadcast (Expander) handling)

Move the application client handling of Broadcast (Expander) to another section; it may not belong here. Add "and Broadcast (Expander)" to the title of 4.6.8.

● Author: wdc-mevans
Subject: Highlight
Date: 5/25/2008 6:07:58 PM
 REJECT (this is still part of the if clause not the then clause. Added a comma after the if to clarify this is not an if...then construct. Changed "it" to "expander device" here as well, although not strictly necessary)

it
s/b
then the expander device

● Author: wdc-mevans
Subject: Highlight
Date: 5/25/2008 6:07:34 PM
 REJECT

it
s/b
the expander device

● Author: lsi-bday
Subject: Highlight
Date: 5/25/2008 6:08:22 PM

Comments from page 85 continued on next page

4.6.7.3.3 Expander-based expander route table

Figure 45 shows a representation of an expander-based expander route table.

Routed SAS address	Phy bit map				
	0	1	2	...	N
SAS address A					
SAS address B					
SAS address C					
...					

Indicates the expander phy(s) to which connection requests to the routed SAS address may be forwarded.

1 indicates the expander phy is used for forwarding connection requests, 0 indicates it is not

Figure 45 — Expander-based expander route table

For each routed SAS address, the expander-based expander route table contains a phy bit map.

A management application client may access an expander-based expander route table with the SMP REPORT EXPANDER ROUTE TABLE LIST function (see 10.4.3.17).

An expander device reports the size of its expander-based expander route table in the MAXIMUM NUMBER OF ROUTED SAS ADDRESSES field in the SMP REPORT GENERAL response (see 10.4.3.4).

4.6.8 Expander device reduced functionality

An expander device shall originate a Broadcast (Expander) to indicate that it is going to temporarily have reduced functionality for a period of time (e.g., if during a microcode update, it disables the ECM and ECR access to its SMP target port or to one or more expander phys, or if it experiences reduced performance). The maximum period of time that the expander device is going to have reduced functionality is indicated:

- in the REPORT SUPPORTED OPERATION CODES command parameter data (see SPC-4) for the WRITE BUFFER command reported by a logical unit with a peripheral device type set to 0Dh (i.e., enclosure services device) accessed via an SSP target port contained in the expander device; and
- from the contents of the MAXIMUM REDUCED FUNCTIONALITY TIME field in the REPORT GENERAL response (see 10.4.3.4).

After the expander device originates a Broadcast (Expander) it shall:

- set the REDUCED FUNCTIONALITY bit to one in the REPORT GENERAL response (see 10.4.3.4);
- initialize the reduced functionality delay timer to the value indicated by the INITIAL REDUCED FUNCTIONALITY DELAY field in the REPORT GENERAL response (see 10.4.3.4) and start the reduced functionality delay timer;
- wait for the reduced functionality delay timer to expire before reducing any expander functions; and
- not stop or restart the reduced functionality delay timer until after the expander device enters the reduced functionality condition.

If the expander device receives a connection request that maps to an expander phy or its SMP target port that is not accessible because of the reduced functionality, then the expander device shall respond with an OPEN REJECT (RETRY) until the operation that caused the expander device to have reduced functionality is complete.

TACCEPT - DONE (as " to indicate that it is going to have reduced functionality for a period of time, it shall". Wordy, and being in the section probably suffices since it says "the expander device" (tying it to the one in the previous paragraph, but will go with wordy here. Could also try "After it originates the Broadcast (Expander), it shall", but that would set off the anti-it fanatics)

Broadcast (Expander) it shall:

s/b/

Broadcast (Expander) to indicate reduced functionality it shall:

Don't want the following actions to take place for the PVD phy event threshold case. Maybe just being in this section is sufficient?

Author: RElliott
Subject: Highlight
Date: 6/30/2008 6:16:52 PM

TACCEPT - DONE

functions

s/b

functionality

After the operation that caused the expander device to have reduced functionality is complete, the expander device shall:

- 1) set the REDUCED FUNCTIONALITY bit to zero in the REPORT GENERAL response (see 10.4.3.4); and
- 2) originate a Broadcast (Change) or a link reset sequence on each expander phy.

After receiving a Broadcast (Expander), a management application client behind an SMP initiator port should issue a REPORT GENERAL function (see 10.4.3.4) to all expander devices to determine:

- a) the expander devices, if any, that are reducing their functionality (i.e., the REDUCED FUNCTIONALITY bit is set to one in the REPORT GENERAL response)(see 4.6.8); and
- b) the amount of time remaining until the reduced functionality occurs (i.e., the contents of the TIME TO REDUCED FUNCTIONALITY field in the REPORT GENERAL response).

4.7 Discover process

4.7.1 Discover process overview

Management application clients direct an SMP initiator port to request SMP functions from an SMP target port. Management application clients are located in every SAS initiator device and every self-configuring expander device. A management application client performs a discover process to discover all the SAS devices and expander devices in the SAS domain (i.e., determining their device types, SAS addresses, and supported protocols). A SAS initiator device uses this information to determine SAS addresses to which it is able to establish connections. A self-configuring expander device uses this information to fill in its expander route table.

A management application client performing the discover process shall perform a level-order (i.e., breadth-first) traversal of the SAS domain. The order of traversal shall be to discover:

- 1) the device(s) to which the device containing the management application client is attached;
- 2) if an attached device is an expander device, every device attached to that expander device; and
- 3) for each expander device found, every device attached to that expander device.

This order is repeated until all expander devices have been traversed. If the management application client discovers an externally configurable expander device that is not located beyond a self-configuring expander device with the CONFIGURES OTHERS bit set to one in the REPORT GENERAL response (see 10.4.3.4) it shall perform the configuration subprocess (see 4.8) to configure the expander route table before attempting to establish connections with devices attached two levels (see 4.8.4) beyond that externally configurable expander device.

If an end device is directly attached to a self-configuring expander device with the CONFIGURES OTHERS bit set to one in the REPORT GENERAL response (see 10.4.3.4), then the management application client in that end device is not required to perform the configuration subprocess. If all the expander devices in the SAS domain are self-configuring expander devices, then management application clients in end devices are not required to perform the configuration subprocess.

If the management application client is inside a self-configuring expander device, then the process shall be repeated on each expander port.

Page: 86

Author: hpq-relliott
Subject: Note
Date: 9/4/2008 9:36:06 AM

ACCEPT - DONE (

9/4 added: If an expander device is found that is reducing its functionality, then the management application client should:
a) terminate any outstanding I_T_L_Q nexuses whose connections are through that expander device; and
b) not create any new I_T_L_Q nexuses whose connections go through that expander device.

There are more specific things it could do, but this communicates the key concepts.

5/5 the intro to 07-008r8 item A) second sentence and B) have some words that might fit here.)

Mention what the application client is supposed to do when it determines that an expander device is going to have reduced functionality.

- complete all I/Os before the reduced functionality occurs
- do not start new I/Os
- do not open new connections after the time expires

Author: wdc-mevans
Subject: Highlight
Date: 5/25/2008 6:09:01 PM

T ACCEPT - DONE

to
s/b
with

Author: RElliott
Subject: Highlight
Date: 6/30/2008 6:16:52 PM

T ACCEPT - DONE (as part of rewrite)

every
s/b
then every

Author: hpq-relliott
Subject: Highlight
Date: 6/4/2008 10:04:20 AM

T ACCEPT - DONE (rewrote as:

"The management application client shall discover devices in the following order:

- 1) the device(s) to which the device containing the management application client is attached;
- 2) for each expander phy with the subtractive routing attribute or the table routing attribute, if the attached device is an expander device, then every device attached to that expander device; and
- 3) repeat step 2) for each additional expander device found attached to that expander device.

The discover process completes when all expander devices have been traversed.

")

after "is an expander device"

add:

"and the expander phy has the subtractive routing attribute or the table routing attribute.

If an expander is attached, but the routing attribute is direct, every address beyond the attached expander device is inaccessible.

Author: wdc-mevans
Subject: Highlight
Date: 5/8/2008 6:53:17 PM

Comments from page 86 continued on next page

After the operation that caused the expander device to have reduced functionality is complete, the expander device shall:

- 1) set the REDUCED FUNCTIONALITY bit to zero in the REPORT GENERAL response (see 10.4.3.4); and
- 2) originate a Broadcast (Change) or a link reset sequence on each expander phy.

After receiving a Broadcast (Expander), a management application client behind an SMP initiator port should issue a REPORT GENERAL function (see 10.4.3.4) to all expander devices to determine:

- a) the expander devices, if any, that are reducing their functionality (i.e., the REDUCED FUNCTIONALITY bit is set to one in the REPORT GENERAL response)(see 4.6.8); and
- b) the amount of time remaining until the reduced functionality occurs (i.e., the contents of the TIME TO REDUCED FUNCTIONALITY field in the REPORT GENERAL response).

4.7 Discover process

4.7.1 Discover process overview

Management application clients direct an SMP initiator port to request SMP functions from an SMP target port. Management application clients are located in every SAS initiator device and every self-configuring expander device. A management application client performs a discover process to discover all the SAS devices and expander devices in the SAS domain (i.e., determining their device types, SAS addresses, and supported protocols). A SAS initiator device uses this information to determine SAS addresses to which it is able to establish connections. A self-configuring expander device uses this information to fill in its expander route table.

A management application client performing the discover process shall perform a level-order (i.e., breadth-first) traversal of the SAS domain. The order of traversal shall be to discover:

- 1) the device(s) to which the device containing the management application client is attached;
- 2) if an attached device is an expander device, every device attached to that expander device; and
- 3) for each expander device found, every device attached to that expander device.

This order is repeated until all expander devices have been traversed. If the management application client discovers an externally configurable expander device that is not located beyond a self-configuring expander device with the CONFIGURES OTHERS bit set to one in the REPORT GENERAL response (see 10.4.3.4) it shall perform the configuration subprocess (see 4.8) to configure the expander route table before attempting to establish connections with devices attached two levels beyond that externally configurable expander device.

If an end device is directly attached to a self-configuring expander device with the CONFIGURES OTHERS bit set to one in the REPORT GENERAL response (see 10.4.3.4), then the management application client in that end device is not required to perform the configuration subprocess. If all the expander devices in the SAS domain are self-configuring expander devices, then management application clients in end devices are not required to perform the configuration subprocess.

If the management application client is inside a self-configuring expander device, then the process shall be repeated on each expander port.

T ACCEPT - DONE

10.4.3.4) it
s/b
10.4.3.4), then the management application client

● Author: RElliott
Subject: Highlight
Date: 6/30/2008 6:16:52 PM

T ACCEPT - DONE

two levels
s/b
two or more levels
to match Isi-bbesmer comment in 4.8.1

● Author: Isi-bbesmer
Subject: Highlight
Date: 6/3/2008 7:50:46 PM

T ACCEPT - DONE (added "or self-configuring expander device, but kept "end device" which fits better with the last sentence)

an end device
s/b
a SAS initiator device or self-configuring expander device

● Author: Isi-bbesmer
Subject: Highlight
Date: 6/3/2008 7:50:22 PM

T REJECT (that change would create uncertainty about which "self-configuring expander device" is being referred to, when combined with the other change in this sentence. Rewording the sentence to make "management application client" the first noun/subject, and then use "it" to disambiguate:

"If a management application client is in an end device or a self-configuring expander device that is directly attached to a self-configuring expander device B with the configures others bit set to one in the REPORT GENERAL response (see 10.4.3.4), then it is not required to perform the configuration subprocess.")

end
s/b
SAS initiator device or self-configuring expander device

● Author: RElliott
Subject: Highlight
Date: 6/30/2008 6:16:52 PM

T ACCEPT - DONE

process
s/b
discover process

Figure 46 shows an example of level-order traversal.

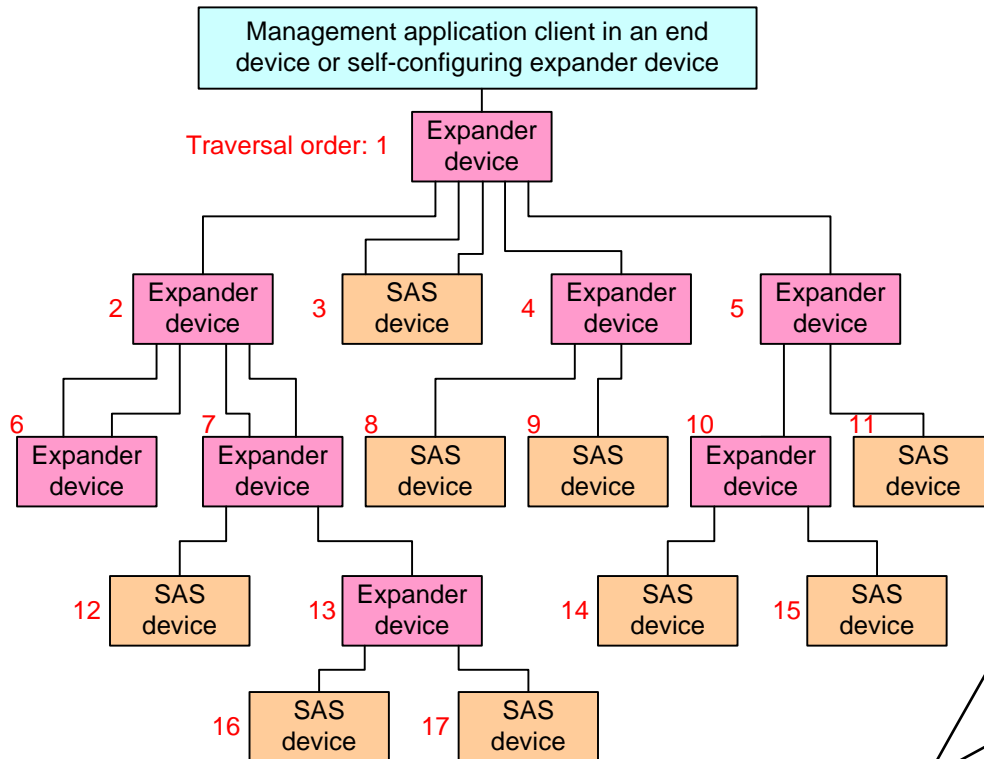

Note: Assume that the phy with the lowest phy identifier in each expander device is on the top right, and the remaining phys have increasing phy identifiers assigned in a counter-clockwise direction.

Figure 46 — Level-order traversal example

The management application client determines whether an expander device or SAS device is attached at each point in the traversal. For the first device (i.e., the **device directly attached**), this is determined from the DEVICE TYPE field in the IDENTIFY address frame (see 7.8.2) information received by the phy that the management application client is using. For other devices (i.e., **devices not directly attached**), this is determined from ATTACHED DEVICE TYPE field in the SMP DISCOVER response (see 10.4.3.10).

If an expander device is attached, **the** management application client shall use the SMP REPORT GENERAL function (see 10.4.3.4) to determine how many phys are in the expander device and then use the SMP DISCOVER function (see 10.4.3.10) and/or the SMP DISCOVER LIST function (see 10.4.3.15) to determine what is attached to each expander phy (e.g., the device type, SAS address, and supported protocol(s)).

NOTE 16 - Expander devices compliant with previous versions of this standard do not implement the SMP DISCOVER LIST function.

If the expander device's EXTERNALLY CONFIGURABLE ROUTE TABLE bit is set to zero in the SMP REPORT GENERAL response, its own management application client shall configure its own expander route table as described in 4.8.

While a self-configuring expander device's CONFIGURING bit is set to one in the SMP REPORT GENERAL response, connection requests for destination ports two or more levels beyond the self-configuring expander device that would otherwise have returned OPEN_REJECT (NO DESTINATION) return OPEN_REJECT (RETRY) instead (see 4.6.6.3 **and 4.7.2**).

● Author: RElliott
Subject: Highlight
Date: 6/30/2008 6:16:52 PM
T ACCEPT - DONE

device directly attached
s/b
device that is directly attached

● Author: RElliott
Subject: Highlight
Date: 6/30/2008 6:16:52 PM
T ACCEPT - DONE

devices not directly attached
s/b
devices that are not directly attached

● Author: RElliott
Subject: Highlight
Date: 6/30/2008 6:16:52 PM
T ACCEPT - DONE

the
s/b
then the

● Author: RElliott
Subject: Highlight
Date: 6/30/2008 6:16:52 PM
T ACCEPT - DONE

and 4.7.2
s/b
4.7.2, and 4.9.6.3

as the CONFIGURING bit is split into SELF CONFIGURING and ZONE CONFIGURING bits

If a SAS device is attached, **the discover process is not required to obtain any more information about the SAS device.** Additional discovery software may access that SAS device, **however:**

- a) if the SAS device supports an SMP target port, **the management application client may use SMP functions (e.g., REPORT GENERAL and REPORT MANUFACTURER INFORMATION)** to determine additional information about the SAS target device;
- b) if the SAS device supports an SSP target port, **a SCSI application client may transmit SCSI commands (e.g., INQUIRY and REPORT LUNS)** to determine additional information about the SCSI target device; and
- c) if the end device supports an STP target port, **an ATA application client may transmit ATA commands (e.g., IDENTIFY DEVICE and IDENTIFY PACKET DEVICE)** to determine additional information about the ATA device.

The result of the discover process is that the management application client has the necessary information (e.g., the device type, SAS address, and supported protocol(s)) to communicate with each SAS device and expander device in the SAS domain and each externally configurable expander device is configured with the necessary expander route entries to allow routing of connection requests through the SAS domain.

~~If the discover process occurs and any phy within the expander device is in the process of a link reset sequence resulting from an SMP PHY CONTROL function (see 10.4.3.28) phy operation of LINK RESET or HARD RESET, then the management device server shall set the NEGOTIATED PHYSICAL LINK RATE field (see table 279) to RESET_IN_PROGRESS in the SMP DISCOVER response (see 10.4.3.10).~~

The discover process may be aborted prior to completion and restarted if there is an indication that **it** may be based on incorrect information (e.g., reception of a Broadcast (Change) or a change in the EXPANDER CHANGE COUNT field returned in an SMP response).

Annex L contains an example implementation of how a management application client may perform the discover process.

4.7.2 Discover process in a self-configuring expander device

The management application client of a self-configuring expander device shall configure:

- a) the expander routing table in that expander device; and
- b) the expander routing table in each externally configurable expander device in the SAS domain that is not located behind another self-configuring expander **device.**

When a self-configuring expander device receives a Broadcast (Change) the management application client shall start the discover process using the expander port that received the Broadcast (Change). If a change to the expander route table is identified **then** the management device server shall set its **CONFIGURING bit** to one in the SMP REPORT GENERAL response (see 10.4.3.4).

If zoning is enabled, **the** management application client in a self-configuring expander device shall use the SMP DISCOVER response (see 10.4.3.10) or SMP DISCOVER LIST response (see 10.4.3.15) values to set the zone group values in the zoning expander route table for all SAS addresses in the zoning expander route table (see 4.9.3.4).

The **management application client** shall set the **CONFIGURING bit** to zero when the discover process is complete. When the **CONFIGURING bit** changes from one to zero:

- a) a zoning expander device with zoning enabled shall originate a Broadcast (Change) on each expander port that has access to the expander port through which the discover process was performed based on the zone permission table; and
- b) an expander device with zoning disabled shall originate a Broadcast (Change) on each expander port other than the one through which the discover process was performed.

When a Broadcast (Change) has been received by a self-configuring expander device, **all previously valid SAS addresses shall continue to be routable until they are determined to be no longer valid.** When a change has been identified, **all unaffected SAS addresses shall continue to be routable.**

Page: 88

Author: RElliott
Subject: Highlight
Date: 6/30/2008 6:16:52 PM
T ACCEPT - DONE
the
s/b
then the

Author: RElliott
Subject: Highlight
Date: 6/30/2008 6:16:52 PM
T ACCEPT - DONE
however
s/b
however, as follows

Author: RElliott
Subject: Highlight
Date: 6/30/2008 6:16:52 PM
T ACCEPT - DONE
the
s/b
then the

Author: RElliott
Subject: Highlight
Date: 6/30/2008 6:16:52 PM
T ACCEPT - DONE
a
s/b
then a

Author: RElliott
Subject: Highlight
Date: 6/30/2008 6:16:52 PM
T ACCEPT - DONE
an
s/b
then n

Author: lsi-bday
Subject: Cross-Out
Date: 5/25/2008 6:10:02 PM
T ACCEPT - DONE ("any phy" was misleading too. Only the phy being reset is subject to being reported as
T RESET_IN_PROGRESS. Deleted the paragraph as requested.)

If the discover process occurs and any phy within the expander device is in the process of a link reset sequence resulting from an SMP PHY CONTROL function (see 10.4.3.28) phy operation of LINK RESET or HARD RESET, then the management device server shall set the NEGOTIATED PHYSICAL LINK RATE field (see table 279) to RESET_IN_PROGRESS in the SMP DISCOVER response (see 10.4.3.10).

This statement is not entirely accurate. All the rules are listed in the SP state machine. For example, if previous value was UNSUPPORTED_PHY_ATTACHED, the SMP PHY CONTROL will not change that value to RESET_IN_PROGRESS.

Author: wdc-mevans
Subject: Highlight
Date: 5/6/2008 4:07:48 PM

Comments from page 88 continued on next page

If a SAS device is attached, the discover process is not required to obtain any more information about the SAS device. Additional discovery software may access that SAS device, however:

- a) if the SAS device supports an SMP target port, the management application client may use SMP functions (e.g., REPORT GENERAL and REPORT MANUFACTURER INFORMATION) to determine additional information about the SAS target device;
- b) if the SAS device supports an SSP target port, a SCSI application client may transmit SCSI commands (e.g., INQUIRY and REPORT LUNS) to determine additional information about the SCSI target device; and
- c) if the end device supports an STP target port, an ATA application client may transmit ATA commands (e.g., IDENTIFY DEVICE and IDENTIFY PACKET DEVICE) to determine additional information about the ATA device.

The result of the discover process is that the management application client has the necessary information (e.g., the device type, SAS address, and supported protocol(s)) to communicate with each SAS device and expander device in the SAS domain and each externally configurable expander device is configured with the necessary expander route entries to allow routing of connection requests through the SAS domain.

~~If the discover process occurs and any phy within the expander device is in the process of a link reset sequence resulting from an SMP PHY CONTROL function (see 10.4.3.28) phy operation of LINK RESET or HARD RESET, then the management device server shall set the NEGOTIATED PHYSICAL LINK RATE field (see table 279) to RESET_IN_PROGRESS in the SMP DISCOVER response (see 10.4.3.10).~~

The discover process may be aborted prior to completion and restarted if there is an indication that it may be based on incorrect information (e.g., reception of a Broadcast (Change) or a change in the EXPANDER CHANGE COUNT field returned in an SMP response).

Annex L contains an example implementation of how a management application client may perform the discover process.

4.7.2 Discover process in a self-configuring expander device

The management application client of a self-configuring expander device shall configure:

- a) the expander routing table in that expander device; and
- b) the expander routing table in each externally configurable expander device in the SAS domain that is not located behind another self-configuring expander device.

When a self-configuring expander device receives a Broadcast (Change) the management application client shall start the discover process using the expander port that received the Broadcast (Change). If a change to the expander route table is identified then the management device server shall set its CONFIGURING bit to one in the SMP REPORT GENERAL response (see 10.4.3.4).

If zoning is enabled, the management application client in a self-configuring expander device shall use the SMP DISCOVER response (see 10.4.3.10) or SMP DISCOVER LIST response (see 10.4.3.15) values to set the zone group values in the zoning expander route table for all SAS addresses in the zoning expander route table (see 4.9.3.4).

The management application client shall set the CONFIGURING bit to zero when the discover process is complete. When the CONFIGURING bit changes from one to zero:

- a) a zoning expander device with zoning enabled shall originate a Broadcast (Change) on each expander port that has access to the expander port through which the discover process was performed based on the zone permission table; and
- b) an expander device with zoning disabled shall originate a Broadcast (Change) on each expander port other than the one through which the discover process was performed.

When a Broadcast (Change) has been received by a self-configuring expander device, all previously valid SAS addresses shall continue to be routable until they are determined to be no longer valid. When a change has been identified, all unaffected SAS addresses shall continue to be routable.

TREJECT

it
s/b
the result of the process

● Author: RElliott
Subject: Underline
Date: 6/30/2008 6:16:52 PM
TACCEPT - DONE

based on
s/b
using

● Author: Isi-bbesmer
Subject: Highlight
Date: 5/25/2008 6:10:14 PM
TACCEPT - DONE

device
s/b
device with the CONFIGURES OTHERS bit set to one in the REPORT GENERAL response (see 10.4.3.4)

● Author: RElliott
Subject: Highlight
Date: 6/30/2008 6:16:52 PM
TACCEPT - DONE

CONFIGURING bit
s/b
SELF CONFIGURING bit

new bit per Isi-bbesmer comment on first page

● Author: RElliott
Subject: Highlight
Date: 6/30/2008 6:16:52 PM
TACCEPT - DONE

then
s/b
, then

● Author: RElliott
Subject: Highlight
Date: 6/30/2008 6:16:52 PM
TACCEPT - DONE

the
s/b
then the

● Author: RElliott
Subject: Highlight
Date: 6/30/2008 6:16:52 PM
TACCEPT - DONE

CONFIGURING bit
s/b
SELF CONFIGURING bit

Comments from page 88 continued on next page

If a SAS device is attached, **the** discover process is not required to obtain any more information about the SAS device. Additional discovery software may access that SAS device, **however:**

- a) if the SAS device supports an SMP target port, **the** management application client may use SMP functions (e.g., REPORT GENERAL and REPORT MANUFACTURER INFORMATION) to determine additional information about the SAS target device;
- b) if the SAS device supports an SSP target port, **a** SCSI application client may transmit SCSI commands (e.g., INQUIRY and REPORT LUNS) to determine additional information about the SCSI target device; and
- c) if the end device supports an STP target port, **an** ATA application client may transmit ATA commands (e.g., IDENTIFY DEVICE and IDENTIFY PACKET DEVICE) to determine additional information about the ATA device.

The result of the discover process is that the management application client has the necessary information (e.g., the device type, SAS address, and supported protocol(s)) to communicate with each SAS device and expander device in the SAS domain and each externally configurable expander device is configured with the necessary expander route entries to allow routing of connection requests through the SAS domain.

~~If the discover process occurs and any phy within the expander device is in the process of a link reset sequence resulting from an SMP PHY CONTROL function (see 10.4.3.28) phy operation of LINK RESET or HARD RESET, then the management device server shall set the NEGOTIATED PHYSICAL LINK RATE field (see table 279) to RESET_IN_PROGRESS in the SMP DISCOVER response (see 10.4.3.10).~~

The discover process may be aborted prior to completion and restarted if there is an indication that **it** may be based on incorrect information (e.g., reception of a Broadcast (Change) or a change in the EXPANDER CHANGE COUNT field returned in an SMP response).

Annex L contains an example implementation of how a management application client may perform the discover process.

4.7.2 Discover process in a self-configuring expander device

The management application client of a self-configuring expander device shall configure:

- a) the expander routing table in that expander device; and
- b) the expander routing table in each externally configurable expander device in the SAS domain that is not located behind another self-configuring expander **device.**

When a self-configuring expander device receives a Broadcast (Change) the management application client shall start the discover process using the expander port that received the Broadcast (Change). If a change to the expander route table is identified **then** the management device server shall set its **CONFIGURING bit** to one in the SMP REPORT GENERAL response (see 10.4.3.4).

If zoning is enabled, **the** management application client in a self-configuring expander device shall use the SMP DISCOVER response (see 10.4.3.10) or SMP DISCOVER LIST response (see 10.4.3.15) values to set the zone group values in the zoning expander route table for all SAS addresses in the zoning expander route table (see 4.9.3.4).

The **management application client** shall set the **CONFIGURING bit** to zero when the discover process is complete. When the **CONFIGURING bit** changes from one to zero:

- a) a zoning expander device with zoning enabled shall originate a Broadcast (Change) on each expander port that has access to the expander port through which the discover process was performed based on the zone permission table; and
- b) an expander device with zoning disabled shall originate a Broadcast (Change) on each expander port other than the one through which the discover process was performed.

When a Broadcast (Change) has been received by a self-configuring expander device, **all previously valid SAS addresses shall continue to be routable until they are determined to be no longer valid.** When a change has been identified, **all unaffected SAS addresses shall continue to be routable.**

new bit per lsi-bbesmer comment on first page

Author: RElliott
Subject: Highlight
Date: 6/30/2008 6:16:52 PM
T ACCEPT - DONE

management application client
s/b
management device server

Author: RElliott
Subject: Underline
Date: 6/30/2008 6:16:52 PM
T ACCEPT - DONE

CONFIGURING bit
s/b
SELF CONFIGURING bit

new bit per lsi-bbesmer comment on first page. Broadcast (Change) will trigger based on the individual bits, not the OR of the two.

Author: wdc-mevans
Subject: Highlight
Date: 5/25/2008 6:10:36 PM

T ACCEPT - DONE ("After receiving a Broadcast (Change), a self-configuring expander device shall continue to route connection requests for each previously valid SAS address until it determines that it is no longer valid. After determining that a SAS address is no longer valid, the self-configuring expander device shall continue to route connection requests for other SAS addresses.")

all previously valid SAS addresses shall continue to be routable until they are determined to be no longer valid.

s/b

the expander device continues to be able to route requests to and responses from all SAS addresses in the expander's route table until the addresses are determined to no longer be valid.

Author: wdc-mevans
Subject: Highlight
Date: 5/25/2008 6:10:51 PM

T ACCEPT - DONE (see previous comment for rewrite of paragraph)

all unaffected SAS addresses shall continue to be routable.

s/b

the expander device continues to be able to route requests to and responses from all SAS addresses in the expander's route table that were not affected by the change..

While the `CONFIGURING` bit is set to one, the expander device shall return `OPEN_REJECT (RETRY)` for any connection requests that would otherwise have resulted in `OPEN_REJECT (NO DESTINATION)` (see 4.6.6.3).

The management application client in a self-configuring expander device shall maintain self-configuration status for the last vendor-specific number of errors encountered during self-configuration and should maintain at least one self-configuration status per phy. The management device server shall assign descriptors to the statuses sequentially starting at 0001h and shall return the descriptors in the `SMP REPORT SELF-CONFIGURATION STATUS` response (see 10.4.3.6). The management device server shall return the index of the last self-configuration status descriptor in the `SMP REPORT GENERAL` response (see 10.4.3.4), the `SMP REPORT SELF-CONFIGURATION STATUS` response (see 10.4.3.6), and the `SMP DISCOVER LIST` response (see 10.4.3.15). The management device server shall wrap the index to 0001h when the highest supported descriptor index has been used.

The management device server shall support self-configuration status descriptor indexes from 0001h to FFFFh. The actual number of self-configuration status descriptors that the management device server maintains for retrieval with the `REPORT SELF-CONFIGURATION STATUS` request is vendor specific and is indicated by the `MAXIMUM NUMBER OF STORED SELF-CONFIGURATION STATUS DESCRIPTORS` field defined in the `REPORT GENERAL` response (see 10.4.3.4). The volatility of these stored descriptors is vendor specific. The management device server shall replace the least recently recorded self-configuration status descriptor with a new one once the number of recorded descriptors exceeds the value indicated by the `MAXIMUM NUMBER OF STORED SELF-CONFIGURATION STATUS DESCRIPTORS` field.

4.7.3 Enabling multiplexing

A management application client may configure multiplexing (see 6.10) in expander devices. Self-configuring expander devices may configure multiplexing for their own phys. The choice of whether or not to enable multiplexing on a physical link is vendor-specific.

If the SAS domain contains all 6 Gbps target phys, then the management application clients should disable multiplexing on every phy.

If the SAS domain contains all 3 Gbps target phys, then the management application clients should:

- a) multiplex each 6 Gbps physical link into two 3 Gbps logical links; and
- b) not multiplex 3 Gbps physical links.

If the SAS domain contains all 1.5 Gbps target phys, then the management application client should:

- a) multiplex each 6 Gbps physical link into two 3 Gbps logical links; and
- b) multiplex each 3 Gbps physical link into two 1.5 Gbps logical links.

NOTE 17 - Rate matching is used for 1.5 Gbps connections carried on 3 Gbps logical links.

4.8 Configuration subprocess

4.8.1 Configuration subprocess overview

As part of the discover process (see 4.7), when it discovers externally configurable expander device, the management application client performs the configuration subprocess to configure the expander routing table in that externally configurable expander device with SAS addresses discovered **two levels** beyond each table routing phy in that externally configurable expander device. A single discover process performs the configuration subprocess at least once per externally configurable expander device.

The routing table in an expander device needs to be configured before connections are able to be established with devices attached **two levels** beyond that expander device.

4.8.2 Allowed topologies

If the management application client detects an externally configurable expander device phy with the table routing attribute attached to an expander device phy with either the direct routing attribute or the table routing attribute, it shall report an error in a vendor-specific manner.

Author: RElliott
Subject: Underline
Date: 6/30/2008 6:16:52 PM
 ACCEPT - DONE

CONFIGURING bit
s/b
SELF CONFIGURING bit

new bit per lsi-bbesmer comment on first page.

Although this is also true for the ZONE CONFIGURING bit (and thus for the combined CONFIGURING bit), this is not the appropriate section for that rule.

Author: RElliott
Subject: Underline
Date: 6/30/2008 6:16:52 PM
 ACCEPT - DONE

least recently recorded
s/b
oldest

to match wdc-mevans comment in 4.11

Author: lsi-bbesmer
Subject: Note
Date: 5/25/2008 6:11:11 PM

 REJECT (All that are listed are the obvious correct choices - all targets being the same rate. There is no good way to guess the proper choice in mixed cases - it depends on which targets (the fast or slow ones) are more important for the workload.)

Several permutations are not specified:

6	3	1.5	
0	0	0	N/A
0	0	1	Rule 3
0	1	0	Rule 2
0	1	1	Not Specified -> Rule 2?
1	0	0	Rule 1
1	0	1	Not Specified -> Rule 1?
1	1	0	Not Specified -> Rule 1?
1	1	1	Not Specified -> Rule 1?

Rule 1 = No MP
Rule 2 = MP 6 to 3, No MP for 3
Rule 3 = MP 6 to 3, 3 to 1.5

Author: lsi-bbesmer
Subject: Note
Date: 5/25/2008 6:11:24 PM

 ACCEPT - DONE (replacing "target phys" with "SAS phys" so both initiators and targets are considered equal. Expander phys are not "SAS phys". This means a case like one 6 Gbps initiator and all 3 Gbps targets is no longer covered by any "should" level advice.)

This seems to be written from the perspective of a single SAS initiator device, however consider the case of Self Config Expanders performing this, then these rules need to consider both target phys and initiator phys. Another case to consider is multiple SAS Initiator devices with mixed rates (ie. 1 at 3G another at 6G).

While the `CONFIGURING` bit is set to one, the expander device shall return `OPEN_REJECT (RETRY)` for any connection requests that would otherwise have resulted in `OPEN_REJECT (NO DESTINATION)` (see 4.6.6.3).

The management application client in a self-configuring expander device shall maintain self-configuration status for the last vendor-specific number of errors encountered during self-configuration and should maintain at least one self-configuration status per phy. The management device server shall assign descriptors to the statuses sequentially starting at 0001h and shall return the descriptors in the `SMP REPORT SELF-CONFIGURATION STATUS` response (see 10.4.3.6). The management device server shall return the index of the last self-configuration status descriptor in the `SMP REPORT GENERAL` response (see 10.4.3.4), the `SMP REPORT SELF-CONFIGURATION STATUS` response (see 10.4.3.6), and the `SMP DISCOVER LIST` response (see 10.4.3.15). The management device server shall wrap the index to 0001h when the highest supported descriptor index has been used.

The management device server shall support self-configuration status descriptor indexes from 0001h to FFFFh. The actual number of self-configuration status descriptors that the management device server maintains for retrieval with the `REPORT SELF-CONFIGURATION STATUS` request is vendor specific and is indicated by the `MAXIMUM NUMBER OF STORED SELF-CONFIGURATION STATUS DESCRIPTORS` field defined in the `REPORT GENERAL` response (see 10.4.3.4). The volatility of these stored descriptors is vendor specific. The management device server shall replace the least recently recorded self-configuration status descriptor with a new one once the number of recorded descriptors exceeds the value indicated by the `MAXIMUM NUMBER OF STORED SELF-CONFIGURATION STATUS DESCRIPTORS` field.

4.7.3 Enabling multiplexing

A management application client may configure multiplexing (see 6.10) in expander devices. Self-configuring expander devices may configure multiplexing for their own phys. The choice of whether or not to enable multiplexing on a physical link is vendor-specific.

If the SAS domain contains all 6 Gbps target phys, then the management application clients should disable multiplexing on every phy.

If the SAS domain contains all 3 Gbps target phys, then the management application clients should:

- a) multiplex each 6 Gbps physical link into two 3 Gbps logical links; and
- b) not multiplex 3 Gbps physical links.

If the SAS domain contains all 1.5 Gbps target phys, then the management application clients should:

- a) multiplex each 6 Gbps physical link into two 3 Gbps logical links; and
- b) multiplex each 3 Gbps physical link into two 1.5 Gbps logical links.

NOTE 17 - Rate matching is used for 1.5 Gbps connections carried on 3 Gbps logical links.

4.8 Configuration subprocess

4.8.1 Configuration subprocess overview

As part of the discover process (see 4.7), when it discovers externally configurable expander device, the management application client performs the configuration subprocess to configure the expander routing table in that externally configurable expander device with SAS addresses discovered **two levels** beyond each table routing phy in that externally configurable expander device. A single discover process performs the configuration subprocess at least once per externally configurable expander device.

The routing table in an expander device needs to be configured before connections are able to be established with devices attached **two levels** beyond that expander device.

4.8.2 Allowed topologies

If the management application client detects an externally configurable expander device phy with the table routing attribute attached to an expander device phy with either the direct routing attribute or the table routing attribute, it shall report an error in a vendor-specific manner.

● Author: lsi-bbesmer

Subject: Highlight

Date: 5/6/2008 4:07:48 PM

T REJECT (true, but this note (being in a section called "Enabling multiplexing" is explaining that after multiplexing 6 Gbps down to 3 Gbps, rate matching is still needed. Wording suggestions are welcome to clarify this.)

RM is also used for:

- 3 Gbps connections on 6 Gbps logical links
- 1.5 Gbps connections on 6 Gbps logical links

Perhaps more generic note:

Rate matching is used for lower rate connections across higher rate logical links.

● Author: ktek-dmoore

Subject: Highlight

Date: 5/6/2008 4:07:48 PM

T REJECT (true, but this note (being in a section called "Enabling multiplexing" is explaining that after multiplexing 6 Gbps down to 3 Gbps, rate matching is still needed. Wording suggestions are welcome to clarify this.)

Rate matching is used for 1.5 Gbps connections carried on 3 Gbps logical links.

Isn't rate matching allowed on any speed link? If I choose to not enable rate matching, can't I talk to a 3Gbps device attached to an expander talking to a 6Gbps HBA?

● Author: lsi-bbesmer

Subject: Highlight

Date: 5/25/2008 6:11:58 PM

T ACCEPT - DONE (but keeping "it")

it discovers externally

s/b

the management application client discovers **an externally**

● Author: lsi-bbesmer

Subject: Highlight

Date: 5/6/2008 4:07:48 PM

T ACCEPT - DONE (also in 4.7.1)

two levels

s/b

two levels or more

● Author: RElliott

Subject: Highlight

Date: 6/30/2008 6:16:52 PM

T ACCEPT - DONE

two levels

s/b

two or more levels

to match lsi-bbesmer comment in prev paragraph

● Author: elx-bmartin

Subject: Comment on Text

Date: 5/6/2008 4:07:48 PM

T REJECT (table-to-table is only allowed for self-configuring expanders, not externally configurable expanders)

table to table is now allowed. This always reports an error on this. This needs to be qualified by whether the expander supports table to table routing.

● Author: lsi-bbesmer

Subject: Note

Date: 5/25/2008 6:12:27 PM

T REJECT (only self-configuring expanders are allowed to set the TABLE TO TABLE bit to one. If an externally configurable

Comments from page 89 continued on next page

While the `CONFIGURING` bit is set to one, the expander device shall return `OPEN_REJECT (RETRY)` for any connection requests that would otherwise have resulted in `OPEN_REJECT (NO DESTINATION)` (see 4.6.6.3).

The management application client in a self-configuring expander device shall maintain self-configuration status for the last vendor-specific number of errors encountered during self-configuration and should maintain at least one self-configuration status per phy. The management device server shall assign descriptors to the statuses sequentially starting at 0001h and shall return the descriptors in the `SMP REPORT SELF-CONFIGURATION STATUS` response (see 10.4.3.6). The management device server shall return the index of the last self-configuration status descriptor in the `SMP REPORT GENERAL` response (see 10.4.3.4), the `SMP REPORT SELF-CONFIGURATION STATUS` response (see 10.4.3.6), and the `SMP DISCOVER LIST` response (see 10.4.3.15). The management device server shall wrap the index to 0001h when the highest supported descriptor index has been used.

The management device server shall support self-configuration status descriptor indexes from 0001h to FFFFh. The actual number of self-configuration status descriptors that the management device server maintains for retrieval with the `REPORT SELF-CONFIGURATION STATUS` request is vendor specific and is indicated by the `MAXIMUM NUMBER OF STORED SELF-CONFIGURATION STATUS DESCRIPTORS` field defined in the `REPORT GENERAL` response (see 10.4.3.4). The volatility of these stored descriptors is vendor specific. The management device server shall replace the least recently recorded self-configuration status descriptor with a new one once the number of recorded descriptors exceeds the value indicated by the `MAXIMUM NUMBER OF STORED SELF-CONFIGURATION STATUS DESCRIPTORS` field.

4.7.3 Enabling multiplexing

A management application client may configure multiplexing (see 6.10) in expander devices. Self-configuring expander devices may configure multiplexing for their own phys. The choice of whether or not to enable multiplexing on a physical link is vendor-specific.

If the SAS domain contains all 6 Gbps target phys, then the management application clients should disable multiplexing on every phy.

If the SAS domain contains all 3 Gbps target phys, then the management application clients should:

- a) multiplex each 6 Gbps physical link into two 3 Gbps logical links; and
- b) not multiplex 3 Gbps physical links.

If the SAS domain contains all 1.5 Gbps target phys, then the management application client should:

- a) multiplex each 6 Gbps physical link into two 3 Gbps logical links; and
- b) multiplex each 3 Gbps physical link into two 1.5 Gbps logical links.

NOTE 17 - Rate matching is used for 1.5 Gbps connections carried on 3 Gbps logical links.

4.8 Configuration subprocess

4.8.1 Configuration subprocess overview

As part of the discover process (see 4.7), when it discovers externally configurable expander device, the management application client performs the configuration subprocess to configure the expander routing table in that externally configurable expander device with SAS addresses discovered **two levels** beyond each table routing phy in that externally configurable expander device. A single discover process performs the configuration subprocess at least once per externally configurable expander device.

The routing table in an expander device needs to be configured before connections are able to be established with devices attached **two levels** beyond that expander device.

4.8.2 Allowed topologies

If the management application client detects an externally configurable expander device phy with the table routing attribute attached to an expander device phy with either the direct routing attribute or the table routing attribute, it shall report an error in a vendor-specific manner.

expander device phy is so attached, it's an error.)

Conflicts with Table to Table supported in REPORT GENERAL

Author: RElliott

Subject: Note

Date: 9/3/2008 5:51:01 PM

 ACCEPT - DONE (reworded first sentence as:

If the management application client detects:

- a) an expander phy with the table routing attribute in an externally configurable expander device; or
- b) an expander phy with the table routing attribute in a self-configuring expander device with the table to table bit set to zero in the SMP REPORT GENERAL response,
attached to:

a) an expander phy with either the direct routing attribute or the table routing attribute in either an externally configurable expander device or a self-configuring expander device,
then it shall report an error in a vendor-specific manner.

This visually separates the two sides being attached, and mentions that self-configuring expanders might have TABLE TO TABLE set to zero.

)

7/15 yes, this is based on feedback from 5/5)

put table-to-table restriction in 4.8.2 (more clearly)

Author: wdc-mevans

Subject: Highlight

Date: 6/1/2008 5:07:35 PM

 REJECT (first noun/subject convention, but added then)

it

s/b

then the management application client

If the management application client detects an overflow of an expander route index, it shall report an error in a vendor-specific manner.

If the route table optimization (see 4.8.3) is disabled and the management application client detects an expander route entry that references the SAS address of the expander device itself (i.e., self-reference), it shall disable the expander route entry by setting the DISABLE EXPANDER ROUTE ENTRY bit to one in the SMP CONFIGURE ROUTE INFORMATION request (see 10.4.3.27). The management application client shall disable each expander route entry in the expander route table by setting the DISABLE EXPANDER ROUTE ENTRY bit to one in the SMP CONFIGURE ROUTE INFORMATION request (see 10.4.3.27) for each expander phy that has its attached device type set to 000b (i.e., no device attached).

If the management application client detects a port that the configuration subprocess has not already configured with a SAS address it has already found attached to another expander device, it should use the SMP PHY CONTROL function (see 10.4.3.28) to disable all the expander phys attached to that SAS address except for phys in the expander device with the lowest SAS address. Figure 47 shows some illegal topologies

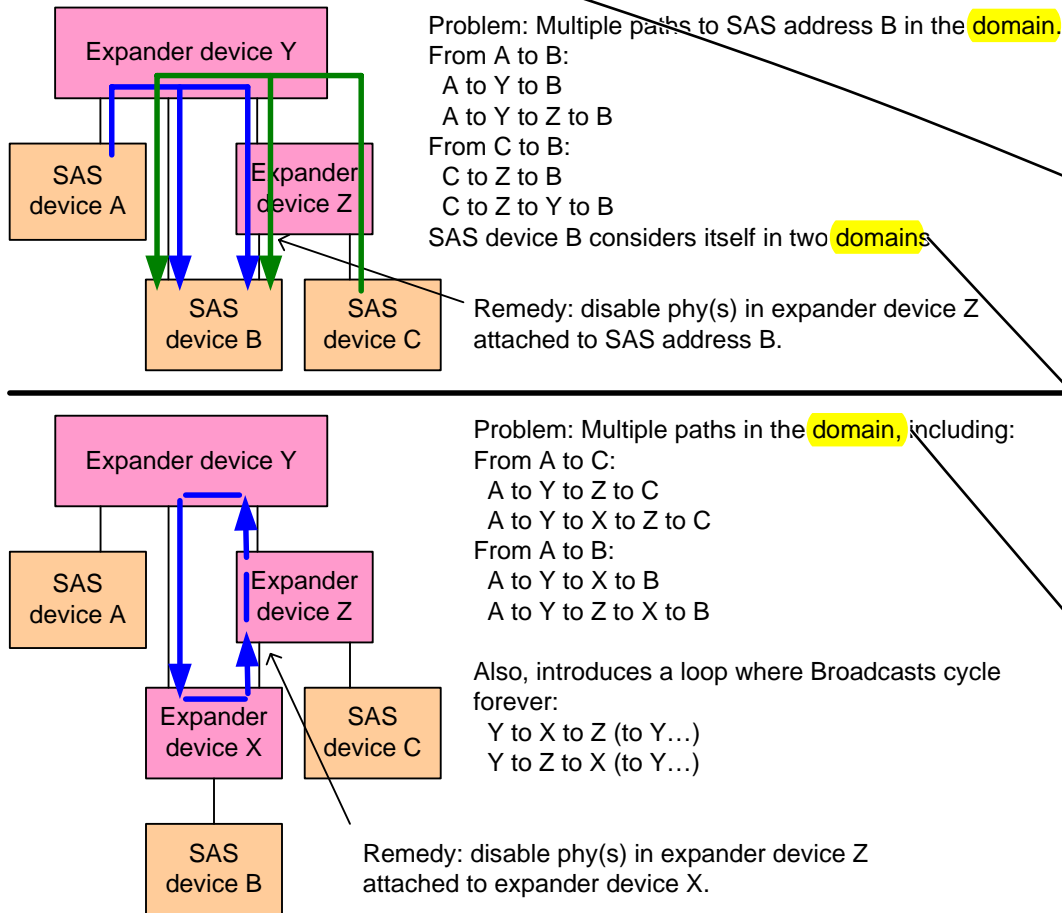

Figure 47 — Examples of invalid topologies

Annex L contains an example implementation of how a management application client may perform the discover process and configuration subprocess.

4.8.3 Route table optimization

The management application client shall support a route table optimization that reduces the number of entries required in an expander route table in an externally configurable expander device. The method used to enable and disable the route table optimization is vendor specific.

Page: 90

Author: wdc-mevans

Subject: Highlight

Date: 6/1/2008 5:07:27 PM

T REJECT (first noun/subject convention, but added "then")

it

s/b

then the management application client

Author: wdc-mevans

Subject: Highlight

Date: 5/25/2008 6:13:23 PM

T ACCEPT - DONE

it

s/b

then the management application client

Author: wdc-mevans

Subject: Highlight

Date: 5/25/2008 6:13:48 PM

T REJECT (but added "then")

it

s/b

then the management application client

Author: wdc-mevans

Subject: Highlight

Date: 5/25/2008 6:13:37 PM

T REJECT (instead, changing to an a) b) list. As currently worded, there needs to at least be an "and" joining the two conditions)

it

s/b

that the management application client

Author: RElliott

Subject: Highlight

Date: 6/30/2008 6:16:52 PM

T ACCEPT - DONE

domain

s/b

SAS domain

Author: RElliott

Subject: Highlight

Date: 6/30/2008 6:16:52 PM

T ACCEPT - DONE

domains

s/b

SAS domains

Author: RElliott

Subject: Highlight

Date: 6/30/2008 6:16:52 PM

T ACCEPT - DONE

domain

s/b

Comments from page 90 continued on next page

If the management application client detects an overflow of an expander route index, it shall report an error in a vendor-specific manner.

If the route table optimization (see 4.8.3) is disabled and the management application client detects an expander route entry that references the SAS address of the expander device itself (i.e., self-reference), it shall disable the expander route entry by setting the DISABLE EXPANDER ROUTE ENTRY bit to one in the SMP CONFIGURE ROUTE INFORMATION request (see 10.4.3.27). The management application client shall disable each expander route entry in the expander route table by setting the DISABLE EXPANDER ROUTE ENTRY bit to one in the SMP CONFIGURE ROUTE INFORMATION request (see 10.4.3.27) for each expander phy that has its attached device type set to 000b (i.e., no device attached).

If the management application client detects a port that the configuration subprocess has not already configured with a SAS address it has already found attached to another expander device, it should use the SMP PHY CONTROL function (see 10.4.3.28) to disable all the expander phys attached to that SAS address except for phys in the expander device with the lowest SAS address. Figure 47 shows some illegal topologies.

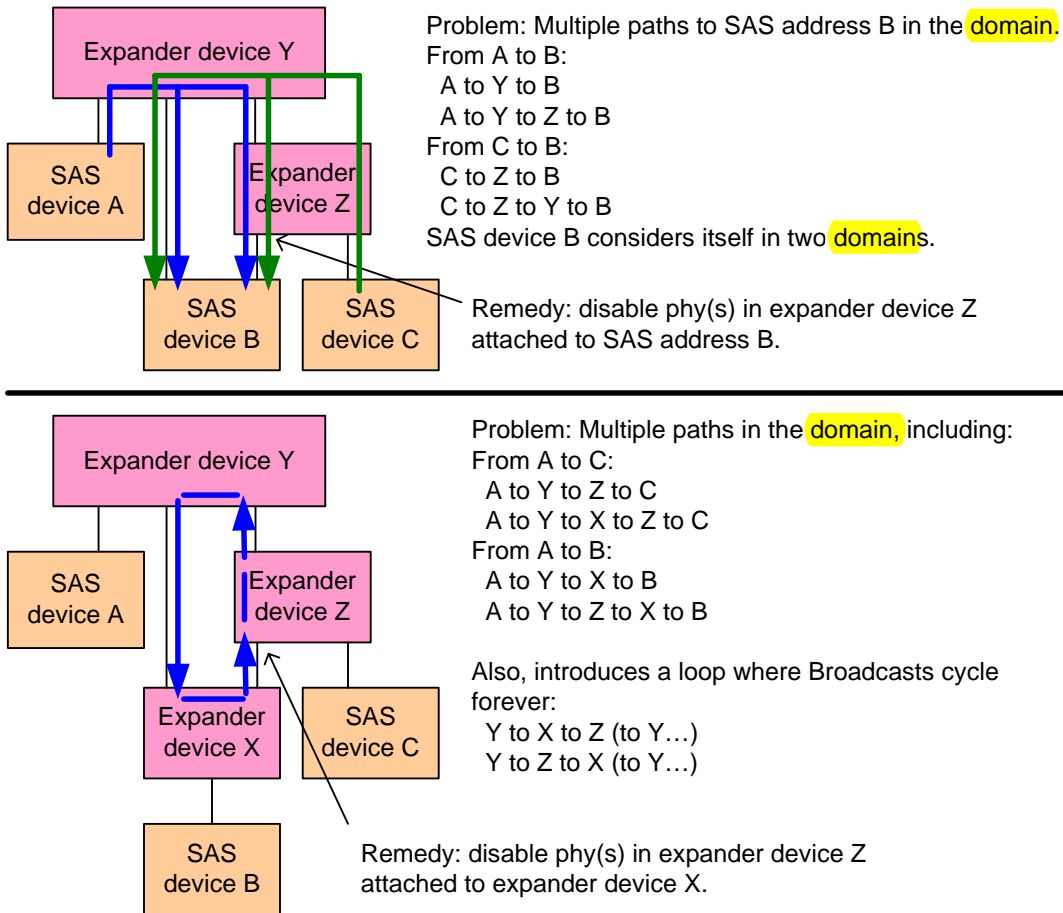

Figure 47 — Examples of invalid topologies

Annex L contains an example implementation of how a management application client may perform the discover process and configuration subprocess.

4.8.3 Route table optimization

The management application client shall support a route table optimization that reduces the number of entries required in an expander route table in an externally configurable expander device. The method used to enable and disable the route table optimization is vendor specific.

If the route table optimization is enabled, then the management application client shall exclude discovered SAS addresses from the expander route table when any of the following conditions are met:

- a) in the SMP DISCOVER response (see 10.4.3.10) for the discovered phy:
 - A) the FUNCTION RESULT field is set to a non-zero value (i.e., not SMP FUNCTION ACCEPTED);
 - b) in the SMP DISCOVER response for the discovered phy:
 - A) the FUNCTION RESULT field is set to zero (i.e., SMP FUNCTION ACCEPTED);
 - B) the ROUTING ATTRIBUTE field is set to 1h (i.e., subtractive) or 2h (i.e., table); and
 - C) the ATTACHED DEVICE TYPE field is set to zero (i.e., no device attached);
 - c) in the SMP DISCOVER response for the discovered phy:
 - A) the FUNCTION RESULT field is set to zero (i.e., SMP FUNCTION ACCEPTED);
 - B) the ROUTING ATTRIBUTE field is set to 1h (i.e., subtractive) or 2h (i.e., table);
 - C) the ATTACHED DEVICE TYPE field is set to a non-zero value (e.g., end device or expander device); and
 - D) the ATTACHED SAS ADDRESS field contains the SAS address of the expander device being configured (i.e., a self-referencing address);
 - d) in the SMP DISCOVER response for the discovered phy:
 - A) the FUNCTION RESULT field is set to zero (i.e., SMP FUNCTION ACCEPTED);
 - B) the ROUTING ATTRIBUTE field is set to 1h (i.e., subtractive) or 2h (i.e., table);
 - C) the ATTACHED DEVICE TYPE field is set to a non-zero value (e.g., end device or expander device); and
 - D) the ATTACHED SAS ADDRESS field contains the SAS address of a device directly attached to the expander device being configured;
- or
- e) in the SMP DISCOVER response for the discovered phy:
 - A) the FUNCTION RESULT field is set to zero (i.e., SMP FUNCTION ACCEPTED);
 - B) the ROUTING ATTRIBUTE field is set to 1h (i.e., subtractive) or 2h (i.e., table);
 - C) the ATTACHED DEVICE TYPE field is set to a non-zero value (e.g., end device or expander device); and
 - D) the ATTACHED SAS ADDRESS field contains a SAS address that already exists in the expander route table.

If the discovered SAS address being included in the expander route table is for a device that is currently not attached (i.e., the ATTACHED DEVICE TYPE field is set to zero (i.e., no device attached) and the ROUTE ATTRIBUTE field is set to 0h (i.e., direct)), then the entry shall be inserted with the ROUTED SAS ADDRESS field set to 00000000 00000000h and the DISABLE EXPANDER ROUTE ENTRY bit set to one (see 10.4.3.27).

If route table optimization is disabled, then all SAS addresses shall be qualified for insertion in the expander route table.

If the management application client supports route table optimization, then the management application client should provide a vendor-specific method for initiating a check of the resulting expander route tables. The check should be performed under the following situations:

- a) when an I_T nexus loss occurs for a destination port that is expected to be present;
- b) when a discover process has been completed;
- c) when another SMP initiator port is discovered in the SAS domain; or
- d) when a self-configuring expander device is discovered in the SAS domain.

If the management application client detects an inconsistency in the expander route tables when route table optimization is enabled (e.g., detects entries that appear to have been filled in by a discover process with route table optimization disabled), then the management application client shall report an error in a vendor-specific manner and shall disable route table optimization. The management application client should then re-initiate a discover process with route table optimization disabled.

4.8.4 Expander route index order

The expander route table shall be configured for each expander phy that has a table routing attribute.

● Author: lsi-bbesmer

Subject: Highlight

Date: 5/25/2008 6:14:14 PM

T REJECT (5/5 This is the same rule as in SAS-1.1. In SAS-2, it is true that phys can come and go due to zoning, but we cannot change the optimization rule to leave a slot for it without breaking SAS-1.1 compatibility. The best advice is to use all self-configuring expanders with zoning.)

What about PHY VACANT?

● Author: RElliott

Subject: Highlight

Date: 6/30/2008 6:16:52 PM

T ACCEPT - DONE

i.e.

s/b

i.e.,

● Author: wdc-mevans

Subject: Highlight

Date: 5/6/2008 4:07:48 PM

T REJECT (only 2 items being anded)

attached) and

s/b

attached), and

● Author: lsi-gpenokie

Subject: Highlight

Date: 5/25/2008 6:14:36 PM

T ACCEPT - DONE (The conventions section defines both. SAS mostly uses spaces; agree to change most of the rest to use space as well. The only except is the G(x) polynomial definition, where there are 9 hex digits starting with a 1. 1<space>04C11DB7h is not as clear as 1_04C11DB7h - it looks like it means "one 04C11DB7h". Usually there are multiple digits together and it is obvious that they're part of one value.)

Global - There needs to be consistency here. In other places an << _ >> is used. Here a space is used << 00000000 00000000h >> one or the other needs to be selected and used throughout the standard.

If the phy is not attached to an expander device, every expander route entry for that phy shall be disabled (i.e., the ROUTED SAS ADDRESS field shall be set to 00000000 00000000h and the DISABLE EXPANDER ROUTE ENTRY bit shall be set to one).

If the phy is attached to an expander device, the expander route table shall be configured for that phy as follows. For purposes of configuring the expander route table for that phy, the expander devices attached to the expander phy are assigned levels:

- 1) the expander device in which the expander route table is being configured is level 0;
- 2) the attached expander device is considered level 1;
- 3) devices attached to the level 1 expander device, except for the level 0 expander device, are considered level 2;
- 4) devices attached to level 2 expander devices, except for level 1 expander devices, are considered level 3; and
- 5) for each n greater than 3, devices attached to level n-1 expander devices, except for level n-2 expander devices, are considered level n.

The expander route table for each expander phy shall be configured starting from expander route index 0 by level (e.g., if there are three levels, then all level 1 entries first, then all level 2 entries, then all level 3 entries) up to the value of the EXPANDER ROUTE INDEXES field reported by the SMP REPORT GENERAL function (see 10.4.3.4).

Assuming the level 1 expander device has expander phys attached to N phys with qualified SAS addresses (see 4.8.3), the first N entries shall be used for those SAS addresses in expander phy order (i.e., the addresses attached to lower expander phy numbers first).

For each of the level 2 devices that:

- a) is an expander device attached to M phys with qualified SAS addresses; and
- b) is attached to an expander phy in the level 1 expander device with the table routing attribute,

the next M entries shall be used for the level 2 expander device's qualified SAS addresses in expander phy order (i.e., lower phy numbers first).

This process shall repeat for all levels of expander devices.

SAS addresses of devices attached beyond expander phys that are attached table-to-table shall not be included in the expander route table. The SAS address of the first expander device that is attached table-to-table shall be included and the SAS address of every device attached beyond that expander device shall not be included.

NOTE 18 - Not including those SAS addresses provides compatibility with management application clients compliant with previous versions of this standard. End devices in SAS domains containing externally configurable expander devices and table-to-table attachments may not be able to establish connections to each other. End devices in SAS domains containing only self-configuring expander devices compliant with this standard (i.e., supporting table-to-table attachments) are able to establish connections to any other end device.

Page: 92

Author: RElliott
Subject: Highlight
Date: 6/30/2008 6:16:52 PM
T ACCEPT - DONE

every
s/b
then every

Author: wdc-mevans
Subject: Highlight
Date: 5/25/2008 6:14:54 PM
T REJECT (this is referring to the phy in the first paragraph of the section that has a table routing attribute)

the phy
s/b
a phy

Author: RElliott
Subject: Highlight
Date: 6/30/2008 6:16:52 PM
T ACCEPT - DONE

the
s/b
then the

Author: wdc-mevans
Subject: Highlight
Date: 5/25/2008 6:14:59 PM
T REJECT (this is referring to the phy in the first paragraph of the section that has a table routing attribute)

the phy
s/b
a phy

Author: lsi-bday
Subject: Highlight
Date: 5/25/2008 6:15:12 PM
T ACCEPT - DONE

Assuming the level 1...

Suggest
If the level 1...

Author: RElliott
Subject: Highlight
Date: 6/30/2008 6:16:52 PM
T ACCEPT - DONE

the
s/b
then the

Author: wdc-mevans
Subject: Highlight
Date: 5/6/2008 4:07:48 PM
T ACCEPT - DONE

repeat
s/b

Comments from page 92 continued on next page

If the phy is not attached to an expander device, every expander route entry for that phy shall be disabled (i.e., the ROUTED SAS ADDRESS field shall be set to 00000000 00000000h and the DISABLE EXPANDER ROUTE ENTRY bit shall be set to one).

If the phy is attached to an expander device, the expander route table shall be configured for that phy as follows. For purposes of configuring the expander route table for that phy, the expander devices attached to the expander phy are assigned levels:

- 1) the expander device in which the expander route table is being configured is level 0;
- 2) the attached expander device is considered level 1;
- 3) devices attached to the level 1 expander device, except for the level 0 expander device, are considered level 2;
- 4) devices attached to level 2 expander devices, except for level 1 expander devices, are considered level 3; and
- 5) for each n greater than 3, devices attached to level n-1 expander devices, except for level n-2 expander devices, are considered level n.

The expander route table for each expander phy shall be configured starting from expander route index 0 by level (e.g., if there are three levels, then all level 1 entries first, then all level 2 entries, then all level 3 entries) up to the value of the EXPANDER ROUTE INDEXES field reported by the SMP REPORT GENERAL function (see 10.4.3.4).

Assuming the level 1 expander device has expander phys attached to N phys with qualified SAS addresses (see 4.8.3), the first N entries shall be used for those SAS addresses in expander phy order (i.e., the addresses attached to lower expander phy numbers first).

For each of the level 2 devices that:

- a) is an expander device attached to M phys with qualified SAS addresses; and
- b) is attached to an expander phy in the level 1 expander device with the table routing attribute,

the next M entries shall be used for the level 2 expander device's qualified SAS addresses in expander phy order (i.e., lower phy numbers first).

This process shall repeat for all levels of expander devices.

SAS addresses of devices attached beyond expander phys that are attached table-to-table shall not be included in the expander route table. The SAS address of the first expander device that is attached table-to-table shall be included and the SAS address of every device attached beyond that expander device shall not be included.

NOTE 18 - Not including those SAS addresses provides compatibility with management application clients compliant with previous versions of this standard. End devices in SAS domains containing externally configurable expander devices and table-to-table attachments may not be able to establish connections to each other. End devices in SAS domains containing only self-configuring expander devices compliant with this standard (i.e., supporting table-to-table attachments) are able to establish connections to any other end device.

be repeated

Author: lsi-gpenokie
Subject: Highlight
Date: 5/25/2008 6:15:25 PM

T ACCEPT - DONE

This statement implies that all expander compliant with this standard will support table-to-table routing. That is not correct. So this << devices compliant with this standard (i.e., supporting table-to-table attachments) are >> should be << devices supporting table-to-table attachments are >>

This page contains no comments

Figure 49 shows a portion of a SAS domain, where phy A in expander device R is being configured.

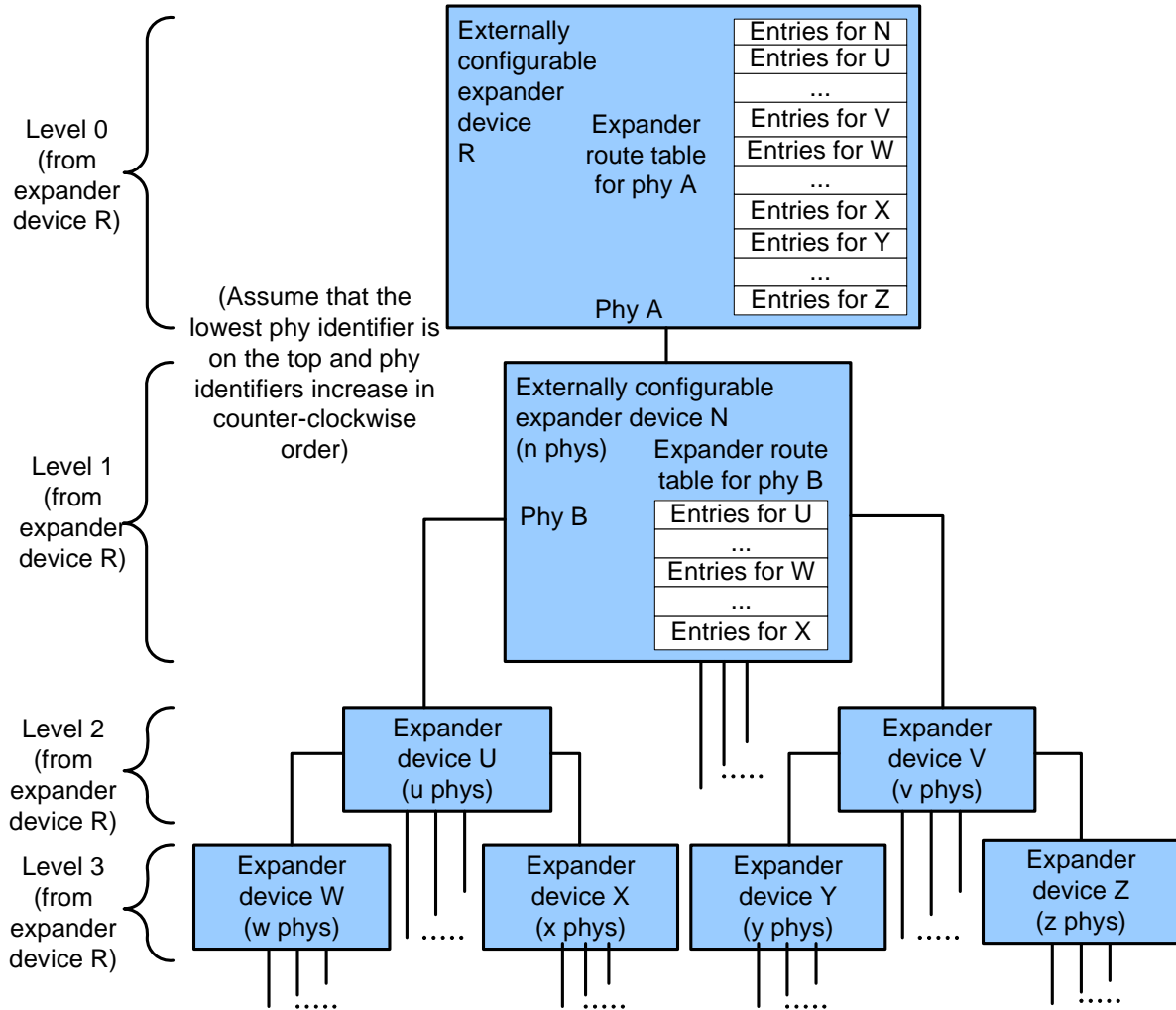

Figure 49 — Expander route index levels example

This page contains no comments

Table 22 shows how the expander route table is configured for externally configurable expander device R phy A in figure 49.

Table 22 — Expander route table levels for externally configurable expander device R phy A

Expander route index	Expander route entry contents
Level 1 (from device R) entries	
0 .. ($\leq n$ entries)	Qualified SAS addresses attached to expander device N
Level 2 (from device R) entries	
($\leq u$ entries)	Qualified SAS addresses attached to expander device U
...	...additional qualified SAS addresses for expander devices at level 2...
($\leq v$ entries)	Qualified SAS addresses attached to expander device V
Level 3 (from device R) entries	
($\leq w$ entries)	Qualified SAS addresses attached to expander device W
...	...additional qualified SAS addresses for expander devices at level 3...
($\leq x$ entries)	Qualified SAS addresses attached to expander device X
($\leq y$ entries)	Qualified SAS addresses attached to expander device Y
...	...additional qualified SAS addresses for expander devices at level 3...
($\leq z$ entries)	Qualified SAS addresses attached to expander device Z
Entries for additional levels	
...	...
Disabled entries	
...	...

Table 23 shows how the expander route table is configured for externally configurable expander device N phy B in figure 49.

Table 23 — Expander route table levels for externally configurable expander device N

Expander route index	Expander route entry contents
Level 1 (from device N) entries	
($\leq u$ entries)	Qualified SAS addresses attached to expander device U
Level 2 (from device N) entries	
($\leq w$ entries)	Qualified SAS addresses attached to expander device W
...	...additional qualified SAS addresses for expander devices at level 2...
($\leq x$ entries)	Qualified SAS addresses attached to expander device X
Entries for additional levels	
...	...
Disabled entries	
...	...

Author: elx-bmartin

Subject: Comment on Text

Date: 6/3/2008 7:52:54 PM

T REJECT (Figure 49 already states that)

Assumes that phys in the expanders are numbered counter clockwise from the left side.

Figure 50 shows an example topology.

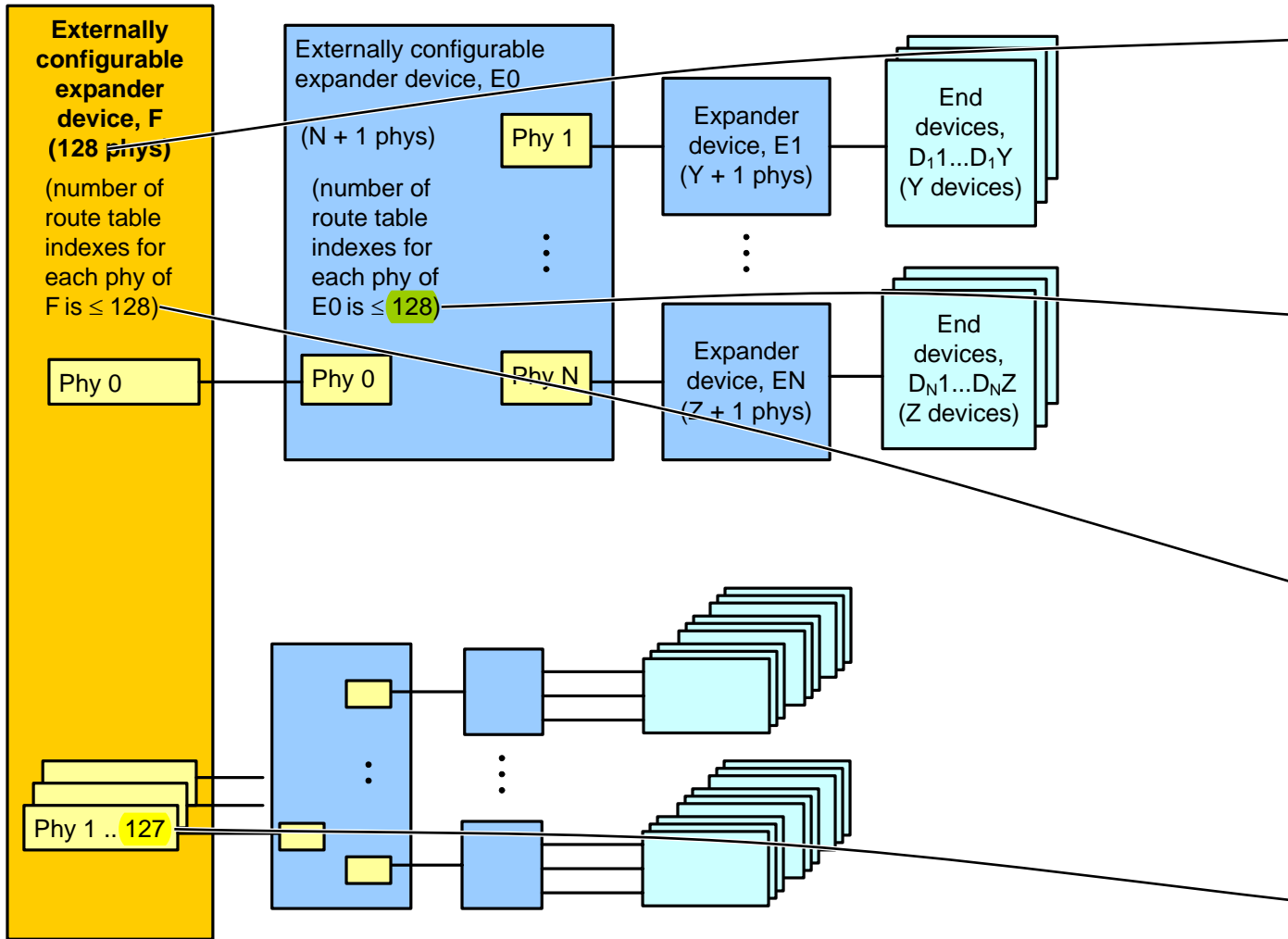

Figure 50 — Expander route index order example

Table 24 shows the expander route index order for externally configurable expander device E0 phy 1 in figure 50.

Table 24 — Expander route entries for externally configurable expander device E0 phy 1

Expander route index	Expander route entry contents
Level 1 entries	
0	SAS address (e.g., D ₁ 1) of the device attached to phy 1 of expander device E1
1	SAS address (e.g., D ₁ 2) of the device attached to phy 2 of expander device E1
...	...
Y - 1	SAS address (e.g., D ₁ Y) of the device attached to phy Y of expander device E1
Level 2 and beyond	
	No entries
Disabled entries	
	Any remaining entries are disabled

Page: 96

● Author: RElliott
Subject: Highlight
Date: 6/30/2008 6:16:52 PM

 ACCEPT - DONE

128

s/b

255

per lsi-bbesmer comment on figure 10

● Author: RElliott
Subject: Highlight
Date: 6/30/2008 6:16:52 PM

 ACCEPT - DONE (delete the whole sentence, which is not necessarily true and is not relied on by the example for anything)

128

s/b

255

per lsi-bbesmer comment on figure 10

● Author: RElliott
Subject: Highlight
Date: 6/30/2008 6:16:52 PM

 ACCEPT - DONE (delete the sentence altogether. It is probably leftover from early SAS-1 when fanout expanders had fixed routing tables 256 deep per phy)

128

s/b

255

per lsi-bbesmer comment on figure 10

● Author: RElliott
Subject: Highlight
Date: 6/30/2008 6:16:52 PM

 ACCEPT - DONE

127

s/b

254

per lsi-bbesmer comment on figure 10

● Author: RElliott
Subject: Note
Date: 6/30/2008 6:16:52 PM

 ACCEPT - DONE

Added " assuming that all phys are present and not subject to exclusion by route table optimization (see 4.8.3)" before the table.)

like in the next table.

Table 25 shows the expander route index order for externally configurable expander device F phy 0 in figure 50.

Table 25 — Expander route entries for externally configurable expander device F phy 0

Expander route index	Expander route entry contents
Level 1 entries	
0	SAS address (e.g., E1) of the device attached to phy 1 of expander device E0
...	...additional qualified SAS addresses for expander device E0...
N - 1	SAS address (e.g., EN) of the device attached to phy N of expander device E0
Level 2 entries	
N	SAS address (e.g., D ₁ 1) of the device attached to phy 1 of expander device E1
...	...additional qualified SAS addresses for expander device E1...
	SAS address (e.g., D ₁ Y) of the device attached to phy Y of expander device E1
...	...additional qualified SAS addresses for expander devices E2 through EN-1...
	SAS address (e.g., D _N 1) of the device attached to phy 1 of expander device EN
...	...additional qualified SAS addresses for expander device EN...
	SAS address (e.g., D _N Z) of the device attached to phy Z of expander device EN
Level 3 and beyond	
	No entries since all devices attached to E1 through EN, except for E0, are end devices
Disabled entries	
	Any remaining entries are disabled

4.9 Zoning

4.9.1 Zoning overview

SAS zoning is implemented by a set of zoning expander devices with zoning enabled that define a zoned portion of a service delivery subsystem (ZPSDS). The zoning expander devices control whether a phy is permitted to participate in a connection to another phy.

Author: Isi-bbesmer

Subject: Highlight

Date: 6/3/2008 7:56:30 PM

T ACCEPT - DONE (5/5: Add a table footnote that this example assumes that all phys are present and not subject to removal because of route table optimization.

6/3: Added " assuming that all phys are present and not subject to exclusion by route table optimization (see 4.8.3)" before the table.)

may not be true if route table optimization is enabled

Figure 51 shows an example of one ZPSDS in a SAS domain.

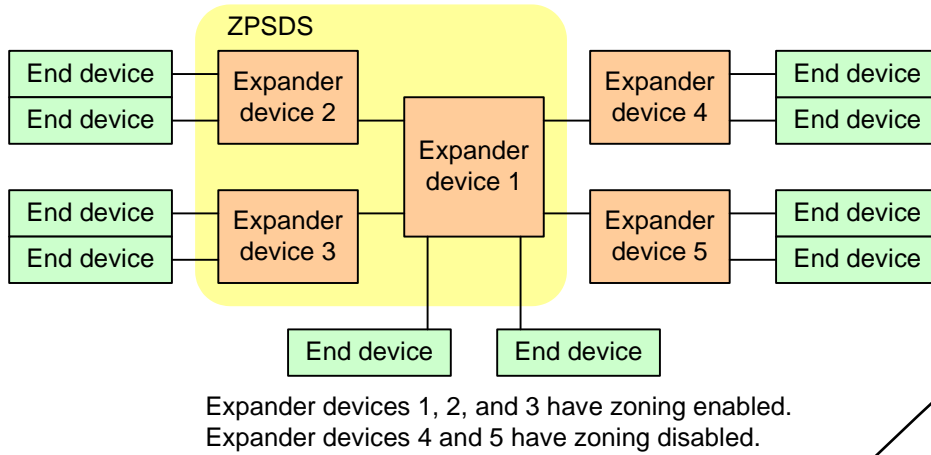

Figure 51 — One ZPSDS example

A ZPSDS has a zone manager responsible for its configuration. The zone manager may have access to an end device with a SAS port whose zone group has access to **zone group 2**, or may have access to one or more zoning expander devices through a sideband interface (e.g., Ethernet) outside the scope of this standard. The SAS address reported for a sideband zone manager is **zero**.

Author: hpq-curtisb

Subject: Comment on Text

Date: 5/25/2008 6:16:31 PM

T ACCEPT - DONE (added cross reference after the first "zone group" in the sentence)

First time that "zone group 2" is introduced. It needs a reference to 4.9.3.2

Author: RElliott

Subject: Highlight

Date: 6/30/2008 6:16:52 PM

T ACCEPT - DONE

zero

s/b

00000000_00000000h

(with a space not _ per other comments)

Figure 52 shows examples of zone manager locations in a SAS domain.

Zone manager attached to an end device with a SAS port whose zone group has access to zone group 2

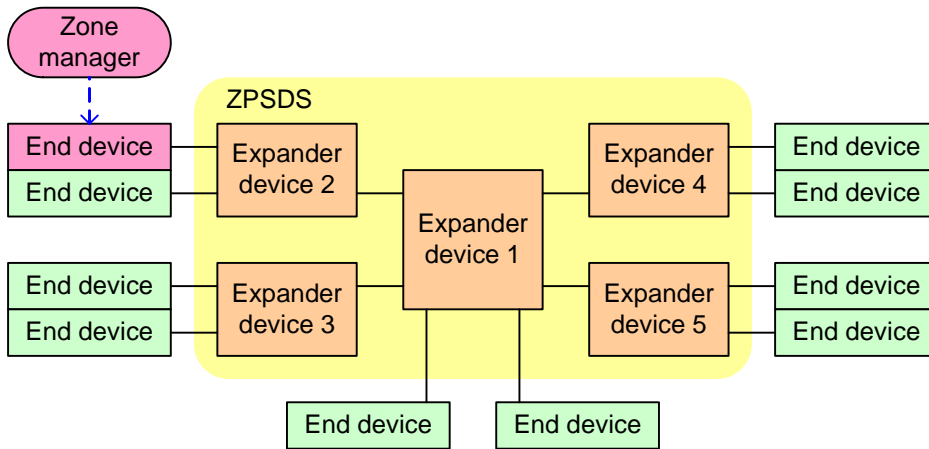

Zone manager attached directly to the expander devices in the ZPSDS

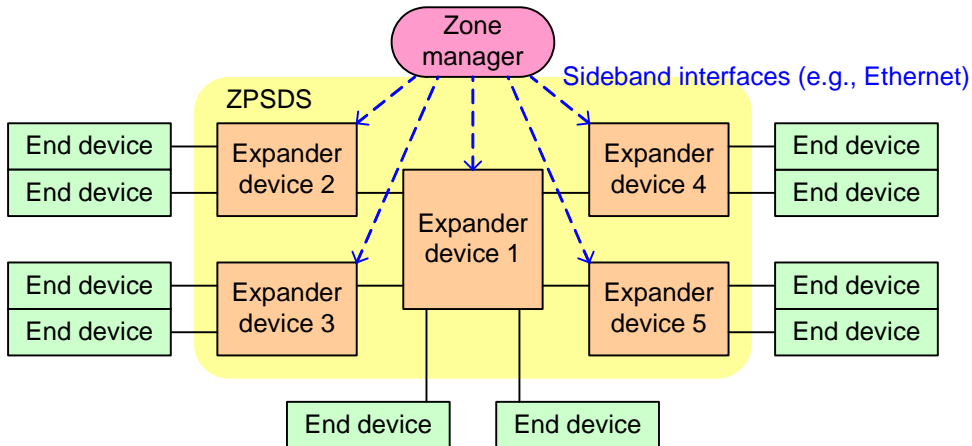

Zone manager attached directly to one expander device in the ZPSDS

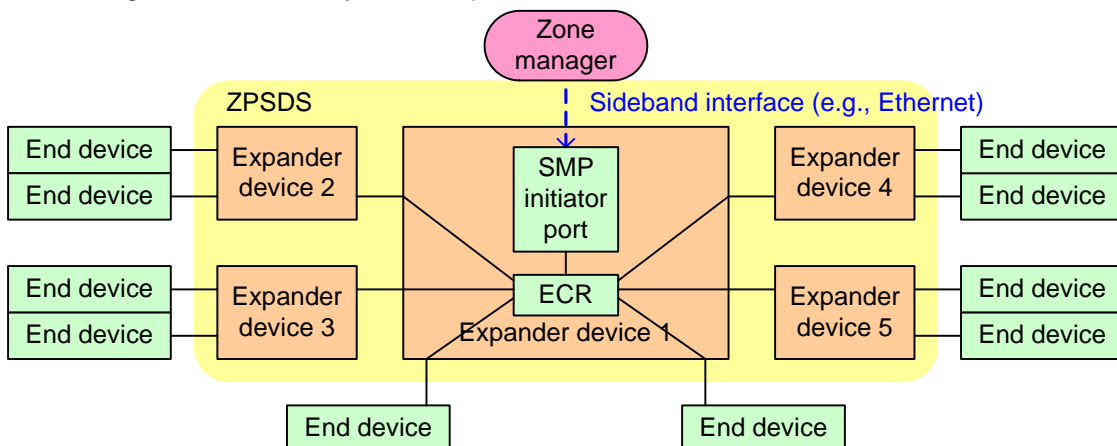

Figure 52 — Zone manager location examples

There may be any number of non-overlapping ZPSDSes in a service delivery subsystem, particularly as a SAS domain is being reconfigured (e.g., as a user is attaching enclosures together). A SAS domain with more than one ZPSDS should be transitory. A ZPSDS may encompass some or all of a service delivery subsystem.

● Author: ktek-dmoore

Subject: Highlight

Date: 5/25/2008 6:16:52 PM

T REJECT (5/5 there is no ZPSDS if zoning is not enabled... not sure it needs to be stated)

access to zone group 2

This implies that zoning must already be enabled, an there are zone permission tables already in use. Should this be noted?

Figure 53 shows an example of three ZPSDSes in a SAS domain.

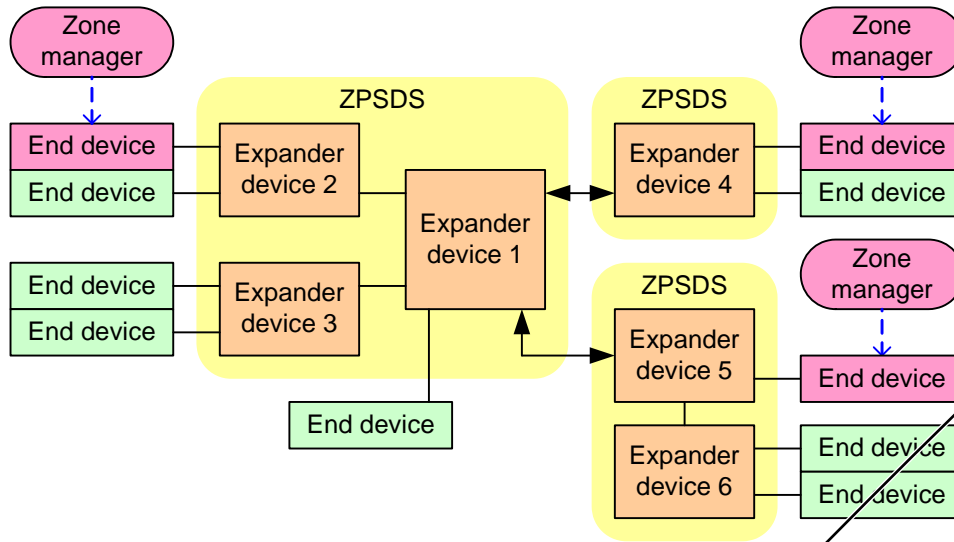

Figure 53 — Three ZPSDSes example

The zone manager assigns zone groups (see 4.9.3.2) to all zoning expander phys inside the ZPSDS. There are 128 or 256 zone groups numbered 0 through 127 or 255. All phys in a wide port shall be assigned to the same zone group. Zone groups are assigned to zoning expander phys as part of the zone phy information (see 4.9.3.1) and are stored along with SAS addresses in the zoning expander route table (see 4.9.3.4). The zone groups assigned in one ZPSDS have no relationship to the zone groups assigned in another ZPSDS.

The zone manager shall assign each zoning expander phy attached to another zoning expander phy inside a ZPSDS to zone group 1. The zone manager shall assign each zoning expander phy on the boundary of the ZPSDS (i.e., with the INSIDE ZPSDS bit set to zero) to a zone group. All phys in the SAS domain beyond that boundary zoning expander phy are considered to be in the same zone group as that zoning expander phy.

Each zoning expander device contains a zone permission table (see 4.9.3.3) that controls whether a connection is allowed between phys based on their zone groups. As defined in 4.9.3.5, a requested connection shall only be established if the zone permission table indicates that access between the zone group of the source port and the zone group of the target port is allowed.

The zoning expander route table (see 4.9.3.4) is an extended version of the expander route table (see 4.6.7.3) that also includes the zone group of each SAS address.

A zoning expander device may support physical presence detection and/or a zone manager password to allow management access. The zone manager password is 32 bytes long and is specified in table 26.

Table 26 — Zone manager password

Code	Name	Description
00000000 00000000 00000000 00000000 00000000 00000000 00000000 00000000h	ZERO	Well-known value that provides access to any zone manager that presents it
FFFFFFFF FFFFFFFF FFFFFFFF FFFFFFFF FFFFFFFF FFFFFFFF FFFFFFFF FFFFFFFFh	DISABLED	Well-known value that does not provide access to any zone manager (e.g., zone manager password usage is disabled)
All others		Random value, providing access only to a zone manager that presents the correct value

Page: 100

● Author: lsi-gpenokie
Subject: Highlight
Date: 5/6/2008 4:07:48 PM
 ACCEPT - DONE

This << numbered 0 through 127 or 255. All phys >> should be << numbered 0 through 127 or 0 through 255. All phys >>

● Author: ktek-dmoore
Subject: Highlight
Date: 5/6/2008 4:07:48 PM
 ACCEPT - DONE
target port
s/b "destination port"

● Author: RElliott
Subject: Underline
Date: 6/30/2008 6:16:52 PM
 ACCEPT - DONE

A zoning expander device may support physical presence detection and/or a zone manager password to allow management access.

s/b

Physical presence detection is a mechanism used to allow management access. The definition of physical presence detection is vendor-specific (e.g., a user physically pressing a button or inserting a key).

The zone manager password is a value used to allow management access.

Reason: In 4.9.2, the "may" rule will appear. This section just defines what they mean.

● Author: RElliott
Subject: Highlight
Date: 6/30/2008 6:16:52 PM

 ACCEPT - DONE (5/5 group prefers a), don't implement the functions if password is not supported. Added "if supported" throughout the standard wherever needed. Deleted lines making the functions mandatory for all zoning expander devices.)

Should zone manager password be

a) totally optional (SMP functions related to it are optional)

b) mandatory, but expander is allowed to implement only the DISABLED value (SMP functions fail if another value is programmed)

c) mandatory

● Author: RElliott
Subject: Note
Date: 6/30/2008 6:16:52 PM

 ACCEPT - DONE

Add:

The definition of physical presence detection is vendor-specific.

from 4.9.2, since this is the first use of the term.

● Author: lsi-gpenokie
Subject: Highlight
Date: 5/25/2008 6:17:21 PM

 ACCEPT - DONE

There should be << . >> at the end of the sentences in this table. That would add 3 periods.

The expander device:

- a) shall maintain a current value;
- b) shall maintain a shadow value;
- c) may maintain a saved value; and
- d) shall have a default value.

for each the following settings:

- a) zoning enabled;
- b) the zone permission table;
- c) zone phy information; and/or
- d) the zone manager password.

Support or lack of support for saved values for one setting does not imply support or lack of support for saved values for any other setting (e.g., the expander device may maintain a saved value for zoning enabled but not for the zone permission table).

For each setting, after power on or expander reduced functionality, the expander device shall set the current value to the saved value, if any, or the default value, if there is no saved value.

Table 27 describes the reasons for which a zoning expander device accepts the SMP ZONE LOCK function after power on.

Table 27 — Zoning expander device zoning configuration after power on

Value after power on			Reason(s) that the SMP ZONE LOCK function is accepted			
Zoning enabled	Zone permission table saved	Zone manager password	Physical presence asserted	SMP initiator port has access to zone group 2	ZONE MANAGER PASSWORD field in the ZONE LOCK request set to the zone manager password	
no	yes or no	ZERO	yes	no	yes	
		DISABLED			no	
		All others			yes	
yes	no	ZERO		yes	no	yes
		DISABLED		no	no	
		All others		yes	yes	
	yes	ZERO		yes	yes	yes
		DISABLED		yes	no	no
		All others		yes	yes	yes

4.9.2 Zoning expander device requirements

In addition to the requirements for expander devices described in 4.6, a zoning expander device shall:

- a) contain a zoning expander route table (see 4.9.3.4);
- b) contain current and shadow zone permission tables that supports 128 or 256 zone groups (see 4.9.3.3);
- c) contain current and shadow zone phy information for each phy;
- d) if zoning is enabled, allow or deny connection requests based on the active zone permission table (see 4.9.3.5);
- e) set the ZONING SUPPORTED bit to one in its SMP REPORT GENERAL response (see 10.4.3.4);
- f) support the ZONING ENABLED bit in the SMP REPORT GENERAL response;
- g) support the zone lock inactivity timer;
- h) be self-configuring;

Page: 101

● Author: RElliott
Subject: Highlight
Date: 6/30/2008 6:16:52 PM

 ACCEPT - DONE
each
s/b
each of

● Author: elx-bmartin
Subject: Comment on Text
Date: 5/25/2008 6:17:40 PM

 ACCEPT - DONE (but this triggers a question about how mandatory/optional is the zone manager password; new comment added)

this should just be and

● Author: lsi-bbesmer
Subject: Highlight
Date: 5/25/2008 6:43:38 PM

 ACCEPT - DONE (but this triggers a question about how mandatory/optional is the zone manager password; new comment added)

and/or
s/b
and

I don't see the reason for the "or" case here, as all 4 settings need to be maintained.

● Author: RElliott
Subject: Note
Date: 9/2/2008 7:10:21 PM

 ACCEPT - DONE

There is no shadow zone manager password, so move it into its own list, just offering current, saved, and default values.

● Author: RElliott
Subject: Highlight
Date: 6/30/2008 6:16:52 PM

 ACCEPT - DONE

expander reduced functionality
s/b
expander device reduced functionality

● Author: lsi-gpenokie
Subject: Highlight
Date: 5/17/2008 5:00:07 PM

 REJECT (Deleting the table per other comments. The answer would have been: "reason(s)" is used in the table header, so that word fits well in the description. There are 3 columns in the table, where "yes" means go ahead and "no" means nothing.)

This << describes the reasons for which a zoning expander device accepts the SMP >> should be << describes when a zoning expander device accepts the SMP >>

● Author: lsi-bbesmer
Subject: Highlight
Date: 5/17/2008 5:01:13 PM

 ACCEPT - DONE (Deleting the table. The rules are fully described in the ZONE LOCK description. 5/5 WG considered adding "The zone values that are saved impacts the acceptance of the ZONE LOCK function (see 10.x.x.x) after power on as shown in table 27" to explain better why this is here. George thinks more rows might be worthwhile if it helps.)

This table does not seem to belong in the "zoning overview" section.

● Author: elx-bmartin

Comments from page 101 continued on next page

The expander device:

- a) shall maintain a current value;
- b) shall maintain a shadow value;
- c) may maintain a saved value; and
- d) shall have a default value,

for each the following settings:

- a) zoning enabled;
- b) the zone permission table;
- c) zone phy information; and/or
- d) the zone manager password.



Support or lack of support for saved values for one setting does not imply support or lack of support for saved values for any other setting (e.g., the expander device may maintain a saved value for zoning enabled but not for the zone permission table).

For each setting, after power on or expander reduced functionality, the expander device shall set the current value to the saved value, if any, or the default value, if there is no saved value.

Table 27 describes the reasons for which a zoning expander device accepts the SMP ZONE LOCK function after power on.

Table 27 — Zoning expander device zoning configuration after power on

Value after power on			Reason(s) that the SMP ZONE LOCK function is accepted			
Zoning enabled	Zone permission table saved	Zone manager password	Physical presence asserted	SMP initiator port has access to zone group 2	ZONE MANAGER PASSWORD field in the ZONE LOCK request set to the zone manager password	
no	yes or no	ZERO	yes	no	yes	
		DISABLED			no	
		All others			yes	
yes	no	ZERO		yes	no	yes
		DISABLED		no	no	
		All others		yes	yes	
	yes	ZERO		yes	yes	yes
		DISABLED		yes	no	
		All others		yes	yes	

4.9.2 Zoning expander device requirements

In addition to the requirements for expander devices described in 4.6, a zoning expander device shall:

- a) contain a zoning expander route table (see 4.9.3.4);
- b) contain current and shadow zone permission tables that supports 128 or 256 zone groups (see 4.9.3.3);
- c) contain current and shadow zone phy information for each phy;
- d) if zoning is enabled, allow or deny connection requests based on the active zone permission table (see 4.9.3.5);
- e) set the ZONING SUPPORTED bit to one in its SMP REPORT GENERAL response (see 10.4.3.4);
- f) support the ZONING ENABLED bit in the SMP REPORT GENERAL response;
- g) support the zone lock inactivity timer;
- h) be self-configuring;

Subject: Comment on Text
Date: 5/17/2008 5:01:52 PM

T REJECT (Deleting the table per other comments. There are actually 3 columns of results in this table, not 1. If the SMP initiator port has access to zone group 2, then that means zoning enabled + zone permission table saved is enough to get a "yes". "no"s mean nothing.)

This table could collapse to three rows since the only dependency is that the zone manager password must match and the value of the zone manager password,

● Author: lsi-gpenokie
Subject: Rectangle
Date: 5/17/2008 5:02:06 PM

T REJECT (Deleting the table per other comments. In this table, the lookup values are centered, the values retrieved are left-justified. If we used a vertical double-line to separate them, the formatting hint would not be needed. But, we don't.)

Center all the << yes >> and << no >> in these 3 columns and center the cell headings.

● Author: elx-bmartin
Subject: Comment on Text
Date: 5/17/2008 5:02:34 PM

T REJECT (Deleting the table per other comments. This table is apparently confusing. Yes means yes, No means "not for this reason, but maybe for some other reason" - not quite the same as "not applicable".)

shouldn't this be N/A since with zoning not enabled you cannot determine that a device has access to a specific zone group?

● Author: lsi-bbesmer
Subject: Highlight
Date: 5/16/2008 10:58:41 AM

T ACCEPT - DONE

active
s/b
current?

the term "active zone permission" only occurs twice in the doc, here and in the glossary.

(unless global comment to change current to active is accepted)

● Author: lsi-bbesmer
Subject: Highlight
Date: 6/4/2008 10:13:03 AM

T ACCEPT - DONE (5/5 changed item e) and f) to "support fields related to zoning in the REPORT GENERAL response" to cover everything. Did not get rid of the "shall" before the list and just state a list of is/does words. It is distinguishing between some shall and may rules, so probably not a good idea.)

support for several other Report General fields are also required:
NUMBER OF ZONE GROUPS
ZONE LOCKED

- i) contain an SMP initiator port (see 4.6.1); and
- j) support zoning-related SMP functions.

A zoning expander device may include physical presence detection to allow locking (see 4.9.6.2). The definition of physical presence detection is vendor-specific.

Figure 54 shows an example of two enclosures with physical presence detection where zoning is enabled in the expander device in the left enclosure, but is not enabled in the expander devices in the right enclosure. The zone manager is able to configure zoning in zoning expander device A because the zone group of its SMP initiator port has access to zone group 2. However, it is not able to enable or configure zoning in expander device B unless physical presence is asserted or it presents the correct zone manager password for that expander device.

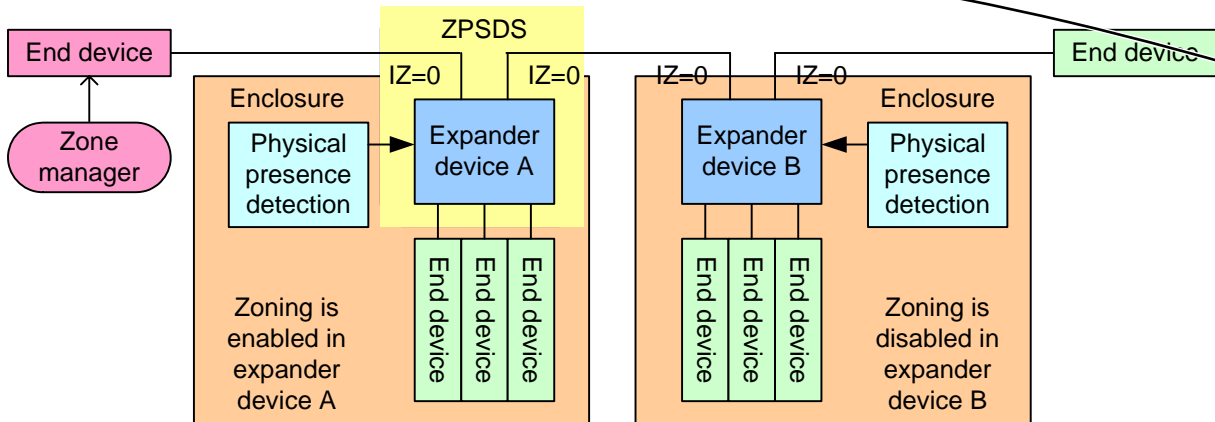

- The ZPSDS is extended as shown below after the zone manager on the left:
- 1) uses the ZONE LOCK function to lock expander devices A and B with physical presence asserted in expander B or providing the correct zone manager password;
 - 2) uses the CONFIGURE ZONE PHY INFORMATION function and the CONFIGURE ZONE PERMISSION TABLE function to configure each expander device, including setting the INSIDE ZPSDS bit to one in each expander phy that is going to be inside the ZPSDS;
 - 3) uses the ENABLE DISABLE ZONING function to enable zoning in expander device B;
 - 4) uses the ZONE ACTIVATE function to activate the changes; and
 - 5) uses the ZONE UNLOCK function to unlock expander devices A and B.

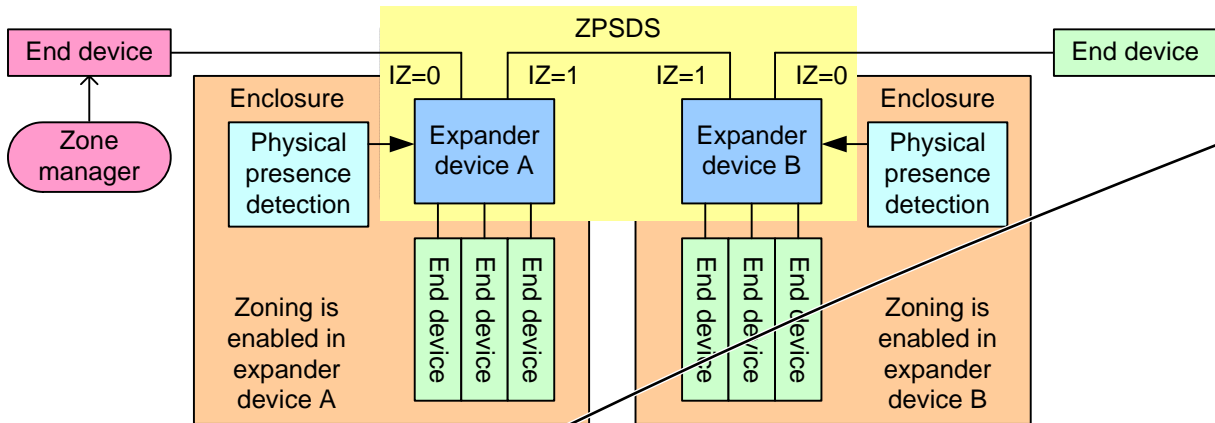

IZ = INSIDE ZPSDS bit in the zone phy information

Figure 54 — Extending a ZPSDS example

Figure 55 shows an example of two enclosures with physical presence detection where zoning is enabled in both the expander devices. The zone manager is able to configure zoning in zoning expander device A because the zone group of its SMP initiator port has access to zone group 2. However, it is not able to

Author: RElliott
Subject: Underline
Date: 6/30/2008 6:16:52 PM
ACCEPT - DONE

A zoning expander device may include physical presence detection to allow locking (see 4.9.6.2). The definition of physical presence detection is vendor-specific.

s/b

A zoning expander device may support physical presence detection and/or a zone manager password to allow management access.

to match changes in 4.9.1

Author: wdc-mevans
Subject: Highlight
Date: 6/4/2008 10:21:59 AM

ACCEPT - DONE (this is not the first occurrence - it was discussed in 4.9.1 and is used several times ahead of this in 4.9.2, including "The definition of physical presence detection is vendor-specific." However, will rewrite 4.9.1 and 4.9.2 to more clearly define it - see other comments)

Global

physical presence is asserted

[This is the first occurrence of this phrase, and it is used many times, particularly in clause 10. However, there is no definition for this phrase, and it is not possible to determine its meaning from the context. It is recommended that this phrase be defined in the definitions clause or replaced throughout the draft.]

Author: Isi-bbesmer
Subject: Highlight
Date: 5/17/2008 5:10:43 PM

ACCEPT - DONE (5/5 cannot cross reference from inside a Visio figure. Maybe delete the words though. 5/5 Break into two diagrams so the reference can be inserted.)

Could this not simply be replaced with:

The ZPSDS is extended as shown below after the zone manager completes zone configuration (see 4.9.6).

Author: Isi-bbesmer
Subject: Highlight
Date: 5/25/2008 6:19:22 PM
ACCEPT - DONE (both expander)

both the expander

s/b

both of the expander

or

both expander

Author: wdc-mevans
Subject: Highlight
Date: 5/25/2008 6:19:33 PM
REJECT

it

s/b

the zone manager

configure zoning in expander device B unless physical presence is asserted or it presents the correct zone manager password for that expander device.

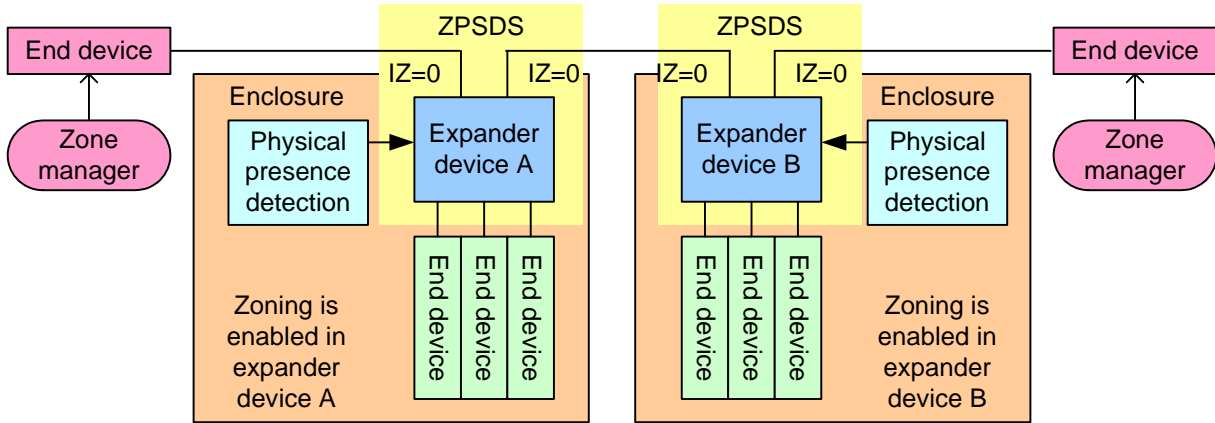

The ZPSDS is extended as shown below after the zone manager on the left:

- 1) uses the ZONE LOCK function to lock expander devices A and B with physical presence asserted in expander B, since it may not have access to zone group 2 in the right ZPSDS;
- 2) uses the CONFIGURE ZONE PHY INFORMATION function and the CONFIGURE ZONE PERMISSION TABLE function to configure each expander device, including setting the INSIDE ZPSDS bit to one in each expander phy that is going to be inside the ZPSDS;
- 3) uses the ENABLE DISABLE ZONING function to enable zoning in expander device B;
- 4) uses the ZONE ACTIVATE function to activate the changes; and
- 5) uses the ZONE UNLOCK function to unlock expander devices A and B.

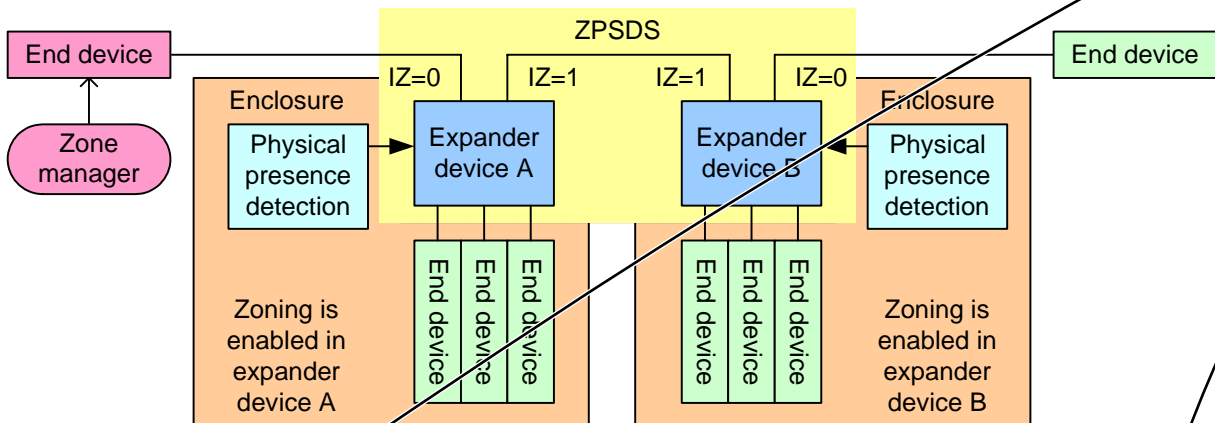

IZ = INSIDE ZPSDS bit in the zone phy information

Figure 55 — Overtaking a ZPSDS example

4.9.3 Zoning operation

4.9.3.1 Zone phy information

Each phy of a zoning expander device shall support the following zone phy information fields:

- a) ~~INSIDE ZPSDS bit;~~
- b) ~~REQUESTED INSIDE ZPSDS bit;~~
- c) ~~INSIDE ZPSDS PERSISTENT bit;~~
- d) ~~ZONE GROUP PERSISTENT bit; and~~
- e) ~~ZONE GROUP field.~~

Page: 103

● Author: wdc-mevans
Subject: Highlight
Date: 5/25/2008 6:19:43 PM
 REJECT

or it
s/b
, or the zone manager

● Author: lsi-bbesmer
Subject: Highlight
Date: 5/17/2008 5:10:18 PM

 ACCEPT - DONE (5/5 cannot cross reference, but WG is okay with deleting text like this. Make sure the basic rules cover everything.)

Could this not simply be replaced with:

The ZPSDS is extended as shown below after the zone manager completes zone configuration (see 4.9.6).

● Author: lsi-bbesmer
Subject: Note
Date: 5/6/2008 4:07:48 PM

 ACCEPT - DONE
This seems to be duplicate of below paragraph.

● Author: elx-bmartin
Subject: Cross-Out
Date: 5/6/2008 4:07:48 PM

 ACCEPT - DONE
This is duplicated in table 28 with additional information in the table, so remove this.

Each phy of a zoning expander device shall support the zone phy information fields defined in table 28.

Table 28 — Zone phy information

Field	Description	Recommended default
INSIDE ZPSDS bit	Indicates if the phy is inside or on the boundary of a ZPSDS	N/A ^a
REQUESTED INSIDE ZPSDS bit	Used to establish the boundary of the ZPSDS	0
INSIDE ZPSDS PERSISTENT bit	Used to determine the value of the INSIDE ZPSDS bit after a link reset sequence	0
ZONE GROUP PERSISTENT bit	Used to determine the zone group of the phy after a link reset sequence when the INSIDE ZPSDS bit is set to zero	0
ZONE GROUP field	The zone group to which the phy belongs	00h

^a The INSIDE ZPSDS bit is determined from the values exchanged during the link reset sequence.

Table 29 lists the usage of the **current** values of the zone phy information fields.

Table 29 — Zone phy information usage

Field	Transmitted in IDENTIFY address frame ^a	Indicated in DISCOVER function and DISCOVER LIST function ^b	Attached value indicated in DISCOVER function ^c	Programmable with the CONFIGURE ZONE PHY INFORMATION function ^d	Changeable by the expander device after a link reset sequence ^e
INSIDE ZPSDS bit	No	Yes	No	No	Yes
REQUESTED INSIDE ZPSDS bit	Yes	Yes	Yes	Yes	Yes
INSIDE ZPSDS PERSISTENT bit	Yes	Yes	Yes	Yes	No
ZONE GROUP PERSISTENT bit	No	Yes	No	Yes	No
ZONE GROUP field	No	Yes	No	Yes	Yes

^a Defined in the IDENTIFY address frame (see 7.8.2).
^b Defined in the DISCOVER response (see 10.4.3.10) and the DISCOVER LIST response SHORT FORMAT descriptor (see 10.4.3.15.4).
^c Defined in the DISCOVER response (see 10.4.3.10).
^d **Defined** in the zone phy configuration descriptor (see 10.4.3.25.3). The saved values are also programmable with this function.
^e **See table 33** in 4.9.4.

All phys in an expander port shall have the same zone phy information.

The expander device shall preserve the zone phy information **while zoning is disabled and there is no power loss and no expander device reduced functionality** (see 4.6.8).

The INSIDE ZPSDS bit indicates if the phy is inside or on the boundary of a ZPSDS. An INSIDE ZPSDS bit set to zero indicates **that the phy is attached to an end device, an expander device that does not support zoning, or a zoning expander device with zoning disabled, or a zoning expander device with zoning enabled that is outside the ZPSDS (i.e., is in another ZPSDS)**. An INSIDE ZPSDS bit set to one indicates that the phy is

Page: 104

Author: RElliott
Subject: Highlight
Date: 6/30/2008 6:16:52 PM
ACCEPT - DONE

when
s/b
if

Author: Isi-bbesmer
Subject: Highlight
Date: 5/17/2008 5:12:26 PM

REJECT ("current" zone phy information is defined in 4.9.1 - it means current as opposed to shadow/saved/default. This si the same terminology used in SCSI mode pages.)

current

what is the meaning of the word current in this context?

- 1) values defined "currently" in this standard?
 - 2) current zone phy information (as opposed to saved/default)
 - 3) something else
-

Author: Isi-gpenokie
Subject: Rectangle
Date: 5/25/2008 6:20:22 PM

REJECT (this table has fat column headers; making them any wider makes the column headers longer, shifting this perceived problem to other columns, or makes the field names wrap uncomfortably.)

A slight adjustment to the column width or the left/right cell margins would put the footnote reference on the same line as the text. This should be done.

Author: RElliott
Subject: Highlight
Date: 9/3/2008 6:46:35 PM
ACCEPT - DONE

Yes

Add footnote:
Only changes to 00h after a link reset sequence. See 4.9.4.

Per discussion with Tim Symons (PMC-Sierra). Causes confusion in thinking that zone group updates don't take effect until link reset; that is only true for the INSIDE ZPSDS bits.

Author: RElliott
Subject: Highlight
Date: 9/3/2008 6:44:10 PM
ACCEPT - DONE

d

Add comment that zone activation is needed to make the change take effect.

The CONFIGURE ZONE PHY INFORMATION function updates shadow values; the activate step (see 4.9.6.4) copies them into current and saved values.

Author: RElliott
Subject: Highlight

Comments from page 104 continued on next page

Each phy of a zoning expander device shall support the zone phy information fields defined in table 28.

Table 28 — Zone phy information

Field	Description	Recommended default
INSIDE ZPSDS bit	Indicates if the phy is inside or on the boundary of a ZPSDS	N/A ^a
REQUESTED INSIDE ZPSDS bit	Used to establish the boundary of the ZPSDS	0
INSIDE ZPSDS PERSISTENT bit	Used to determine the value of the INSIDE ZPSDS bit after a link reset sequence	0
ZONE GROUP PERSISTENT bit	Used to determine the zone group of the phy after a link reset sequence when the INSIDE ZPSDS bit is set to zero	0
ZONE GROUP field	The zone group to which the phy belongs	00h

^a The INSIDE ZPSDS bit is determined from the values exchanged during the link reset sequence.

Table 29 lists the usage of the **current** values of the zone phy information fields.

Table 29 — Zone phy information usage

Field	Transmitted in IDENTIFY address frame ^a	Indicated in DISCOVER function and DISCOVER LIST function ^b	Attached value indicated in DISCOVER function ^c	Programmable with the CONFIGURE ZONE PHY INFORMATION function ^d	Changeable by the expander device after a link reset sequence ^e
INSIDE ZPSDS bit	No	Yes	No	No	Yes
REQUESTED INSIDE ZPSDS bit	Yes	Yes	Yes	Yes	Yes
INSIDE ZPSDS PERSISTENT bit	Yes	Yes	Yes	Yes	No
ZONE GROUP PERSISTENT bit	No	Yes	No	Yes	No
ZONE GROUP field	No	Yes	No	Yes	Yes

^a Defined in the IDENTIFY address frame (see 7.8.2).
^b Defined in the DISCOVER response (see 10.4.3.10) and the DISCOVER LIST response SHORT FORMAT descriptor (see 10.4.3.15.4).
^c Defined in the DISCOVER response (see 10.4.3.10).
^d **Defined** in the zone phy configuration descriptor (see 10.4.3.25.3). The saved values are also programmable with this function.
^e **See table 33** in 4.9.4.

All phys in an expander port shall have the same zone phy information.

The expander device shall preserve the zone phy information **while zoning is disabled and there is no power loss and no expander device reduced functionality** (see 4.6.8).

The INSIDE ZPSDS bit indicates if the phy is inside or on the boundary of a ZPSDS. An INSIDE ZPSDS bit set to zero indicates **that the phy is attached to an end device, an expander device that does not support zoning, or a zoning expander device with zoning disabled, or a zoning expander device with zoning enabled that is outside the ZPSDS (i.e., is in another ZPSDS)**. An INSIDE ZPSDS bit set to one indicates that the phy is

Date: 9/3/2008 6:42:19 PM

T ACCEPT - DONE

See table 33

s/b

See table 34

but better yet, just delete the table reference since the table only covers the INSIDE ZPSDS bits, not the ZONE GROUP field

Author: wdc-mevans

Subject: Highlight

Date: 5/25/2008 6:20:40 PM

T ACCEPT - DONE (as "The expander device shall preserve the zone phy information while:

- a) zoning is disabled;
 - b) no power loss occurs; and
 - c) there is no expander device reduced functionality (see 4.6.8).
- ")

while zoning is disabled and there is no power loss and no expander device reduced functionality (see 4.6.8).

s/b

while:

- a) zoning is disabled;
- b) no power loss occurs; and
- c) there is no reduction in expander device functionality (see 4.6.8).

Author: wdc-mevans

Subject: Highlight

Date: 5/17/2008 5:24:43 PM

T ACCEPT - DONE (This is the definition of zone phy information bits, not the definition of fields in DISCOVER, so they only exist in a zoning expander device. So, the proposed a) of an "expander device does not support zoning" are unnecessary. The wording "supports zoning, but" is unnecessary in b). Added sentences about setting each bit/field to zero in the DISCOVER response outside of zoning expander devices.

5/5 this seems complete as edited. Check that other bits/fields are defined as zero if the expander device does not support zoning.)

that the phy is attached to an end device, an expander device that does not support zoning, or a zoning expander device with zoning disabled, or a zoning expander device with zoning enabled that is outside the ZPSDS (i.e., is in another ZPSDS).

s/b

that:

- a) the expander device does not support zoning;
 - b) the expander device supports zoning, but zoning is disabled;
 - c) the phy is attached to an end device;
 - d) the phy is attached to an expander device that does not support zoning;
 - e) the phy is attached to an expander device that supports zoning, but zoning is disabled; or
 - f) the phy is attached to an expander device that supports zoning, zoning is enabled, but is outside the ZPSDS (i.e., is in another ZPSDS).
-

attached to a zoning expander device with zoning enabled and is ~~thus inside a ZPSDS~~. The INSIDE ZPSDS bit only changes following a link reset sequence (see 4.9.4), based on:

- a) the REQUESTED INSIDE ZPSDS bit;
- b) the REQUESTED INSIDE ZPSDS bit received in the incoming IDENTIFY address frame (see 7.6.2);
- c) the INSIDE ZPSDS PERSISTENT bit; and
- d) the INSIDE ZPSDS PERSISTENT bit received in the incoming IDENTIFY address frame.

The REQUESTED INSIDE ZPSDS bit is used to establish the boundary of the ZPSDS. The REQUESTED INSIDE ZPSDS bit is used to determine the values of other zone phy information fields after a link reset sequence (see 4.9.4).

The INSIDE ZPSDS PERSISTENT bit is used to determine the value of the INSIDE ZPSDS bit after a link reset sequence (see 4.9.4).

The ZONE GROUP field contains the zone group to which the phy belongs. The zone group of the SMP initiator port and SMP target port in a zoning expander device shall be 01h. 4.9.3.2 defines more about zone groups.

The ZONE GROUP PERSISTENT bit is used to determine the method of determining the zone group of the phy after a link reset sequence **when** ~~the INSIDE ZPSDS bit is set to zero~~ (see 4.9.4).

Page: 105

● Author: Isi-bday
Subject: Cross-Out
Date: 5/25/2008 6:44:14 PM
 REJECT (see response to wdc-mevans comment)

thus

● Author: wdc-mevans
Subject: Cross-Out
Date: 5/17/2008 5:15:16 PM
 REJECT (without thus or therefore, it seems like these are two conditions being ANDed together. That is not the case; this and is just stating the result of the first and only condition being met. An i.e. could work, but that loses the hint that one condition causes the other)

thus
s/b
[Delete the unnecessary word.]

● Author: RElliott
Subject: Highlight
Date: 6/30/2008 6:16:52 PM
 ACCEPT - DONE

when
s/b
if

4.9.3.2 Zone groups

The zone groups are defined in table 30.

Table 30 — Zone groups

Zone group	Configurable in zone permission table ^a	Description
0	No	Phys in zone group 0 have access to phys in zone group 1 and do not have access to phys in other zone groups.
1	No	Phys in zone group 1 have access to phys in all zone groups.
2	Yes	<p>Phys in zone group 2 have access to phys in the zone groups indicated by the zone permission table.</p> <p>A management device server in a zoning expander device with zoning enabled only allows management application clients using phys in zone groups with access to zone group 2 to perform the following SMP functions:</p> <p>a) CONFIGURE GENERAL (see 10.4.3.18); and</p> <p>b) ZONE LOCK (see 10.4.3.21) and SMP zone configuration functions (see 4.9.6.1) performed while the zoning expander device is locked.</p> <p>A management device server in a zoning expander device with zoning enabled only allows management application clients to perform certain SMP phy-based control and configuration functions (e.g., PHY CONTROL, PHY TEST FUNCTION, and CONFIGURE PHY EVENT) if the zone group of the management application client's phy has access to zone group 2 or the zone group of the specified phy.</p>
3	Yes	<p>Phys in zone group 3 have access to phys in the zone groups indicated by the zone permission table.</p> <p>A management device server in a zoning expander device with zoning enabled only allows management application clients using a phy in a zone group with access to zone group 3 to perform certain SMP zoning-related functions (i.e., ZONED BROADCAST (see 10.4.3.20)).</p>
4 to 7	Reserved	
8 to 255	Yes	Phys in zone groups 8 through 255 have access to phys in the zone groups indicated by the zone permission table.
^a A zone group defined as configurable is able to be changed with the SMP CONFIGURE ZONE PERMISSION TABLE function (see 10.4.3.26).		

4.9.3.3 Zone permission table

The zone permission table specifies access permission between zone groups. If a bit in the zone permission table is set to one then connection requests shall be permitted between phys in the zone groups. If a bit in the zone permission table is set to zero then connection requests between phys in the zone groups shall be rejected with OPEN_REJECT (ZONE VIOLATION) or OPEN_REJECT (RETRY) as described in 4.9.3.5.

● Author: RElliott
Subject: Highlight
Date: 6/30/2008 6:16:52 PM
T ACCEPT - DONE

in zone
s/b
in the zone

● Author: elx-bmartin
Subject: Comment on Text
Date: 5/17/2008 5:25:42 PM
T ACCEPT - DONE (5/5 accept:
b) ZONE LOCK; and
c) SMP)

make this item c, and delete the and at the end of item a)

● Author: wdc-mevans
Subject: Highlight
Date: 5/25/2008 6:21:22 PM
T REJECT (connections are 1:1, we don't allow party line connections)

between
s/b
among
[The rule is: use "between" for two items or more than two specified items (i.e., "between phy a, phy b, and phy c"), otherwise, for more than two unspecified items, "among" is used.]

● Author: wdc-mevans
Subject: Highlight
Date: 5/25/2008 6:21:42 PM
T REJECT (connections are 1:1)

between
s/b
among

● Author: RElliott
Subject: Highlight
Date: 6/30/2008 6:16:52 PM
T ACCEPT - DONE

then
s/b
, then

● Author: wdc-mevans
Subject: Highlight
Date: 5/25/2008 6:21:36 PM
T REJECT (connections are 1:1)

between
s/b
among

The zone permission table structure is shown in table 31.

Table 31 — Zone permission table

Destination zone group (i.e., d)	Source zone group (i.e., s) ^{a b}				
	0	1	2 to 3	4 to 7	8 to (z-1) ^c
0	0	1	0	0	0
1	1	1	1	1	1
2 to 3	0	1	ZP[s = 2 to 3, d = 2 to 3]	Reserved	ZP[s = 8 to (z-1), d = 2 to 3]
4 to 7	0	1	Reserved	Reserved	Reserved
8 to (z-1) ^c	0	1	ZP[s = 2 to 3, d = 8 to (z-1)]	Reserved	ZP[s = 8 to (z-1), d = 8 to (z-1)]

^a Shading identifies configurable zone groups.
^b All reserved ZP bits shall be set to zero (e.g., bits ZP[4 to 7, 4 to (z-1)] are set to zero).
^c The number of zone groups (i.e., z) is reported in NUMBER OF ZONE GROUPS field in the REPORT GENERAL response (see 10.4.3.4).

A ZP[s, d] bit set to one specifies that the source zone group (i.e., s) has permission to access the destination zone group (i.e., d). A ZP[s, d] bit set to zero specifies that the source zone group (i.e., s) does not have permission to access the destination zone group (i.e., d).

If ZP[s, d] is set to a value, ZP[d,s] shall be set to the same value.

The zoning expander device shall preserve the zone permission table while zoning is disabled and may or may not preserve the zone permission table through power loss. If the zoning expander device preserves that zoning is enabled and does not preserve the zone permission table, it shall set the zone permission table to grant minimal permissions on power on as specified in table 32.

Table 32 — Zone permission table granting minimal permissions

Destination zone group (i.e., d)	Source zone group (i.e., s) ^{a b}				
	0	1	2 to 3	4 to 7	8 to (z-1) ^c
0	0	1	0	0	0
1	1	1	1	1	1
2 to 3	0	1	0	Reserved	0
4 to 7	0	1	Reserved	Reserved	Reserved
8 to (z-1) ^c	0	1	0	Reserved	0

^a Shading identifies configurable zone groups.
^b All reserved ZP bits shall be set to zero (e.g., bits ZP[4 to 7, 4 to (z-1)] are set to zero).
^c The number of zone groups (i.e., z) is reported in NUMBER OF ZONE GROUPS field in the REPORT GENERAL response (see 10.4.3.4).

If a zone manager enables zoning on zoning capable expander devices that report different values in the NUMBER OF ZONE GROUPS field in the REPORT GENERAL response (see 10.4.3.4)(e.g., some support 128 and others support 256), then the zone manager shall:

- a) configure all zoning enabled expander devices contained within the ZPSDS to use the highest commonly supported number of zone groups (e.g., 128);

Author: Isi-gpenokie
Subject: Highlight
Date: 5/25/2008 6:21:56 PM

T REJECT (3.8 only applies to procedures/functions. 3.2 even defines [s, d] notation for ZPSDS)

Global - The conventions section defines [...] as << Brackets enclose optional or conditional parameters and arguments >> That definition does not seem to fit here. Either the definition needs to change or a new convention needs to be defined.

Author: elx-bmartin
Subject: Highlight
Date: 5/25/2008 6:22:12 PM

T ACCEPT - DONE (and added space before s)

If ZP[s, d] is set to a value, ZP[d,s] shall be set to the same value

ZP[s,d] has to be set to a value. Reword to:

ZP[d,s] shall be set to the same value as ZP[s,d]

Author: wdc-mevans
Subject: Highlight
Date: 5/25/2008 6:22:24 PM

T ACCEPT - DONE

that
s/b
whether or not

Author: Isi-bbesmer
Subject: Highlight
Date: 6/4/2008 10:43:19 AM

T ACCEPT - DONE (5/5 "may or may not preserve the ZPT through power loss or expander device reduced functionality". Change "on power on" in last sentence of this paragraph to "after power on or expander device reduced functionality")

power loss.
s/b
there is no power
loss and no expander device reduced functionality (see 4.6.8).

Author: RElliott
Subject: Highlight
Date: 7/17/2008 6:02:34 PM

T ACCEPT - DONE (7/14)

zone permission table
s/b
current zone permission table

Author: wdc-mevans
Subject: Highlight
Date: 5/25/2008 6:22:47 PM

T REJECT (first noun/subject convention, but added "then")

it
s/b
then the zoning expander device

- b) configure the zone phy information in all the zoning expander devices to set each phy to a zone group less than the highest commonly supported number of zone groups; and
- c) configure the zone permission table in all the zoning expander devices to set each entry to zero that is higher than the highest commonly supported number of zone groups.

4.9.3.4 Zoning expander route table

A zoning expander route table is an expander-based expander route table (see 4.6.7.3) that is able to hold the zone group of each routed SAS address.

Figure 56 shows a representation of the zoning expander route table.

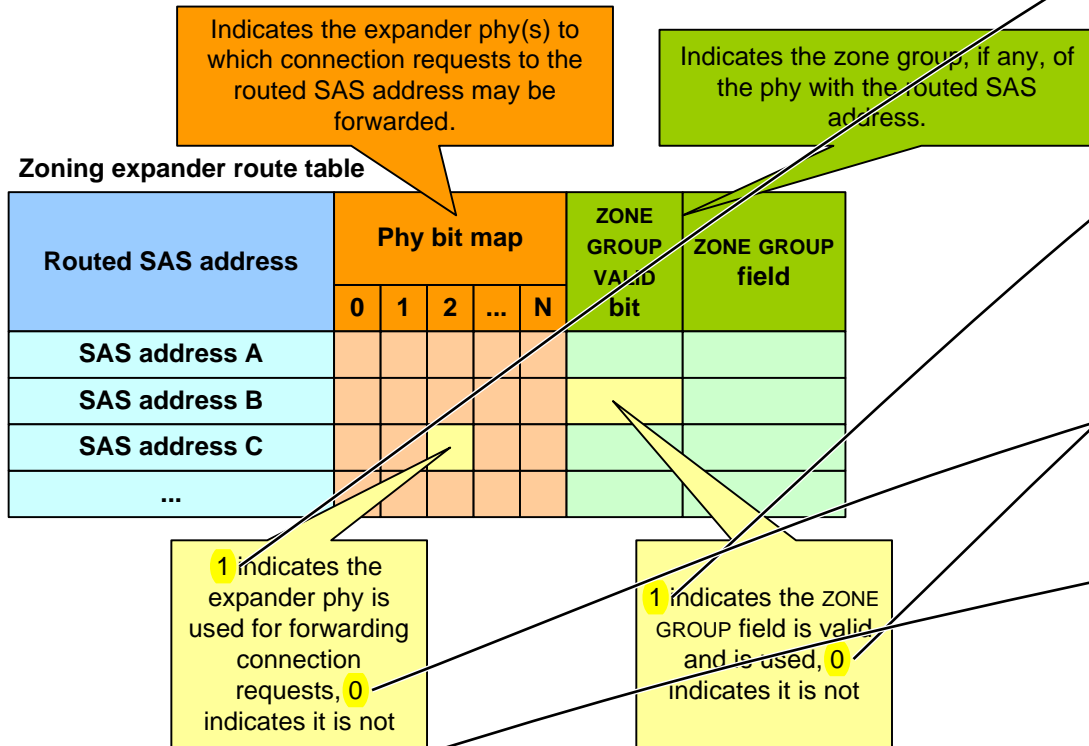

Figure 56 — Zoning expander route table

The zoning expander route table:



- a) shall include discovered SAS addresses for each expander phy with the ROUTING ATTRIBUTE field set to 2h (i.e., table) in the DISCOVER response; and
- b) may include discovered SAS addresses for expander phys with the ROUTING ATTRIBUTE field set to 1h (i.e., subtractive) in the DISCOVER response as long as they do not prevent inclusion of SAS addresses for expander phys with the ROUTING ATTRIBUTE field set to 2h (i.e., table). The determination of which such SAS addresses to include is vendor-specific.

The total number of routed SAS addresses shall not exceed the value indicated in the MAXIMUM NUMBER OF ROUTED SAS ADDRESSES field in the REPORT GENERAL response.

4.9.3.5 Source zone group and destination zone group determination

When a zoning expander device with zoning enabled receives an OPEN address frame (see 7.8.3):

- a) the zone group of the source port (i.e., s) is identified as defined in table 33; and
- b) the zone group of the destination port (i.e., d) is identified as defined in table 34.

If the ZP[s, d] bit is set to one then access between the phys shall be permitted and the zoning expander device shall perform the ECM arbitration procedure. If the ZP[s, d] bit is set to zero then access between the

Page: 108

● Author: Isi-gpenokie
Subject: Highlight
Date: 5/25/2008 6:23:37 PM
 REJECT

Should be << one >>

● Author: Isi-gpenokie
Subject: Highlight
Date: 5/25/2008 6:23:24 PM
 REJECT

Should be << one >>

● Author: Isi-gpenokie
Subject: Highlight
Date: 5/25/2008 6:23:29 PM
 REJECT

Should be << zero >>

● Author: Isi-gpenokie
Subject: Highlight
Date: 5/25/2008 6:23:34 PM
 REJECT

Should be << zero >>

● Author: Isi-bbesmer
Subject: Note
Date: 6/4/2008 10:46:46 AM
 REJECT (but changed "for" to "discovered behind". end devices are part of the "discovered SAS addresses". The expander phys discussed are those in this expander device.)

Don't end-devices need to be in this list?

● Author: Isi-gpenokie
Subject: Highlight
Date: 6/4/2008 10:44:51 AM
 REJECT (no, this is tied into the subset of SAS addresses discussed earlier in item b). It's not applicable SAS addresses in general)

This << determination of which such SAS addresses to include is vendor-specific >> should be << determination of which SAS addresses to include is vendor-specific >>

● Author: RElliott
Subject: Highlight
Date: 6/30/2008 6:16:52 PM
 ACCEPT - DONE

one then
s/b
one, then

● Author: wdc-mevans
Subject: Highlight
Date: 5/17/2008 5:26:31 PM
 ACCEPT - DONE

phys
s/b

Comments from page 108 continued on next page

- b) configure the zone phy information in all the zoning expander devices to set each phy to a zone group less than the highest commonly supported number of zone groups; and
- c) configure the zone permission table in all the zoning expander devices to set each entry to zero that is higher than the highest commonly supported number of zone groups.

4.9.3.4 Zoning expander route table

A zoning expander route table is an expander-based expander route table (see 4.6.7.3) that is able to hold the zone group of each routed SAS address.

Figure 56 shows a representation of the zoning expander route table.

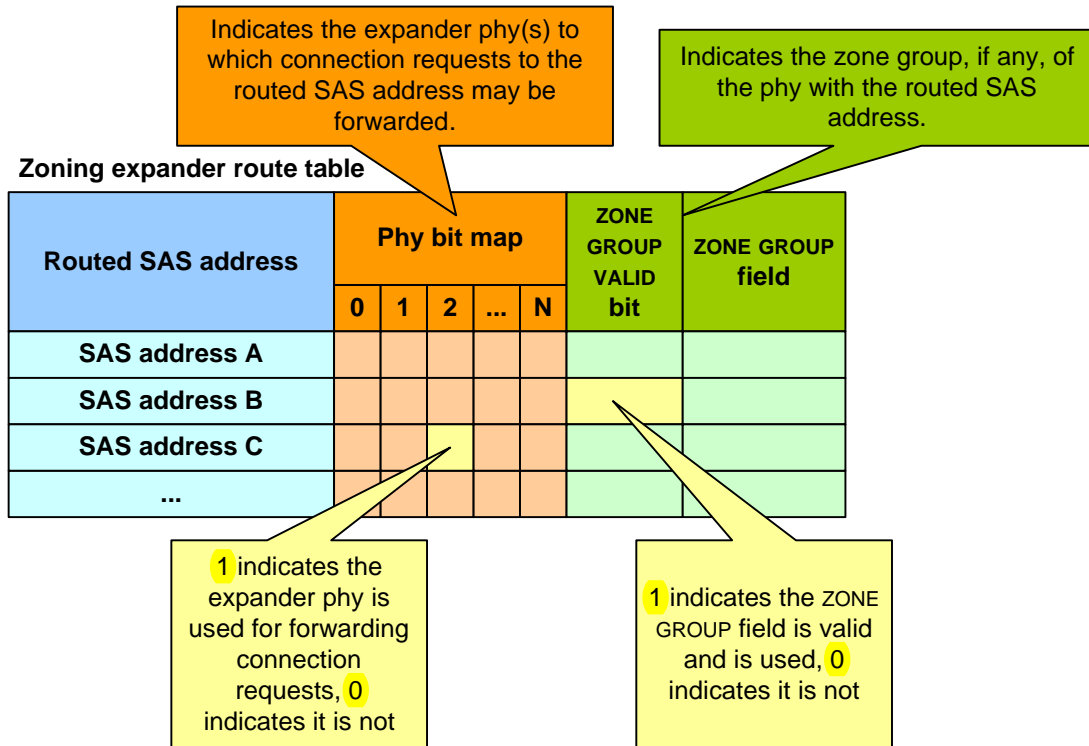

Figure 56 — Zoning expander route table

The zoning expander route table:

- a) shall include discovered SAS addresses for each expander phy with the ROUTING ATTRIBUTE field set to 2h (i.e., table) in the DISCOVER response; and
- b) may include discovered SAS addresses for expander phys with the ROUTING ATTRIBUTE field set to 1h (i.e., subtractive) in the DISCOVER response as long as they do not prevent inclusion of SAS addresses for expander phys with the ROUTING ATTRIBUTE field set to 2h (i.e., table). The determination of which such SAS addresses to include is vendor-specific.

The total number of routed SAS addresses shall not exceed the value indicated in the MAXIMUM NUMBER OF ROUTED SAS ADDRESSES field in the REPORT GENERAL response.

4.9.3.5 Source zone group and destination zone group determination

When a zoning expander device with zoning enabled receives an OPEN address frame (see 7.8.3):

- a) the zone group of the source port (i.e., s) is identified as defined in table 33; and
- b) the zone group of the destination port (i.e., d) is identified as defined in table 34.

If the ZP[s, d] bit is set to one then access between the phys shall be permitted and the zoning expander device shall perform the ECM arbitration procedure. If the ZP[s, d] bit is set to zero then access between the

phys is not permitted and the zoning expander device shall transmit an OPEN_REJECT in response to the connection request as follows:

- a) OPEN_REJECT (RETRY) if the zoning expander device is locked; and
- b) OPEN_REJECT (ZONE VIOLATION) if the zoning expander device is unlocked.

Zoning expander devices with zoning enabled shall follow the rules in table 33 to determine the zone group of the source port.

Table 33 — Source zone group determination

INSIDE ZPSDS bit of the expander phy that received the OPEN address frame	Source zone group
0	Zone group of the receiving expander phy
1	Source zone group specified by the SOURCE ZONE GROUP field in the received OPEN address frame

Zoning expander devices with zoning enabled shall follow the rules in table 34 to determine the zone group of the destination port.

Table 34 — Destination zone group determination

Routing method of the destination expander phy	Destination zone group
Direct	Zone group of the destination expander phy
Subtractive	<p>If the ZONE GROUP VALID bit is set to one, then the zone group stored in the zoning expander route table for the destination SAS address.</p> <p>If the ZONE GROUP VALID bit is set to zero, then the zone group of the destination expander phy (i.e., the subtractive routing phy).</p>
Table	<p>If the ZONE GROUP VALID bit is set to one, then the zone group stored in the zoning expander route table for the destination SAS address.</p> <p>If the ZONE GROUP VALID bit is set to zero, then the zone group of the destination expander phy (i.e., the table routing phy).</p>

Page: 109

● Author: Isi-bday
Subject: Cross-Out
Date: 5/6/2008 4:07:48 PM
T REJECT (prefer to keep the "in response to the connection request" part)

an OPEN_REJECT in response to the
connection request as follows

● Author: wdc-mevans
Subject: Highlight
Date: 5/25/2008 6:24:10 PM
T ACCEPT - DONE

permitted and
s/b
permitted, and

● Author: wdc-mevans
Subject: Highlight
Date: 5/17/2008 5:26:57 PM
T ACCEPT - DONE

phys
s/b
source and destination phys

Figure 57 shows an example of a ZPSDS.

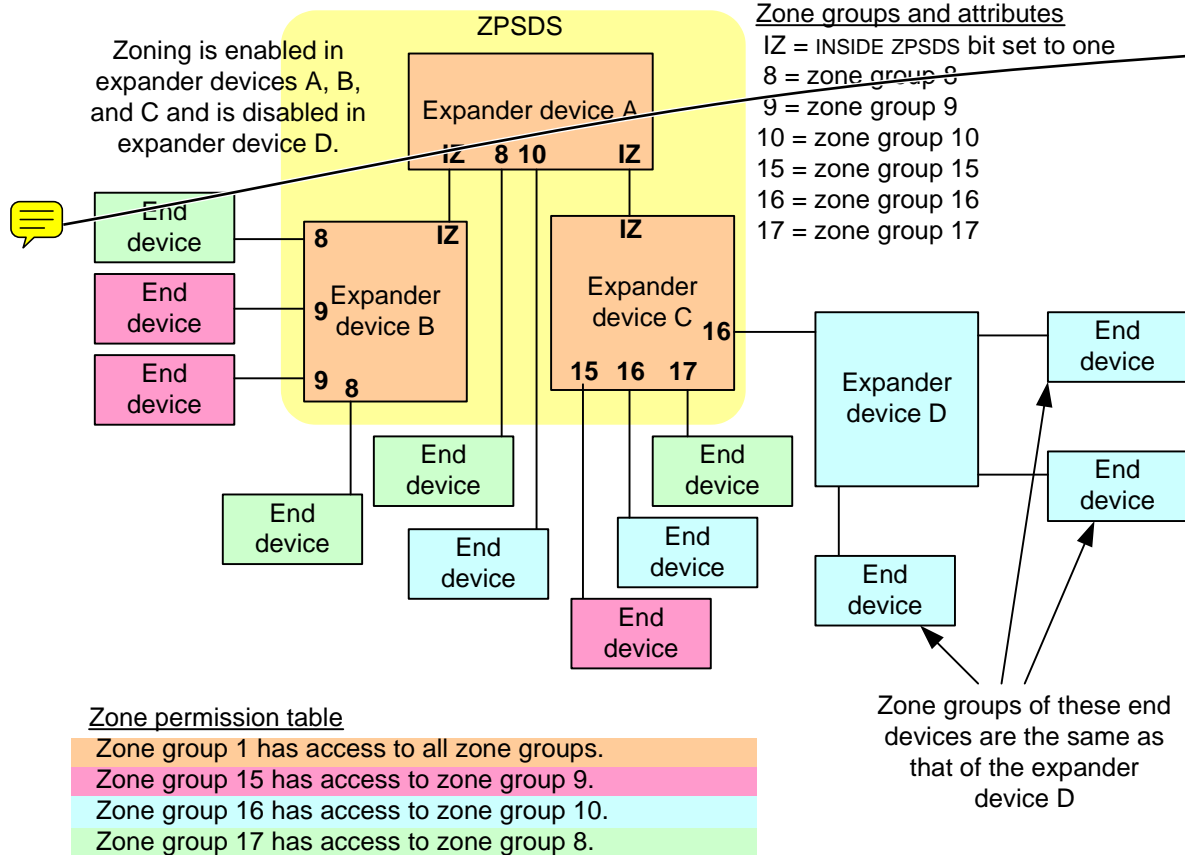

Figure 57 — Example of a ZPSDS

4.9.4 Zone phy information and link reset sequences

At the completion of a link reset sequence (see 4.4), if a SATA device is attached to an expander phy, **the** zoning expander device with zoning enabled shall set the INSIDE ZPSDS bit to zero for that expander phy.

At the completion of a link reset sequence, if a SATA device is not attached to an expander phy, **the** zoning expander device with zoning enabled shall update the current zone phy information fields as defined in table 35 based on:

- a) the REQUESTED INSIDE ZPSDS bit and the INSIDE ZPSDS PERSISTENT bit in the zone phy information (i.e., the bits transmitted in the outgoing IDENTIFY address frame (see 7.8.2)); and
- b) the REQUESTED INSIDE ZPSDS bit and INSIDE ZPSDS PERSISTENT bit received in the incoming IDENTIFY address frame.

● Author: lsi-bbesmer

Subject: Note

Date: 6/4/2008 10:52:52 AM



ACCEPT - DONE (This is the first location where all the terms used in the figure have been introduced. However, I agree it is unlikely location. Moved into 4.9.1 as the first figure in the zoning section. In that location, it uses a bunch of terms that have not yet been introduced, but I think that's also a reasonable approach - show the terms in a figure, then define them.)

This is a really cool diagram :), just don't understand what this has to do with "Source zone group and destination zone group determination".

● Author: RElliott

Subject: Highlight

Date: 6/30/2008 6:16:52 PM



ACCEPT - DONE

the

s/b

then the

● Author: RElliott

Subject: Highlight

Date: 6/30/2008 6:16:52 PM



ACCEPT - DONE

the

s/b

then the

Table 35 — Zone phy information fields after a link reset sequence

REQUESTED INSIDE ZPSDS bit		INSIDE ZPSDS PERSISTENT bit		Zone phy information field changes
Transmitted	Received	Transmitted	Received	
0	0 or 1	0 or 1	0 or 1	The zoning expander device shall set the INSIDE ZPSDS bit to zero.
1	0			
1	1	0	0	If the SAS address received in the IDENTIFY address frame during the identification sequence is different from the SAS address prior to the completion of the link reset sequence, then the zoning expander device shall: a) set the REQUESTED INSIDE ZPSDS bit to zero; and b) set the INSIDE ZPSDS bit to zero.
		0	1	
		1	0	If the SAS address received in the IDENTIFY address frame during the identification sequence is the same as the SAS address prior to the completion of the link reset sequence, then the zoning expander device shall: a) set the INSIDE ZPSDS bit to one; and b) set the ZONE GROUP field to 01h.
		1	1	The zoning expander device shall: a) set the INSIDE ZPSDS bit to one; and b) set the ZONE GROUP field to 01h.

This page contains no comments

If the ZONE GROUP PERSISTENT bit is set to one, then a link reset sequence (see 4.4) shall not cause the zone group of an expander phy to change unless the INSIDE ZPSDS bit changes from zero to one as specified in table 35. If the ZONE GROUP PERSISTENT bit is set to zero, then table 36 specifies events based on the initial condition of an expander phy that shall cause a zoning expander device with zoning enabled to change the ZONE GROUP field of the expander phy to its reset value (i.e., the saved value, if any, or the default value (e.g., 00h) if there is no saved value).

Table 36 — Events that cause the ZONE GROUP field to be reset when the ZONE GROUP PERSISTENT bit set to zero

Initial condition	Event after the initial condition is established
Completed link reset sequence with a SAS device attached	A subsequent link reset sequence completes and: <ol style="list-style-type: none"> the SAS address received in the IDENTIFY address frame (see 7.8.2) during the identification sequence is different from the SAS address prior to the completion of the link reset sequence; or a SATA device is attached.
Completed link reset sequence with a SATA device attached	Either: <ol style="list-style-type: none"> A subsequent link reset sequence completes and: <ol style="list-style-type: none"> a hot-plug timeout (see 6.7.5) occurred between the time of the initial condition and the time the link reset sequence completed; the zoning expander device has detected the possibility that a new SATA device has been inserted. The method of detection is outside the scope of this standard (e.g., an enclosure services process reports a change in the ELEMENT STATUS CODE field in the Device or Array Device element (see SES-2), or a change in the WORLD WIDE NAME field in the attached SATA device's IDENTIFY (PACKET) DEVICE data (see ATA8-ACS)); or a SAS phy or expander phy is attached; or The expander phy is disabled with the SMP PHY CONTROL function (see 10.4.3.28) DISABLE phy operation.

4.9.5 Broadcast processing in a zoning expander device with zoning enabled

The BPP determines the source zone group(s) of the Broadcast as follows:

- if the BPP receives a Broadcast Event Notify message from an expander logical phy (i.e., a zoning expander logical phy received a BROADCAST), the Broadcast has a single source zone group set to the zone group of that expander phy; and
- if the BPP receives a message from the management device server indicating that it received an SMP ZONED BROADCAST request from an SMP initiator port that has access to zone group 3, the Broadcast has each of the source zone groups specified in the SMP ZONED BROADCAST request.

The BPP forwards the Broadcast to each expander port other than the one on which the Broadcast was received (i.e., the expander port that received the BROADCAST or SMP ZONED BROADCAST request) if:

- the Broadcast is not a Broadcast (Zone Activate) and any of the source zone groups have access to the zone group of the expander port;
- the Broadcast is a Broadcast (Zone Activate), the BPP is in a locked zoning expander device, the INSIDE ZPSDS bit is set to one, and the source zone group has access to zone group 2; or
- the Broadcast is a Broadcast (Zone Activate), the BPP is not in a locked zoning expander device, and any of the source zone groups have access to the zone group of the expander port.

To forward a Broadcast to an expander port:

- if the expander port's INSIDE ZPSDS bit is set to one, then the BPP shall request that the SMP initiator port establish a connection on at least one phy in the expander port to the SMP target port of the attached expander device and transmit an SMP ZONED BROADCAST request specifying the source zone group(s); or

Page: 112

Author: elx-bmartin
Subject: Highlight
Date: 5/6/2008 4:07:48 PM
ACCEPT - DONE

bit set

S.B.

bit is set

Author: RElliott
Subject: Highlight
Date: 6/30/2008 6:16:52 PM
ACCEPT - DONE

when

s/b

if

Author: RElliott
Subject: Underline
Date: 6/30/2008 6:16:52 PM
ACCEPT - DONE

A

s/b

a

(part of global change to lowercase a)b)c) list entries)

Author: lsi-bday
Subject: Highlight
Date: 5/25/2008 6:24:53 PM

REJECT (yes, that is the intended behavior. This is the paranoid mode where zone permissions are lost if there is a fair chance that the drive was changed out. Taking a whole hot-plug timeout is the only indication that it might have happened. If software determines it is the same drive, it can reestablish the permissions.)

a hot-plug timeout

So is this the correct thing to do if the very next COMINIT is not detected by the SATA device, and a hot plug time expires until the expander tries again to do the link reset sequence?

Author: RElliott
Subject: Underline
Date: 6/30/2008 6:16:52 PM
ACCEPT - DONE

The

s/b

the

(part of global change to lowercase a)b)c) list entries)

Author: RElliott
Subject: Highlight
Date: 8/30/2008 1:38:34 PM
ACCEPT - DONE

Broadcast Event Notify message

Comments from page 112 continued on next page

If the ZONE GROUP PERSISTENT bit is set to one, then a link reset sequence (see 4.4) shall not cause the zone group of an expander phy to change unless the INSIDE ZPSDS bit changes from zero to one as specified in table 35. If the ZONE GROUP PERSISTENT bit is set to zero, then table 36 specifies events based on the initial condition of an expander phy that shall cause a zoning expander device with zoning enabled to change the ZONE GROUP field of the expander phy to its reset value (i.e., the saved value, if any, or the default value (e.g., 00h) if there is no saved value).

Table 36 — Events that cause the ZONE GROUP field to be reset when the ZONE GROUP PERSISTENT bit set to zero

Initial condition	Event after the initial condition is established
Completed link reset sequence with a SAS device attached	A subsequent link reset sequence completes and: <ol style="list-style-type: none"> a) the SAS address received in the IDENTIFY address frame (see 7.8.2) during the identification sequence is different from the SAS address prior to the completion of the link reset sequence; or b) a SATA device is attached.
Completed link reset sequence with a SATA device attached	Either: <ol style="list-style-type: none"> a) A subsequent link reset sequence completes and: <ol style="list-style-type: none"> A) a hot-plug timeout (see 6.7.5) occurred between the time of the initial condition and the time the link reset sequence completed; B) the zoning expander device has detected the possibility that a new SATA device has been inserted. The method of detection is outside the scope of this standard (e.g., an enclosure services process reports a change in the ELEMENT STATUS CODE field in the Device or Array Device element (see SES-2), or a change in the WORLD WIDE NAME field in the attached SATA device's IDENTIFY (PACKET) DEVICE data (see ATA8-ACS)); or C) a SAS phy or expander phy is attached; or b) The expander phy is disabled with the SMP PHY CONTROL function (see 10.4.3.28) DISABLE phy operation.

4.9.5 Broadcast processing in a zoning expander device with zoning enabled

The BPP determines the source zone group(s) of the Broadcast as follows:

- a) if the BPP receives a Broadcast Event Notify message from an expander logical phy (i.e., a zoning expander logical phy received a BROADCAST), the Broadcast has a single source zone group set to the zone group of that expander phy; and
- b) if the BPP receives a message from the management device server indicating that it received an SMP ZONED BROADCAST request from an SMP initiator port that has access to zone group 3, the Broadcast has each of the source zone groups specified in the SMP ZONED BROADCAST request.

The BPP forwards the Broadcast to each expander port other than the one on which the Broadcast was received (i.e., the expander port that received the BROADCAST or SMP ZONED BROADCAST request) if:

- a) the Broadcast is not a Broadcast (Zone Activate) and any of the source zone groups have access to the zone group of the expander port;
- b) the Broadcast is a Broadcast (Zone Activate), the BPP is in a locked zoning expander device, the INSIDE ZPSDS bit is set to one, and the source zone group has access to zone group 2; or
- c) the Broadcast is a Broadcast (Zone Activate), the BPP is not in a locked zoning expander device, and any of the source zone groups have access to the zone group of the expander port.

To forward a Broadcast to an expander port:

- a) if the expander port's INSIDE ZPSDS bit is set to one, then the BPP shall request that the SMP initiator port establish a connection on at least one phy in the expander port to the SMP target port of the attached expander device and transmit an SMP ZONED BROADCAST request specifying the source zone group(s); or

s/b
request

● Author: RElliott
Subject: Highlight
Date: 8/30/2008 1:43:01 PM
T ACCEPT - DONE

the
s/b
then the

● Author: lsi-gpenokie
Subject: Highlight
Date: 5/25/2008 6:25:07 PM
T ACCEPT - DONE

Unless the BPP can get both of these messages at the same time this is an << or >>.

● Author: RElliott
Subject: Highlight
Date: 8/31/2008 4:44:15 PM
T REFER PROTOCOL WG

message from the management device server indicating that it received an SMP
ZONED BROADCAST request from an SMP initiator port that has access to zone group 3,

should this message (probably "request") have a name? Is it just an argument to an existing Broadcast Event Notify request?

● Author: RElliott
Subject: Highlight
Date: 8/30/2008 1:43:15 PM
T ACCEPT - DONE

the
s/b
then the

- b) if the expander port's INSIDE ZPSDS bit is set to zero, then the BPP shall send a Transmit Broadcast message to at least one phy in the expander port, causing it to transmit a BROADCAST.

4.9.6 Zone configuration

4.9.6.1 Zone configuration overview

Zoning expander devices implement a lock to coordinate zoning configuration by zone manager(s).

There are four steps in the zone configuration process:

- 1) lock (see 4.9.6.2);
- 2) load (see 4.9.6.3);
- 3) activate (see 4.9.6.4); and
- 4) unlock (see 4.9.6.5).

The management device server in a zoning expander device **only accepts** SMP zone configuration function requests, SMP ZONE ACTIVATE requests, and SMP ZONE UNLOCK **requests** when it is locked, and only accepts SMP zone configuration function requests from the zone manager that locked the zoning expander device (i.e., the active zone manager). SMP zone configuration functions change zoning expander shadow values. When changes are complete, the zone manager activates the changes and the zoning expander device sets the zoning expander active values equal to the zoning expander shadow values. The zone manager then unlocks the zoning expander devices.

For a ZPSDS to function correctly, all **zoning expander devices are required** to have identical values in their zone permission tables. To change zone permission tables, a zone manager device locks all zoning expander devices in a ZPSDS.

To change zone phy information, a zone manager locks only the zoning expander devices containing the phys to be changed.

When a zoning expander device with zoning disabled is being added to a ZPSDS (see figure 54 in 4.9.1) or two or more ZPSDSes are being merged (see figure 55 in 4.9.1), the zone manager locks all of the zoning expander devices that are to be included in the final ZPSDS. The zone manager configures the zone phy information in each zoning expander device (e.g., sets the REQUESTED INSIDE ZPSDS bit to one for phys inside the final ZPSDS) and configures all of the zone permission tables to be identical.

If the zone lock inactivity timer expires then the zoning expander device performs the unlock step. The zoning expander device is unlocked and the zoning expander shadow values are not activated.

4.9.6.2 Lock step

The lock step ensures that the same zone manager locks each zoning expander device. A zone manager sends the SMP ZONE LOCK request (see 10.4.3.21) to lock a zoning expander device. A zoning expander device is locked **when** the ZONE LOCKED bit is set to one in the SMP REPORT GENERAL response and after the SAS address of the zone management server device has been stored. The management device server in a locked zoning expander device processes SMP zone configuration function requests, SMP ZONE ACTIVATE requests, and SMP ZONE UNLOCK requests.

If more than one zone manager attempts to lock a group of zoning expander devices, **the** following rules ensure that any concurrent requests are resolved:

- 1) **If the first SMP ZONE LOCK response received by a zone manager has the FUNCTION RESULT field set to ZONE LOCK VIOLATION (see 10.4.3.3), then the group of zoning expander devices is locked by another zone manager and** the zone manager should originate no further requests until it receives a Broadcast (Change);
- 2) **If at least one SMP ZONE LOCK request is successful and at least one other response has:**
 - A) the **FUNCTION RESULT** field set to ZONE LOCK VIOLATION (see 10.4.3.3); and
 - B) the **CONFIGURING** bit set to one (see 4.9.6.3),

then **a zoning expander device** is locked and being configured by another zone manager. The zone manager that failed to lock the zoning expander devices should unlock all zoning expander devices

Page: 113

● Author: Isi-bbesmer
Subject: Highlight
Date: 5/25/2008 6:25:24 PM
T REJECT (this is an overview, the shalls are elsewhere)

shall only accept

● Author: Isi-bbesmer
Subject: Highlight
Date: 6/4/2008 1:25:39 PM
T REJECT (Although discussed in the WG as follows, I think it reads fine. Changing "when" to "while" though, since it's for the entire duration, not just when the lock occurs. 5/5 This is not a list of the only things the expander accepts, it is saying the expander only access these things under certain conditions. Need to reword; try putting the list first, or create an a)b) list. "These...are only accepted when locked". Or invert, these are rejected when not locked. Avoid "only accepts".)

Do we need to add REPORT GENERAL to this list, so other devices can determine if the expander is configuring.

● Author: Isi-bbesmer
Subject: Highlight
Date: 5/6/2008 4:07:48 PM
T ACCEPT - DONE

zoning expander devices are required
s/b
zoning expander devices within the ZPSDS are required

● Author: RElliott
Subject: Highlight
Date: 8/31/2008 6:10:22 PM
T ACCEPT - DONE

If the zone lock inactivity timer expires then
s/b
When the zone lock inactivity timer expires

● Author: RElliott
Subject: Highlight
Date: 6/30/2008 6:16:52 PM
T ACCEPT - DONE

when
s/b
while

● Author: RElliott
Subject: Highlight
Date: 6/30/2008 6:16:52 PM
T ACCEPT - DONE

the
s/b
then the

● Author: Isi-gpenokie
Subject: Rectangle
Date: 6/4/2008 1:40:14 PM
T ACCEPT - DONE (Although discussed in the WG, the original comment seems OK as long as the outer items remain "and"ed since 2) and 3) could both be true. 5/5 the order is really 1) followed by 2) and 3) in parallel. Put the 1) text into the paragraph somehow, then use an unordered list for 2) and 3).)

Comments from page 113 continued on next page

- b) if the expander port's INSIDE ZPSDS bit is set to zero, then the BPP shall send a Transmit Broadcast message to at least one phy in the expander port, causing it to transmit a BROADCAST.

4.9.6 Zone configuration

4.9.6.1 Zone configuration overview

Zoning expander devices implement a lock to coordinate zoning configuration by zone manager(s).

There are four steps in the zone configuration process:

- 1) lock (see 4.9.6.2);
- 2) load (see 4.9.6.3);
- 3) activate (see 4.9.6.4); and
- 4) unlock (see 4.9.6.5).

The management device server in a zoning expander device **only accepts** SMP zone configuration function requests, SMP ZONE ACTIVATE requests, and SMP ZONE UNLOCK **requests** when it is locked, and only accepts SMP zone configuration function requests from the zone manager that locked the zoning expander device (i.e., the active zone manager). SMP zone configuration functions change zoning expander shadow values. When changes are complete, the zone manager activates the changes and the zoning expander device sets the zoning expander active values equal to the zoning expander shadow values. The zone manager then unlocks the zoning expander devices.

For a ZPSDS to function correctly, all **zoning expander devices are required** to have identical values in their zone permission tables. To change zone permission tables, a zone manager device locks all zoning expander devices in a ZPSDS.

To change zone phy information, a zone manager locks only the zoning expander devices containing the phys to be changed.

When a zoning expander device with zoning disabled is being added to a ZPSDS (see figure 54 in 4.9.1) or two or more ZPSDSes are being merged (see figure 55 in 4.9.1), the zone manager locks all of the zoning expander devices that are to be included in the final ZPSDS. The zone manager configures the zone phy information in each zoning expander device (e.g., sets the REQUESTED INSIDE ZPSDS bit to one for phys inside the final ZPSDS) and configures all of the zone permission tables to be identical.

If the zone lock inactivity timer expires then the zoning expander device performs the unlock step. The zoning expander device is unlocked and the zoning expander shadow values are not activated.

4.9.6.2 Lock step

The lock step ensures that the same zone manager locks each zoning expander device. A zone manager sends the SMP ZONE LOCK request (see 10.4.3.21) to lock a zoning expander device. A zoning expander device is locked **when** the ZONE LOCKED bit is set to one in the SMP REPORT GENERAL response and after the SAS address of the zone management server device has been stored. The management device server in a locked zoning expander device processes SMP zone configuration function requests, SMP ZONE ACTIVATE requests, and SMP ZONE UNLOCK requests.

If more than one zone manager attempts to lock a group of zoning expander devices, **the** following rules ensure that any concurrent requests are resolved:

- 1) If the first SMP ZONE LOCK response received by a zone manager has the FUNCTION RESULT field set to ZONE LOCK VIOLATION (see 10.4.3.3), then the group of zoning expander devices is locked by another zone **manager and** the zone manager should originate no further requests until it receives a Broadcast (Change);
- 2) **If at least one SMP ZONE LOCK request is successful and at least one other response has:**
 - A) the **FUNCTION RESULT** field set to ZONE LOCK VIOLATION (see 10.4.3.3); and
 - B) the **CONFIGURING bit** set to one (see 4.9.6.3),

then **a zoning expander device** is locked and being configured by another zone manager. The zone manager that failed to lock the zoning expander devices should unlock all zoning expander devices

This does not appear to be an ordered list. Change it to an a,b,c list.

● Author: wdc-mevans
Subject: Highlight
Date: 5/25/2008 6:25:50 PM
T ACCEPT - DONE

manager and
s/b
manager, and

● Author: lsi-bbesmer
Subject: Highlight
Date: 6/4/2008 1:40:52 PM
T ACCEPT - DONE (configuring bit split into two bits, so ZONE CONFIGURING used here; see comment on page i; per 5/5 WG)

This requires 2 SMP requests to each expander:
1) Zone Lock
2) Report General

The Lock state could change between these 2 states.

Probably the easiest change here is to add a copy of the CONFIGURING Bit in the ZONE LOCK response.

● Author: RElliott
Subject: Underline
Date: 6/30/2008 6:16:52 PM
T ACCEPT - DONE

CONFIGURING bit
s/b
ZONE CONFIGURING bit

new bit per lsi-bbesmer comment on first page

● Author: RElliott
Subject: Highlight
Date: 6/30/2008 6:16:52 PM
T ACCEPT - DONE

a zoning expander device
s/b
at least one zoning expander device

that it has locked. When a Broadcast (Change) event is received, then the zone manager should retry the lock step; and

- 3) If at least one SMP ZONE LOCK request is successful and at least one other response has:
- the FUNCTION RESULT field set to ZONE LOCK VIOLATION (see 10.4.3.3); and
 - the CONFIGURING bit set to zero,

then another zone manager has locked at least one zoning expander device in the group of zoning expander devices and the zone manager shall evaluate the ACTIVE ZONE MANAGER SAS ADDRESS field in the SMP ZONE LOCK response:

- if the returned SAS address has a lower numeric value than the SMP port SAS address of the zone manager, then the zone manager with the higher numeric value SAS address shall repeat the SMP ZONE LOCK request to all zoning expander devices that it has not already locked until all required zoning expander devices are locked, or until a Broadcast (Change) is received; or
- if the returned ACTIVE ZONE MANAGER SAS ADDRESS field has a higher numeric value than the SMP port SAS address of the zone manager, then the zone manager with the lower numeric value SAS address shall originate an SMP ZONE UNLOCK request to unlock all zoning expander devices that it locked.

The lock step is complete after a zone manager receives a successful SMP ZONE LOCK response from all required zoning expander devices.

4.9.6.3 Load step

The load step stores SMP zone configuration information as zoning expander shadow values. A zoning expander device only processes SMP zone configuration function requests originated by the active zone manager when it is locked.

The SMP zone configuration functions are:

- SMP CONFIGURE ZONE PHY INFORMATION (see 10.4.3.25);
- SMP CONFIGURE ZONE PERMISSION TABLE (see 10.4.3.26); and
- SMP ENABLE DISABLE ZONING (see 10.4.3.19).

After a locked zoning expander device processes any SMP zone configuration function request, it sets the CONFIGURING bit to one in the SMP REPORT GENERAL response (see 10.4.3.4).

SMP zone configuration functions change the zoning expander shadow values and do not affect the zoning expander active values. The zoning expander shadow values become zoning expander active values during the activate step (see 4.9.6.4).

If the active zone manager receives a response to an SMP zone configuration function with the FUNCTION RESULT field set to ZONE LOCK VIOLATION (see 10.4.3.3), then it should unlock all locked zoning expander devices.

The load step may be skipped when a locked zoning expander device is unlocked:

- by a zone manager with a higher SAS address during the lock step (see 4.9.6.2); or
- because the zone lock inactivity timer expires.

4.9.6.4 Activate step

The activate step copies the zoning expander shadow register values to the zoning expander active values. The active zone manager issues one of the following:

- a Broadcast (Zone Activate) (see 4.1.13); or
- an SMP ZONE ACTIVATE request (see 10.4.3.22) to all locked zoning expander devices.

After a locked zoning expander device receives a Broadcast (Zone Activate) or processes an SMP ZONE ACTIVATE request, then the zoning expander device shall set the zoning expander active values equal to the zoning expander shadow values.

If the active zone manager receives an SMP ZONE ACTIVATE response with the FUNCTION RESULT field set to ZONE LOCK VIOLATION (see 10.4.3.3), then it should unlock all locked zoning expander devices.

Page: 114

● Author: RElliott
Subject: Cross-Out
Date: 6/30/2008 6:16:52 PM
T ACCEPT - DONE

● Author: Isi-gpenokie
Subject: Highlight
Date: 5/25/2008 6:27:05 PM
T REJECT (this is an ordered list; they use and)

This is a list of conditions of which any one could occur to it is an << or >> list.

● Author: wdc-mevans
Subject: Highlight
Date: 5/25/2008 6:26:39 PM
T REJECT (2 things ANDED together)

successful and
s/b
successful, and

● Author: Isi-bbesmer
Subject: Highlight
Date: 6/4/2008 1:41:22 PM
T ACCEPT - DONE (changed to ZONE CONFIGURING bit; see comment on first page)

See comment for 2)

● Author: RElliott
Subject: Underline
Date: 6/30/2008 6:16:52 PM
T ACCEPT - DONE

CONFIGURING bit
s/b
ZONE CONFIGURING bit

new bit per Isi-bbesmer comment on first page

● Author: wdc-mevans
Subject: Highlight
Date: 5/25/2008 6:27:20 PM
T ACCEPT - DONE

devices and
s/b
devices, and

● Author: wdc-mevans
Subject: Highlight
Date: 5/25/2008 6:27:27 PM
T ACCEPT - DONE

response:
s/b
response as follows:

● Author: RElliott
Subject: Highlight

Comments from page 114 continued on next page

that it has locked. When a Broadcast (Change) event is received, then the zone manager should retry the lock step; and

- 3) If at least one SMP ZONE LOCK request is successful and at least one other response has:
- A) the FUNCTION RESULT field set to ZONE LOCK VIOLATION (see 10.4.3.3); and
 - B) the CONFIGURING bit set to zero,

then another zone manager has locked at least one zoning expander device in the group of zoning expander devices and the zone manager shall evaluate the ACTIVE ZONE MANAGER SAS ADDRESS field in the SMP ZONE LOCK response:

- A) if the returned SAS address has a lower numeric value than the SMP port SAS address of the zone manager, then the zone manager with the higher numeric value SAS address shall repeat the SMP ZONE LOCK request to all zoning expander devices that it has not already locked until all required zoning expander devices are locked, or until a Broadcast (Change) is received; or
- B) if the returned ACTIVE ZONE MANAGER SAS ADDRESS field has a higher numeric value than the SMP port SAS address of the zone manager, then the zone manager with the lower numeric value SAS address shall originate an SMP ZONE UNLOCK request to unlock all zoning expander devices that it locked.

The lock step is complete after a zone manager receives a successful SMP ZONE LOCK response from all required zoning expander devices.

4.9.6.3 Load step

The load step stores SMP zone configuration information as zoning expander shadow values. A zoning expander device only processes SMP zone configuration function requests originated by the active zone manager when it is locked.

The SMP zone configuration functions are:

- a) SMP CONFIGURE ZONE PHY INFORMATION (see 10.4.3.25);
- b) SMP CONFIGURE ZONE PERMISSION TABLE (see 10.4.3.26); and
- c) SMP ENABLE DISABLE ZONING (see 10.4.3.19).

After a locked zoning expander device processes any SMP zone configuration function request, it sets the CONFIGURING bit to one in the SMP REPORT GENERAL response (see 10.4.3.4).

SMP zone configuration functions change the zoning expander shadow values and do not affect the zoning expander active values. The zoning expander shadow values become zoning expander active values during the activate step (see 4.9.6.4).

If the active zone manager receives a response to an SMP zone configuration function with the FUNCTION RESULT field set to ZONE LOCK VIOLATION (see 10.4.3.3), then it should unlock all locked zoning expander devices.

The load step may be skipped when a locked zoning expander device is unlocked:

- a) by a zone manager with a higher SAS address during the lock step (see 4.9.6.2); or
- b) because the zone lock inactivity timer expires.

4.9.6.4 Activate step

The activate step copies the zoning expander shadow register values to the zoning expander active values. The active zone manager issues one of the following:

- a) a Broadcast (Zone Activate) (see 4.1.13); or
- b) an SMP ZONE ACTIVATE request (see 10.4.3.22) to all locked zoning expander devices.

After a locked zoning expander device receives a Broadcast (Zone Activate) or processes an SMP ZONE ACTIVATE request, then the zoning expander device shall set the zoning expander active values equal to the zoning expander shadow values.

If the active zone manager receives an SMP ZONE ACTIVATE response with the FUNCTION RESULT field set to ZONE LOCK VIOLATION (see 10.4.3.3), then it should unlock all locked zoning expander devices.

Date: 6/30/2008 6:16:52 PM

 ACCEPT - DONE

when
s/b
while

● Author: wdc-mevans

Subject: Highlight

Date: 5/25/2008 6:27:48 PM

 REJECT (first noun/subject convention)

it
s/b
the locked zoning expander

● Author: RElliott

Subject: Underline

Date: 6/30/2008 6:16:52 PM

 ACCEPT - DONE

CONFIGURING bit
s/b
ZONE CONFIGURING bit

new bit per lsi-bbesmer comment on first page

● Author: RElliott

Subject: Note

Date: 6/30/2008 6:16:52 PM

 ACCEPT - DONE

Add:

While the zone configuring bit is set to one, the expander device shall return OPEN_REJECT (RETRY) for any connection requests that would otherwise have resulted in OPEN_REJECT (NO DESTINATION) (see 4.6.6.3).

to support splitting the CONFIGURING bit per lsi-bbesmer comment on first page

● Author: wdc-mevans

Subject: Highlight

Date: 5/25/2008 6:27:55 PM

 REJECT (first noun/subject convention)

it
s/b
the active zone manager

● Author: RElliott

Subject: Note

Date: 9/3/2008 7:16:36 PM

 ACCEPT - DONE

Add that the active step:

b) saves the zoning expander shadow values, if saving was requested.

by merging into 1st sentence.

(per discussion with Tim Symons, PMC-Sierra and Brad Besmer, LSI)

Don't want to save before activation, or expanders will be inconsistent if a power loss occurs.

Comments from page 114 continued on next page

that it has locked. When a Broadcast (Change) event is received, then the zone manager should retry the lock step; and

- 3) If at least one SMP ZONE LOCK request is successful and at least one other response has:
- A) the FUNCTION RESULT field set to ZONE LOCK VIOLATION (see 10.4.3.3); and
 - B) the CONFIGURING bit set to zero,

then another zone manager has locked at least one zoning expander device in the group of zoning expander devices and the zone manager shall evaluate the ACTIVE ZONE MANAGER SAS ADDRESS field in the SMP ZONE LOCK response:

- A) if the returned SAS address has a lower numeric value than the SMP port SAS address of the zone manager, then the zone manager with the higher numeric value SAS address shall repeat the SMP ZONE LOCK request to all zoning expander devices that it has not already locked until all required zoning expander devices are locked, or until a Broadcast (Change) is received; or
- B) if the returned ACTIVE ZONE MANAGER SAS ADDRESS field has a higher numeric value than the SMP port SAS address of the zone manager, then the zone manager with the lower numeric value SAS address shall originate an SMP ZONE UNLOCK request to unlock all zoning expander devices that it locked.

The lock step is complete after a zone manager receives a successful SMP ZONE LOCK response from all required zoning expander devices.

4.9.6.3 Load step

The load step stores SMP zone configuration information as zoning expander shadow values. A zoning expander device only processes SMP zone configuration function requests originated by the active zone manager when it is locked.

The SMP zone configuration functions are:

- a) SMP CONFIGURE ZONE PHY INFORMATION (see 10.4.3.25);
- b) SMP CONFIGURE ZONE PERMISSION TABLE (see 10.4.3.26); and
- c) SMP ENABLE DISABLE ZONING (see 10.4.3.19).

After a locked zoning expander device processes any SMP zone configuration function request, it sets the CONFIGURING bit to one in the SMP REPORT GENERAL response (see 10.4.3.4).

SMP zone configuration functions change the zoning expander shadow values and do not affect the zoning expander active values. The zoning expander shadow values become zoning expander active values during the activate step (see 4.9.6.4).

If the active zone manager receives a response to an SMP zone configuration function with the FUNCTION RESULT field set to ZONE LOCK VIOLATION (see 10.4.3.3), then it should unlock all locked zoning expander devices.

The load step may be skipped when a locked zoning expander device is unlocked:

- a) by a zone manager with a higher SAS address during the lock step (see 4.9.6.2); or
- b) because the zone lock inactivity timer expires.

4.9.6.4 Activate step

The activate step copies the zoning expander shadow register values to the zoning expander active values. The active zone manager issues one of the following:

- a) a Broadcast (Zone Activate) (see 4.1.13); or
- b) an SMP ZONE ACTIVATE request (see 10.4.3.27) to all locked zoning expander devices.

After a locked zoning expander device receives a Broadcast (Zone Activate) or processes an SMP ZONE ACTIVATE request, then the zoning expander device shall set the zoning expander active values equal to the zoning expander shadow values.

If the active zone manager receives an SMP ZONE ACTIVATE response with the FUNCTION RESULT field set to ZONE LOCK VIOLATION (see 10.4.3.3), then it should unlock all locked zoning expander devices.

● Author: RElliott
Subject: Highlight
Date: 6/30/2008 6:16:52 PM
T ACCEPT - DONE

issues
s/b
originates

● Author: wdc-mevans
Subject: Highlight
Date: 5/25/2008 6:28:06 PM
T REJECT (first noun/subject convention)

it
s/b
the active zone manager

The activate step may be skipped when a locked zoning expander device is unlocked:

- a) by a zone manager with a higher SAS address during the lock step (see 4.9.6.2); or
- b) because the zone lock inactivity timer expires.

4.9.6.5 Unlock step

The unlock step ensures that the active zone manager unlocks the locked zoning expander devices, or if the zone manager fails then the zone lock inactivity timer expires and the zoning expander devices unlock.

If the active zone manager originated Broadcast (Zone Activate), then it sends an SMP ZONE UNLOCK request (see 10.4.3.23) with the ACTIVATE REQUIRED bit set to one to each of the locked zoning expander devices. This ensures that each zoning expander device has performed the activate step before it performs the unlock step. If it receives an SMP ZONE UNLOCK response with the FUNCTION RESULT field set to NOT ACTIVATED (see 10.4.3.3), then the zone manager retries the SMP ZONE UNLOCK request a vendor-specific number of times, then originates an SMP ZONE ACTIVATE request to each locked zoning expander device.

If the active zone manager originated SMP ZONE ACTIVATE request(s), then after all the SMP ZONE ACTIVATE functions have successfully completed it sends an SMP ZONE UNLOCK request with the ACTIVATE REQUIRED bit set to zero to each of the locked zoning expander devices. If it receives an SMP ZONE UNLOCK response with the FUNCTION RESULT field set to BUSY (see 10.4.3.3), then the zone manager retries the SMP ZONE UNLOCK request.

When the SMP ZONE UNLOCK request is successful or the zone lock inactivity timer expires, then the zoning expander device is unlocked and shall:

- a) set the ZONE LOCKED bit to zero in the SMP REPORT GENERAL response (see 10.4.3.4);
- b) set the CONFIGURING bit to zero in the SMP REPORT GENERAL response;
- c) if the zone lock timer expired, originate a Broadcast (Change) from zone group 1; and
- d) if the management device server processed an SMP ZONE UNLOCK request, originate a Broadcast (Change) (see 7.11) from either:
 - A) each zone group whose zone permission table entries or zone phy information has changed; or
 - B) zone group 1.

When all SMP ZONE UNLOCK requests are successful the configuration process is complete.

4.9.6.6 Zone lock inactivity timer

The zone lock inactivity timer is supported by all zoning expander devices. The use of a timer ensures that if the zone manager disappears without performing the unlock step that all locked zoning expander devices are unlocked.

When a zoning expander device processes an SMP ZONE LOCK request (see 10.4.3.21) then the zone lock inactivity timer default value is set to the value of the ZONE LOCK INACTIVITY TIME LIMIT field.

The zone lock inactivity timer is initialized and started if the default value is non-zero and:

- a) the zoning expander device completes processing of any SMP zone configuration function request or SMP ZONE ACTIVATE request while the ZONE LOCKED bit is set to one in the SMP REPORT GENERAL response (see 10.4.3.4); or
- b) the zoning expander device completes processing of a successful SMP ZONE LOCK request.

The zone lock inactivity timer is stopped if:

- a) the ZONE LOCK INACTIVITY TIME LIMIT field is set to zero in an SMP ZONE LOCK request; or
- b) the ZONE LOCKED bit is set to zero in the SMP REPORT GENERAL response (e.g., an SMP ZONE UNLOCK request (see 10.4.3.23) is processed, or the zone lock inactivity timer expires).

If the zone lock inactivity timer expires then the zoning expander device:

- a) sets the ZONE LOCKED bit to zero in the SMP REPORT GENERAL response;
- b) sets the CONFIGURING bit to zero in the SMP REPORT GENERAL response; and
- c) sends Broadcast (Change) on all ports.

● Author: wdc-mevans
Subject: Highlight
Date: 5/25/2008 6:28:31 PM
T ACCEPT - DONE

expires and
s/b
expires, and

● Author: wdc-mevans
Subject: Highlight
Date: 5/25/2008 6:28:22 PM
T ACCEPT - DONE (made into an a)b list)

fails then
s/b
fails, then

● Author: wdc-mevans
Subject: Highlight
Date: 5/22/2008 10:11:15 AM
T REJECT (first noun/subject convention)

it
s/b
the active zone manager

● Author: wdc-mevans
Subject: Highlight
Date: 6/4/2008 4:37:20 PM
T ACCEPT - DONE (reworded sentence as: "This ensures that the activate step precedes the unlock step in each zoning expander device.")

it
s/b
the zoning expander device

● Author: wdc-mevans
Subject: Highlight
Date: 6/4/2008 4:37:58 PM
T ACCEPT - DONE

it
s/b
the active zone manager

● Author: lsi-gpenokie
Subject: Highlight
Date: 6/4/2008 4:35:32 PM
T ACCEPT - DONE

This << If it receives an SMP ZONE >> should be << If the zone manager receives an SMP ZONE >>

● Author: RElliott
Subject: Highlight
Date: 6/30/2008 6:16:52 PM
T ACCEPT - DONE

the zone manager
s/b
it

The activate step may be skipped when a locked zoning expander device is unlocked:

- a) by a zone manager with a higher SAS address during the lock step (see 4.9.6.2); or
- b) because the zone lock inactivity timer expires.

4.9.6.5 Unlock step

The unlock step ensures that the active zone manager unlocks the locked zoning expander devices, or if the zone manager fails then the zone lock inactivity timer expires and the zoning expander devices unlock.

If the active zone manager originated Broadcast (Zone Activate), then it sends an SMP ZONE UNLOCK request (see 10.4.3.23) with the ACTIVATE REQUIRED bit set to one to each of the locked zoning expander devices. This ensures that each zoning expander device has performed the activate step before it performs the unlock step. If it receives an SMP ZONE UNLOCK response with the FUNCTION RESULT field set to NOT ACTIVATED (see 10.4.3.3), then the zone manager retries the SMP ZONE UNLOCK request a vendor-specific number of times, then originates an SMP ZONE ACTIVATE request to each locked zoning expander device.

If the active zone manager originated SMP ZONE ACTIVATE request(s), then after all the SMP ZONE ACTIVATE functions have successfully completed it sends an SMP ZONE UNLOCK request with the ACTIVATE REQUIRED bit set to zero to each of the locked zoning expander devices. If it receives an SMP ZONE UNLOCK response with the FUNCTION RESULT field set to BUSY (see 10.4.3.3), then the zone manager retries the SMP ZONE UNLOCK request.

When the SMP ZONE UNLOCK request is successful or the zone lock inactivity timer expires, then the zoning expander device is unlocked and shall:

- a) set the ZONE LOCKED bit to zero in the SMP REPORT GENERAL response (see 10.4.3.4);
- b) set the CONFIGURING bit to zero in the SMP REPORT GENERAL response;
- c) if the zone lock timer expired, originate a Broadcast (Change) from zone group 1; and
- d) if the management device server processed an SMP ZONE UNLOCK request, originate a Broadcast (Change) (see 7.11) from either:
 - A) each zone group whose zone permission table entries or zone phy information has changed; or
 - B) zone group 1.

When all SMP ZONE UNLOCK requests are successful the configuration process is complete.

4.9.6.6 Zone lock inactivity timer

The zone lock inactivity timer is supported by all zoning expander devices. The use of a timer ensures that if the zone manager disappears without performing the unlock step that all locked zoning expander devices are unlocked.

When a zoning expander device processes an SMP ZONE LOCK request (see 10.4.3.21) then the zone lock inactivity timer default value is set to the value of the ZONE LOCK INACTIVITY TIME LIMIT field.

The zone lock inactivity timer is initialized and started if the default value is non-zero and:

- a) the zoning expander device completes processing of any SMP zone configuration function request or SMP ZONE ACTIVATE request while the ZONE LOCKED bit is set to one in the SMP REPORT GENERAL response (see 10.4.3.4); or
- b) the zoning expander device completes processing of a successful SMP ZONE LOCK request.

The zone lock inactivity timer is stopped if:

- a) the ZONE LOCK INACTIVITY TIME LIMIT field is set to zero in an SMP ZONE LOCK request; or
- b) the ZONE LOCKED bit is set to zero in the SMP REPORT GENERAL response (e.g., an SMP ZONE UNLOCK request (see 10.4.3.23) is processed, or the zone lock inactivity timer expires).

If the zone lock inactivity timer expires then the zoning expander device:

- a) sets the ZONE LOCKED bit to zero in the SMP REPORT GENERAL response;
- b) sets the CONFIGURING bit to zero in the SMP REPORT GENERAL response; and
- c) sends Broadcast (Change) on all ports.

(making the sentence conform to first noun/subject convention)

Author: wdc-mevans
Subject: Highlight
Date: 6/1/2008 5:09:17 PM
 REJECT (first noun/subject convention, but added a comma)

it
s/b
the active zone manager

Author: wdc-mevans
Subject: Highlight
Date: 6/4/2008 4:38:30 PM
 ACCEPT - DONE

it
s/b
the active zone manager

Author: Isi-gpenokie
Subject: Highlight
Date: 6/4/2008 4:38:43 PM
 ACCEPT - DONE ("If the active zone manager...")

This << If it receives an SMP_ZONE >> should be << If the zone manager receives an SMP_ZONE >>

Author: RElliott
Subject: Highlight
Date: 6/30/2008 6:16:52 PM
 ACCEPT - DONE

the zone manager
s/b
it

to follow first noun/subject convention

Author: RElliott
Subject: Underline
Date: 6/30/2008 6:16:52 PM
 ACCEPT - DONE

CONFIGURING bit
s/b
ZONE CONFIGURING bit

new bit per Isi-bbesmer comment on first page

Author: RElliott
Subject: Highlight
Date: 8/31/2008 6:12:28 PM
 ACCEPT - DONE

zone lock timer
s/b
zone lock inactivity timer

Author: RElliott
Subject: Note
Date: 8/31/2008 6:37:49 PM
 ACCEPT - DONE (7/14 per comment in 10.4.3.23)

Comments from page 115 continued on next page

The activate step may be skipped when a locked zoning expander device is unlocked:

- a) by a zone manager with a higher SAS address during the lock step (see 4.9.6.2); or
- b) because the zone lock inactivity timer expires.

4.9.6.5 Unlock step

The unlock step ensures that the active zone manager unlocks the locked zoning expander devices, or if the zone manager fails then the zone lock inactivity timer expires and the zoning expander devices unlock.

If the active zone manager originated Broadcast (Zone Activate), then it sends an SMP ZONE UNLOCK request (see 10.4.3.23) with the ACTIVATE REQUIRED bit set to one to each of the locked zoning expander devices. This ensures that each zoning expander device has performed the activate step before it performs the unlock step. If it receives an SMP ZONE UNLOCK response with the FUNCTION RESULT field set to NOT ACTIVATED (see 10.4.3.3), then the zone manager retries the SMP ZONE UNLOCK request a vendor-specific number of times, then originates an SMP ZONE ACTIVATE request to each locked zoning expander device.

If the active zone manager originated SMP ZONE ACTIVATE request(s), then after all the SMP ZONE ACTIVATE functions have successfully completed it sends an SMP ZONE UNLOCK request with the ACTIVATE REQUIRED bit set to zero to each of the locked zoning expander devices. If it receives an SMP ZONE UNLOCK response with the FUNCTION RESULT field set to BUSY (see 10.4.3.3), then the zone manager retries the SMP ZONE UNLOCK request.

When the SMP ZONE UNLOCK request is successful or the zone lock inactivity timer expires, then the zoning expander device is unlocked and shall:

- a) set the ZONE LOCKED bit to zero in the SMP REPORT GENERAL response (see 10.4.3.4);
- b) set the CONFIGURING bit to zero in the SMP REPORT GENERAL response;
- c) if the zone lock timer expired, originate a Broadcast (Change) from zone group 1; and
- d) if the management device server processed an SMP ZONE UNLOCK request, originate a Broadcast (Change) (see 7.11) from either:
 - A) each zone group whose zone permission table entries or zone phy information has changed; or
 - B) zone group 1.

When all SMP ZONE UNLOCK requests are successful the configuration process is complete.

4.9.6.6 Zone lock inactivity timer

The zone lock inactivity timer is supported by all zoning expander devices. The use of a timer ensures that if the zone manager disappears without performing the unlock step that all locked zoning expander devices are unlocked.

When a zoning expander device processes an SMP ZONE LOCK request (see 10.4.3.21) then the zone lock inactivity timer default value is set to the value of the ZONE LOCK INACTIVITY TIME LIMIT field.

The zone lock inactivity timer is initialized and started if the default value is non-zero and:

- a) the zoning expander device completes processing of any SMP zone configuration function request or SMP ZONE ACTIVATE request while the ZONE LOCKED bit is set to one in the SMP REPORT GENERAL response (see 10.4.3.4); or
- b) the zoning expander device completes processing of a successful SMP ZONE LOCK request.

The zone lock inactivity timer is stopped if:

- a) the ZONE LOCK INACTIVITY TIME LIMIT field is set to zero in an SMP ZONE LOCK request; or
- b) the ZONE LOCKED bit is set to zero in the SMP REPORT GENERAL response (e.g., an SMP ZONE UNLOCK request (see 10.4.3.23) is processed, or the zone lock inactivity timer expires).

If the zone lock inactivity timer expires then the zoning expander device:

- a) sets the ZONE LOCKED bit to zero in the SMP REPORT GENERAL response;
- b) sets the CONFIGURING bit to zero in the SMP REPORT GENERAL response; and
- c) sends Broadcast (Change) on all ports.

preface d) by:
if the zone configuring bit was set to one,

which is wording in 10.4.3.23 that is missing here. Then, delete the duplicate rule in 10.4.3.23

● Author: lsi-bbesmer
Subject: Highlight
Date: 5/6/2008 4:07:48 PM
T ACCEPT - DONE

configuration
s/b
zone configuration

● Author: RElliott
Subject: Highlight
Date: 6/30/2008 6:16:52 PM
T ACCEPT - DONE

successful
s/b
successful,

● Author: lsi-bbesmer
Subject: Highlight
Date: 5/25/2008 6:45:59 PM
T REJECT (that shall is in 4.9.2. Deleting this sentence per lsi-gpenokie comment, and dropping the word "mandatory" from the new wording)

is
s/b
shall be

● Author: lsi-gpenokie
Subject: Highlight
Date: 5/25/2008 6:30:03 PM
T ACCEPT - DONE (without "mandatory", which is already specified in 4.9.2)

This << The zone lock inactivity timer is supported by all zoning expander devices. The use of a timer ensures that if the zone manager disappears >> should be << The mandatory zone lock inactivity timer (see x.x.x) ensures that if the zone manager disappears >>

● Author: RElliott
Subject: Underline
Date: 6/30/2008 6:16:52 PM
T ACCEPT - DONE

CONFIGURING bit
s/b
ZONE CONFIGURING bit

new bit per lsi-bbesmer comment on first page

If the zone lock inactivity timer expires while the zoning expander device is processing an SMP configuration function then the zoning expander device may complete the request successfully or return a function result of ZONE LOCK VIOLATION.

4.9.6.7 Enable a zoning expander device

If a zoning expander device has the ZONING SUPPORTED bit set to one and the ZONING ENABLED bit set to zero in the REPORT GENERAL response (see 10.4.3.4), then a zone manager configures the zoning expander device using the zone configuration process. This ensures that the zone permission table is the same in all zoning expander devices inside the ZPSDS.

Changes made by the SMP ENABLE DISABLE ZONING function sent by the active zone manager become active during the activate step (see 4.9.6.4).

4.10 Phy test functions

The optional Protocol-Specific diagnostic page for SAS (see 10.2.9.2) provide methods for an application client to enable and disable a phy test function (e.g., transmission of the CJTPAT) for a selected phy in a SAS target device with an SSP target port. The optional SMP PHY TEST FUNCTION function (see 10.4.3.29) provides similar methods for expander devices and SAS target devices with SMP target ports.

The application client sends a SEND DIAGNOSTIC command with the Protocol-Specific diagnostic page or an SMP PHY TEST FUNCTION function specifying the phy in the SAS target device that is to perform the phy test function and the phy test function to be performed. If the phy test function requires a specific phy test pattern and/or phy test pattern physical link rate, then it also specifies the phy test pattern and phy test pattern physical link rate.

The SEND DIAGNOSTIC command may be sent through any SSP target port to any logical unit in the SAS target device that contains the phy that is to perform the phy test function.

For the SEND DIAGNOSTIC command, the phy shall begin the specified phy test function after the SSP target port receives an ACK for the RESPONSE frame transmitted in response to the SEND DIAGNOSTIC command that requested the phy test function. For the SMP PHY TEST FUNCTION function, the phy shall begin the specified phy test function after the SMP target port transmits the SMP response frame.

The phy test function on one phy may affect the previously negotiated settings on other phys (e.g., in a device with a common SSC clock, the SSC modulation type may change from none to down-spreading even on phys that negotiated no SSC).

Once a SAS phy has begun performing a phy test function, it shall ignore its receiver. To stop a SAS phy from performing a phy test function, an application client sends a SEND DIAGNOSTIC command or an SMP PHY TEST FUNCTION function to a SAS phy in the SAS target device that is not performing a phy test function, requesting a phy test function of 00h (i.e., STOP). If no such phy is available, the phy test function only stops on power loss.

4.11 Phy events

Phys shall count the following events using saturating counters and report them in the Protocol-Specific Port log page (see 10.2.8.1) and/or the SMP REPORT PHY ERROR LOG function (see 10.4.3.11):

- a) invalid dwords received;
- b) dwords received with running disparity errors;
- c) loss of dword synchronization; and
- d) phy reset problems.

NOTE 19 - This standard also defines wrapping counters that count those same events (see table 37).

The saturating counters are each up to 4 bytes wide.

Phys may also count certain events (e.g., elasticity buffer overflows) using wrapping counters and record peak values for certain events (e.g., the longest connection time) using peak value detectors, reporting them in the Protocol-Specific Port log page (see 10.2.8.1), SMP REPORT PHY EVENT function (see 10.4.3.14), and/or

Page: 116

Author: hpq-relliott
Subject: Note
Date: 5/6/2008 4:07:48 PM
 ACCEPT - DONE

Move 4.10 text into 4.10.1 Phy test functions overview, allowing room for subsections for each phy test function

Author: intc-mseidel
Subject: Highlight
Date: 5/6/2008 4:07:48 PM
 REJECT (but moot in rewrite)

"provide" in first sentence s/b "provides"

Author: lsi-gpenokie
Subject: Highlight
Date: 5/6/2008 4:07:48 PM
 REJECT (when added, people wanted to ensure that all this was clearly labeled optional. In the rewrite per hpq-relliott comment, this is simplified to a statement that "Each phy test function is optional.")

This << The optional Protocol-Specific diagnostic page >> should be << The Protocol-Specific diagnostic page >>

Author: hpq-relliott
Subject: Note
Date: 5/6/2008 4:07:48 PM
 ACCEPT - DONE

Replace 1st paragraph, first sentence of 2nd paragraph, 3rd paragraph, and 4th paragraph with:

Phy test functions (e.g., transmission of test patterns) are used for phy and interconnect characterization and diagnosis. The phy may be attached to test equipment while performing a phy test function. The following optional mechanisms are defined for invoking phy test functions:

a) the Protocol-Specific diagnostic page for SAS (see 10.2.9.1) invokes a phy test function in a selected phy other than the phy that receives the diagnostic page in a SAS target device with an SSP target port. The SEND DIAGNOSTIC command may be sent through any SSP target port to any logical unit in the SAS target device that contains the phy that is to perform the phy test function. The phy test function starts some time after the SSP target port receives an ACK for the RESPONSE frame transmitted in response to the SEND DIAGNOSTIC command; and

b) the SMP PHY TEST FUNCTION function (see 10.4.3.25) invokes a phy test function in a phy controlled by a management device server other than the phy that receives the function. The phy test function starts some time after the SMP target port transmits the SMP response frame.

Each phy test function is optional.

Author: lsi-gpenokie
Subject: Highlight
Date: 5/6/2008 4:07:48 PM
 REJECT (when added, people wanted to ensure that all this was clearly labeled optional. In the rewrite per hpq-relliott comment, this is simplified to a statement that "Each phy test function is optional.")

This << The optional SMP PHY TEST FUNCTION function >> should be << The SMP PHY TEST FUNCTION function >>

Author: wdc-mevans
Subject: Highlight
Date: 5/6/2008 4:07:48 PM
 REJECT - DONE

Comments from page 116 continued on next page

If the zone lock inactivity timer expires while the zoning expander device is processing an SMP configuration function then the zoning expander device may complete the request successfully or return a function result of ZONE LOCK VIOLATION.

4.9.6.7 Enable a zoning expander device

If a zoning expander device has the ZONING SUPPORTED bit set to one and the ZONING ENABLED bit set to zero in the REPORT GENERAL response (see 10.4.3.4), then a zone manager configures the zoning expander device using the zone configuration process. This ensures that the zone permission table is the same in all zoning expander devices inside the ZPSDS.

Changes made by the SMP ENABLE DISABLE ZONING function sent by the active zone manager become active during the activate step (see 4.9.6.4).

4.10 Phy test functions

The optional Protocol-Specific diagnostic page for SAS (see 10.2.9.2) provide methods for an application client to enable and disable a phy test function (e.g., transmission of the CJTPAT) for a selected phy in a SAS target device with an SSP target port. The optional SMP PHY TEST FUNCTION function (see 10.4.3.29) provides similar methods for expander devices and SAS target devices with SMP target ports.

The application client sends a SEND DIAGNOSTIC command with the Protocol-Specific diagnostic page or an SMP PHY TEST FUNCTION function specifying the phy in the SAS target device that is to perform the phy test function and the phy test function to be performed. If the phy test function requires a specific phy test pattern and/or phy test pattern physical link rate, then it also specifies the phy test pattern and phy test pattern physical link rate.

The SEND DIAGNOSTIC command may be sent through any SSP target port to any logical unit in the SAS target device that contains the phy that is to perform the phy test function.

For the SEND DIAGNOSTIC command, the phy shall begin the specified phy test function after the SSP target port receives an ACK for the RESPONSE frame transmitted in response to the SEND DIAGNOSTIC command that requested the phy test function. For the SMP PHY TEST FUNCTION function, the phy shall begin the specified phy test function after the SMP target port transmits the SMP response frame.

The phy test function on one phy may affect the previously negotiated settings on other phys (e.g., in a device with a common SSC clock, the SSC modulation type may change from none to down-spreading even on phys that negotiated no SSC).

Once a SAS phy has begun performing a phy test function, it shall ignore its receiver. To stop a SAS phy from performing a phy test function, an application client sends a SEND DIAGNOSTIC command or an SMP PHY TEST FUNCTION function to a SAS phy in the SAS target device that is not performing a phy test function requesting a phy test function of 00h (i.e., STOP). If no such phy is available, the phy test function only stops on power loss.

4.11 Phy events

Phys shall count the following events using saturating counters and report them in the Protocol-Specific Port log page (see 10.2.8.1) and/or the SMP REPORT PHY ERROR LOG function (see 10.4.3.11):

- a) invalid dwords received;
- b) dwords received with running disparity errors;
- c) loss of dword synchronization; and
- d) phy reset problems.

NOTE 19 - This standard also defines wrapping counters that count those same events (see table 37).

The saturating counters are each up to 4 bytes wide.

Phys may also count certain events (e.g., elasticity buffer overflows) using wrapping counters and record peak values for certain events (e.g., the longest connection time) using peak value detectors, reporting them in the Protocol-Specific Port log page (see 10.2.8.1), SMP REPORT PHY EVENT function (see 10.4.3.14), and/or

command
s/b
command (see SPC-4)

Author: hpq-relliott
Subject: Note
Date: 6/4/2008 1:28:55 PM
 ACCEPT - DONE

Create 4.10.2 Transmit pattern phy test function containing:

4.10.2 Transmit pattern phy test function

While a phy is performing the transmit pattern phy test function, the test equipment attached to that phy:

- a) shall not transmit COMSAS or COMWAKE; and
- b) shall not transmit COMINIT except to stop the phy test function.

While performing the transmit pattern phy test function, a phy:

- a) shall ignore all dwords received; and
- b) shall repeatedly transmit the specified pattern at the specified physical link rate.

Author: wdc-meavans
Subject: Highlight
Date: 6/4/2008 4:40:17 PM
 REJECT (changed to "the mechanism for invoking the phy test function" instead)

it
s/b
the application client

Author: intc-mseidel
Subject: Highlight
Date: 8/29/2008 2:40:13 PM
 REJECT (Other changes have embedded this text inside an a)b) list, making it look less like a generic statement about processing the SEND DIAGNOSTIC command. It is worded passively as "The phy test function starts some time after the SSP target port receives the ACK...". I don't think that will mislead anyone into thinking the test function invocation would bypass normal SCSI command processing rules)

7/14 clarify that this only applies if GOOD status is being returned. The phy test function is not going to run if CHECK CONDITION is returned. Same for SMP - only function results of 00h mean the test function is beginning.)

5/5 mixing SCSI commands and SMP functions in this comment. Is this comment is asking about how unsupported SMP functions are handled? Or is the wording about starting the function after the ACK too broad, and need to say "command is successful". Probably the latter...)

If a phy does not support SEND DIAGNOSTIC function, then how does it respond? It is supposed to send a function result of UNKNOWN PHY TEST FUNCTION in the RESPONSE frame. But if it sends a RESPONSE frame and then gets an ACK, it "shall begin the specified phy test function".

The wording should be clarified here and in 10.4.3.29. The same is true for the wording concerned with the SMP PHY TEST FUNCTION.

Author: hpq-relliott
Subject: Highlight
Date: 5/25/2008 6:32:44 PM
 ACCEPT - DONE (5/5 WG ok with concept)

To stop a SAS phy from performing a phy test function, an application client sends a SEND DIAGNOSTIC command or an SMP PHY TEST FUNCTION function to a SAS phy in the SAS target device that is not performing a phy test function requesting a phy test function of 00h (i.e., STOP). If no such phy is available, the phy test function only stops on power loss.

Comments from page 116 continued on next page

If the zone lock inactivity timer expires while the zoning expander device is processing an SMP configuration function then the zoning expander device may complete the request successfully or return a function result of ZONE LOCK VIOLATION.

4.9.6.7 Enable a zoning expander device

If a zoning expander device has the ZONING SUPPORTED bit set to one and the ZONING ENABLED bit set to zero in the REPORT GENERAL response (see 10.4.3.4), then a zone manager configures the zoning expander device using the zone configuration process. This ensures that the zone permission table is the same in all zoning expander devices inside the ZPSDS.

Changes made by the SMP ENABLE DISABLE ZONING function sent by the active zone manager become active during the activate step (see 4.9.6.4).

4.10 Phy test functions

The optional Protocol-Specific diagnostic page for SAS (see 10.2.9.2) provide methods for an application client to enable and disable a phy test function (e.g., transmission of the CJTPAT) for a selected phy in a SAS target device with an SSP target port. The optional SMP PHY TEST FUNCTION function (see 10.4.3.29) provides similar methods for expander devices and SAS target devices with SMP target ports.

The application client sends a SEND DIAGNOSTIC command with the Protocol-Specific diagnostic page or an SMP PHY TEST FUNCTION function specifying the phy in the SAS target device that is to perform the phy test function and the phy test function to be performed. If the phy test function requires a specific phy test pattern and/or phy test pattern physical link rate, then it also specifies the phy test pattern and phy test pattern physical link rate.

The SEND DIAGNOSTIC command may be sent through any SSP target port to any logical unit in the SAS target device that contains the phy that is to perform the phy test function.

For the SEND DIAGNOSTIC command, the phy shall begin the specified phy test function after the SSP target port receives an ACK for the RESPONSE frame transmitted in response to the SEND DIAGNOSTIC command that requested the phy test function. For the SMP PHY TEST FUNCTION function, the phy shall begin the specified phy test function after the SMP target port transmits the SMP response frame.

The phy test function on one phy may affect the previously negotiated settings on other phys (e.g., in a device with a common SSC clock, the SSC modulation type may change from none to down-spreading even on phys that negotiated no SSC).

Once a SAS phy has begun performing a phy test function, it shall ignore its receiver. To stop a SAS phy from performing a phy test function, an application client sends a SEND DIAGNOSTIC command or an SMP PHY TEST FUNCTION function to a SAS phy in the SAS target device that is not performing a phy test function requesting a phy test function of 00h (i.e., STOP). If no such phy is available, the phy test function only stops on power loss.

4.11 Phy events

Phys shall count the following events using saturating counters and report them in the Protocol-Specific Port log page (see 10.2.8.1) and/or the SMP REPORT PHY ERROR LOG function (see 10.4.3.11):

- a) invalid dwords received;
- b) dwords received with running disparity errors;
- c) loss of dword synchronization; and
- d) phy reset problems.

NOTE 19 - This standard also defines wrapping counters that count those same events (see table 37).

The saturating counters are each up to 4 bytes wide.

Phys may also count certain events (e.g., elasticity buffer overflows) using wrapping counters and record peak values for certain events (e.g., the longest connection time) using peak value detectors, reporting them in the Protocol-Specific Port log page (see 10.2.8.1), SMP REPORT PHY EVENT function (see 10.4.3.14), and/or

s/b

A phy stops performing a phy test function:

- a) after the SCSI device server, if any, processes a Protocol-Specific diagnostic page specifying the phy and specifying a phy test function of 00h (i.e., STOP);
- b) after the management device serve, if any, processes an SMP PHY TEST FUNCTION request specifying the phy and specifying a phy test function of 00h (i.e., STOP);
- c) after the phy receives COMINIT; or
- d) upon power off.

It is vendor-specific how long a phy takes to stop performing the phy test function. After a phy stops performing a phy test function, it performs a link reset sequence.

[the technical change here is adding COMINIT. That could be deferred to SAS-2.1]

Author: hpq-relliott
Subject: Highlight
Date: 7/14/2008 7:28:03 PM

T ACCEPT - DONE

Once a SAS phy has begun performing a phy test function, it shall ignore its receiver.

s/b

While a phy is performing a phy test function, the link layer receivers (i.e., the SL_IR receiver, SL receiver, SSP receiver, STP receiver, and SMP receiver) shall ignore all incoming dwords and the OOB signal detector shall detect COMINIT. The phy shall ignore any other OOB signals (i.e., COMSAS and COMWAKE).

[the technical change here is honoring COMINIT. That could be deferred to SAS-2.1]

Author: RElliott
Subject: Highlight
Date: 6/30/2008 6:16:52 PM

T REJECT (moot as the note was deleted per another comment)

fix font in "events (see table 37)."

Author: lsi-gpenokie
Subject: Highlight
Date: 6/4/2008 4:42:07 PM

T REJECT (but deleted the note, and changed the first sentence 2 paragraphs down to "Phys may count those events and certain other events...")

Remove note and change to << See tgable xx for a definition of wrapping counters that count those same events. >>

Author: wdc-mevans
Subject: Highlight
Date: 5/6/2008 4:07:48 PM

T REJECT

them

s/b

the events and peak values

the SMP REPORT PHY EVENT LIST function (see 10.4.3.16). The wrapping counters and peak value detectors are each 4 bytes wide. Peak value detectors trigger Broadcast (Expander) under certain circumstances (see 7.2.6.4).

For phys not controlled by SMP target ports, the number of additional events monitored and which events to monitor is vendor-specific.

For phys controlled by SMP target ports, the number of additional events that are simultaneously monitored is vendor-specific, but the SMP CONFIGURE PHY EVENT function (see 10.4.3.30) allows the events to count/record to be specified.

The management device server shall maintain phy events for the last vendor-specific number of events and should maintain at least one phy event per phy. The management device server shall assign descriptors to the events sequentially starting at 0001h and shall return the descriptors in the SMP REPORT PHY EVENT LIST response (see 10.4.3.16). The management device server shall return the index of the descriptor for the last phy event in the SMP REPORT GENERAL response (see 10.4.3.4), the SMP REPORT PHY EVENT LIST response (see 10.4.3.16), and the SMP DISCOVER LIST response (see 10.4.3.15). The management device server shall wrap the index to 0001h when the highest supported descriptor index has been used.

The management device server shall support phy event list descriptor (see 10.4.3.16.4) indexes from 0001h to FFFFh. The actual number of phy event list descriptors that the management device server maintains for retrieval with the REPORT PHY EVENT LIST request is vendor specific and is indicated by the MAXIMUM NUMBER OF STORED PHY EVENT LIST DESCRIPTORS field defined in the REPORT GENERAL response (see 10.4.3.4). The volatility of these stored descriptors is vendor specific. The management device server shall replace the least recently recorded phy event list descriptor with a new one once the number of recorded descriptors exceeds the value indicated by the MAXIMUM NUMBER OF STORED PHY EVENT LIST DESCRIPTORS field.

The PHY EVENT SOURCE field, defined in table 37, is used in the Protocol-Specific Port log page (see 10.2.8.1), the REPORT PHY EVENT function (see 10.4.3.14), the REPORT PHY EVENT LIST function (see 10.4.3.16), and the CONFIGURE PHY EVENT function (see 10.4.3.30) and indicates or specifies the type of phy event in the accompanying PHY EVENT field.

Table 37 — PHY EVENT SOURCE field (part 1 of 4)

Code	Name	Type ^a	Description
00h	No event	N/A	No event. The PHY EVENT field is not valid.
01h	Invalid dword count ^b	WC	Number of invalid dwords (see 3.1.114) that have been received outside of phy reset sequences (i.e., between when the SP state machine (see 6.8) sends a Phy Layer Ready (SAS) confirmation or Phy Layer Ready (SATA) confirmation and when it sends a Phy Layer Not Ready confirmation to the link layer).
02h	Running disparity error count ^b	WC	Number of dwords containing running disparity errors (see 6.2) that have been received outside of phy reset sequences.
03h	Loss of dword synchronization count ^b	WC	Number of times the phy has restarted the link reset sequence because it lost dword synchronization (i.e., the SP state machine transitioned from SP15:SAS_PHY_Ready or SP22:SATA_PHY_Ready to SP0:OOB_COMINIT (see 6.8)).
04h	Phy reset problem count ^b	WC	Number of times a phy reset problem has occurred (see 6.7.4.2.4).
^a The Type column indicates the source type: a) WC = wrapping counter; b) PVD = peak value detector; and c) N/A = not applicable. ^b This standard also defines a saturating counter that counts this event (see 10.2.8.1 and 10.4.3.11).			

Page: 117

● Author: elx-bmartin
Subject: Sticky Note
Date: 8/31/2008 6:40:29 PM

☞ ACCEPT - DONE (7/14 this would help clarify the other elx-bmartin comment, so add it.)

add the following sentence:

"Phy events on all logical phys within a phy shall be counted in a single counter associated with the phy."

● Author: lsi-gpenokie
Subject: Highlight
Date: 6/9/2008 4:18:49 PM

T ACCEPT - DONE (as "allows for specification of the events to monitor.")

I cannot parse this so it makes any sense << but the SMP CONFIGURE PHY EVENT function (see 10.4.3.30) allows the events to count/record to be specified.>> this needs to be fixed and the << / >> removed.

● Author: wdc-mevans
Subject: Highlight
Date: 5/17/2008 5:28:28 PM

T REJECT (some of them count, some of them record peaks)

count/record
s/b
count and record

● Author: wdc-mevans
Subject: Highlight
Date: 6/9/2008 4:16:27 PM

T ACCEPT - DONE (also one other place; comment added)

least recently recorded
s/b
oldest

● Author: elx-bmartin
Subject: Comment on Text
Date: 7/14/2008 7:17:38 PM

T REJECT (7/14 all counters are physical. There is no way to inquire about a specific logical phy's count, since they don't have phy identifiers.)

This table should have one additional field to indicate whether a phy event is on a logical phy or a physical phy. 01h through 04h are definitely physical phy based and 06h and above are definitely logical phy based. 05h is the only one that is difficult to determine which layer it belongs in.

● Author: lsi-bbesmer
Subject: Note
Date: 5/25/2008 6:33:23 PM

☞ ACCEPT - DONE (shaded labeled subsections added for each region)

Split this table into sections similar to Table 242 on page 554.

● Author: RElliott
Subject: Underline
Date: 6/30/2008 6:16:52 PM

T ACCEPT - DONE

(see 6.2)

point to new RD section

Comments from page 117 continued on next page

the SMP REPORT PHY EVENT LIST function (see 10.4.3.16). The wrapping counters and peak value detectors are each 4 bytes wide. Peak value detectors trigger Broadcast (Expander) under certain circumstances (see 7.2.6.4).

For phys not controlled by SMP target ports, the number of additional events monitored and which events to monitor is vendor-specific.

For phys controlled by SMP target ports, the number of additional events that are simultaneously monitored is vendor-specific, but the SMP CONFIGURE PHY EVENT function (see 10.4.3.30) allows the events to count/record to be specified.

The management device server shall maintain phy events for the last vendor-specific number of events and should maintain at least one phy event per phy. The management device server shall assign descriptors to the events sequentially starting at 0001h and shall return the descriptors in the SMP REPORT PHY EVENT LIST response (see 10.4.3.16). The management device server shall return the index of the descriptor for the last phy event in the SMP REPORT GENERAL response (see 10.4.3.4), the SMP REPORT PHY EVENT LIST response (see 10.4.3.16), and the SMP DISCOVER LIST response (see 10.4.3.15). The management device server shall wrap the index to 0001h when the highest supported descriptor index has been used.

The management device server shall support phy event list descriptor (see 10.4.3.16.4) indexes from 0001h to FFFFh. The actual number of phy event list descriptors that the management device server maintains for retrieval with the REPORT PHY EVENT LIST request is vendor specific and is indicated by the MAXIMUM NUMBER OF STORED PHY EVENT LIST DESCRIPTORS field defined in the REPORT GENERAL response (see 10.4.3.4). The volatility of these stored descriptors is vendor specific. The management device server shall replace the least recently recorded phy event list descriptor with a new one once the number of recorded descriptors exceeds the value indicated by the MAXIMUM NUMBER OF STORED PHY EVENT LIST DESCRIPTORS field.

The PHY EVENT SOURCE field, defined in table 37, is used in the Protocol-Specific Port log page (see 10.2.8.1), the REPORT PHY EVENT function (see 10.4.3.14), the REPORT PHY EVENT LIST function (see 10.4.3.16), and the CONFIGURE PHY EVENT function (see 10.4.3.30) and indicates or specifies the type of phy event in the accompanying PHY EVENT field.

Table 37 — PHY EVENT SOURCE field (part 1 of 4)

Code	Name	Type ^a	Description
00h	No event	N/A	No event. The PHY EVENT field is not valid.
01h	Invalid dword count ^b	WC	Number of invalid dwords (see 3.1.114) that have been received outside of phy reset sequences (i.e., between when the SP state machine (see 6.8) sends a Phy Layer Ready (SAS) confirmation or Phy Layer Ready (SATA) confirmation and when it sends a Phy Layer Not Ready confirmation to the link layer).
02h	Running disparity error count ^b	WC	Number of dwords containing running disparity errors (see 6.2) that have been received outside of phy reset sequences.
03h	Loss of dword synchronization count ^b	WC	Number of times the phy has restarted the link reset sequence because it lost dword synchronization (i.e., the SP state machine transitioned from SP15:SAS_PHY_Ready or SP12:SATA_PHY_Ready to SP0:OOB_COMINIT (see 6.8)).
04h	Phy reset problem count ^b	WC	Number of times a phy reset problem has occurred (see 6.7.4.2.4).
^a The Type column indicates the source type: a) WC = wrapping counter; b) PVD = peak value detector; and c) N/A = not applicable. ^b This standard also defines a saturating counter that counts this event (see 10.2.8.1 and 10.4.3.11).			

Author: stx-ghoulder

Subject: Highlight

Date: 5/25/2008 6:33:38 PM

TREJECT (abbreviations only used within one table are not normally added to 3.2; the table footnote, which repeats on each page, is supposed to suffice)

WC = wrapping counter;

b) PVD = peak value detector; and

The WC and PVD abbreviations should be added to clause 3.2.

Table 37 — PHY EVENT SOURCE field (part 2 of 4)

Code	Name	Type ^a	Description
05h	Elasticity buffer overflow count	WC	Number of times the phy's elasticity buffer (see 7.3) has overflowed outside of phy reset sequences (e.g., because it did not receive a sufficient number of deletable primitives).
06h	Received ERROR count	WC	Number of times the phy received an ERROR primitive.
07h - 1Fh	Reserved for phy layer-based phy events		
20h	Received address frame error count	WC	Number of times the phy detected an invalid address frame (see 7.8) (e.g., because of a CRC error).
21h	Transmitted abandon-class OPEN_REJECT count	WC	Number of times the phy received an OPEN address frame and transmitted an abandon-class OPEN_REJECT (see 7.2.6.10). In expander devices, forwarded OPEN_REJECTs shall not be counted.
22h	Received abandon-class OPEN_REJECT count	WC	Number of times the phy originated an OPEN address frame and received an abandon-class OPEN_REJECT (see 7.2.6.10). In expander devices, OPEN_REJECTs in response to forwarded OPEN address frames shall not be counted.
23h	Transmitted retry-class OPEN_REJECT count	WC	Number of times the phy received an OPEN address frame and transmitted a retry-class OPEN_REJECT (see 7.2.6.10). In expander devices, forwarded OPEN_REJECTs shall not be counted.
24h	Received retry-class OPEN_REJECT count	WC	Number of times the phy originated an OPEN address frame and received a retry-class OPEN_REJECT (see 7.2.6.10). In expander devices, OPEN_REJECTs in response to forwarded OPEN address frames shall not be counted.
25h	Received AIP (WAITING ON PARTIAL) count	WC	Number of times the phy received an AIP (WAITING ON PARTIAL) or AIP (RESERVED WAITING ON PARTIAL). In expander devices, forwarded AIPs shall be counted.
26h	Received AIP (WAITING ON CONNECTION) count	WC	Number of times the phy received an AIP (WAITING ON CONNECTION). In expander devices, forwarded AIPs shall be counted.
27h	Transmitted BREAK count	WC	Number of times the phy transmitted a BREAK that was not a response to a BREAK it received (e.g., a Close Timeout was detected by the SL state machine interfacing to the SMP target port).
28h	Received BREAK count	WC	Number of times the phy received a BREAK that was not a response to a BREAK that it transmitted.
29h	Break Timeout count	WC	Number of times the phy transmitted a BREAK and did not receive a BREAK or BREAK_REPLY in response (e.g., as detected by the XL state machine and/or the SL state machine interfacing to the SMP target port).
<p>^a The Type column indicates the source type:</p> <p>a) WC = wrapping counter;</p> <p>b) PVD = peak value detector; and</p> <p>c) N/A = not applicable.</p> <p>^b This standard also defines a saturating counter that counts this event (see 10.2.8.1 and 10.4.3.11).</p>			

● Author: Isi-gpenokie
Subject: Cross-Out
Date: 5/6/2008 4:07:48 PM
T REJECT

Don't need this word.

● Author: Isi-gpenokie
Subject: Highlight
Date: 5/25/2008 6:33:47 PM
T REJECT (nothing wrong with "because")

Change to << as a result of >>

● Author: RElliott
Subject: Highlight
Date: 6/30/2008 6:16:52 PM
T ACCEPT - DONE

SL state machine
s/b
SL state machines

● Author: RElliott
Subject: Highlight
Date: 6/30/2008 6:16:52 PM
T ACCEPT - DONE

SL state machine
s/b
SL state machines

Table 37 — PHY EVENT SOURCE field (part 3 of 4)

Code	Name	Type ^a	Description
2Ah	Connection count	WC	Number of connections in which the phy was involved.
2Bh	Peak transmitted pathway blocked count	PVD	Peak value of a PATHWAY BLOCKED COUNT field in an OPEN address frame transmitted by the phy. Since the maximum value of the PATHWAY BLOCKED COUNT field is FFh, only byte 3 of the PHY EVENT field is used.
2Ch	Peak transmitted arbitration wait time	PVD	Peak value of an ARBITRATION WAIT TIME field in an OPEN address frame transmitted by the phy. Since the maximum value of the ARBITRATION WAIT TIME field is FFFFh, only bytes 2 and 3 of the PHY EVENT field are used.
2Dh	Peak arbitration time	PVD	Peak time in microseconds after transmitting an OPEN address frame that the phy has waited for connection response (e.g., OPEN_ACCEPT or OPEN_REJECT).
2Eh	Peak connection time	PVD	The peak duration, in microseconds, of any connection in which the phy was involved.
2Fh - 3Fh	Reserved for SAS arbitration-related phy information		
40h	Transmitted SSP frame count	WC	Number of SSP frames transmitted.
41h	Received SSP frame count	WC	Number of SSP frames received.
42h	Transmitted SSP frame error count	WC	Number of times the phy was used in a connection involving the SSP target port, transmitted an SSP frame, and received a NAK or an ACK/NAK timeout.
43h	Received SSP frame error count	WC	Number of times the phy was used in a connection involving the SSP target port, detected an invalid SSP frame, and transmitted a NAK (CRC ERROR) (e.g., because of a CRC error).
44h	Transmitted CREDIT_BLOCKED count	WC	Number of times the phy transmitted a CREDIT_BLOCKED.
45h	Received CREDIT_BLOCKED count	WC	Number of times the phy received a CREDIT_BLOCKED.
46h - 4Fh	Reserved for SSP-related phy events		
50h	Transmitted SATA frame count	WC	Number of STP or SATA frames transmitted.
51h	Received SATA frame count	WC	Number of STP or SATA frames received.
^a The Type column indicates the source type: a) WC = wrapping counter; b) PVD = peak value detector; and c) N/A = not applicable. ^b This standard also defines a saturating counter that counts this event (see 10.2.8.1 and 10.4.3.11).			

● Author: Isi-gpenokie
Subject: Highlight
Date: 5/25/2008 6:34:09 PM
T ACCEPT - DONE

This << only bytes 2 and 3 of the PHY EVENT field are used >> should be << only byte 2 and byte 3 of the PHY EVENT field are used >>

● Author: Isi-gpenokie
Subject: Highlight
Date: 5/6/2008 4:07:48 PM
T REJECT (nothing wrong with "because")

Change to << as a result of >>

Table 37 — PHY EVENT SOURCE field (part 4 of 4)

Code	Name	Type ^a	Description
52h	SATA flow control buffer overflow count	WC	Number of times the phy's STP flow control buffer (see 7.17.2) has overflowed (e.g., because it received more data dwords than allowed after transmitting SATA_HOLD during an STP connection). In an expander device, this count should be maintained in the expander phy transmitting the SATA_HOLD and receiving the data dwords, but may be maintained in the expander phy receiving the SATA_HOLD and transmitting the data dwords.
53h - 5Fh	Reserved for STP and SATA-related phy events		
60h	Transmitted SMP frame count	WC	Number of SMP frames transmitted.
61h	Received SMP frame count	WC	Number of SMP frames received.
62h	Reserved for SMP-related phy events		
63h	Received SMP frame error count	WC	Number of times the phy was used to access the SMP target port and the SMP target port detected an invalid SMP frame and transmitted a BREAK (e.g., because of a CRC error).
64h - 6Fh	Reserved for SMP-related phy events		
70h - CFh	Reserved		
D0h - FFh	Vendor specific		
^a The Type column indicates the source type: a) WC = wrapping counter; b) PVD = peak value detector; and c) N/A = not applicable. ^b This standard also defines a saturating counter that counts this event (see 10.2.8.1 and 10.4.3.11).			

● Author: Isi-gpenokie
Subject: Cross-Out
Date: 5/6/2008 4:07:48 PM

 REJECT

Don't need this word.

● Author: Isi-gpenokie
Subject: Highlight
Date: 5/6/2008 4:07:48 PM

 REJECT (nothing wrong with "because")

Change to << as a result of >>

5 Physical layer

5.1 Physical layer overview

The physical layer defines:

- passive interconnect (e.g., connectors and cable assemblies); and
- transmitter and receiver device electrical characteristics.

Within this standard, references to connector gender use the terms plug and receptacle as equivalent to the terms free and fixed, respectively, that may be used in the references that define the connectors. Fixed and free terminology has no relationship to the application of the connector.

5.2 Passive interconnect

5.2.1 SATA connectors and cable assemblies

Figure 58 shows a schematic representation of the connectors and cables defined by SATA (see SATA-2). A SATA host is analogous to a SAS initiator device and a SATA device is analogous to a SAS target device.

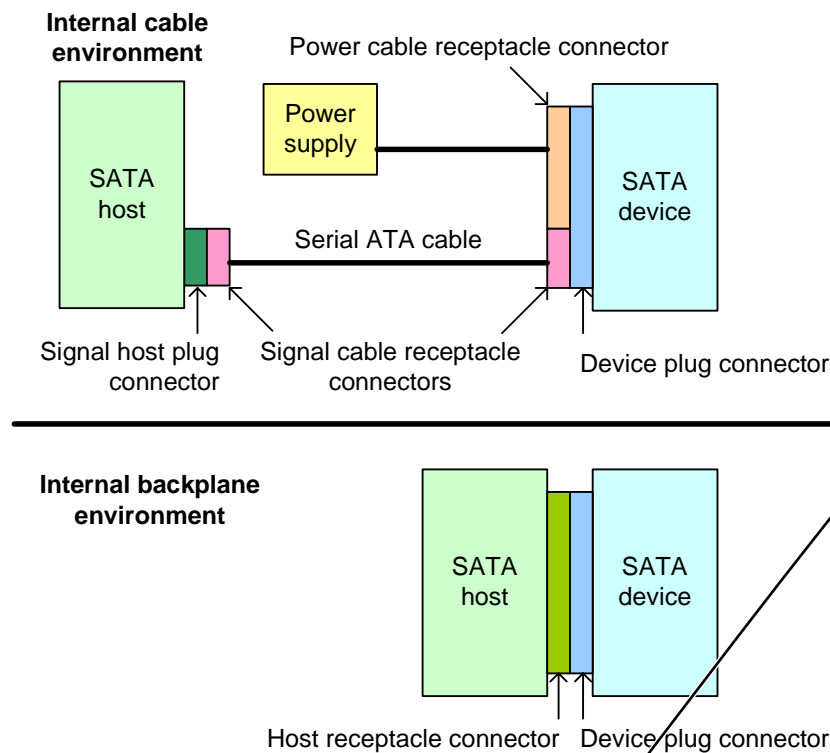

Figure 58 — SATA connectors and cables

5.2.2 SAS connectors and cables

This standard defines SAS Drive cable, SAS Drive backplane, SAS internal cable, and SAS external cable environments.

Author: ibm-ted-vojnovich

Subject: Note

Date: 8/31/2008 6:47:20 PM

ACCEPT - TODO (Jay Neer's 08-322 adds a key to prevent a 10 m Mini SAS 4x cable from being plugged into a SAS-1.1 Mini SAS 4x receptacle, which will solve this problem. The 8x connectors in SAS-2.1 will have adequate sideband signals for the system to detect that an incompatible cable was attached; for the Mini SAS 4x connectors, which have no sidebands, keys are the best alternative.)

Section 5: Lots of good math there. However, I am concerned about the following scenario: Somebody has a SAS 1.1 device (disk for example) and uses a SAS 2.0 cable (I understand that SAS supports up to 10M while SAS 1.1 supports 5M). If the distance limit for SAS 2.0 is longer than SAS 1.1, how does the system behave (I would think SAS 1.1 transceiver would have a hard time working with a cable that is farther in distance). I may be off base here (have not watched the analog side that closely) but would think there needs some way to help the admin trouble shoot this (connector/cable color matching, some impedance sensing, etc). Should that not be specified in the std?

Author: wdc-mevans

Subject: Highlight

Date: 5/6/2008 4:07:48 PM

TREJECT (these are only used for targets, not initiators. In SCSI speak, "device" includes both initiators and targets, so calling it a "device" connector would imply that SAS initiators might use this connector. That is different from ATA, where "device" means target and "host" means initiator (there is no global term covering both ATA device & host). I think STA recommended the name and capitalization "SAS Drive" back in the SAS-1 era.)

Global

SAS Drive cable, SAS Drive backplane,

s/b

SAS device cable, SAS device backplane

[These terms came into the SAS 1.1 standard during the letter ballot process, rev 09c to be exact. I'm not aware of:

a) why this became "Drive" in the first place; and

b) the rationale for calling these "Drive" -- especially capitalized -- when none of the other related terms are capitalized.

These terms -- especially SAS Drive backplane receptacle are counter intuitive. My recommended change is consistent with standard SCSI naming conventions.]

Figure 59 shows a schematic representation of the SAS Drive cable environments.

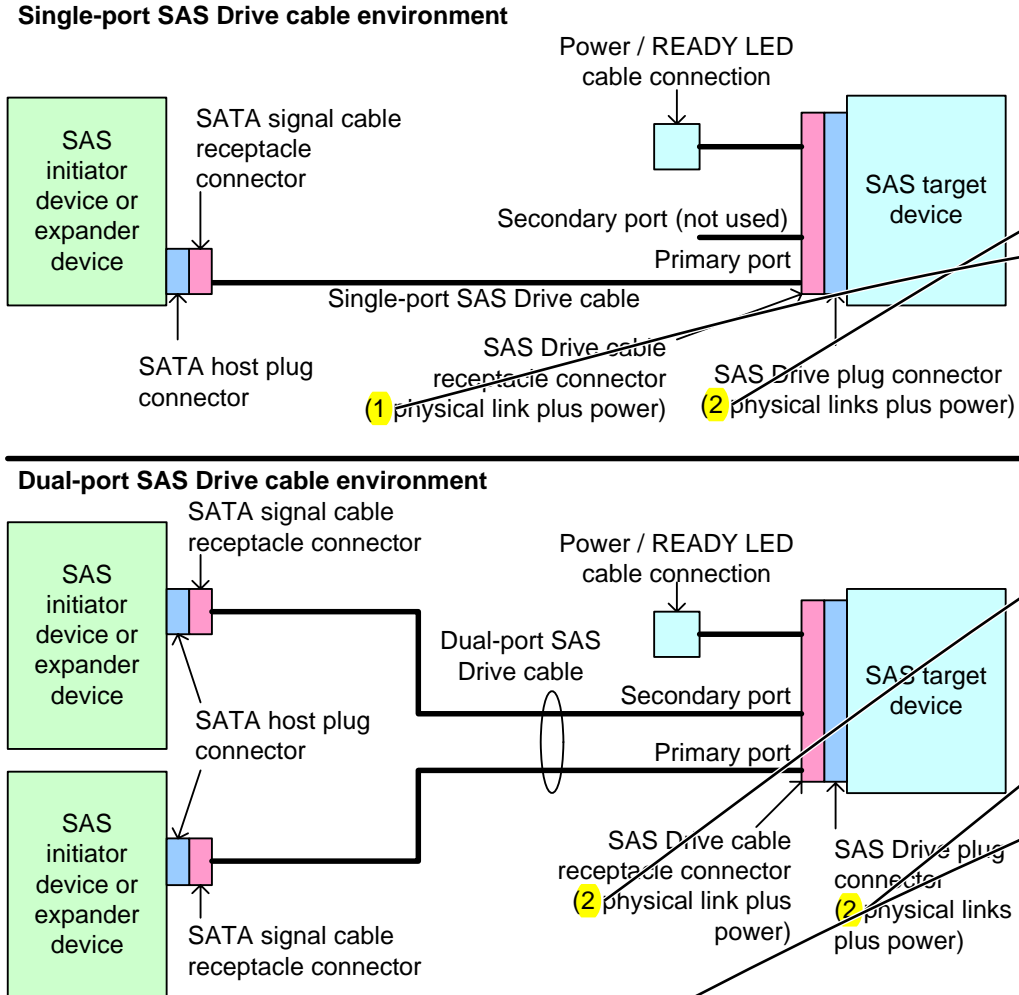

Figure 59 — SAS Drive cable environments

Figure 60 shows a schematic representation of the SAS Drive backplane environment.

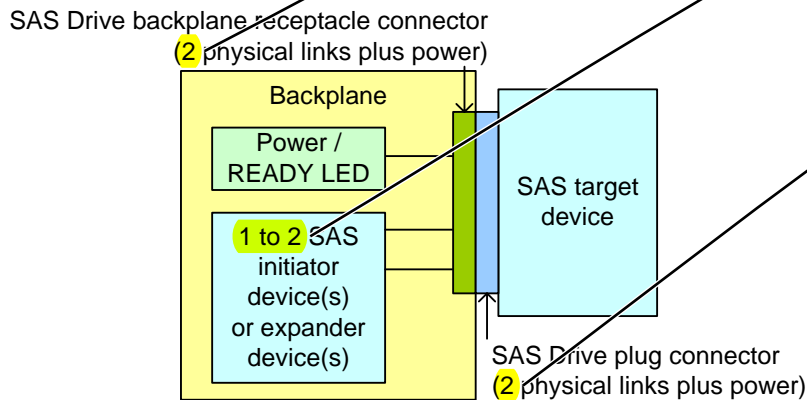

Figure 60 — SAS Drive backplane environment

● Author: Isi-gpenokie
Subject: Highlight
Date: 5/6/2008 4:07:48 PM
T REJECT
Change to << two >>

● Author: Isi-gpenokie
Subject: Highlight
Date: 5/6/2008 4:07:48 PM
T REJECT
Change to << one >>

● Author: Isi-gpenokie
Subject: Highlight
Date: 5/6/2008 4:07:48 PM
T REJECT
Change to << two >>

● Author: Isi-gpenokie
Subject: Highlight
Date: 5/6/2008 4:07:48 PM
T REJECT
Change to << two >>

● Author: Isi-gpenokie
Subject: Highlight
Date: 5/6/2008 4:07:48 PM
T REJECT
Change to << two >>

● Author: Isi-gpenokie
Subject: Highlight
Date: 5/6/2008 4:07:48 PM
T REJECT
Change to << one or two >>

● Author: Isi-gpenokie
Subject: Highlight
Date: 5/6/2008 4:07:48 PM
T REJECT
Change to << two >>

Figure 61 shows a schematic representation of the SAS external cable environment.

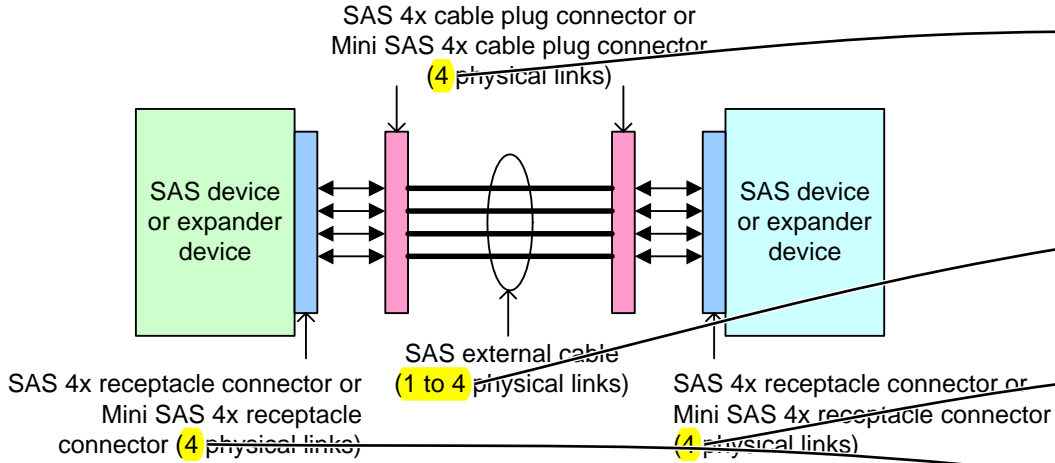

Figure 61 — SAS external cable environment

Figure 62 shows a schematic representation of the SAS internal cable environment attaching a controller to a backplane using a SAS internal symmetric cable.

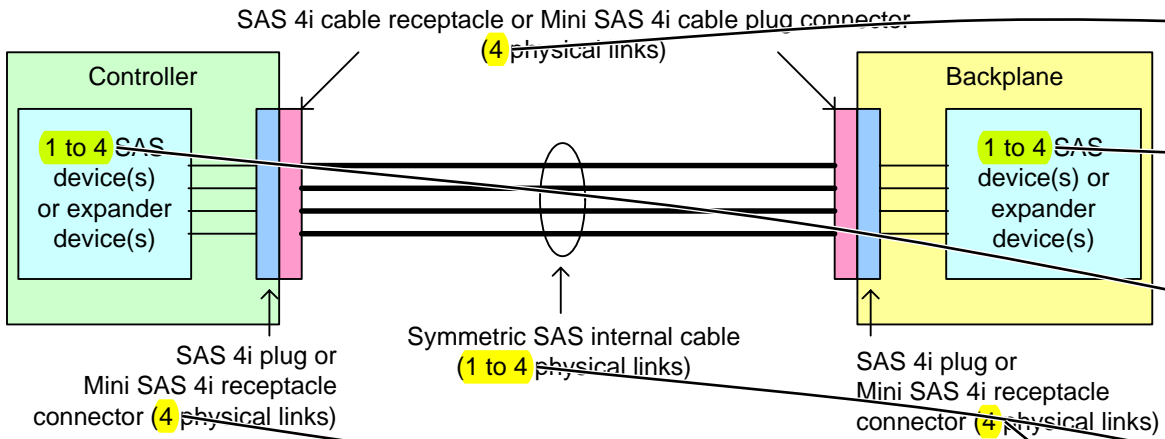

Figure 62 — SAS internal symmetric cable environment - controller to backplane

A SAS internal symmetric cable provides one to four physical links, and may be used as any combination of wide links and narrow links (see 4.1.4) using those physical links.

● Author: Isi-gpenokie
Subject: Highlight
Date: 5/6/2008 4:07:48 PM
T REJECT
Change to << four >>

● Author: Isi-gpenokie
Subject: Highlight
Date: 5/6/2008 4:07:48 PM
T REJECT
Change to << one to four >>

● Author: Isi-gpenokie
Subject: Highlight
Date: 5/6/2008 4:07:48 PM
T REJECT
Change to << four >>

● Author: Isi-gpenokie
Subject: Highlight
Date: 5/6/2008 4:07:48 PM
T REJECT
Change to << four >>

● Author: Isi-gpenokie
Subject: Highlight
Date: 5/6/2008 4:07:48 PM
T REJECT
Change to << four >>

● Author: Isi-gpenokie
Subject: Highlight
Date: 5/6/2008 4:07:48 PM
T REJECT
Change to << one to four >>

● Author: Isi-gpenokie
Subject: Highlight
Date: 5/6/2008 4:07:48 PM
T REJECT
Change to << one to four >>

● Author: Isi-gpenokie
Subject: Highlight
Date: 5/6/2008 4:07:48 PM
T REJECT
Change to << one to four >>

● Author: Isi-gpenokie
Subject: Highlight
Date: 5/6/2008 4:07:48 PM
T REJECT
Change to << four >>

● Author: Isi-gpenokie
Subject: Highlight
Date: 5/6/2008 4:07:48 PM
T REJECT
Change to << four >>

Figure 63 shows a schematic representation of the SAS internal cable environment attaching a controller to a controller using a SAS internal symmetric cable. Two controllers may also be attached together with a SAS internal symmetric cable.

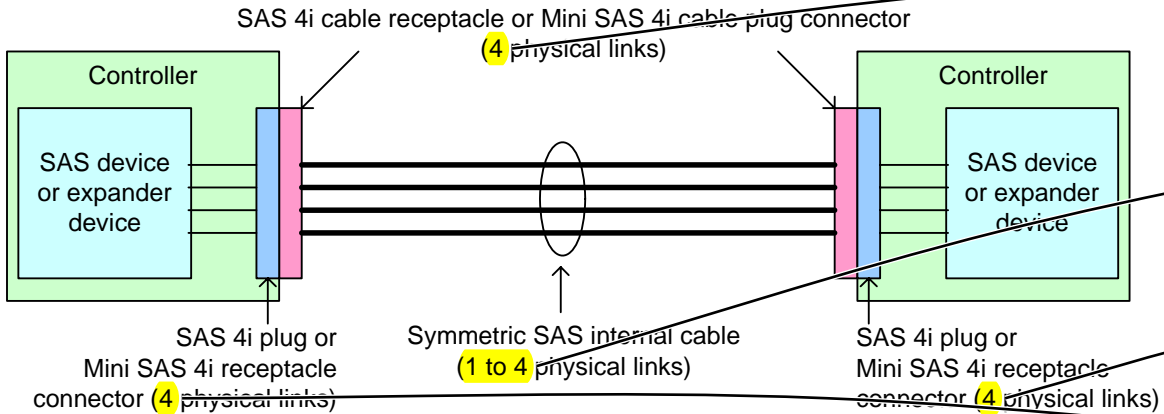

Figure 63 — SAS internal symmetric cable environment - controller to controller

Figure 64 shows a schematic representation of the SAS internal cable environment using a SAS controller-based fanout cable.

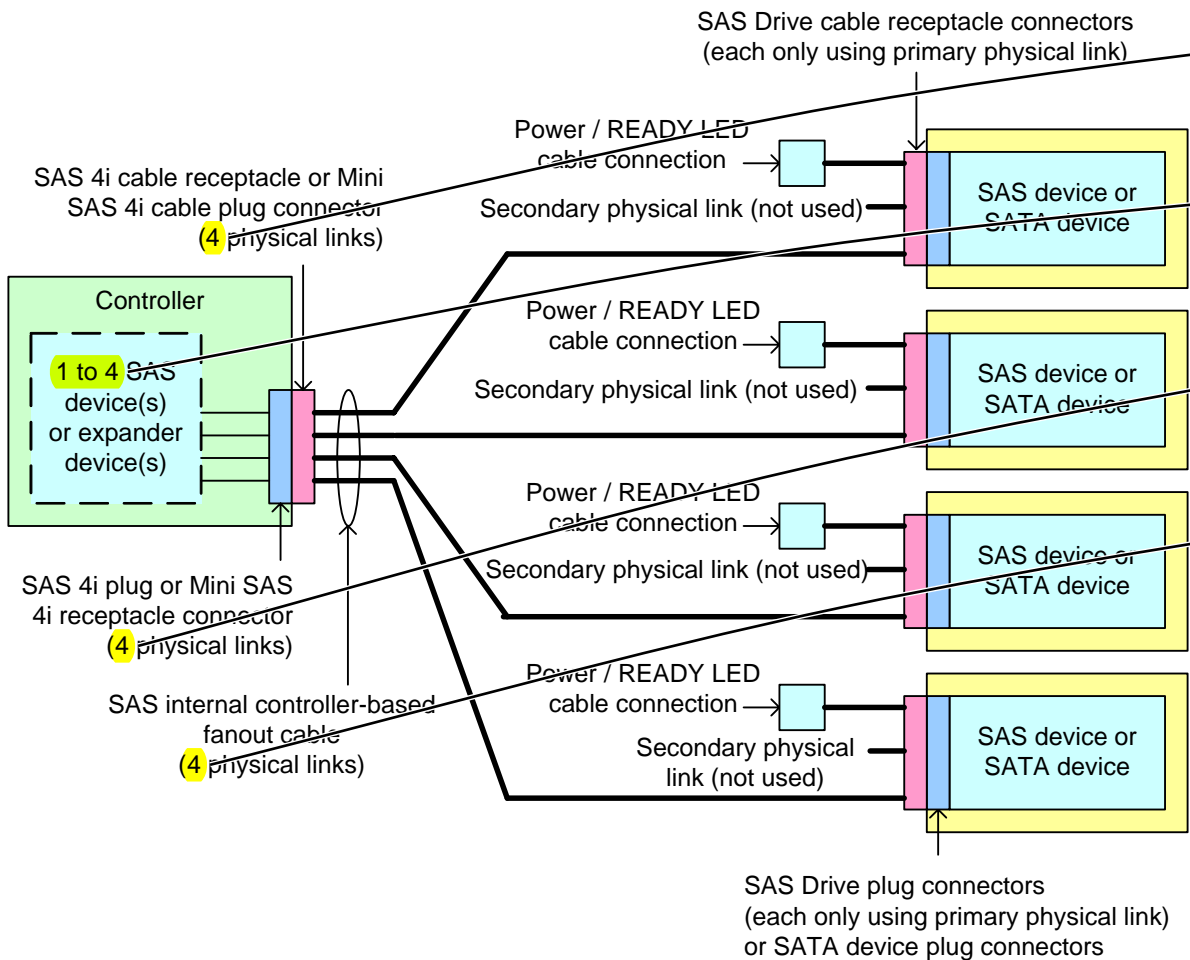

Figure 64 — SAS internal controller-based fanout cable environment

● Author: Isi-gpenokie
Subject: Highlight
Date: 5/6/2008 4:07:48 PM
T REJECT
Change to << four >>

● Author: Isi-gpenokie
Subject: Highlight
Date: 5/6/2008 4:07:48 PM
T REJECT
Change to << one to four >>

● Author: Isi-gpenokie
Subject: Highlight
Date: 5/6/2008 4:07:48 PM
T REJECT
Change to << four >>

● Author: Isi-gpenokie
Subject: Highlight
Date: 5/6/2008 4:07:48 PM
T REJECT
Change to << four >>

● Author: Isi-gpenokie
Subject: Highlight
Date: 5/6/2008 4:07:48 PM
T REJECT
Change to << four >>

● Author: Isi-gpenokie
Subject: Highlight
Date: 5/6/2008 4:07:48 PM
T REJECT
Change to << one to four >>

● Author: Isi-gpenokie
Subject: Highlight
Date: 5/6/2008 4:07:48 PM
T REJECT
Change to << four >>

● Author: Isi-gpenokie
Subject: Highlight
Date: 5/6/2008 4:07:48 PM
T REJECT
Change to << four >>

Figure 65 shows a schematic representation of the SAS internal cable environment using a SAS backplane-based fanout cable.

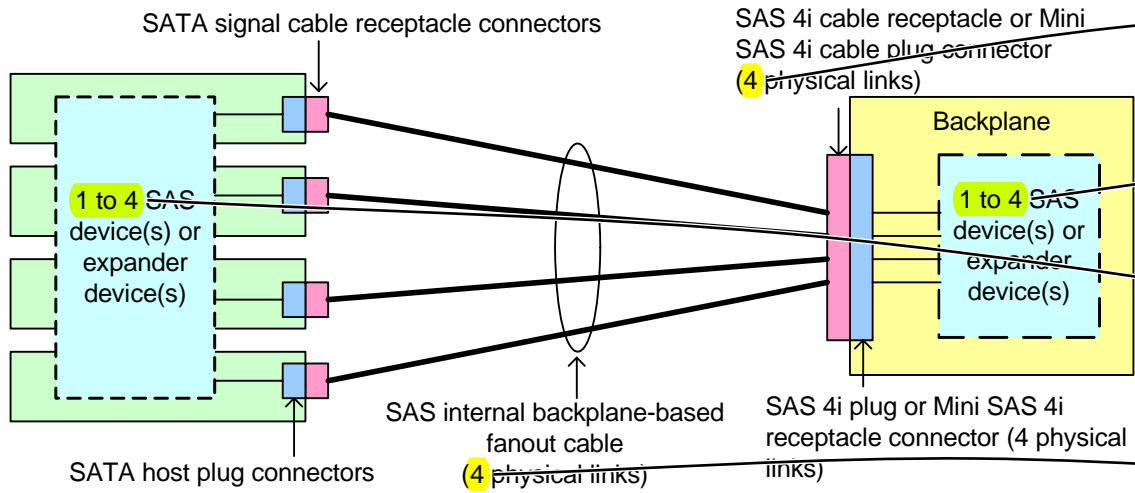

Figure 65 — SAS internal backplane-based fanout cable environment

● Author: Isi-gpenokie
Subject: Highlight
Date: 5/6/2008 4:07:48 PM
T REJECT
Change to << four >>

● Author: Isi-gpenokie
Subject: Highlight
Date: 5/6/2008 4:07:48 PM
T REJECT
Change to << one to four >>

● Author: Isi-gpenokie
Subject: Highlight
Date: 5/6/2008 4:07:48 PM
T REJECT
Change to << one to four >>

● Author: Isi-gpenokie
Subject: Highlight
Date: 5/6/2008 4:07:48 PM
T REJECT
Change to << four >>

5.2.3 Connectors

5.2.3.1 Connectors overview

Table 38 summarizes the connectors defined in this standard.

Table 38 — Connectors

Type of connector	Physical links	Reference	Attaches to		
			Type of connector	Physical links	Reference
SATA internal connectors used by SAS					
SATA signal cable receptacle	1	SATA-2	SATA host plug	1	SATA-2
SATA host plug	1	SATA-2	SATA signal cable receptacle	1	SATA-2
SATA device plug	1	SATA-2	SAS Drive cable receptacle	1 or 2	5.2.3.2.1.2
			SAS Drive backplane receptacle	2	5.2.3.2.1.3
SAS internal connectors - SAS Drive connectors					
SAS Drive plug	2	5.2.3.2.1.1	SAS Drive cable receptacle	1 or 2	5.2.3.2.1.2
			SAS Drive backplane receptacle	2	5.2.3.2.1.3
SAS Drive cable receptacle	1 or 2	5.2.3.2.1.2	SAS Drive plug	2	5.2.3.2.1.1
			SATA device plug	1	SATA-2
SAS Drive backplane receptacle	2	5.2.3.2.1.3	SAS Drive plug	2	5.2.3.2.1.1
			SATA device plug	1	SATA-2
SAS internal connectors - other					
SAS 4i cable receptacle	4	5.2.3.2.2.1	SAS 4i plug	4	5.2.3.2.2.2
SAS 4i plug	4	5.2.3.2.2.2	SAS 4i cable receptacle	4	5.2.3.2.2.1
Mini SAS 4i cable plug	4	5.2.3.2.3.1	Mini SAS 4i receptacle	4	5.2.3.2.3.2
Mini SAS 4i receptacle	4	5.2.3.2.3.2	Mini SAS 4i cable plug	4	5.2.3.2.3.1
SAS external connectors					
SAS 4x cable plug	4	5.2.3.3.1.1	SAS 4x receptacle	4	5.2.3.3.1.2
SAS 4x receptacle	4	5.2.3.3.1.2	SAS 4x cable plug	4	5.2.3.3.1.1
Mini SAS 4x cable plug	4	5.2.3.3.2.1	Mini SAS 4x receptacle	4	5.2.3.3.2.2
Mini SAS 4x receptacle	4	5.2.3.3.2.2	Mini SAS 4x plug	4	5.2.3.3.2.1

A SAS icon (see Annex M) should be placed on or near each SAS connector.

This page contains no comments

5.2.3.2 SAS internal connectors

5.2.3.2.1 SAS Drive connectors

5.2.3.2.1.1 SAS Drive plug connector

The SAS Drive plug connector is the Device Free (Plug) connector defined in SFF-8482.

See SFF-8223, SFF-8323, and SFF-8523 for the SAS Drive plug connector locations on common form factors.

Figure 66 shows the SAS Drive plug connector.

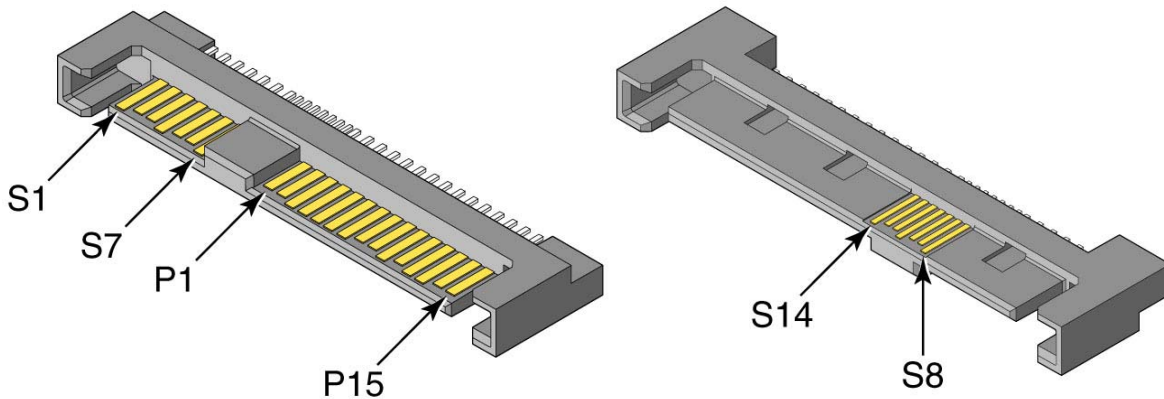

Figure 66 — SAS Drive plug connector

Table 39 (see 5.2.3.2.1.4) defines the pin assignments for the SAS Drive plug connector.

5.2.3.2.1.2 SAS Drive cable receptacle connector

The SAS Drive cable receptacle connector is the Internal Cable Fixed (Receptacle) connector defined in SFF-8482.

The single-port version attaches to:

- a SAS Drive plug connector, providing contact for the power pins and only the primary physical link;
- a SATA device plug connector, providing contact for the power pins and the primary physical link.

Figure 67 shows the single-port version of the SAS Drive cable receptacle connector.

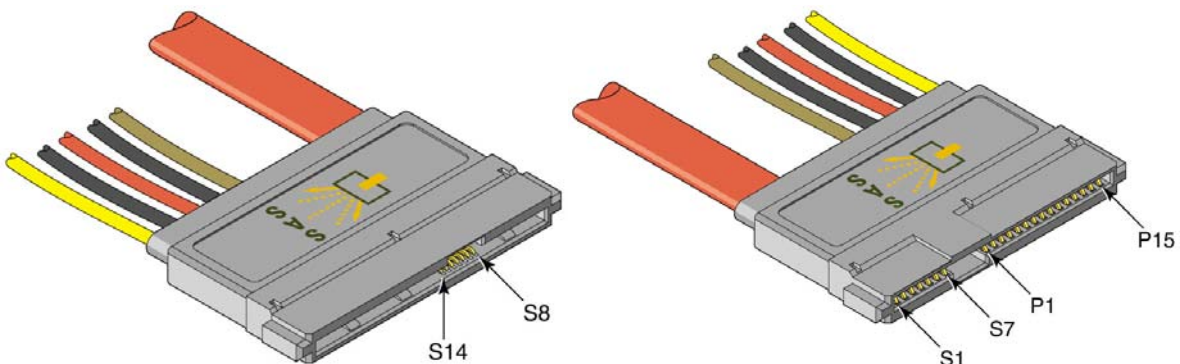

Figure 67 — Single-port SAS Drive cable receptacle connector

The dual-port version attaches to:

- a SAS Drive plug connector, providing contact for the power pins and only the primary physical link;

This page contains no comments

- b) a SAS Drive plug connector, providing contact for the power pins and both the primary and secondary physical links; or
- c) a SATA device plug connector, providing contact for the power pins and the primary physical link.

Figure 68 shows the dual-port version of the SAS Drive cable receptacle connector.

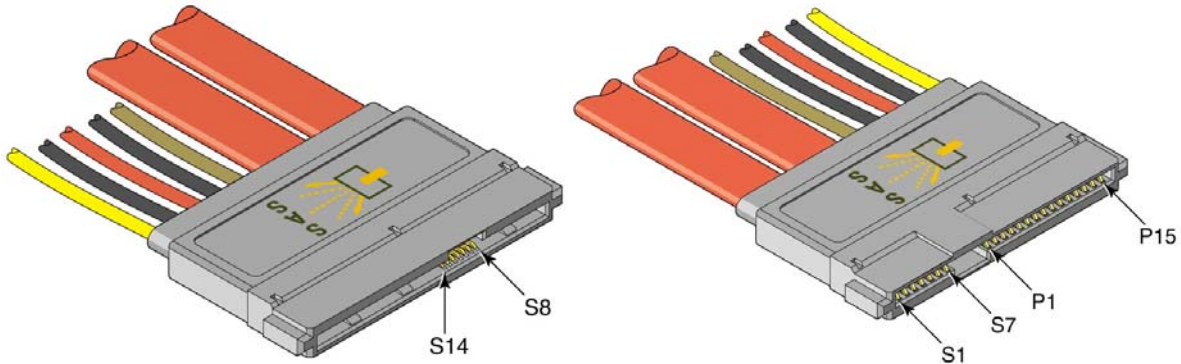

Figure 68 — Dual-port SAS Drive cable receptacle connector

Table 39 (see 5.2.3.2.1.4) defines the pin assignments for the SAS Drive cable receptacle connector. The secondary physical link (i.e., pins S8 through S14) is not supported by the single-port internal cable receptacle.

5.2.3.2.1.3 SAS Drive backplane receptacle connector

The SAS Drive backplane receptacle connector is the Backplane Fixed (Receptacle) connector defined in SFF-8482.

The SAS Drive backplane receptacle connector attaches to:

- a) a SAS Drive plug connector, providing contact for the power pins and only the primary physical link;
- b) a SAS Drive plug connector, providing contact for the power pins and both primary and secondary physical links; or
- c) a SATA device plug connector, providing contact for the power pins and the primary physical link.

Figure 69 shows the SAS Drive backplane receptacle connector.

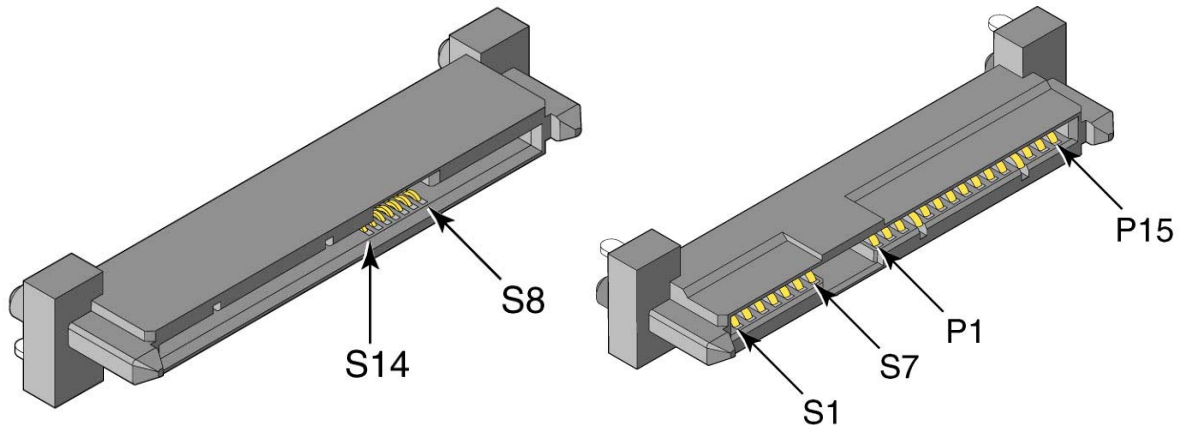



Figure 69 — SAS Drive backplane receptacle connector

Table 39 (see 5.2.3.2.1.4) defines the pin assignments for the SAS Drive backplane receptacle connector.

This page contains no comments

5.2.3.2.1.4 SAS Drive connector pin assignments

Table 39 defines the SAS target device pin assignments for the SAS Drive plug connector (see 5.2.3.2.1.1), the SAS Drive cable receptacle connector (see 5.2.3.2.1.2), and the SAS Drive ~~backplane receptacle~~ connector (see 5.2.3.2.1.3). The TP+, TP-, RP+, and RP- signals are used by the primary physical link. The TS+, TS-, RS+, and RS- signals are used by the secondary physical link, if any.

 SAS Drive plug connector pin assignments, except for the addition of the secondary physical link when present, are in the same locations as they are in a SATA device plug connector (see SATA-2).

● Author: hpq-bolawsky

Subject: Note

Date: 5/23/2008 4:32:05 PM



REJECT (Alvin: This paragraph only defines the location, not the properties. Note d of Table 39 specifically states that the electrical properties of SATA for this pin are different.)

Paragraph 2 implies that pin 11 of the power section is defined the same in Serial ATA. Note d clarifies this to some extent but the original SATA-II release identifies this pin as reserved.

Table 39 — SAS Drive connector pin assignments

Segment	Pin	Backplane receptacle	SAS Drive plug and SAS Drive cable receptacle
Primary signal segment	S1	SIGNAL GROUND	
	S2	TP+	RP+
	S3	TP-	RP-
	S4	SIGNAL GROUND	
	S5	RP-	TP-
	S6	RP+	TP+
	S7	SIGNAL GROUND	
Secondary signal segment ^a	S8	SIGNAL GROUND	
	S9	TS+	RS+
	S10	TS-	RS-
	S11	SIGNAL GROUND	
	S12	RS-	TS-
	S13	RS+	TS+
	S14	SIGNAL GROUND	
Power segment ^b	P1	V_{33} ^c	
	P2	V_{33} ^c	
	P3	V_{33} , precharge ^c	
	P4	GROUND	
	P5	GROUND	
	P6	GROUND	
	P7	V_5 , precharge ^c	
	P8	V_5 ^c	
	P9	V_5 ^c	
	P10	GROUND	
	P11	READY LED ^d	
	P12	GROUND	
	P13	V_{12} , precharge ^c	
	P14	V_{12} ^c	
	P15	V_{12} ^c	
^a S8 through S14 are no-connects on single-port implementations. ^b Backplane receptacle connectors and SAS Drive cable receptacle connectors provide V_{33} , V_5 , and V_{12} . SAS Device plug connectors receive V_{33} , V_5 , and V_{12} . ^c Behind a SAS Drive plug connector, the precharge pin and each corresponding voltage pin shall be connected together on the SAS target device (e.g., the V_5 , precharge pin P7 is connected to the two V_5 pins P8 and P9). ^d Electrical characteristics for READY LED are defined in 5.4 and signal behavior is defined in 10.4.1. SATA devices use P11 for activity indication and staggered spin-up disable and have different electrical characteristics (see SATA-2).			

This page contains no comments

5.2.3.2.2 SAS 4i connectors

5.2.3.2.2.1 SAS 4i cable receptacle connector

The SAS 4i cable receptacle connector is the 4 Lane Cable Receptacle (fixed) with Backshell connector defined in SFF-8484.

Figure 70 shows the SAS 4i cable receptacle connector.

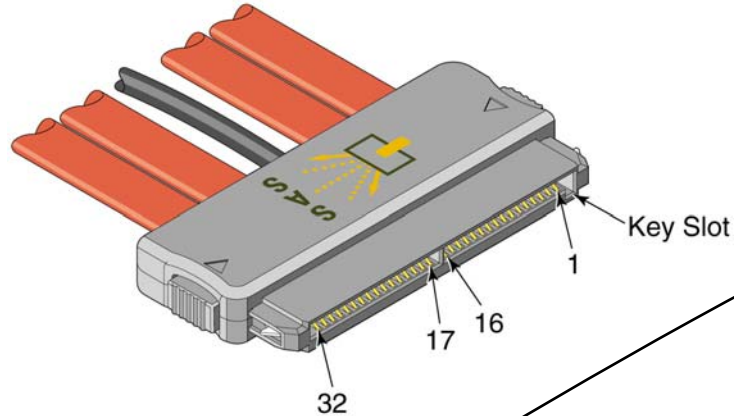

Figure 70 — SAS 4i cable receptacle connector

Table 40 and table 41 (see 5.2.3.2.2.3) define the pin assignments for the SAS 4i cable receptacle connector.

5.2.3.2.2.2 SAS 4i plug connector

The SAS 4i plug connector is the 4 Lane Vertical Plug (free) or 4 Lane R/A Plug (free) connector defined in SFF-8484.

Figure 71 shows the SAS 4i plug connector.

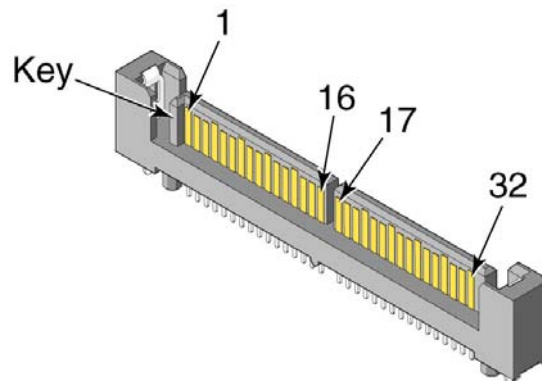

Figure 71 — SAS 4i plug connector

Table 40 and table 41 (see 5.2.3.2.2.3) define the pin assignments for the SAS 4i plug connector.

● Author: Isi-gpenokie
Subject: Highlight
Date: 5/6/2008 4:07:48 PM
T REJECT (that's how it's named in the reference)

Change to << four >>

● Author: Isi-gpenokie
Subject: Highlight
Date: 5/6/2008 4:07:48 PM
T REJECT (that's how it's named in the reference)

Change to << four >>

5.2.3.2.2.3 SAS 4i connector pin assignments

Table 40 defines the pin assignments for SAS 4i cable receptacle connectors (see 5.2.3.2.2.1) and SAS 4i plug connectors (see 5.2.3.2.2.2) for controller applications using one, two, three, or four of the physical links.

Table 40 — Controller SAS 4i connector pin assignments and physical link usage

Signal	Pin usage based on number of physical links supported by the cable assembly ^a			
	One	Two	Three	Four
Rx 0+	2	2	2	2
Rx 0-	3	3	3	3
Tx 0-	5	5	5	5
Tx 0+	6	6	6	6
Rx 1+	N/C	8	8	8
Rx 1-	N/C	9	9	9
Tx 1-	N/C	11	11	11
Tx 1+	N/C	12	12	12
Sideband 0	14	14	14	14
Sideband 1	15	15	15	15
Sideband 2	16	16	16	16
Sideband 3	17	17	17	17
Sideband 4	18	18	18	18
Sideband 5	19	19	19	19
Rx 2+	N/C	N/C	21	21
Rx 2-	N/C	N/C	22	22
Tx 2-	N/C	N/C	24	24
Tx 2+	N/C	N/C	25	25
Rx 3+	N/C	N/C	N/C	27
Rx 3-	N/C	N/C	N/C	28
Tx 3-	N/C	N/C	N/C	30
Tx 3+	N/C	N/C	N/C	31
SIGNAL GROUND	1, 4, 7, 10, 13, 20, 23, 26, 29, 32			
^a N/C = not connected				

The use of the sideband signals by a controller is vendor-specific. One implementation of the sideband signals by a controller is an SGPIO initiator interface (see SFF-8485). Other implementations shall be compatible with the signal levels defined in SFF-8485.

This page contains no comments

Table 41 defines the pin assignments for SAS 4i plug connectors (see 5.2.3.2.2.1) and SAS 4i cable receptacle connectors (see 5.2.3.2.2.1) for backplane applications using one, two, three, or four of the physical links.

Table 41 — Backplane SAS 4i connector pin assignments and physical link usage

Signal	Pin usage based on number of physical links supported by the cable assembly ^a			
	One	Two	Three	Four
Rx 3+	N/C	N/C	N/C	2
Rx 3-	N/C	N/C	N/C	3
Tx 3-	N/C	N/C	N/C	5
Tx 3+	N/C	N/C	N/C	6
Rx 2+	N/C	N/C	8	8
Rx 2-	N/C	N/C	9	9
Tx 2-	N/C	N/C	11	11
Tx 2+	N/C	N/C	12	12
Sideband 5	14	14	14	14
Sideband 4	15	15	15	15
Sideband 3	16	16	16	16
Sideband 2	17	17	17	17
Sideband 1	18	18	18	18
Sideband 0	19	19	19	19
Rx 1+	N/C	21	21	21
Rx 1-	N/C	22	22	22
Tx 1-	N/C	24	24	24
Tx 1+	N/C	25	25	25
Rx 0+	27	27	27	27
Rx 0-	28	28	28	28
Tx 0-	30	30	30	30
Tx 0+	31	31	31	31
SIGNAL GROUND	1, 4, 7, 10, 13, 20, 23, 26, 29, 32			
^a N/C = not connected				

The use of the sideband signals by a backplane is vendor-specific. One implementation of the sideband signals by a backplane is an SGPIO target interface (see SFF-8485). Other implementations shall be compatible with the signal levels defined in SFF-8485.

This page contains no comments

5.2.3.2.3 Mini SAS 4i connectors

5.2.3.2.3.1 Mini SAS 4i cable plug connector

The Mini SAS 4i cable plug connector is the free (plug) 36-circuit Unshielded Compact Multilane connector defined in SFF-8087 and SFF-8086.

Figure 72 shows the Mini SAS 4i cable plug connector.

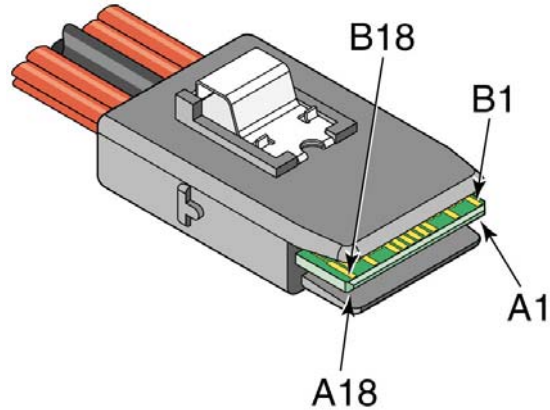

Figure 72 — Mini SAS 4i cable plug connector

Table 42 and table 43 (see 5.2.3.2.3.3) define the pin assignments for the Mini SAS 4i cable plug connector.

5.2.3.2.3.2 Mini SAS 4i receptacle connector

The Mini SAS 4i receptacle connector is the fixed (receptacle) 36-circuit Unshielded Compact Multilane connector defined in SFF-8087 and SFF-8086.

Figure 73 shows the Mini SAS 4i receptacle connector.

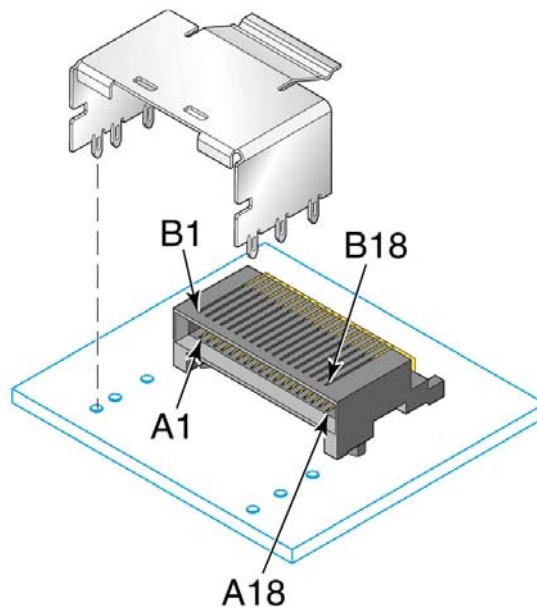

Figure 73 — Mini SAS 4i receptacle connector

Table 42 and table 43 (see 5.2.3.2.3.3) define the pin assignments for the Mini SAS 4i receptacle connector.

This page contains no comments

5.2.3.2.3.3 Mini SAS 4i connector pin assignments

Table 42 defines the pin assignments for Mini SAS 4i plug connectors (see 5.2.3.2.3.1) and Mini SAS 4i cable receptacle connectors (see 5.2.3.2.3.2) for controller applications using one, two, three, or four of the physical links.

Table 42 — Controller Mini SAS 4i connector pin assignments and physical link usage

Signal	Pin usage based on number of physical links supported by the cable assembly ^a				Mating level
	One	Two	Three	Four	
Rx 0+	A2	A2	A2	A2	Third
Rx 0-	A3	A3	A3	A3	
Rx 1+	N/C	A5	A5	A5	
Rx 1-	N/C	A6	A6	A6	
Sideband 7	A8	A8	A8	A8	First
Sideband 3	A9	A9	A9	A9	
Sideband 4	A10	A10	A10	A10	
Sideband 5	A11	A11	A11	A11	
Rx 2+	N/C	N/C	A13	A13	Third
Rx 2-	N/C	N/C	A14	A14	
Rx 3+	N/C	N/C	N/C	A16	
Rx 3-	N/C	N/C	N/C	A17	
Tx 0+	B2	B2	B2	B2	Third
Tx 0-	B3	B3	B3	B3	
Tx 1+	N/C	B5	B5	B5	
Tx 1-	N/C	B6	B6	B6	
Sideband 0	B8	B8	B8	B8	First
Sideband 1	B9	B9	B9	B9	
Sideband 2	B10	B10	B10	B10	
Sideband 6	B11	B11	B11	B11	
Tx 2+	N/C	N/C	B13	B13	Third
Tx 2-	N/C	N/C	B14	B14	
Tx 3+	N/C	N/C	N/C	B16	
Tx 3-	N/C	N/C	N/C	B17	
SIGNAL GROUND	A1, A4, A7, A12, A15, A18, B1, B4, B7, B12, B15, B18				First
^a N/C = not connected					

The use of the sideband signals by a controller is vendor-specific. One implementation of the sideband signals by a controller is an SGPIO initiator interface (see SFF-8485). Other implementations shall be compatible with the signal levels defined in SFF-8485.

Author: hpq-bolawsky

Subject: Note

Date: 5/23/2008 4:41:22 PM



ACCEPT - DONE (Alvin: The mating level is a function of the length as described in SFF-8086. There are three levels defined (second mate optional), so the absence of second level is okay, but not intuitively obvious.

Resolution:

Add a flag for note b at the head of the "Mating level" column.

Add note b:

b Mating level applies to the physical dimension of the contact (see SFF-8086).

Done to all 3 tables with "mating level" columns - table 42, 43, and 49.)

)

Table 42/43

Why are signal pins labeled as third mate and not second?

Table 43 defines the pin assignments for Mini SAS 4i plug connectors (see 5.2.3.2.3.1) and Mini SAS 4i cable receptacle connectors (see 5.2.3.2.3.2) for backplane applications using one, two, three, or four of the physical links.

Table 43 — Backplane Mini SAS 4i connector pin assignments and physical link usage

Signal	Pin usage based on number of physical links supported by the cable assembly ^a				Mating level
	One	Two	Three	Four	
Rx 0+	A2	A2	A2	A2	Third
Rx 0-	A3	A3	A3	A3	
Rx 1+	N/C	A5	A5	A5	
Rx 1-	N/C	A6	A6	A6	
Sideband 0	A8	A8	A8	A8	First
Sideband 1	A9	A9	A9	A9	
Sideband 2	A10	A10	A10	A10	
Sideband 6	A11	A11	A11	A11	
Rx 2+	N/C	N/C	A13	A13	Third
Rx 2-	N/C	N/C	A14	A14	
Rx 3+	N/C	N/C	N/C	A16	
Rx 3-	N/C	N/C	N/C	A17	
Tx 0+	B2	B2	B2	B2	Third
Tx 0-	B3	B3	B3	B3	
Tx 1+	N/C	B5	B5	B5	
Tx 1-	N/C	B6	B6	B6	
Sideband 7	B8	B8	B8	B8	First
Sideband 3	B9	B9	B9	B9	
Sideband 4	B10	B10	B10	B10	
Sideband 5	B11	B11	B11	B11	
Tx 2+	N/C	N/C	B13	B13	Third
Tx 2-	N/C	N/C	B14	B14	
Tx 3+	N/C	N/C	N/C	B16	
Tx 3-	N/C	N/C	N/C	B17	
SIGNAL GROUND	A1, A4, A7, A12, A15, A18, B1, B4, B7, B12, B15, B18				First
^a N/C = not connected					

The use of the sideband signals by a backplane is vendor-specific. One implementation of the sideband signals by a backplane is an SGPIO target interface (see SFF-8485). Other implementations shall be compatible with the signal levels defined in SFF-8485.

● Author: RElliott
Subject: Highlight
Date: 6/30/2008 6:16:52 PM
T ACCEPT - DONE

assembly a

fix footnote cross reference, which points to wrong table

● Author: RElliott
Subject: Highlight
Date: 6/30/2008 6:16:52 PM
T ACCEPT - DONE

Add footnote for Mating level as described in table 42

5.2.3.3 SAS external connectors

5.2.3.3.1 SAS 4x connectors

5.2.3.3.1.1 SAS 4x cable plug connector

The SAS 4x cable plug connector is the 4X free (plug) connector with jack screws defined in SFF-8470. The SAS 4x cable plug connector shall not include keys and may include key slots. Key slots for the SAS 4x cable plug connector are not defined by this standard.

Figure 74 shows the SAS 4x cable plug connector.

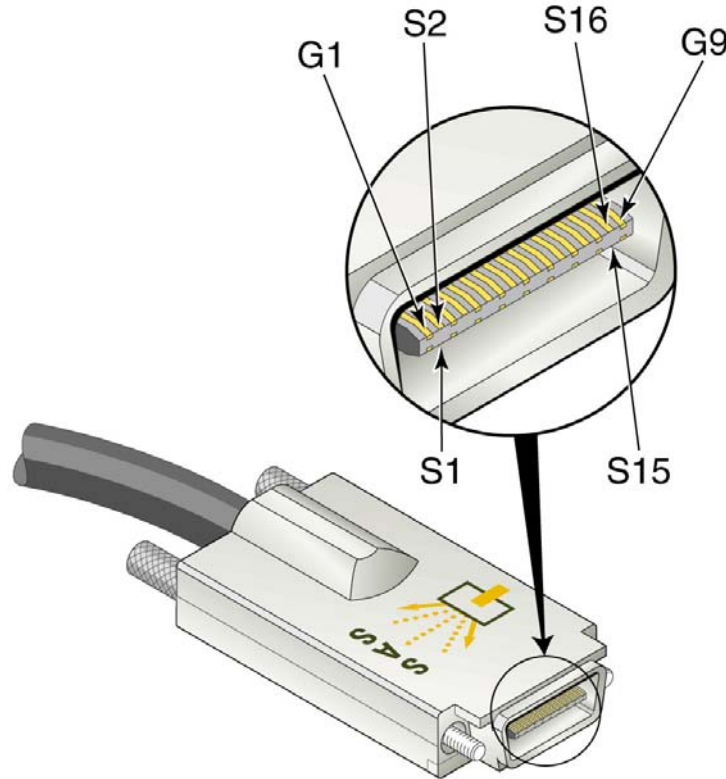

Figure 74 — SAS 4x cable plug connector

Table 46 (see 5.2.3.3.1.3) defines the pin assignments for the SAS 4x cable plug connector.

Table 44 defines the icons that should be placed on or near SAS 4x cable plug connectors.

Table 44 — SAS 4x cable plug connector icons

Use	Icon
End of a SAS external cable that attaches to an end device, an enclosure out port, or an enclosure universal port	Diamond
End of a SAS external cable that attaches to an end device, an enclosure in port, or an enclosure universal port	Circle

5.2.3.3.1.2 SAS 4x receptacle connector

The SAS 4x receptacle connector is the 4X fixed (receptacle) connector with jack screws defined in SFF-8470. The SAS 4x receptacle connector shall not include keys and may include key slots. Key slots for the SAS 4x receptacle connector are not defined by this standard.

This page contains no comments

A SAS 4x receptacle connector may be used by one or more SAS devices (e.g., one SAS device using physical links 0 and 3, another using physical link 1, and a third using physical link 2).

A SAS 4x receptacle connector shall be used by no more than one expander device at a time, and all physical links shall be used by the same expander port (i.e., all the expander phys shall have the same routing attribute (e.g., subtractive or table) (see 4.6.2)).

Figure 75 shows the SAS 4x receptacle connector.

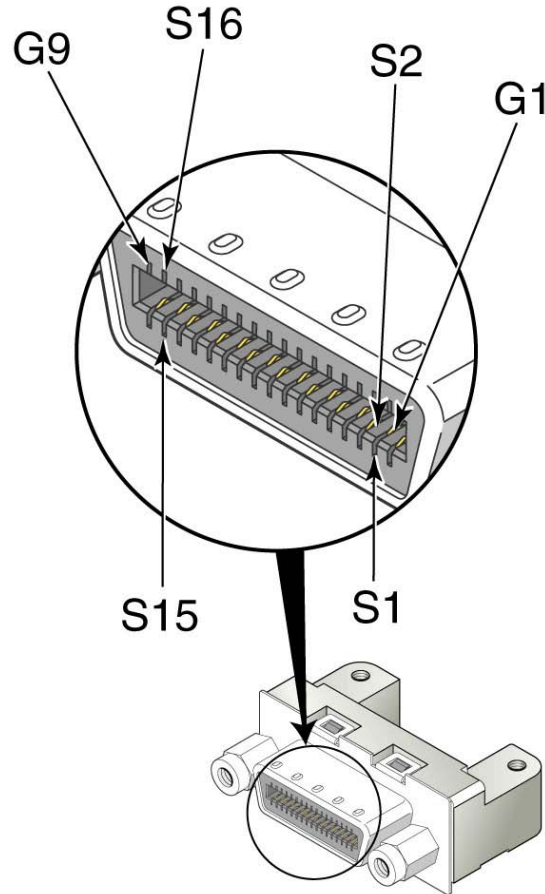

Figure 75 — SAS 4x receptacle connector

Table 46 (see 5.2.3.3.1.3) defines the pin assignments for the SAS 4x receptacle connector.

Table 45 defines the icons that should be placed near SAS 4x receptacle connectors.

Table 45 — SAS 4x receptacle connector icons

Use	Icons
Enclosure out port (see 4.6.2)	Diamond
End device or enclosure universal port	Diamond and circle
Enclosure in port (see 4.6.2)	Circle

This page contains no comments

5.2.3.3.1.3 SAS 4x connector pin assignments

Table 46 defines the pin assignments for SAS 4x cable plug connectors (see 5.2.3.3.1.1) and SAS 4x receptacle connectors (see 5.2.3.3.1.2) for applications using one, two, three, or four of the physical links.

Table 46 — SAS 4x connector pin assignments and physical link usage

Signal	Pin usage based on number of physical links supported by the cable assembly ^a			
	One	Two	Three	Four
Rx 0+	S1	S1	S1	S1
Rx 0-	S2	S2	S2	S2
Rx 1+	N/C	S3	S3	S3
Rx 1-	N/C	S4	S4	S4
Rx 2+	N/C	N/C	S5	S5
Rx 2-	N/C	N/C	S6	S6
Rx 3+	N/C	N/C	N/C	S7
Rx 3-	N/C	N/C	N/C	S8
Tx 3-	N/C	N/C	N/C	S9
Tx 3+	N/C	N/C	N/C	S10
Tx 2-	N/C	N/C	S11	S11
Tx 2+	N/C	N/C	S12	S12
Tx 1-	N/C	S13	S13	S13
Tx 1+	N/C	S14	S14	S14
Tx 0-	S15	S15	S15	S15
Tx 0+	S16	S16	S16	S16
SIGNAL GROUND	G1 - G9			
CHASSIS GROUND	Housing			
^a N/C = not connected				

SIGNAL GROUND shall not be connected to CHASSIS GROUND in the connector when used in a cable assembly.

5.2.3.3.2 Mini SAS 4x connectors

5.2.3.3.2.1 Mini SAS 4x cable plug connector

The Mini SAS 4x cable plug connector is the free (plug) 26-circuit Shielded Compact Multilane connector defined in SFF-8088 and SFF-8086.

This page contains no comments

Figure 76 shows the Mini SAS 4x cable plug connector.

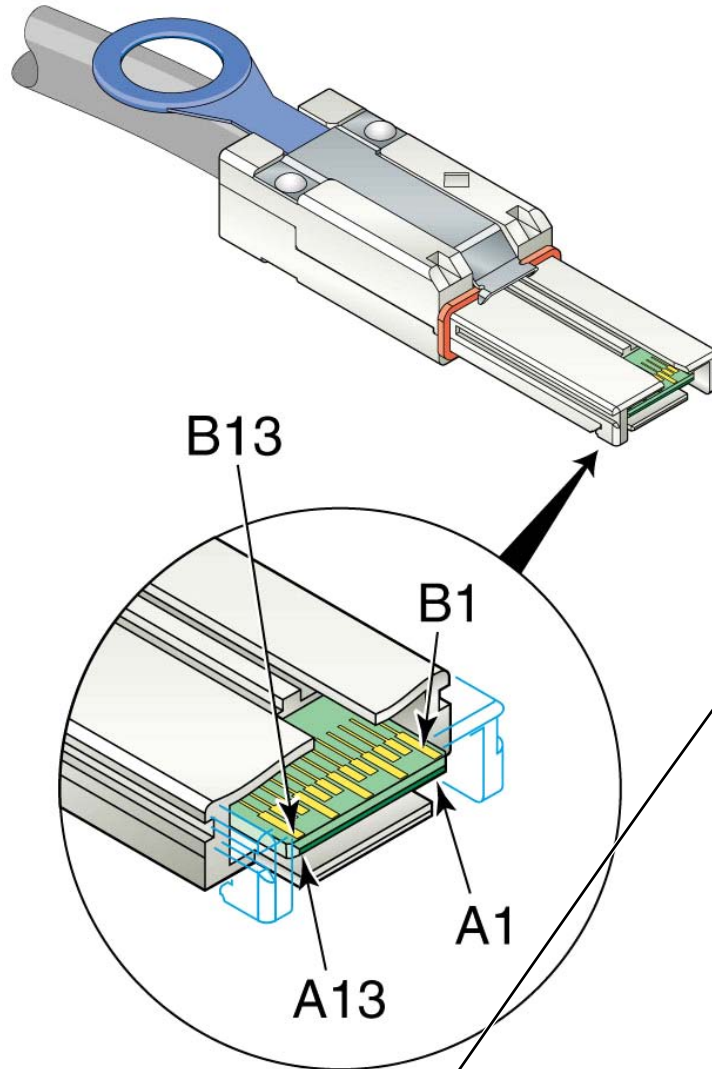

Figure 76 — Mini SAS 4x cable plug connector

If constructed with a pull tab as shown in figure 76, the pull tab should use PANTONE 279 C (i.e., light blue coated).

Table 49 (see 5.2.3.3.2.3) defines the pin assignments for the Mini SAS 4x cable plug connector.

Mini SAS 4x cable plug connectors shall include key slots to allow attachment to Mini SAS 4x receptacle connectors (see 5.2.3.3.2.2) with matching keys.

Table 47 defines the icons that shall be placed on or near Mini SAS 4x cable plug connectors and the key slot positions (see SFF-8088) that shall be used by Mini SAS 4x cable plug connectors.

Table 47 — Mini SAS 4x cable plug connector icons and key slot positions

Use	Icon	Key slot positions	Reference
End of a SAS external cable that attaches to an end device, an enclosure out port, or an enclosure universal port	Diamond	2, 4	Figure 77
End of a SAS external cable that attaches to an end device, an enclosure in port, or an enclosure universal port	Circle	4, 6	Figure 78

Author: RElliott
Subject: Highlight
Date: 6/30/2008 6:16:52 PM

T ACCEPT - DONE

the
s/b
then the

Figure 77 shows the key slots on the Mini SAS 4x cable plug connector that attaches to an end device or an enclosure universal port (see figure 80 in 5.2.3.3.2.2), or an enclosure out port (see figure 81 in 5.2.3.3.2.2).

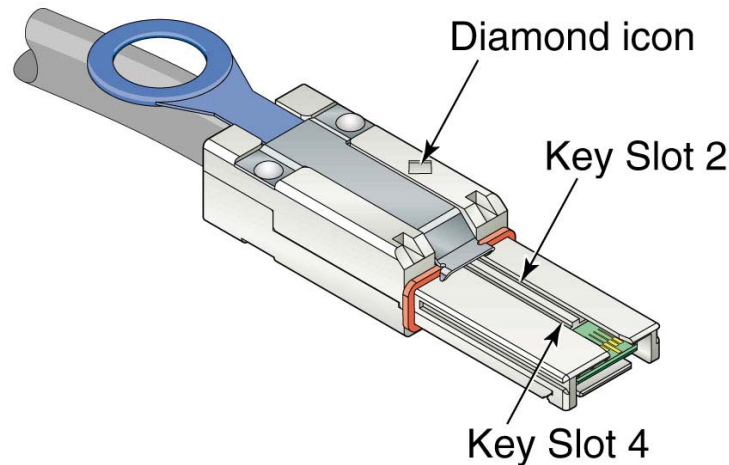

Figure 77 — Mini SAS 4x cable plug connector that attaches to an enclosure out port

Figure 78 shows the key slots on the Mini SAS 4x cable plug connector that attaches to an end device or an enclosure universal port (see figure 80 in 5.2.3.3.2.2), or an enclosure in port (see figure 82 in 5.2.3.3.2.2).

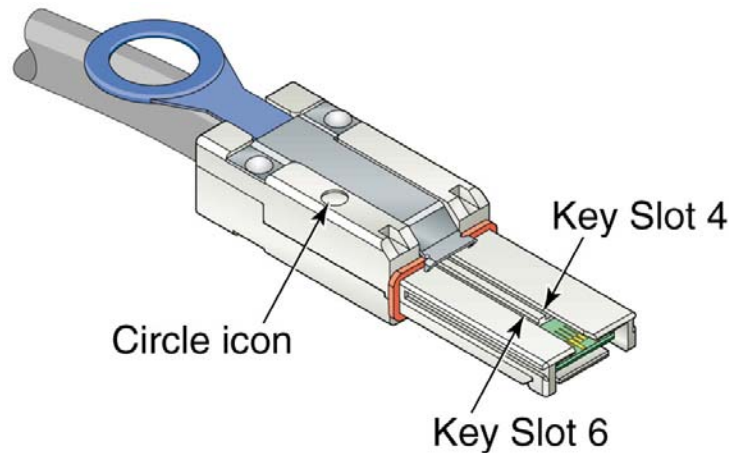

Figure 78 — Mini SAS 4x cable plug connector that attaches to an enclosure in port

5.2.3.3.2.2 Mini SAS 4x receptacle connector

The Mini SAS 4x receptacle connector is the fixed (receptacle) 26-circuit Shielded Compact Multilane connector defined in SFF-8088 and SFF-8086.

A Mini SAS 4x receptacle connector may be used by one or more SAS devices (e.g., one SAS device using physical links 0 and 3, another using physical link 1, and a third using physical link 2).

A Mini SAS 4x receptacle connector shall be used by no more than one expander device at a time, and all physical links shall be used by the same expander port (i.e., all the expander phys shall have the same routing attribute (e.g., subtractive or table) (see 4.6.2)).

This page contains no comments

Figure 79 shows the Mini SAS 4x receptacle connector.

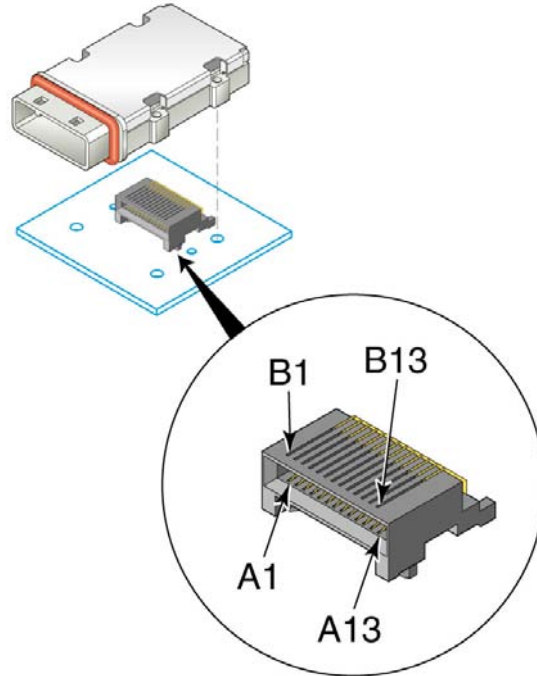

Figure 79 — Mini SAS 4x receptacle connector

Table 49 (see 5.2.3.3.2.3) defines the pin assignments for the Mini SAS 4x receptacle connector.

Mini SAS 4x receptacle connectors shall include keys to prevent attachment to Mini SAS 4x cable plug connectors (see 5.2.3.3.2.1) without matching key slots.

Table 48 defines the icons that shall be placed on or near Mini SAS 4x receptacle connectors and the key positions (see SFF-8088) that shall be used by Mini SAS 4x receptacle connectors.

Table 48 — Mini SAS 4x receptacle connector icons and key positions

Use	Icons	Key position	Reference
End device or enclosure universal port	Diamond and circle	4	Figure 80
Enclosure out port (see 4.6.2)	Diamond	2	Figure 81
Enclosure in port (see 4.6.2)	Circle	6	Figure 82

This page contains no comments

Figure 80 shows the key on a Mini SAS 4x receptacle connector used by end devices. This connector may be attached to the Mini SAS 4x cable plug shown in figure 77 or the Mini SAS 4x cable plug shown in figure 78 (see 5.2.3.3.2.1).

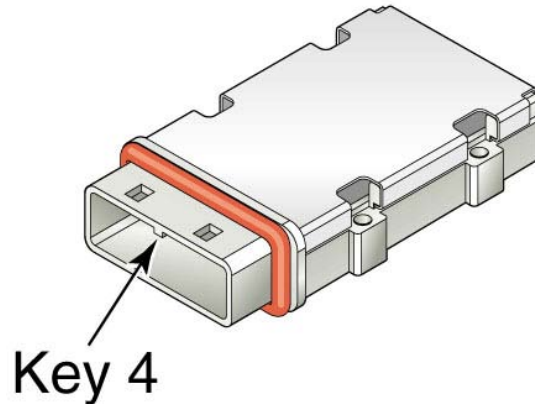

Figure 80 — Mini SAS 4x receptacle connector - end device or enclosure universal port

Figure 81 shows the key on a Mini SAS 4x receptacle connector used by an enclosure out port. This connector may be attached to the Mini SAS 4x cable plug shown in figure 77 (see 5.2.3.3.2.1).

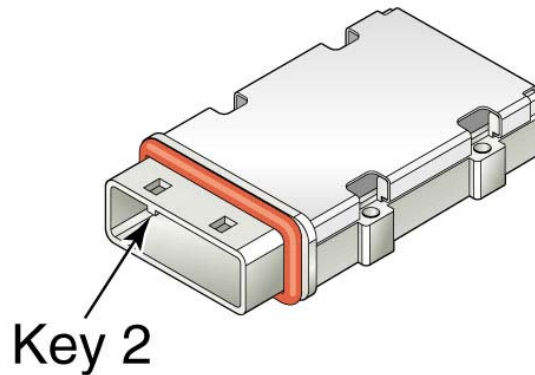

Figure 81 — Mini SAS 4x receptacle connector - enclosure out port

Figure 82 shows the key on a Mini SAS 4x receptacle connector used by an enclosure in port. This connector may be attached to the Mini SAS 4x cable plug shown in figure 78 (see 5.2.3.3.2.1).

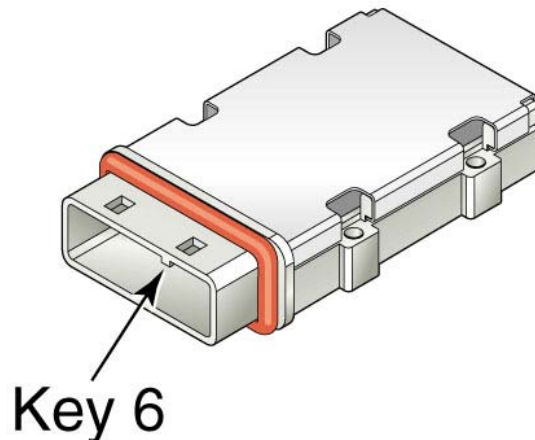

Figure 82 — Mini SAS 4x receptacle connector - enclosure in port

This page contains no comments

5.2.3.3.2.3 Mini SAS 4x connector pin assignments

Table 49 defines the pin assignments for Mini SAS 4x cable plug connectors (see 5.2.3.3.2.1) and Mini SAS 4x receptacle connectors (see 5.2.3.3.2.2) for applications using one, two, three, or four of the physical links.

Table 49 — Mini SAS 4x connector pin assignments and physical link usage

Signal	Pin usage based on number of physical links supported by the cable assembly ^a				Mating level
	One	Two	Three	Four	
Rx 0+	A2	A2	A2	A2	Third
Rx 0-	A3	A3	A3	A3	
Rx 1+	N/C	A5	A5	A5	
Rx 1-	N/C	A6	A6	A6	
Rx 2+	N/C	N/C	A8	A8	
Rx 2-	N/C	N/C	A9	A9	
Rx 3+	N/C	N/C	N/C	A11	
Rx 3-	N/C	N/C	N/C	A12	
Tx 0+	B2	B2	B2	B2	
Tx 0-	B3	B3	B3	B3	
Tx 1+	N/C	B5	B5	B5	
Tx 1-	N/C	B6	B6	B6	
Tx 2+	N/C	N/C	B8	B8	
Tx 2-	N/C	N/C	B9	B9	
Tx 3+	N/C	N/C	N/C	B11	
Tx 3-	N/C	N/C	N/C	B12	
SIGNAL GROUND	A1, A4, A7, A10, A13 B1, B4, B7, B10, B13				First
CHASSIS GROUND	Housing				N/A

^a N/C = not connected

SIGNAL GROUND shall not be connected to CHASSIS GROUND in the connector when used in a cable assembly.

5.2.4 Cable assemblies

5.2.4.1 SAS internal cable assemblies

5.2.4.1.1 SAS Drive cable assemblies

There are two types of SAS Drive cable assemblies:

- single-port SAS Drive cable assembly; and
- dual-port SAS Drive cable assembly.

Both SAS Drive cable assemblies shall use:

- a SAS Drive cable receptacle connector (see 5.2.3.2.1.2) on the SAS target device end; and

● Author: hpq-bolawsky

Subject: Note

Date: 5/23/2008 4:41:28 PM

 ACCEPT - DONE (see reply on table 42)

Why are signal pins labeled as third mate and not second?

● Author: RElliott

Subject: Highlight

Date: 6/30/2008 6:16:52 PM

 ACCEPT - DONE

There are two types of SAS Drive cable assemblies:

s/b

A SAS Drive cable assembly is either:

and change "and" to "or"

● Author: wdc-mevans

Subject: Highlight

Date: 5/23/2008 5:00:03 PM

 REJECT (but rewording this paragraph)

assembly

s/b

assemblies

● Author: wdc-mevans

Subject: Highlight

Date: 5/23/2008 5:00:07 PM

 REJECT (but rewording this paragraph)

assembly

s/b

assemblies

● Author: RElliott

Subject: Highlight

Date: 6/30/2008 6:16:52 PM

 ACCEPT - DONE

Both SAS Drive cable assemblies shall use

s/b

A SAS Drive cable assembly has:

- b) a SATA signal cable receptacle connector (see SATA-2) on the SAS initiator device or expander device end.

The power and READY LED signal connection is vendor specific.

A SAS initiator device shall use a SATA host plug connector (see SATA-2) for connection to a SAS Drive cable assembly. The signal assignment for the SAS initiator device or expander device with this connector shall be the same as that defined for a SATA host (see SATA-2).

Figure 83 shows the Single-port SAS Drive cable assembly.

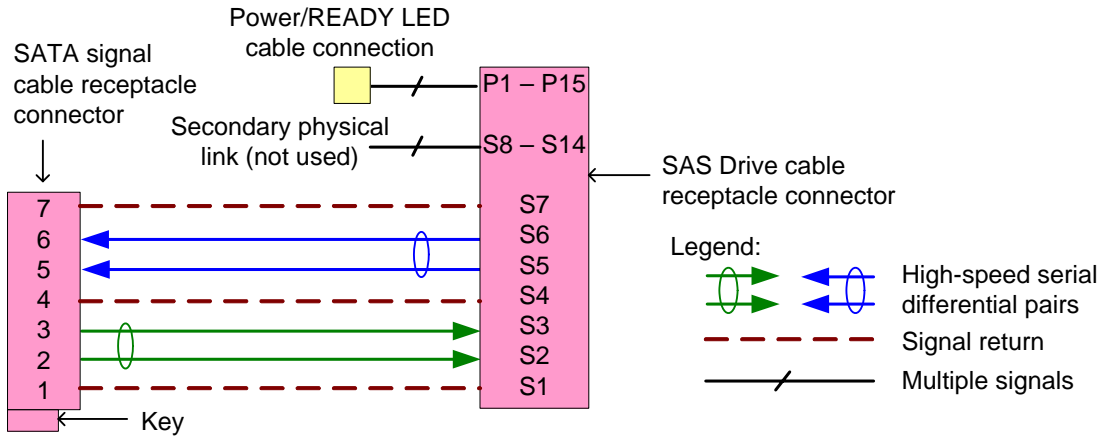

Figure 83 — Single-port SAS Drive cable assembly

Figure 84 shows the Dual-port SAS Drive cable assembly.

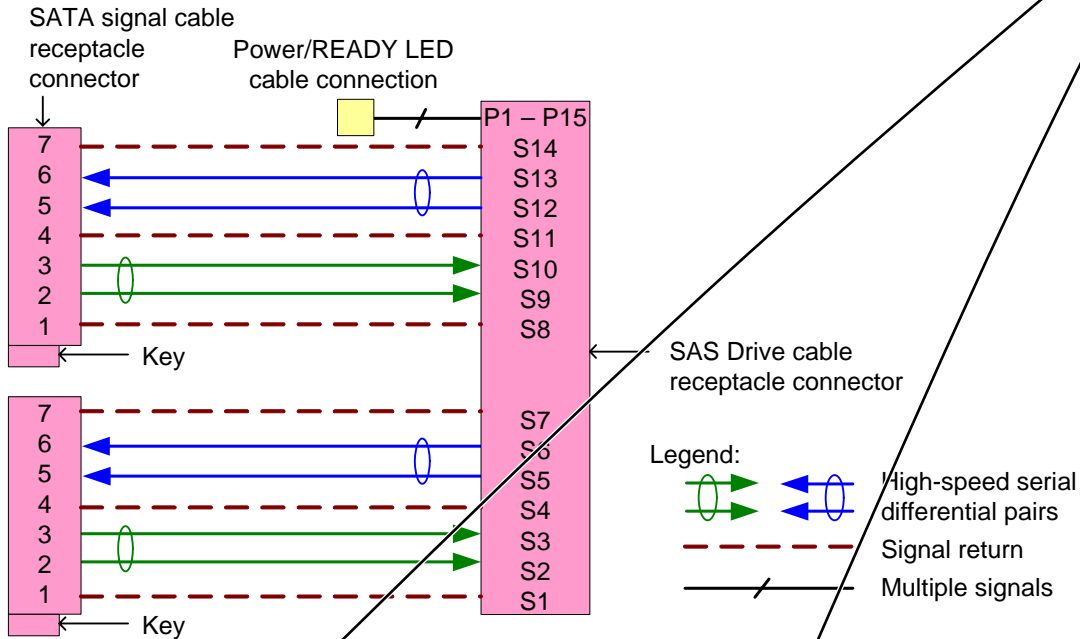

Figure 84 — Dual-port SAS Drive cable assembly

5.2.4.1.2 SAS internal symmetric cable assemblies

5.2.4.1.2.1 SAS internal symmetric cable assemblies overview

There are several types of SAS internal symmetric cable assemblies:

- a) SAS 4i cable receptacle connectors (see 5.2.3.2.2.1) on each end (see 5.2.4.1.2.2);

● Author: lsi-gpenokie
Subject: Highlight
Date: 5/6/2008 4:07:48 PM

T REJECT (treat the ANDED noun as one thing)

This << connection is vendor specific. >> should be << connection are vendor specific. >>

● Author: RElliott
Subject: Highlight
Date: 6/30/2008 6:16:52 PM

T ACCEPT - DONE

There are several types of SAS internal symmetric cable assemblies

s/b

A SAS internal symmetric cable assembly has:

and change "and" to "or"

● Author: wdc-mevans
Subject: Highlight
Date: 5/24/2008 10:58:37 AM

T REJECT (but rewrote this paragraph)

SAS

s/b

assemblies with SAS

- b) Mini SAS 4i cable plug connectors (see 5.2.3.3.2.1) on each end (see 5.2.4.1.2.3); and
- c) a SAS 4i cable receptacle connector on one end and a Mini SAS 4i cable plug connector on the other end, with vendor-specific sidebands (see 5.2.4.1.2.4);
- d) a SAS 4i cable receptacle connector on the controller end and a Mini SAS 4i cable plug connector on the backplane end, with sidebands supporting SGPIO (see 5.2.4.1.2.5); and
- e) a Mini SAS 4i cable receptacle connector on the controller end and a SAS 4i cable plug connector on the backplane end, with sidebands supporting SGPIO (see 5.2.4.1.2.6).

In a SAS internal symmetric cable assembly, the Tx signals on one end shall be connected to Rx signals on the other end (e.g., a Tx + of one connector shall connect to an Rx + of the other connector. SAS internal symmetric cable assemblies should be labeled to indicate how many physical links are included (e.g., 1X, 2X, 3X, and 4X on each connector's housing).

5.2.4.1.2.2 SAS internal symmetric cable assembly - SAS 4i

Figure 85 shows the SAS internal symmetric cable assembly with SAS 4i cable receptacle connectors at each end.

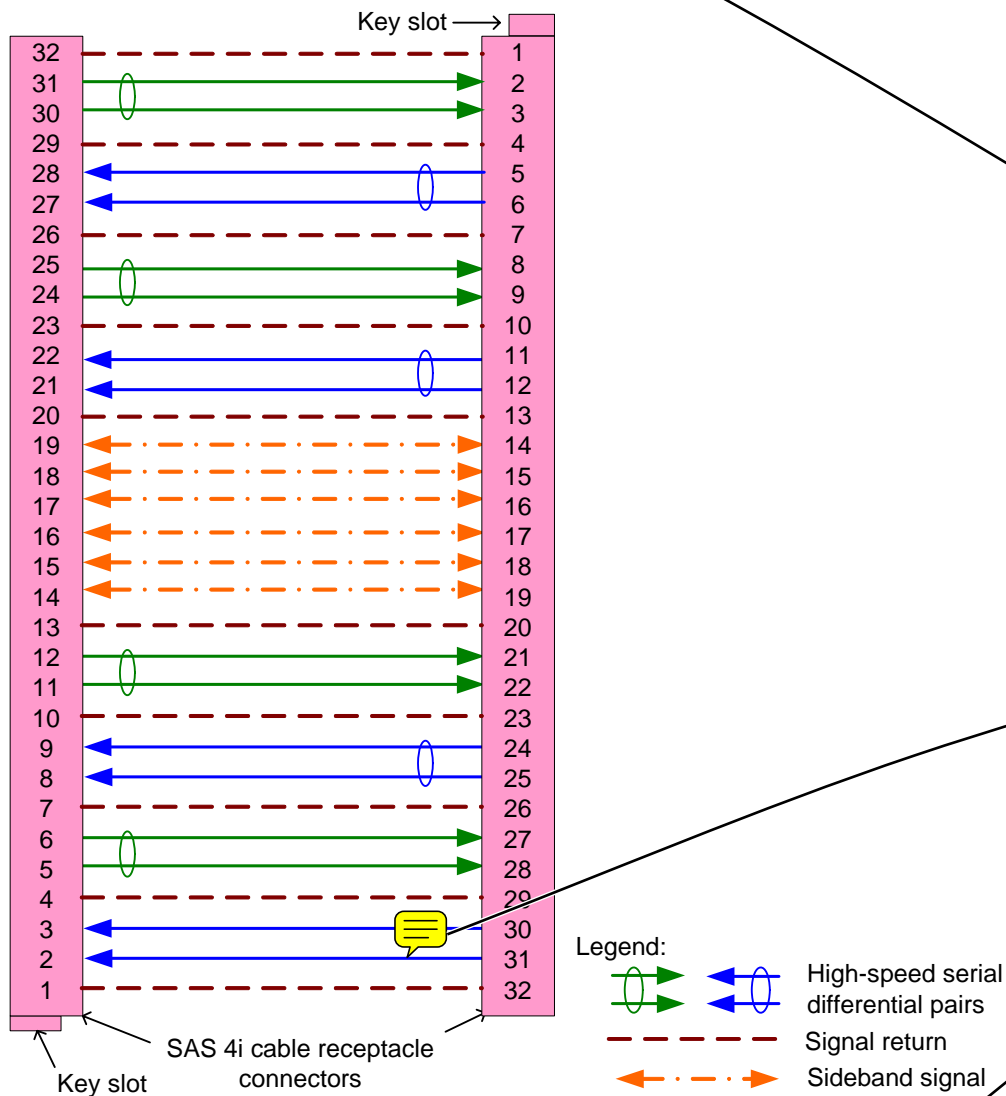



Figure 85 — SAS internal symmetric cable assembly - SAS 4i

In addition to the signal return connections shown in figure 85, the cable assembly may connect one or more of the signal returns together.

Page: 146

● Author: Isi-gpenokie
Subject: Cross-Out
Date: 5/6/2008 4:07:48 PM
 ACCEPT - DONE

This is an extra one.

● Author: wdc-mevans
Subject: Highlight
Date: 5/24/2008 10:58:47 AM
 REJECT (but rewrote this paragraph)
Mini
s/b
assemblies with Mini

● Author: wdc-mevans
Subject: Highlight
Date: 5/24/2008 10:58:59 AM
 REJECT (but rewrote this paragraph)
a SAS
s/b
assemblies with a SAS

● Author: wdc-mevans
Subject: Highlight
Date: 5/24/2008 10:59:05 AM
 REJECT (but rewrote this paragraph)
a SAS
s/b
assemblies with a SAS

● Author: wdc-mevans
Subject: Highlight
Date: 5/24/2008 10:59:09 AM
 REJECT (but rewrote this paragraph)
a Mini
s/b
assemblies with a Mini

● Author: hpq-bolawsky
Subject: Note
Date: 5/6/2008 4:07:48 PM
 ACCEPT - DONE
Pair on pins 30/31 routed to pins 2/3 do not have circle indicating foil return.

● Author: RElliott
Subject: Underline
Date: 6/30/2008 6:16:52 PM
 ACCEPT - DONE
the cable assembly
s/b
this cable assembly

For controller-to-backplane applications, the cable assembly may support one to four physical links. SIDEBAND signals on the controller are attached to the corresponding SIDEBAND signals on the backplane (e.g., SIDEBAND0 of the controller is attached to SIDEBAND0 of the backplane).

For controller-to-controller applications, the cable assembly shall support all four physical links and the controllers should use all four physical links, because one controller's physical links 0 and 1 are attached the other controller's physical links 3 and 2, respectively. If both controllers use one or two physical links starting with physical links 0, communication is not possible. If both controllers use physical links 0, 1, and 2, then only communication over physical links 1 and 2 is possible. SIDEBAND signals on one controller are not attached to their corresponding SIDEBAND signals on the other controller (e.g., SIDEBAND0 of one controller is attached to SIDEBAND5 of the other controller).

5.2.4.1.2.3 SAS internal symmetric cable assembly - Mini SAS 4i

Figure 86 shows the SAS internal cable assembly with Mini SAS 4i cable plug connectors at each end.

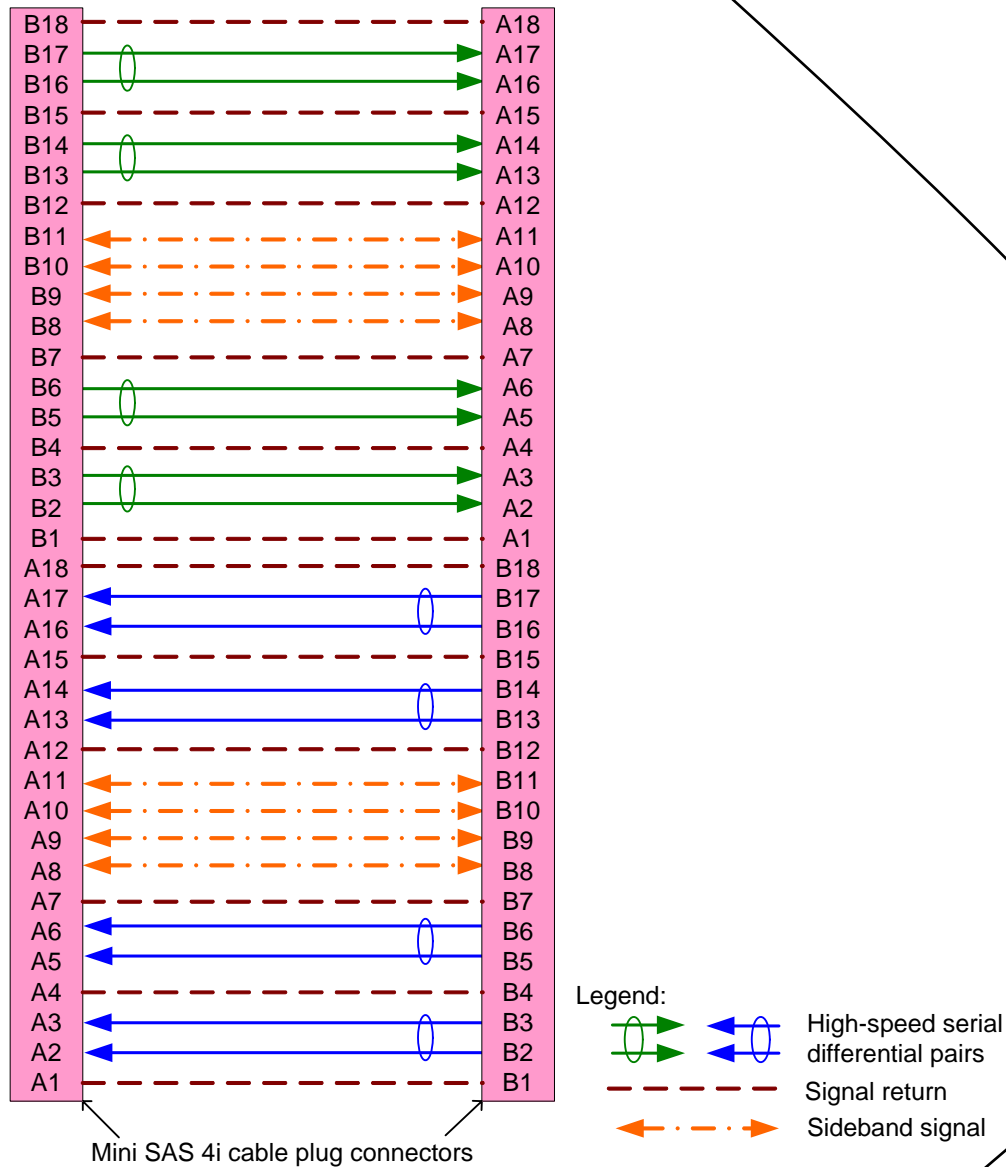

Figure 86 — SAS internal symmetric cable assembly - Mini SAS 4i

In addition to the signal return connections shown in figure 86, the cable assembly may connect one or more of the signal returns together.

● Author: RElliott
Subject: Underline
Date: 6/30/2008 6:16:52 PM
T ACCEPT - DONE

the cable assembly
s/b
this cable assembly

● Author: RElliott
Subject: Underline
Date: 6/30/2008 6:16:52 PM
T ACCEPT - DONE

the cable assembly
s/b
this cable assembly

● Author: lsi-gpenokie
Subject: Highlight
Date: 5/6/2008 4:07:48 PM

T REJECT (i.e. means "in other words", but this is not restating the first part of the sentence, it's explaining the reason for the first part. Expanding "physical links 0 and 1" to "physical link 0 and physical link 1" is too wordy and degrades readability.)

This << physical links, because one controller's physical links 0 and 1 are attached the other controller's physical links 3 and 2, respectively.>> should be << links, (i.e., one controller's physical link 0 and physical link 1 are attached to the other controller's physical link 3 and physical link 2, respectively). >>

● Author: lsi-gpenokie
Subject: Highlight
Date: 5/6/2008 4:07:48 PM

T REJECT (too wordy and degrades readability.)

This << use physical links 0, 1, and 2, then only >> should be << use physical link 0, physical link 1, and physical link 2, then only >>

● Author: lsi-gpenokie
Subject: Highlight
Date: 5/6/2008 4:07:48 PM

T REJECT (too wordy and degrades readability)

This << over physical links 1 and 2 is possible >> should be << over physical link 1 and physical link 2 is possible >>

● Author: RElliott
Subject: Underline
Date: 6/30/2008 6:16:52 PM
T ACCEPT - DONE

the cable assembly
s/b
this cable assembly

The cable assembly may support one to four physical links.

For controller-to-backplane applications, SIDEBAND signals on the controller are attached to the corresponding SIDEBAND signals on the backplane (e.g., SIDEBAND0 of the controller is attached to SIDEBAND0 of the backplane).

For controller-to-controller applications, SIDEBAND signals on one controller are not attached to their corresponding SIDEBAND signals on the other controller (e.g., SIDEBAND0 of one controller is attached to SIDEBAND6 of the other controller).

5.2.4.1.2.4 SAS internal symmetric cable assembly - SAS 4i to Mini SAS 4i with vendor-specific sidebands

Figure 87 shows the SAS internal symmetric cable assembly with a SAS 4i cable receptacle connector at one end and a Mini SAS 4i cable plug connector at the other end, with vendor-specific sidebands.

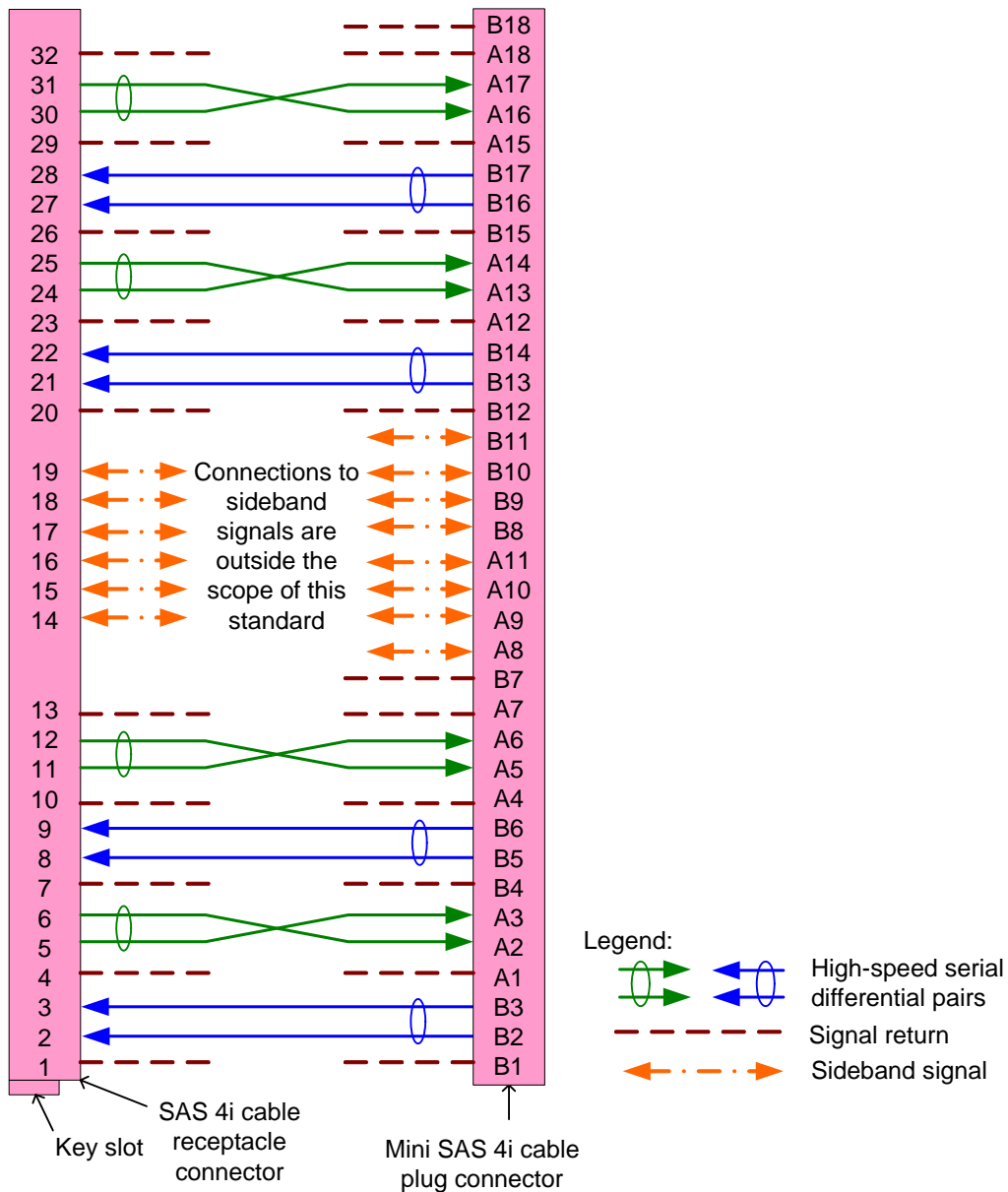

Figure 87 — SAS internal symmetric cable assembly - SAS 4i to Mini SAS 4i with vendor-specific sidebands

Author: RElliott
Subject: Underline
Date: 6/30/2008 6:16:52 PM
T ACCEPT - DONE

the cable assembly
s/b
this cable assembly

NOTE 20 - The cable assembly needs different SIDEBAND signal routing based on whether the controller or backplane is using the SAS 4i connector.

The cable assembly shall connect each signal return on one end to at least one signal return on the other end.
The cable assembly may connect one or more of the signal returns together.

For controller-to-backplane applications with the SAS 4i cable receptacle connector on the controller end, the cable assembly may support one to four physical links.

For controller-to-controller applications, the cable assembly may support one to four physical links.

For controller-to-backplane applications with the Mini SAS 4i cable receptacle connector on the controller end, the cable assembly shall support all four physical links and the controller should use all four physical links, because the controller's physical links 0, 1, 2, and 3 are attached to the backplane's physical links 3, 2, 1, and 0, respectively. If both controllers use one or two physical links starting with physical links 0, communication is not possible. If both controllers use physical links 0, 1, and 2, then only communication over physical links 1 and 2 is possible.

Author: RElliott
Subject: Underline
Date: 6/30/2008 6:16:52 PM
T ACCEPT - DONE

the cable assembly
s/b
this cable assembly

Author: RElliott
Subject: Underline
Date: 6/30/2008 6:16:52 PM
T ACCEPT - DONE

the cable assembly
s/b
this cable assembly

Author: RElliott
Subject: Highlight
Date: 6/30/2008 6:16:52 PM
T ACCEPT - DONE

The
s/b
This

throughout this section, to make it clearer that these rules only apply to the connector in figure 87

Author: RElliott
Subject: Underline
Date: 6/30/2008 6:16:52 PM
T ACCEPT - DONE

the cable assembly
s/b
this cable assembly

Author: RElliott
Subject: Underline
Date: 6/30/2008 6:16:52 PM
T ACCEPT - DONE

the cable assembly
s/b
this cable assembly

Author: RElliott
Subject: Underline
Date: 6/30/2008 6:16:52 PM
T ACCEPT - DONE

the cable assembly
s/b
this cable assembly

NOTE 20 - The cable assembly needs different SIDEBAND signal routing based on whether the controller or backplane is using the SAS 4i connector.

The cable assembly shall connect each signal return on one end to at least one signal return on the other end. The cable assembly may connect one or more of the signal returns together.

For controller-to-backplane applications with the SAS 4i cable receptacle connector on the controller end, the cable assembly may support one to four physical links.

For controller-to-controller applications, the cable assembly may support one to four physical links.

For controller-to-backplane applications with the Mini SAS 4i cable receptacle connector on the controller end, the cable assembly shall support all four physical links and the controller should use all four physical links, because the controller's physical links 0, 1, 2, and 3 are attached to the backplane's physical links 3, 2, 1, and 0, respectively. If both controllers use one or two physical links starting with physical links 0, communication is not possible. If both controllers use physical links 0, 1, and 2, then only communication over physical links 1 and 2 is possible.

Author: hpq-bolawsky
Subject: Note
Date: 6/9/2008 2:47:38 PM

 REJECT (this is in the "SAS 4i to Mini SAS 4i with vendor-specific sidebands" section, which constrains the statements correctly. The section is about the cable assemblies with SGPIO and explicit controller/backplane sides do not include this paragraph. Changing "The cable assembly" to "This cable assembly" throughout to clarify this.)

Lane reversal is only an issue with using the "SAS 4i controller to Mini SAS 4i backplane" cable in an application where the controller is a Mini SAS version. We now have two cable pinouts and use of the "Mini SAS 4i controller to SAS 4i backplane" cable will eliminate the reversal issue. This paragraph needs to be updated based on the addition of the latter pinout option.

Author: RElliott
Subject: Underline
Date: 6/30/2008 6:16:52 PM

 ACCEPT - DONE

the cable assembly
s/b
this cable assembly

Author: lsi-gpenokie
Subject: Highlight
Date: 5/6/2008 4:07:48 PM

 REJECT (see previous section)

This << physical links, because the controller's physical links 0, 1, 2, and 3 are attached to the backplane's physical links 3, 2, 1, and 0, respectively. >> should be << physical links (i.e., the controller's physical link 0, physical link 1, physical link 2, and physical link 3 are attached to the backplane's physical link 3, physical link 2, physical link 1, and physical link 0, respectively. >>

Author: RElliott
Subject: Underline
Date: 6/30/2008 6:16:52 PM

 ACCEPT - DONE

both controllers
s/b
both the controller and the backplane

(from Alvin)

Author: RElliott
Subject: Underline
Date: 6/30/2008 6:16:52 PM

 ACCEPT - DONE

both controllers
s/b
both the controller and the backplane

(from Alvin)

Author: lsi-gpenokie
Subject: Highlight
Date: 5/6/2008 4:07:48 PM

 REJECT (see previous section)

This << physical links 0, 1, and 2, then only communication over physical links 1 and 2 is possible >> should be << physical link 0, physical link 1, and physical link 2, then only communication over physical link 1 and physical link 2 is possible >>

5.2.4.1.2.5 SAS internal symmetric cable assembly - SAS 4i controller to Mini SAS 4i backplane with SGPIO

Figure 88 shows the SAS internal symmetric cable assembly with a SAS 4i cable receptacle connector at the controller end and a Mini SAS 4i cable plug connector at the backplane end, with sidebands connected to support SGPIO (see SFF-8485).

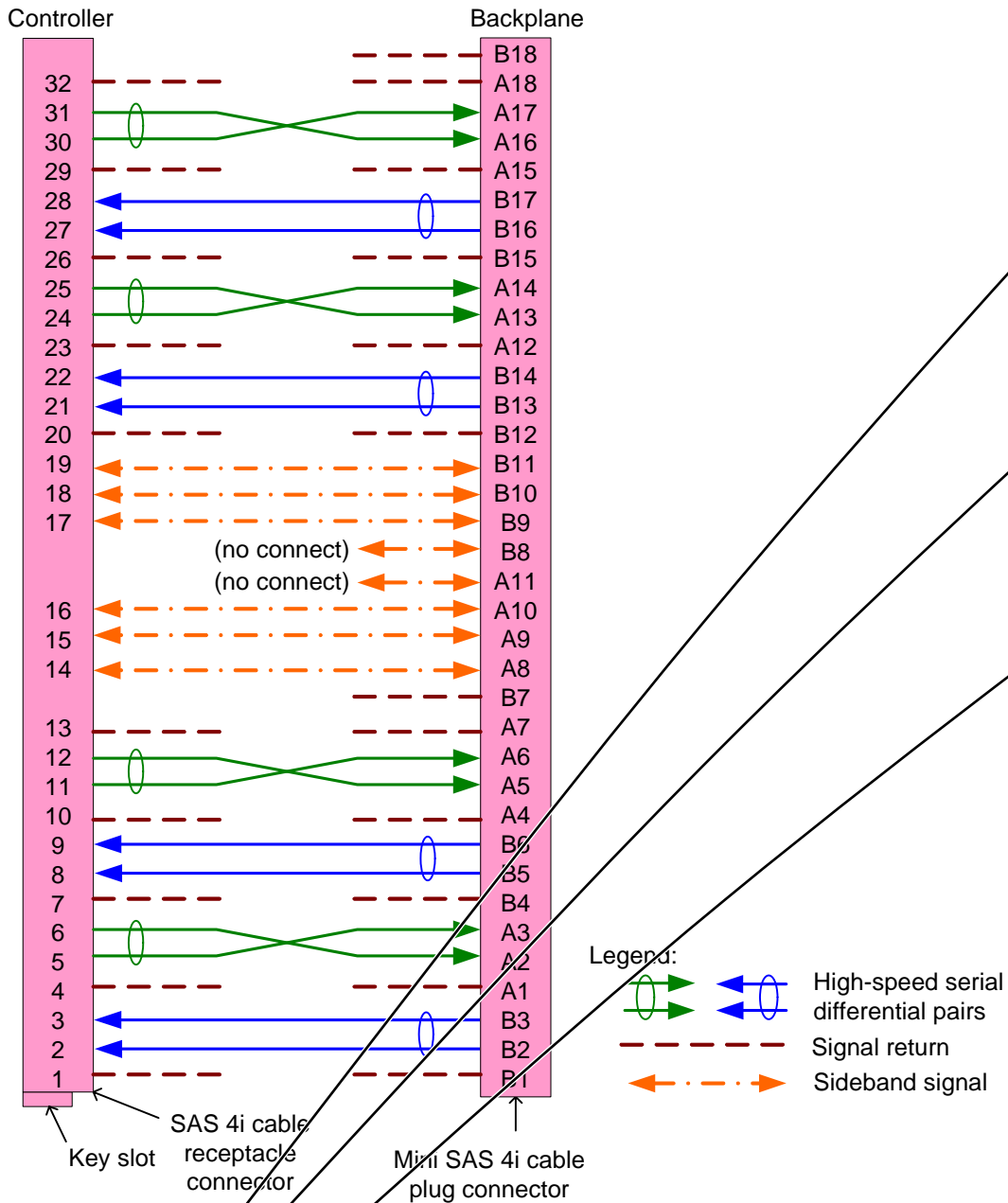

Figure 88 — SAS internal symmetric cable assembly - SAS 4i controller to Mini SAS 4i backplane with SGPIO

The cable assembly shall connect each signal return on one end to at least one signal return on the other. The cable assembly may connect one or more of the signal returns together.

The cable assembly may support one to four physical links.

● Author: RElliott
Subject: Underline
Date: 6/30/2008 6:16:52 PM
T ACCEPT - DONE

the cable assembly
s/b
this cable assembly

● Author: RElliott
Subject: Underline
Date: 6/30/2008 6:16:52 PM
T ACCEPT - DONE

the cable assembly
s/b
this cable assembly

● Author: RElliott
Subject: Underline
Date: 6/30/2008 6:16:52 PM
T ACCEPT - DONE

the cable assembly
s/b
this cable assembly

5.2.4.1.2.6 SAS internal symmetric cable assembly - Mini SAS 4i controller to SAS 4i backplane with SGPIO

Figure 89 shows the SAS internal symmetric cable assembly with a Mini SAS 4i cable receptacle connector at the controller end and a SAS 4i cable plug connector at the backplane end, with sidebands connected to support SGPIO (see SFF-8485).

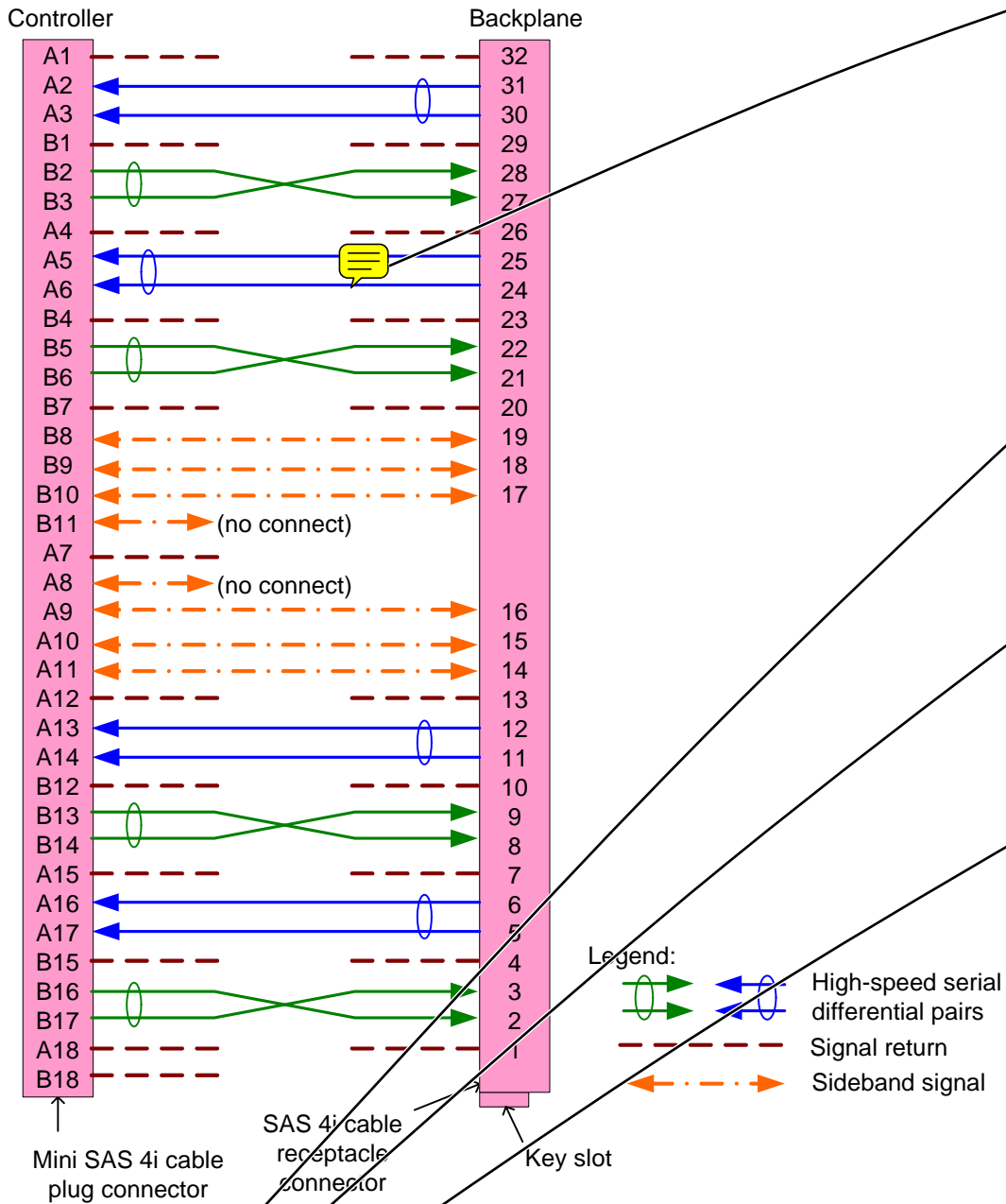



Figure 89 — SAS internal symmetric cable assembly - Mini SAS 4i controller to SAS 4i backplane with SGPIO

The cable assembly shall connect each signal return on one end to at least one signal return on the other end. The cable assembly may connect one or more of the signal returns together.

The cable assembly may support one to four physical links.

● Author: hpq-bolawsky
Subject: Note
Date: 5/6/2008 4:07:48 PM
 ACCEPT - DONE

Positioning of the foil return graphic for pins A5/A6 is in wrong location.

● Author: RElliott
Subject: Underline
Date: 6/30/2008 6:16:52 PM
 ACCEPT - DONE

the cable assembly
s/b
this cable assembly

● Author: RElliott
Subject: Underline
Date: 6/30/2008 6:16:52 PM
 ACCEPT - DONE

the cable assembly
s/b
this cable assembly

● Author: RElliott
Subject: Underline
Date: 6/30/2008 6:16:52 PM
 ACCEPT - DONE

the cable assembly
s/b
this cable assembly

5.2.4.1.3 SAS internal fanout cable assemblies

5.2.4.1.3.1 SAS internal fanout cable assemblies overview

There are several types of SAS internal fanout cable assemblies:

- a) SAS internal controller-based fanout cable assemblies (see 5.2.4.1.3.2) with:
 - A) a SAS 4i cable receptacle connector on one end (i.e., the controller end) and four SAS Drive cable receptacle connectors on the other end (i.e., the backplane end); and
 - B) a Mini SAS 4i cable plug connector on one end (i.e., the controller end) and four SAS Drive cable receptacle connectors on the other end (i.e., the backplane end);and
- b) SAS internal backplane-based fanout cable assemblies (see 5.2.4.1.3.3) with:
 - A) four SATA signal cable receptacle connectors on one end (i.e., the controller end) and a SAS 4i cable receptacle connector on the other end (i.e., the backplane end); and
 - B) four SATA signal cable receptacle connectors on one end (i.e., the controller end) and a Mini SAS 4i cable plug connector on the other end (i.e., the backplane end).

In a SAS internal fanout symmetric cable assembly, the Tx signals on one end shall be connected to Rx signals on the other end (e.g., a Tx + of one connector shall connect to an Rx + of the other connector).

● Author: RElliott
Subject: Highlight
Date: 6/30/2008 6:16:52 PM
T ACCEPT - DONE

There are several types of SAS internal fanout cable assemblies:

s/b

A SAS internal fanout cable assembly is either:
and change "and"s to "or"s

● Author: Isi-gpenokie
Subject: Highlight
Date: 5/6/2008 4:07:48 PM
T ACCEPT - DONE

This is a missing <<) >> It should be << to an Rx + of the other connector). >>

5.2.4.1.3.2 SAS internal controller-based fanout cable assemblies

Figure 90 shows the SAS internal controller-based fanout cable assembly with a SAS 4i cable receptacle connector at the controller end.

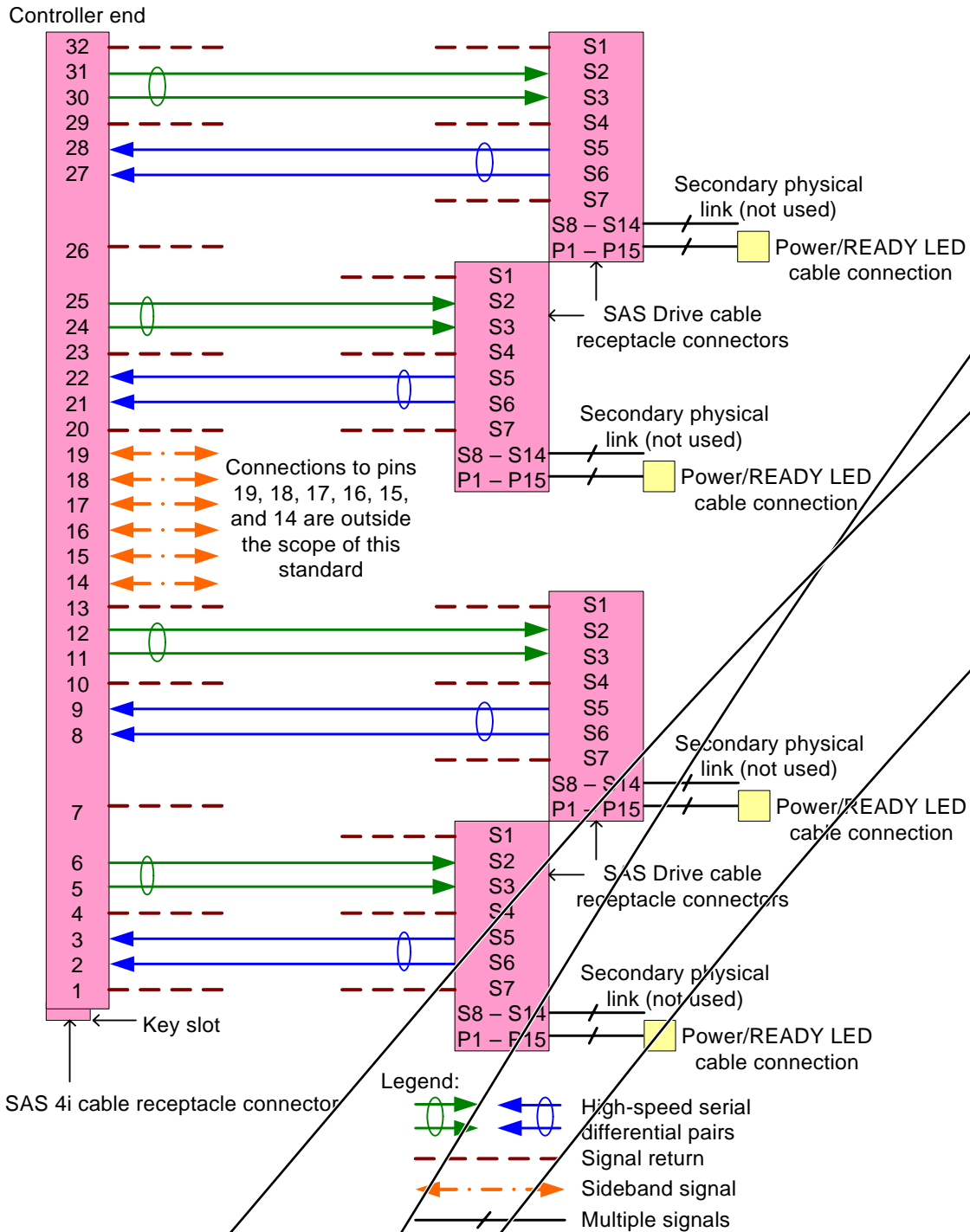

Figure 90 — SAS internal controller-based fanout cable assembly - SAS 4i

The cable assembly shown in figure 90 shall connect each signal return on one end to at least one signal return on the other end. The cable assembly may connect one or more of the signal returns together.

● Author: RElliott
Subject: Cross-Out
Date: 6/30/2008 6:16:52 PM
T ACCEPT - DONE

shown in figure 90

● Author: RElliott
Subject: Underline
Date: 6/30/2008 6:16:52 PM
T ACCEPT - DONE

the cable assembly
s/b
this cable assembly

● Author: RElliott
Subject: Underline
Date: 6/30/2008 6:16:52 PM
T ACCEPT - DONE

the cable assembly
s/b
this cable assembly

Figure 91 shows the SAS internal controller-based fanout cable assembly with a Mini SAS 4i cable plug connector at the controller end.

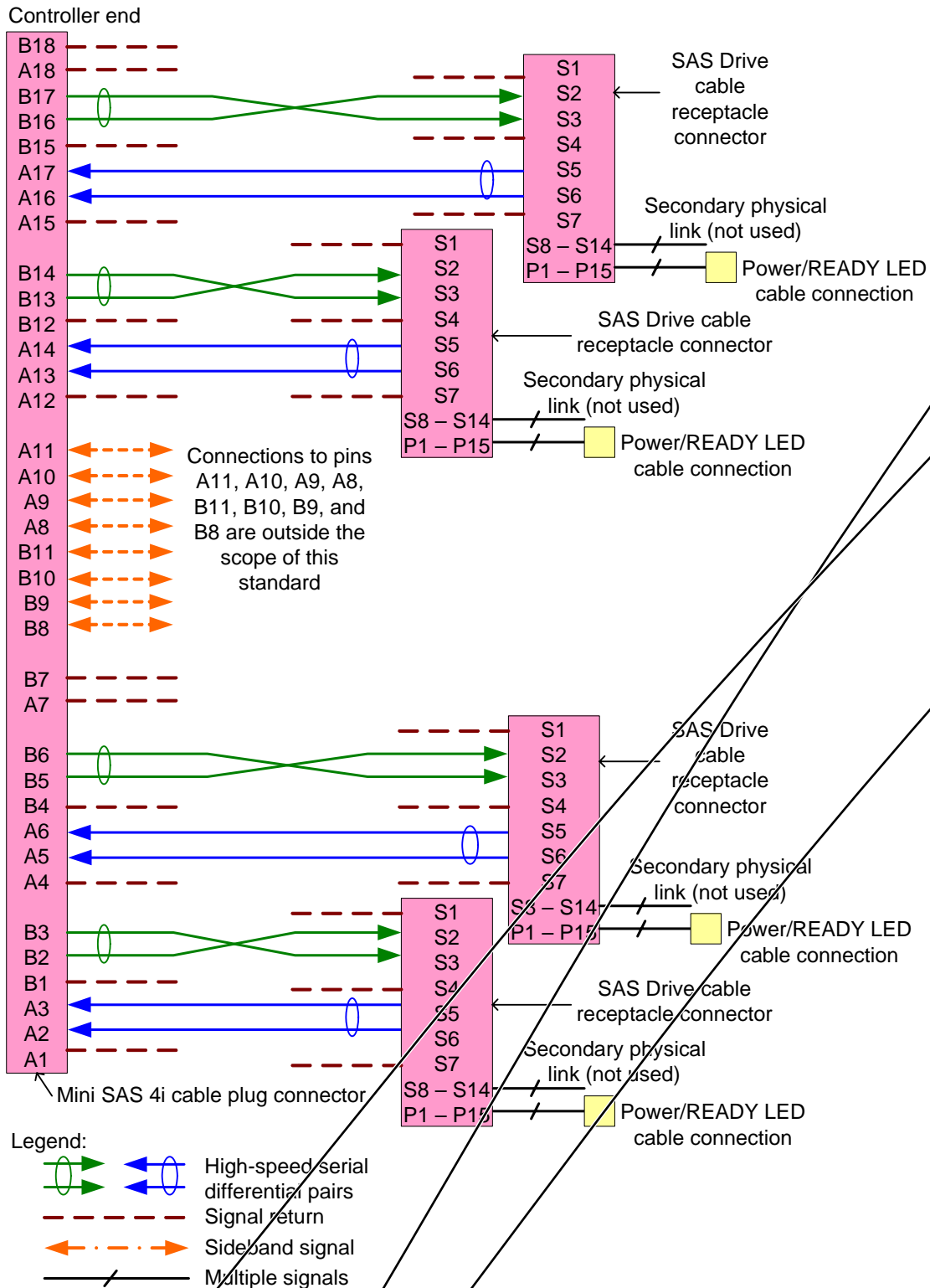

Figure 91 — SAS internal controller-based fanout cable assembly - Mini SAS 4i

The cable assembly shown in figure 91 shall connect each signal return on one end to at least one signal return on the other end. The cable assembly may connect one or more of the signal returns together.

● Author: RElliott
Subject: Cross-Out
Date: 6/30/2008 6:16:52 PM
T ACCEPT - DONE

shown in figure 91

● Author: RElliott
Subject: Underline
Date: 6/30/2008 6:16:52 PM
T ACCEPT - DONE

the cable assembly
s/b
this cable assembly

● Author: RElliott
Subject: Underline
Date: 6/30/2008 6:16:52 PM
T ACCEPT - DONE

the cable assembly
s/b
this cable assembly

5.2.4.1.3.3 SAS internal backplane-based fanout cable assemblies

Figure 92 shows the SAS internal backplane-based fanout cable assembly with the SAS 4i cable receptacle connector.

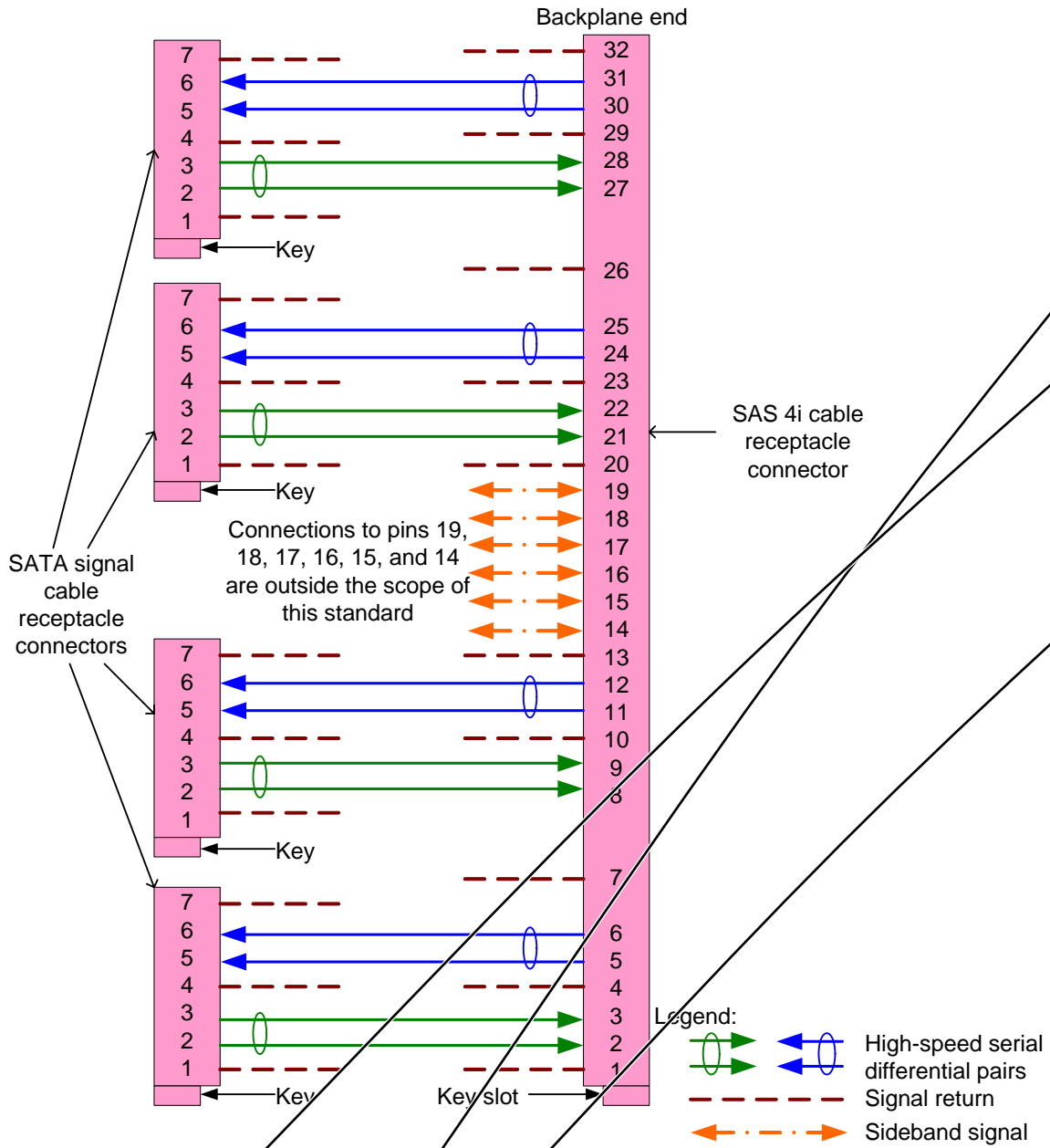

Figure 92 -- SAS internal backplane-based fanout cable assembly - SAS 4i

The cable assembly shown in figure 92 shall connect each signal return on one end to at least one signal return on the other end. The cable assembly may connect one or more of the signal returns together.

● Author: RElliott
Subject: Cross-Out
Date: 6/30/2008 6:16:52 PM
T ACCEPT - DONE

shown in figure 92

● Author: RElliott
Subject: Underline
Date: 6/30/2008 6:16:52 PM
T ACCEPT - DONE

the cable assembly
s/b
this cable assembly

● Author: RElliott
Subject: Underline
Date: 6/30/2008 6:16:52 PM
T ACCEPT - DONE

the cable assembly
s/b
this cable assembly

Figure 93 shows the SAS internal backplane-based fanout cable assembly with the Mini SAS 4i cable receptacle connector.

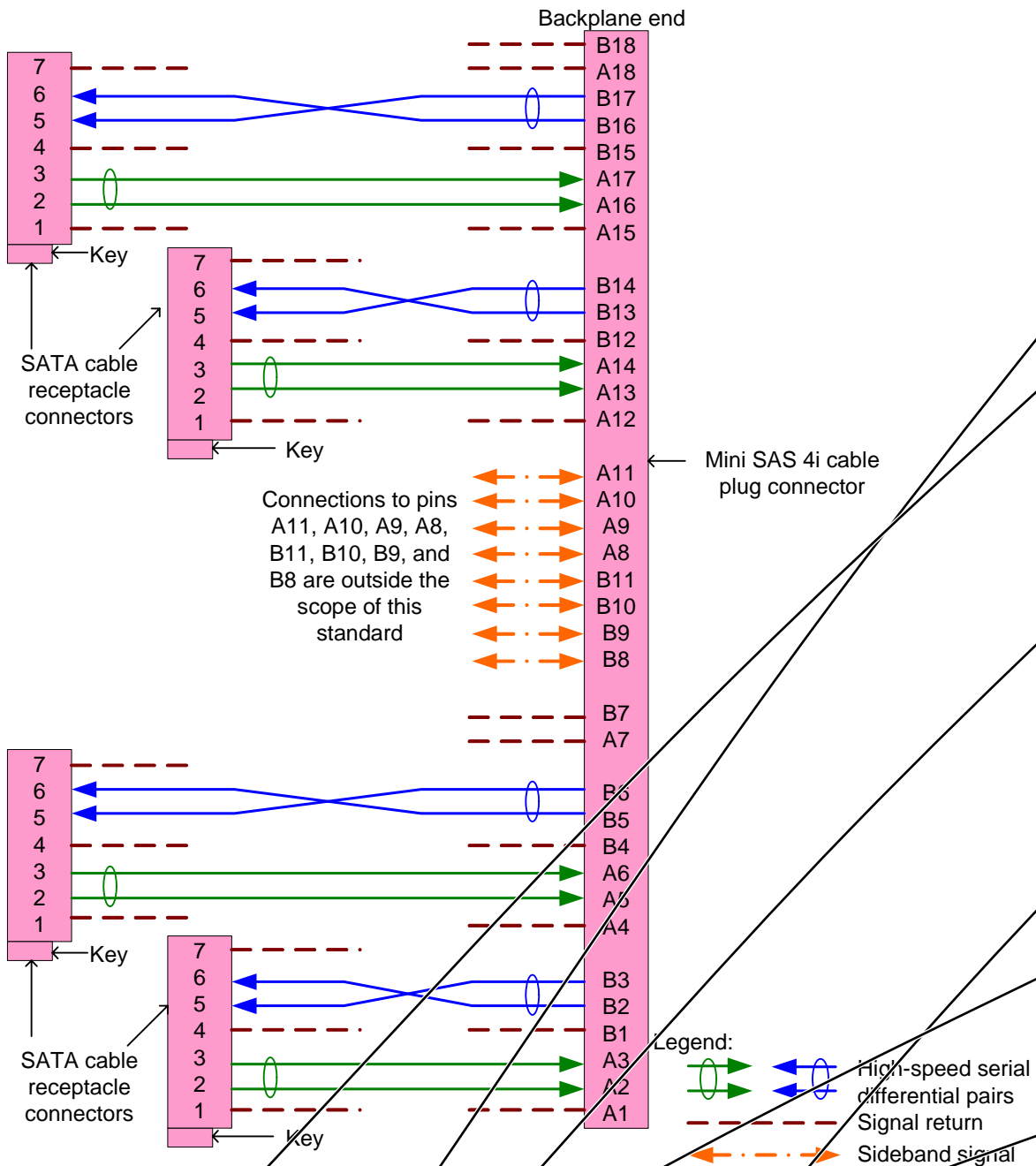

Figure 93 — SAS internal backplane-based fanout cable assembly — Mini SAS 4i

The cable assembly shown in figure 93 shall connect each signal return on one end to at least one signal return on the other end. The cable assembly may connect one or more of the signal returns together.

5.2.4.2 SAS external cable assemblies

5.2.4.2.1 SAS external cable assemblies overview

There are several types of SAS external cable assemblies:

- a) SAS 4x cable plug connector (see 5.2.3.3.1.1) at each end (see 5.2.4.2.2);
- b) Mini SAS 4x cable plug connector (see 5.2.3.3.2.1) at each end (see 5.2.4.2.3); and

● Author: RElliott
Subject: Cross-Out
Date: 6/30/2008 6:16:52 PM

T ACCEPT - DONE

Delete "shown in figure 93" to match other wording

● Author: RElliott
Subject: Underline
Date: 6/30/2008 6:16:52 PM

T ACCEPT - DONE

the cable assembly
s/b
this cable assembly

● Author: RElliott
Subject: Underline
Date: 6/30/2008 6:16:52 PM

T ACCEPT - DONE

the cable assembly
s/b
this cable assembly

● Author: RElliott
Subject: Highlight
Date: 6/30/2008 6:16:52 PM

T ACCEPT - DONE

There are several types of SAS external cable assemblies:
s/b
A SAS external cable assembly has:
and change "and" to "or"

● Author: wdc-mevans
Subject: Highlight
Date: 5/24/2008 11:04:11 AM

T REJECT (but rewrote paragraph and made this singular)

SAS
s/b
assemblies with a SAS

● Author: wdc-mevans
Subject: Highlight
Date: 5/24/2008 11:03:55 AM

T REJECT (but rewrote paragraph and made this singular)

Mini
s/b
assemblies with a Mini

- c) SAS 4x cable plug connector at one end and Mini SAS 4x cable plug connector at the other end (see 5.2.4.2.4).

SAS external cable assemblies do not include power or the READY LED signal.

Although the connector always supports four physical links, a SAS external cable assembly may support one, two, three, or four physical links. SAS external cable assemblies should be labeled to indicate how many physical links are included (e.g., 1X, 2X, 3X, and 4X on each connector's housing)

The Tx signals on one end shall be connected to the corresponding Rx signals of the other end (e.g., Tx 0+ of one connector shall be connected to Rx 0+ of the other connector).

Signal returns shall not be connected to CHASSIS GROUND in the cable assembly.

In addition to the SAS icon (see Annex M), additional icons are defined for external connectors to guide users into making compatible attachments (i.e., not attaching expander device table routing phys to expander device table routing phys in externally configurable expander devices, which is not allowed by this standard). Connectors that have one or more matching icons are intended to be attached. Connectors that do not have a matching icon should not be attached together.

One end of the SAS external cable assembly shall support being attached to an end device, an enclosure out port, or an enclosure universal port. The other end of the SAS external cable assembly shall support being attached to an end device, an enclosure in port, or an enclosure universal port. If a SAS 4x cable plug connector is used, it should include icons as defined in 5.2.3.3.1.1. If a Mini SAS 4x cable plug connector is used, it shall include icons and key slots as defined in 5.2.3.3.2.1.

5.2.4.2.2 SAS external cable assembly - SAS 4x

Figure 94 shows the SAS external cable assembly with SAS 4x cable plug connectors at each end.

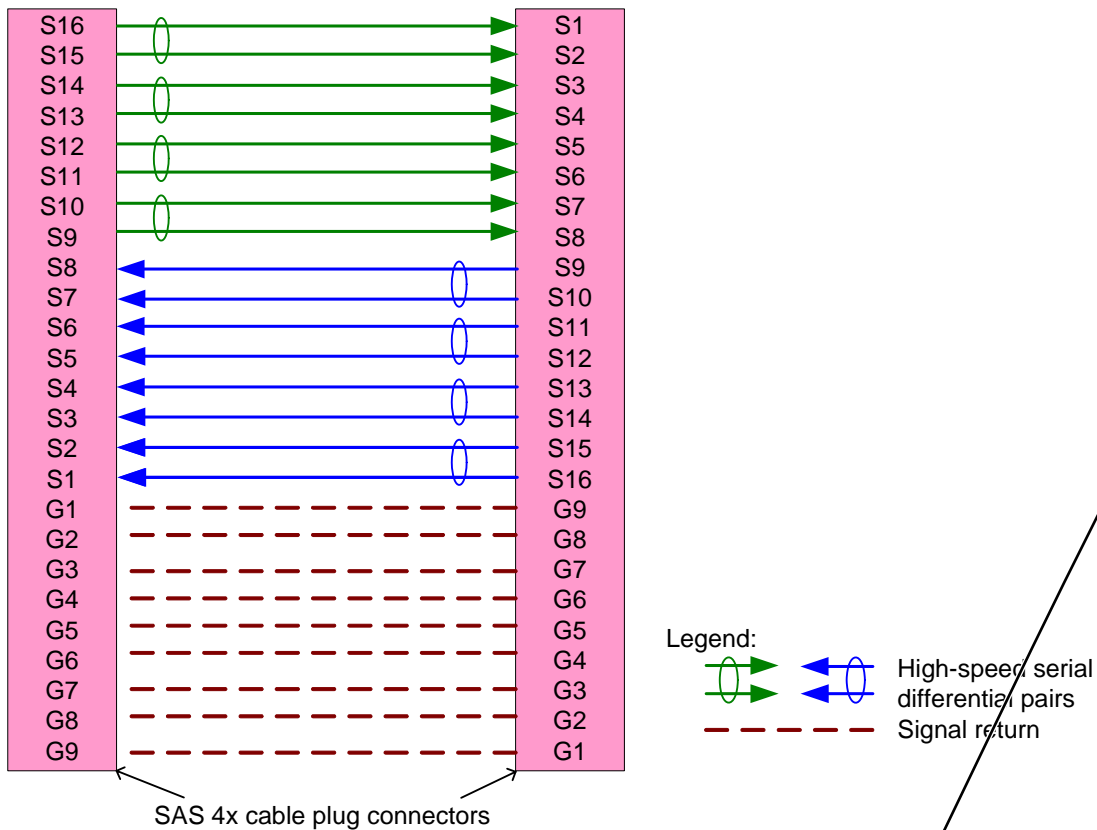

Figure 94 — SAS external cable assembly - SAS 4x

In addition to the signal return connections shown in figure 94, the cable assembly may connect one or more of the signal returns together.

● Author: wdc-mevans
Subject: Highlight
Date: 5/24/2008 11:02:40 AM

T ACCEPT - DONE
and Mini
s/b
and a Mini

● Author: wdc-mevans
Subject: Highlight
Date: 5/24/2008 11:02:19 AM

T REJECT (but rewrote paragraph)
SAS
s/b
assemblies with a SAS

● Author: lsi-gpenokie
Subject: Highlight
Date: 5/6/2008 4:07:48 PM

T REJECT (degrades readability)

This << may support one, two, three, or four physical links. SAS >> should be << may support one physical link, two physical links, three physical links, or four physical links. SAS >>

● Author: RElliott
Subject: Underline
Date: 6/30/2008 6:16:52 PM

T ACCEPT - DONE

the cable assembly
s/b
this cable assembly

5.2.4.2.3 SAS external cable assembly - Mini SAS 4x

Figure 95 shows the SAS external cable assembly with Mini SAS 4x cable plug connectors at each end.

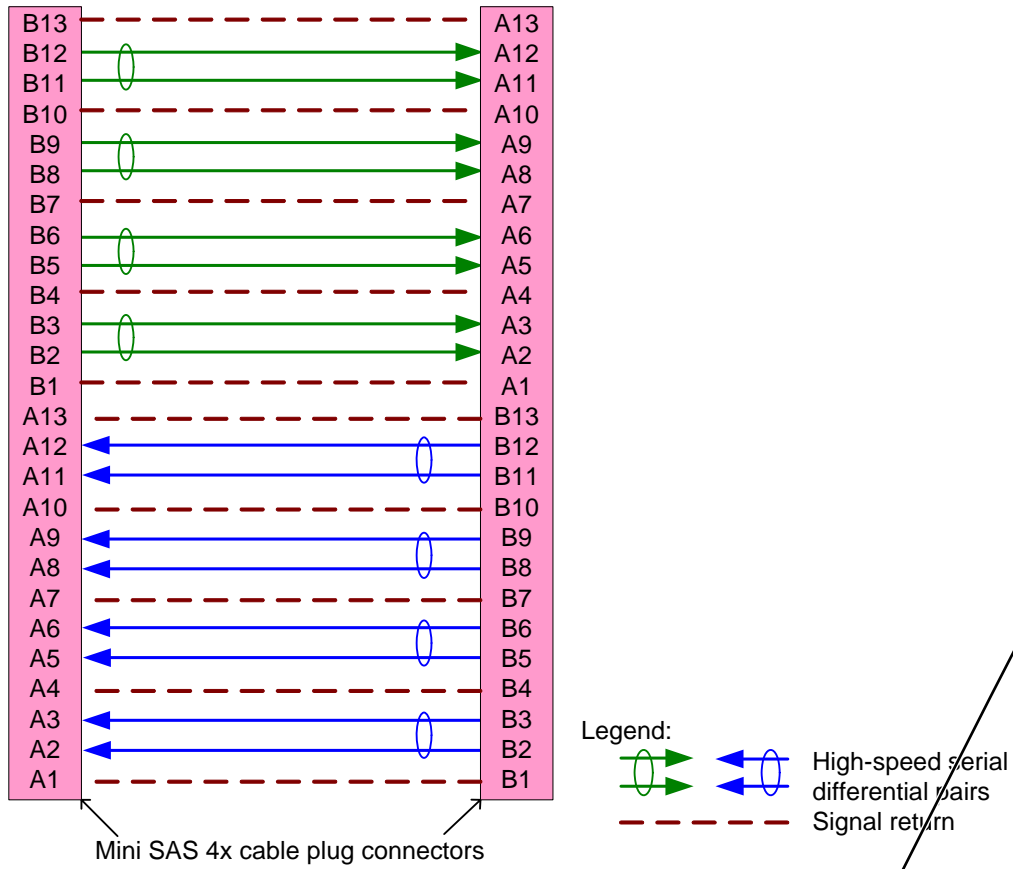

Figure 95 — SAS external cable assembly - Mini SAS 4x

In addition to the signal return connections shown in figure 95, the cable assembly may connect one or more of the signal returns together.

Author: RElliott
Subject: Underline
Date: 6/30/2008 6:16:52 PM
TACCEPT - DONE

the cable assembly
s/b
this cable assembly

Figure 96 shows the icons and key slots in the SAS external cable assembly with Mini SAS 4x cable plug connectors at each end.

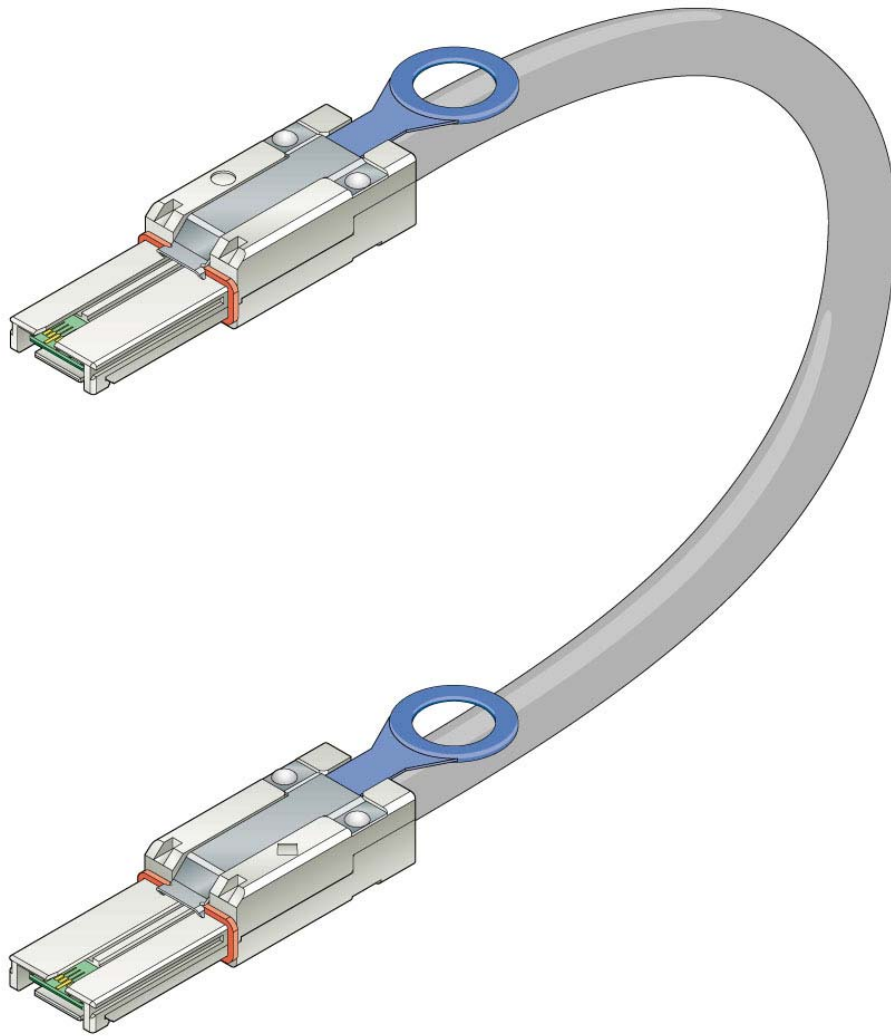

Figure 96 — SAS external cable assembly with Mini SAS 4x cable plug connectors

Although the topology is supported by this standard, a SAS external cable assembly with Mini SAS 4x connectors on each end that attaches an enclosure in port to another enclosure in port is not defined by this standard.

This page contains no comments

5.2.4.2.4 SAS external cable assembly - SAS 4x to Mini SAS 4x

Figure 97 shows the SAS external cable assembly with a SAS 4x cable plug connector at one end and a Mini SAS 4x cable plug connector at the other end.

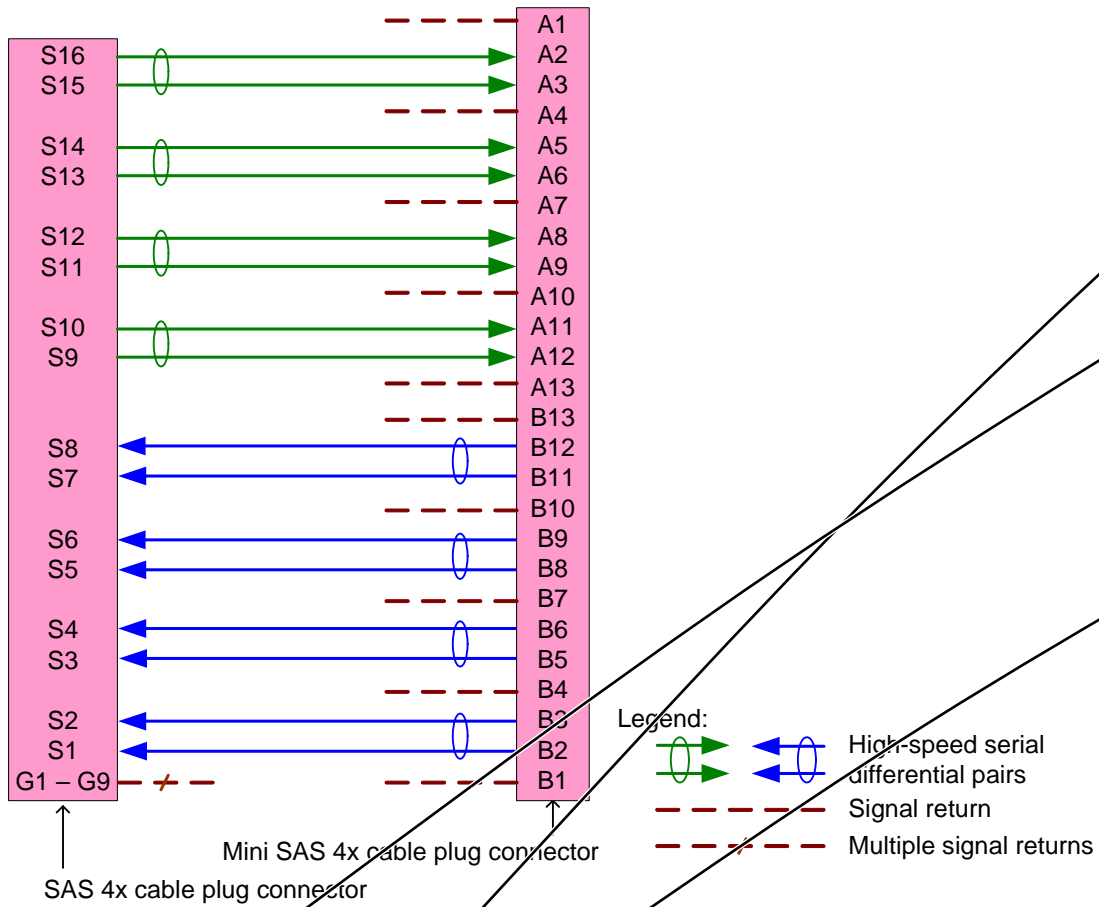

Figure 97 — SAS external cable assembly - SAS 4x to Mini SAS 4x

The cable assembly shown in figure 97 shall connect each signal return on one end to at least one signal return on the other end. The cable assembly may connect one or more of the signal returns together.

5.2.5 Backplanes

SAS backplane designs should follow the recommendations in SFF-8460.

● Author: RElliott
Subject: Cross-Out
Date: 6/30/2008 6:16:52 PM
T ACCEPT - DONE

shown in figure 97

● Author: RElliott
Subject: Underline
Date: 6/30/2008 6:16:52 PM
T ACCEPT - DONE

the cable assembly
s/b
this cable assembly

● Author: RElliott
Subject: Underline
Date: 6/30/2008 6:16:52 PM
T ACCEPT - DONE

the cable assembly
s/b
this cable assembly

5.2.6 Cable assembly and backplane specifications

Table 50 defines the general characteristics of cable assemblies and backplanes.

Table 50 — General characteristics of cable assemblies and backplanes

Characteristic ^{a, b}	Units	Value
Bulk cable or backplane: ^{c, d}		
Differential characteristic impedance	ohm	100
Mated connectors:		
Differential characteristic impedance ^e	ohm	100
Cable assembly and backplane:		
Minimum $ S_{DD21} $ for internal cable assemblies ^{f, g}	dB	-6
Minimum $ S_{DD21} $ for external cable assemblies and backplanes	See 5.3.3.3	
<p>^a All measurements are made through mated connector pairs.</p> <p>^b The equivalent maximum TDR rise time from 20 % to 80 % shall be 70 ps. Filtering may be used to obtain the equivalent rise time. The filter consists of the two-way launch/return path of the test fixture, the two-way launch/return path of the test cable, and the software or hardware filtering of the TDR scope. The equivalent rise time is the rise time of the TDR scope output after application of all filter components. When configuring software or hardware filters of the TDR scope to obtain the equivalent rise time, filtering effects of test cables and test fixtures shall be included.</p> <p>^c The impedance measurement identifies the impedance mismatches present in the bulk cable or backplane when terminated in its characteristic impedance. This measurement excludes mated connectors at both ends of the bulk cable or backplane, when present, but includes any intermediate connectors or splices.</p> <p>^d Where the bulk cable or backplane has an electrical length of > 4 ns the procedure detailed in SFF-8410, or an equivalent procedure, shall be used to determine the impedance.</p> <p>^e The characteristic impedance is a measurement reference impedance for the test environment.</p> <p>^f An internal cable assembly may be a TxRx connection segment or a full TxRx connection. The full TxRx connection is required to comply with the requirements for intra-enclosure compliance points defined in 5.3.</p> <p>^g The range for this frequency domain measurement is 10 MHz to 4 500 MHz.</p>		

Page: 161

Author: ibm-jay-diepenbrock
Subject: Highlight
Date: 5/24/2008 11:14:18 AM

T REJECT (Alvin: 1) General characteristics are nominal and tolerances are handled by the s-parameter tables. Rob: 2) Intra-pair skew was purposely removed, because it isn't the right parameter to rate the degradation of signal quality (common mode emissions Scd provide a more complete picture), and the SAS-1.1 value was not being honored in many long cables that work fine. See 06-499 and SFF-8416 for discussion. 3) Channels in SAS-2 are qualified by simulation of their s-parameters in a tool like StatEye. This limits how much ISI they may introduce.)

The mated connector end/backplane impedance conditions are nominal values only. Tolerances need to be specified.

The intra-pair skew requirements have been dropped. They should be added back in.

The inter symbol interference (i.e., jitter) requirements should also be added back in.

Author: mxim-mbari
Subject: Note
Date: 9/4/2008 2:44:15 PM

REFER PHYSICAL WG

Impedance value should have min, nom, and max value Or tolerance. TCTF test load in 5.3.2.3 (Page 173) refers back to this section for nominal value

Author: mxim-mbari
Subject: Inserted Text
Date: 5/26/2008 7:54:02 PM

T REJECT (Alvin: Reject. Minimum is correct because more negative (a lower minimum) is a worse condition.)

Minimum insertion loss for cables do not seem logical

Author: RElliott
Subject: Note
Date: 9/4/2008 2:43:01 PM

ACCEPT - DONE (53 ns is decent worst-case number per cable vendors. Added row to the "general electrical characteristics" table right below the Differential impedance row, rather than place in the passive cable section, since this will apply to both passive and SAS-2.1 active cable assemblies.)

The STP flow control budget (section 7.17.2 note 77) assumes 5 ns/m prop delay on a cable. For 10 m, this means:

- one-way prop delay 50 ns
- round-trip prop delay 100 ns
- $26 \frac{2}{3}$ ns per dword at 1.5 Gbps
- $100 / 26 \frac{2}{3} = 3.75$ dwords on the wire at 1.5 Gbps
- $100 / 26 \frac{2}{3} * 2 = 7.5$ dwords at 3 Gbps
- $100 / 26 \frac{2}{3} * 4 = 15$ dwords at 6 Gbps

We use that to justify a buffer size of 4 dwords at 1.5 Gbps, 8 dwords at 3 Gbps, and 16 dwords at 6 Gbps.

However, <http://www.spectra-strip.amphenol.com/ecpartsearch3.cfm?partID=366> says an Amphenol Spectra-Strip cable has 5.1 ns / m nominal propagation delay, longer than our assumption.

What is a good worst-case propagation delay number to use?

If it were 5.3 ns, then we'd be right at the budget:

- $5.3 / 26 \frac{2}{3} = 3.975$ dwords at 6 Gbps
- $5.3 / 26 \frac{2}{3} * 4 = 15.9$ dwords at 6 Gbps

Worst than 5.3 means our budget is not big enough.

We should probably add a rule in chapter 5 that a SAS cable (or any interconnect) must have a total propagation delay of less than 50 ns (or 53 ns... whatever matches note 77).

Comments from page 161 continued on next page

5.2.6 Cable assembly and backplane specifications

Table 50 defines the general characteristics of cable assemblies and backplanes.

Table 50 — General characteristics of cable assemblies and backplanes

Characteristic ^{a, b}	Units	Value
Bulk cable or backplane: ^{c, d}		
Differential characteristic impedance	ohm	100
Mated connectors:		
Differential characteristic impedance ^e	ohm	100
Cable assembly and backplane:		
Minimum $ S_{DD21} $ for internal cable assemblies ^{f, g}	dB	-6
Minimum $ S_{DD21} $ for external cable assemblies and backplanes	See 5.3.3.3	
<p>^a All measurements are made through mated connector pairs.</p> <p>^b The equivalent maximum TDR rise time from 20 % to 80 % shall be 70 ps. Filtering may be used to obtain the equivalent rise time. The filter consists of the two-way launch/return path of the test fixture, the two-way launch/return path of the test cable, and the software or hardware filtering of the TDR scope. The equivalent rise time is the rise time of the TDR scope output after application of all filter components. When configuring software or hardware filters of the TDR scope to obtain the equivalent rise time, filtering effects of test cables and test fixtures shall be included.</p> <p>^c The impedance measurement identifies the impedance mismatches present in the bulk cable or backplane when terminated in its characteristic impedance. This measurement excludes mated connectors at both ends of the bulk cable or backplane, when present, but includes any intermediate connectors or splices.</p> <p>^d Where the bulk cable or backplane has an electrical length of > 4 ns the procedure detailed in SFF-8410, or an equivalent procedure, shall be used to determine the impedance.</p> <p>^e The characteristic impedance is a measurement reference impedance for the test environment.</p> <p>^f An internal cable assembly may be a TxRx connection segment or a full TxRx connection. The full TxRx connection is required to comply with the requirements for intra-enclosure compliance points defined in 5.3.</p> <p>^g The range for this frequency domain measurement is 10 MHz to 4 500 MHz.</p>		



Table 51 defines the S-parameter limits of cable assemblies and backplanes.

Table 51 — S-parameters of cable assemblies and backplanes

Characteristic ^{a b c}	Reference	L (dBmV)	N (dBmV)	H (dB)	S (dBmV/decade)	f _{min} (MHz)	f _{max} (GHz)
S _{CC22}	Figure 125 (see 5.3.6.5.2)	-6.0	-5.0	0	13.3	100	6.0
S _{DD22}	Figure 125	-10	-7.9	0	13.3	100	6.0
S _{CD22}	Figure 126 (see 5.3.6.5.2)	-26	-12.7	-10	13.3	100	6.0
S _{CD21}	Figure 126	-24	-24	-24	0	100	6.0
Maximum near-end crosstalk (NEXT) for each receive signal pair ^d		-26	-26	-26	0	100	6.0

^a All measurements are made through mated connector pairs.

^b The range for this frequency domain measurement is 10 MHz to 6 000 MHz.

^c Specifications apply to any combination of cables and backplanes that are used to form a TxRx connection.

^d Determine all valid aggressor/victim near-end crosstalk transfer modes. Over the complete frequency range of this measurement, determine the sum of the crosstalk transfer ratios, measured in the frequency domain, of all crosstalk transfer modes. To remove unwanted bias due to test fixture noise, crosstalk sources with magnitudes less than -50 dB (e.g., -60 dB) at all frequencies may be ignored. The following equation details the summation process of the valid near-end crosstalk sources. All NEXT values expressed in dB format in a passive transfer network shall have negative dB magnitude.

$$\text{TotalNEXT}(f) = 10 \times \log \sum_{1}^n 10^{(\text{NEXT}(f)/10)}$$

Page: 162

Author: Isi-jenkins
Subject: Highlight
Date: 5/26/2008 7:55:09 PM

 ACCEPT - DONE (Alvin: Accept.
Change table title to "Maximum limits for s-parameters of cable assemblies and backplanes".

Change sentence preceding table to:
Table 51 defines the maximum limits of S-parameters of cable assemblies and backplanes.
)

To avoid any ambiguity, this table should probably be entitled: "Maximum limits for s-parameters of cable assemblies and backplanes"

Author: ifx-hnewman
Date: 5/6/2008 4:07:48 PM

 ACCEPT - DONE (3 times in this table, and in two other tables as well)

dBmV)
s/b dB)

Author: hpq-bolawsky
Subject: Note
Date: 5/6/2008 4:07:48 PM

 ACCEPT - DONE

All three dBmV references are inappropriate. Should be dB.

Author: ifx-hnewman
Date: 5/6/2008 4:07:48 PM

 REJECT (T10 voted for periods over commas for all standards)

6.0
s/b 6,0
periods need to be replaced by commas in entire table

Author: hpq-bolawsky
Subject: Note
Date: 8/29/2008 5:47:15 PM

 ACCEPT - DONE (7/15 incorporate 08-187r1)

The Scc22 and Scd22 specifications are not achievable with all common types of interconnect. Data supporting revised specification will be posted in 08-187r0 SAS-2 S-Parameters of Cable Assemblies and Backplanes.

Author: mxim-mbari
Subject: Note
Date: 8/29/2008 5:49:09 PM

 ACCEPT - DONE (corrected with incorporation of 08-187r1)

Scd21 is not plotted in figure 126

Author: hpq-bolawsky
Subject: Note
Date: 5/26/2008 7:59:30 PM

 ACCEPT - DONE (Alvin: Accept: Add note e and flag it along with a b c on "Characteristic".
e See Figure 124 for descriptions of L,N,H,S,fmin, and fmax

)

Comments from page 162 continued on next page

Table 51 defines the S-parameter limits of cable assemblies and backplanes.

Table 51 — S-parameters of cable assemblies and backplanes

Characteristic ^{a b c}	Reference	L (dBmV)	N (dBmV)	H (dB)	S (dBmV/ decade)	f _{min} (MHz)	f _{max} (GHz)
S _{CC22}	Figure 125 (see 5.3.6.5.2)	-6.0	-5.0	0	13.3	100	6.0
S _{DD22}	Figure 125	-10	-7.9	0	13.3	100	6.0
S _{CD22}	Figure 126 (see 5.3.6.5.2)	-26	-12.7	-10	13.3	100	6.0
S _{CD21}	Figure 126	-24	-24	-24	0	100	6.0
Maximum near-end crosstalk (NEXT) for each receive signal pair ^d		-26	-26	-26	0	100	6.0

^a All measurements are made through mated connector pairs.
^b The range for this frequency domain measurement is 10 MHz to 6 000 MHz.
^c Specifications apply to any combination of cables and backplanes that are used to form a TxRx connection.
^d Determine all valid aggressor/victim near-end crosstalk transfer modes. Over the complete frequency range of this measurement, determine the sum of the crosstalk transfer ratios, measured in the frequency domain, of all crosstalk transfer modes. To remove unwanted bias due to test fixture noise, crosstalk sources with magnitudes less than -50 dB (e.g., -60 dB) at all frequencies may be ignored. The following equation details the summation process of the valid near-end crosstalk sources. All NEXT values expressed in dB format in a passive transfer network shall have negative dB magnitude.

$$\text{TotalNEXT}(f) = 10 \times \log \sum_{1}^n 10^{(\text{NEXT}(f)/10)}$$

Table needs a better link to figure 124 for interpreting fmin/fmax. Referenced Figure 125/126 don't include those parameters.

● Author: mxim-mbari

Subject: Note

Date: 5/26/2008 7:59:37 PM

 ACCEPT - DONE (Alvin: Accept: Add note e and flag it along with a b c on "Characteristic".

e See Figure 124 for descriptions of L,N,H,S,fmin, and fmax

)

Needs to reference figure 124 for description of L,N,H,S,fmin, and fmax

● Author: ifx-hnewman

Date: 5/24/2008 11:15:54 AM

 ACCEPT - DONE (per Alvin)

10

s/b 100

● Author: Isi-gpenokie

Subject: Highlight

Date: 5/6/2008 4:07:48 PM

 ACCEPT - DONE

Move this << All NEXT values expressed in dB format in a passive transfer network shall have negative dB magnitude. >> to after the equation and add a period to the end.

● Author: RElliott

Subject: Note

Date: 6/30/2008 6:16:52 PM

 ACCEPT - DONE

Add

where:

f frequency

h number of the near-end crosstalk source

5.3 Transmitter and receiver device electrical characteristics

5.3.1 Compliance points

A TxRx connection is the complete simplex signal path between the transmitter circuit (see 3.1.282) and receiver circuit (see 3.1.181).

A TxRx connection segment is that portion of a TxRx connection delimited by separable connectors or changes in conductive material.

This standard defines the electrical requirements of the signal at the compliance points IT, IR, CT, and CR in a TxRx connection. Each compliant phy shall be compatible with these electrical requirements to allow interoperability within a SAS environment.

Signal behavior at separable connectors requires compliance with signal characteristics defined by this standard only if the connectors are identified as compliance points by the supplier of the parts that contain the candidate compliance point.

Signal characteristics for compliance points are measured at physical positions called probe points in a test load (see 5.3.2). Measurements at the probe points in a test load approximate measurements at the compliance point in the actual TxRx connection. Some components in the test load may be de-embedded as described in B.4.

Table 52 defines the compliance points.

Table 52 — Compliance points

Compliance point	Type	Description
IT	intra-enclosure (i.e., internal)	The signal from a transmitter device (see 3.1.284), as measured at probe points in a test load attached with an internal connector.
IT _S ^a	intra-enclosure (i.e., internal)	The location of a transmitter device where S-parameters are measured and where the TxRx connection begins. This location is at the transmitter device side of the internal connector with a test load or a TxRx connection attached with an internal connector.
IR	intra-enclosure (i.e., internal)	The signal going to a receiver device (see 3.1.182), as measured at probe points in a test load attached with an internal connector.
CT	inter-enclosure (i.e., cabinet)	The signal from a transmitter device, as measured at probe points in a test load attached with an external connector.
CT _S ^a	inter-enclosure (i.e., cabinet)	The location of a transmitter device where S-parameters are measured and where the TxRx connection begins. This location is at the transmitter device side of the external connector with a test load or a TxRx connection attached with an external connector.
CR	inter-enclosure (i.e., cabinet)	The signal going to a receiver device, as measured at probe points in a test load attached with an external connector.
^a Because the 6 Gbps transmitter device S-parameter specifications do not include the mated connector, transmitter device S-parameter measurement points are at the IT _S and CT _S compliance points. 6 Gbps receiver device S-parameter measurement points are at the IR and CR compliance points.		

The TxRx connection includes the characteristics of the mated connectors at both the transmitter device and receiver device ends. One end of a TxRx connection is a IT_S or CT_S compliance point, and the other end of the TxRx connection is the corresponding IR or CR compliance point.

● Author: intc-mseidel

Subject: Highlight

Date: 5/24/2008 11:20:04 AM

T REJECT (they're for all SAS-2 phys at any rate. Other comment resolutions will fill out the specifications for 1.5 and 3 Gbps SAS-2 operation (SNW-3 based))

The ITs and CTs compliance points only appear with reference to the Tx test load. It should therefore be indicated that these points are only for Gen3 phys.

● Author: lsi-gpenokie

Subject: Highlight

Date: 5/24/2008 11:21:39 AM

T REJECT (nothing wrong with "because")

This << Because the 6 Gbps transmitter device S-parameter specifications do not include the mated connector, transmitter device >> should be << The 6 Gbps transmitter device S-parameter specifications do not include the mated connector, therefore the transmitter device >>

● Author: lsi-gpenokie

Subject: Highlight

Date: 5/6/2008 4:07:48 PM

T REJECT (this is not restating anything, this is defining where the compliance points exist)

This << ends. One end of a TxRx connection is a ITS or CTS compliance point, and the other end of the TxRx connection is the corresponding IR or CR compliance point. >> should be << ends (i.e., one end of a TxRx connection is a ITS or CTS compliance point, and the other end of the TxRx connection is the corresponding IR or CR compliance point). >>

Figure 98 shows the locations of the CT and CR compliance points using a SAS 4x or Mini SAS 4x cable assembly, and shows how two of the compliance points are tested using test loads (see 5.3.2).

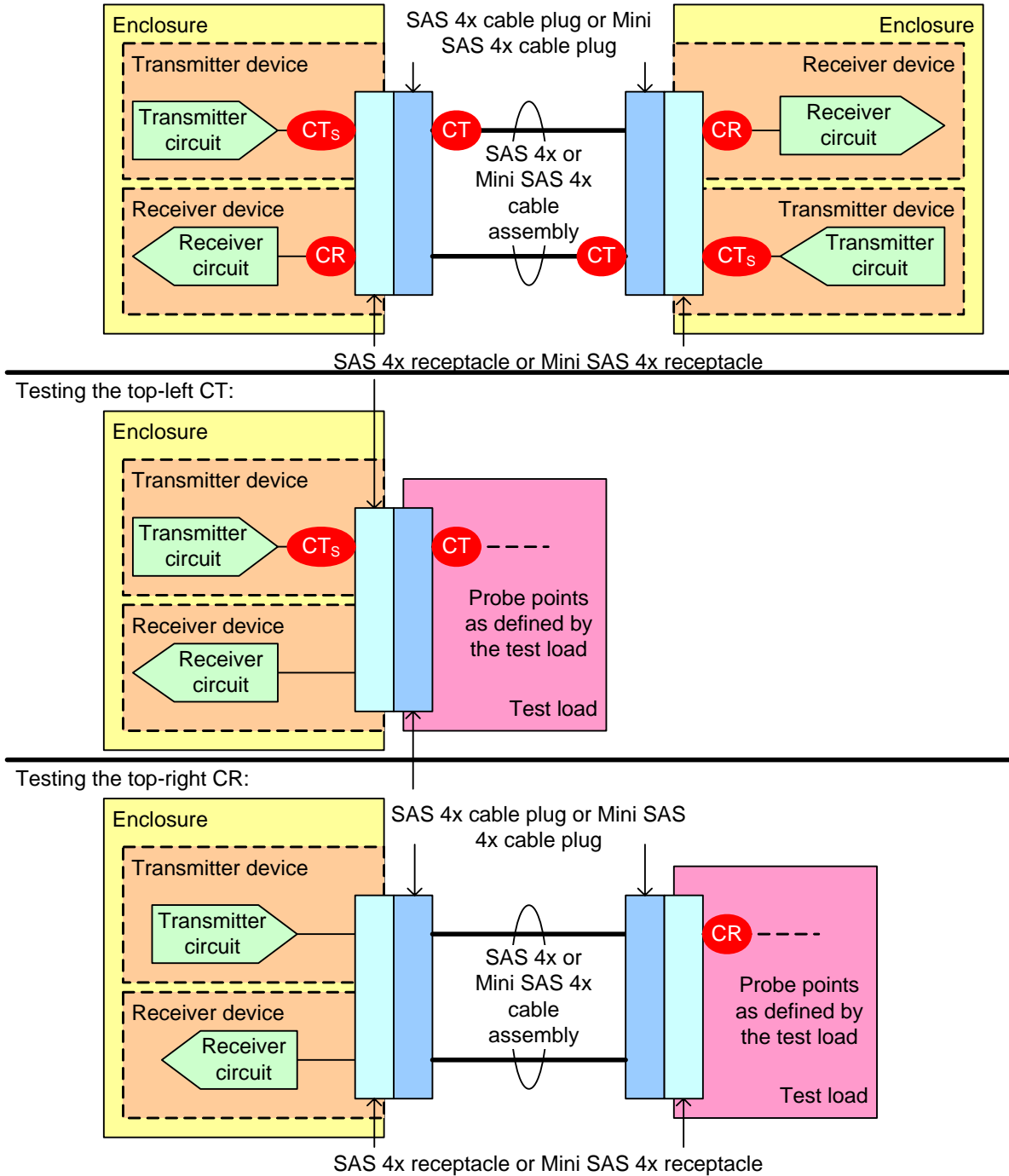

Figure 98 — SAS 4x and Mini SAS 4x cable assembly CT and CR compliance points

This page contains no comments

Figure 99 shows the locations of the IT and IR compliance points using a backplane with a SAS Drive backplane receptacle (see 5.2.3.2.1.3) that is not using SATA, and shows how the compliance points are tested using test loads (see 5.3.2).

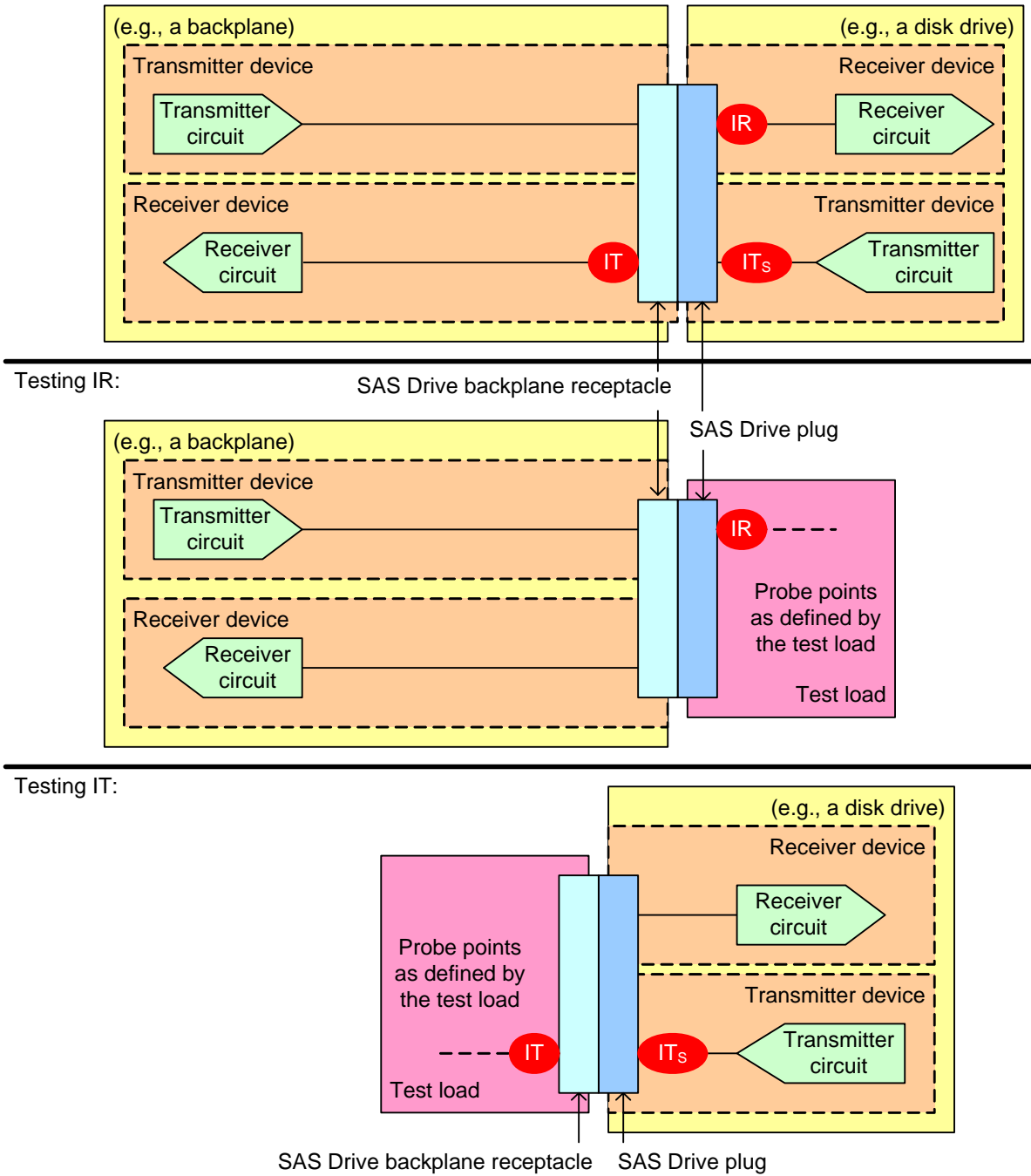

Figure 99 — Backplane with SAS Drive connector IT and IR compliance points

This page contains no comments

If the backplane supports SATA, there are no IT or IR compliance points. SATA defines the signal characteristics that the SATA phy delivers and that the SAS backplane is required to deliver to the SATA device, as shown in figure 100.

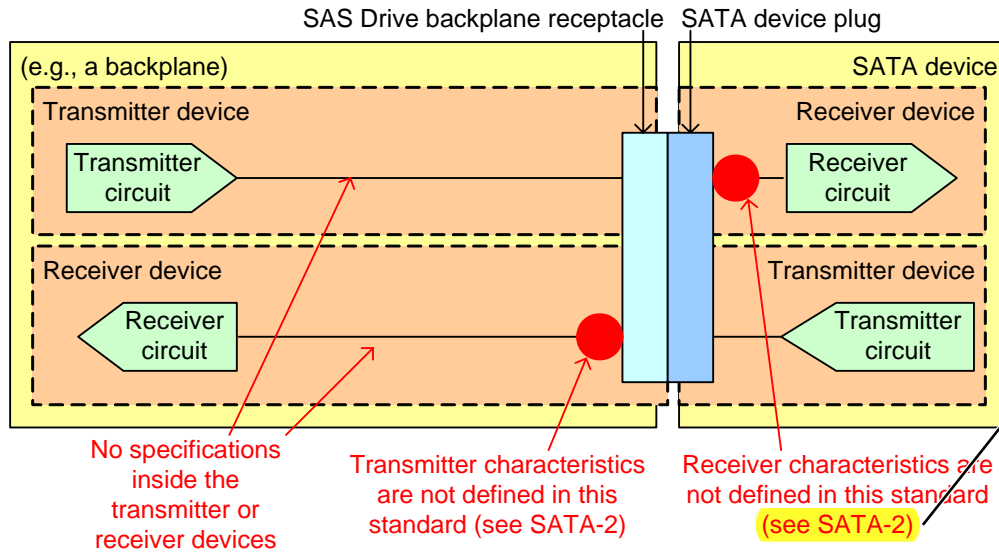

Figure 100 — Backplane with SAS Drive connector compliance points with SATA phy attached

Author: ifx-hnewman
Date: 8/31/2008 8:15:12 PM

TACCEPT - DONE (From the SATA device perspective, it is true that all the characteristics are on the left side (through the mated connector). The yellow box on the left represents a SATA host, though, and its compliance points are on the right side (through the mated connector).

Added red dots on both sides of both Tx and Rx (4 total). This matches the SATA Usage Model figures that say "Gen1i Compliance Points (4 Plcs)" (assuming that Plcs means "places").

Merged the text underneath into one sentence, pointing to all 4, that says "SATA host and SATA device characteristics are not defined in this standard". This is vague enough that we don't have to worry about which ones are which.)

(see SATA-2)

Move red dot to the left of the connector. This better represents the receive compliance point being referenced in SATA-2.

Also in Figure 103

Figure 101 shows the locations of the IT and IR compliance points using a SAS 4i or Mini SAS 4i cable assembly, and shows how two of the compliance points are tested using test loads (see 5.3.2).

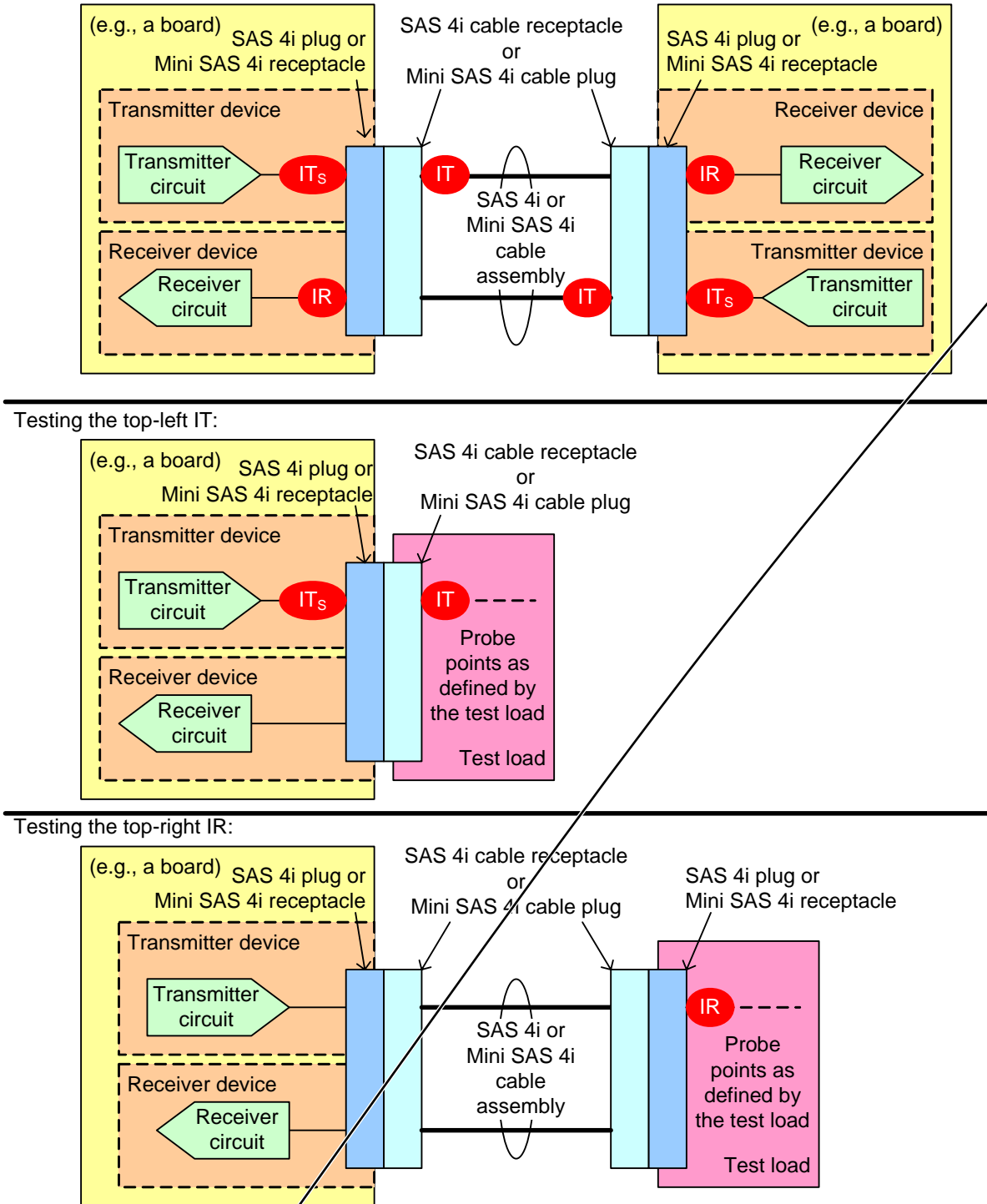

Figure 101 — SAS 4i and Mini SAS 4i cable assembly IT and IR compliance points

Figure 102 shows the locations of the IT and IR compliance points using a SAS 4i or Mini SAS 4i cable assembly combined with a backplane with a SAS Drive backplane receptacle (see 5.2.3.2.1.3), where the

Author: RElliott
Subject: Highlight
Date: 8/29/2008 10:59:29 AM
ACCEPT - DONE



combined with
s/b
attached to

to match comment resolution on page 169

backplane is not attached to a SATA device, and shows how two of the compliance points are tested using test loads (see 5.3.2).

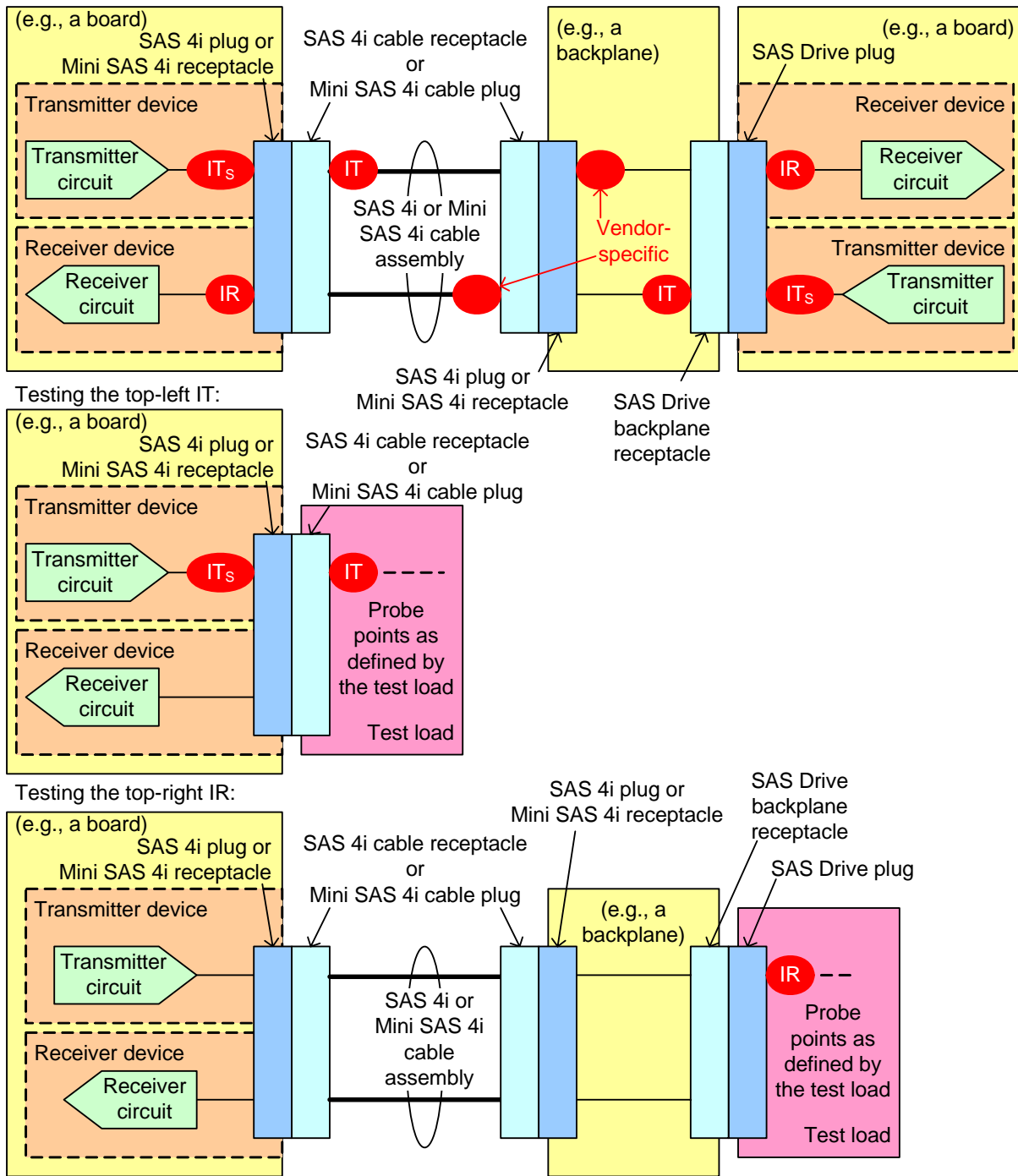

Figure 102 — SAS 4i and Mini SAS 4i cable assembly and backplane IT and IR compliance points

Author: wdc-mevans
Subject: Highlight
Date: 5/26/2008 8:01:48 PM
REJECT (Alvin: Reject)

T

shows how two
s/b
how sets of two

Figure 103 shows the locations of the IT and IR compliance points using a SAS 4i or Mini SAS 4i cable assembly combined with a backplane with a SAS Drive backplane receptacle (see 5.2.3.2.1.3), where the backplane supports being attached to a SATA device. There are no IT and IR compliance points at the SAS Drive backplane receptacle connector when a SATA device is attached; SATA defines the signal characteristics that the SATA device delivers and that the SAS backplane is required to deliver to the SATA device. There are compliance points at the SAS 4i connector, however.

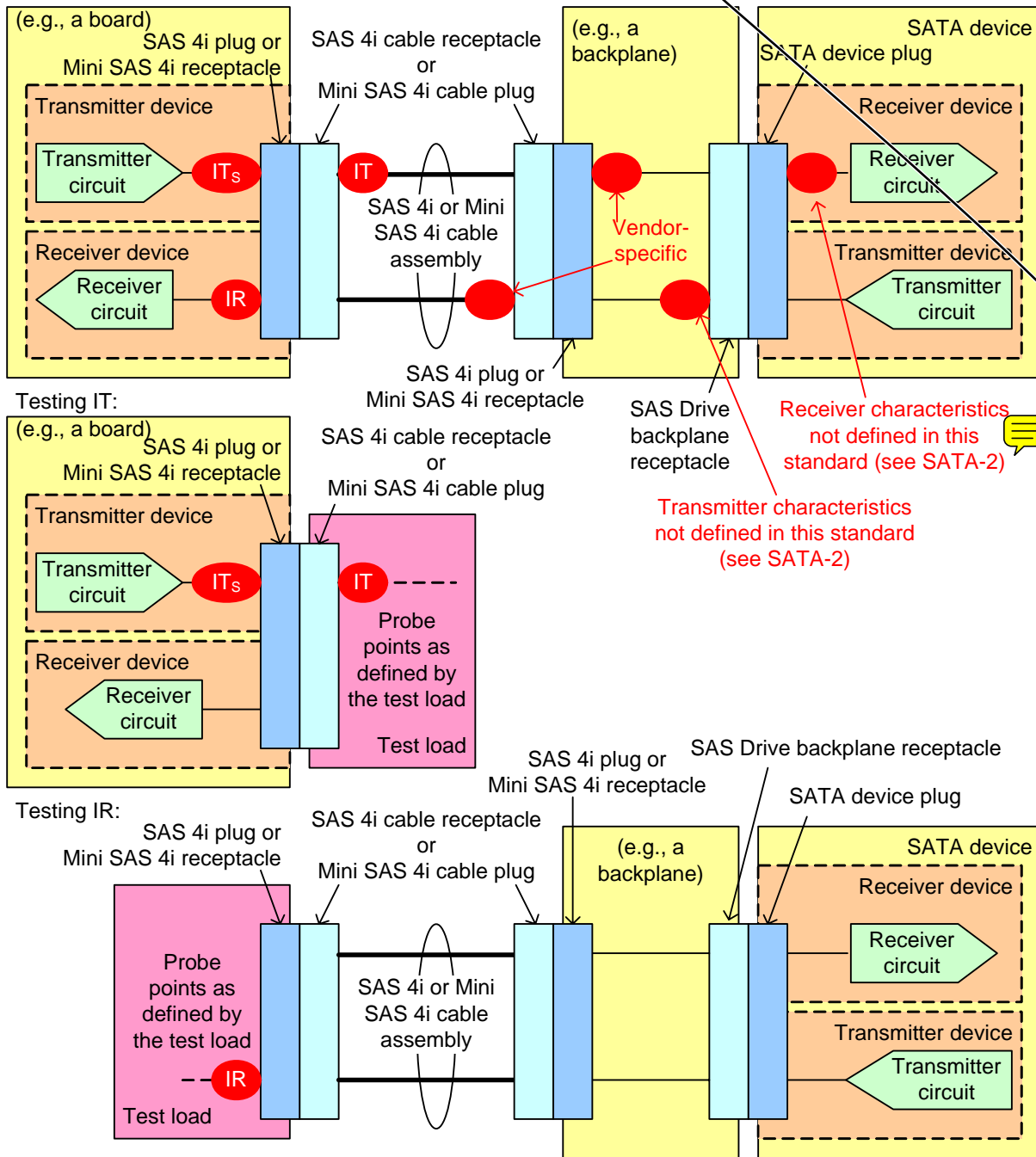





Figure 103 — SAS 4i or Mini SAS 4i cable assembly and backplane IT and IR compliance points with SATA device attached

● Author: wdc-mevans
Subject: Highlight
Date: 5/26/2008 8:04:01 PM
 ACCEPT - DONE (as "that supports...")

5.2.3.2.1.3), where
s/b
5.2.3.2.1.3) where

● Author: lsi-gpenokie
Subject: Highlight
Date: 8/29/2008 10:58:47 AM
 ACCEPT - DONE (7/15 change "combined with" to "attached to")

This << assembly combined with a backplane with a SAS Drive backplane receptacle >> should be << assembly combined with a backplane and a SAS Drive backplane receptacle >>

● Author: lsi-gpenokie
Subject: Highlight
Date: 5/26/2008 8:07:11 PM
 REJECT (this is not a rewording, so i.e. is incorrect. Changing ";" to ". In that case, " instead, which might ease the semicolon indigestion)

This << attached; SATA defines the signal characteristics that the SATA device delivers and that the SAS backplane is required to deliver to the SATA device. There >> should be << attached (i.e., SATA defines the signal characteristics that the SATA device delivers and that the SAS backplane is required to deliver to the SATA device). There >>

● Author: lsi-gpenokie
Subject: Highlight
Date: 5/26/2008 8:07:54 PM
 REJECT (why?)

Move the << however >> to the beginning of the sentence.

● Author: CoxA
Subject: Note
Date: 8/31/2008 8:18:02 PM
 ACCEPT - DONE (as with earlier figure, added two more red dots and changed the text to read: "SATA host and SATA device characteristics are not defined in this standard (see SATA)")

Move point to the other side of the connector as Harvey indicated earlier.

Figure 104 shows the locations of the IT and IR compliance points using a SAS Drive cable assembly. It also shows how two of the compliance points are tested using test loads (see 5.3.2).

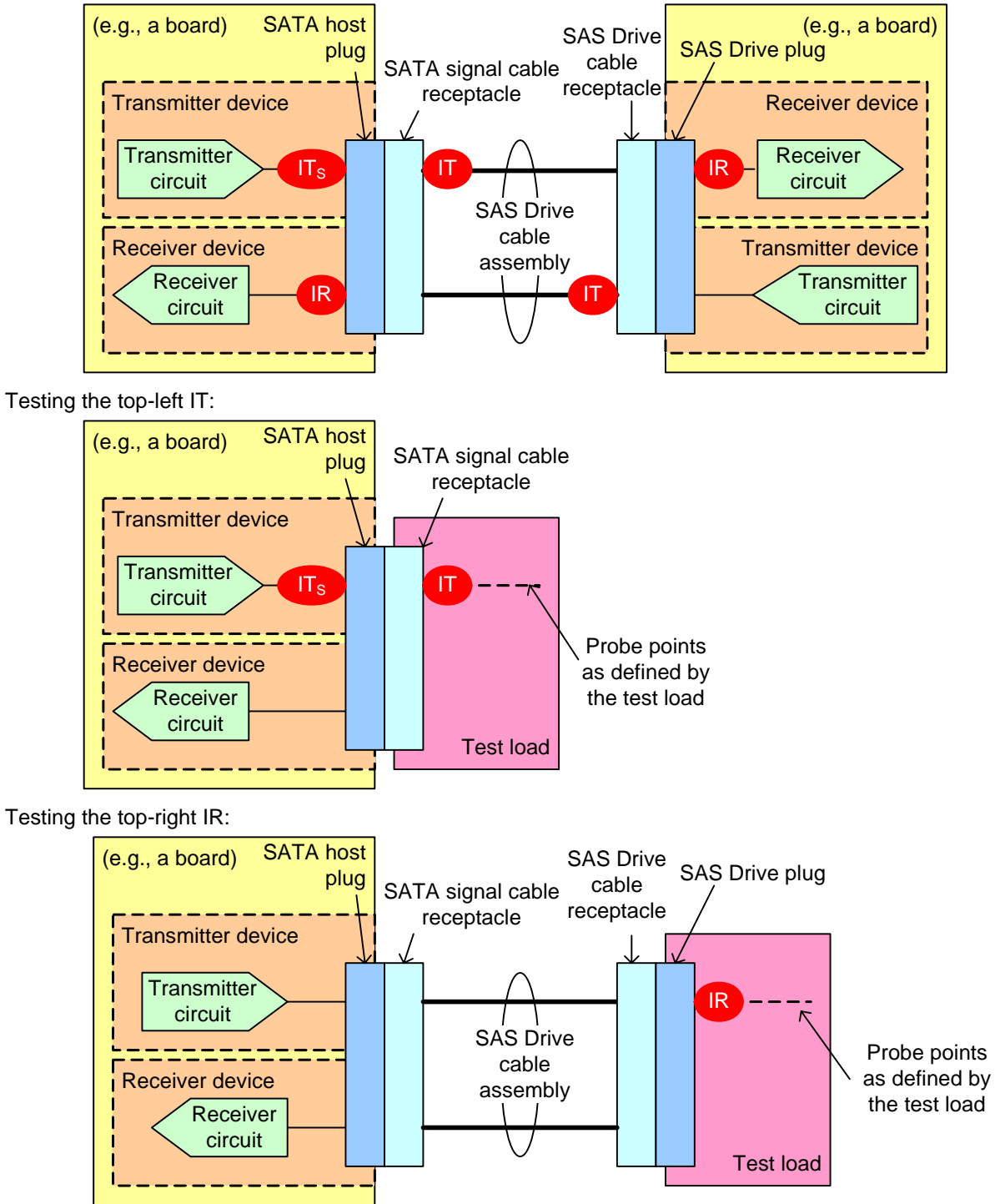

Figure 104 — SAS Drive cable assembly IT and IR compliance points

Author: wdc-mevans
Subject: Highlight
Date: 5/6/2008 4:07:48 PM
ACCEPT - DONE (" and")

It
s/b
The figure

5.3.2 Test loads

5.3.2.1 Test loads overview

This standard uses a test load methodology to specify transmitter device signal output characteristics (see 5.3.6.2 and 5.3.6.3) and delivered signal characteristics (see 5.3.7.3). This methodology specifies the signal as measured at specified probe points in specified test loads.

For 1.5 Gbps and 3 Gbps, the test loads used by the methodology are:

- a) zero-length test load (see 5.3.2.2): used for testing transmitter device compliance points and receiver device compliance points;
- b) transmitter compliance transfer function (TCTF) test load (see 5.3.2.3): used for testing transmitter device compliance points; and
- c) low-loss TCTF test load (see 5.3.2.4): used for testing transmitter device compliance points when SATA devices using Gen2i levels (see SATA-2) are supported and the SAS receiver device does not support the signal levels received through a full TCTF test load (see 5.3.2.3).

For 6 Gbps, the test loads used by the methodology are:

- a) zero-length test load (see 5.3.2.2): used for testing transmitter device compliance points and receiver device compliance points; and
- b) reference transmitter test load (see 5.3.2.5): used with a reference receiver device (see 5.3.7.4.3) by simulation methods to determine the delivered signal.

For 6 Gbps SATA, see SATA-2 regarding Gen3 transmitter device and receiver device requirements.

Physical positions denoted as probe points identify the position in the test load where the signal properties are measured, but do not imply that physical probing is used for the measurement. Physical probing may be disruptive to the signal and should not be used unless verified to be non-disruptive.

5.3.2.2 Zero-length test load

Figure 105 shows the zero-length test load as used for testing a transmitter device compliance point.

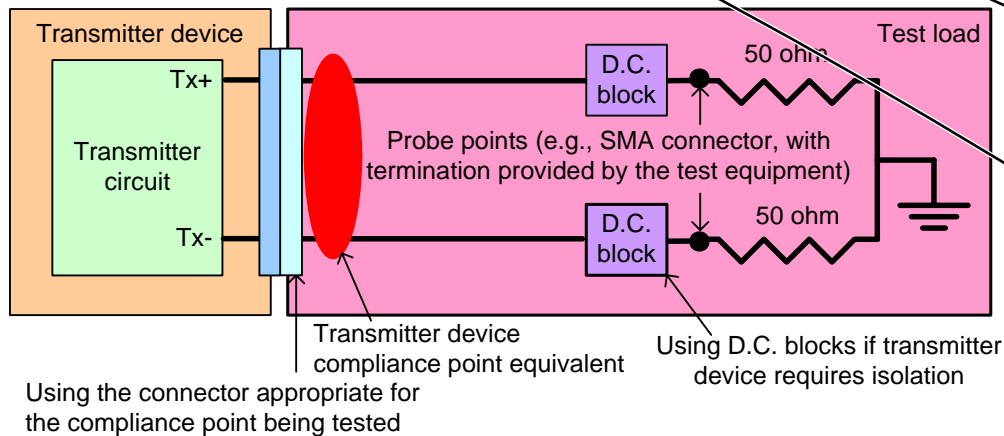



Figure 105 — Zero-length test load for transmitter device compliance point

Page: 171

● Author: lsi-gpenokie
Subject: Highlight
Date: 5/6/2008 4:07:48 PM
 REJECT (the probe points are inside the test loads)

This << specified probe points in specified test loads >> should be << specified probe points with specified test loads >>

● Author: ifx-hnewman
Date: 5/6/2008 4:07:48 PM
 REJECT (T10 voted for periods rather than commas)

1.5
s/b 1,5
"Global"

● Author: ifx-hnewman
Date: 9/4/2008 2:44:28 PM
 REFER PHYSICAL WG

and receiver device compliance points

c) zero-length test load (see 5.3.2.2): used with a reference receiver device (see 5.3.7.4.3) by simulation methods to determine the delivered signal.

● Author: ifx-hnewman
Date: 9/4/2008 2:44:34 PM
 REFER PHYSICAL WG

and

● Author: stx-alvin-cox
Subject: Note
Date: 7/17/2008 5:24:41 PM
 ACCEPT - DONE (7/15 add a reference to SATA 3.0)

There needs to be a place holder here rather than referencing SATA-2 since there is no SATA 6Gbps specification available yet and we don't know what it will be called.

● Author: mxim-mbari
Subject: Note
Date: 7/17/2008 5:24:49 PM
 ACCEPT - DONE (7/15 add a reference to SATA 3.0)

I have looked at SATA Revision 2.6 specification. Could not find any Gen3 information.

● Author: ifx-hnewman
Date: 7/17/2008 5:25:07 PM
 ACCEPT - DONE (7/15 add a reference to SATA 3.0)

SATA-2
new reference needed for 6Gbps SATA.

● Author: lsi-bday
Subject: Highlight
Date: 7/17/2008 5:24:59 PM
 ACCEPT - DONE (7/15 add a reference to SATA 3.0)

For 6 Gbps SATA, see SATA-2 regarding Gen3 transmitter device and receiver device requirements.

Comments from page 171 continued on next page

5.3.2 Test loads

5.3.2.1 Test loads overview

This standard uses a test load methodology to specify transmitter device signal output characteristics (see 5.3.6.2 and 5.3.6.3) and delivered signal characteristics (see 5.3.7.3). This methodology specifies the signal as measured at **specified probe points in specified test loads**.

For 1.5 Gbps and 3 Gbps, the test loads used by the methodology are:

- zero-length test load (see 5.3.2.2): used for testing transmitter device compliance points and receiver device compliance points;
- transmitter compliance transfer function (TCTF) test load (see 5.3.2.3): used for testing transmitter device compliance points; and
- low-loss TCTF test load (see 5.3.2.4): used for testing transmitter device compliance points when SATA devices using Gen2i levels (see SATA-2) are supported and the SAS receiver device does not support the signal levels received through a full TCTF test load (see 5.3.2.3).

For 6 Gbps, the test loads used by the methodology are:

- zero-length test load (see 5.3.2.2): used for testing transmitter device compliance points ~~and receiver device compliance points~~; and
- reference transmitter test load (see 5.3.2.5): used with a reference receiver device (see 5.3.7.4.3) by simulation methods to determine the delivered signal.

For 6 Gbps SATA, see SATA-2 regarding Gen3 transmitter device and receiver device requirements.

Physical positions denoted as probe points identify the position in the test load where the signal properties **are measured, but** do not imply that physical probing is used for the measurement. Physical probing may be disruptive to the signal and should not be used unless verified to be non-disruptive.

5.3.2.2 Zero-length test load

Figure 105 shows the zero-length test load as used for testing a transmitter device compliance point.

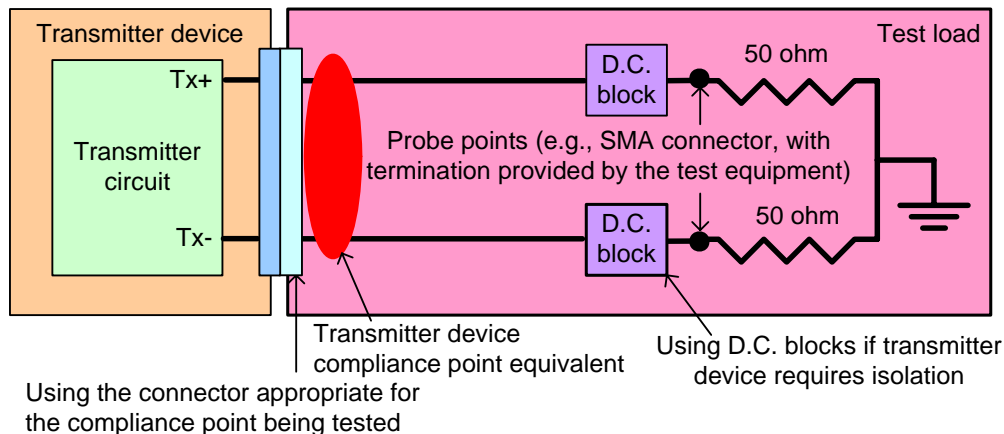

Figure 105 — Zero-length test load for transmitter device compliance point

However, SATA-2 (referred as the 2.6 spec at beginning of this standard) does not define Gen3 requirements.

Author: wdc-mevans

Subject: Highlight

Date: 5/6/2008 4:07:48 PM

T REJECT (no, they must be measured there.)

are measured, but

s/b

may be measured but

Figure 106 shows the zero-length test load as used for testing a receiver device compliance point.

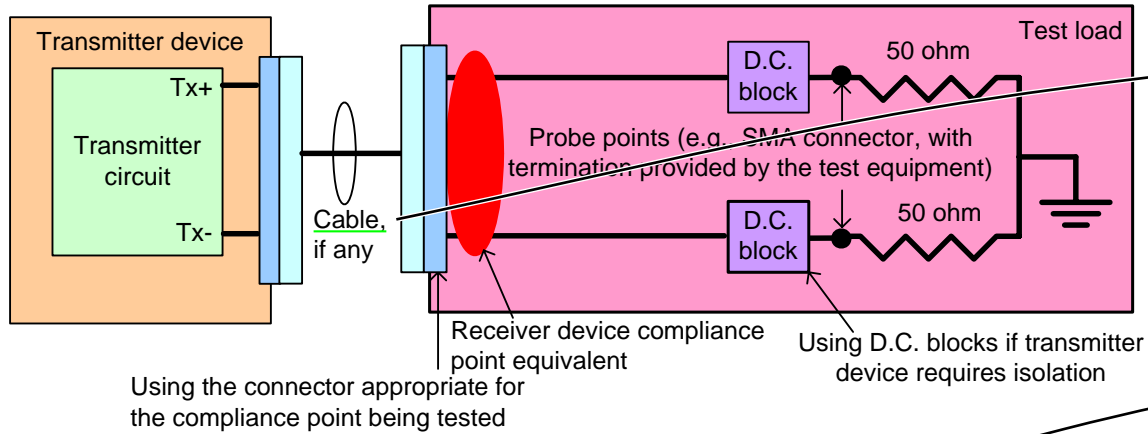

Figure 106 — Zero-length test load for receiver device compliance point

Figure 105 and figure 106 show ideal designs. Actual designs include:

- a) insertion loss between the compliance and probe points, and
- b) return loss due one or more impedance mismatches between the compliance point and 50 ohm termination points.

Not shown are non-ideal effects of the test equipment raw measurements (e.g., additional insertion loss and return loss). For de-embedding methods to remove non-ideal effects see Annex B.

Usage of fixturing and test equipment shall comply with the requirements defined in this subclause. The requirements in this subclause include the combined effects of the fixturing and test equipment.

The zero-length test load, including all fixturing and instrumentation required for the measurement, shall comply with the following equations:

For 50 MHz $f \le 6.0 \text{ GHz}$:

$$|S_{DD21}(f)| \ge -20 \times \log_{10}(e) \times ((1.0 \times 10^{-6} \times f^{0.5}) + (2.8 \times 10^{-11} \times f) + (5.3 \times 10^{-21} \times f^2)) - 0.2 \text{ dB}$$

$$|S_{DD11}(f)| \le -15 \text{ dB}$$

where:

$|S_{DD21}(f)|$ magnitude of $S_{DD21}(f)$

$|S_{DD11}(f)|$ magnitude of $S_{DD11}(f)$

f signal frequency in Hz

● Author: RElliott
Subject: Underline
Date: 6/30/2008 6:16:52 PM
T ACCEPT - DONE

Cable
s/b
TxRx connection

(from Alvin, per WG meeting)

● Author: RElliott
Subject: Underline
Date: 6/30/2008 6:16:52 PM
T ACCEPT - DONE

Actual designs
s/b
Implementations may

(from Alvin, per WG)

● Author: ibm-jay-diepenbrock
Subject: Highlight
Date: 5/26/2008 8:12:25 PM

T REJECT (Alvin: Reject. This section does not specify cables. Rob: this is discussing the zero-length test load, and this paragraph is communicating that test fixtures are not ideal. There are new equations in SAS-2 limiting for Sdd21 of the whole test load just below.)

Include limits on insertion loss for the cables as a function of frequency. Maybe not this section, but somewhere.

Figure 107 shows the allowable $|S_{DD21}(f)|$ of a zero-length test load and the $|S_{DD21}(f)|$ of a sample zero-length test load.

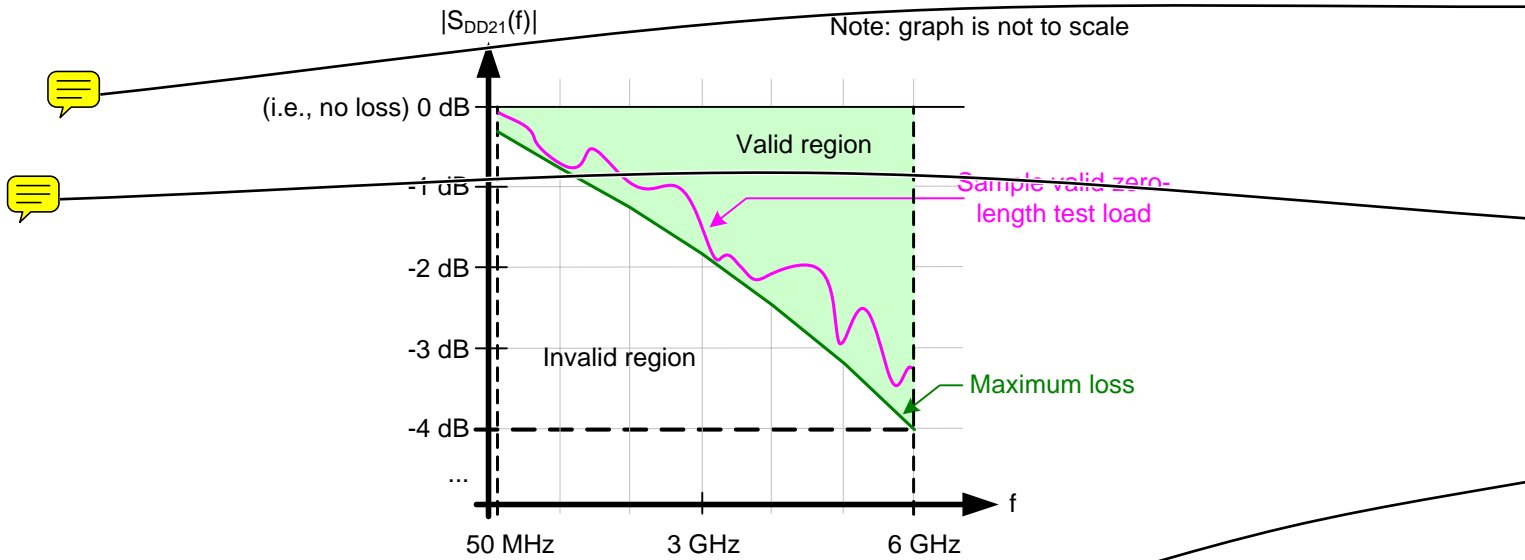

Figure 107 — Zero-length test load S_{DD21}

NOTE 21 - The zero-length test load performance specifications defined in this subclause were not required by previous versions of this standard.

5.3.2.3 TCTF test load

Figure 108 shows the TCTF test load. This test load is used for 1.5 Gbps and 3 Gbps characterization.

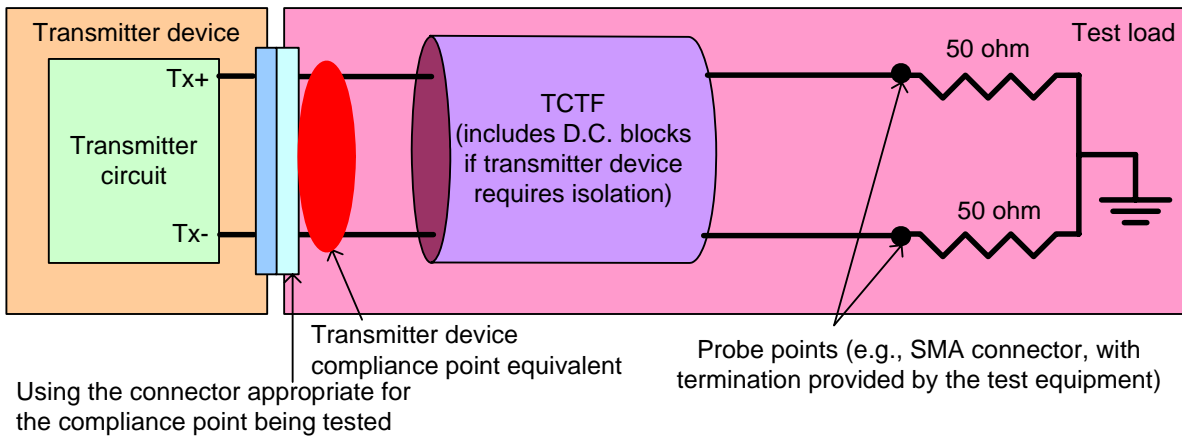

Figure 108 — TCTF test load

The TCTF test load shall meet the requirements in 5.2.6. The nominal impedance shall be the target impedance.

The TCTF is defined by a set of S-parameters (see B.9). Only the magnitude of $S_{DD21}(f)$ is specified by this standard.

For testing a 3 Gbps transmitter device at IT, the TCTF test load shall comply with the following equations:

For $50 \text{ MHz} < f \leq 3.0 \text{ GHz}$:

$$|S_{DD21}(f)| \leq -20 \times \log_{10}(e) \times ((6.5 \times 10^{-6} \times f^{0.5}) + (2.0 \times 10^{-10} \times f) + (3.3 \times 10^{-20} \times f^2)) \text{ dB}$$

and for $3.0 \text{ GHz} < f \leq 5.0 \text{ GHz}$:

$$|S_{DD21}(f)| \leq -10.9 \text{ dB}$$

● Author: hpq-bolawsky

Subject: Note

Date: 9/2/2008 7:47:06 PM

 REJECT (double-checked Excel graph of the formula - it bows out as shown.)

The shape appears to be incorrect. My data forms a straight line.

● Author: RElliott

Subject: Note

Date: 9/1/2008 7:32:05 PM

 ACCEPT - DONE

Move the note to the bottom of the figure

(from Ralph Weber, per ISO editing of SAS-1.1)

● Author: RElliott

Subject: Highlight

Date: 6/30/2008 6:16:52 PM

 ACCEPT - DONE

SDD21

global

add (f) in figure titles to avoid ending line with subscript, which causes problems in the table of figures

and, specifying a minimum ISI loss:

$$|S_{DD21}(f = 300 \text{ MHz})| - |S_{DD21}(f = 1\,500 \text{ MHz})| > 3.9 \text{ dB}$$

where:

$|S_{DD21}(f)|$ magnitude of $S_{DD21}(f)$
 f signal frequency in Hz

Figure 109 shows the allowable $|S_{DD21}(f)|$ and minimum ISI loss of a TCTF test load and the $|S_{DD21}(f)|$ of a sample TCTF test load at IT at 3 Gbps.

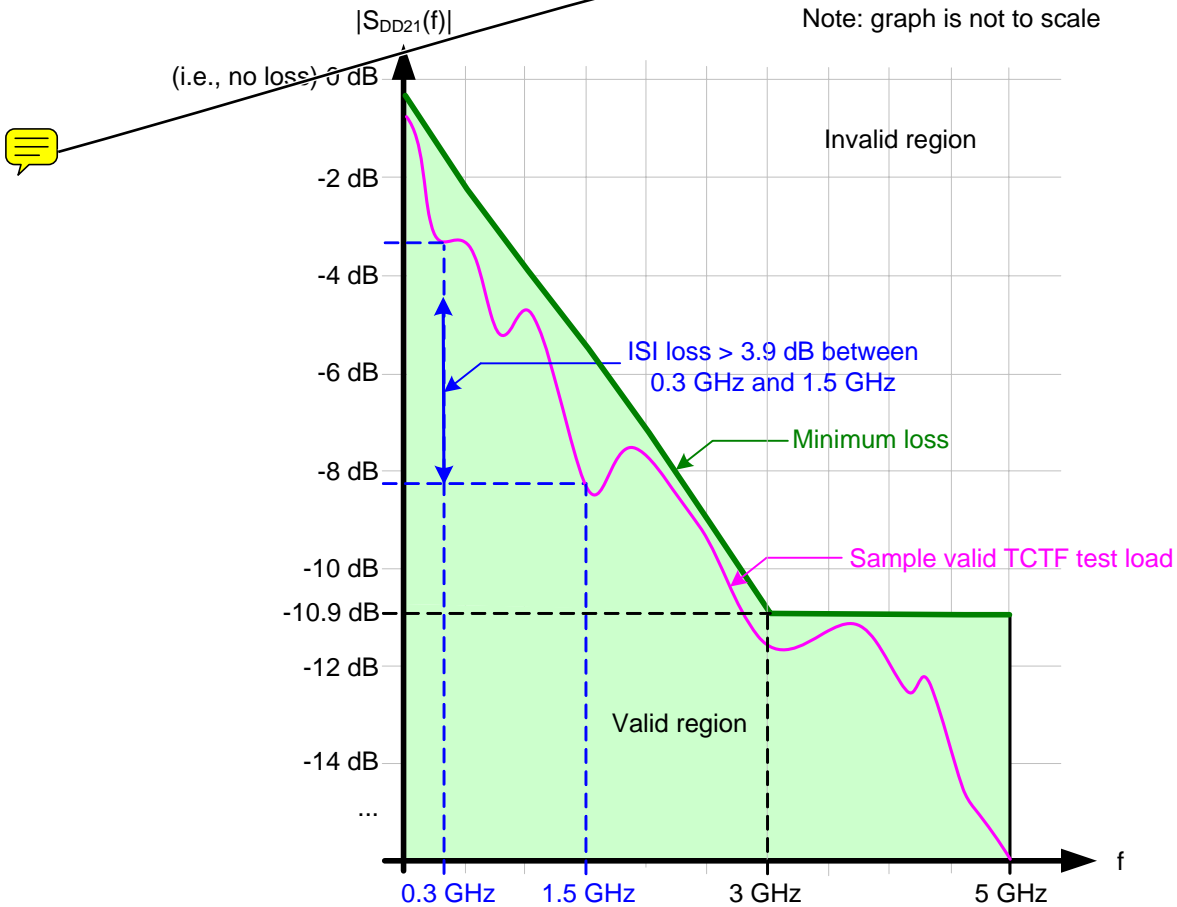

Figure 109 — TCTF test load S_{DD21} and ISI loss requirements at IT at 3 Gbps

For testing a 3 Gbps transmitter device at CT, the TCTF test load shall comply with the following equations:

For $50 \text{ MHz} < f \leq 3.0 \text{ GHz}$:

$$|S_{DD21}(f)| \leq -20 \times \log_{10}(e) \times ((1.7 \times 10^{-5} \times f^{0.5}) + (1.0 \times 10^{-10} \times f)) \text{ dB}$$

and for $3.0 \text{ GHz} < f \leq 5.0 \text{ GHz}$:

$$|S_{DD21}(f)| \leq -10.7 \text{ dB}$$

and, specifying a minimum ISI loss:

$$|S_{DD21}(f = 300 \text{ MHz})| - |S_{DD21}(f = 1\,500 \text{ MHz})| > 3.9 \text{ dB}$$

where:

$|S_{DD21}(f)|$ magnitude of $S_{DD21}(f)$
 f signal frequency in Hz

● Author: RElliott

Subject: Note

Date: 9/1/2008 7:32:17 PM

 ACCEPT - DONE

Move the note to the bottom of the figure

(from Ralph Weber, per ISO editing of SAS-1.1)

Figure 110 shows the allowable $|S_{DD21}(f)|$ and minimum ISI loss of a TCTF test load and the $|S_{DD21}(f)|$ of a sample TCTF test load at CT at 3 Gbps.

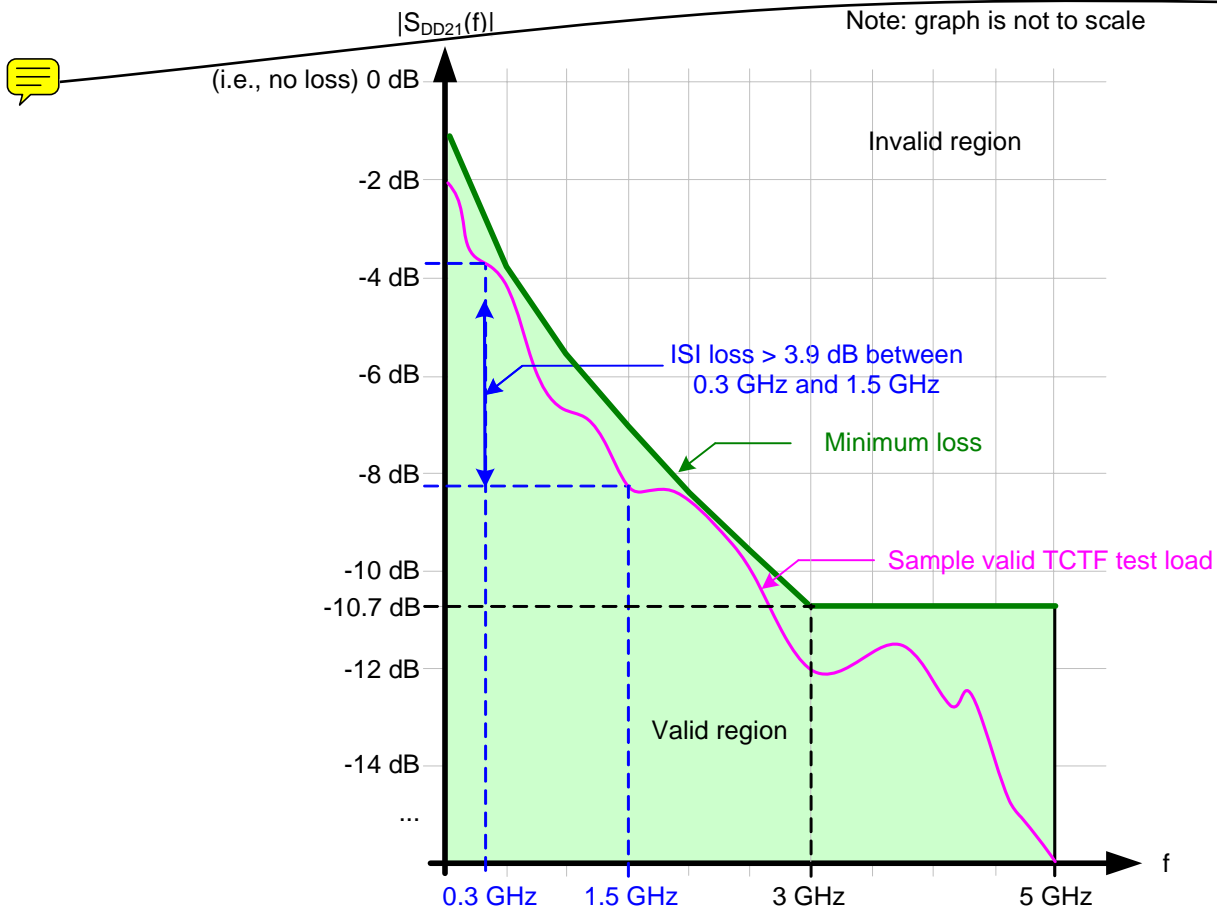

Figure 110 — TCTF test load S_{DD21} and ISI loss requirements at CT at 3 Gbps

For testing a 1.5 Gbps transmitter device at IT, the TCTF test load shall comply with the following equations:

For $50 \text{ MHz} < f \leq 1.5 \text{ GHz}$:

$$|S_{DD21}(f)| \leq -20 \times \log_{10}(e) \times ((6.5 \times 10^{-6} \times f^{0.5}) + (2.0 \times 10^{-10} \times f) + (3.3 \times 10^{-20} \times f^2)) \text{ dB}$$

and for $1.5 \text{ GHz} < f \leq 5.0 \text{ GHz}$:

$$|S_{DD21}(f)| \leq -5.4 \text{ dB}$$

and, specifying a minimum ISI loss:

$$|S_{DD21}(f = 150 \text{ MHz})| - |S_{DD21}(f = 750 \text{ MHz})| > 2.0 \text{ dB}$$

where:

- $|S_{DD21}(f)|$ magnitude of $S_{DD21}(f)$
- f signal frequency in Hz

● Author: RElliott

Subject: Note

Date: 9/1/2008 7:32:24 PM

 ACCEPT - DONE

Move the note to the bottom of the figure

(from Ralph Weber, per ISO editing of SAS-1.1)

Figure 111 shows the allowable $|S_{DD21}(f)|$ and minimum ISI loss of a TCTF test load and the $|S_{DD21}(f)|$ of a sample TCTF test load at IT at 1.5 Gbps.

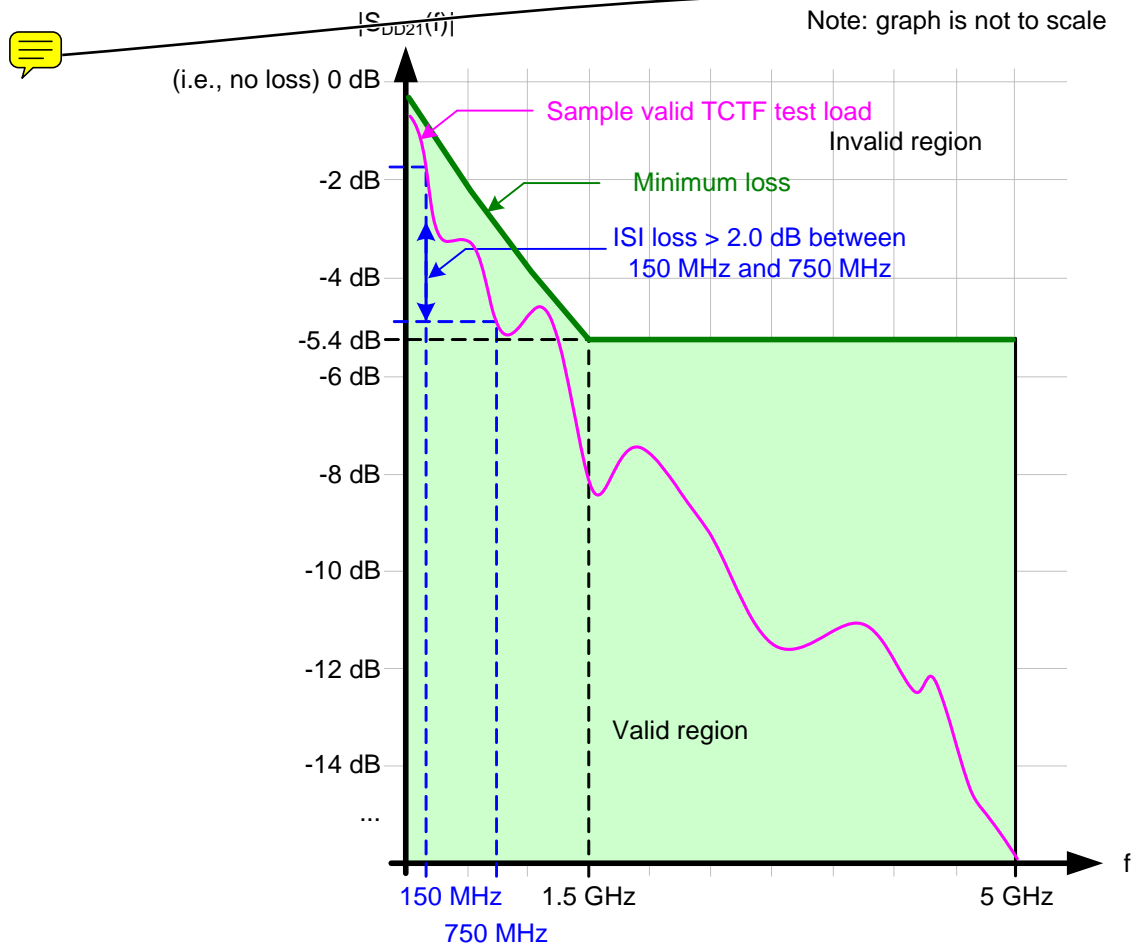

Figure 111 — TCTF test load S_{DD21} and ISI loss requirements at IT at 1.5 Gbps

For testing a 1.5 Gbps transmitter device at CT, the TCTF test load shall comply with the following equations:

For $50 \text{ MHz} < f \leq 1.5 \text{ GHz}$:

$$|S_{DD21}(f)| \leq -20 \times \log_{10}(e) \times ((1.7 \times 10^{-5} \times f^{0.5}) + (1.0 \times 10^{-10} \times f)) \text{ dB}$$

and for $1.5 \text{ GHz} < f \leq 5.0 \text{ GHz}$:

$$|S_{DD21}(f)| \leq -7.0 \text{ dB}$$

and, specifying a minimum ISI loss:

$$|S_{DD21}(f = 150 \text{ MHz})| - |S_{DD21}(f = 750 \text{ MHz})| > 2.0 \text{ dB}$$

where:

$|S_{DD21}(f)|$ magnitude of $S_{DD21}(f)$
 f signal frequency in Hz

● Author: RElliott

Subject: Note

Date: 9/1/2008 7:32:31 PM

 ACCEPT - DONE

Move the note to the bottom of the figure

(from Ralph Weber, per ISO editing of SAS-1.1)

Figure 112 shows the allowable $|S_{DD21}(f)|$ and minimum ISI loss of a TCTF test load and the $|S_{DD21}(f)|$ of a sample TCTF test load at CT at 1.5 Gbps.

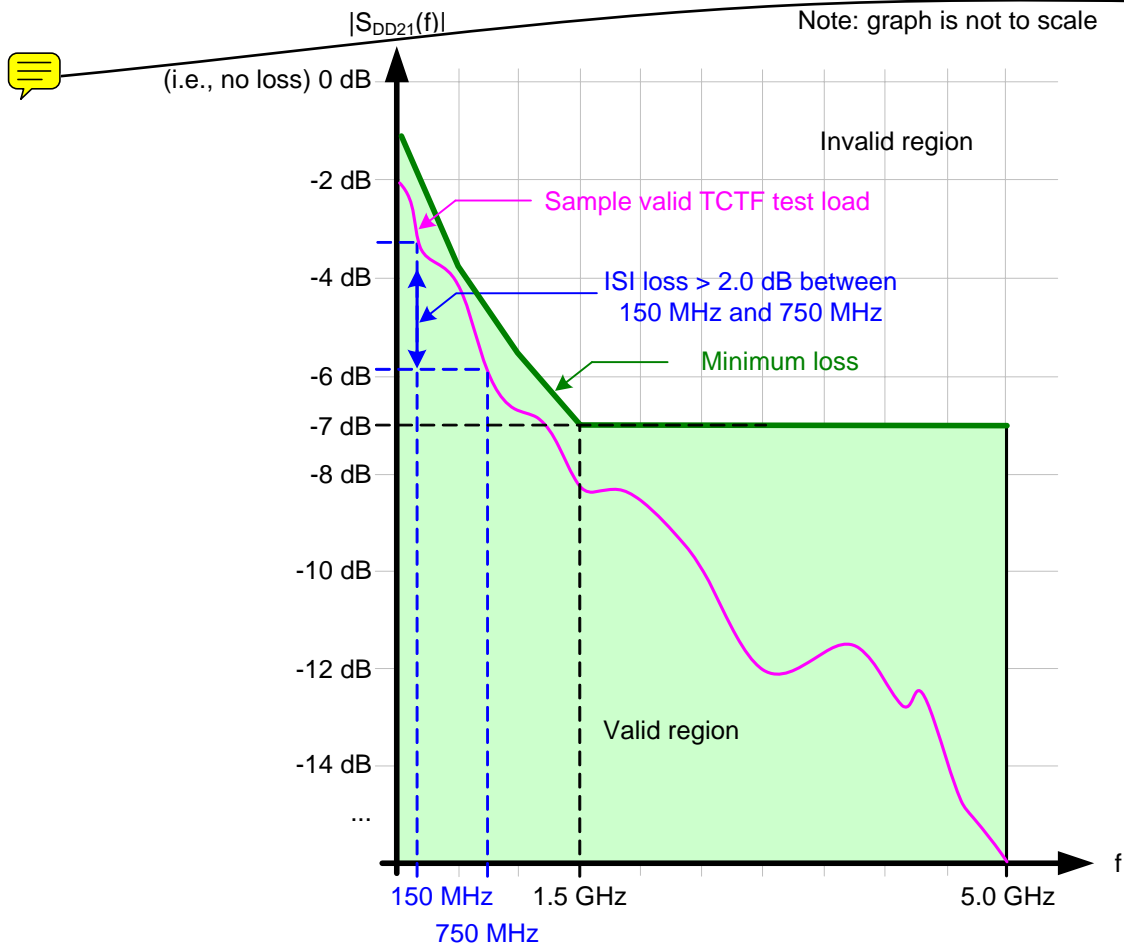

Figure 112 — TCTF test load S_{DD21} and ISI loss requirements at CT at 1.5 Gbps

5.3.2.4 Low-loss TCTF test load

Figure 113 shows the low-loss TCTF test load. This test load is used for 1.5 Gbps and 3 Gbps characterization.

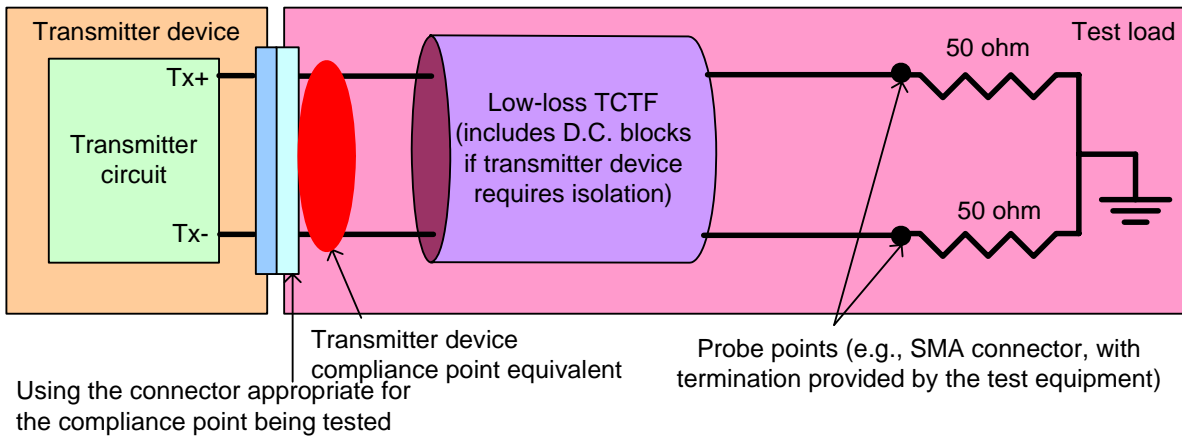



Figure 113 — Low-loss TCTF test load

● Author: RElliott

Subject: Note

Date: 9/1/2008 7:32:38 PM

 ACCEPT - DONE

Move the note to the bottom of the figure

(from Ralph Weber, per ISO editing of SAS-1.1)

The low-loss TCTF test load shall meet the requirements defined in 5.2.6. The nominal impedance shall be the target impedance.

The low-loss TCTF is defined by a set of S-parameters (see B.9). Only the magnitude of $S_{DD21}(f)$ is specified by this standard.

The low-loss TCTF test load shall comply with the following equations:

For $50 \text{ MHz} < f \leq 3.0 \text{ GHz}$:

$$|S_{DD21}(f)| \leq -20 \times \log_{10}(e) \times ((2.2 \times 10^{-6} \times f^{0.5}) + (6.9 \times 10^{-11} \times f) + (1.1 \times 10^{-20} \times f^2)) \text{ dB}$$

for $3.0 \text{ GHz} < f \leq 5.0 \text{ GHz}$:

$$|S_{DD21}(f)| \leq -3.7 \text{ dB}$$

and, specifying a minimum ISI loss:

$$|S_{DD21}(f = 300 \text{ MHz})| - |S_{DD21}(f = 1\,500 \text{ MHz})| > 1.3 \text{ dB}$$

where:

$|S_{DD21}(f)|$ magnitude of $S_{DD21}(f)$
 f signal frequency in Hz

Figure 114 shows the allowable $|S_{DD21}(f)|$ and minimum ISI loss of a low-loss TCTF test load and the $|S_{DD21}(f)|$ of a sample low-loss TCTF test load.

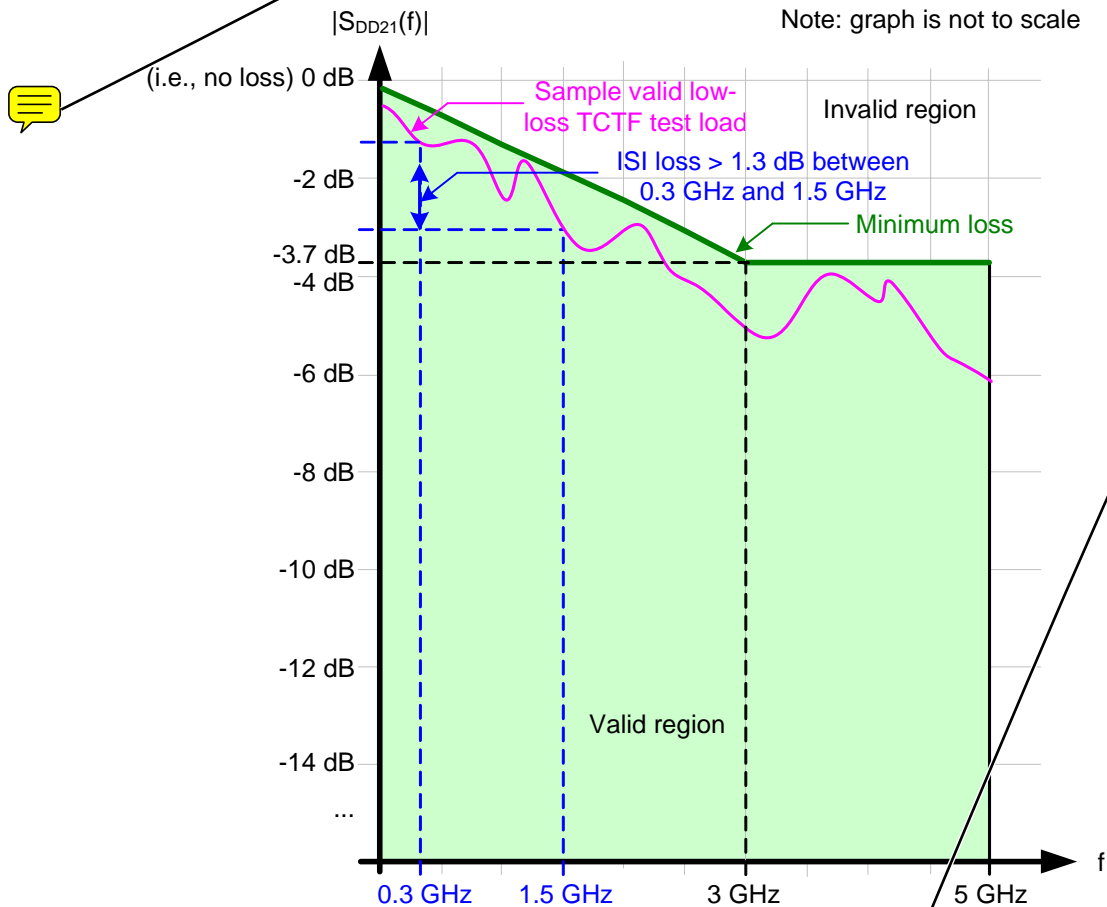



Figure 114 — Low-loss TCTF test load S_{DD21} and ISI loss requirements

5.3.2.5 Reference transmitter test load

The reference transmitter test load is a 10 m Mini SAS 4x cable assembly.

● Author: RElliott
Subject: Note
Date: 9/1/2008 7:32:46 PM
 ACCEPT - DONE

Move the note to the bottom of the figure

(from Ralph Weber, per ISO editing of SAS-1.1)

● Author: Isi-gpenokie
Subject: Highlight
Date: 6/3/2008 9:17:48 AM
 REJECT (Alvin: Reject based on adding 1.5 and 3G SAS 2 requirements.)

This << The reference transmitter test load is a 10 m Mini SAS 4x cable assembly. >> should be << The reference transmitter test load for 6 Gbps is a 10 m Mini SAS 4x cable assembly. >>

The reference transmitter test load is used along with the reference receiver device (see 5.3.7.4.3) for simulation of 6 Gbps transmitter device compliance. The specific simulation program used (e.g., StatEye from <http://www.stateye.org>) is not specified by this standard.

NOTE 22 — An S-parameter model of the reference transmitter test load is available from <http://www.t10.org> as document number 07-193r1 titled “SAS 2.0 Transmitter Test Load.” This model includes reference transmitter device (see 5.3.6.5.4) etch, the reference transmitter test load, and reference receiver device (see 5.3.7.4.3) etch. 07-193r1.pdf describes how the model was created, including the specific etch configuration. 07-193r1.zip contains a Touchstone® .s4p file containing the S-parameters. Touchstone® is a registered trademark of Agilent Corporation.

Figure 115 shows the physical model used to measure the reference transmitter test load.

NOTE 23 - The etches between the transmission points and probe points are typically included in an S-parameter measurement of a TxRx connection. Although these etches add extra loss to the TxRx connection, they are considered to be an acceptable amount of loss for simulation purposes when restricted to a configuration similar to the reference transmitter test load.

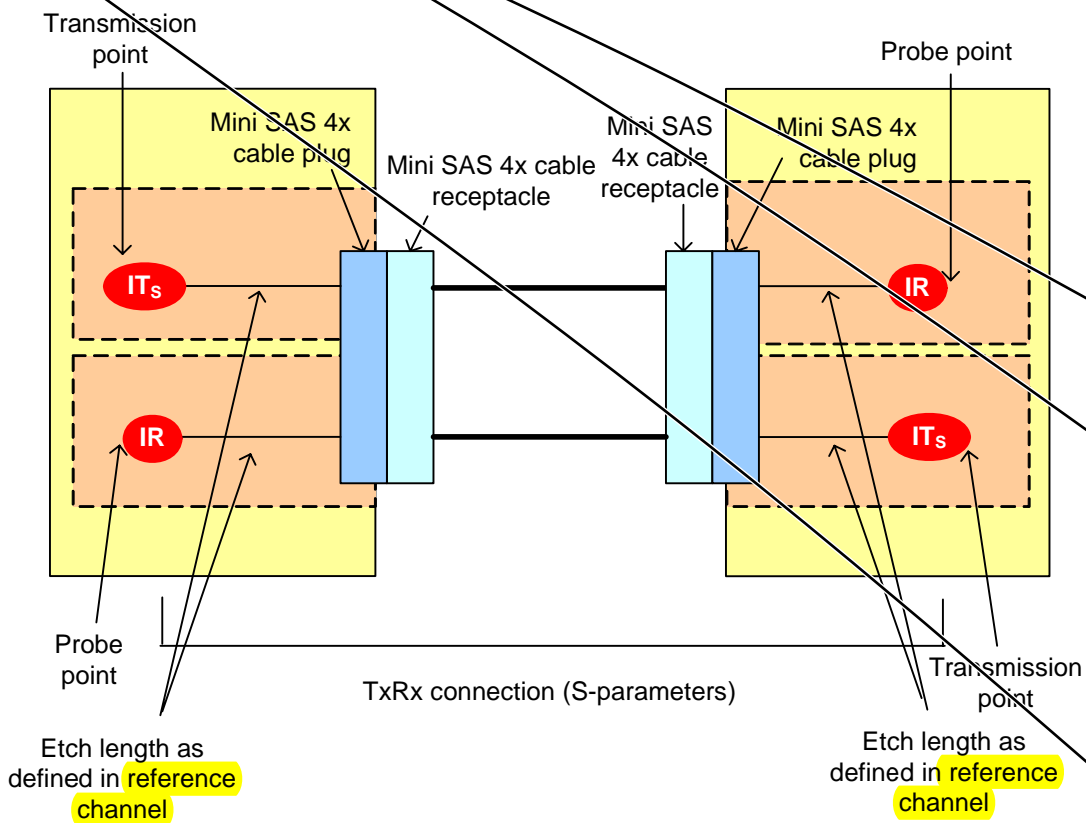



Figure 115 — Reference transmitter test load physical characterization

Editor’s Note 1: For the reference transmitter test load, SAS-2 should include 1) a graph of Sdd21, 2) possibly include graphs of all 16 S-parameters, 3) include graphs of the impulse response (requested by 07-486r3 which added the receiver device physical testing section), and 4) possibly include a chart of the impulse response numbers (requested by 07-486r3). The 10GBASE-LRM standard includes 3) and 4) in its receiver device testing section.

Page: 179

● Author: intc-mseidel
Subject: Highlight
Date: 8/31/2008 4:46:41 PM
 ACCEPT - DONE (.s4p files will be "included with this standard.")

Note 22 indicates several dependencies outside the standard. It would be better to include the s-parameter model on some concrete way, perhaps as text in an appendix. I assume that all Notes and Editor's Notes must be addressed in the Letter Ballot process (and edited into the text or out of the document).

● Author: lsi-gpenokie
Subject: Highlight
Date: 6/3/2008 9:25:12 AM
 REJECT (There is nothing wrong with using trademarks. The files will be "included with this standard" (see other comment))

This note is troubling for more than one reason. One is that it references a proposal. That is not going to fly at ISO and may be a problem at ANSI. I see two solutions- one would be to put it as an annex of this standard the other would be to create a technical report. The other problem is have a trademark. I don't have any good solution to that other than deleting it.

● Author: stx-alvin-cox
Subject: Note
Date: 6/3/2008 9:24:06 AM
 ACCEPT - DONE (replaced with normative text)

Why is this a note rather than text included in the specification?

● Author: lsi-bday
Subject: Highlight
Date: 5/6/2008 4:07:48 PM
 ACCEPT - DONE

This model...

This sentence appears to be larger font than rest of the note.

● Author: RElliott
Subject: Note
Date: 6/30/2008 6:16:52 PM
 ACCEPT - DONE
fix fonts in note 22

● Author: RElliott
Subject: Note
Date: 6/30/2008 6:16:52 PM
 ACCEPT - DONE

Replace note 22 with:

An S-parameter model of the reference transmitter test load is included with this standard. This model includes reference transmitter device (see 5.3.6.5.4) etch, the reference transmitter test load, and reference receiver device (see 5.3.7.4.3) etch. The following files are included:

- a) 07-193r1.pdf describes how the model was created, including the specific etch configuration; and
- b) 07-193r1.s4p contains a Touchstone® file containing the S-parameters.

NOTE: Touchstone® is a registered trademark of Agilent Corporation.

● Author: stx-alvin-cox
Subject: Note
Date: 6/6/2008 2:28:28 PM
 ACCEPT - DONE (changing "are typically included" to "may be included" to make this normatively interesting)

Why is this a note rather than text included in the specification?

Comments from page 179 continued on next page

The reference transmitter test load is used along with the reference receiver device (see 5.3.7.4.3) for simulation of 6 Gbps transmitter device compliance. The specific simulation program used (e.g., StatEye from <http://www.stateye.org>) is not specified by this standard.

NOTE 22 - An S-parameter model of the reference transmitter test load is available from <http://www.t10.org> as document number 07-193r1 titled "SAS 2.0 Transmitter Test Load." This model includes reference transmitter device (see 5.3.6.5.4) etch, the reference transmitter test load, and reference receiver device (see 5.3.7.4.3) etch. 07-193r1.pdf describes how the model was created, including the specific etch configuration. 07-193r1.zip contains a Touchstone® .s4p file containing the S-parameters. Touchstone® is a registered trademark of Agilent Corporation.

Figure 115 shows the physical model used to measure the reference transmitter test load.

NOTE 23 - The etches between the transmission points and probe points are typically included in an S-parameter measurement of a TxRx connection. Although these etches add extra loss to the TxRx connection, they are considered to be an acceptable amount of loss for simulation purposes when restricted to a configuration similar to the reference transmitter test load.

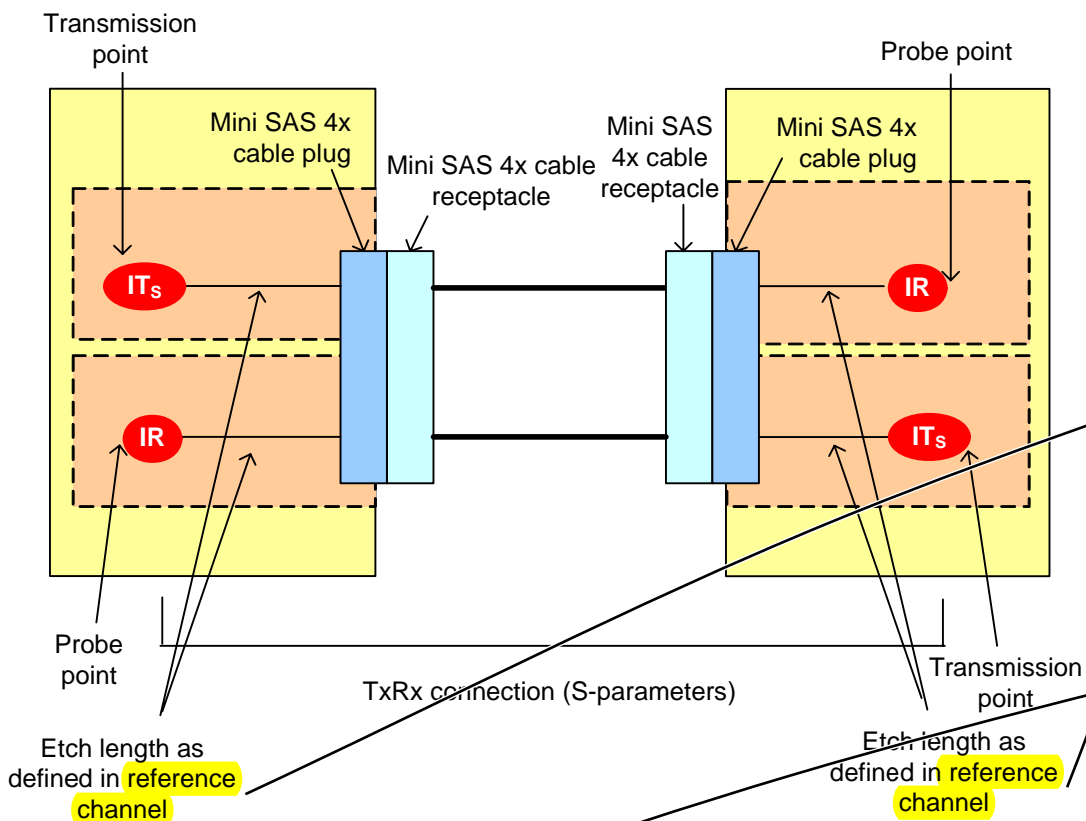



Figure 115 — Reference transmitter test load physical characterization

Editor's Note 1: For the reference transmitter test load, SAS-2 should include 1) a graph of Sdd21, 2) possibly include graphs of all 16 S-parameters, 3) include graphs of the impulse response (requested by 07-486r3 which added the receiver device physical testing section), and 4) possibly include a chart of the impulse response numbers (requested by 07-486r3). The 10GBASE-LRM standard includes 3) and 4) in its receiver device testing section.

● Author: mxim-kwitt
Subject: Note
Date: 6/3/2008 9:12:50 AM
 ACCEPT - DONE

Add Figures of (1) pulse response and (2) insertion loss from 08-144r1 page 3.

● Author: RElliott
Subject: Highlight
Date: 6/30/2008 6:16:52 PM
 ACCEPT - DONE

are typically included
s/b
may be included

(from Alvin)

● Author: RElliott
Subject: Highlight
Date: 9/3/2008 6:34:18 PM
 ACCEPT - DONE

reference channel
s/b
reference transmitter test load

(from George Penokie, LSI)

● Author: RElliott
Subject: Highlight
Date: 9/3/2008 6:34:11 PM
 ACCEPT - DONE

reference channel
s/b
reference transmitter test load

(from George Penokie, LSI)

● Author: RElliott
Subject: Highlight
Date: 6/30/2008 6:16:52 PM
 ACCEPT - DONE (Alvin: Add insertion loss graph)

Address Editor's Note 1

● Author: Isi-jenkins
Subject: Highlight
Date: 6/3/2008 9:11:30 AM
 ACCEPT - DONE (a pulse response graph will be included)

The reference in 07-486r3 was to a "pulse response", not an "impulse response". The two are similar, but not the same. Pulse response can be mathematically derived from impulse response, but we need to be clear about which is which.

5.3.3 General electrical characteristics

5.3.3.1 General electrical characteristics overview

Table 53 defines the general electrical characteristics.

Table 53 — General electrical characteristics

Characteristic	Units	1.5 Gbps (i.e., G1)	3 Gbps (i.e., G2)	6 Gbps (i.e., G3)
Physical link rate (nominal)	MBps	150	300	600
Unit interval (UI)(nominal)	ps	666.6	333.3	166.6
Baud rate (f_{baud})(nominal)	Gigasymbols/s	1.5	3	6
Differential impedance of TxRx connection (nominal)	ohm	100		
Maximum A.C. coupling capacitor ^a	nF	12		
Maximum noise during OOB idle time ^b	mV(P-P)	120		
^a The coupling capacitor value for A.C. coupled transmit and receive pairs. A.C. coupling requirements for transmitter devices are described in 5.3.6.1. A.C. coupling requirements for receiver devices are described in 5.3.7.1. The equivalent series resistance at 3 GHz should be less than 1 ohm. ^b With a measurement bandwidth of $1.5 \times f_{\text{baud}}$ (e.g., 9 GHz for 6 Gbps), no signal level during the idle time shall exceed the specified maximum differential amplitude.				

5.3.3.2 Transmitter device general electrical characteristics

Table 54 defines the transmitter device general electrical characteristics.

Table 54 — Transmitter device general electrical characteristics

Characteristic	Units	1.5 Gbps	3 Gbps	6 Gbps
Physical link rate long-term stability at IT and CT	ppm	± 100		
Physical link rate SSC modulation at IT and CT	ppm	See table 76 and table 77 in 5.3.8.2		
Maximum transmitter device transients ^a	√	± 1.2		
^a See 5.3.4 for transient test circuits and conditions.				

Table 55 defines the transmitter device termination characteristics.

Table 55 — Transmitter device termination characteristics

Characteristic	Units	1.5 Gbps	3 Gbps	6 Gbps
Differential impedance ^a	ohm	60 min/115 max		See 5.3.6.5.1
Maximum differential impedance imbalance ^{a b}	ohm	5		See 5.3.6.5.2 ^c
Common-mode impedance ^b	ohm	15 min/40 max		See 5.3.6.5.1
^a All transmitter device termination measurements are made through mated connector pairs. ^b The difference in measured impedance to SIGNAL GROUND on the plus and minus terminals on the interconnect, transmitter device, or receiver device, with a differential test signal applied to those terminals. ^c Measurement replaced by $S_{\text{cd}22}$ specifications (i.e., differential to common mode conversion).				

● Author: lsi-gpenokie
Subject: Highlight
Date: 6/9/2008 12:33:48 PM

 ACCEPT - DONE (Alvin: Accept. The revision looks better by avoiding the period after the section number preceding the "A.C.")

This << A.C. coupling requirements for transmitter devices are described in 5.3.6.1. A.C. coupling requirements for receiver devices are described in 5.3.7.1. >> should be << See 5.3.6.1 for the A.C. coupling requirements for transmitter devices. See 5.3.7.1 for the A.C. coupling requirements for receiver devices. >>

● Author: hpq-relliott
Subject: Highlight
Date: 5/6/2008 4:07:48 PM

 ACCEPT - DONE

cd
s/b
CD

● Author: hpq-bolawsky
Subject: Note
Date: 6/6/2008 2:31:10 PM

 REJECT (Alvin: note c is only used in a 6 Gbps cell, so only applies to 6 Gbps)

Clarify note "c" for application to "6 Gbps" only

5.3.3.3 TxRx connection characteristics

5.3.3.3.1 TxRx connection characteristics overview

Each TxRx connection shall support a bit error ratio (BER) that is less than 10^{-12} (i.e., fewer than one bit error per 10^{12} bits). The parameters specified in this standard support meeting this requirement under all conditions including the minimum input and output amplitude levels.

A TxRx connection may be constructed from multiple TxRx connection segments (e.g., backplane, cable, cable, backplane). In such cases, the individual TxRx connection segment should have loss characteristics less than the total allowed loss characteristic for the TxRx connection. It is the responsibility of the implementer to ensure that the TxRx connection is constructed from individual TxRx connection segments such that the overall TxRx connection requirements are met. Loss characteristics for individual TxRx connection segments are beyond the scope of this standard.

Each TxRx connection segment shall comply with the impedance requirements detailed in 5.2.6 for the conductive material from which they are formed. A passive equalizer network, if present, shall be considered part of the TxRx connection.

TxRx connections shall be applied only to homogenous ground applications (e.g., between devices within an enclosure or rack, or between enclosures interconnected by a common ground return or ground plane).

5.3.3.3.2 TxRx connection characteristics for 1.5 Gbps and 3 Gbps

For 1.5 Gbps and 3 Gbps, each TxRx connection shall be designed such that its loss characteristics are less than:

- the loss of the TCTF test load plus ISI at 3 Gbps (see figure 112 in 5.3.2.3) over the frequency range of 50 MHz to 3 000 MHz; or
- if the system supports SATA devices using Gen2i levels (see SATA-2) but the receiver device does not support SATA Gen2i levels through the TCTF test load, the loss of the low-loss TCTF test load plus ISI (see figure 114 in 5.3.2.4) over the frequency range of 50 MHz to 3 000 MHz

Each TxRx connection shall meet the delivered signal specifications in table 68 (see 5.3.7.3).

For external cable assemblies, these electrical requirements are consistent with using good quality passive cable assemblies constructed with shielded twinaxial cable with 24 gauge solid wire up to 6 m long, provided that no other TxRx connection segments are included in the TxRx connection.

5.3.3.3.3 TxRx connection characteristics for 6 Gbps

For 6 Gbps, the TxRx connection shall support a bit error ratio (BER) that is less than 10^{-15} (i.e., fewer than one bit error per 10^{15} bits) based on simulation results using S-parameter measurements of the TxRx connection, the reference transmitter device (see 5.3.6.5.4), and the reference receiver device (see 5.3.7.4.3).

NOTE 24 - Because simulations typically do not include all aspects of noise that may degrade the received signal quality, the goal of a BER that is less than 10^{-15} is expected to yield an actual BER that is less than 10^{-12} .



● Author: lsi-gpenokie

Subject: Highlight

Date: 5/26/2008 8:14:07 PM

T REJECT (Alvin: Reject. The 10-15 references that follow apply to simulations that support an actual 10-12 BER when other factors not included in the simulations are considered.)

This << error ratio (BER) that is less than 10-12 (i.e., fewer >> contradicts the following statement in section 5.3.3.3.3 that states << error ratio (BER) that is less than 10-15 (i.e., fewer than one bit error per 1015 bits) >>. The solution is to move the 10-12 wording into section 5.3.3.3.2 which applies to 1.5 and 3 Gbps.

● Author: pmcs-gfortin

Subject: Highlight

Date: 5/6/2008 4:07:48 PM

T ACCEPT - DONE

overall

● Author: intc-mseidel

Subject: Highlight

Date: 5/6/2008 4:07:48 PM

T REJECT ("over" should be "overall" instead)

Second paragraph, third sentence: "that the over TxRx connection requirements" s/b "that over the TxRx connection all requirements"

● Author: lsi-gpenokie

Subject: Highlight

Date: 5/6/2008 4:07:48 PM

T ACCEPT - DONE

This << such that the over TxRx connection requirements are >> should be << such that the overall TxRx connection requirements are >> I think.

● Author: lsi-gpenokie

Subject: Highlight

Date: 5/6/2008 4:07:48 PM

T REJECT (SAS-2 does not define support for non-passive interconnects, and active equalizers are outside the scope. Notice the title of 5.2. Remember this comment for SAS-2.1, though.)

This << A passive equalizer network, if present, shall >> should be << A equalizer network, if present, shall >> as the current wording implies that an active equalizer would not be considered part of the TxRx connection.

● Author: hpq-relliott

Subject: Highlight

Date: 6/9/2008 12:32:22 PM

T ACCEPT - DONE (Alvin: Accept, but only specify the 3Gbps requirement as was done in SATA.)

The 1.5 Gbps TCTF test load graphs are solely for testing the transmitter device; the interconnect is only required to be designed to be better than the 3 Gbps TCTF test load, regardless of the rate.

Split into two paragraphs, one for CT and one for IT:

For 1.5 Gbps and 3 Gbps, each external TxRx connection shall be designed such that its loss characteristics are less than the loss of the TCTF test load plus ISI at CT at 3 Gbps (see figure 109 in 5.3.2.3) over the frequency range of 50 MHz to 3 000 MHz.

For 1.5 Gbps and 3 Gbps, each internal TxRx connection shall be designed such that its loss characteristics are less than:

a) the loss of the TCTF test load plus ISI at IT at 3 Gbps (see figure 108 in 5.3.2.3) over the frequency range of 50 MHz to 3 000 MHz; or

b) if the system supports SATA devices using Gen2i levels (see SATA) but the receiver device does not support SATA Gen2i levels through the TCTF test load, the loss of the low-loss TCTF test load plus ISI (see figure 113 in 5.3.2.4) over the frequency range of 50 MHz to 3 000 MHz.

)

5.3.3.3 TxRx connection characteristics

5.3.3.3.1 TxRx connection characteristics overview

Each TxRx connection shall support a bit error ratio (BER) that is less than 10^{-12} (i.e., fewer than one bit error per 10^{12} bits). The parameters specified in this standard support meeting this requirement under all conditions including the minimum input and output amplitude levels.

A TxRx connection may be constructed from multiple TxRx connection segments (e.g., backplane, cable, cable, backplane). In such cases, the individual TxRx connection segment should have loss characteristics less than the total allowed loss characteristic for the TxRx connection. It is the responsibility of the implementer to ensure that the TxRx connection is constructed from individual TxRx connection segments such that the over TxRx connection requirements are met. Loss characteristics for individual TxRx connection segments are beyond the scope of this standard.

Each TxRx connection segment shall comply with the impedance requirements detailed in 5.2.6 for the conductive material from which they are formed. A passive equalizer network, if present, shall be considered part of the TxRx connection.

TxRx connections shall be applied only to homogenous ground applications (e.g., between devices within an enclosure or rack, or between enclosures interconnected by a common ground return or ground plane).

5.3.3.3.2 TxRx connection characteristics for 1.5 Gbps and 3 Gbps

For 1.5 Gbps and 3 Gbps, each TxRx connection shall be designed such that its loss characteristics are less than:

- the loss of the TCTF test load plus ISI at 3 Gbps (see figure 112 in 5.3.2.3) over the frequency range of 50 MHz to 3 000 MHz; or
- if the system supports SATA devices using Gen2i levels (see SATA-2) but the receiver device does not support SATA Gen2i levels through the TCTF test load, the loss of the low-loss TCTF test load plus ISI (see figure 114 in 5.3.2.4) over the frequency range of 50 MHz to 3 000 MHz.

Each TxRx connection shall meet the delivered signal specifications in table 68 (see 5.3.7.3).

For external cable assemblies, these electrical requirements are consistent with using good quality passive cable assemblies constructed with shielded twinaxial cable with 24 gauge solid wire up to 6 m long, provided that no other TxRx connection segments are included in the TxRx connection.

5.3.3.3.3 TxRx connection characteristics for 6 Gbps

For 6 Gbps, the TxRx connection shall support a bit error ratio (BER) that is less than 10^{-15} (i.e., fewer than one bit error per 10^{15} bits) based on simulation results using S-parameter measurements of the TxRx connection, the reference transmitter device (see 5.3.6.5.4), and the reference receiver device (see 5.3.7.4.3).

NOTE 24 - Because simulations typically do not include all aspects of noise that may degrade the received signal quality, the goal of a BER that is less than 10^{-15} is expected to yield an actual BER that is less than 10^{-12} .

3 Gbps (see figure 112)

Figure 112 is a 1.5 Gbps table.

Item a) should probably refer to both tables for a given compliance point.: - for CT, the interconnect must be better than figure 112 (using revision 14 figure numbers) at 1.5 Gbps and figure 110 at 3 Gbps. - for IT, the interconnect must be better than figure 111 at 1.5 Gbps and figure 109 at 3 Gbps.

(from Justin Wang, Uniconn)

Author: RElliott
Subject: Highlight
Date: 9/3/2008 6:27:36 PM

 ACCEPT - DONE

24 gauge
s/b
24 AWG

(from George Penokie, LSI)

Author: RElliott
Subject: Cross-Out
Date: 6/30/2008 6:16:52 PM

 ACCEPT - DONE (per Alvin)

typically

Author: stx-alvin-cox
Subject: Note
Date: 6/6/2008 3:55:34 PM

 ACCEPT - DONE (Alvin: Accept. Change "Because" to "Since" and change the note to regular text as a continuation of the above paragraph.)

Why is this a note rather than text included in the specification?

Author: lsi-gpenokie
Subject: Highlight
Date: 6/6/2008 3:55:00 PM

 REJECT (Alvin: Reject. Should not be actual less than 10-15 based on text description.)

This << an actual BER that is less than 0-12. >> is a really bad thing to state. It should be << an actual BER that is less that 10-15 >>

Author: hpq-relliott
Subject: Note
Date: 9/4/2008 2:46:03 PM

 ACCEPT - TODO (

9/4 want to put the numbers in a separate section, rather than combine them, so they can differ in the future if appropriate

Alvin: Accept. Add sentence:

The TxRx connection simulation results shall comply with the 6 Gbps simulation results stated in Table 62 for transmitter devices.)

Need to state the goals for the statistical eye calculated by the reference receiver when performing channel testing:

minimum amplitude 100 mV
maximum TJ 0.60 UI

Author: RElliott
Subject: Note

Comments from page 181 continued on next page

5.3.3.3 TxRx connection characteristics

5.3.3.3.1 TxRx connection characteristics overview

Each TxRx connection shall support a bit error ratio (BER) that is less than 10^{-12} (i.e., fewer than one bit error per 10^{12} bits). The parameters specified in this standard support meeting this requirement under all conditions including the minimum input and output amplitude levels.

A TxRx connection may be constructed from multiple TxRx connection segments (e.g., backplane, cable, cable, backplane). In such cases, the individual TxRx connection segment should have loss characteristics less than the total allowed loss characteristic for the TxRx connection. It is the responsibility of the implementer to ensure that the TxRx connection is constructed from individual TxRx connection segments such that the over TxRx connection requirements are met. Loss characteristics for individual TxRx connection segments are beyond the scope of this standard.

Each TxRx connection segment shall comply with the impedance requirements detailed in 5.2.6 for the conductive material from which they are formed. A passive equalizer network, if present, shall be considered part of the TxRx connection.

TxRx connections shall be applied only to homogenous ground applications (e.g., between devices within an enclosure or rack, or between enclosures interconnected by a common ground return or ground plane).

5.3.3.3.2 TxRx connection characteristics for 1.5 Gbps and 3 Gbps

For 1.5 Gbps and 3 Gbps, each TxRx connection shall be designed such that its loss characteristics are less than:

- a) the loss of the TCTF test load plus ISI at 3 Gbps (see figure 112 in 5.3.2.3) over the frequency range of 50 MHz to 3 000 MHz; or
- b) if the system supports SATA devices using Gen2i levels (see SATA-2) but the receiver device does not support SATA Gen2i levels through the TCTF test load, the loss of the low-loss TCTF test load plus ISI (see figure 114 in 5.3.2.4) over the frequency range of 50 MHz to 3 000 MHz.

Each TxRx connection shall meet the delivered signal specifications in table 68 (see 5.3.7.3).

For external cable assemblies, these electrical requirements are consistent with using good quality passive cable assemblies constructed with shielded twinaxial cable with 24 gauge solid wire up to 6 m long, provided that no other TxRx connection segments are included in the TxRx connection.

5.3.3.3.3 TxRx connection characteristics for 6 Gbps

For 6 Gbps, the TxRx connection shall support a bit error ratio (BER) that is less than 10^{-15} (i.e., fewer than one bit error per 10^{15} bits) based on simulation results using S-parameter measurements of the TxRx connection, the reference transmitter device (see 5.3.6.5.4), and the reference receiver device (see 5.3.7.4.3).

NOTE 24 - Because simulations typically do not include all aspects of noise that may degrade the received signal quality, the goal of a BER that is less than 10^{-15} is expected to yield an actual BER that is less than 10^{-12} .



Date: 6/30/2008 6:16:52 PM

 ACCEPT - DONE (5/5 yes on step size and max frequency (the only ones discussed). Also included passivity/causality. Ignoring min frequency and reciprocity.

Added:

"The S-parameter measurements shall:

- a) have a minimum step size of 10 MHz;
 - b) have a maximum frequency of at least 20 GHz;
 - c) be passive (i.e., the output power is less than or equal to the input power); and
 - d) be causal (i.e., the output depends only on past inputs).
- "

There are several parameters that can cause corrupt simulations with S-parameter files: minimum frequency (especially 0 Hz), frequency step size, max frequency, reciprocity, passivity, and causality.

See Anthony Sanders' DesignCon 2008 paper "Issues of Frequency Content of S-Parameter Data for High-Speed Channel Evaluation." This recommends a maximum of 4.5x the baud rate (e.g., $4.5 \times 6 = 27$ GHz). Since 20 GHz VNAs are currently state of the art, though, we can only reasonably demand 20 GHz for physically measured S-parameters. The Cadence "Guidelines for Robust S-Parameter Model Development Application Note" suggests $2/\text{rise_time}$ (e.g., $2/41.67 \text{ ps} = 48 \text{ GHz}$), which is impractical.

The T11 web site has a MATLAB script to check passivity. (it is possible to correct passivity as well) Causality is often discussed, but I haven't found a publicly available script to check it or correct it.

Author: RElliott

Subject: Note

Date: 9/4/2008 2:46:17 PM

 REFER PHYSICAL WG

need to clarify if the simulation target includes crosstalk or not

Figure 116 shows an example circuit for simulation. The specific simulation program used (e.g., StatEye from <http://www.stateye.org>) is not specified by this standard.

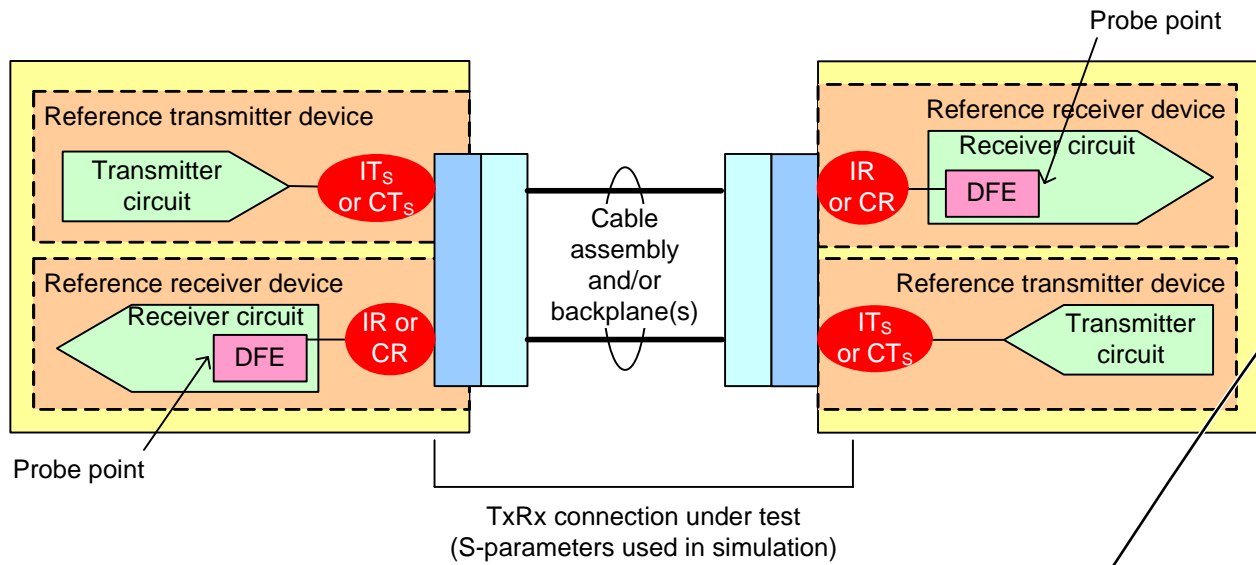

Figure 116 — Example 6 Gbps TxRx connection compliance testing

For external cable assemblies, these electrical requirements are consistent with using good quality passive Mini SAS 4x cable assemblies constructed with shielded twinaxial cable with 24 gauge solid wire up to 10 m long, provided that no other TxRx connection segments are included in the TxRx connection.

A TxRx connection supporting 6 Gbps may not support 1.5 Gbps and 3 Gbps and may not support SATA. SAS 6 Gbps transceiver devices incorporate enhanced features to allow them to operate over TxRx connections with higher loss than TxRx connections compliant with previous versions of this standard, TxRx connections defined in this standard for 1.5 Gbps and 3 Gbps (see 5.3.3.3.2), and TxRx connections supporting SATA.

5.3.3.4 Receiver device general electrical characteristics

Table 56 defines the receiver device general electrical characteristics.

Table 56 — Receiver device general electrical characteristics

Characteristic	Units	1.5 Gbps	3 Gbps	6 Gbps
Physical link rate long-term tolerance at IR if SATA is not supported	ppm		± 100	
Physical link rate long-term tolerance at IR if SATA is supported	ppm		± 350	
Physical link rate SSC modulation tolerance at IR	ppm		See table 78 in 5.3.8.3	
Maximum receiver device transients ^a	V		± 1.2	
Minimum Receiver A.C. common-mode voltage tolerance V_{CM} ^b	mV(P-P)		150	
Receiver A.C. common-mode frequency tolerance range F_{CM} ^b	MHz		2 to 200	

^a See 5.3.4 for transient test circuits and conditions.

^b Receiver devices shall tolerate sinusoidal common-mode noise components within the peak-to-peak amplitude (V_{CM}) and the frequency range (F_{CM}).

● Author: RElliott
Subject: Highlight
Date: 9/3/2008 6:27:43 PM
T ACCEPT - DONE

24 gauge
s/b
24 AWG

(from George Penokie, LSI)

● Author: Isi-gpenokie
Subject: Highlight
Date: 7/17/2008 6:04:26 PM
T ACCEPT - DONE (7/15 change to a)b)c) list.

It is not a complete sentence; it is the 2nd and 3rd part of the sentence in which it is located. An a)b)c) list could be a possible improvement, but no change is currently planned)

I don't understand what this is stating as it does not read as a complete sentence << TxRx connections defined in this standard for 1.5 Gbps and 3 Gbps (see 5.3.3.3.2), and TxRx connections supporting SATA. >> It needs to be fixed.

Table 57 defines the receiver device termination characteristics.

Table 57 — Receiver device termination characteristics

Characteristic	Units	1.5 Gbps	3 Gbps	6 Gbps
Differential impedance ^{a, b, c}	ohm	100 ± 15		See 5.3.7.4.1
Maximum differential impedance imbalance ^{a, b, c, d}	ohm	5		See 5.3.7.4.2 ^e
Maximum receiver termination time constant ^{a, b, c}	ps	150	100	N/A
Common-mode impedance ^{a, b}	ohm	20 min/40 max		See 5.3.7.4.1

^a All receiver device termination measurements are made through mated connector pairs.

^b The receiver device termination impedance specification applies to all receiver devices in a TxRx connection and covers all time points between the connector nearest the receiver device, the receiver device, and the transmission line terminator. This measurement shall be made from that connector.

^c At the time point corresponding to the connection of the receiver device to the transmission line, the input capacitance of the receiver device and its connection to the transmission line may cause the measured impedance to fall below the minimum impedances specified in this table. With impedance measured using amplitude in units of ρ (i.e., the reflection coefficient, a dimensionless unit) and duration in units of time, the area of the impedance dip caused by this capacitance is the receiver termination time constant. The receiver termination time constant shall not be greater than the values shown in this table.

An approximate value for the receiver termination time constant is given by the product of the amplitude of the dip in units of ρ and the width of the dip in units of time, as measured at the half amplitude point. The amplitude is defined as the difference in the reflection coefficient between the reflection coefficient at the nominal impedance and the reflection coefficient at the minimum impedance point.

The value of the receiver device excess input capacitance is given by the following equation:

$$C = \frac{\text{receiver termination time constant}}{(R_0 \parallel R_R)}$$

where (R₀ || R_R) is the parallel combination of the transmission line characteristic impedance and termination resistance at the receiver device.

^d The difference in measured impedance to SIGNAL GROUND on the plus and minus terminals on the interconnect, transmitter device, or receiver device, with a differential test signal applied to those terminals.

^e Measurement replaced by S_{cd2z} specifications (i.e., differential to common mode conversion).

5.3.4 Transmitter and receiver device transients

Transients may occur at transmitter devices or receiver devices as a result of changes in supply power conditions or mode transitions.

A mode transition is an event that may result in a measurable transient due to the response of the transmitter device or receiver device. The following conditions constitute a mode transition:

- a) enabling or disabling driver circuitry;
- b) enabling or disabling receiver common-mode circuitry;
- c) hot plug event;
- d) adjusting driver amplitude;
- e) enabling or disabling de-emphasis; and
- f) adjusting terminator impedance.

Transmitter device transients are measured at nodes V_P and V_N with respect to GROUND on the test circuit shown in figure 117 during all power state and mode transitions. Receiver device transients are measured at nodes V_P and V_N with respect to GROUND on the test circuit shown in figure 118 during all power state and

Page: 183

Author: pmcs-rhernandez

Subject: Note

Date: 5/24/2008 12:10:20 PM

 REJECT (Alvin: This is accomplished by the reference to different sections to determine the 6 Gbps values. It made logical sense to include those reference locations here, understanding that the methodology is different.)

In table 57 (page 183), notes a, b, c & d should only apply to 1.5Gbps and 3Gbps

Author: lsi-gpenokie

Subject: Highlight

Date: 5/24/2008 12:08:50 PM

 REJECT (Alvin: The context states what connector.)

From what connector ?? This << made from that connector >> should be << made from the connector nearest the receiver device >> I think.

Author: RElliott

Subject: Note

Date: 6/30/2008 6:16:52 PM

 ACCEPT - DONE

Convert the receiver termination time constant paragraph into an equation format with a where: list. That matches the format of the receiver device excess input capacitance equation that follows.

Author: lsi-gpenokie

Subject: Highlight

Date: 5/24/2008 12:05:47 PM

 REJECT (but converted whole paragraph into an equation. That ends up moving this into an i.e. inside the where list)

This << The amplitude is defined as >> should be << Where the amplitude is defined as >>

Author: RElliott

Subject: Note

Date: 6/30/2008 6:16:52 PM

 ACCEPT - DONE

Change R0 and RR to use subscripts

Author: RElliott

Subject: Note

Date: 6/30/2008 6:16:52 PM

 ACCEPT - DONE

use equation formatting for the where: material

Author: hpq-relliott

Subject: Highlight

Date: 5/6/2008 4:07:48 PM

 ACCEPT - DONE

cd
s/b
CD

mode transitions. Test conditions shall include power supply power on and power off conditions, voltage sequencing, and mode transitions.

Figure 117 shows the test circuit attached to IT or CT to test transmitter device transients.

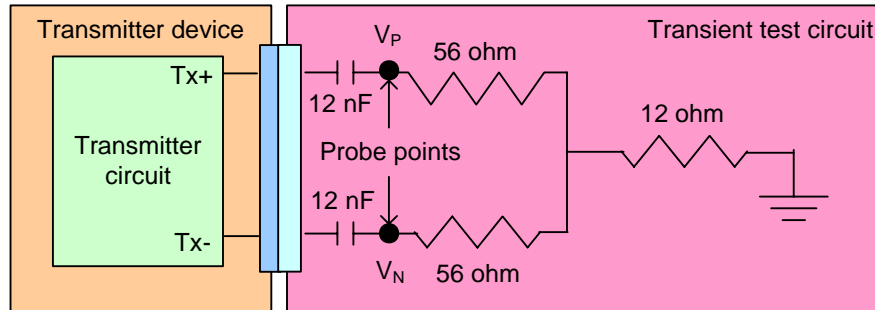

Figure 117 — Transmitter device transient test circuit

Figure 118 shows the test circuit attached to IR or CR to test receiver device transients.

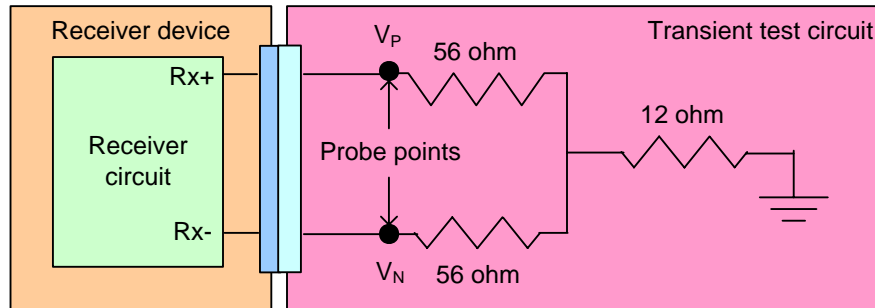

Figure 118 — Receiver device transient test circuit

5.3.5 Eye masks and the jitter transfer function (JTF)

5.3.5.1 Eye masks overview

The eye masks shown in this subclause shall be interpreted as graphical representations of the voltage and time limits of the signal. The eye mask boundaries define the eye contour of:

- the 10^{-12} jitter population for 1.5 Gbps and 3 Gbps measured eyes; and
- the 10^{-15} jitter population for 6 Gbps simulated eyes.

For 1.5 Gbps and 3 Gbps, equivalent time sampling oscilloscope technology is not practical for measuring compliance to the eye masks. See MJSQ for methods that are suitable for verifying compliance to these eye masks.

For 6 Gbps, simulations are used to approximate the eye diagram after application of receiver equalization, instead of direct measurements of the signal at the IR and CR compliance points.

CJTPAT shall be used for all jitter testing unless otherwise specified. Annex A defines the required pattern on the physical link and provides information regarding special considerations for running disparity (see 6.2) and scrambling (see 7.6).

5.3.5.2 Jitter transfer function (JTF)

With the possible presence of SSC, the application of a single pole high-pass frequency-weighting function that progressively attenuates jitter at 20 dB/decade below a frequency of $(f_{\text{baud}} / 1\ 667)$ as specified in previous versions of this standard does not separate the SSC component from the actual jitter and thus may overstate the transmitter device jitter. To differentiate between allowable timing variation due to SSC and jitter, the frequency-weighting jitter transfer function (JTF) function shall be applied to the signal at the compliance point when determining the eye mask.

● Author: Isi-gpenokie
Subject: Highlight
Date: 5/6/2008 4:07:48 PM

T REJECT

This << Annex A defines the required pattern on the physical link and provides information regarding >> should be << See annex A for the required pattern on the physical link and for information regarding >>

● Author: RElliott
Subject: Underline
Date: 6/30/2008 6:16:52 PM

T ACCEPT - DONE

(see 6.2)

point to new RD section

● Author: Isi-gpenokie
Subject: Highlight
Date: 5/24/2008 12:11:35 PM

T REJECT

This << the actual jitter and thus may overstate the transmitter device jitter. To >> should be << the actual jitter and as a result, the transmitter device jitter may be overstated. To >>

The jitter measurement device shall comply with the JTF. The reference clock characteristics are controlled by the resulting JTF characteristics obtained by taking the time difference between the PLL output (i.e., the reference clock) and the data stream sourced to the PLL. The PLL's closed loop transfer function's -3 dB corner frequency and other adjustable parameters (e.g., peaking) are determined by the value required to meet the requirements of the JTF.

The JTF shall have the following characteristics for a repeating 0011b or 1100b pattern (e.g., D24.3)(see table 235 in 10.2.9.2):

- the -3 dB corner frequency of the JTF shall be 2.6 ± 0.5 MHz;
- the magnitude peaking of the JTF shall be 3.5 dB maximum; and
- the attenuation at $30 \text{ kHz} \pm 1 \%$ shall be 72 dB to 75 dB.

The JTF -3 dB corner frequency and the magnitude peaking requirements shall be measured with sinusoidal PJ applied, with a peak-to-peak amplitude of $0.3 \text{ UI} \pm 10 \%$. The relative attenuation at 30 kHz shall be measured with sinusoidal phase (i.e., time) modulation applied, with a peak-to-peak amplitude of $20.8 \text{ ns} \pm 10 \%$.

A proportional decrease of the JTF -3 dB corner frequency should be observed for a decrease in pattern transition density compared to a 0.5 transition density. If a JMD shifts the JTF -3 dB corner frequency in a manner that does not match this characteristic, or does not shift at all, measurements of jitter with patterns with transition densities different than 0.5 may lead to discrepancies in reported jitter levels. In the case of reported jitter discrepancies between JMDs, the JMD with the shift of the -3 dB corner frequency that is closest to the proportional characteristic of the reference channel shall be considered correct. This characteristic may be measured with the conditions defined above for measuring the -3 dB corner frequency, but substituting other patterns with different transition densities.

5.3.5.3 Transmitter device eye mask

Figure 119 describes the eye mask used for testing the following:

- the signal output of the transmitter device at IT, CT, IR, and CR for 1.5 Gbps and 3 Gbps;
- the signal output of the transmitter device at IT and CT for 6 Gbps; and
- the simulated signal output of the reference receiver device at IR and CR for 6 Gbps.

This eye mask applies to jitter after the application of the JTF (see 5.3.5.2).

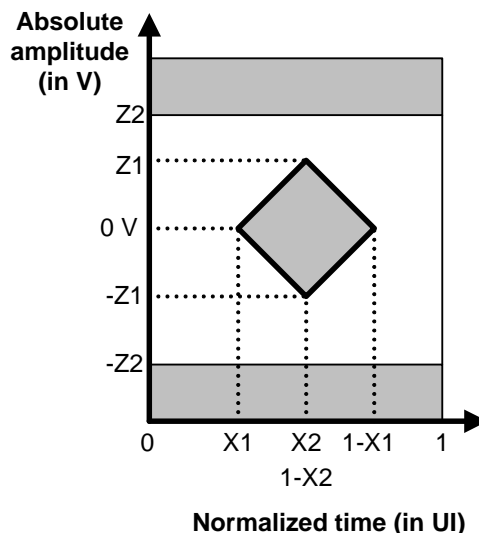

Figure 119 — Transmitter device eye mask

Verifying compliance with the limits represented by the transmitter device eye mask should be done with reverse channel traffic present in order that the effects of crosstalk are taken into account.

● Author: intc-mseidel
Subject: Highlight
Date: 5/24/2008 12:12:41 PM

T REJECT (Alvin: Reject due to limitations on test equipment capability.)

The 3-dB corner frequency of the JTF originally came from $F_{\text{baud}}/500$ for 3Gbps, which is 6 MHz (lowpass). The corresponding highpass corner frequency was found to be approximately 2.5 MHz, depending upon the particular characteristics of the tracking PLL filter. Doubling the baud rate should correspondingly increase the JTF corner frequency.

● Author: stx-alvin-cox
Subject: Note
Date: 5/24/2008 12:13:24 PM

T ACCEPT - DONE

First occurrence. jitter measurement device (JMD)

● Author: RElliott
Subject: Highlight
Date: 9/3/2008 6:33:01 PM

T ACCEPT - DONE

reference channel
s/b
reference transmitter test load (se 5.3.2.5)

(from George Penokie, LSI)

● Author: pmcs-gfortin
Subject: Highlight
Date: 5/24/2008 12:13:49 PM

T ACCEPT - DONE

This requirement is not strictly sufficient to get a realistic eye mask for devices with multiple channels, such as expanders. It is proposed include the impact of crosstalk from adjacent forward and reverse channels:

"Verifying compliance with the limits represented by the transmitter device eye mask should be done with reverse channel traffic present on the channel-under-test and with forward and reverse traffic present on all other channels, in order that the effects of crosstalk are taken into account."

5.3.5.4 Receiver device eye mask

Figure 120 describes the eye mask used for testing the following:

- the signal delivered to the receiver device at IR and CR for 1.5 Gbps and 3 Gbps; and
- the simulated signal delivered to the reference receiver device at IR and CR for 6 Gbps.

This eye mask applies to jitter after the application of the JTF (see 5.3.5.2). This requirement accounts for the low frequency tracking properties and response time of the CDRs in receiver devices.

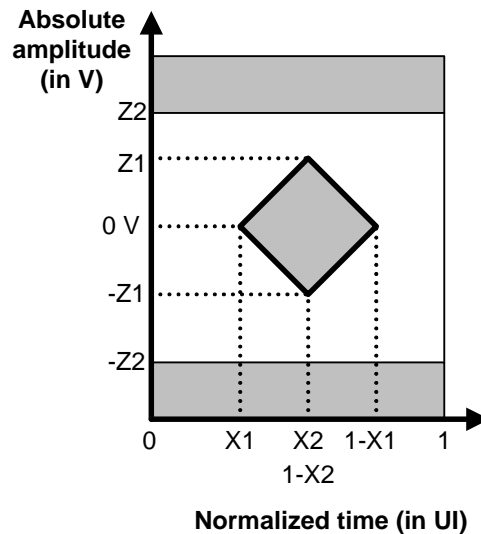

Figure 120 — Receiver device eye mask

Verifying compliance with the limits represented by the receiver device eye mask should be done with reverse channel traffic present in order that the effects of crosstalk are taken into account.

5.3.5.5 Receiver device jitter tolerance eye mask

Figure 121 describes the eye mask used to test the jitter tolerance of the receiver device at IR and CR for 1.5 Gbps and 3 Gbps. For 6 Gbps, jitter tolerance is included in the received signal specifications for receiver device physical testing (see 5.3.7.4.4).

The eye mask shall be constructed as follows:

- X_2 and Z_2 shall be the values for the delivered signal listed in table 68 (see 5.3.7.3);
- X_{1OP} shall be half the value of T_J for maximum delivered jitter listed in table 73 (see 5.3.7.5); and

Author: pmcs-gfortin
Subject: Highlight
Date: 5/24/2008 12:13:56 PM
ACCEPT - DONE

This requirement is not strictly sufficient to get a realistic eye mask for devices with multiple channels, such as expanders. It is proposed include the impact of crosstalk from adjacent forward and reverse channels:

"Verifying compliance with the limits represented by the receiver device eye mask should be done with reverse channel traffic present on the channel-under-test and with forward and reverse traffic present on all other channels, in order that the effects of crosstalk are taken into account."

- c) $X1_{TOL}$ shall be half the value of TJ for receiver device jitter tolerance listed in table 74 (see 5.3.7.6), for applied sinusoidal jitter frequencies above $(f_{baud} / 1007)$.

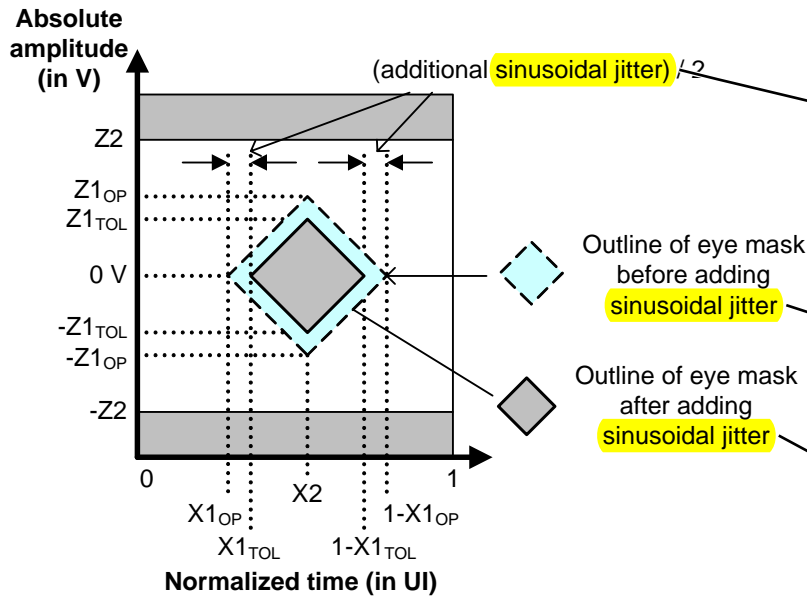

Figure 121 — Deriving a receiver device jitter tolerance eye mask

The leading and trailing edge slopes of the receiver device eye mask in figure 120 (see 5.3.5.4) shall be preserved. As a result, the amplitude value of Z1 is less than that given for the delivered signal in table 68 (see 5.3.7.3), and $Z1_{TOL}$ and $Z1_{OP}$ shall be defined from those slopes by the following equation:

$$Z1_{TOL} = Z1_{OP} \times \frac{X2 - \left(\frac{ASJ}{2}\right) - X1_{OP}}{X2 - X1_{OP}}$$

where:

- $Z1_{TOL}$ is the value for Z1 to be used for the receiver device jitter tolerance eye mask
- $Z1_{OP}$ is the Z1 value for the delivered signal in table 68
- $X1_{OP}$ is the X1 value for the delivered signal in table 68
- X2 is the X2 value for the delivered signal in table 68
- ASJ is the additional sinusoidal jitter defined in figure 122

The X1 points in the receiver device jitter tolerance eye mask (see figure 121) are greater than the X1 points in the receiver device eye mask (see figure 120) due to the addition of sinusoidal jitter.

● Author: RElliott
Subject: Highlight
Date: 6/30/2008 6:16:52 PM
T ACCEPT - DONE

sinusoidal jitter
s/b
SJ

● Author: RElliott
Subject: Highlight
Date: 6/30/2008 6:16:52 PM
T ACCEPT - DONE

sinusoidal jitter
s/b
SJ

● Author: RElliott
Subject: Highlight
Date: 6/30/2008 6:16:52 PM
T ACCEPT - DONE

sinusoidal jitter
s/b
SJ

● Author: RElliott
Subject: Highlight
Date: 6/30/2008 6:16:52 PM
T ACCEPT - DONE

sinusoidal jitter
s/b
SJ

● Author: RElliott
Subject: Highlight
Date: 6/30/2008 6:16:52 PM
T ACCEPT - DONE

sinusoidal jitter
s/b
SJ

● Author: RElliott
Subject: Highlight
Date: 6/30/2008 6:16:52 PM
T ACCEPT - DONE

sinusoidal jitter
s/b
SJ

Figure 122 defines the applied sinusoidal jitter.

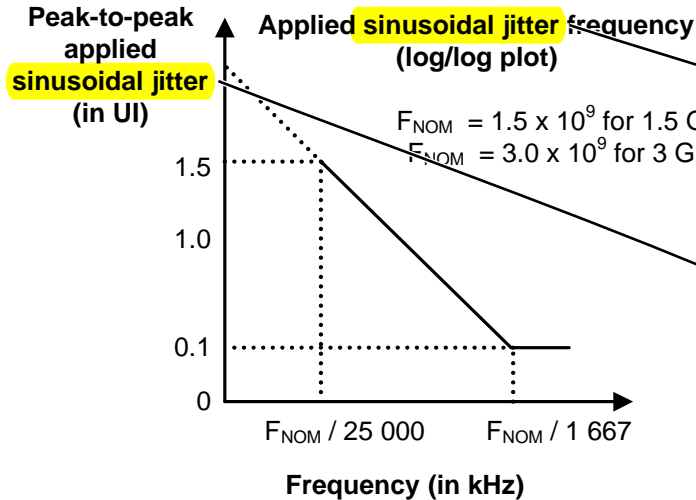

Figure 122 — Applied sinusoidal jitter

5.3.6 Transmitter device characteristics

5.3.6.1 Transmitter device characteristics overview

A.C. coupling requirements for transmitter devices are as follows:

- transmitter devices using inter-enclosure TxRx connections (i.e., attached to CT compliance points) shall be A.C. coupled to the interconnect through a transmission network;
- transmitter devices using intra-enclosure TxRx connections (i.e., attached to IT compliance points) that support SATA shall be A.C. coupled to the interconnect through a transmission network; and
- transmitter devices using intra-enclosure TxRx connections (i.e., attached to IT compliance points) that do not support SATA may be A.C. or D.C. coupled.

Transmitter devices may or may not incorporate de-emphasis (i.e., pre-emphasis) and other forms of compensation. The transmitter device shall use the same settings (e.g., de-emphasis and voltage swing) with both the zero-length test load and the appropriate TCTF test load or reference transmitter test load (see 5.3.2).

See B.5 for a methodology for measuring transmitter device signal output.

5.3.6.2 Transmitter device signal output characteristics as measured with the zero-length test load

Table 58 specifies the signal output characteristics for the transmitter device at 1.5 Gbps or 3 Gbps as measured with the zero-length test load (see 5.3.2.2) attached at a transmitter device compliance point (i.e.,

● Author: RElliott
Subject: Highlight
Date: 6/30/2008 6:16:52 PM
T ACCEPT - DONE

sinusoidal jitter
s/b
SJ

● Author: RElliott
Subject: Highlight
Date: 6/30/2008 6:16:52 PM
T ACCEPT - DONE

sinusoidal jitter
s/b
SJ

● Author: RElliott
Subject: Highlight
Date: 6/30/2008 6:16:52 PM
T ACCEPT - DONE

sinusoidal jitter
s/b
SJ

● Author: mxim-kwitt
Subject: Inserted Text
Date: 5/24/2008 12:26:59 PM

T REJECT (unless the stressed receiver sensitivity test changes, the Applied SJ figure is only referenced by the legacy 1.5 and 3 Gbps specifications, not the 6 Gbps specification)

$F_{NOM} = 6.0 \times 10^9$ for 6 Gbps

● Author: RElliott
Subject: Highlight
Date: 6/30/2008 6:16:52 PM
T ACCEPT - DONE

sinusoidal jitter
s/b
SJ

IT or CT). All specifications are based on differential measurements. See 5.3.6.5 for 6 Gbps transmitter device signal output characteristics.

Table 58 — Transmitter device signal output characteristics as measured with the zero-length test load at transmitter device compliance points IT and CT

Signal characteristic ^a	Units	1.5 Gbps	3 Gbps
Maximum intra-pair skew ^b	ps	20	15
Maximum transmitter device off voltage ^c	mV(P-P)	50	
Maximum rise/fall time ^d	ps	273	137
Minimum rise/fall time ^d	ps	67	
Maximum transmitter output imbalance ^e	%	10	

^a All tests in this table shall be performed with zero-length test load (see 5.3.2.2).
^b The intra-pair skew measurement shall be made at the midpoint of the transition with a repeating 01b or 10b pattern (e.g., D10.2 or D21.5)(see table 235 in 10.2.9.2) on the physical link. The same stable trigger, coherent to the data stream, shall be used for both the Tx+ and Tx- signals. Intra-pair skew is defined as the time difference between the means of the midpoint crossing times of the Tx+ signal and the Tx- signal.
^c The transmitter device off voltage is the maximum A.C. voltage measured at compliance points IT and CT when the transmitter is unpowered or transmitting D.C. idle (e.g., during idle time of an OOB signal).
^d Rise/fall times are measured from 20 % to 80 % of the transition with a repeating 01b or 10b pattern (e.g., D10.2 or D21.5)(see table 235 in 10.2.9.2) on the physical link.
^e The maximum difference between the V+ and V- A.C. RMS transmitter device amplitudes measured with CJTPAT (see A.2) into the zero-length test load shown in figure 105 (see 5.3.2.2), as a percentage of the average of the V+ and V- A.C. RMS amplitudes.

5.3.6.3 Transmitter device signal output characteristics as measured with each test load

Table 59 specifies the signal output characteristics for the transmitter device at 1.5 Gbps or 3 Gbps as measured with each test load (i.e., the zero-length test load (see 5.3.2.2) and either the TCTF test load (see 5.3.2.3) or the low-loss TCTF test load (see 5.3.2.4)) attached at a transmitter device compliance point (i.e., IT or CT). All specifications are based on differential measurements. See 5.3.6.5 for 6 Gbps transmitter device signal output characteristics.

This page contains no comments

Table 59 — Transmitter device signal output characteristics as measured with each test load at transmitter device compliance points IT and CT

Signal characteristic	Units	IT		CT	
		1.5 Gbps	3 Gbps	1.5 Gbps	3 Gbps
Maximum jitter (see figure 119 in 5.3.5.3) ^a	N/A	See table 73 in 5.3.7.5			
Maximum peak to peak voltage (i.e., 2 × Z2 in figure 119) if SATA is not supported	mV(P-P)	1 600			
Maximum peak to peak voltage (i.e., 2 × Z2 in figure 119) if SATA is supported	mV(P-P)	see SATA-2 ^d		N/A	
Minimum eye opening (i.e., 2 × Z1 in figure 119), if SATA is not supported	mV(P-P)	325	275	275	
Minimum eye opening (i.e., 2 × Z1 in figure 119), if SATA is supported	mV(P-P)	see SATA-2 ^d		N/A	
Half of maximum jitter (i.e., X1 in figure 119) ^b	UI	0.275			
Center of bit time (i.e., X2 in figure 119)	UI	0.50			
Maximum intra-pair skew ^c	ps	80	75	80	75
Maximum voltage (non-operational)	mV(P-P)	2 000			
<p>^a The value for X1 applies at a total jitter probability of 10⁻¹². At this level of probability, direct visual comparison between the mask and actual signals is not a valid method for determining compliance with the jitter requirements.</p> <p>^b The value for X1 shall be half the value of TJ for maximum delivered jitter listed in table 73. The test or analysis shall include the effects of a single pole high-pass frequency-weighting function that progressively attenuates jitter at 20 dB/decade below a frequency of ($f_{\text{baud}} / 1\ 667$).</p> <p>^c The intra-pair skew measurement shall be made at the midpoint of the transition with a repeating 01b or 10b pattern (e.g., D10.2 or D21.5)(see table 235 in 10.2.9.2) on the physical link. The same stable trigger, coherent to the data stream, shall be used for both the Tx+ and Tx- signals. Intra-pair skew is defined as the time difference between the means of the midpoint crossing times of the Tx+ signal and the Tx- signal at the probe points.</p> <p>^d Amplitude measurement methodologies of SATA and this standard differ. Under conditions of maximum rise/fall time and jitter, eye diagram methodologies used in this standard may indicate less signal amplitude than the technique specified by SATA-2. Implementors of designs supporting SATA are required to ensure interoperability and should perform additional system characterization with an eye diagram methodology using SATA devices.</p>					

5.3.6.4 Transmitter device maximum jitter

Table 60 defines the maximum jitter the transmitter device shall deliver at 1.5 Gbps or 3 Gbps as measured with each test load (i.e., the zero-length test load (see 5.3.2.2) and either the TCTF test load (see 5.3.2.3) or the low-loss TCTF test load (see 5.3.2.4)) at a transmitter device compliance point (i.e., IT or CT). SSC-induced high-frequency jitter is included in DJ and consequently in TJ at the transmitter output. SSC

Author: ibm-jay-diepenbrock
Subject: Highlight
Date: 5/24/2008 12:17:29 PM

TREJECT (Alvin: Reject. This table does not address cards and cables. Rob: This is a SAS-1.1 compatibility table, not SAS-2, so we don't want to change much. For SAS-2, although the jitter budget for the interconnect is not specific, you simulate the s-parameters with StatEye and determine if it complies or not.)

Separate budgets need allocated for cards and cables.

Author: ibm-jay-diepenbrock
Subject: Highlight
Date: 5/24/2008 12:20:00 PM

TREJECT (Alvin: Reject. This table specifies the transmitter device. Rob: SAS-2 removes the intra-pair cable skew spec for SAS-2 compliant channels, because it is misleading and incomplete - see 06-499 for details. Simulation of the s-parameters and evaluation of the statistical eye quality and Scd are the replacements.)

I don't see an allocation of in-pair skew for the cable separate from the rest of the system. How does a cable supplier know if his cable meets the spec. or not since he has no knowledge of the amount of skew on cards, etc.?
Please allocate separate portions of the skew and jitter budget to the cards and the cables and insertion loss.

Cable suppliers are having difficulty meeting the specs - even using the entire budget. They don't want to sign up to meet the spec'ed limits.

Author: pmcs-gfortin
Subject: Highlight
Date: 5/24/2008 12:22:59 PM

TACCEPT - DONE (Alvin: Accept wording change. This existing text does not match 07-339r9. Change to:
The value for X1 shall be half the value of TJ for maximum delivered jitter listed in table 73. The test or analysis shall include the effects of the JTF (see 5.3.5.2).)

In section 5.3.7.5 (p. 206), the first paragraph states:

"Table 73 defines the maximum jitter the system shall deliver to the receiver device at the receiver device compliance point (i.e., IR or CR) for 1.5 Gbps and 3 Gbps. SSC-induced high-frequency jitter is included in DJ and consequently TJ at the transmitter device output."

This implies that the value of X1 in table 59 must be measured with SSC-enabled. If true, then a single pole high-pass filter may not be sufficient to reject jitter and note b should instead refer to the JTF.

The reference to the single pole high-pass filter is also inconsistent with sections 5.3.5.3 and 5.3.5.4 that mandate usage of the JTF for jitter filtering.

Proposed rewording:

"The value for X1 shall be half the value of TJ for maximum delivered jitter listed in table 73. The test or analysis shall include the effects of the JTF."

Author: wdc-mevans
Subject: Highlight
Date: 5/24/2008 12:24:07 PM

TREJECT

and consequently in
s/b
and, as a result, in

shall be enabled if supported by the transmitter device. See 5.3.6.5 for 6 Gbps transmitter device signal output characteristics.

Table 60 — Transmitter device maximum jitter as measured with each test load at transmitter device compliance points IT and CT

Signal characteristic ^{a, b}	Units	1.5 Gbps	3 Gbps
Deterministic jitter (DJ) ^d	UI	0.35	
Total jitter (TJ) ^{c, d, e}	UI	0.55	

^a All DJ and TJ values are level 1 (see MJSQ).

^b The values for jitter in this table are measured at the average signal amplitude point.

^c TJ is specified at a CDF level of 10^{-12} .

^d The DJ and TJ values in this table apply to jitter measured as described in 5.3.5.3. Values for DJ and TJ shall be calculated from the CDF for the jitter population using the calculation of level 1 jitter compliance levels method in MJSQ.

^e If TJ received at any point is less than the maximum allowed, then the jitter distribution of the signal is allowed to be asymmetric. The TJ plus the magnitude of the asymmetry shall not exceed the allowed maximum TJ. The numerical difference between the average of the peaks with a BER that is less than 10^{-12} and the average of the individual events is the measure of the asymmetry. Jitter peak-to-peak measured $< (\text{maximum TJ} - |\text{Asymmetry}|)$.

This page contains no comments

5.3.6.5 Transmitter device signal output characteristics for 6 Gbps

5.3.6.5.1 Transmitter device signal output characteristics for 6 Gbps overview

Table 61 specifies the signal output characteristics for the transmitter device as measured with the zero-length test load (see 5.3.2.2), unless otherwise specified, attached at a transmitter device compliance point (i.e., IT or CT). All specifications are based on differential measurements.

Table 61 — Transmitter device signal output characteristics for 6 Gbps at IT and CT

Signal characteristic	Units	Minimum	Nominal	Maximum
Peak to peak voltage if SATA is not supported ^a	mV(P-P)	800		1 200
Transmitter device off voltage ^b	mV(P-P)			50
Maximum voltage (non-operational)	mV(P-P)		2 000	
Minimum rise/fall time ^c	UI	0.25 (41.6 ps)		
Reference differential impedance ^d	ohm		100	
Reference common mode impedance ^d	ohm		25	
Common mode voltage limit (rms) ^e	mV			30
Random jitter (RJ) ^f	UI			0.15 (25 ps)
Half of maximum jitter (i.e., X1 in figure 119) ^g	UI			0.30 (50 ps)
Minimum eye opening (i.e., 2 x Z1 in figure 119) ^g	mV(P-P)	100		

^a See 5.3.6.5.5 for measurement method.
^b The transmitter device off voltage is the maximum A.C. voltage measured at compliance points IT and CT when the transmitter is unpowered or transmitting D.C. idle (e.g., during idle time of an CQB signal).
^c Rise/fall times are measured from 20 % to 80 % of the transition with a repeating 01b or 10b pattern (e.g., D10.2 or D21.5)(see table 235 in 10.2.9.2) on the physical link.
^d For transmitter device S-parameters characteristics, see 5.3.6.5.2.
^e This is a broadband limit. For additional limits on spectral content, see figure 123 and table 62.
^f RJ is 14 times the RJ 1 sigma value, based on a BER of 10⁻¹². This test shall be performed with a repeating 01b or 10b pattern (e.g., D10.2 or D21.5)(see table 235 in 10.2.9.2) on the physical link. If the transmitter device supports SSC, this measurement shall be performed with both SSC enabled and SSC disabled. For simulations based on a BER of 10⁻¹⁵, the RJ specified is 17 times the RJ 1 sigma value.
^g This value is obtained by simulation. It represents the resulting signal output within the reference receiver device (see 5.3.7.4.3) after equalization, when the transmitter device output signal of CJTPAT is transmitted through the reference transmitter test load (see 5.3.2.5).

Page: 192

Author: RElliott
Subject: Highlight
Date: 9/4/2008 11:28:38 AM
 ACCEPT - DONE

800
s.b
850

per 08-202r1

Author: stx-alvin-cox
Subject: Note
Date: 9/4/2008 11:34:05 AM
 ACCEPT - DONE (per 08-202r1)

Shouldn't the maximum voltage (non-operational) be a minimum rather than nominal? For 1.5 and 3.0, it is not included in a min/nom/max line. Maybe this should be called non-operational withstanding voltage and be in the minimum column.

Author: stx-alvin-cox
Subject: Note
Date: 9/4/2008 11:34:43 AM
 ACCEPT - DONE (per 08-202)

Drop minimum from rise/fall time since the minimum is what is specified in the table.

Author: pmcs-gfortin
Subject: Highlight
Date: 9/4/2008 11:37:45 AM
 REFER PHYSICAL WG

Also apply note h

Author: pmcs-gfortin
Subject: Highlight
Date: 9/4/2008 11:37:29 AM
 REFER PHYSICAL WG

Also apply note h

Author: mxim-mbari
Subject: Note
Date: 9/4/2008 11:37:39 AM
 REFER PHYSICAL WG

Text at the beginning of the section mention measured values. Note g mention simulation. Should this be measured?

Author: lsi-jenkins
Subject: Highlight
Date: 9/4/2008 11:35:13 AM
 ACCEPT - DONE (per 08-202r1)

Change to 84 mV.

ref 08-146r1.

Author: mxim-mbari
Subject: Note
Date: 9/4/2008 11:36:24 AM
 REFER PHYSICAL WG

Comments from page 192 continued on next page

5.3.6.5 Transmitter device signal output characteristics for 6 Gbps

5.3.6.5.1 Transmitter device signal output characteristics for 6 Gbps overview

Table 61 specifies the signal output characteristics for the transmitter device as measured with the zero-length test load (see 5.3.2.2), unless otherwise specified, attached at a transmitter device compliance point (i.e., IT or CT). All specifications are based on differential measurements.

Table 61 — Transmitter device signal output characteristics for 6 Gbps at IT and CT

Signal characteristic	Units	Minimum	Nominal	Maximum
Peak to peak voltage if SATA is not supported ^a	mV(P-P)	800		1 200
Transmitter device off voltage ^b	mV(P-P)			50
Maximum voltage (non-operational)	mV(P-P)		2 000	
Minimum rise/fall time ^c	UI	0.25 (41.6 ps)		
Reference differential impedance ^d	ohm		100	
Reference common mode impedance ^d	ohm		25	
Common mode voltage limit (rms) ^e	mV			30
Random jitter (RJ) ^f	UI			0.15 (25 ps)
Half of maximum jitter (i.e., X1 in figure 119) ^g	UI			0.30 (50 ps)
Minimum eye opening (i.e., 2 x Z1 in figure 119) ^g	mV(P-P)	100		

^a See 5.3.6.5.5 for measurement method.

^b The transmitter device off voltage is the maximum A.C. voltage measured at compliance points IT and CT when the transmitter is unpowered or transmitting D.C. idle (e.g., during idle time of an OOB signal).

^c Rise/fall times are measured from 20 % to 80 % of the transition with a repeating 01b or 10b pattern (e.g., D10.2 or D21.5)(see table 235 in 10.2.9.2) on the physical link.

^d For transmitter device S-parameters characteristics, see 5.3.6.5.2.

^e This is a broadband limit. For additional limits on spectral content, see figure 123 and table 62.

^f RJ is 14 times the RJ 1 sigma value, based on a BER of 10⁻¹². This test shall be performed with a repeating 01b or 10b pattern (e.g., D10.2 or D21.5)(see table 235 in 10.2.9.2) on the physical link. If the transmitter device supports SSC, this measurement shall be performed with both SSC enabled and SSC disabled. For simulations based on a BER of 10⁻¹⁵, the RJ specified is 17 times the RJ 1 sigma value.

^g This value is obtained by simulation. It represents the resulting signal output within the reference receiver device (see 5.3.7.4.3) after equalization, when the transmitter device output signal of CJTPAT is transmitted through the reference transmitter test load (see 5.3.2.5).

Is this item better in Table 65 ?

Author: pmcs-gfortin
Subject: Highlight
Date: 9/4/2008 11:37:20 AM
 REFER PHYSICAL WG

With the bandwidth of the JTF scaling as a function of transition density, a D10.2 pattern will result in a stronger rejection of low frequency jitter than would a pattern with low transition density, such as D30.3. As such, an RJ measurement performed with a D10.2 pattern may not be representative of the worst case residual RJ seen by a reference receiver having a CDR function matching the JTF.

It is proposed to change the reference pattern to D30.3 to keep the jitter budget consistent with the worst case pattern for the JTF, since a receiver that implements a CDR that matches the JTF along with a 3-taps DFE should be a valid receiver.

"RJ is 14 times the RJ 1 sigma value, based on a BER of 10-12. This test shall be performed with a repeating D30.3 pattern (see table 235 in 10.2.9.2) on the physical link. If the transmitter device supports SSC, this measurement shall be performed with both SSC enabled and SSC disabled. For simulations based on a BER of 10-15, the RJ specified is 17 times the RJ 1 sigma value."

Author: pmcs-gfortin
Subject: Highlight
Date: 9/4/2008 11:37:06 AM
 REFER PHYSICAL WG (9/4 will probably use SASWDP to do this simulation, like for receiver device sensitivity channel calibration)

No standard method is specified to record the transmitter signal and perform the required simulation. Implementation by different vendors may yield inconsistencies in what constitutes a compliant transmitter and may result in inter-operability issues.

Author: RElliott
Subject: Note
Date: 9/4/2008 11:38:00 AM
 REFER PHYSICAL WG

Transmitter device physical testing should be its own section, expanding upon note g

Author: pmcs-gfortin
Subject: Highlight
Date: 9/4/2008 11:38:13 AM
 REFER PHYSICAL WG

It is proposed to add note h:

"The test or analysis shall include the effects of the JTF."

Figure 123 shows the transmitter device common mode voltage limit.

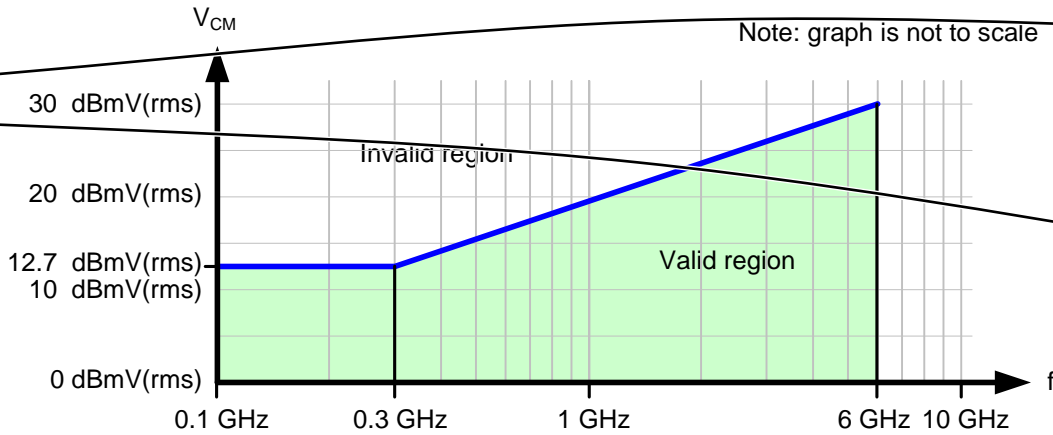

Figure 123 — Transmitter device common mode voltage limit

Table 62 defines the transmitter device common mode voltage limit characteristics.

Table 62 — Transmitter device common mode voltage limit characteristics

Characteristic ^a	Reference	L (dBmV)	N (dBmV) ^b	S (dBmV/decade)	f _{min} (MHz)	f _{max} (GHz)
Spectral limit of common mode voltage	Figure 123	12.7	26.0	13.3	100	6.0

^a See figure 124 for characteristic descriptions.

^b For dBmV, the reference level of 0 dBmV is 1 mV (rms). Hence, 0 dBm is 1 mW which is 158 mV (rms) across 25 ohms (i.e., the reference impedance for common mode voltage) which is $20 \times \log_{10}(158) = +44$ dBmV. +26 dBmV is therefore -18 dBm.

^c Maximum value at the Nyquist frequency (i.e., 3 GHz) (see figure 123).

^d The transmitter device common mode voltage shall be measured with a 1 MHz resolution bandwidth through the range of 100 MHz to 6 GHz with the transmitter device output of CJTPAT. The end points of the range shall be at the center of the measurement bandwidth.

5.3.6.5.2 Transmitter device S-parameters

S-parameters limits shall be calculated per the following formula. Variables are illustrated in figure 124 and specified in table 63.

$$\text{Measured value} < \max [L, \min [H, N + 13.3 \log_{10}(f / 3 \text{ GHz})]]$$

where:

- S is the slope in dB/decade
- H is the maximum value (i.e., the high frequency asymptote)
- N is the value at the Nyquist frequency (i.e., 3 GHz)
- L is the minimum value (i.e., the low frequency asymptote)
- f is the frequency of the signal in Hz
- max [A, B] is the maximum of A and B
- min [A, B] is the minimum of A and B

● Author: RElliott
Subject: Note
Date: 9/1/2008 7:33:32 PM
 ACCEPT - DONE

Move the note to the bottom of the figure

(from Ralph Weber, per ISO editing of SAS-1.1)

● Author: RElliott
Subject: Note
Date: 6/30/2008 6:16:52 PM
 ACCEPT - DONE

dBmV(rms)

s/b

dBmV

the rms part is covered by the definition

● Author: pmcs-gfortin
Subject: Highlight
Date: 5/24/2008 12:30:52 PM

 ACCEPT - DONE
add note c as well

● Author: pmcs-gfortin
Subject: Highlight
Date: 5/24/2008 12:29:47 PM

 ACCEPT - DONE
note b should apply

● Author: pmcs-gfortin
Subject: Highlight
Date: 5/24/2008 12:29:36 PM

 ACCEPT - DONE
note b should apply

● Author: RElliott
Subject: Note
Date: 8/27/2008 3:12:31 PM

 REJECT (7/15 discussion in WG wasn't convinced of a need to change this at this date.)

The transmitter common-mode voltage limit is specified in two places, once in Table 61 as a broadband limit, and again in Figure 123 as a per-frequency-band limit. Table 61 limits the overall amount to 30 mVrms which translates to 84.9 mVpp if the AC signal is a pure sinusoid. Figure 123 imposes a limit in the band 100 MHz to 300 MHz (1 MHz measurement band) to 12.7 dBmV which translates to 4.3 mVrms and 12.2 mVpp if it is a pure sinusoid.

Furthermore, if the transmitter had energy at each band that followed the limits in Figure 123 it would far exceed the limit in Table 61. A collection of discrete frequencies at the limit in Figure 123 would violate the overall limit, such as (for example) spikes at 100 MHz, 200 MHz, and so on up to 1400 MHz at the Fig 123 limit would violate the overall limit. As another example, spikes at 100 MHz, 300 MHz, 500 MHz, and so on up to 1900 MHz would violate the limit, as would a set of spikes at 750 MHz, 1500 MHz, 2250 MHz and 3000 MHz. Note that these spikes would violate the “energy” aspect of the limit, where they are combined as a sum-of-squares and then translated effectively into a sinusoid. The actual combination of the spikes would depend on the relative phases; the smallest I could find for the 750/1500/2250/3000 MHz case was approximately 40 mV, so that combination of frequencies could not all simultaneously be at the Fig 123 levels.

Since these sinusoidal levels are quite small, I propose that we remove Figure 123 and its limits entirely and retain only the limit in Table 61. This absolute wide-band time-domain specification will be enough to limit transmitted CM energy and still allow the silicon and system designers enough leeway to specify their power supply noise and filtering limits depending upon the particular frequencies in their systems. This leeway should not jeopardize practical systems.

Mark Seidel

Figure 123 shows the transmitter device common mode voltage limit.

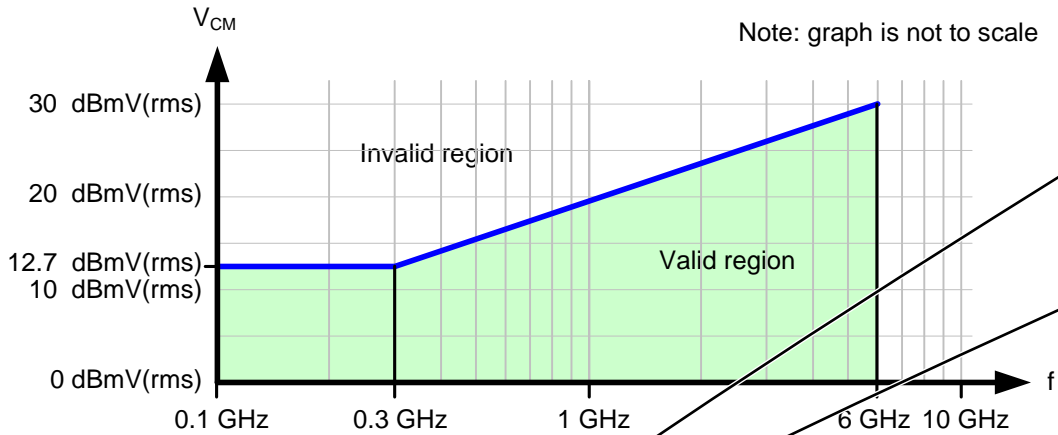

Figure 123 — Transmitter device common mode voltage limit

Table 62 defines the transmitter device common mode voltage limit characteristics.

Table 62 — Transmitter device common mode voltage limit characteristics

Characteristic ^a	Reference	L (dBmV)	N (dBmV) ^b	S (dBmV/decade)	f _{min} (MHz)	f _{max} (GHz)
Spectral limit of common mode voltage	Figure 123	12.7	26.0	13.3	100	6.0
^a See figure 124 for characteristic descriptions. ^b For dBmV, the reference level of 0 dBmV is 1 mV (rms). Hence, 0 dBm is 1 mW which is 158 mV (rms) across 25 ohms (i.e., the reference impedance for common mode voltage) which is $20 \times \log_{10}(158) = +44$ dBmV. +26 dBmV is therefore -18 dBm. ^c Maximum value at the Nyquist frequency (i.e., 3 GHz) (see figure 123). ^d The transmitter device common mode voltage shall be measured with a 1 MHz resolution bandwidth through the range of 100 MHz to 6 GHz with the transmitter device output of CJTPAT. The end points of the range shall be at the center of the measurement bandwidth.						

5.3.6.5.2 Transmitter device S-parameters

S-parameters limits shall be calculated per the following formula. Variables are illustrated in figure 124 and specified in table 63.

$$\text{Measured value} < \max [L, \min [H, N + 13.3 \log_{10}(f / 3 \text{ GHz})]]$$

where:

- S is the slope in dB/decade
- H is the maximum value (i.e., the high frequency asymptote)
- N is the value at the Nyquist frequency (i.e., 3 GHz)
- L is the minimum value (i.e., the low frequency asymptote)
- f is the frequency of the signal in Hz
- max [A, B] is the maximum of A and B
- min [A, B] is the minimum of A and B

Author: ifx-hnewman
Date: 5/24/2008 12:31:34 PM
 ACCEPT - DONE (added references to c and d)

c
Add footnote 'c' and 'd' to table.

Author: hpq-bolawsky
Subject: Note
Date: 5/24/2008 12:31:13 PM
 ACCEPT - DONE (added missing references)

Notes c and d are not used.

Author: RElliott
Subject: Underline
Date: 6/30/2008 6:16:52 PM
 ACCEPT - DONE

13.3 log₁₀

add the char-xmultiply symbol before "log"

Author: RElliott
Subject: Cross-Out
Date: 8/27/2008 2:52:02 PM
 ACCEPT - DONE

Delete
"S is the slope in dB/decade"

since it is not used in the formula

Figure 124 shows the S-parameter values.

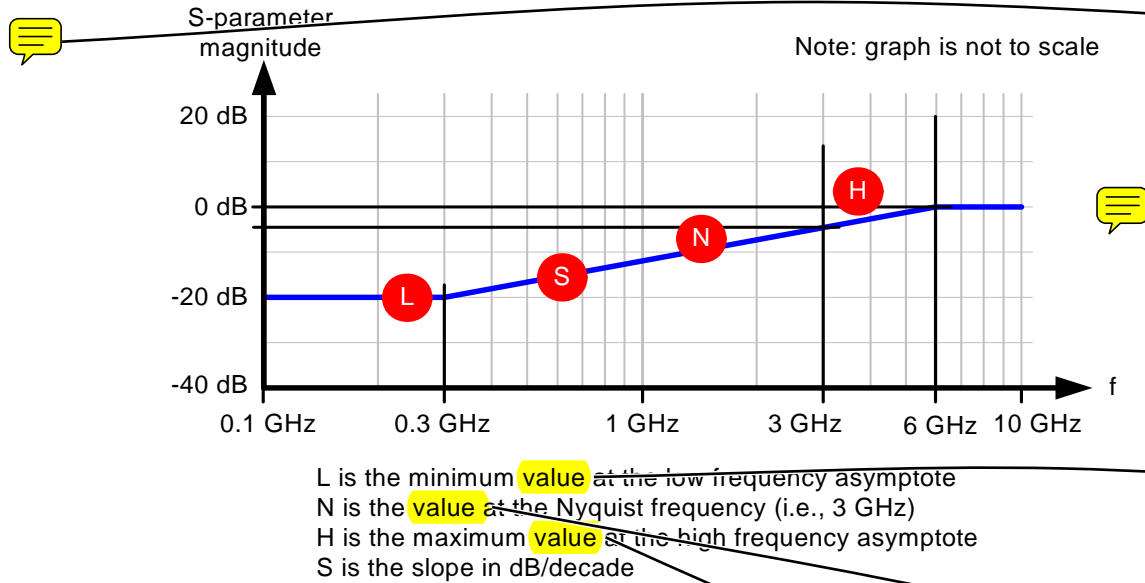

Figure 124 — S-parameter values

Table 63 defines the S-parameter limits of the transmitter device.

Table 63 — S-parameters at the transmitter device compliance point IT_s or CT_s

Characteristic ^a	Reference	L (dBmV)	N ^b (dBmV)	H (dB)	S (dBmV/decade)	f _{min} (MHz)	f _{max} (GHz)
S _{CC22}	Figure 125	-6.0	-5.0	0	13.3	100	6.0
S _{DD22}	Figure 125	-10	-7.9	0	13.3	100	6.0
S _{CD22}	Figure 126	-26	-12.7	-10	13.3	100	6.0

^a For S-parameter measurements, the transmitter under test shall transmit a repeating 0011b or 1100b pattern (e.g., D24.3)(see table 235 in 10.2.9.2). The amplitude applied by the test equipment shall be less than -4.4 dBm (190 mV zero to peak) per port. See B.9.4.2.

Page: 194

● Author: RElliott
Subject: Note
Date: 8/27/2008 3:20:45 PM
 ACCEPT - DONE

Move the note to the bottom of the figure

(from Ralph Weber, per ISO editing of SAS-1.1)

● Author: hpq-relliott
Subject: Note
Date: 8/27/2008 3:12:48 PM

 ACCEPT - DONE (move N so it is over the black line, at least. Right over the intersection of black and blue is ideal. Maybe make the graph taller and add some arrows. H can be an arrow as well. Refer back to 07-339 again)

Move N to the right

● Author: RElliott
Subject: Highlight
Date: 8/27/2008 3:20:09 PM
 ACCEPT - DONE (7/15)

value
s/b
value in dB

● Author: RElliott
Subject: Highlight
Date: 8/27/2008 3:20:22 PM
 ACCEPT - DONE (7/15)

value
s/b
value in dB

● Author: RElliott
Subject: Highlight
Date: 8/27/2008 3:20:15 PM
 ACCEPT - DONE (7/15)

value
s/b
value in dB

● Author: RElliott
Subject: Highlight
Date: 8/27/2008 10:18:12 AM
 ACCEPT - DONE

S-parameter limits
s/b
Maximum limits for S-parameters

to match cable assembly/backplane wording

● Author: RElliott
Subject: Highlight
Date: 8/27/2008 10:18:05 AM
 ACCEPT - DONE

S-parameters

Comments from page 194 continued on next page

Figure 124 shows the S-parameter values.

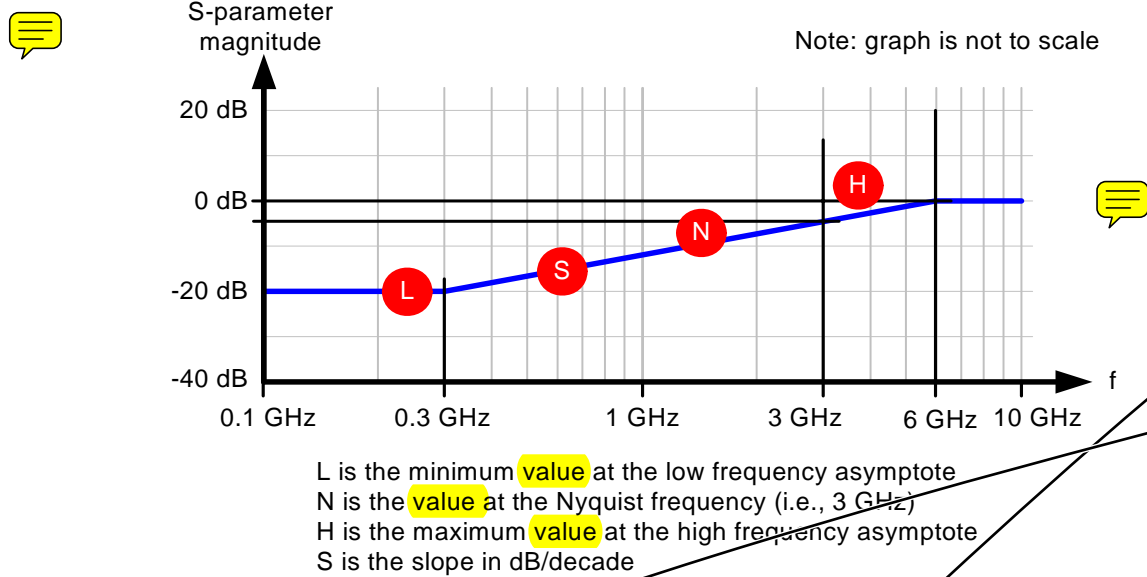

Figure 124 — S-parameter values

Table 63 defines the S-parameter limits of the transmitter device.

Table 63 — S-parameters at the transmitter device compliance point IT_s or CT_s

Characteristic ^a	Reference	L (dBmV)	N ^b (dBmV)	H (dB)	S (dBmV/decade)	f_{min} (MHz)	f_{max} (GHz)
S_{CC22}	Figure 125	-6.0	-5.0	0	13.3	100	6.0
S_{DD22}	Figure 125	-10	-7.9	0	13.3	100	6.0
S_{CD22}	Figure 126	-26	-12.7	-10	13.3	100	6.0

^a For S-parameter measurements, the transmitter under test shall transmit a repeating 0011b or 1100b pattern (e.g., D24.3)(see table 235 in 10.2.9.2). The amplitude applied by the test equipment shall be less than -4.4 dBm (190 mV zero to peak) per port. See B.9.4.2.

s/b

Maximum limits for S-parameters

to match cable assembly/backplane wording

● Author: hpq-bolawsky

Subject: Highlight

Date: 5/24/2008 12:36:57 PM

 ACCEPT - DONE (deleted reference to non-existent b. 07-399r9 did not include such a reference)

b

is wrong or missing

● Author: hpq-bolawsky

Subject: Note

Date: 5/6/2008 4:07:48 PM

 ACCEPT - DONE

All three dBmV references are inappropriate. Should be dB.

● Author: mxim-mbari

Subject: Note

Date: 5/24/2008 12:33:45 PM

 REJECT (Alvin: Reject. Correct as stated.)

From the plot I read this to be -2.5dB

Figure 125 shows the transmitter device S_{CC22} and S_{DD22} limits.

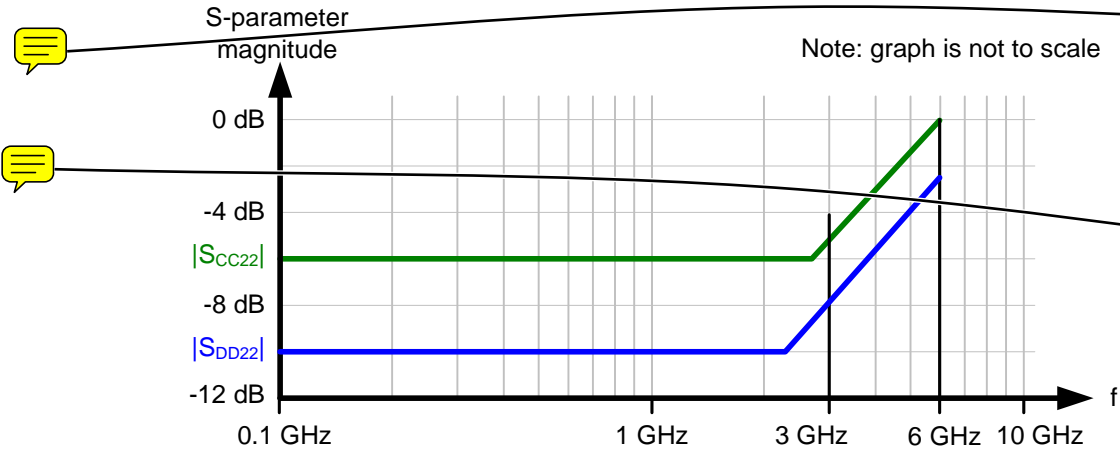

Figure 125 — Transmitter device S_{CC22} and S_{DD22} limits

Figure 126 shows the transmitter device S_{CD22} limits.

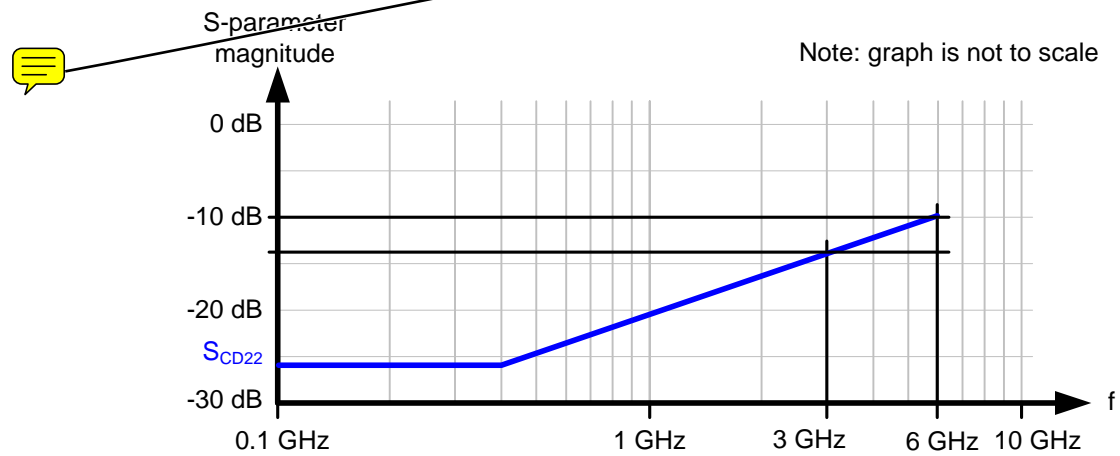

Figure 126 — Transmitter device S_{CD22} limits

5.3.6.5.3 Recommended transmitter device settings for interoperability

Table 64 defines recommended values for transmitter devices to provide interoperability with a broad range of implementations utilizing compliant TxRx connections and compliant receiver devices. The values are based on the evaluation of simulations with a variety of characterized physical hardware. Use of the recommended values does not guarantee that an implementation is capable of achieving a specific BER.

Specific implementations may obtain increased margin by deviating from the recommended values. However, such implementations are beyond the scope of this standard.

Table 64 — Recommended transmitter device settings at IT and CT

Characteristic	Units	Minimum	Nominal	Maximum
Differential voltage swing (mode) VMA ^a	mV	600	707	none
Transmitter equalization ^a	dB	2	3	4

^a See 5.3.6.5.5 for measurement method.

Page: 195

● Author: RElliott
Subject: Note
Date: 8/27/2008 4:15:42 PM
 ACCEPT - DONE

Move the note to the bottom of the figure

(from Ralph Weber, per ISO editing of SAS-1.1)

● Author: RElliott
Subject: Note
Date: 8/27/2008 4:15:30 PM
 ACCEPT - DONE

Combine figures 125/126

● Author: RElliott
Subject: Note
Date: 8/27/2008 4:15:57 PM
 REJECT (figure 126 merged into 125 instead)

Move the note to the bottom of the figure

(from Ralph Weber, per ISO editing of SAS-1.1)

● Author: stx-alvin-cox
Subject: Note
Date: 5/24/2008 12:37:22 PM
 ACCEPT - DONE

"none" is incorrect. A value was intentionally not supplied. This entry in the table should be left blank.

5.3.6.5.4 Reference transmitter device characteristics

The reference transmitter device is a set of parameters defining the electrical performance characteristics of a transmitter device to be used in simulation to determine compliance of an TxRx connection.

NOTE 25 — An S-parameter model of the reference transmitter device and reference receiver device is available from <http://www.t10.org> as document number 07-267r0 titled “SC SAS Reference TX & RX Termination Networks.” This model includes reference transmitter device (see 5.3.6.5.4) parameters and reference receiver device (see 5.3.7.4.3) parameters. 07-267r0.pdf describes how the models were created. 07-267r0.zip contains Touchstone® .s4p files containing the S-parameters. Touchstone® is a registered trademark of Agilent Corporation.

Editor’s Note 2: SAS-2 should incorporate the figures/equations from 07-267r0 explaining how the models were created.

Table 65 defines the reference transmitter device characteristics.

Table 65 — Reference transmitter device characteristics at IT and CT

Characteristic	Units	Value
Peak to peak voltage (V_{P-P}) ^a	mV(P-P)	1000 ^b
Transmitter equalization ^a	dB	2
Maximum rise/fall time ^c	UI	0.41 (68.3 ps)
RJ	UI	0.15 (25 ps)
D _J	UI	0.15 (25 ps)

^a See 5.3.6.5.5 for measurement method.
^b This is a higher value than the minimum required transmitter voltage defined in table 64 (see 5.3.6.5.1).
^c Rise/fall times are measured from 20 % to 80 % of the transition with a repeating 01b or 10b pattern (e.g., D10.2 or D21.5)(see table 235 in 10.2.9.2).

5.3.6.5.5 Transmitter equalization measurement

Transmitter equalization measurement shall be based on a mode (i.e., the most frequent value of a set of data) measurement for VMA and a peak-to-peak measurement for V_{P-P} with a repeating D30.3 pattern (see table 235 in 10.2.9.2).

The voltage measurements shall be made with the transmitter device terminated through the interoperability point into a zero length test load (see 5.3.2.2).

The V_{P-P} and VMA values shall be measured using an equivalent time sampling scope with a histogram function with the following or an equivalent procedure:

- 1) calibrate the sampling scope for measurement of a 3 GHz signal; and
- 2) determine the VMA mode value and V_{P-P} peak-to-peak value as illustrated in figure 127. A sample size of 1 000 minimum, 2 000 maximum histogram hits for VMA shall be used to determine the values. The histogram is a combination of two histograms, an upper histogram for TX+ and a lower histogram for TX-. The histograms on the left represent the test pattern signal displayed on the right.

Page: 196

● Author: stx-alvin-cox
Subject: Note
Date: 6/3/2008 9:29:00 AM
 ACCEPT - DONE (replaced with normative text)

Why is this a note rather than text included in the specification?

● Author: intc-mseidel
Subject: Highlight
Date: 6/6/2008 2:42:05 PM
 REJECT (we cannot incorporate a 1 MiB .s4p text file into the standard; it has to be delivered alongside)

Note 25 points to documents outside the standard; this standard should be made more stand-alone by incorporating needed information.

● Author: lsi-gpenokie
Subject: Highlight
Date: 6/3/2008 9:30:03 AM
 REJECT (There is nothing wrong with referencing a trademark. Replacing with normative text that "includes [the models] with this standard" - see other comment)

This is note is troubling for more than one reason. One is that it references a proposal. That is not going to fly at ISO and may be a problem at ANSI. I see two solutions- one would be to put it as an annex of this standard the other would be to create a technical report. The other problem is have a trademark. I don't have any good solution to that other than deleting it.

● Author: RElliott
Subject: Note
Date: 6/30/2008 6:16:52 PM
 ACCEPT - DONE

Replace note 25 with:
An S-parameter model of the reference transmitter device is included with this standard. The following files are included:
a) 07-267r0.pdf describes how the reference transmitter device and reference receiver device models were created; and
b) 07-267r0.s4p contains a Touchstone® file containing the S-parameters for each model.
Touchstone® is a registered trademark of Agilent Corporation.

● Author: RElliott
Subject: Highlight
Date: 6/30/2008 6:16:52 PM
 REJECT (reference 07-267r0.pdf instead of incorporating the equations into the standard itself)

Editor's Note 2:

● Author: stx-alvin-cox
Subject: Note
Date: 9/4/2008 11:39:28 AM
 ACCEPT - DONE (850, per 08-202r1)

This value should be closer to the minimum allowed transmitter output voltage.

● Author: lsi-jenkins
Subject: Note
Date: 9/4/2008 11:39:50 AM
 ACCEPT - DONE (per 08-202r1)

Change to 850 & delete note b.

ref: 08-144r1, 08-146r1

● Author: mxim-kwitt

Comments from page 196 continued on next page

5.3.6.5.4 Reference transmitter device characteristics

The reference transmitter device is a set of parameters defining the electrical performance characteristics of a transmitter device to be used in simulation to determine compliance of an TxRx connection.



NOTE 25 - An S-parameter model of the reference transmitter device and reference receiver device is available from <http://www.t10.org> as document number 07-267r0 titled "6G SAS Reference TX & RX



Termination Networks." This model includes reference transmitter device (see 5.3.6.5.4) parameters and reference receiver device (see 5.3.7.4.3) parameters. 07-267r0.pdf describes how the models were created. 07-267r0.zip contains Touchstone® .s4p files containing the S-parameters. Touchstone® is a registered trademark of Agilent Corporation.

Editor's Note 2: SAS-2 should incorporate the figures/equations from 07-267r0 explaining how the models were created.

Table 65 defines the reference transmitter device characteristics.

Table 65 — Reference transmitter device characteristics at IT and CT

Characteristic	Units	Value
Peak to peak voltage (V_{P-P}) ^a	mV(P-P)	1000 ^b
Transmitter equalization ^a	dB	2
Maximum rise/fall time ^c	UI	0.41 (66.5 ps)
RJ	UI	0.15 (25 ps)
DJ	UI	0.15 (25 ps)

^a See 5.3.6.5.5 for measurement method.
^b This is a higher value than the minimum required transmitter voltage defined in table 64 (see 5.3.6.5.1).
^c Rise/fall times are measured from 20 % to 80 % of the transition with a repeating 01b or 10b pattern (e.g., D10.2 or D21.5)(see table 235 in 10.2.9.2).

5.3.6.5.5 Transmitter equalization measurement

Transmitter equalization measurement shall be based on a mode (i.e., the most frequent value of a set of data) measurement for VMA and a peak-to-peak measurement for V_{P-P} with a repeating D30.3 pattern (see table 235 in 10.2.9.2).

The voltage measurements shall be made with the transmitter device terminated through the interoperability point into a zero length test load (see 5.3.2.2).

The V_{P-P} and VMA values shall be measured using an equivalent time sampling scope with a histogram function with the following or an equivalent procedure:

- 1) calibrate the sampling scope for measurement of a 3 GHz signal; and
- 2) determine the VMA mode value and V_{P-P} peak-to-peak value as illustrated in figure 127. A sample size of 1 000 minimum, 2 000 maximum histogram hits for VMA shall be used to determine the values. The histogram is a combination of two histograms, an upper histogram for TX+ and a lower histogram for TX-. The histograms on the left represent the test pattern signal displayed on the right.

Subject: Replacement Text
Date: 9/4/2008 11:40:34 AM
 ACCEPT - DONE (per 08-202)

850

● Author: Isi-jenkins
Subject: Highlight
Date: 9/4/2008 11:41:46 AM
 ACCEPT - DONE (per 08-202r1)

Change DJ to BUJ with value of 0.10 (16.7 ps)

ref: 08-144r1, 08-146r1

● Author: hpq-relliott
Subject: Note
Date: 9/4/2008 2:47:13 PM
 REFER PHYSICAL WG (need to make sure the default settings are updated, and sims have been run with these values)

StatEye default RJ/DJ is a bit different than this.

● Author: mxim-kwitt
Subject: Replacement Text
Date: 9/4/2008 11:42:08 AM
 ACCEPT - DONE (per 08-202r1)

0.1 (16.6 ps)

● Author: mxim-kwitt
Subject: Replacement Text
Date: 9/4/2008 2:46:46 PM
 ACCEPT - DONE (per 08-202r1)

BUJ

● Author: mxim-kwitt
Subject: Cross-Out
Date: 9/4/2008 11:40:34 AM
 ACCEPT - DONE

Delete note b

● Author: RElliott
Subject: Highlight
Date: 7/17/2008 5:59:52 PM
 ACCEPT - DONE

illustrated
s/b
shown

The VMA mode value and V_{P-P} peak value are determined by adding the values measured for TX+ and TX-.

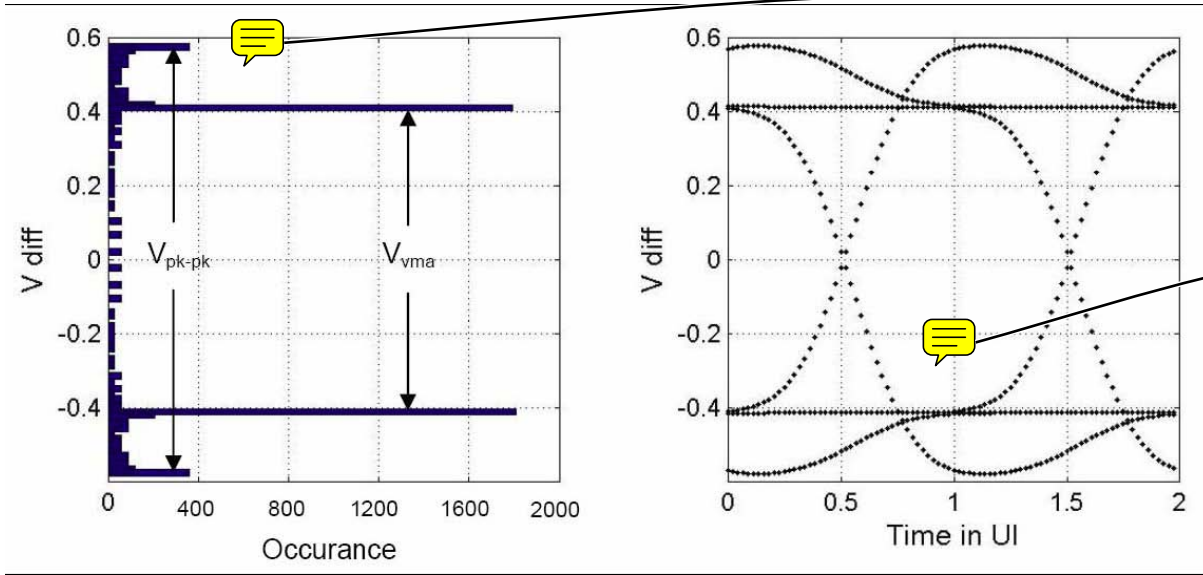

Figure 127 — Transmitter equalization measurement

Editor's Note 3: That figure needs to be redrawn in Visio - it is currently a bitmap. Normalize capitalization, spelling, add spaces to numbers for ISO style, etc.

The following formula shall be used to calculate the transmitter equalization value:

$$\text{Transmitter equalization} = 20 \times \log_{10} (V_{P-P} / \text{VMA}) \text{ dB}$$

where:

V_{P-P} is the peak-to-peak value
 VMA is the mode value

5.3.6.6 Transmitter device signal output for OOB signals

Transmitter devices supporting SATA shall use SATA Gen1i or Gen2i signal output levels (see SATA-2) during the first OOB sequence (see 6.7) after a power on or hard reset. If the phy does not receive COMINIT within a hot-plug timeout (see 6.7.5), the transmitter device shall increase its transmit levels to the OOB signal output levels specified in table 66 and perform the OOB sequence again. If no COMINIT is received within a hot-plug timeout of the second OOB sequence, the transmitter device shall initiate another OOB sequence using SATA Gen1i or Gen2i signal output levels. The transmitter device shall continue alternating between transmitting COMINIT using SATA Gen1i or Gen2i signal output levels and transmitting COMINIT with SAS signal output levels until the phy receives COMINIT.

If the phy both transmits and receives COMSAS (i.e., a SAS phy or expander phy is attached), the transmitter device shall set its transmit levels to the SAS signal output levels (see 5.3.6.2, 5.3.6.3, and 5.3.6.5) prior to beginning the SAS speed negotiation sequence (see 6.7.4.2). If it had been using SATA Gen1i or Gen2i signal output levels, this mode transition (i.e., output voltage change) may result in a transient (see 5.3.4) during the idle time between COMSAS and the SAS speed negotiation sequence.

If the transmitter device is using SAS signal output levels and the phy does not receive COMSAS (i.e., a SATA phy is attached), the transmitter device shall set its transmit levels to the SATA Gen1i or Gen2i signal output levels and restart the OOB sequence.

Transmitter devices that do not support SATA shall transmit OOB signals using SAS signal output levels.

Page: 197

Author: stx-alvin-cox

Subject: Note

Date: 6/3/2008 8:59:47 AM

 ACCEPT - DONE (incorporated updated figure from Kevin Witt (Maxim), which moves the arrows for Vpp and VMA to the right of the histogram peaks)

The pk-pk is not a mode measurement and should indicate some point beyond what appears as a mode value.

Author: mxim-kwitt

Subject: Note

Date: 6/3/2008 8:57:52 AM

 ACCEPT - DONE

Add updated figure from 08-144r1

Author: lsi-gpenokie

Subject: Highlight

Date: 6/3/2008 8:59:38 AM

 ACCEPT - DONE (updated figure from Kevin Witt, Maxim)

Figure 127 needs to have the correct capitalization, spelling, add spaces to numbers for ISO style, etc.

Author: RElliott

Subject: Highlight

Date: 6/30/2008 6:16:52 PM

 ACCEPT - DONE

the
s/b
then the

Author: RElliott

Subject: Highlight

Date: 6/30/2008 6:16:52 PM

 ACCEPT - DONE

the
s/b
then the

Author: RElliott

Subject: Highlight

Date: 6/30/2008 6:16:52 PM

 ACCEPT - DONE

the
s/b
then the

Author: RElliott

Subject: Highlight

Date: 6/30/2008 6:16:52 PM

 ACCEPT - DONE

the
s/b
then the

Comments from page 197 continued on next page

Table 66 defines the transmitter device OOB signal output characteristics.

Table 66 — Transmitter device OOB signal output characteristics

Characteristic	Units	IT	CT
Maximum peak to peak voltage (i.e., 2 x Z2 in figure 119) ^a	mV(P-P)		1 600
OOB offset delta ^b	mV		± 25
OOB common mode delta ^c	mV		± 50
Minimum OOB burst amplitude ^d , if SATA is not supported	mV(P-P)		240
Minimum OOB burst amplitude ^d , if SATA is supported	mV(P-P)	240 ^{e, f}	N/A

^a The recommended maximum peak to peak voltage is 1 200 mV(P-P).
^b The maximum difference in the average differential voltage (D.C. offset) component between the burst times and the idle times of an OOB signal.
^c The maximum difference in the average of the common-mode voltage between the burst times and the idle times of an OOB signal.
^d With a measurement bandwidth of 4.5 GHz, each signal level during the OOB burst shall exceed the specified minimum differential amplitude before transitioning to the opposite bit value or before termination of the OOB burst.
^e Amplitude measurement methodologies of SATA and this standard differ. Under conditions of maximum rise/fall time and jitter, eye diagram methodologies used in this standard may indicate less signal amplitude than the technique specified by SATA-2. Implementers of designs supporting SATA are required to ensure interoperability and should perform additional system characterization with an eye diagram methodology using SATA devices.
^f The OOB burst contains either 1.5 Gbps D24.3 characters, 1.5 Gbps ALIGN (0) primitives, or 3 Gbps ALIGN (0) primitives (see 6.6 and SATA-2).

5.3.7 Receiver device characteristics

5.3.7.1 Receiver device characteristics overview

A.C. coupling requirements for receiver devices are as follows:

- a) all receiver devices (i.e., attached to IR or CR compliance points) shall be A.C. coupled to the interconnect through a receive network

The receive network shall terminate the TxRx connection by a 100 ohm equivalent impedance.

The receiver device shall operate within the required BER (see 5.3.3.3.1) when a signal with valid voltage and timing characteristics is delivered to the receiver device compliance point from a nominal 100 ohm source. The received signal shall be considered valid if it meets the voltage and timing limits specified in table 68 (see 5.3.7.3) for 1.5 Gbps and 3 Gbps and table 69 (see 5.3.7.3) for 6 Gbps.

Additionally, for 1.5 Gbps and 3 Gbps the receiver device shall operate within the required BER when the signal has additional sinusoidal jitter present as specified in table 74 (see 5.3.7.6) with the common-mode signal V_{CM} as specified in table 56 (see 5.3.3). Jitter tolerance for receiver device compliance **points is illustrated in figure 121** (see 5.3.5.5). Figure 121 assumes that any external interference occurs prior to the point at which the test is applied. When testing the jitter tolerance capability of a receiver device, the additional 0.1 UI of sinusoidal jitter may be reduced by an amount proportional to the actual externally induced interference between the application point of the test and the input to the receiver device. The additional jitter reduces the eye opening in both voltage and time. For 6 Gbps, the additional jitter and common mode voltage is included in the receiver device physical test procedure (see 5.3.7.4.4).

See B.8 for a methodology for measuring receiver device signal tolerance.

Page: 198

● Author: RElliott
Subject: Note
Date: 9/4/2008 2:37:12 PM
 ACCEPT - DONE (added " as measured with each test load at IT and CT" to footnote d)

Lost the concept from SAS-1.1 of meeting these with both the zero-length and the TCTF test loads attached.

Transmitter must not transmit only 240 mV; it needs to deliver 240 mV after a TCTF test load.

● Author: stx-alvin-cox
Subject: Cross-Out
Date: 5/6/2008 4:07:48 PM
 ACCEPT - DONE

● Author: stx-alvin-cox
Subject: Inserted Text
Date: 5/6/2008 4:07:48 PM
 ACCEPT - DONE

with

● Author: wdc-mevans
Subject: Highlight
Date: 5/24/2008 12:38:36 PM
 REJECT (Rob: nothing wrong with adverbs. Alvin: Reject. From SAS 1.1)

Additionally
s/b
In addition

● Author: RElliott
Subject: Underline
Date: 6/30/2008 6:16:52 PM
 ACCEPT - DONE

sinusoidal jitter
s/b
SJ

● Author: lsi-gpenokie
Subject: Highlight
Date: 5/24/2008 12:40:02 PM
 REJECT (Alvin: Reject. From SAS 1.1)

This << points is illustrated in figure >> should be << points is defined in figure >>

● Author: RElliott
Subject: Underline
Date: 6/30/2008 6:16:52 PM
 ACCEPT - DONE

sinusoidal jitter
s/b
SJ

5.3.7.2 OOB delivered signal characteristics

Table 67 defines the amplitude requirements of the OOB signal delivered by the system with the zero-length test load (see 5.3.2.2) at the receiver device compliance point (i.e., IR or CR).

Table 67 — OOB delivered signal characteristics

Characteristic	Units	IR	CR
Minimum OOB burst amplitude ^a , if SATA is not supported	mV(P-P)	240 ^c	
Minimum OOB burst amplitude ^a , if SATA is supported	mV(P-P)	225 ^{b, c}	N/A
<p>^a With a measurement bandwidth of 4.5 GHz, each signal level during the OOB burst shall exceed the specified minimum differential amplitude before transitioning to the opposite bit value or before termination of the OOB burst.</p> <p>^b Amplitude measurement methodologies of SATA and this standard differ. Under conditions of maximum rise/fall time and jitter, eye diagram methodologies used in this standard may indicate less signal amplitude than the technique specified by SATA-2. Implementers of designs supporting SATA are required to ensure interoperability and should perform additional system characterization with an eye diagram methodology using SATA devices.</p> <p>^c The OOB burst contains either 1.5 Gbps D24.3 characters, 1.5 Gbps ALIGN (0) primitives, or 3 Gbps ALIGN (0) primitives (see 6.6 and SATA-2).</p>			

5.3.7.3 Delivered signal (receiver device signal tolerance) characteristics

Table 68 specifies the requirements of the signal delivered by the system with the zero-length test load (see 5.3.2.2) at the receiver device compliance point (i.e., IR or CR) for 1.5 Gbps and 3 Gbps. These imply the required signal tolerance characteristics of the receiver device. For 6 Gbps, see 5.3.7.4.

Table 68 — Delivered signal characteristics as measured with the zero length test load at receiver device compliance points IR and CR (part 1 of 2)

Signal characteristic	Units	IR		CR	
		1.5 Gbps	3 Gbps	1.5 Gbps	3 Gbps
Maximum peak to peak voltage (i.e., $2 \times Z2$ in figure 120) if a SATA phy is not attached	mV(P-P)	1 600		1 600	
Maximum peak to peak voltage (i.e., $2 \times Z2$ in figure 120) if a SATA phy is attached	mV(P-P)	see SATA-2 ^a		N/A	
Minimum eye opening (i.e., $2 \times Z1$ in figure 120), if a SATA phy is not attached	mV(P-P)	325	275	275	
Minimum eye opening (i.e., $2 \times Z1$ in figure 120), if a SATA phy using Gen1i or Gen1x levels is attached and the interconnect is characterized with the TCTF test load (see 5.3.2.3)	mV(P-P)	225 ^a	N/A	N/A	
Minimum eye opening (i.e., $2 \times Z1$ in figure 120), if a SATA phy using Gen2i levels is attached and the interconnect is characterized with the TCTF test load (see 5.3.2.3)	mV(P-P)	N/A	175 ^a	N/A	

● Author: RElliott
Subject: Highlight
Date: 6/30/2008 6:16:52 PM
T ACCEPT - DONE

at

add space

● Author: lsi-gpenokie
Subject: Highlight
Date: 8/29/2008 10:56:43 AM
T ACCEPT - DONE (7/15 "These also serve as...")

original reply: Alvin: Reject. From SAS 1.1 Rob: In SAS-1.1, that was vague - that's why we're doing a better job in SAS-2 and 6 Gbps. These are SAS-1.1 compatibility numbers.)

What is the term << imply >> doing in this standard? It has no valid definition and can only add to confusion. Either << These are the required signal tolerance characteristics of the receiver device. >> Or not. Or perhaps you mean << The required signal tolerance characteristics of the receiver device may be derived from the delivered signal characteristic defined in table 68. >> But that is only marginally better. There should be a table with the receiver device characteristics, not this unclear vague definition..

Table 68 — Delivered signal characteristics as measured with the zero length test load at receiver device compliance points IR and CR (part 2 of 2)

Signal characteristic	Units	IR		CR	
		1.5 Gbps	3 Gbps	1.5 Gbps	3 Gbps
Minimum eye opening (i.e., $2 \times Z1$ in figure 120), if a SATA phy using Gen2x levels is attached and the interconnect is characterized with the TCTF test load (see 5.3.2.3)	mV(P-P)	N/A	275 ^a	N/A	
Minimum eye opening (i.e., $2 \times Z1$ in figure 120), if a SATA phy is attached and the interconnect is characterized with the low-loss TCTF test load (see 5.3.2.4)	mV(P-P)	275 ^a		N/A	
Jitter tolerance (see figure 121 in 5.3.5.5) ^{b c}	N/A	See table 74 in 5.3.7.6			
Half of maximum jitter (i.e., X1 in figure 120) ^d	UI	0.275			
Center of bit time (i.e., X2 in figure 120)	UI	0.50			
Maximum intra-pair skew ^e	ps	80	75	80	75
Maximum voltage (non-operational)	mV(P-P)	2 000			
<p>^a Amplitude measurement methodologies of SATA and this standard differ. Under conditions of maximum rise/fall time and jitter, eye diagram methodologies used in this standard may indicate less signal amplitude than the technique specified by SATA-2. Implementers of designs supporting SATA are required to ensure interoperability and should perform additional system characterization with an eye diagram methodology using SATA devices.</p> <p>^b The value for X1 applies at a total jitter probability of 10^{-12}. At this level of probability direct visual comparison between the mask and actual signals is not a valid method for determining compliance with the jitter requirements.</p> <p>^c SSC shall be enabled if supported by the receiver device. SSC shall not be enabled if the receiver device does not support SSC. The SSC type should be the same as that applied to the receiver device during normal operation. Multiple tests may be required depending on if the receiver device supports being attached to SATA or supports SSC. Jitter set up shall be performed prior to application of SSC.</p> <p>^d The value for X1 shall be half the value given for TJ in table 73. When SSC is disabled, the test or analysis shall include the effects of a single pole high-pass frequency-weighting function that progressively attenuates jitter at 20 dB/decade below a frequency of ($f_{baud} / 1\ 667$).</p> <p>^e The intra-pair skew measurement shall be made at the midpoint of the transition with a repeating 01b or 10b pattern (e.g., D10.2 or D21.5)(see table 235 in 10.2.9.2) on the physical link. The same stable trigger, coherent to the data stream, shall be used for both the Rx+ and Rx- signals. Intra-pair skew is defined as the time difference between the means of the midpoint crossing times of the Rx+ signal and the Rx- signal at the probe points.</p>					

5.3.7.4 Receiver device and delivered signal (receiver device signal tolerance) characteristics for 6 Gbps

5.3.7.4.1 Receiver device characteristics

Table 69 specifies the requirements of the signal delivered by the system with the zero-length test load (see 5.3.2.2), unless otherwise specified, attached at the receiver device compliance point (i.e., IR or CR) for 6

● Author: Isi-gpenokie
Subject: Highlight
Date: 5/6/2008 4:07:48 PM
T ACCEPT - DONE

<< set up >> should be << setup >>

● Author: Isi-gpenokie
Subject: Highlight
Date: 5/24/2008 12:45:28 PM

T REJECT (Alvin: Reject. From SAS 1.1 Rob: Starting a sentence with "Where" is grammatically incorrect. It's not better to combine this into the previous sentence due to length - it reads well as is)

This << signals. Intra-pair skew is defined as the time difference between the me >> should be << signals. Where intra-pair skew is the time difference between the me >>

Gbps. These **imply** the required signal tolerance characteristics of the receiver device. All specifications are based on differential measurements.

Table 69 — Receiver device delivered signal characteristics at IR and CR

Characteristic	Units	Minimum	Nominal	Maximum
Peak to peak voltage for 6 Gbps ^a	mV(P-P)			1 200
Maximum peak-to-peak voltage (i.e., 2 x Z2 in figure 120) for OOB, 1.5 Gbps, and 3 Gbps	mV(P-P)			1 600
Non-operational input voltage transient	mV(P-P)			2 000
Reference differential impedance ^b	ohm		100	
Reference common mode impedance ^b	ohm		25	

^a See 5.3.6.5.5 for measurement method.
^b For receiver device S-parameter characteristics, see 5.3.7.4.2.

5.3.7.4.2 Receiver device S-parameters

S-parameter limits shall be calculated per the following formula. Variables are illustrated in figure 124 (see 5.3.6.5.2) and specified in table 70.

$$\text{Measured value} < \max [L, \min [H, N + 13.3 \times \log_{10}(f / 3 \text{ GHz})]]$$

where:

- S** is the slope in dB/decade
- H** is the maximum value (i.e., the high frequency asymptote)
- N** is the value at the Nyquist frequency (i.e., 3 GHz)
- L** is the minimum value (i.e., the low frequency asymptote)

Table 70 defines the **S-parameters** of the receiver device.

Table 70 — S-parameters at the receiver device compliance point IR_s or CR_s

Characteristic	Reference	L (dBmV)	N (dBmV)	H (dB)	S (dBmV/decade)	f _{min} (MHz)	f _{max} (GHz)
S _{CC22}	Figure 128	-6.0	-5.0	0	13.3	100	6.0
S _{DD22}	Figure 128	-10	-7.9	0	13.3	100	6.0
S _{CD22}	Figure 130	-26	-12.7	-10	13.3	100	6.0

Page: 201

● Author: RElliott
Subject: Highlight
Date: 8/29/2008 10:57:21 AM
 ACCEPT - DONE (7/15 apply same change as previous section)

imply

● Author: stx-alvin-cox
Subject: Note
Date: 5/24/2008 12:47:12 PM
 ACCEPT - DONE (deleted "transient" but avoided introducing the parenthetical expression that would draw complaints)

Change from "Non-operational input voltage transient" to "Input voltage (non-operational)"

● Author: RElliott
Subject: Cross-Out
Date: 8/27/2008 2:43:55 PM
 ACCEPT - DONE

Delete
"S is the slope in dB/decade"

since it is not used in the equation

● Author: RElliott
Subject: Note
Date: 8/27/2008 2:51:44 PM
 ACCEPT - DONE

Add
f is the frequency of the signal in Hz

since it is used in the equation
(same wording as in Transmitter device S-parameters section)

● Author: RElliott
Subject: Highlight
Date: 8/27/2008 10:18:40 AM
 ACCEPT - DONE

S-parameters
s/b
Maximum limits for S-parameters

to match cable assembly/backplane wording

● Author: mxim-mbari
Subject: Note
Date: 5/24/2008 12:47:46 PM
 ACCEPT - DONE (should be "IR or CR")

Can not locate these compliance points, IRs or CRs, in any figures.

● Author: RElliott
Subject: Highlight
Date: 8/27/2008 10:18:52 AM
 ACCEPT - DONE

S-parameters
s/b

Comments from page 201 continued on next page

Gbps. These imply the required signal tolerance characteristics of the receiver device. All specifications are based on differential measurements.

Table 69 — Receiver device delivered signal characteristics at IR and CR

Characteristic	Units	Minimum	Nominal	Maximum
Peak to peak voltage for 6 Gbps ^a	mV(P-P)			1 200
Maximum peak-to-peak voltage (i.e., 2 x Z2 in figure 120) for OOB, 1.5 Gbps, and 3 Gbps	mV(P-P)			1 600
Non-operational input voltage transient	mV(P-P)			2 000
Reference differential impedance ^b	ohm		100	
Reference common mode impedance ^b	ohm		25	

^a See 5.3.6.5.5 for measurement method.
^b For receiver device S-parameter characteristics, see 5.3.7.4.2.

5.3.7.4.2 Receiver device S-parameters

S-parameter limits shall be calculated per the following formula. Variables are illustrated in figure 124 (see 5.3.6.5.2) and specified in table 70.

$$\text{Measured value} < \max [L, \min [H, N + 13.3 \times \log_{10}(f / 3 \text{ GHz})]]$$

where:

- S** is the slope in dB/decade
- H** is the maximum value (i.e., the high frequency asymptote)
- N** is the value at the Nyquist frequency (i.e., 3 GHz)
- L** is the minimum value (i.e., the low frequency asymptote)

Table 70 defines the S-parameters of the receiver device.

Table 70 — S-parameters at the receiver device compliance point IR_s or CR_s

Characteristic	Reference	L (dBmV)	N (dBmV)	H (dB)	S (dB.mV/decade)	f _{min} (MHz)	f _{max} (GHz)
S _{CC22}	Figure 128	-6.0	-5.0	0	13.3	100	6.0
S _{DD22}	Figure 128	-10	-7.9	0	13.3	100	6.0
S _{CD22}	Figure 130	-26	-12.7	-10	13.3	100	6.0

Maximum limits for S-parameters

to match cable assembly/backplane wording

● Author: mxim-mbari
Subject: Note
Date: 5/24/2008 12:48:07 PM

 ACCEPT - DONE

This table do not match the Figures. The Table should be for Scc11, Sdd11, and Scd11.

● Author: hpq-bolawsky
Subject: Note
Date: 5/6/2008 4:07:48 PM

 ACCEPT - DONE

All three dBmV references are inappropriate. Should be dB.

● Author: pmcs-gfortin
Subject: Highlight
Date: 5/24/2008 12:48:19 PM

 ACCEPT - DONE

11

● Author: mxim-mbari
Subject: Note
Date: 5/24/2008 12:49:15 PM

 REJECT (Alvin: Reject. Correct value.)

Wrong value [H = 0 dB for Sdd22 row]

● Author: pmcs-gfortin
Subject: Highlight
Date: 5/24/2008 12:48:24 PM

 ACCEPT - DONE

11

● Author: mxim-mbari
Subject: Note
Date: 5/6/2008 4:07:48 PM

 ACCEPT - DONE

Should be Figure 129

● Author: pmcs-gfortin
Subject: Highlight
Date: 5/24/2008 12:48:30 PM

 ACCEPT - DONE

11

● Author: pmcs-gfortin
Subject: Highlight
Date: 5/6/2008 4:07:48 PM

 ACCEPT - DONE

Should be 129

Figure 128 shows the receiver device S_{CC11} and S_{DD11} limits.

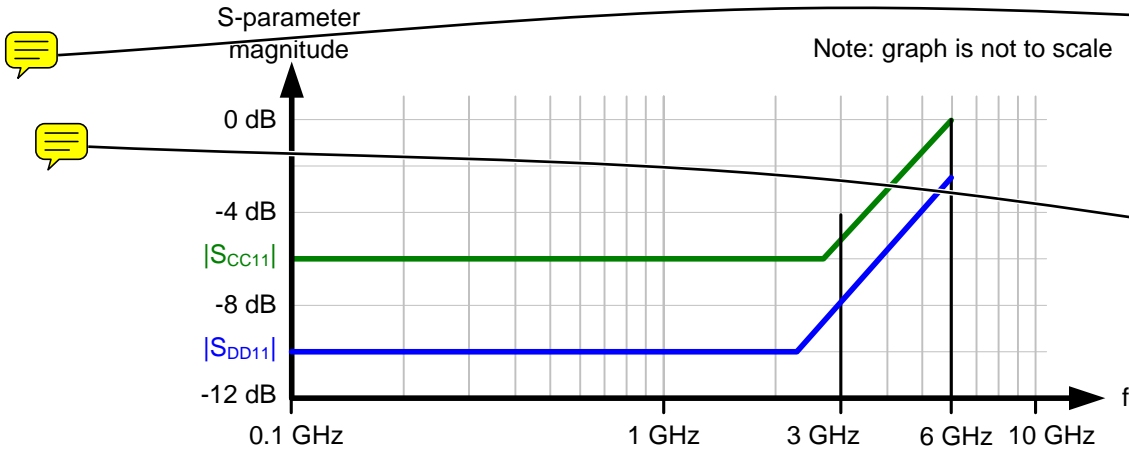

Figure 128 — Receiver device S_{CC11} and S_{DD11} limits

Figure 129 shows the receiver device S_{CD11} limits.

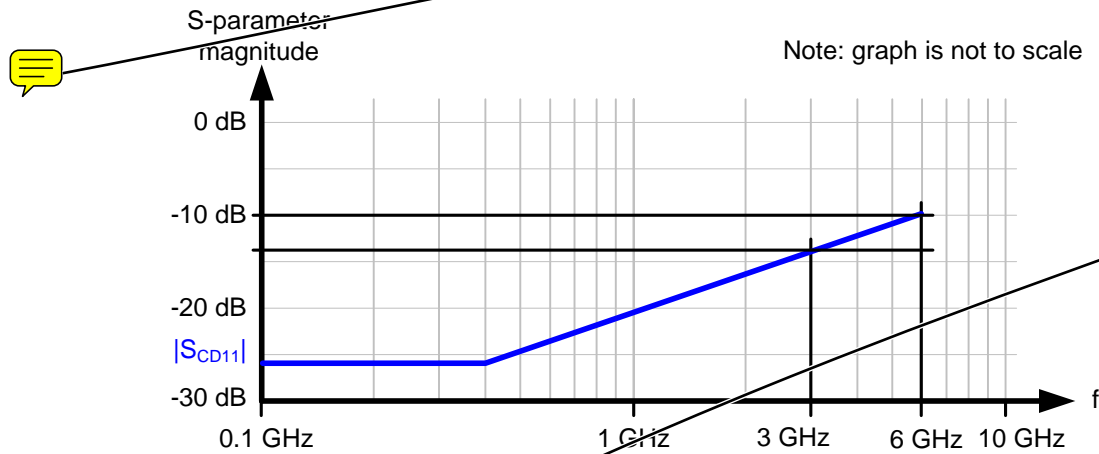



Figure 129 — Receiver device S_{CD11} limits

5.3.7.4.3 Reference receiver device

The reference receiver device is a set of parameters defining the electrical performance characteristics of a receiver device to be used in simulation to determine compliance of a transmitter device or TxRx connection.

NOTE 26 - An S-parameter model of the reference transmitter device and reference receiver device is available from <http://www.t10.org> as document number 07-267r0 titled "6G SAS Reference TX & RX Termination Networks." This model includes reference transmitter device (see 5.3.6.5.4) parameters and reference receiver device (see 5.3.7.4.3) parameters. 07-267r0.pdf describes how the models were created. 07-267r0.zip contains Touchstone® .s4p files containing the S-parameters. Touchstone® is a registered trademark of Agilent Corporation.

Editor's Note 4: SAS-2 should incorporate the figures/equations from 07-267r0 explaining how the models were created.

● Author: RElliott
Subject: Note
Date: 8/27/2008 4:16:34 PM
 ACCEPT - DONE

Move the note to the bottom of the figure

(from Ralph Weber, per ISO editing of SAS-1.1)

● Author: RElliott
Subject: Note
Date: 8/27/2008 4:16:45 PM
 ACCEPT - DONE

Merge figures 128/129

● Author: RElliott
Subject: Note
Date: 8/27/2008 4:16:27 PM
 REJECT (figure 126 merged into 125 instead)

Move the note to the bottom of the figure

(from Ralph Weber, per ISO editing of SAS-1.1)

● Author: stx-alvin-cox
Subject: Note
Date: 6/3/2008 9:33:07 AM
 ACCEPT - DONE (replaced by normative text)

Why is this a note rather than text included in the specification?

● Author: lsi-gpenokie
Subject: Highlight
Date: 6/3/2008 9:33:33 AM
 REJECT (there is nothing wrong with referencing a trademark. Replaced by normative text.)

This note is troubling for more than one reason. One is that it references a proposal. That is not going to fly at ISO and may be a problem at ANSI. I see two solutions- one would be to put it as an annex of this standard the other would be to create a technical report. The other problem is have a trademark. I don't have any good solution to that other than deleting it.

● Author: RElliott
Subject: Note
Date: 6/30/2008 6:16:52 PM
 ACCEPT - DONE

Replace note 26 with:

An S-parameter model of the reference receiver device is included with this standard. The following files are included:

- a) 07-267r0.pdf describes how the reference transmitter device and reference receiver device models were created; and
- b) 07-267r0.s4p contains a Touchstone® file containing the S-parameters for each model.

Touchstone® is a registered trademark of Agilent Corporation.

● Author: RElliott
Subject: Highlight
Date: 6/30/2008 6:16:52 PM
 REJECT (reference 07-267r0.pdf instead of incorporating the equations into the standard)

Editor's Note 4:

The reference receiver device includes a 3 tap decision feedback equalizer (DFE) with infinite precision taps and unit interval tap spacing. The reference coefficient adaptation algorithm is the least mean square (LMS) algorithm. The DFE equalizer can be modeled at the center of the eye as:

$$y_k = x_k - \sum_{i=1}^2 d_i \times x_{k-i}$$

The reference receiver assumes the coefficients (d_i) are positive and their magnitudes are less than 0.5.

NOTE 27 - For more information on DFE and LMS, see John R. Barry, Edward A. Lee, and David G. Messerschmitt. *Digital Communication - Third Edition*. Kluwer Academic Publishing, 2003. See <http://users.ece.gatech.edu/~barry/digital>.

Figure 130 shows a reference receiver device.

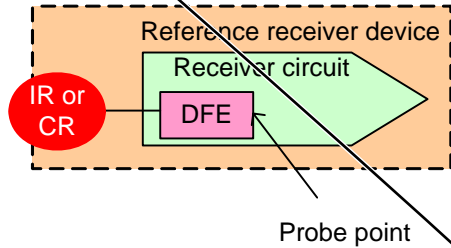

Figure 130 — Reference receiver device

5.3.7.4.4 Receiver device physical testing

5.3.7.4.4.1 Receiver device physical testing overview

A receiver device shall satisfy the stressed receiver sensitivity test described in this subclause. The receiver device under test must demonstrate a BER that is less than 10^{-12} with a confidence level of 95 %. The BER is computed on the raw bit stream before 8b10b decoding.

Table 71 defines the number of bits that shall be transmitted with a certain number of errors to have a confidence level of 95 % that the BER is less than 10^{-12} .

Table 71 — Number of bits received per number of errors for BER confidence level of 95 %

Number of errors	Number of bits
0	3.00×10^{12}
1	4.74×10^{12}
2	6.30×10^{12}
3	7.75×10^{12}
4	9.15×10^{12}
5	1.05×10^{13}

The stressed receiver sensitivity test shall be applied at the receiver device compliance point (IR or CR) as a means to perform physical validation of predicted performance of the receiver device. Any implementation of the stressed signal generation hardware is permitted for the stressed receiver signal as long as it provides the ISI-stressed signal with jitter and noise as defined in this subclause.

Author: wdc-mevans
Subject: Highlight
Date: 5/24/2008 12:49:47 PM
ACCEPT - DONE (as "may be")

can be
s/b
is

Author: RElliott
Subject: Highlight
Date: 6/30/2008 6:16:52 PM
ACCEPT - DONE

DFE equalizer
s/b
DFE

since E already means equalizer

Author: lsi-gpenokie
Subject: Rectangle
Date: 6/25/2008 1:03:20 PM
ACCEPT - DONE (we don't center equations; they are left-justified to one tab stop. Redrew in medium size. Added where: list. Per Alvin, here are the definitions for the "where" statement:

y equalizer differential output voltage
x equalizer differential input voltage
d equalizer feedback coefficient
k sample index in UI
sign of y_{k-1}
)

This equation should be centered on the page and it looks like it is not used the default fonts for equations. And where is the <<Where >> that tells the reader what y, x, d, and k are>

Author: RElliott
Subject: Note
Date: 6/30/2008 6:16:52 PM
ACCEPT - DONE (using "sgn". Added sgn(), which is the preferred function name according to wikipedia. Added "sgn = singum (i.e., sign)" to the acronyms list.)

equation should include sign (x (k-i))
not just x (k-i)

Author: mxim-kwitt
Subject: Replacement Text
Date: 5/6/2008 4:07:48 PM
ACCEPT - DONE
 $\sqrt{2}$ s/b 3

Author: lsi-gpenokie
Subject: Highlight
Date: 5/24/2008 1:00:11 PM
ACCEPT - DONE ("shall have")

This << The receiver device under test must demonstrate a BER that >> shall be << The receiver device under test shall meet a BER that >>

Author: lsi-gpenokie
Subject: Highlight

The reference receiver device includes a 3 tap decision feedback equalizer (DFE) with infinite precision taps and unit interval tap spacing. The reference coefficient adaptation algorithm is the least mean square (LMS) algorithm. The DFE equalizer can be modeled at the center of the eye as:

$$y_k = x_k - \sum_{i=1}^2 d_i \times x_{k-i}$$



The reference receiver assumes the coefficients (d_i) are positive and their magnitudes are less than 0.5.

NOTE 27 - For more information on DFE and LMS, see John R. Barry, Edward A. Lee, and David G. Messerschmitt. *Digital Communication - Third Edition*. Kluwer Academic Publishing, 2003. See <http://users.ece.gatech.edu/~barry/digital>.

Figure 130 shows a reference receiver device.

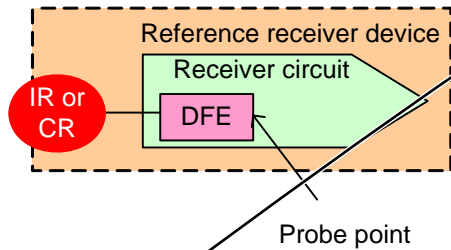

Figure 130 — Reference receiver device

5.3.7.4.4 Receiver device physical testing

5.3.7.4.4.1 Receiver device physical testing overview

A receiver device shall satisfy the stressed receiver sensitivity test described in this subclause. The receiver device under test must demonstrate a BER that is less than 10^{-12} with a confidence level of 95 %. The BER is computed on the raw bit stream before 8b10b decoding.

Table 71 defines the number of bits that shall be transmitted with a certain number of errors to have a confidence level of 95 % that the BER is less than 10^{-12} .

Table 71 — Number of bits received per number of errors for BER confidence level of 95 %

Number of errors	Number of bits
0	3.00×10^{12}
1	4.74×10^{12}
2	6.30×10^{12}
3	7.75×10^{12}
4	9.15×10^{12}
5	1.05×10^{13}

The stressed receiver sensitivity test shall be applied at the receiver device compliance point (IR or CR) as a means to perform physical validation of predicted performance of the receiver device. Any implementation of the stressed signal generation hardware is permitted for the stressed receiver signal as long as it provides the ISI-stressed signal with jitter and noise as defined in this subclause.

Date: 5/24/2008 12:59:40 PM

T ACCEPT - DONE

This << A receiver device shall satisfy the stressed receiver sensitivity test >> should be << A receiver device shall pass the stressed receiver sensitivity test >>

Author: wdc-mevans

Subject: Highlight

Date: 5/24/2008 1:00:24 PM

T ACCEPT - DONE

must

s/b

shall

Author: lsi-gpenokie

Subject: Highlight

Date: 5/26/2008 8:19:10 PM

T ACCEPT - DONE (also added "receiver device" before the parenthesis where missing)

Global

All the << (IR or CR) >> in this section need to be changed to << (i.e., IR or CR) >>.

Author: RElliott

Subject: Highlight

Date: 9/4/2008 11:23:42 AM

T ACCEPT - DONE

(global)

stressed receiver sensitivity

s/b

stressed receiver device sensitivity

to not disagree with B.2.3, which says "receiver sensitivity" is not used in this standard

Figure 131 shows the block diagram of the stressed receiver sensitivity test.

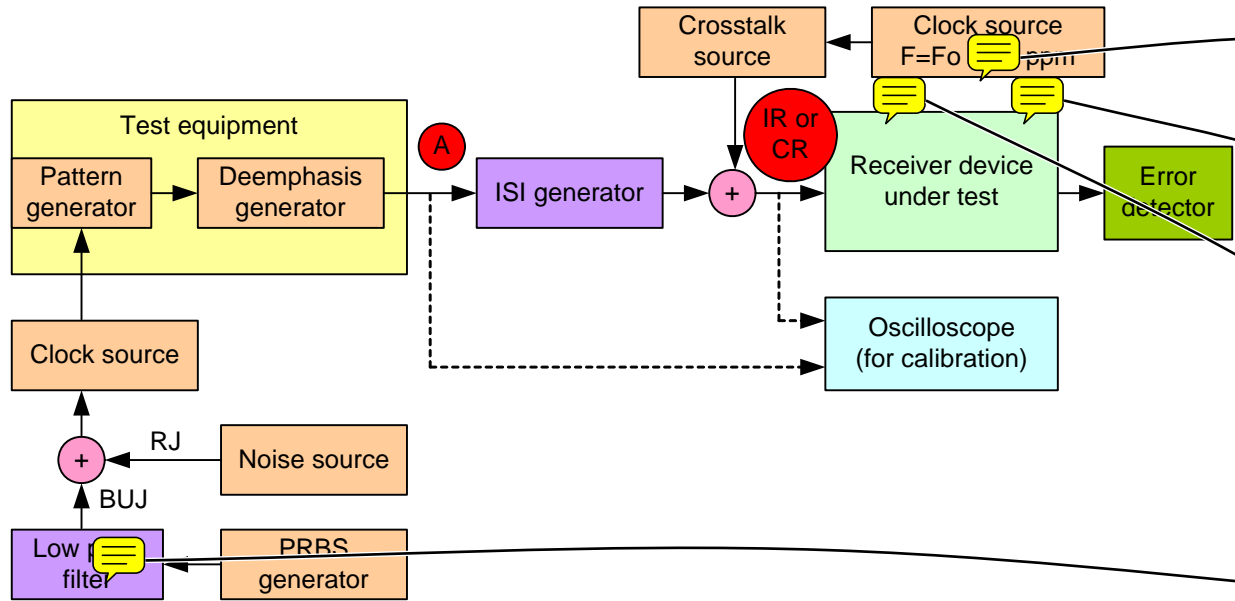

Figure 131 — Stressed receiver sensitivity test block diagram

The receiver device under test demonstrates its ability to compensate for channel intersymbol interference (ISI) representative of the SAS-2 reference channel while subjected to the budgeted jitter and cross talk sources.

Table 72 defines the characteristics of the signal at point A in figure 131.

Table 72 — Stressed receiver sensitivity test characteristics

Characteristic	Units	Minimum	Typical	Maximum	Reference
Tx data pattern		CJTPAT			Annex A
Tx peak to peak voltage	mV(P-P)			800	5.3.6.5.1
Tx minimum rise/fall time	UI	0.24 (41.6 ps)			5.3.6.5.1
Transmitter equalization	dB			2	5.3.6.5.5
Tx RJ	UI	0.15 (25 ps)			5.3.6.5.1
Tx bounded uncorrelated jitter	UI	0.000 22 (0.036 ps)			
Link dispersion penalty ^{a b}	dB	13			5.3.7.4.4.8
D24.3 delivered eye opening (Z1) ^b	mV	75		95	5.3.5.4
D24.3 delivered eye opening (X1)^b	UI	0.15			5.3.5.4
NEXT offset frequency ^b	ppm	20			
Total crosstalk amplitude ^{b c}	mV _{rms}	4			

^a Link dispersion penalty is the WDP of the delivered signal computed with Palloc = 15.4 dB.

^b This specification pertains to the delivered signal at IR or CR during the receiver device compliance test. All adjacent phys in the receiver device shall be active with representative traffic with their maximum amplitude and maximum frequency of operation. Additional pseudo-random crosstalk shall be added, if needed, to meet the total crosstalk amplitude specification.

^c Observed with a histogram of at least 1 000 hits.

Page: 204

● Author: mxim-kwitt
Subject: Note
Date: 9/4/2008 2:51:32 PM
 REFER PHYSICAL WG

s/b just Clock source see 08-144r1 page 8

● Author: hpq-relliott
Subject: Note
Date: 9/4/2008 2:51:35 PM
 REFER PHYSICAL WG

Fo is not defined

● Author: hpq-relliott
Subject: Note
Date: 9/4/2008 2:51:43 PM
 REFER PHYSICAL WG

20 ppm is just the minimum, so the equation is not always correct. Reference the "NEXT offset frequency" variable below.

● Author: mxim-kwitt
Subject: Note
Date: 9/4/2008 2:51:46 PM
 REFER PHYSICAL WG

modify per 08-144r1 to BUJ source

● Author: pmcs-gfortin
Subject: Highlight
Date: 9/4/2008 2:51:49 PM
 REFER PHYSICAL WG

The SSC modulation source should be added.

● Author: hpq-relliott
Subject: Note
Date: 9/4/2008 2:51:53 PM
 REFER PHYSICAL WG

Add a list right after the figure describing what each of the blocks are. In particular, a link describing the ISI generator is needed. (suggested by Mike Jenkins in March WG)

● Author: RElliott
Subject: Highlight
Date: 6/30/2008 6:16:52 PM
 ACCEPT - DONE

cross talk
s/b
crosstalk

● Author: lsi-gpenokie
Subject: Highlight
Date: 9/4/2008 2:52:06 PM
 REFER PHYSICAL WG

This << representative of the SAS-2 reference channel while subjected to the budgeted >> should be << representative of the reference channel defined in this standard for 6 Gbps channels while subjected to the budgeted >>

● Author: pmcs-gfortin
Subject: Highlight

Comments from page 204 continued on next page

Figure 131 shows the block diagram of the stressed receiver sensitivity test.

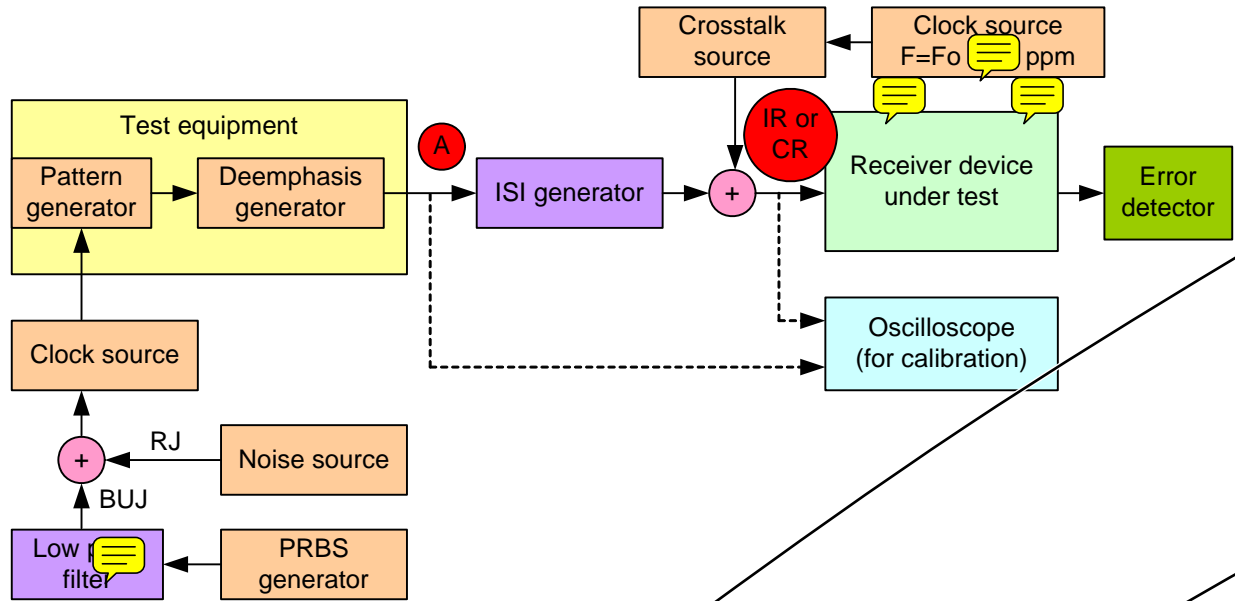

Figure 131 — Stressed receiver sensitivity test block diagram

The receiver device under test demonstrates its ability to compensate for channel intersymbol interference (ISI) representative of the SAS-2 reference channel while subjected to the budgeted jitter and cross talk sources.

Table 72 defines the characteristics of the signal at point A in figure 131.

Table 72 — Stressed receiver sensitivity test characteristics

Characteristic	Units	Minimum	Typical	Maximum	Reference
Tx data pattern		CJTPAT			Annex A
Tx peak to peak voltage	mV(P-P)			800	5.3.6.5.1
Tx minimum rise/fall time	UI	0.24 (41.6 ps)			5.3.6.5.1
Transmitter equalization	dB			2	5.3.6.5.5
Tx RJ	UI	0.15 (25 ps)			5.3.6.5.1
Tx bounded uncorrelated jitter	UI	0.030-0.22 (0.036 ps)			
Link dispersion penalty ^{a b}	dB	13			5.3.7.4.4.8
D24.3 delivered eye opening (Z1) ^b	mV	75		95	5.3.5.4
D24.3 delivered eye opening (X1)^b	UI	0.15			5.3.5.4
NEXT offset frequency ^b	ppm	20			
Total crosstalk amplitude ^{b c}	mV _{rms}	4			

^a Link dispersion penalty is the WDP of the delivered signal computed with Palloc = 15.4 dB.
^b This specification pertains to the delivered signal at IR or CR during the receiver device compliance test. All adjacent phys in the receiver device shall be active with representative traffic with their maximum amplitude and maximum frequency of operation. Additional pseudo-random crosstalk shall be added, if needed, to meet the total crosstalk amplitude specification.
^c Observed with a histogram of at least 1 000 hits.

Date: 9/4/2008 2:52:11 PM
 REFER PHYSICAL WG

It is proposed to add: "If the receiver device under test includes a CJTPAT or disparity errors checker, it is recommended to perform this test with a triangular SSC modulation."

Author: RElliott
Subject: Note
Date: 9/3/2008 6:33:20 PM
 ACCEPT - DONE

reference channel
s/b
reference transmitter test load (se 5.3.2.5)

(from George Penokie, LSI)

Author: Isi-jenkins
Subject: Highlight
Date: 9/4/2008 2:52:14 PM
 REFER PHYSICAL WG

The last 5 lines in table 72 have nothing to do with point A. Change "A" to "IR or CR".

Author: pmcs-gfortin
Subject: Highlight
Date: 9/4/2008 2:52:18 PM
 REFER PHYSICAL WG

Several objections to the table 72, which are addressed by Kevin Witt in proposal 08-144r1

Author: pmcs-gfortin
Subject: Highlight
Date: 9/4/2008 2:52:23 PM
 REFER PHYSICAL WG

Add
"SSC modulation frequency" units="kHz" min=30, max=33
"SSC modulation amplitude" units="ppm" typ=2200-2300, note f
"SSC modulation profile" typ=triangular

Author: mxim-kwitt
Subject: Cross-Out
Date: 5/6/2008 4:07:48 PM

Author: Isi-jenkins
Subject: Highlight
Date: 9/4/2008 2:52:32 PM
 REFER PHYSICAL WG

Change 800(max) to 830(min), 850(typ), 870(max). All these values need to be bounded above & below.

ref 08-144r1 & 08-146r1.

Author: mxim-kwitt
Subject: Note
Date: 9/4/2008 2:52:35 PM
 REFER PHYSICAL WG

825-875

Author: mxim-kwitt
Subject: Inserted Text

Figure 131 shows the block diagram of the stressed receiver sensitivity test.

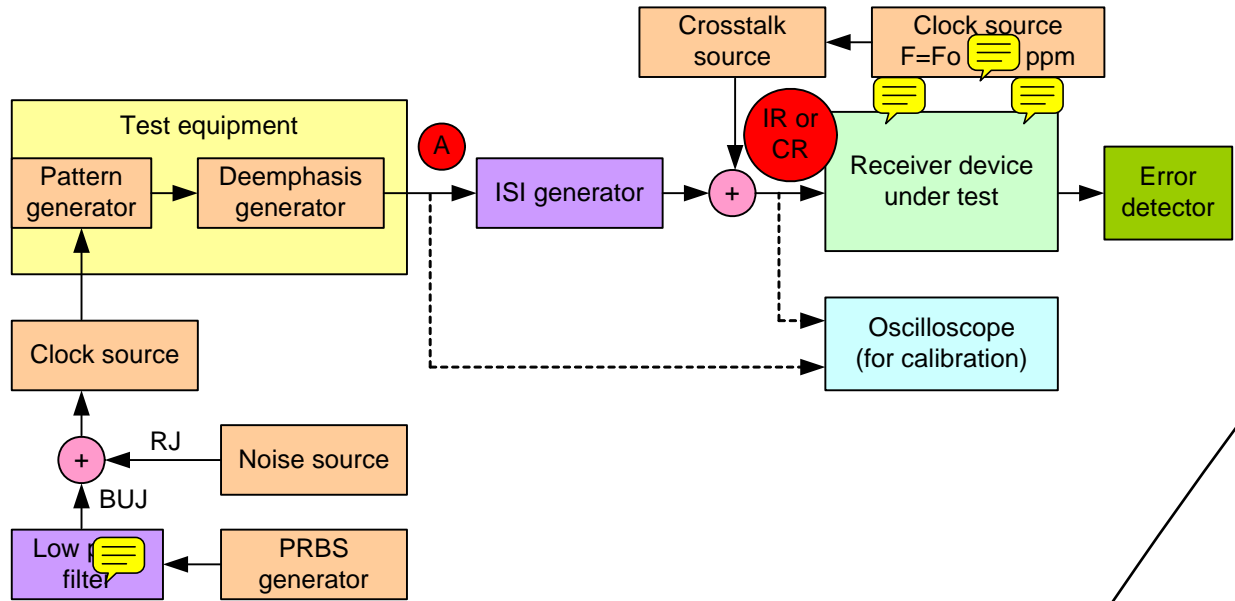

Figure 131 — Stressed receiver sensitivity test block diagram

The receiver device under test demonstrates its ability to compensate for channel intersymbol interference (ISI) representative of the SAS-2 reference channel while subjected to the budgeted jitter and cross talk sources.

Table 72 defines the characteristics of the signal at point A in figure 131.

Table 72 — Stressed receiver sensitivity test characteristics

Characteristic	Units	Minimum	Typical	Maximum	Reference
Tx data pattern		CJTPAT			Annex A
Tx peak to peak voltage	mV(P-P)			800	5.3.6.5.1
Tx minimum rise/fall time	UI	0.24 (41.6 ps)			5.3.6.5.1
Transmitter equalization	dB			2	5.3.6.5.5
Tx RJ	UI	0.15 (25 ps)			5.3.6.5.1
Tx bounded uncorrelated jitter	UI	0.000 22 (0.036 ps)			
Link dispersion penalty ^{a b}	dB	13			5.3.7.4.4.8
D24.3 delivered eye opening (Z1) ^b	mV	75		95	5.3.5.4
D24.3 delivered eye opening (X1)^b	UI	0.15			5.3.5.4
NEXT offset frequency ^b	ppm	20			
Total crosstalk amplitude ^{b c}	mV _{rms}	4			

^a Link dispersion penalty is the WDP of the delivered signal computed with Palloc = 15.4 dB.
^b This specification pertains to the delivered signal at IR or CR during the receiver device compliance test. All adjacent phys in the receiver device shall be active with representative traffic with their maximum amplitude and maximum frequency of operation. Additional pseudo-random crosstalk shall be added, if needed, to meet the total crosstalk amplitude specification.
^c Observed with a histogram of at least 1 000 hits.

Date: 9/4/2008 2:52:41 PM

 REFER PHYSICAL WG

f

Author: mxim-kwitt
Subject: Cross-Out
Date: 9/4/2008 2:53:02 PM
 REFER PHYSICAL WG

Delete 0.24

Author: mxim-kwitt
Subject: Note
Date: 9/4/2008 2:52:43 PM
 REFER PHYSICAL WG

0.24 (41.6ps)

Author: mxim-kwitt
Subject: Replacement Text
Date: 9/4/2008 2:53:07 PM
 REFER PHYSICAL WG

1.7-2.3

Author: mxim-kwitt
Subject: Inserted Text
Date: 9/4/2008 2:53:09 PM
 REFER PHYSICAL WG

f

Author: intc-mseidel
Subject: Highlight
Date: 9/4/2008 2:53:17 PM
 REFER PHYSICAL WG

It would be better to relax the RJ number of 0.15UI, since this number is on the edge for today's leading-edge process technologies. Future technologies (implementing SAS-2 as legacy) will have increasing difficulty to meet this RJ number. Past versions of this and other phy standards have specified TJ and DJ; going to RJ and TJ in this standard makes the game a little different looking ahead. 0.18 or 0.20 UI would be better.

Author: Isi-jenkins
Subject: Highlight
Date: 9/4/2008 2:53:12 PM
 REFER PHYSICAL WG

Change to 0.135(min), 0.150(typ), 0.165(max)

Author: mxim-kwitt
Subject: Replacement Text
Date: 9/4/2008 2:53:33 PM
 REFER PHYSICAL WG

26 s/b 26.6

Author: Isi-jenkins
Subject: Highlight
Date: 9/4/2008 2:53:36 PM
 REFER PHYSICAL WG

Author: Isi-jenkins
Subject: Highlight

Comments from page 204 continued on next page

Figure 131 shows the block diagram of the stressed receiver sensitivity test.

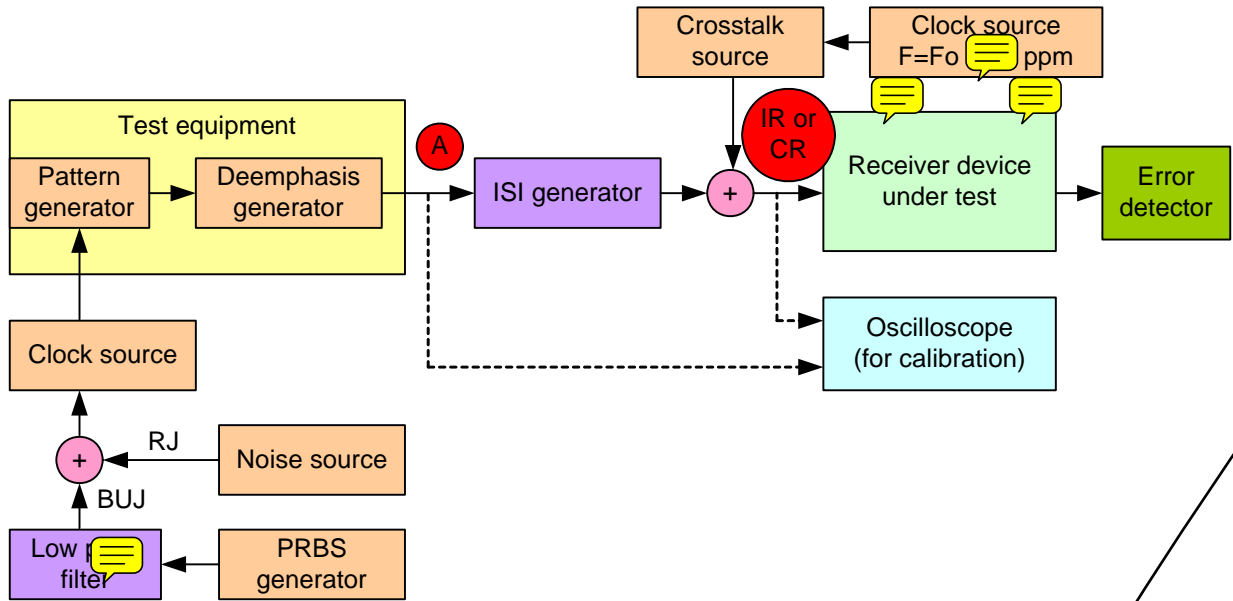

Figure 131 — Stressed receiver sensitivity test block diagram

The receiver device under test demonstrates its ability to compensate for channel intersymbol interference (ISI) representative of the SAS-2 reference channel while subjected to the budgeted jitter and cross talk sources.

Table 72 defines the characteristics of the signal at point A in figure 131.

Table 72 — Stressed receiver sensitivity test characteristics

Characteristic	Units	Minimum	Typical	Maximum	Reference
Tx data pattern		CJTPAT			Annex A
Tx peak to peak voltage	mV(P-P)			800	5.3.6.5.1
Tx minimum rise/fall time	UI	0.24 (41.6 ps)			5.3.6.5.1
Transmitter equalization	dB			2	5.3.6.5.5
Tx RJ	UI	0.15 (25 ps)			5.3.6.5.1
Tx bounded uncorrelated jitter	UI	0.000 22 (0.036 ps)			
Link dispersion penalty	dB	13			5.3.7.4.4.8
D24.3 delivered eye opening (Z1)	mV	75		95	5.3.5.4
D24.3 delivered eye opening (X1)	UI	0.15			5.3.5.4
NEXT offset frequency	ppm	20			
Total crosstalk amplitude	mV _{rms}	4			

^a Link dispersion penalty is the WDP of the delivered signal computed with Palloc = 15.4 dB.

^b This specification pertains to the delivered signal at IR or CR during the receiver device compliance test. All adjacent phys in the receiver device shall be active with representative traffic with their maximum amplitude and maximum frequency of operation. Additional pseudo-random crosstalk shall be added, if needed, to meet the total crosstalk amplitude specification.

^c Observed with a histogram of at least 1 000 hits.

Date: 9/4/2008 2:53:38 PM
REFER PHYSICAL WG

Author: intc-mseidel
Subject: Highlight
Date: 9/4/2008 2:53:42 PM
REFER PHYSICAL WG

The Tx bounded uncorrelated jitter number is extremely small, and should be increased at least two orders of magnitude. Also, "BUJ" should be indicated here, and a definition should be added.

Author: mxim-kwitt
Subject: Replacement Text
Date: 9/4/2008 2:53:48 PM
REFER PHYSICAL WG
0.1

Author: lsi-jenkins
Subject: Highlight
Date: 9/4/2008 2:53:51 PM
REFER PHYSICAL WG

Change to 0.09(min), 0.10(typ), 0.11(max)

ref 08-144r1 & 08-146r1

Author: mxim-kwitt
Subject: Replacement Text
Date: 9/4/2008 2:53:54 PM
REFER PHYSICAL WG
16.6

Author: intc-mseidel
Subject: Highlight
Date: 9/4/2008 2:53:58 PM
REFER PHYSICAL WG

All references here and elsewhere to Link Dispersion Penalty (LDP) and WDP must either be defined and explained, migrated into another already-explained concept, or removed.

Author: mxim-kwitt
Subject: Cross-Out
Date: 9/4/2008 2:54:00 PM
REFER PHYSICAL WG

Author: mxim-kwitt
Subject: Cross-Out
Date: 9/4/2008 2:54:05 PM
REFER PHYSICAL WG

Author: mxim-kwitt
Subject: Cross-Out
Date: 9/4/2008 2:54:07 PM
REFER PHYSICAL WG

Author: mxim-kwitt

Figure 131 shows the block diagram of the stressed receiver sensitivity test.

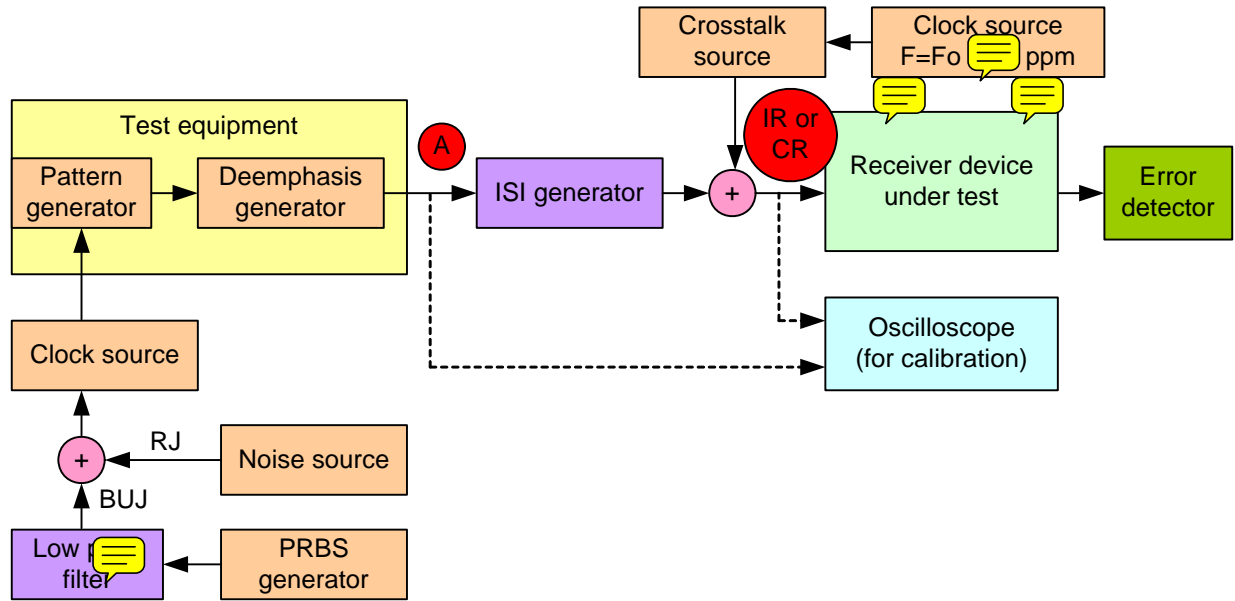

Figure 131 — Stressed receiver sensitivity test block diagram

The receiver device under test demonstrates its ability to compensate for channel intersymbol interference (ISI) representative of the SAS-2 reference channel while subjected to the budgeted jitter and cross talk sources.

Table 72 defines the characteristics of the signal at point A in figure 131.

Table 72 — Stressed receiver sensitivity test characteristics

Characteristic	Units	Minimum	Typical	Maximum	Reference
Tx data pattern		CJTPAT			Annex A
Tx peak to peak voltage	mV(P-P)			800	5.3.6.5.1
Tx minimum rise/fall time	UI	0.24 (41.6 ps)			5.3.6.5.1
Transmitter equalization	dB			2	5.3.6.5.5
Tx RJ	UI	0.15 (25 ps)			5.3.6.5.1
Tx bounded uncorrelated jitter	UI	0.000 22 (0.036 ps)			
Link dispersion penalty ^{a b}	dB	13			5.3.7.4.4.8
D24.3 delivered eye opening (Z1) ^b	mV	75		95	5.3.5.4
D24.3 delivered eye opening (X1)^b	UI	0.15			5.3.5.4
NEXT offset frequency ^b	ppm	20			
Total crosstalk amplitude ^{b c}	mV _{rms}	4			

^a Link dispersion penalty is the WDP of the delivered signal computed with Palloc = 15.4 dB.

^b This specification pertains to the delivered signal at IR or CR during the receiver device compliance test. All adjacent phys in the receiver device shall be active with representative traffic with their maximum amplitude and maximum frequency of operation. Additional pseudo-random crosstalk shall be added, if needed, to meet the total crosstalk amplitude specification.

^c Observed with a histogram of at least 1 000 hits.

Subject: Cross-Out
Date: 9/4/2008 2:54:10 PM
 REFER PHYSICAL WG

● Author: Isi-jenkins
Subject: Highlight
Date: 9/4/2008 2:54:14 PM
 REFER PHYSICAL WG

Change to 100(min), 107(typ), 115(max) and add note to measure at center of vertical histogram at crossing point.

ref 08-144r1 & 08-146r1

● Author: Isi-jenkins
Subject: Highlight
Date: 9/4/2008 2:54:16 PM
 REFER PHYSICAL WG

● Author: mxim-kwitt
Subject: Note
Date: 9/4/2008 2:54:20 PM
 REFER PHYSICAL WG

200-230

● Author: mxim-kwitt
Subject: Inserted Text
Date: 9/4/2008 2:54:23 PM
 REFER PHYSICAL WG

(c,e,f)

● Author: mxim-kwitt
Subject: Cross-Out
Date: 9/4/2008 2:54:31 PM
 REFER PHYSICAL WG

● Author: mxim-kwitt
Subject: Inserted Text
Date: 9/4/2008 2:54:34 PM
 REFER PHYSICAL WG

d

● Author: mxim-kwitt
Subject: Replacement Text
Date: 9/4/2008 2:54:41 PM
 REFER PHYSICAL WG

2500

● Author: Isi-gpenokie
Subject: Highlight
Date: 9/4/2008 2:54:45 PM
 REFER PHYSICAL WG

This term << Palloc >> is used no were else in the standard what the heck is it? Define it or delete it.

● Author: Isi-gpenokie
Subject: Highlight

Comments from page 204 continued on next page

Figure 131 shows the block diagram of the stressed receiver sensitivity test.

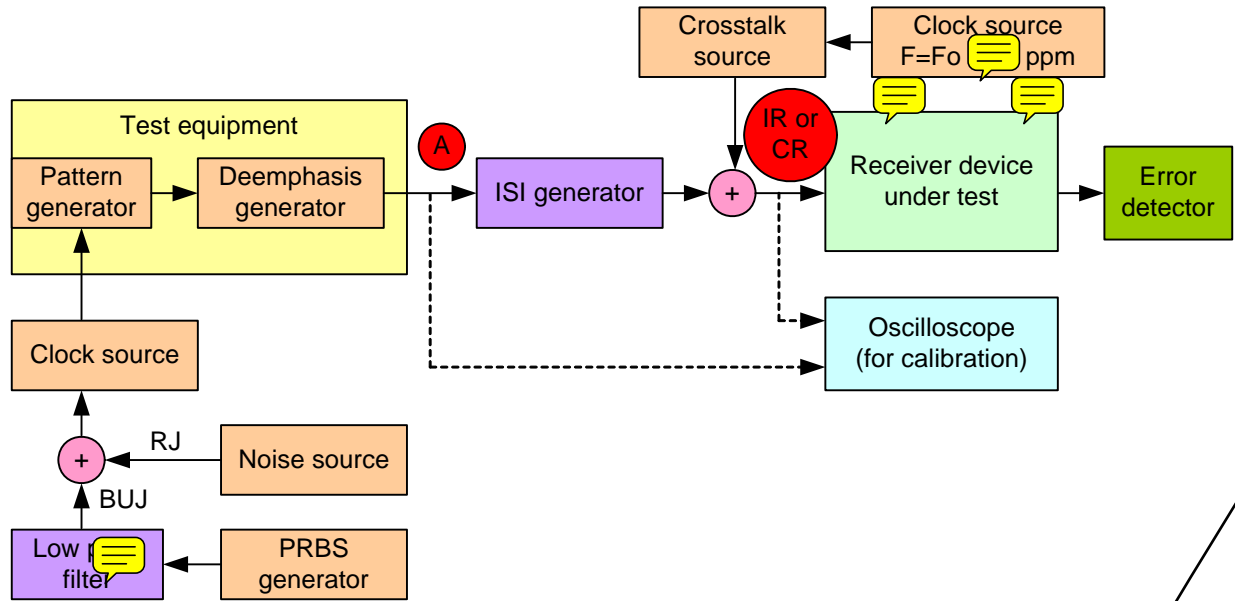

Figure 131 — Stressed receiver sensitivity test block diagram

The receiver device under test demonstrates its ability to compensate for channel intersymbol interference (ISI) representative of the SAS-2 reference channel while subjected to the budgeted jitter and cross talk sources.

Table 72 defines the characteristics of the signal at point A in figure 131.

Table 72 — Stressed receiver sensitivity test characteristics

Characteristic	Units	Minimum	Typical	Maximum	Reference
Tx data pattern		CJTPAT			Annex A
Tx peak to peak voltage	mV(P-P)			800	5.3.6.5.1
Tx minimum rise/fall time	UI	0.24 (41.6 ps)			5.3.6.5.1
Transmitter equalization	dB			2	5.3.6.5.5
Tx RJ	UI	0.15 (25 ps)			5.3.6.5.1
Tx bounded uncorrelated jitter	UI	0.000 22 (0.036 ps)			
Link dispersion penalty ^{a b}	dB	13			5.3.7.4.4.8
D24.3 delivered eye opening (Z1) ^b	mV	75		95	5.3.5.4
D24.3 delivered eye opening (X1)^b	UI	0.15			5.3.5.4
NEXT offset frequency ^b	ppm	2			
Total crosstalk amplitude ^{b c}	mV _{rms}	4			

^a Link dispersion penalty is the WDP of the delivered signal computed with Palloc = 15.4 dB.

^b This specification pertains to the delivered signal at IR or CR during the receiver device compliance test. All adjacent phys in the receiver device shall be active with representative traffic with their maximum amplitude and maximum frequency of operation. Additional pseudo-random crosstalk shall be added, if needed, to meet the total crosstalk amplitude specification.

^c Observed with a histogram of at least 1 000 hits.

Date: 9/4/2008 2:54:48 PM
REFER PHYSICAL WG

This term << WDP >> is used no were else in the standard what the heck is it? Define it or delete it.

Author: lsi-gpenokie
Subject: Highlight
Date: 9/4/2008 2:54:51 PM
REFER PHYSICAL WG

This << This specification pertains to the delivered signal >> should be << This standard pertains to the delivered signal >>

Author: pmcs-gfortin
Subject: Highlight
Date: 9/4/2008 2:54:55 PM
REFER PHYSICAL WG

It is proposed to clarify note 'b' to highlight that activity must be present on both receive and transmit phys:

"This specification pertains to the delivered signal at IR or CR during the receiver device compliance test. All adjacent receive and transmit phys in the receiver device shall be active with representative traffic with their maximum amplitude and maximum frequency of operation. Additional pseudo-random crosstalk shall be added, if needed, to meet the total crosstalk amplitude specification."

Author: lsi-gpenokie
Subject: Highlight
Date: 9/4/2008 2:54:59 PM
REFER PHYSICAL WG

<< least 1 000 hits. >> of what? Snowballs, baseballs, rocks?

Author: mxim-kwitt
Subject: Inserted Text
Date: 9/4/2008 2:55:02 PM
REFER PHYSICAL WG

Add:

d An SSC modulated source can be used instead of fixed offset frequency crosstalk.

e Based on the centroid of the vertical histogram at 1 and 0 crossing
see Figure xxx

f Test setup is to be within this range and it is not required to show
compliance across the range.

5.3.7.4.4.2 Test signal characteristics and calibration

5.3.7.4.4.3 Transmit waveform calibration

Test equipment shall be used to establish the transmit launch signal at point A in figure 131 to meet the characteristics defined in table 72.

5.3.7.4.4.4 ISI generator calibration

The hardware ISI generator shall deliver a stressed signal to the receiver device under test that is representative of and at least as stressful as the reference transmitter test load (see 5.3.2.5). The measure of stress is:

- a) the computed link dispersion penalty (LDP); and
- b) $|S_{DD21}|$ at $(f_{baud} / 2)$.

With the transmitter jitter and crosstalk sources disabled, the delivered waveform shall be captured at the compliance point (IR or CR) and processed to determine the LDP. Waveform averaging shall be used to minimize the impact of measurement noise and jitter on the LDP calculations.

$|S_{DD21}|$ delivered by the hardware ISI generator shall be measured by observing the delivered eye opening at the compliance point (IR or CR) per the specification in table 72.

NOTE 28 - The reference transmitter test load (see 5.3.2.5) may be used as an ISI generator. It has a nominal $|S_{DD21}|$ requirement of -15 dB at $(f_{baud} / 2)$.

5.3.7.4.4.5 ISI generator pulse response

The captured waveform shall be processed as described in section 5.3.7.4.4.6 to determine the LDP. An ISI generator suitable for this test shall have a LDP greater than that budgeted and an $|S_{DD21}|$ comparable to that of the reference transmitter test load.

5.3.7.4.4.6 Crosstalk calibration

A coupling mechanism is used to inject representative crosstalk to the receiver device under test at the compliance point (IR or CR). The center frequency of the crosstalk source shall be frequency offset from the pattern generator to sweep all potential relative phase alignments between the crosstalk source and the signal from the ISI generator. With the transmit signal disabled, a histogram of the signal delivered to the receiver under test shall be generated. The crosstalk amplitude shall be at greater than the total crosstalk amplitude specified in table 72.

5.3.7.4.4.7 Jitter tolerance

A receiver device shall satisfy the jitter tolerance test described in this subclause. The jitter tolerance test leverages the receiver device physical test hardware. The receiver device under test shall demonstrate a BER that is less than 10^{-12} with a 95 % confidence level when subjected to the sinusoidal jitter defined in 5.3.7.6.

Page: 205

● Author: lsi-gpenokie
Subject: Highlight
Date: 5/6/2008 4:07:48 PM

T ACCEPT - DONE
<< he >> should be <<the>>.

● Author: pmcs-gfortin
Subject: Highlight
Date: 9/4/2008 2:55:11 PM

T REFER PHYSICAL WG

For inclusion of SSC in the test procedure, we should add:

"If the receiver device is tested with an SSC modulated signal, the residual SSC jitter shall be accounted for when calibrating the transmit signal BUJ. The transmit BUJ shall be measured through the JTF using a D30.3 pattern, with +/- 2300 ppm triangular SSC modulating the pattern generator clock source."

● Author: lsi-gpenokie
Subject: Highlight
Date: 9/4/2008 2:55:14 PM

T REFER PHYSICAL WG

This << representative of and at least as stressful as the reference >> should be << representative of, and at least as stressful as, the reference >>

● Author: lsi-gpenokie
Subject: Cross-Out
Date: 7/15/2008 8:01:33 PM

T REJECT (noise and jitter are not part of calculations. Noise and jitter have impact on calculations.)

This << impact of >> should be deleted as it adds nothing.

● Author: lsi-gpenokie
Subject: Highlight
Date: 9/4/2008 2:55:19 PM

T REFER PHYSICAL WG

This << point (IR or CR) per the specification in table 72. >> should be << point (IR or CR) as defined in table 72. >>

● Author: mxim-kwitt
Subject: Note
Date: 9/4/2008 2:55:22 PM

 REFER PHYSICAL WG

Insert figure of D24.3 response from 08-144r1 page 4.

● Author: mxim-kwitt
Subject: Inserted Text
Date: 9/4/2008 2:55:25 PM

T REFER PHYSICAL WG

The delivered eye opening is the difference of the "1" level centroid at the crossing, determined with a vertical histogram, minus the "0" level centroid at the crossing, also determined with a vertical histogram.

● Author: lsi-gpenokie
Subject: Highlight
Date: 9/4/2008 2:55:29 PM

T REFER PHYSICAL WG

This << than that budgeted and an |SDD21| comparable >> should be << than that budgeted with an |SDD21| comparable >>

Comments from page 205 continued on next page

5.3.7.4.4.2 Test signal characteristics and calibration

5.3.7.4.4.3 Transmit waveform calibration

Test equipment shall be used to establish the transmit launch signal at point A in figure 131 to meet the characteristics defined in table 72.

5.3.7.4.4.4 ISI generator calibration

The hardware ISI generator shall deliver a stressed signal to the receiver device under test that is representative of and at least as stressful as the reference transmitter test load (see 5.3.2.5). The measure of stress is:

- a) the computed link dispersion penalty (LDP); and
- b) $|S_{DD21}|$ at $(f_{baud} / 2)$.

With the transmitter jitter and crosstalk sources disabled, the delivered waveform shall be captured at the compliance point (IR or CR) and processed to determine the LDP. Waveform averaging shall be used to minimize the impact of measurement noise and jitter on the LDP calculations.

$|S_{DD21}|$ delivered by the hardware ISI generator shall be measured by observing the delivered eye opening at the compliance point (IR or CR) per the specification in table 72.

NOTE 28 - The reference transmitter test load (see 5.3.2.5) may be used as an ISI generator. It has a nominal $|S_{DD21}|$ requirement of -15 dB at $(f_{baud} / 2)$.

5.3.7.4.4.5 ISI generator pulse response

The captured waveform shall be processed as described in section 5.3.7.4.4.6 to determine the LDP. An ISI generator suitable for this test shall have a LDP greater than that budgeted and an $|S_{DD21}|$ comparable to that of the reference transmitter test load.

5.3.7.4.4.6 Crosstalk calibration

A coupling mechanism is used to inject representative crosstalk to the receiver device under test at the compliance point (IR or CR). The center frequency of the crosstalk source shall be frequency offset from the pattern generator to sweep all potential relative phase alignments between the crosstalk source and the signal from the ISI generator. With the transmit signal disabled, a histogram of the signal delivered to the receiver under test shall be generated. The crosstalk amplitude shall be at greater than the total crosstalk amplitude specified in table 72.

5.3.7.4.4.7 Jitter tolerance

A receiver device shall satisfy the jitter tolerance test described in this subclause. The jitter tolerance test leverages the receiver device physical test hardware. The receiver device under test shall demonstrate a BER that is less than 10^{-12} with a 95 % confidence level when subjected to the sinusoidal jitter defined in 5.3.7.6.

● Author: Isi-gpenokie
Subject: Cross-Out
Date: 9/4/2008 2:55:36 PM
 REFER PHYSICAL WG

This << The jitter tolerance test leverages the receiver device physical test hardware. >> provides no useful information and should be deleted.

● Author: Isi-gpenokie
Subject: Highlight
Date: 9/4/2008 2:55:41 PM
 REFER PHYSICAL WG

This << device shall satisfy the jitter tolerance test >> should be << device shall, at a minimum, meet the jitter tolerance test >>

● Author: pmcs-gfortin
Subject: Highlight
Date: 9/4/2008 2:55:46 PM
 REFER PHYSICAL WG

Section 5.3.7.6 only specifies the sinusoidal jitter limit for 1.5Gb/s and 3Gb/s. It should be extended for 6Gb/s if the intent is to include a 0.1UI SJ margin for 6G SAS-2 jitter tolerance test.

● Author: RElliott
Subject: Underline
Date: 6/30/2008 6:16:52 PM
 ACCEPT - DONE

sinusoidal jitter
s/b
SJ

● Author: Isi-jenkins
Subject: Highlight
Date: 9/4/2008 2:55:52 PM
 REFER PHYSICAL WG

● Author: Isi-jenkins
Subject: Note
Date: 9/4/2008 2:55:49 PM
 REFER PHYSICAL WG

section 5.3.7.6 discusses only 1.5 & 3Gb/s testing. The only reference to 6G is a reference back to this section.

08-144r1, slide 9, recommends a reasonable solution for this.

● Author: mxim-kwitt
Subject: Replacement Text
Date: 9/4/2008 2:59:35 PM
 REFER PHYSICAL WG

in Figure 122 as illustrated in Figure xxx, with the addition of fixed SJ of 0.022UI at 20MHz.

The jitter tolerance test uses the electrical characteristics of table 72 with the transmitter RJ and DJ minimized.

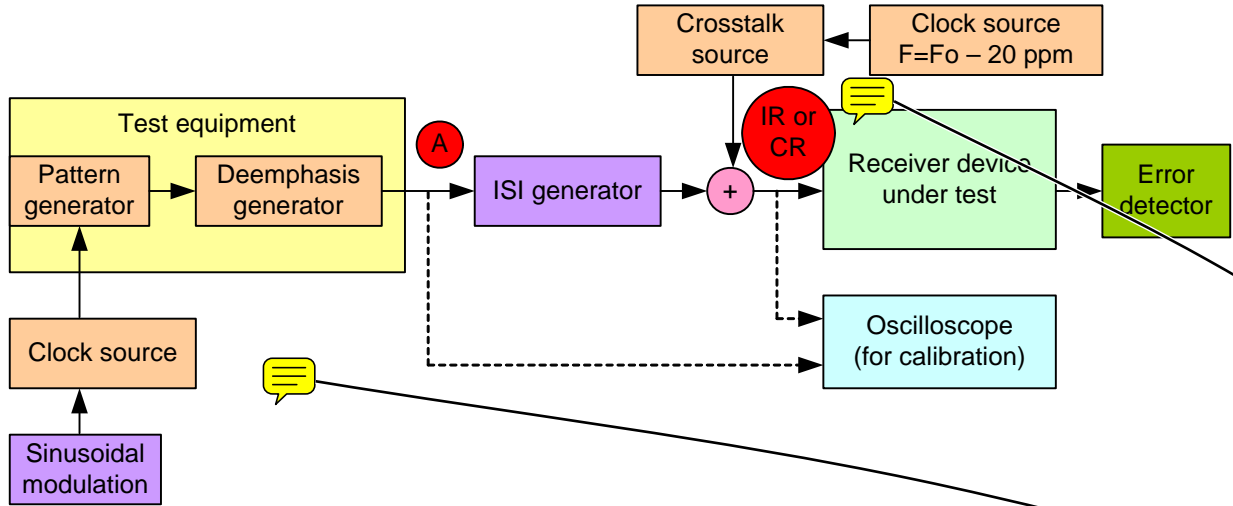

Figure 132 — Jitter tolerance test block diagram

5.3.7.4.4.8 Link dispersion penalty signal processing algorithm

The LDP computation algorithm can be found in T11-706r0.

Editor's Note 5: This needs to be replaced - either incorporate the information about the LDP algorithm, or replace it with a different parameter and algorithm that can be used with StatEye.

5.3.7.5 Maximum delivered jitter

Table 73 defines the maximum jitter the system shall deliver to the receiver device at the receiver device compliance point (i.e., IR or CR) for 1.5 Gbps and 3 Gbps. SSC-induced high-frequency jitter is included in DJ and consequently TJ at the transmitter device output. SSC shall be enabled if supported by the receiver device and shall not disabled if the not supported by the receiver device. For 6 Gbps see 5.3.7.4.4.

Table 73 — Maximum delivered jitter at receiver device compliance points IR and CR

Signal characteristic ^{a, b}	Units	1.5 Gbps	3 Gbps
Deterministic jitter (DJ) ^c	UI	0.35	
Total jitter (TJ) ^{d, c, e}	UI	0.55	

- ^a All DJ and TJ values are level 1 (see MJSQ).
- ^b The values for jitter in this table are measured at the average signal amplitude point.
- ^c The DJ and TJ values in this table apply to jitter measured as described in 5.3.5.3. Values for DJ and TJ shall be calculated from the CDF for the jitter population using the calculation of level 1 jitter compliance levels method in MJSQ.
- ^d TJ is specified at a CDF level of 10⁻¹².
- ^e If TJ received at any point is less than the maximum allowed, then the jitter distribution of the signal is allowed to be asymmetric. The TJ plus the magnitude of the asymmetry shall not exceed the allowed maximum TJ. The numerical difference between the average of the peaks with a BER that is less than 10⁻¹² and the average of the individual events is the measure of the asymmetry.

Jitter peak-to-peak measured < (maximum TJ - |Asymmetry|)

Page: 206

● Author: mxim-kwitt
Subject: Cross-Out
Date: 9/4/2008 2:55:58 PM
 REFER PHYSICAL WG

● Author: Isi-jenkins
Subject: Highlight
Date: 9/4/2008 2:56:02 PM
 REFER PHYSICAL WG

The replacement to figure 132, below, as proposed in 08-144r1, still shows an RJ input. To avoid any misunderstanding, I want to assert that the solutions discussed in committee did still have RJ (and BUJ other than SJ) minimized. That is, this line remains as is.

● Author: RElliott
Subject: Note
Date: 9/4/2008 2:56:06 PM
 REFER PHYSICAL WG

fix overlap of red circle over green box

● Author: mxim-kwitt
Subject: Note
Date: 9/4/2008 2:56:09 PM
 REFER PHYSICAL WG

modify Figure 132 from page 9 of 08-144r2



● Author: pmcs-gfortin
Subject: Highlight
Date: 9/4/2008 2:56:13 PM
 REFER PHYSICAL WG

Figure 132 (section 5.3.7.4.4.7, p. 204) does not include the RJ and BUJ jitter sources from figure 131 and table 72. These jitter sources should be added so that the SJ sweep test is a true JT margin test. The SSC modulation source should also be added.

● Author: wdc-mevans
Subject: Highlight
Date: 9/4/2008 2:56:17 PM
 REFER PHYSICAL WG

can
s/b
is

● Author: Isi-gpenokie
Subject: Highlight
Date: 9/4/2008 2:56:20 PM
 REFER PHYSICAL WG

Besides the term << can >> needing to be removed, the reference to a proposal is not allowed.

● Author: wdc-mevans
Subject: Highlight
Date: 6/3/2008 4:12:55 PM
 REJECT (nothing wrong with "consequently")

and consequently in
s/b

Comments from page 206 continued on next page

The jitter tolerance test uses the electrical characteristics of table 72 with the transmitter RJ and BUJ minimized.

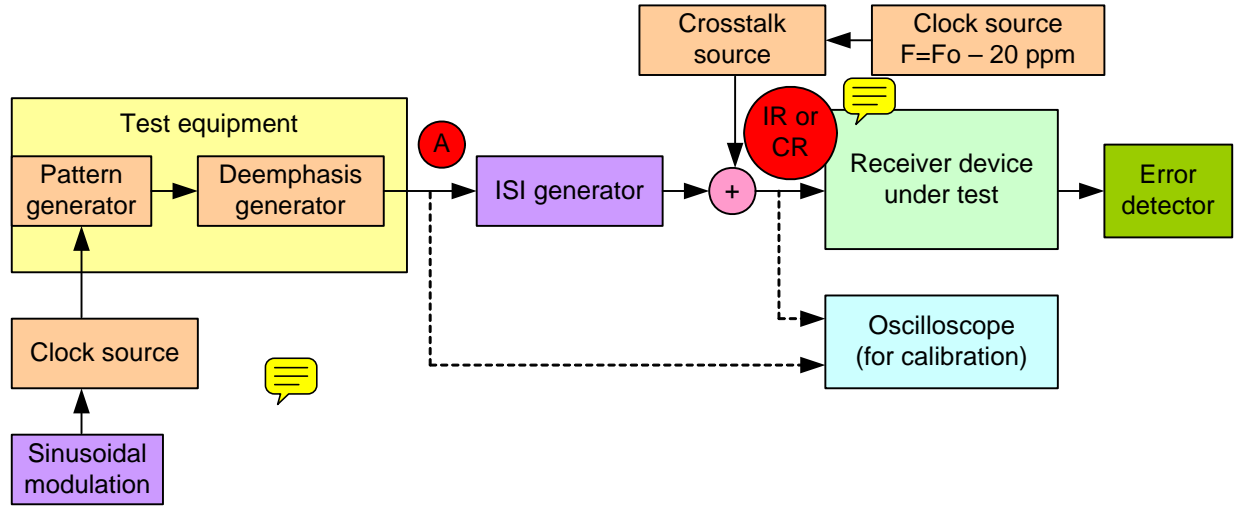

Figure 132 — Jitter tolerance test block diagram

5.3.7.4.4.8 Link dispersion penalty signal processing algorithm

The LDP computation algorithm can be found in T11-706r0.

Editor's Note 5: This needs to be replaced - either incorporate the information about the LDP algorithm, or replace it with a different parameter and algorithm that can be used with StatEye.

5.3.7.5 Maximum delivered jitter

Table 73 defines the maximum jitter the system shall deliver to the receiver device at the receiver device compliance point (i.e., IR or CR) for 1.5 Gbps and 3 Gbps. SSC-induced high-frequency jitter is included in DJ and consequently TJ at the transmitter device output. SSC shall be enabled if supported by the receiver device and shall not disabled if the not supported by the receiver device. For 6 Gbps see 5.3.7.4.4.

Table 73 — Maximum delivered jitter at receiver device compliance points IR and CR

Signal characteristic ^{a, b}	Units	1.5 Gbps	3 Gbps
Deterministic jitter (DJ) ^c	UI	0.35	
Total jitter (TJ) ^{d, c, e}	UI	0.55	

^a All DJ and TJ values are level 1 (see MJSQ).
^b The values for jitter in this table are measured at the average signal amplitude point.
^c The DJ and TJ values in this table apply to jitter measured as described in 5.3.5.3. Values for DJ and TJ shall be calculated from the CDF for the jitter population using the calculation of level 1 jitter compliance levels method in MJSQ.
^d TJ is specified at a CDF level of 10⁻¹².
^e If TJ received at any point is less than the maximum allowed, then the jitter distribution of the signal is allowed to be asymmetric. The TJ plus the magnitude of the asymmetry shall not exceed the allowed maximum TJ. The numerical difference between the average of the peaks with a BER that is less than 10⁻¹² and the average of the individual events is the measure of the asymmetry.
 Jitter peak-to-peak measured < (maximum TJ - |Asymmetry|)

and, as a result, in

Author: lsi-gpenokie

Subject: Highlight

Date: 5/24/2008 1:03:58 PM

TACCEPT - DONE ("SSC shall be enabled if SSC is supported by the receiver device and shall be disabled if SSC is not supported by the receiver device.")

This << SSC shall be enabled if supported by the receiver device and shall not disabled if the not supported by the receiver device. >> has so many things wrong with it I don't know were to start. For example:

Does it apply to 1.5, 3, and 6 or just 1.5 and 3?

What does << shall not disabled if the not supported by the receiver device >> this mean? Aside from a missing <<be>>.

It appears to be saying that you shall not disable SSC if SSC is not supported. How can you not disable something that is not there to be disabled?

Author: wdc-mevans

Subject: Highlight

Date: 5/6/2008 4:07:48 PM

TREJECT (only 2 things are anded)

10-12 and

s/b

10-12, and

5.3.7.6 Receiver device jitter tolerance

Table 74 defines the amount of jitter the receiver device shall tolerate at the receiver device compliance point (i.e., IR or CR) for 1.5 Gbps and 3 Gbps. Receiver device jitter testing shall be performed with the maximum (i.e., slowest) rise/fall times, minimum signal amplitude, and maximum total jitter, and should be performed with normal activity in the receiver device (e.g., with other transmitter circuits and receiver circuits on the same board as the receiver device performing normal activity) with SSC enabled if supported by the receiver device. For 6 Gbps see 5.3.7.4.4.

Table 74 — Receiver device jitter tolerance at receiver device compliance points IR and CR

Signal characteristic	Units	1.5 Gbps	3 Gbps
Applied sinusoidal jitter (SJ) ^b	UI	0.10 ^c	0.10 ^d
Deterministic jitter (DJ) ^{a, h}	UI	0.35 ^f	0.35 ^g
Total jitter (TJ) ^{a, e, h}	UI	0.65	

^a All DJ and TJ values are level 1 (see MJSQ).

^b The jitter values given are normative for a combination of applied SJ, DJ, and TJ that receiver devices shall be able to tolerate without exceeding the required BER (see 5.3.3.3.1). Receiver devices shall tolerate applied SJ of progressively greater amplitude at lower frequencies, according to figure 122 (see 5.3.5.5), with the same DJ and RJ levels as were used in the high frequency sweep.

^c Applied sinusoidal swept frequency: 900 kHz to the minimum of 5 MHz and $(3.75 \times 2^{(\text{generation} - 1)})$ MHz (e.g., 5 MHz for 1.5 Gbps and 7.5 MHz for 3 Gbps).

^d Applied sinusoidal swept frequency: 1 800 kHz to the minimum of 5 MHz and $(3.75 \times 2^{(\text{generation} - 1)})$ MHz (e.g., 5 MHz for 1.5 Gbps and 7.5 MHz for 3 Gbps).

^e No value is given for RJ. For compliance with this standard, the actual RJ amplitude shall be the value that brings TJ to the stated value at a probability of 10^{-12} . The additional 0.1 UI of applied SJ is added to ensure the receiver device has sufficient operating margin in the presence of external interference.

^f The measurement bandwidth shall be 900 kHz to 750 MHz.

^g The measurement bandwidth shall be 1 800 kHz to 1 500 MHz.

^h The DJ and TJ values in this table apply to jitter measured as described in 5.3.5.4. Values for DJ and TJ shall be calculated from the CDF for the jitter population using the calculation of level 1 jitter compliance levels method in MJSQ.

5.3.8 Spread spectrum clocking (SSC)

5.3.8.1 SSC overview

Spread spectrum clocking (SSC) is the technique of modulating the operating frequency of a transmitted signal to reduce the measured peak amplitude of radiated emissions.

Phys transmit with SSC as defined in 5.3.8.2 and receive with SSC as defined in 5.3.8.3.

NOTE 29 - Phys compliant with previous versions of this standard do not transmit with SSC. Phys compliant with previous versions of this standard that do not support being attached to SATA devices were not required to receive with SSC.

● Author: RElliott
Subject: Highlight
Date: 6/30/2008 6:16:52 PM
T ACCEPT - DONE

total jitter
s/b
TJ

● Author: wdc-mevans
Subject: Highlight
Date: 5/24/2008 1:03:41 PM
T ACCEPT - DONE

if supported
s/b
if SSC is supported

● Author: Isi-gpenokie
Subject: Highlight
Date: 9/4/2008 2:56:29 PM
T REFER PHYSICAL WG

In this << (generation - 1) >> it is not clear what the exponent is supposed to be.

● Author: Isi-gpenokie
Subject: Highlight
Date: 9/4/2008 2:56:34 PM
T REFER PHYSICAL WG

In this << (generation - 1) >> it is not clear what the exponent is supposed to be.

Table 75 defines the SSC modulation types.

Table 75 — SSC modulation types

SSC modulation type	Maximum SSC frequency deviation (SSC _{tol}) ^a
Center-spreading	+2 300 / -2 300 ppm
None	+0 / -0 ppm
Down-spreading	+0 / -2 300 ppm
SATA down-spreading ^b	+0 / -5 000 ppm

^a This is in addition to the physical link rate long-term stability and tolerance defined in table 54 and table 56 (see 5.3.3).
^b This is only used as a receiver parameter.

A phy may be transmitting with a different SSC modulation type than it is receiving (e.g., a phy is transmitting with center-spreading while it is receiving with down-spreading).

If the SSC modulation type is not none, the phy shall transmit within the specified maximum SSC frequency deviation with an SSC modulation frequency that is a minimum of 30 kHz and a maximum of 33 kHz.

The SSC modulation profile (e.g., triangular or exponential) is vendor-specific, but is intended to provide the maximum amount of electromagnetic interference (EMI) reduction. For center-spreading, the average amount of up-spreading (i.e., > 0 ppm) in the SSC modulation profile shall be the same as the average amount of down-spreading (i.e., < 0 ppm). The amount of asymmetry in the SSC modulation profile shall be less than 288 ppm.

NOTE 30 - 288 ppm is the rate of deletable primitives that are left over after accounting for the physical link rate long-term stability. It is calculated as the deletable primitive rate defined in previous versions of this standard of 1/2 048 (i.e., 488 ppm) minus the width between the extremes of the physical link rate long-term stability of +100/-100 ppm (i.e., 200 ppm).

SSC-induced jitter is included in the deterministic jitter (DJ) and consequently in total jitter (TJ) at the transmitter output. SSC-induced jitter shall be measured using a D30.3 pattern (see table 235 in 10.2.9.2) after the application of the JTF (see 5.3.5.2).

The slope of the frequency deviation shall not exceed 1 200 ppm/μs when computed over any 0.3 ± 0.01 μs interval of the SSC modulation profile. The slope is computed from the difference equation:

$$\text{slope} = (f(t) - f(t - 0.3 \mu\text{s})) / 0.3 \mu\text{s}$$

where

f(t) is the SSC frequency deviation expressed in ppm.

NOTE 31 - A triangular SSC modulation profile has a slope of approximately 310 ppm/μs and meets the slope requirement. Other SSC modulation profiles (e.g., exponential) may not meet the slope requirement.

A modulation profile that has a slope of 1 200 ppm/μs over 0.3 μs creates a residual jitter of approximately 25 ps (i.e., 0.15 UI at 6 Gbps) after filtering by the JTF. This consumes the total DJ budget of the transmitter device, which does not allow the transmitter device to contribute any other type of DJ.

Activation or deactivation of SSC on a link that is not D.C. idle shall be done without violating the slope requirement.

Page: 208

● Author: RElliott
Subject: Highlight
Date: 6/30/2008 6:16:52 PM
T ACCEPT - DONE

(global)
Change
None
to
No-spreading

The term "none" is confusing in some tables.

● Author: wdc-mevans
Subject: Highlight
Date: 6/1/2008 4:42:27 PM
T REJECT (first noun/subject convention)

it
s/b
the phy

● Author: RElliott
Subject: Highlight
Date: 6/30/2008 6:16:52 PM
T ACCEPT - DONE

the
s/b
then the

● Author: RElliott
Subject: Highlight
Date: 6/30/2008 6:16:52 PM
T ACCEPT - DONE

none
s/b
no-spreading

● Author: RElliott
Subject: Cross-Out
Date: 6/30/2008 6:16:52 PM
~~**T**~~ ACCEPT - DONE

Delete "or exponential" - don't want to encourage anything but triangular, as most other patterns exceed the df/dt recommendation

● Author: wdc-mevans
Subject: Highlight
Date: 9/4/2008 2:56:40 PM
T REFER PHYSICAL WG

specific, but
s/b
specific but

● Author: lsi-gpenokie
Subject: Highlight

Comments from page 208 continued on next page

Table 75 defines the SSC modulation types.

Table 75 — SSC modulation types

SSC modulation type	Maximum SSC frequency deviation (SSC _{tol}) ^a
Center-spreading	+2 300 / -2 300 ppm
None	+0 / -0 ppm
Down-spreading	+0 / -2 300 ppm
SATA down-spreading ^b	+0 / -5 000 ppm

^a This is in addition to the physical link rate long-term stability and tolerance defined in table 54 and table 56 (see 5.3.3).
^b This is only used as a receiver parameter.

A phy may be transmitting with a different SSC modulation type than it is receiving (e.g., a phy is transmitting with center-spreading while it is receiving with down-spreading).

If the SSC modulation type is not none, the phy shall transmit within the specified maximum SSC frequency deviation with an SSC modulation frequency that is a minimum of 30 kHz and a maximum of 33 kHz.

The SSC modulation profile (e.g., triangular or exponential) is vendor-specific, but is intended to provide the maximum amount of electromagnetic interference (EMI) reduction. For center-spreading, the average amount of up-spreading (i.e., > 0 ppm) in the SSC modulation profile shall be the same as the average amount of down-spreading (i.e., < 0 ppm). The amount of asymmetry in the SSC modulation profile shall be less than 288 ppm.

NOTE 30 - 288 ppm is the rate of deletable primitives that are left over after accounting for the physical link rate long-term stability. It is calculated as the deletable primitive rate defined in previous versions of this standard of 1/2 048 (i.e., 488 ppm) minus the width between the extremes of the physical link rate long-term stability of +100/-100 ppm (i.e., 200 ppm).

SSC-induced jitter is included in the deterministic jitter (DJ) and consequently in total jitter (TJ) at the transmitter output. SSC-induced jitter shall be measured using a D30.3 pattern (see table 235 in 10.2.9.2) after the application of the JTF (see 5.3.5.2).

The slope of the frequency deviation shall not exceed 1 200 ppm/μs when computed over any 0.3 ± 0.01 μs interval of the SSC modulation profile. The slope is computed from the difference equation:

$$\text{slope} = (f(t) - f(t - 0.3 \mu\text{s})) / 0.3 \mu\text{s}$$

where

f(t) is the SSC frequency deviation expressed in ppm.

NOTE 31 - A triangular SSC modulation profile has a slope of approximately 310 ppm/μs and meets the slope requirement. Other SSC modulation profiles (e.g., exponential) may not meet the slope requirement.

A modulation profile that has a slope of 1 200 ppm/μs over 0.3 μs creates a residual jitter of approximately 25 ps (i.e., 0.15 UI at 6 Gbps) after filtering by the JTF. This consumes the total DJ budget of the transmitter device, which does not allow the transmitter device to contribute any other type of DJ.

Activation or deactivation of SSC on a link that is not D.C. idle shall be done without violating the slope requirement.

Date: 6/3/2008 4:13:47 PM

T ACCEPT - DONE

This << vendor-specific, but is intended to provide the >> should be << vendor-specific, but should provide the >>

Author: pmcs-gfortin

Subject: Highlight

Date: 5/24/2008 1:06:11 PM

T REJECT (instead, changed to only use DJ and TJ acronyms, and removed the "the"s. This matches wording in other sections)

"in the total jitter"

Author: wdc-mevans

Subject: Highlight

Date: 5/24/2008 1:04:24 PM

T REJECT

and consequently in

s/b

and, as a result, in

Author: pmcs-gfortin

Subject: Highlight

Date: 9/4/2008 2:56:50 PM

T REFER PHYSICAL WG

May need to change to "bounded un-correlated jitter (BUJ)" to stay in line with the proposed change to the tx jitter specs that was discussed at the March face-to-face meeting.

Author: pmcs-gfortin

Subject: Highlight

Date: 6/28/2008 1:27:04 PM

T ACCEPT - DONE (Alvin: Accept. Replace text with:

"The slope of the frequency deviation should not exceed +- 850 ppm/us when computed over any 0.27 +- 0.01 us interval of the SSC modulation profile, after filtering of the transmitter jitter output by a single pole low-pass filter with a cutoff frequency of 3.7MHz +- 0.2MHz. Alternatively, the transmitter jitter may be filtered by the closed-loop transfer function of a measurement equipment's PLL that is compliant to the JTF.

The slope is computed from the difference equation:

$$\text{slope} = (f(t) - f(t - 0.27 \text{ us})) / 0.27 \text{ us}$$

where

f(t) is the SSC frequency deviation expressed in ppm.

NOTE 31 - A +- 2300 ppm triangular SSC modulation profile has a slope of approximately 310 ppm/us and meets the informative slope specification. Other SSC modulation profiles (e.g., exponential) may not meet the slope requirement. A modulation profile that has a slope of +- 850 ppm/us over 0.27 us creates a residual jitter of approximately 16.7 ps (i.e., 0.10 UI at 6 Gbps) after filtering by the JTF. This consumes the total BUJ budget of the transmitter device, which does not allow the transmitter device to contribute any other type of BUJ.

Activation or deactivation of SSC on a link that is not D.C. idle shall be done without violating the total jitter (TJ) at the transmitter output after application of the JTF."

)

As explained in detail in presentation T10/08-121r1, the measurement of the slope of the SSC profile is not an accurate representation of the jitter after the JTF in the presence of high frequency noise. It thus cannot be used as a specification for the transmitter output jitter.

Also, as detailed in 08-121r1, a slope calculation window of 0.27us gives a better fit with the nominal JTF response.

It is proposed to change the SSC slope specification to make it informative rather than normative:

"The slope of the frequency deviation should not exceed +- 850 ppm/us when computed over any 0.27 +- 0.01 us interval of the SSC modulation profile, after filtering of the transmitter jitter output by a single pole low-pass filter with a cutoff frequency of 3.7MHz +- 0.2MHz. Alternatively, the transmitter jitter may be filtered by the closed-loop transfer function of a measurement equipment's PLL that is compliant to the JTF.

Comments from page 208 continued on next page

Table 75 defines the SSC modulation types.

Table 75 — SSC modulation types

SSC modulation type	Maximum SSC frequency deviation (SSC _{tol}) ^a
Center-spreading	+2 300 / -2 300 ppm
None	+0 / -0 ppm
Down-spreading	+0 / -2 300 ppm
SATA down-spreading ^b	+0 / -5 000 ppm
^a This is in addition to the physical link rate long-term stability and tolerance defined in table 54 and table 56 (see 5.3.3). ^b This is only used as a receiver parameter.	

A phy may be transmitting with a different SSC modulation type than it is receiving (e.g., a phy is transmitting with center-spreading while it is receiving with down-spreading).

If the SSC modulation type is not none, the phy shall transmit within the specified maximum SSC frequency deviation with an SSC modulation frequency that is a minimum of 30 kHz and a maximum of 33 kHz.

The SSC modulation profile (e.g., triangular or exponential) is vendor-specific, but is intended to provide the maximum amount of electromagnetic interference (EMI) reduction. For center-spreading, the average amount of up-spreading (i.e., > 0 ppm) in the SSC modulation profile shall be the same as the average amount of down-spreading (i.e., < 0 ppm). The amount of asymmetry in the SSC modulation profile shall be less than 288 ppm.

NOTE 30 - 288 ppm is the rate of deletable primitives that are left over after accounting for the physical link rate long-term stability. It is calculated as the deletable primitive rate defined in previous versions of this standard of 1/2 048 (i.e., 488 ppm) minus the width between the extremes of the physical link rate long-term stability of +100/-100 ppm (i.e., 200 ppm).

SSC-induced jitter is included in the deterministic jitter (DJ) and consequently in total jitter (TJ) at the transmitter output. SSC-induced jitter shall be measured using a D30.3 pattern (see table 235 in 10.2.9.2) after the application of the JTF (see 5.3.5.2).

The slope of the frequency deviation shall not exceed 1 200 ppm/μs when computed over any 0.3 ± 0.01 μs interval of the SSC modulation profile. The slope is computed from the difference equation:

$$\text{slope} = (f(t) - f(t - 0.3 \mu\text{s})) / 0.3 \mu\text{s}$$

where

f(t) is the SSC frequency deviation expressed in ppm.

NOTE 31 - A triangular SSC modulation profile has a slope of approximately 310 ppm/μs and meets the slope requirement. Other SSC modulation profiles (e.g., exponential) may not meet the slope requirement.

A modulation profile that has a slope of 1 200 ppm/μs over 0.3 μs creates a residual jitter of approximately 25 ps (i.e., 0.15 UI at 6 Gbps) after filtering by the JTF. This consumes the total DJ budget of the transmitter device, which does not allow the transmitter device to contribute any other type of DJ.

Activation or deactivation of SSC on a link that is not D.C. idle shall be done without violating the slope requirement.

The slope is computed from the difference equation:

$$\text{slope} = (f(t) - f(t - 0.27 \text{ us})) / 0.27 \text{ us}$$

where

$f(t)$ is the SSC frequency deviation expressed in ppm.

NOTE 31 - A +/- 2300 ppm triangular SSC modulation profile has a slope of approximately 310 ppm/us and meets the informative slope specification. Other SSC modulation profiles (e.g., exponential) may not meet the slope requirement. A modulation profile that has a slope of +/- 850 ppm/us over 0.27 us creates a residual jitter of approximately 16.7 ps (i.e., 0.10 UI at 6 Gbps) after filtering by the JTF. This consumes the total BUJ budget of the transmitter device, which does not allow the transmitter device to contribute any other type of BUJ.

Activation or deactivation of SSC on a link that is not D.C. idle shall be done without violating the total jitter (TJ) at the transmitter output after application of the JTF."

5.3.8.2 Transmitter SSC modulation

A SAS phy transmits with the SSC modulation types defined in table 76.

Table 76 — SAS phy transmitter SSC modulation

SSC modulation type ^a	Requirement	Condition
None	Mandatory	When attached to a phy that does not support SSC
None or down-spreading	Optional	When attached to a phy that supports SSC
^a SAS phys compliant with previous versions of this standard were only allowed to transmit with an SSC modulation type of none.		

An expander phy transmits with the SSC modulation types defined in table 77

Table 77 — Expander phy transmitter SSC modulation types

SSC modulation type ^a	Requirement	Condition
None	Mandatory	When attached to a SAS phy or expander phy that does not support SSC
None or center-spreading	Optional	When attached to a SAS phy or expander phy that supports SSC
None or down-spreading	Optional	When attached to a SATA phy
^a Expander phys compliant with previous versions of this standard were only allowed to transmit with an SSC modulation type of none.		

A SAS device or expander device should provide independent control of SSC on each transmitter device. However, it may implement a common SSC transmit clock in which multiple transmitter devices do not have independent controls to enable and disable SSC. In such implementations, SSC may be disabled on a transmitter device that is already transmitting with SSC enabled if another transmitter device sharing the same common SSC transmit clock is required to perform SNW-1, SNW-2, SNW-3, or Final-SNW (see 6.7.4.2.3.2) or SAS speed negotiation (see 6.7.4.2.4).

If any transmitter device sharing a common SSC transmit clock enters a non-SSC transmission state (e.g., SNW-1, SNW-2, Final-SNW, or Train-SNW with SSC disabled), any transmitter device sharing that common SSC transmit clock may disable SSC. These transmitter devices are compliant with the SSC requirements even if the transmitter device has negotiated SSC enabled but its transmit clock has SSC disabled, provided that the transmitted signal does not exceed the maximum SSC frequency deviation limits specified in table 75.

The disabling and enabling of SSC may occur at any time except as noted in 6.7.4.2.3.2 or 6.7.4.2.4 (see 5.3.8.1).

● Author: RElliott
Subject: Highlight
Date: 6/30/2008 6:16:52 PM
 ACCEPT - DONE

SSC modulation
s/b
SSC modulation types

● Author: RElliott
Subject: Note
Date: 6/30/2008 6:16:52 PM
 ACCEPT - DONE

Redraw table 76 with these column headers:
SSC modulation type(s)
Condition Required Optional

● Author: RElliott
Subject: Highlight
Date: 6/30/2008 6:16:52 PM
 ACCEPT - DONE

When
s/b
While

since this persists for the duration of attachment, not just occurs at the instant of attachment

● Author: RElliott
Subject: Highlight
Date: 6/30/2008 6:16:52 PM
 ACCEPT - DONE

When
s/b
While

● Author: Isi-gpenokie
Subject: Highlight
Date: 5/26/2008 8:22:31 PM
 ACCEPT - DONE (but keeping the "with")

This << standard were only allowed to transmit with an >> should be << standard only transmitted an >>

● Author: RElliott
Subject: Highlight
Date: 6/30/2008 6:16:52 PM
 ACCEPT - DONE

none
s/b
no-spreading

● Author: RElliott
Subject: Note
Date: 6/30/2008 6:16:52 PM
 ACCEPT - DONE

5.3.8.2 Transmitter SSC modulation

A SAS phy transmits with the SSC modulation types defined in table 76.

Table 76 — SAS phy transmitter SSC modulation

SSC modulation type ^a	Requirement	Condition
None	Mandatory	When attached to a phy that does not support SSC
None or down-spreading	Optional	When attached to a phy that supports SSC
^a SAS phys compliant with previous versions of this standard were only allowed to transmit with an SSC modulation type of none.		

An expander phy transmits with the SSC modulation types defined in table 77.

Table 77 — Expander phy transmitter SSC modulation types

SSC modulation type ^a	Requirement	Condition
None	Mandatory	When attached to a SAS phy or expander phy that does not support SSC
None or center-spreading	Optional	When attached to a SAS phy or expander phy that supports SSC
None or down-spreading	Optional	When attached to a SATA phy
^a Expander phys compliant with previous versions of this standard were only allowed to transmit with an SSC modulation type of none.		

A SAS device or expander device should provide independent control of SSC on each transmitter device. However, it may implement a common SSC transmit clock in which multiple transmitter devices do not have independent controls to enable and disable SSC. In such implementations, SSC may be disabled on a transmitter device that is already transmitting with SSC enabled if another transmitter device sharing the same common SSC transmit clock is required to perform SNW-1, SNW-2, SNW-3, or Final-SNW (see 6.7.4.2.3.2) or SAS speed negotiation (see 6.7.4.2.4).

If any transmitter device sharing a common SSC transmit clock enters a non-SSC transmission state (e.g., SNW-1, SNW-2, Final-SNW, or Train-SNW with SSC disabled), any transmitter device sharing that common SSC transmit clock may disable SSC. These transmitter devices are compliant with the SSC requirements even if the transmitter device has negotiated SSC enabled but its transmit clock has SSC disabled, provided that the transmitted signal does not exceed the maximum SSC frequency deviation limits specified in table 75.

The disabling and enabling of SSC may occur at any time except as noted in 6.7.4.2.3.2 or 6.7.4.2.4 (see 5.3.8.1).

Redraw table 77 with these column headers:

SSC modulation type(s)

Condition Required Optional

Author: RElliott
Subject: Highlight
Date: 6/30/2008 6:16:52 PM

T ACCEPT - DONE

When
s/b
While

since this persists for the duration of attachment, not just occurs at the instant of attachment

Author: RElliott
Subject: Highlight
Date: 6/30/2008 6:16:52 PM

T ACCEPT - DONE

When
s/b
While

Author: RElliott
Subject: Highlight
Date: 6/30/2008 6:16:52 PM

T ACCEPT - DONE

When
s/b
While

Author: lsi-gpenokie
Subject: Highlight
Date: 5/26/2008 8:22:57 PM

T ACCEPT - DONE (but kept the "with")

This << standard were only allowed to transmit with an >> should be << standard only transmitted an >>

Author: RElliott
Subject: Highlight
Date: 6/30/2008 6:16:52 PM

T ACCEPT - DONE

none
s/b
no-spreading

Author: wdc-mevans
Subject: Highlight
Date: 5/6/2008 4:07:48 PM

T REJECT

it
s/b
a SAS device or expander device

Author: lsi-gpenokie
Subject: Highlight
Date: 5/6/2008 4:07:48 PM

Comments from page 209 continued on next page

5.3.8.2 Transmitter SSC modulation

A SAS phy transmits with the SSC modulation types defined in table 76.

Table 76 — SAS phy transmitter SSC modulation

SSC modulation type ^a	Requirement	Condition
None	Mandatory	When attached to a phy that does not support SSC
None or down-spreading	Optional	When attached to a phy that supports SSC
^a SAS phys compliant with previous versions of this standard were only allowed to transmit with an SSC modulation type of none.		

An expander phy transmits with the SSC modulation types defined in table 77.

Table 77 — Expander phy transmitter SSC modulation types

SSC modulation type ^a	Requirement	Condition
None	Mandatory	When attached to a SAS phy or expander phy that does not support SSC
None or center-spreading	Optional	When attached to a SAS phy or expander phy that supports SSC
None or down-spreading	Optional	When attached to a SATA phy
^a Expander phys compliant with previous versions of this standard were only allowed to transmit with an SSC modulation type of none.		

A SAS device or expander device should provide independent control of SSC on each transmitter device. However, it may implement a common SSC transmit clock in which multiple transmitter devices do not have independent controls to enable and disable SSC. In such implementations, SSC may be disabled on a transmitter device that is already transmitting with SSC enabled if another transmitter device sharing the same common SSC transmit clock is required to perform SNW-1, SNW-2, SNW-3, or Final-SNW (see 6.7.4.2.3.2) or SAS speed negotiation (see 6.7.4.2.4).

If any transmitter device sharing a common SSC transmit clock enters a non-SSC transmission state (e.g., SNW-1, SNW-2, Final-SNW, or Train-SNW with SSC disabled), any transmitter device sharing that common SSC transmit clock may disable SSC. These transmitter devices are compliant with the SSC requirements even if the transmitter device has negotiated SSC enabled but its transmit clock has SSC disabled, provided that the transmitted signal does not exceed the maximum SSC frequency deviation limits specified in table 75.

The disabling and enabling of SSC may occur at any time except as noted in 6.7.4.2.3.2 or 6.7.4.2.4 (see 5.3.8.1).

TREJECT

This << However, it may implement a common >> should be << However, a SAS device or expander device may implement a common >>

5.3.8.3 Receiver SSC modulation tolerance

SAS phys and expander phys support (i.e., tolerate) receiving with SSC modulation types defined in table 78.

Table 78 — Receiver SSC modulation tolerance

SSC modulation type ^{a b}	Requirement	Phys that tolerate
None	Mandatory	All phys
Center-spreading	Optional ^c	All phys
Down-spreading	Optional ^c	All phys
SATA down-spreading	Mandatory	Phys that support being attached to SATA phys
^a This is in addition to the physical link rate long-term tolerance defined in table 56 (see 5.3.3). ^b Phys compliant with previous versions of this standard that do not support being attached to SATA devices were only required to tolerate an SSC modulation type of none. Phys compliant with previous versions of this standard that support being attached to SATA devices were only required to tolerate SSC modulation types of none and SATA down-spreading. ^c If either the SSC modulation type of center-spreading or down-spreading is supported, both shall be supported.		

5.3.8.4 Expander device center-spreading tolerance buffer

Expander devices supporting the SSC modulation type of center-spreading shall support a center-spreading tolerance buffer for each connection with the buffer size defined in table 79 to hold any dwords it receives during the up-spreading portion(s) of the SSC modulation period that it is unable to forward because the ECR and/or the transmitting expander phy is slower than the receiving expander phy and because the dword stream does not include enough deletable primitives. The expander device unloads the center-spreading tolerance buffer during the down-spreading portion(s) of the SSC modulation period when the receiving expander phy is slower than the ECR and the transmitting expander phy.

Table 79 — Expander device center-spreading tolerance buffer

Physical link rate	Minimum buffer size
6 Gbps	14 dwords
3 Gbps	8 dwords
1.5 Gbps	4 dwords

NOTE 32 - The minimum buffer size is based on the number of dwords that may transmitted during half of the longest allowed SSC modulation period (i.e., half of the period indicated by 30 kHz) at the maximum physical link rate (i.e., +2 400 ppm) minus the number that may be transmitted at the minimum physical link rate (i.e., -2 400 ppm). This accounts for forwarding dwords in a connection that originated from a phy compliant with previous versions of this standard (i.e., a phy with an SSC modulation type of none and inserting deletable primitives at a rate supporting only the long-term frequency stability).

Author: RElliott
Subject: Highlight
Date: 6/30/2008 6:16:52 PM
T ACCEPT - DONE

modulation tolerance
s/b
modulation types tolerance

Author: RElliott
Subject: Highlight
Date: 6/30/2008 6:16:52 PM
T ACCEPT - DONE (
ACCEPT - DONE

Redraw table 76 with these column headers:
SSC modulation type(s)
Condition Required Optional

Changed "Phys that tolerate" header to "Type of phys".

Split the SATA down-spreading row into two, one for Phys that support and one for Phys that do not support. Those are the only two rows that remain.)

"All phys" is confusing, people think this overrides the mandatory/optional column

This is just trying to distinguish phys that support SATA vs phys that do not.

Author: RElliott
Subject: Highlight
Date: 6/30/2008 6:16:52 PM
T ACCEPT - DONE

none
s/b
no-spreading

Author: RElliott
Subject: Highlight
Date: 6/30/2008 6:16:52 PM
T ACCEPT - DONE

none
s/b
no-spreading

Author: intc-mseidel
Subject: Highlight
Date: 5/6/2008 4:07:48 PM
T REJECT (this is a receiver table, not a transmitter table. Receivers must be ready to tolerate both center- and down-spreading if they advertise support for SSC in SNW-3.)

In Note (c), there is no reason to require a transmitter to support both types of SSC modulation if it supports any type, since it could be designed for a particular application. Change Note (c): "both shall be supported" s/b "both should be supported".

Author: lsi-gpenokie
Subject: Highlight

5.3.8.3 Receiver SSC modulation tolerance

SAS phys and expander phys support (i.e., tolerate) receiving with SSC modulation types defined in table 78.

Table 78 — Receiver SSC modulation tolerance

SSC modulation type ^{a b}	Requirement	Phys that tolerate
None	Mandatory	All phys
Center-spreading	Optional ^c	All phys
Down-spreading	Optional ^c	All phys
SATA down-spreading	Mandatory	Phys that support being attached to SATA phys
^a This is in addition to the physical link rate long-term tolerance defined in table 56 (see 5.3.3). ^b Phys compliant with previous versions of this standard that do not support being attached to SATA devices were only required to tolerate an SSC modulation type of none . Phys compliant with previous versions of this standard that support being attached to SATA devices were only required to tolerate SSC modulation types of none and SATA down-spreading. ^c If either the SSC modulation type of center-spreading or down-spreading is supported, both shall be supported.		

5.3.8.4 Expander device center-spreading tolerance buffer

Expander devices supporting the SSC modulation type of center-spreading shall support a center spreading tolerance buffer for each connection with the buffer size defined in table 79 to hold any dwords it receives during the up-spreading portion(s) of the SSC modulation period that it is unable to forward because the ECR and/or the transmitting expander phy is slower than the receiving expander phy and because the dword stream does not include enough deletable primitives. The expander device unloads the center-spreading tolerance buffer during the down-spreading portion(s) of the SSC modulation period when the receiving expander phy is slower than the ECR and the transmitting expander phy.

Table 79 — Expander device center-spreading tolerance buffer

Physical link rate	Minimum buffer size
6 Gbps	14 dwords
3 Gbps	8 dwords
1.5 Gbps	4 dwords

NOTE 32 - The minimum buffer size is based on the number of dwords that may be transmitted during half of the longest allowed SSC modulation period (i.e., half of the period indicated by 30 kHz) at the maximum physical link rate (i.e., +2 400 ppm) minus the number that may be transmitted at the minimum physical link rate (i.e., -2 400 ppm). This accounts for forwarding dwords in a connection that originated from a phy compliant with previous versions of this standard (i.e., a phy with an SSC modulation type of **none** and inserting deletable primitives at a rate supporting only the long-term frequency stability).

Date: 5/26/2008 8:23:37 PM

T REJECT (Alvin: Reject. Support is a better description for the receiver than implement.)

this << spreading is supported, both shall be supported. >> should be << spreading is implemented, both shall be implemented. >>

Author: wdc-mevans

Subject: Highlight

Date: 6/1/2008 4:53:17 PM

T ACCEPT - DONE (as "The expander device uses this buffer to hold any dwords that it receives..." to avoid introducing an "it" problem)

table 79 to hold

s/b

table 79. This buffer holds

Author: lsi-gpenokie

Subject: Highlight

Date: 6/1/2008 4:53:45 PM

T REJECT (that doesn't make sense when the full sentence is read. wdc-mevans change accepted instead)

This << size defined in table 79 to hold any dwords >> should be << size defined in table 79 that is large enough to hold any dwords >>

Author: lsi-bday

Subject: Highlight

Date: 6/6/2008 1:37:04 PM

T REJECT (To be safe, adhere to these numbers. Saving a dword or two because of an analog technicality (that might be overlooked) would be risky. If the analog requirement changes again, it might get worse - but will always be bounded by these numbers.)

Minimum buffer size

With the addition of the SSC slope requirement of 1200 ppm/us, is the calculation accurate, or can these values be reduced?

Author: RElliott

Subject: Highlight

Date: 6/30/2008 6:16:52 PM

T ACCEPT - DONE

none

s/b

no-spreading

Figure 133 shows an example of center-spreading tolerance buffer usage.

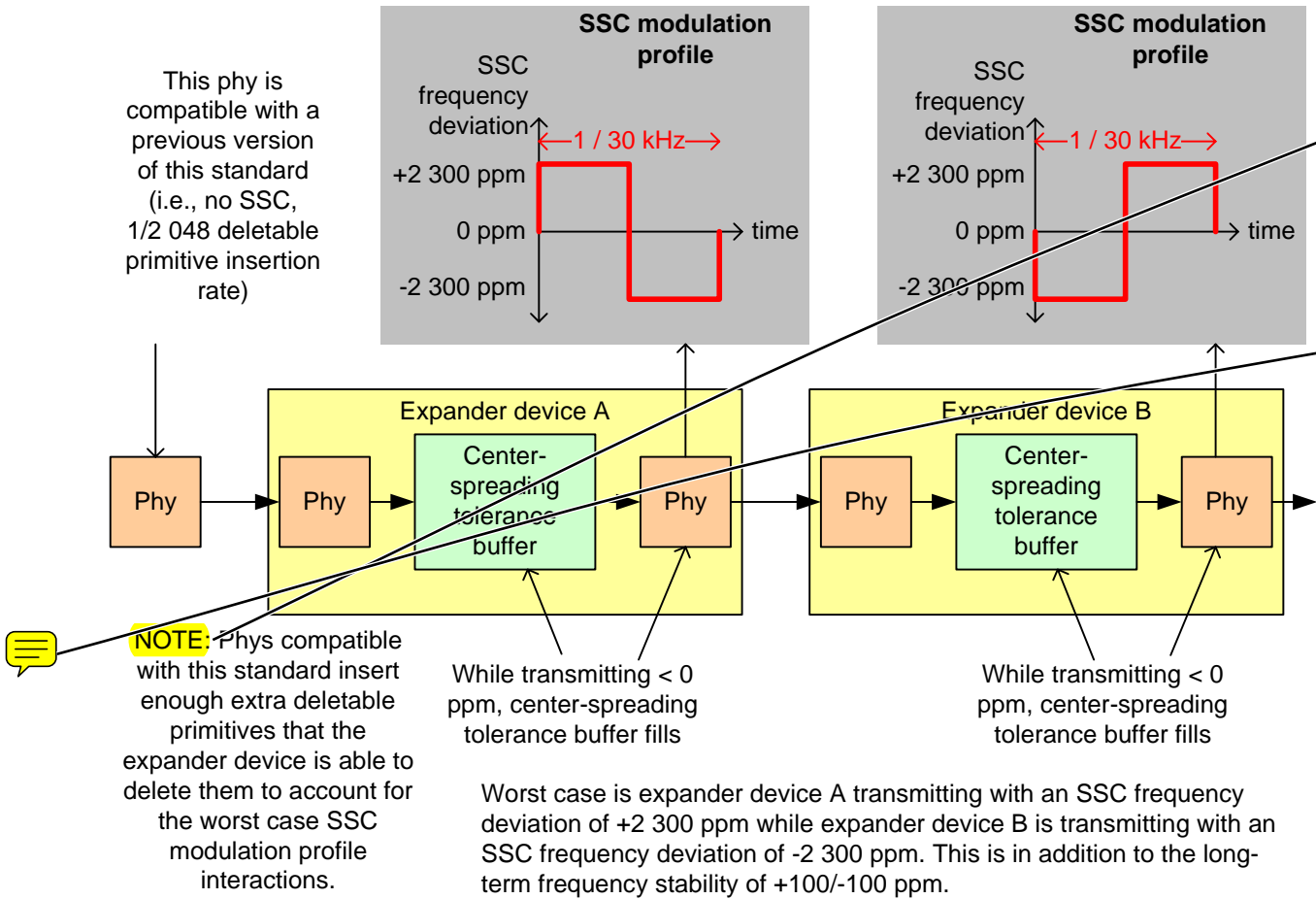

Figure 133 — Center-spreading tolerance buffer

5.3.9 Non-tracking clock architecture

Transceivers shall be designed with a non-tracking clock architecture (i.e., the receive clock derived from the bit stream received by the receiver device shall not be used as the transmit clock by the transmitter device).

Receiver devices that support SATA shall tolerate clock tracking by the SATA device. Receiver devices that do not support SATA are not required to tolerate clock tracking by the SATA device.

5.4 READY LED signal electrical characteristics

A SAS target device uses the READY LED signal to activate an externally visible LED that indicates the state of readiness and activity of the SAS target device.

All SAS target devices using the SAS Drive plug connector (see 5.2.3.2.1.1) shall support the READY LED signal.

The READY LED signal is designed to pull down the cathode of an LED using an open collector or open drain transmitter circuit. The LED and the current limiting circuitry shall be external to the SAS target device.

● Author: RElliott

Subject: Highlight

Date: 8/27/2008 4:18:52 PM

 REJECT (deleted word NOTE instead)

NOTE

s/b

Note

● Author: RElliott

Subject: Note

Date: 8/27/2008 4:19:04 PM

 REJECT (Deleted word NOTE instead)

Move the note to the bottom of the figure

(from Ralph Weber, per ISO editing of SAS-1.1)

Table 80 describes the output characteristics of the READY LED signal.

Table 80 — Output characteristics of the READY LED signal

State	Test condition	Requirement
Negated (LED off)	$0\text{ V} \leq V_{OH} \leq 3.6\text{ V}$	$-100\text{ }\mu\text{A} < I_{OH} < 100\text{ }\mu\text{A}$
Asserted (LED on)	$I_{OL} = 15\text{ mA}$	$0 \leq V_{OL} \leq 0.225\text{ V}$

The READY LED signal behavior is defined in 10.4.1.

NOTE 33 - SATA devices use the pin used by the READY LED signal (i.e., P11) for activity indication and staggered spin-up disable (see SATA-2). The output characteristics differ from those in table 80.

This page contains no comments

6 Phy layer

6.1 Phy layer overview

The phy layer defines 8b10b coding and OOB signals. Phy layer state machines interface between the link layer and the physical layer to perform the phy reset sequence and keep track of dword synchronization.

6.2 8b10b coding

6.2.1 8b10b coding overview

All information transferred in SAS is encoded into 10-bit characters using 8b10b encoding. Information includes data bytes (e.g., representing data in a frame) and control bytes (e.g., used for frame delimiters).

Running disparity (RD) shall be maintained separately on each physical link in each direction. During a connection (see 4.1.12), expander devices shall convert incoming 10-bit characters to 8-bit bytes and generate the 10-bit character with correct disparity for the output physical link. Phys within a device may or may not begin operation with the same disparity after the reset sequence.

6.2.2 8b10b coding introduction

Information to be transmitted across a physical link shall be encoded eight bits at a time into a 10-bit character and then transmitted serially bit-by-bit across the physical link. Information received over the physical link shall be collected ten bits at a time, and those characters that are used for data, called data characters, shall be decoded into the correct 8-bit data bytes. The 10-bit characters support all 256 8-bit combinations. Some of the remaining 10-bit characters, referred to as control characters, are used for functions that are to be distinguishable from the contents of a frame. The rest of the 10-bit characters are invalid characters.

8b10b coding ensures that sufficient transitions are present in the serial bit stream to make clock recovery possible at the receiver. Such encoding also greatly increases the likelihood of detecting any single or multiple bit errors that may occur during transmission and reception of information. In addition, some of the control characters of the transmission code contain a distinct and easily recognizable bit pattern called a comma pattern which assists a receiver in achieving character and dword alignment on the incoming bit stream.

6.2.3 8b10b coding notation conventions

This subclause uses letter notation for describing information bits and control variables. Such notation differs from the bit notation specified by the remainder of this standard. The following text describes the translation process between these notations and provides a translation example. It also describes the conventions used to name valid characters. This text is provided for the purposes of terminology clarification only.

An unencoded information byte is composed of eight information bits A, B, C, D, E, F, G, H and the control variable Z. This information is encoded into the bits a, b, c, d, e, i, f, g, h, j of a 10-bit character.

An information bit contains either a binary zero or a binary one. A control variable has either the value D or the value K. When the control variable associated with an unencoded information byte contains the value D, that byte is referred to as a data byte. When the control variable associated with an unencoded information byte contains the value K, that byte is referred to as a control byte.

The information bit labeled A corresponds to bit 0 in the numbering scheme of this standard, B corresponds to bit 1, and so on, as shown in table 81. Bit H is the most significant bit of the byte and bit A is the least significant bit of the byte.

Table 81 — Bit designations

Bit notation:	7	6	5	4	3	2	1	0	Control variable
Unencoded bit notation:	H	G	F	E	D	C	B	A	Z

Page: 213

Author: wdc-mevans

Subject: Highlight

Date: 5/6/2008 4:07:48 PM

 REJECT (there has been confusion in the past about whether the incoming and outgoing disparity are related, or whether it is related across wide links. These words help.)

separately on
s/b
for

Author: RElliott

Subject: Note

Date: 6/30/2008 6:16:52 PM

 ACCEPT - DONE

Move this RD paragraph into the new RD section

Author: RElliott

Subject: Note

Date: 6/30/2008 6:16:52 PM

 ACCEPT - DONE

Merge 6.2.1 and 6.2.2 together, after moving the RD paragraph elsewhere.

The section becomes:

All information transferred in SAS is encoded into 10-bit characters using 8b10b encoding. 10-bit characters are transmitted serially bit-by-bit across the physical link.

Out of all 1024 possible 10-bit characters:

- a) some of the characters are data characters, representing the 256 possible 8-bit data bytes;
- b) some of the characters are control characters, used for primitives (e.g., frame delimiters) and other control purposes; and
- c) the rest of the characters are invalid characters.

8b10b coding ensures that sufficient transitions are present in the serial bit stream to make clock recovery possible at the receiver. 8b10b coding also increases the likelihood of detecting any single or multiple bit errors that occur during transmission and reception. In addition, some of the control characters of the transmission code contain a distinct bit pattern, called a comma pattern, which assists a receiver in achieving character and dword alignment on the incoming bit stream.

Author: RElliott

Subject: Cross-Out

Date: 6/30/2008 6:16:52 PM

 ACCEPT - DONE

 Delete "after the reset sequence"

It doesn't really mean after the link reset sequence, or after the hard reset sequence, or after the OOB sequence. It applies to the burst portion of OOB signals, speed negotiation, and after speed negotiation. Just deleting it seems to work best.

Author: wdc-mevans

Subject: Cross-Out

Date: 5/6/2008 4:07:48 PM

 REJECT (with wide links available, important to stress that it's serial)

serially
[Delete the redundant word.]

Author: Isi-gpenokie

Subject: Cross-Out

Date: 5/6/2008 4:07:48 PM

 ACCEPT - DONE

 This << greatly >> adds nothing to the standard and should be deleted.

Comments from page 213 continued on next page

6 Phy layer

6.1 Phy layer overview

The phy layer defines 8b10b coding and OOB signals. Phy layer state machines interface between the link layer and the physical layer to perform the phy reset sequence and keep track of dword synchronization.

6.2 8b10b coding

6.2.1 8b10b coding overview

All information transferred in SAS is encoded into 10-bit characters using 8b10b encoding. Information includes data bytes (e.g., representing data in a frame) and control bytes (e.g., used for frame delimiters).

Running disparity (RD) shall be maintained **separately on** each physical link in each direction. During a connection (see 4.1.12), expander devices shall convert incoming 10-bit characters to 8-bit bytes and generate the 10-bit character with correct disparity for the output physical link. Phys within a device may or may not begin operation with the same disparity ~~after the reset sequence~~.

6.2.2 8b10b coding introduction

Information to be transmitted across a physical link shall be encoded eight bits at a time into a 10-bit character and then transmitted ~~serially~~ bit-by-bit across the physical link. Information received over the physical link shall be collected ten bits at a time, and those characters that are used for data, called data characters, shall be decoded into the correct 8-bit data bytes. The 10-bit characters support all 256 8-bit combinations. Some of the remaining 10-bit characters, referred to as control characters, are used for functions that are to be distinguishable from the contents of a frame. The rest of the 10-bit characters are invalid characters.

8b10b coding ensures that sufficient transitions are present in the serial bit stream to make clock recovery possible at the receiver. Such encoding also ~~greatly~~ increases the likelihood of detecting any single or multiple bit errors that may occur during transmission and reception of information. In addition, some of the control characters of the transmission code contain a distinct ~~and easily recognizable~~ bit **pattern called a comma pattern which** assists a receiver in achieving character and dword alignment on the incoming bit stream.

6.2.3 8b10b coding notation conventions

This subclause uses letter notation for describing information bits and control variables. Such notation differs from the bit notation specified by the remainder of this standard. The following text describes the translation process between these notations and provides a translation example. **It** also describes the conventions used to name valid characters. This text is provided for the purposes of terminology clarification only.

An unencoded information byte is composed of eight information **bits A, B, C, D, E, F, G, H** and the control variable Z. This information is encoded into the bits a, b, c, d, e, i, f, g, h, j of a 10-bit character.

An information bit contains either a binary zero or a binary one. A control variable has either the value D or the value K. When the control variable associated with an unencoded information byte contains the value D, that byte is referred to as a data byte. When the control variable associated with an unencoded information byte contains the value K, that byte is referred to as a control byte.

The information bit labeled A corresponds to bit 0 in the numbering scheme of this standard, B corresponds to bit 1, and so on, as shown in table 81. Bit H is the most significant bit of the **byte and** bit A is the least significant bit of the byte.

Table 81 — Bit designations

Bit notation:	7	6	5	4	3	2	1	0	Control variable
Unencoded bit notation:	H	G	F	E	D	C	B	A	Z

Author: wdc-mevans
Subject: Cross-Out
Date: 5/6/2008 4:07:48 PM
 ACCEPT - DONE
and easily recognizable
[Delete the redundant words.]

Author: wdc-mevans
Subject: Highlight
Date: 5/17/2008 5:30:33 PM
 ACCEPT - DONE
pattern called a comma pattern which
s/b
pattern, called a comma pattern, which

Author: wdc-mevans
Subject: Highlight
Date: 5/6/2008 4:07:48 PM
 ACCEPT - DONE
It
s/b
This subclause

Author: wdc-mevans
Subject: Highlight
Date: 5/6/2008 4:07:48 PM
 ACCEPT - DONE (too awkward to introduce with a comma. Changed to "with bits labeled" instead.)
bits A, B, C, D, E, F, G, H and
s/b
bits, A, B, C, D, E, F, G, and H, and

Author: RElliott
Subject: Note
Date: 6/30/2008 6:16:52 PM
 ACCEPT - DONE
Make this into an a)b) list:

An unencoded information byte is composed of:
a) eight information bits labeled A, B, C, D, E, F, G, and H; and
b) a control variable labeled Z.

This information is encoded into a 10-bit character containing bits labeled a, b, c, d, e, i, f, g, h, and j.

Author: RElliott
Subject: Underline
Date: 6/30/2008 6:16:52 PM
 ACCEPT - DONE
This information is encoded into the bits a, b, c, d, e, i, f, g, h, j of a 10-bit character.

Move this to 6.3.2. There is no other discussion of the 10-bit character nomenclature in this clause.

Author: wdc-mevans
Subject: Highlight
Date: 5/6/2008 4:07:48 PM
 ACCEPT - DONE
h, j
s/b
h, and j

6 Phy layer

6.1 Phy layer overview

The phy layer defines 8b10b coding and OOB signals. Phy layer state machines interface between the link layer and the physical layer to perform the phy reset sequence and keep track of dword synchronization.

6.2 8b10b coding

6.2.1 8b10b coding overview

All information transferred in SAS is encoded into 10-bit characters using 8b10b encoding. Information includes data bytes (e.g., representing data in a frame) and control bytes (e.g., used for frame delimiters).

Running disparity (RD) shall be maintained **separately on** each physical link in each direction. During a connection (see 4.1.12), expander devices shall convert incoming 10-bit characters to 8-bit bytes and generate the 10-bit character with correct disparity for the output physical link. Phys within a device may or may not begin operation with the same disparity ~~after the reset sequence~~.

6.2.2 8b10b coding introduction

Information to be transmitted across a physical link shall be encoded eight bits at a time into a 10-bit character and then transmitted ~~serially~~ bit-by-bit across the physical link. Information received over the physical link shall be collected ten bits at a time, and those characters that are used for data, called data characters, shall be decoded into the correct 8-bit data bytes. The 10-bit characters support all 256 8-bit combinations. Some of the remaining 10-bit characters, referred to as control characters, are used for functions that are to be distinguishable from the contents of a frame. The rest of the 10-bit characters are invalid characters.

8b10b coding ensures that sufficient transitions are present in the serial bit stream to make clock recovery possible at the receiver. Such encoding also ~~greatly~~ increases the likelihood of detecting any single or multiple bit errors that may occur during transmission and reception of information. In addition, some of the control characters of the transmission code contain a distinct ~~and easily recognizable~~ bit **pattern called a comma pattern which** assists a receiver in achieving character and dword alignment on the incoming bit stream.

6.2.3 8b10b coding notation conventions

This subclause uses letter notation for describing information bits and control variables. Such notation differs from the bit notation specified by the remainder of this standard. The following text describes the translation process between these notations and provides a translation example. **It** also describes the conventions used to name valid characters. This text is provided for the purposes of terminology clarification only.

An unencoded information byte is composed of eight information **bits A, B, C, D, E, F, G, H** and the control variable Z. This information is encoded into the bits a, b, c, d, e, i, f, g, h, j of a 10-bit character.

An information bit contains either a binary zero or a binary one. A control variable has either the value D or the value K. When the control variable associated with an unencoded information byte contains the value D, that byte is referred to as a data byte. When the control variable associated with an unencoded information byte contains the value K, that byte is referred to as a control byte.

The information bit labeled A corresponds to bit 0 in the numbering scheme of this standard, B corresponds to bit 1, and so on, as shown in table 81. Bit H is the most significant bit of the **byte and** bit A is the least significant bit of the byte.

Table 81 — Bit designations

Bit notation:	7	6	5	4	3	2	1	0	Control variable
Unencoded bit notation:	H	G	F	E	D	C	B	A	Z

Author: wdc-mevans
Subject: Highlight
Date: 5/6/2008 4:07:48 PM

TREJECT
byte and
s/b
byte, and

Each valid character **has been given a name** using the following convention:

Zxx.y

where:

- Z is the control variable of the unencoded information byte. The value of Z is used to indicate whether the character is a data character (Z = D) or a control character (Z = K).
- xx is the decimal value of the binary number composed of the bits E, D, C, B, and A of the unencoded information byte in that order.
- y is the decimal value of the binary number composed of the bits H, G, and F of the unencoded information byte in that order.

Table 82 shows the conversion from byte notation to the character naming convention.

Table 82 — Conversion from byte notation to character name example

Byte notation	BCh								
Bit notation	7	6	5	4	3	2	1	0	Control
	1	0	1	1	1	1	0	0	K
Unencoded bit notation	H	G	F	E	D	C	B	A	Z
	1	0	1	1	1	1	0	0	K
Unencoded bit notation reordered to conform with Zxx.y naming convention	Z	E	D	C	B	A	H	G	F
	K	1	1	1	0	0	1	0	1
Character name	K	28		.	5				

Most Kxx.y combinations do not result in valid characters within the 8b10b coding scheme. Only those combinations that result in control characters **as specified by table 84** are considered valid.

6.3 Character encoding and decoding

6.3.1 Introduction

This subclause describes how to select valid characters (i.e., 8b10b encoding) and check the validity of received characters (i.e., 10b8b decoding). **It also specifies** the ordering rules to be followed when transmitting the bits within a character.

6.3.2 Transmission order

Within the definition of the 8b10b code, the bit positions of the characters are labeled a, b, c, d, e, i, f, g, h, and j. Bit a shall be transmitted first, followed by bits b, c, d, e, i, f, g, h, and j, in that order.

NOTE 34 - Bit i is transmitted between bit e and bit f, rather than in **the order that would be indicated by the** letters of the alphabet.

Characters within primitives shall be transmitted sequentially beginning with the control character used to distinguish the primitive (e.g., K28.3 or K28.5) and proceeding character by character from left to right within the definition of the primitive until all characters of the primitive are transmitted.

The contents of a frame shall be transmitted sequentially beginning with the primitive used to denote the start of frame (e.g., SOAF, SOF, or SATA_SOF) and proceeding character-by-character from left to right within the definition of the frame until the primitive used to denote the end of frame (e.g., EOAF, EOF, or SATA_EOF) is transmitted.

● Author: RElliott
Subject: Highlight
Date: 6/30/2008 6:16:52 PM
T ACCEPT - DONE

has been given a name
s/b
is named

● Author: wdc-mevans
Subject: Highlight
Date: 5/25/2008 7:12:00 PM
T ACCEPT - DONE

(Z
s/b
(i.e., Z

● Author: wdc-mevans
Subject: Highlight
Date: 5/25/2008 7:12:08 PM
T ACCEPT - DONE

(Z
s/b
(i.e., Z

● Author: RElliott
Subject: Highlight
Date: 6/30/2008 6:16:52 PM
T ACCEPT - DONE

table 84 are
s/b
table 84 (see 6.3.3)

● Author: RElliott
Subject: Highlight
Date: 6/30/2008 6:16:52 PM
T ACCEPT - DONE

as specified by
s/b
defined in

● Author: wdc-mevans
Subject: Highlight
Date: 5/6/2008 4:07:48 PM
T ACCEPT - DONE (as ", and")

It
s/b
This subclause

● Author: RElliott
Subject: Underline
Date: 6/30/2008 6:16:52 PM
T ACCEPT - DONE

6.3.2 Transmission order

Each valid character **has been given a name** using the following convention:

Zxx.y

where:

- Z is the control variable of the unencoded information byte. The value of Z is used to indicate whether the character is a data character (Z = D) or a control character (Z = K).
- xx is the decimal value of the binary number composed of the bits E, D, C, B, and A of the unencoded information byte in that order.
- y is the decimal value of the binary number composed of the bits H, G, and F of the unencoded information byte in that order.

Table 82 shows the conversion from byte notation to the character naming convention.

Table 82 — Conversion from byte notation to character name example

Byte notation	BCh								
Bit notation	7	6	5	4	3	2	1	0	Control
	1	0	1	1	1	1	0	0	K
Unencoded bit notation	H	G	F	E	D	C	B	A	Z
	1	0	1	1	1	1	0	0	K
Unencoded bit notation reordered to conform with Zxx.y naming convention	Z	E	D	C	B	A	H	G	F
	K	1	1	1	0	0	1	0	1
Character name	K	28		.	5				

Most Kxx.y combinations do not result in valid characters within the 8b10b coding scheme. Only those combinations that result in control characters **as specified by table 84 are** considered valid.

6.3 Character encoding and decoding

6.3.1 Introduction

This subclause describes how to select valid characters (i.e., 8b10b encoding) and check the validity of received characters (i.e., 10b8b decoding). It also specifies the ordering rules to be followed when transmitting the bits within a character.

6.3.2 Transmission order

Within the definition of the 8b10b code, the bit positions of the characters are labeled a, b, c, d, e, i, f, g, h, and j. Bit a shall be transmitted first, followed by bits b, c, d, e, i, f, g, h, and j, in that order.

NOTE 34 - Bit i is transmitted between bit e and bit f, rather than in **the order that would be indicated by the** letters of the alphabet.

Characters within primitives shall be transmitted sequentially beginning with the control character used to distinguish the primitive (e.g., K28.3 or K28.5) and proceeding character by character from left to right within the definition of the primitive until all characters of the primitive are transmitted.

The contents of a frame shall be transmitted sequentially beginning with the primitive used to denote the start of frame (e.g., SOAF, SOF, or SATA_SOF) and proceeding character-by-character from left to right within the definition of the frame until the primitive used to denote the end of frame (e.g., EOAF, EOF, or SATA_EOF) is transmitted.

Split this into 3 sections
6.3.2 Bit transmission order
6.3.x Character transmission order
6.3.y Frame transmission order

Author: RElliott
Subject: Underline
Date: 6/30/2008 6:16:52 PM

T ACCEPT - DONE

Within the definition of the 8b10b code, the bit positions of the characters are labeled a, b, c, d, e, i, f, g, h, and j.

s/b

An information byte is encoded into a 10-bit character containing bits labeled a, b, c, d, e, i, f, g, h, and j.

to merge with sentence moved from 6.2.3

Author: lsi-gpenokie
Subject: Highlight
Date: 5/6/2008 4:07:48 PM

T ACCEPT - DONE

This << the order that would be indicated by the >> should be << the order indicated by the >>

6.3.3 Data and control characters

Table 83 and table 84 define the data characters (i.e., Dxx.y characters) and control characters (i.e., Kxx.y characters), respectively, and shall be used for both generating characters (i.e., encoding) and checking the validity of received characters (i.e., decoding). Each data character and control character entry has two columns that represent two (not necessarily different) characters, corresponding to the current value of the running disparity (current RD - or current RD +). RD is a binary parameter with a negative (-) or positive (+) value.

After power on, the transmitter may initialize the current RD to either positive or negative. Upon transmission of any character, the transmitter shall calculate a new value for its RD based on the contents of the transmitted character.

After power on, the receiver shall assume either the positive or negative value for its initial RD. Upon reception of any character, the receiver shall determine whether the character is valid or invalid and shall calculate a new value for its RD based on the contents of the received character.

The following rules for RD shall be used to calculate the new RD value for characters that have been transmitted (i.e., the transmitter's RD) and that have been received (i.e., the receiver's RD).

RD for a character shall be calculated on the basis of sub-blocks, where the first six bits (i.e., bits a, b, c, d, e, and i) form one sub-block (i.e., the six-bit sub-block) and the second four bits (i.e., bits f, g, h, and j) form the other sub-block (i.e., the four-bit sub-block):

- a) RD at the beginning of the six-bit sub-block is the RD at the end of the preceding character;
- b) RD at the beginning of the four-bit sub-block is the RD at the end of the preceding six-bit sub-block; and
- c) RD at the end of the character is the RD at the end of the four-bit sub-block.

RD for the sub-blocks shall be calculated as follows:

- a) If the sub-block contains more ones than zeros, then RD at the end of a sub-block is positive;
- b) If the sub-block contains more zeros than ones, then RD at the end of a sub-block is negative; or
- c) If the sub-block contains equal numbers of zeros and ones, then:
 - A) if it is a six-bit sub-block containing 000111b, then RD at the end of the sub-block is positive;
 - B) if it is a six-bit sub-block containing 111000b, then RD at the end of the sub-block is negative;
 - C) if it is a four-bit sub-block containing 0011b, then RD at the end of the sub-block is positive;
 - D) if it is a four-bit sub-block containing 1100b, then RD at the end of the sub-block is negative; or
 - E) otherwise, RD at the end of the sub-block is the same as at the beginning of the sub-block.

All sub-blocks with equal numbers of zeros and ones have neutral disparity (i.e., the ending disparity is the same as the beginning disparity). In order to limit the run length of zeros or ones across adjacent sub-blocks, the 8b10b code rules specify that sub-blocks encoded as 000111b or 0011b are generated only when the RD at the beginning of the sub-block is positive, ensuring that RD at the end of these sub-blocks is also positive. Likewise, sub-blocks containing 111000b or 1100b are generated only when the RD at the beginning of the sub-block is negative, ensuring that RD at the end of these sub-blocks is also negative.

Author: RElliott
Subject: Note
Date: 6/30/2008 6:16:52 PM
 ACCEPT - DONE

Split up 6.3.3 into 3 sections:
6.3.x Running disparity
6.3.y Data characters
6.3.z Control characters

Introduce the latter two with sentences like:

Table 83 defines the data characters (i.e., Dxx.y characters), and shall be used for both generating characters (i.e., encoding) and checking the validity of received characters (i.e., decoding).

Delete the first sentence of 6.3.3 in favor of those.

Reorder/reword as shown in sas2r14b.

Author: lsi-gpenokie
Subject: Highlight
Date: 6/5/2008 6:13:45 PM
 ACCEPT - DONE (significant rewrite gets rid of this. 5/5 yes fix this)

This << represent two (not necessarily different) characters, >> should be << represent two, not necessarily different, characters, >>

Author: wdc-mevans
Subject: Highlight
Date: 5/6/2008 4:07:48 PM
 REJECT (this is not just about transmission)

columns that represent two (not necessarily different) characters, corresponding to the current value of the running disparity (current RD - or current RD +). RD is a binary parameter with a negative (-) or positive (+) value.

s/b

columns that define the character to be transmitted based on the current running disparity (i.e., current RD - or current RD +).

Author: lsi-gpenokie
Subject: Highlight
Date: 6/5/2008 6:14:30 PM
 ACCEPT - DONE (significant rewrite gets rid of this. New RD section created, sentences moved around, etc. 5/5 move the RD definition ahead of its usage. Introduce the RD acronym at its first usage. Then clearly identifier "current RD -" and "current RD +" as table headers. Fix the parenthetical "(not necessarily different)" too.)

This << disparity (current RD - or current RD +) >> should be << disparity (i.e., current RD - or current RD +) >>

Author: lsi-gpenokie
Subject: Highlight
Date: 6/5/2008 4:43:12 PM
 ACCEPT - DONE (added "RD has the following properties:")

The sentence leading into the a,b,c list has no connecting words that indicate what the relationship between the sentence and the a.b.c list is. This needs to be fixed.

Author: RElliott
Subject: Underline
Date: 6/30/2008 6:16:52 PM
 ACCEPT - DONE

6.3.3 Data and control characters

Table 83 and table 84 define the data characters (i.e., Dxx.y characters) and control characters (i.e., Kxx.y characters), respectively, and shall be used for both generating characters (i.e., encoding) and checking the validity of received characters (i.e., decoding). Each data character and control character entry has two columns that represent two (not necessarily different) characters, corresponding to the current value of the running disparity (current RD - or current RD +). RD is a binary parameter with a negative (-) or positive (+) value.

After power on, the transmitter may initialize the current RD to either positive or negative. Upon transmission of any character, the transmitter shall calculate a new value for its RD based on the contents of the transmitted character.

After power on, the receiver shall assume either the positive or negative value for its initial RD. Upon reception of any character, the receiver shall determine whether the character is valid or invalid and shall calculate a new value for its RD based on the contents of the received character.

The following rules for RD shall be used to calculate the new RD value for characters that have been transmitted (i.e., the transmitter's RD) and that have been received (i.e., the receiver's RD).

RD for a character shall be calculated on the basis of sub-blocks, where the first six bits (i.e., bits a, b, c, d, e, and i) form one sub-block (i.e., the six-bit sub-block) and the second four bits (i.e., bits f, g, h, and j) form the other sub-block (i.e., the four-bit sub-block):

- a) RD at the beginning of the six-bit sub-block is the RD at the end of the preceding character;
- b) RD at the beginning of the four-bit sub-block is the RD at the end of the preceding six-bit sub-block; and
- c) RD at the end of the character is the RD at the end of the four-bit sub-block.

RD for the sub-blocks shall be calculated as follows:

- a) If the sub-block contains more ones than zeros, then RD at the end of a sub-block is positive;
- b) If the sub-block contains more zeros than ones, then RD at the end of a sub-block is negative; or
- c) If the sub-block contains equal numbers of zeros and ones, then:
 - A) if it is a six-bit sub-block containing 000111b, then RD at the end of the sub-block is positive;
 - B) if it is a six-bit sub-block containing 111000b, then RD at the end of the sub-block is negative;
 - C) if it is a four-bit sub-block containing 0011b, then RD at the end of the sub-block is positive;
 - D) if it is a four-bit sub-block containing 1100b, then RD at the end of the sub-block is negative; or
 - E) otherwise, RD at the end of the sub-block is the same as at the beginning of the sub-block.

All sub-blocks with equal numbers of zeros and ones have neutral disparity (i.e., the ending disparity is the same as the beginning disparity). In order to limit the run length of zeros or ones across adjacent sub-blocks, the 8b10b code rules specify that sub-blocks encoded as 000111b or 0011b are generated only when the RD at the beginning of the sub-block is positive, ensuring that RD at the end of these sub-blocks is also positive. Likewise, sub-blocks containing 111000b or 1100b are generated only when the RD at the beginning of the sub-block is negative, ensuring that RD at the end of these sub-blocks is also negative.

If
s/b
if

(part of global change to lowercase a)b)c) list entries)

● Author: RElliott
Subject: Underline
Date: 6/30/2008 6:16:52 PM
T ACCEPT - DONE

If
s/b
if

(part of global change to lowercase a)b)c) list entries)

● Author: RElliott
Subject: Underline
Date: 6/30/2008 6:16:52 PM
T ACCEPT - DONE

If
s/b
if

(part of global change to lowercase a)b)c) list entries)

Table 83 defines the data characters.

Table 83 — Data characters (part 1 of 5)

Name	Data byte		Data character (binary representation)	
	Binary representation (HGF EDCBA)	Hexadecimal representation	Current RD - abcdei fghj	Current RD + abcdei fghj
D00.0	000 00000	00h	100111 0100	011000 1011
D01.0	000 00001	01h	011101 0100	100010 1011
D02.0	000 00010	02h	101101 0100	010010 1011
D03.0	000 00011	03h	110001 1011	110001 0100
D04.0	000 00100	04h	110101 0100	001010 1011
D05.0	000 00101	05h	101001 1011	101001 0100
D06.0	000 00110	06h	011001 1011	011001 0100
D07.0	000 00111	07h	111000 1011	000111 0100
D08.0	000 01000	08h	111001 0100	000110 1011
D09.0	000 01001	09h	100101 1011	100101 0100
D10.0	000 01010	0Ah	010101 1011	010101 0100
D11.0	000 01011	0Bh	110100 1011	110100 0100
D12.0	000 01100	0Ch	001101 1011	001101 0100
D13.0	000 01101	0Dh	101100 1011	101100 0100
D14.0	000 01110	0Eh	011100 1011	011100 0100
D15.0	000 01111	0Fh	010111 0100	101000 1011
D16.0	000 10000	10h	011011 0100	100100 1011
D17.0	000 10001	11h	100011 1011	100011 0100
D18.0	000 10010	12h	010011 1011	010011 0100
D19.0	000 10011	13h	110010 1011	110010 0100
D20.0	000 10100	14h	001011 1011	001011 0100
D21.0	000 10101	15h	101010 1011	101010 0100
D22.0	000 10110	16h	011010 1011	011010 0100
D23.0	000 10111	17h	111010 0100	000101 1011
D24.0	000 11000	18h	110011 0100	001100 1011
D25.0	000 11001	19h	100110 1011	100110 0100
D26.0	000 11010	1Ah	010110 1011	010110 0100
D27.0	000 11011	1Bh	110110 0100	001001 1011
D28.0	000 11100	1Ch	001110 1011	001110 0100
D29.0	000 11101	1Dh	101110 0100	010001 1011
D30.0	000 11110	1Eh	011110 0100	100001 1011
D31.0	000 11111	1Fh	101011 0100	010100 1011
D00.1	001 00000	20h	100111 1001	011000 1001
D01.1	001 00001	21h	011101 1001	100010 1001
D02.1	001 00010	22h	101101 1001	010010 1001
D03.1	001 00011	23h	110001 1001	110001 1001
D04.1	001 00100	24h	110101 1001	001010 1001
D05.1	001 00101	25h	101001 1001	101001 1001
D06.1	001 00110	26h	011001 1001	011001 1001
D07.1	001 00111	27h	111000 1001	000111 1001
D08.1	001 01000	28h	111001 1001	000110 1001
D09.1	001 01001	29h	100101 1001	100101 1001
D10.1	001 01010	2Ah	010101 1001	010101 1001
D11.1	001 01011	2Bh	110100 1001	110100 1001
D12.1	001 01100	2Ch	001101 1001	001101 1001
D13.1	001 01101	2Dh	101100 1001	101100 1001
D14.1	001 01110	2Eh	011100 1001	011100 1001
D15.1	001 01111	2Fh	010111 1001	101000 1001
D16.1	001 10000	30h	011011 1001	100100 1001
D17.1	001 10001	31h	100011 1001	100011 1001
D18.1	001 10010	32h	010011 1001	010011 1001
D19.1	001 10011	33h	110010 1001	110010 1001

This page contains no comments

Table 83 — Data characters (part 2 of 5)

Name	Data byte		Data character (binary representation)	
	Binary representation (HGF EDCBA)	Hexadecimal representation	Current RD - abcdei fghj	Current RD + abcdei fghj
D20.1	001 10100	34h	001011 1001	001011 1001
D21.1	001 10101	35h	101010 1001	101010 1001
D22.1	001 10110	36h	011010 1001	011010 1001
D23.1	001 10111	37h	111010 1001	000101 1001
D24.1	001 11000	38h	110011 1001	001100 1001
D25.1	001 11001	39h	100110 1001	100110 1001
D26.1	001 11010	3Ah	010110 1001	010110 1001
D27.1	001 11011	3Bh	110110 1001	001001 1001
D28.1	001 11100	3Ch	001110 1001	001110 1001
D29.1	001 11101	3Dh	101110 1001	010001 1001
D30.1	001 11110	3Eh	011110 1001	100001 1001
D31.1	001 11111	3Fh	101011 1001	010100 1001
D00.2	010 00000	40h	100111 0101	011000 0101
D01.2	010 00001	41h	011101 0101	100010 0101
D02.2	010 00010	42h	101101 0101	010010 0101
D03.2	010 00011	43h	110001 0101	110001 0101
D04.2	010 00100	44h	110101 0101	001010 0101
D05.2	010 00101	45h	101001 0101	101001 0101
D06.2	010 00110	46h	011001 0101	011001 0101
D07.2	010 00111	47h	111000 0101	000111 0101
D08.2	010 01000	48h	111001 0101	000110 0101
D09.2	010 01001	49h	100101 0101	100101 0101
D10.2	010 01010	4Ah	010101 0101	010101 0101
D11.2	010 01011	4Bh	110100 0101	110100 0101
D12.2	010 01100	4Ch	001101 0101	001101 0101
D13.2	010 01101	4Dh	101100 0101	101100 0101
D14.2	010 01110	4Eh	011100 0101	011100 0101
D15.2	010 01111	4Fh	010111 0101	101000 0101
D16.2	010 10000	50h	011011 0101	100100 0101
D17.2	010 10001	51h	100011 0101	100011 0101
D18.2	010 10010	52h	010011 0101	010011 0101
D19.2	010 10011	53h	110010 0101	110010 0101
D20.2	010 10100	54h	001011 0101	001011 0101
D21.2	010 10101	55h	101010 0101	101010 0101
D22.2	010 10110	56h	011010 0101	011010 0101
D23.2	010 10111	57h	111010 0101	000101 0101
D24.2	010 11000	58h	110011 0101	001100 0101
D25.2	010 11001	59h	100110 0101	100110 0101
D26.2	010 11010	5Ah	010110 0101	010110 0101
D27.2	010 11011	5Bh	110110 0101	001001 0101
D28.2	010 11100	5Ch	001110 0101	001110 0101
D29.2	010 11101	5Dh	101110 0101	010001 0101
D30.2	010 11110	5Eh	011110 0101	100001 0101
D31.2	010 11111	5Fh	101011 0101	010100 0101
D00.3	011 00000	60h	100111 0011	011000 1100
D01.3	011 00001	61h	011101 0011	100010 1100
D02.3	011 00010	62h	101101 0011	010010 1100
D03.3	011 00011	63h	110001 1100	110001 0011
D04.3	011 00100	64h	110101 0011	001010 1100
D05.3	011 00101	65h	101001 1100	101001 0011
D06.3	011 00110	66h	011001 1100	011001 0011
D07.3	011 00111	67h	111000 1100	000111 0011
D08.3	011 01000	68h	111001 0011	000110 1100
D09.3	011 01001	69h	100101 1100	100101 0011

This page contains no comments

Table 83 — Data characters (part 3 of 5)

Name	Data byte		Data character (binary representation)	
	Binary representation (HGF EDCBA)	Hexadecimal representation	Current RD - abcdei fghj	Current RD + abcdei fghj
D10.3	011 01010	6Ah	010101 1100	010101 0011
D11.3	011 01011	6Bh	110100 1100	110100 0011
D12.3	011 01100	6Ch	001101 1100	001101 0011
D13.3	011 01101	6Dh	101100 1100	101100 0011
D14.3	011 01110	6Eh	011100 1100	011100 0011
D15.3	011 01111	6Fh	010111 0011	101000 1100
D16.3	011 10000	70h	011011 0011	100100 1100
D17.3	011 10001	71h	100011 1100	100011 0011
D18.3	011 10010	72h	010011 1100	010011 0011
D19.3	011 10011	73h	110010 1100	110010 0011
D20.3	011 10100	74h	001011 1100	001011 0011
D21.3	011 10101	75h	101010 1100	101010 0011
D22.3	011 10110	76h	011010 1100	011010 0011
D23.3	011 10111	77h	111010 0011	000101 1100
D24.3	011 11000	78h	110011 0011	001100 1100
D25.3	011 11001	79h	100110 1100	100110 0011
D26.3	011 11010	7Ah	010110 1100	010110 0011
D27.3	011 11011	7Bh	110110 0011	001001 1100
D28.3	011 11100	7Ch	001110 1100	001110 0011
D29.3	011 11101	7Dh	101110 0011	010001 1100
D30.3	011 11110	7Eh	011110 0011	100001 1100
D31.3	011 11111	7Fh	101011 0011	010100 1100
D00.4	100 00000	80h	100111 0010	011000 1101
D01.4	100 00001	81h	011101 0010	100010 1101
D02.4	100 00010	82h	101101 0010	010010 1101
D03.4	100 00011	83h	110001 1101	110001 0010
D04.4	100 00100	84h	110101 0010	001010 1101
D05.4	100 00101	85h	101001 1101	101001 0010
D06.4	100 00110	86h	011001 1101	011001 0010
D07.4	100 00111	87h	111000 1101	000111 0010
D08.4	100 01000	88h	111001 0010	000110 1101
D09.4	100 01001	89h	100101 1101	100101 0010
D10.4	100 01010	8Ah	010101 1101	010101 0010
D11.4	100 01011	8Bh	110100 1101	110100 0010
D12.4	100 01100	8Ch	001101 1101	001101 0010
D13.4	100 01101	8Dh	101100 1101	101100 0010
D14.4	100 01110	8Eh	011100 1101	011100 0010
D15.4	100 01111	8Fh	010111 0010	101000 1101
D16.4	100 10000	90h	011011 0010	100100 1101
D17.4	100 10001	91h	100011 1101	100011 0010
D18.4	100 10010	92h	010011 1101	010011 0010
D19.4	100 10011	93h	110010 1101	110010 0010
D20.4	100 10100	94h	001011 1101	001011 0010
D21.4	100 10101	95h	101010 1101	101010 0010
D22.4	100 10110	96h	011010 1101	011010 0010
D23.4	100 10111	97h	111010 0010	000101 1101
D24.4	100 11000	98h	110011 0010	001100 1101
D25.4	100 11001	99h	100110 1101	100110 0010
D26.4	100 11010	9Ah	010110 1101	010110 0010
D27.4	100 11011	9Bh	110110 0010	001001 1101
D28.4	100 11100	9Ch	001110 1101	001110 0010
D29.4	100 11101	9Dh	101110 0010	010001 1101
D30.4	100 11110	9Eh	011110 0010	100001 1101
D31.4	100 11111	9Fh	101011 0010	010100 1101

This page contains no comments

Table 83 — Data characters (part 4 of 5)

Name	Data byte		Data character (binary representation)	
	Binary representation (HGF EDCBA)	Hexadecimal representation	Current RD - abcdei fghj	Current RD + abcdei fghj
D00.5	101 00000	A0h	100111 1010	011000 1010
D01.5	101 00001	A1h	011101 1010	100010 1010
D02.5	101 00010	A2h	101101 1010	010010 1010
D03.5	101 00011	A3h	110001 1010	110001 1010
D04.5	101 00100	A4h	110101 1010	001010 1010
D05.5	101 00101	A5h	101001 1010	101001 1010
D06.5	101 00110	A6h	011001 1010	011001 1010
D07.5	101 00111	A7h	111000 1010	000111 1010
D08.5	101 01000	A8h	111001 1010	000110 1010
D09.5	101 01001	A9h	100101 1010	100101 1010
D10.5	101 01010	AAh	010101 1010	010101 1010
D11.5	101 01011	ABh	110100 1010	110100 1010
D12.5	101 01100	ACh	001101 1010	001101 1010
D13.5	101 01101	ADh	101100 1010	101100 1010
D14.5	101 01110	AEnh	011100 1010	011100 1010
D15.5	101 01111	AFh	010111 1010	101000 1010
D16.5	101 10000	B0h	011011 1010	100100 1010
D17.5	101 10001	B1h	100011 1010	100011 1010
D18.5	101 10010	B2h	010011 1010	010011 1010
D19.5	101 10011	B3h	110010 1010	110010 1010
D20.5	101 10100	B4h	001011 1010	001011 1010
D21.5	101 10101	B5h	101010 1010	101010 1010
D22.5	101 10110	B6h	011010 1010	011010 1010
D23.5	101 10111	B7h	111010 1010	000101 1010
D24.5	101 11000	B8h	110011 1010	001100 1010
D25.5	101 11001	B9h	100110 1010	100110 1010
D26.5	101 11010	BAh	010110 1010	010110 1010
D27.5	101 11011	BBh	110110 1010	001001 1010
D28.5	101 11100	BCh	001110 1010	001110 1010
D29.5	101 11101	BDh	101110 1010	010001 1010
D30.5	101 11110	BEh	011110 1010	100001 1010
D31.5	101 11111	BFh	101011 1010	010100 1010
D00.6	110 00000	C0h	100111 0110	011000 0110
D01.6	110 00001	C1h	011101 0110	100010 0110
D02.6	110 00010	C2h	101101 0110	010010 0110
D03.6	110 00011	C3h	110001 0110	110001 0110
D04.6	110 00100	C4h	110101 0110	001010 0110
D05.6	110 00101	C5h	101001 0110	101001 0110
D06.6	110 00110	C6h	011001 0110	011001 0110
D07.6	110 00111	C7h	111000 0110	000111 0110
D08.6	110 01000	C8h	111001 0110	000110 0110
D09.6	110 01001	C9h	100101 0110	100101 0110
D10.6	110 01010	CAh	010101 0110	010101 0110
D11.6	110 01011	CBh	110100 0110	110100 0110
D12.6	110 01100	CCh	001101 0110	001101 0110
D13.6	110 01101	CDh	101100 0110	101100 0110
D14.6	110 01110	CEh	011100 0110	011100 0110
D15.6	110 01111	CFh	010111 0110	101000 0110
D16.6	110 10000	D0h	011011 0110	100100 0110
D17.6	110 10001	D1h	100011 0110	100011 0110
D18.6	110 10010	D2h	010011 0110	010011 0110
D19.6	110 10011	D3h	110010 0110	110010 0110
D20.6	110 10100	D4h	001011 0110	001011 0110
D21.6	110 10101	D5h	101010 0110	101010 0110

This page contains no comments

Table 83 — Data characters (part 5 of 5)

Name	Data byte		Data character (binary representation)	
	Binary representation (HGF EDCBA)	Hexadecimal representation	Current RD - abcdei fghj	Current RD + abcdei fghj
D22.6	110 10110	D6h	011010 0110	011010 0110
D23.6	110 10111	D7h	111010 0110	000101 0110
D24.6	110 11000	D8h	110011 0110	001100 0110
D25.6	110 11001	D9h	100110 0110	100110 0110
D26.6	110 11010	DAh	010110 0110	010110 0110
D27.6	110 11011	DBh	110110 0110	001001 0110
D28.6	110 11100	DCh	001110 0110	001110 0110
D29.6	110 11101	DDh	101110 0110	010001 0110
D30.6	110 11110	DEh	011110 0110	100001 0110
D31.6	110 11111	DFh	101011 0110	010100 0110
D00.7	111 00000	E0h	100111 0001	011000 1110
D01.7	111 00001	E1h	011101 0001	100010 1110
D02.7	111 00010	E2h	101101 0001	010010 1110
D03.7	111 00011	E3h	110001 1110	110001 0001
D04.7	111 00100	E4h	110101 0001	001010 1110
D05.7	111 00101	E5h	101001 1110	101001 0001
D06.7	111 00110	E6h	011001 1110	011001 0001
D07.7	111 00111	E7h	111000 1110	000111 0001
D08.7	111 01000	E8h	111001 0001	000110 1110
D09.7	111 01001	E9h	100101 1110	100101 0001
D10.7	111 01010	EAh	010101 1110	010101 0001
D11.7	111 01011	EBh	110100 1110	110100 1000
D12.7	111 01100	ECh	001101 1110	001101 0001
D13.7	111 01101	EDh	101100 1110	101100 1000
D14.7	111 01110	EEh	011100 1110	011100 1000
D15.7	111 01111	EFh	010111 0001	101000 1110
D16.7	111 10000	F0h	011011 0001	100100 1110
D17.7	111 10001	F1h	100011 0111	100011 0001
D18.7	111 10010	F2h	010011 0111	010011 0001
D19.7	111 10011	F3h	110010 1110	110010 0001
D20.7	111 10100	F4h	001011 0111	001011 0001
D21.7	111 10101	F5h	101010 1110	101010 0001
D22.7	111 10110	F6h	011010 1110	011010 0001
D23.7	111 10111	F7h	111010 0001	000101 1110
D24.7	111 11000	F8h	110011 0001	001100 1110
D25.7	111 11001	F9h	100110 1110	100110 0001
D26.7	111 11010	FAh	010110 1110	010110 0001
D27.7	111 11011	FBh	110110 0001	001001 1110
D28.7	111 11100	FCh	001110 1110	001110 0001
D29.7	111 11101	FDh	101110 0001	010001 1110
D30.7	111 11110	FEh	011110 0001	100001 1110
D31.7	111 11111	FFh	101011 0001	010100 1110

This page contains no comments

Table 84 defines the control characters. Comma patterns, which are two bits of one polarity followed by five bits of the opposite polarity (i.e., 001111b or 110000b), are underlined.

Table 84 — Control characters

Name	Control byte		Control character (binary representation)	
	Binary representation (HGF EDCBA)	Hexadecimal representation	Current RD - abcdei fghj	Current RD + abcdei fghj
K28.0	000 11100	1Ch	001111 0100	110000 1011
K28.1	001 11100	3Ch	<u>001111</u> 1001	<u>110000</u> 0110
K28.2	010 11100	5Ch	001111 0101	110000 1010
K28.3	011 11100	7Ch	001111 0011	110000 1100
K28.4	100 11100	9Ch	001111 0010	110000 1101
K28.5	101 11100	BCh	<u>001111</u> 1010	<u>110000</u> 0101
K28.6	110 11100	DCh	001111 0110	110000 1001
K28.7	111 11100	FCh	<u>001111</u> 1000	<u>110000</u> 0111
K23.7	111 10111	F7h	111010 1000	000101 0111
K27.7	111 11011	FBh	110110 1000	001001 0111
K29.7	111 11101	FDh	101110 1000	010001 0111
K30.7	111 11110	FEh	011110 1000	100001 0111

NOTE 35 - K28.1, K28.5, and K28.7 are the only characters which contain comma patterns. Comma patterns do not appear in any data characters and do not appear across any adjacent data characters. The K28.7 control character **introduces a comma pattern** when followed by any of the following characters: K28.y, D3.y, D11.y, D12.y, D19.y, D20.y, or D28.y, where y is a value in the range 0 to 7, inclusive. None of the other control characters introduce a comma pattern when adjacent to any other character. Therefore, K28.7 is not used, ensuring that comma patterns do not appear in any sequence of characters except the first 7 bits of K28.1 or K28.5.

The only control characters used in this standard are K28.3, K28.5, and K28.6, as defined in table 85.

Table 85 — Control character usage

First character of a dword	Usage in SAS physical links	Usage in SATA physical links
K28.3	Primitives used only inside STP connections	All primitives except ALIGN
K28.5	ALIGN and most primitives defined in this standard	ALIGN
K28.6	Not used	SATA_ERROR

See 7.2 for details on primitives, which use those control characters.

6.3.4 Encoding characters in the transmitter

To transmit a data byte, the transmitter shall select the appropriate character from table 83 based on the current value of the transmitter's RD. To transmit a control byte, the transmitter shall select the appropriate character from table 84 based on the current value of the transmitter's RD. After the transmitting the character,

Author: Isi-gpenokie
Subject: Highlight
Date: 5/6/2008 4:07:48 PM

T ACCEPT - DONE (converted into two table footnotes)

This note << NOTE 35 - K28.1, K28.5 >> seems like it should be a footnote in the above table. I say make it that way.

Author: RElliott
Subject: Highlight
Date: 6/30/2008 6:16:52 PM

T ACCEPT - DONE
introduces a comma pattern

s/b

introduces an additional comma pattern starting with bits i and f

It already has a comma pattern in bits abcdeif, as shown in the table. What this sentence is explaining is another comma is created out of bits ifghj of this character and ab of the next character, which would make identifying dword boundaries impossible.

the transmitter shall calculate a new value for its RD based on that character. This new value shall be used as the transmitter's current RD for the next character transmitted. This process is called 8b10b encoding.

6.3.5 Decoding characters in the receiver

After receiving a character, the receiver shall search the character column in table 83 and table 84 corresponding to its current RD to determine the data byte or control byte to which the character corresponds. This process is called 10b8b decoding. If the received character is not found in the proper column, then the character shall be considered invalid and the dword containing the character shall be considered an invalid dword.

Regardless of the received character's validity, the received character shall be used to calculate a new value of RD in the receiver. This new value shall be used as the receiver's current RD for the next received character.

Detection of a code violation does not necessarily indicate that the character in which the code violation was detected is in error. Code violations may result from a prior error that altered the RD of the bit stream but did not result in a detectable error at the character in which the error occurred. The example shown in table 86 exhibits this behavior. These errors may span dword boundaries. Expanders forwarding such a dword forward it as an ERROR (see 7.2.6.7).

Table 86 — Delayed code violation example

	RD	First character	RD	Second character	RD	Third character	RD
Transmitted character stream	-	D21.1	-	D10.2	-	D23.5	+
Transmitted bit stream	-	101010 1001	-	010101 0101	-	111010 1010	+
Bit stream after error	-	101010 1011 (error in second to last bit)	+	010101 0101	+	111010 1010	+
Decoded character stream	-	D21.0 (rather than D21.1) (not detected as an error)	+	D10.2 (no error)	+	Code violation (although D23.5 was properly received)	+

6.4 Dwords, primitives, data dwords, and invalid dwords

All characters transferred in SAS are grouped into four-character sequences called dwords.

A primitive is a dword whose first character is K28.3 or K28.5 and whose remaining three characters are data characters with correct disparity.

Primitives are defined with both negative and positive starting RD (see 6.3.3). SAS defines primitives starting with K28.5 (see 7.2.6 and 7.2.7). SATA defines primitives starting with K28.3 and K28.5, which are used in SAS during STP connections (see 7.2.8).

A data dword is a dword that contains four data characters with correct disparity.

A dword containing an invalid character shall be considered an invalid dword.

6.5 Bit order

Dwords transmitted in an STP connection shall be transmitted in the bit order specified by SATA.

This page contains no comments

Dwords for other types of connections and outside of connections shall be transmitted in the bit order in figure 134.

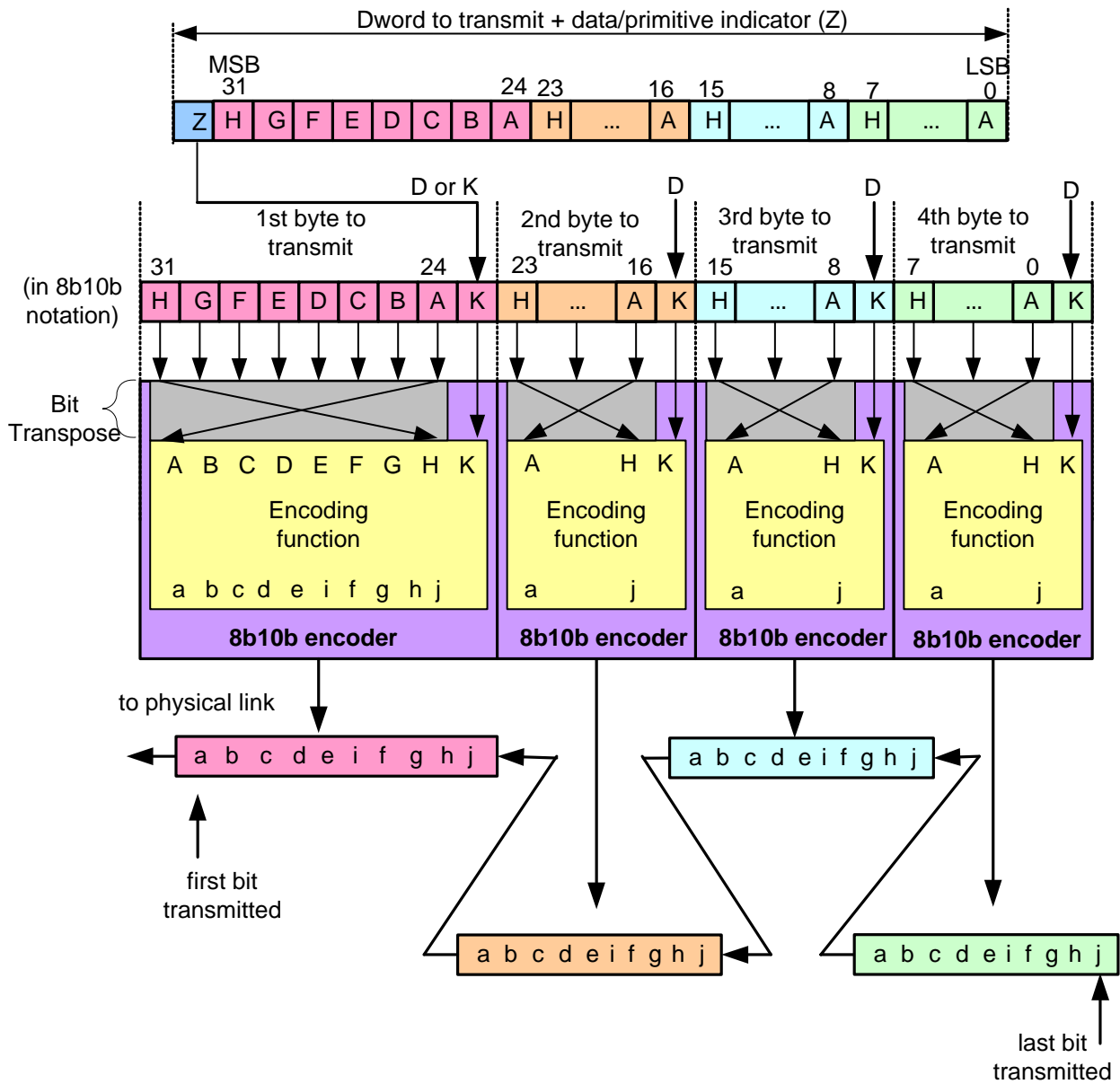

Figure 134 — SAS bit transmission logic

Author: wdc-mevans
Subject: Highlight
Date: 5/6/2008 4:07:48 PM

T ACCEPT - DONE

order in

s/b

order shown in

Figure 135 shows the SAS bit reception order.

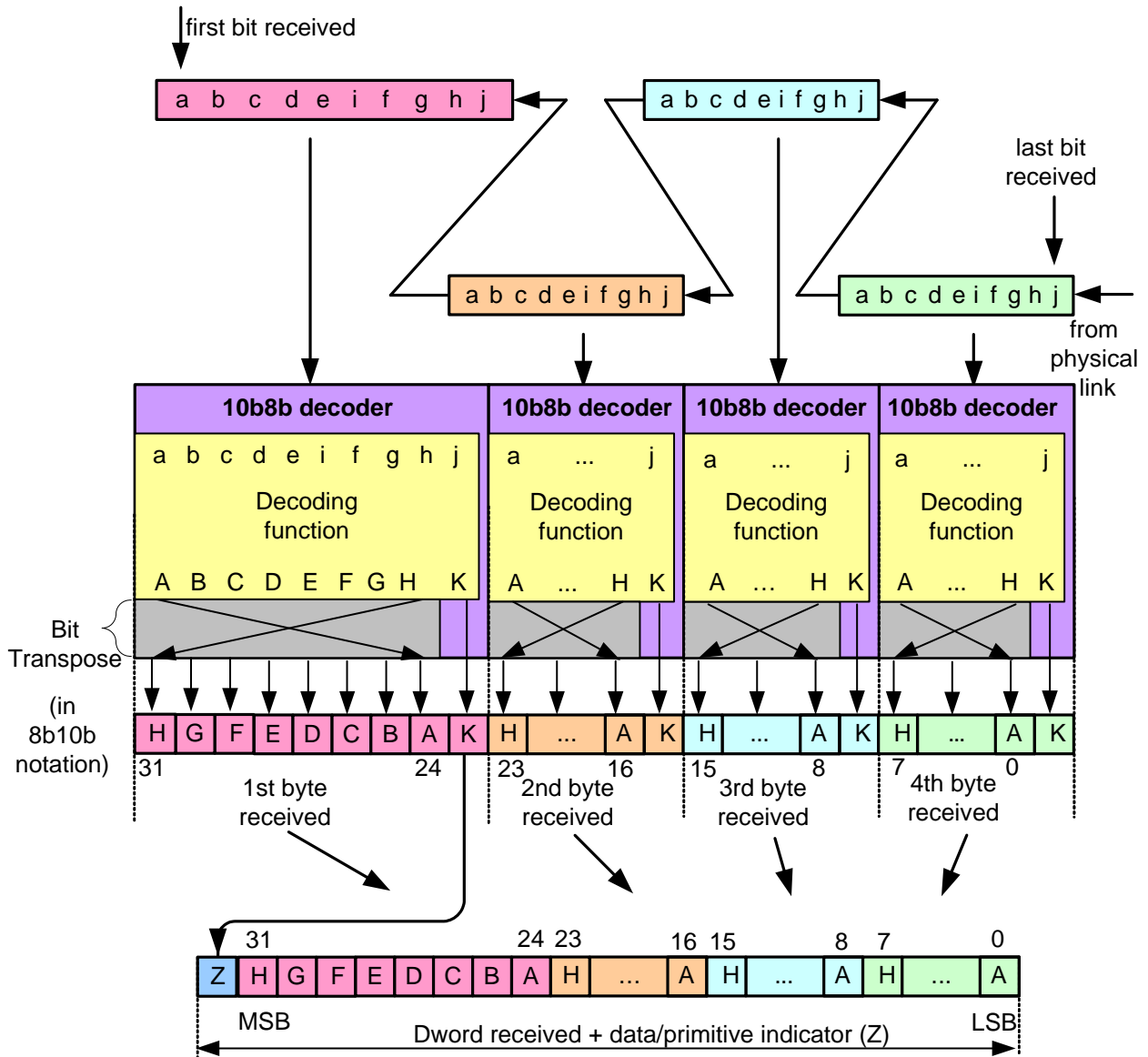

Figure 135 — SAS bit reception logic

6.6 Out of band (OOB) signals

6.6.1 OOB signals overview

Out of band (OOB) signals are low-speed signal patterns that do not appear in normal data streams. OOB signals consist of defined amounts of idle time followed by defined amounts of burst time. During the idle time, the physical link carries D.C. idle (see 3.1.46). During the burst time, the physical link carries signal transitions. The signals are differentiated by the length of idle time between the burst times.

SATA defines two OOB signals: COMINIT/COMRESET and COMWAKE. COMINIT and COMRESET are used in this standard interchangeably. Phys compliant with this standard identify themselves with an additional SAS-specific OOB signal called COMSAS.

This page contains no comments

Table 87 defines the timing specifications for OOB signals.

Table 87 — OOB signal timing specifications

Parameter	Minimum	Nominal	Maximum	Comments
OOB Interval (OOBI) ^a	665.067 ps	666.6 ps	668.267 ps	The time basis for burst times and idle times used to create OOB signals. Based on 1.5 Gbps clock tolerance with center-spreading SSC (see table 53 in 5.3.3 and table 75 in 5.3.8.1).
COMSAS detect timeout	13.65 μs			The minimum time a receiver device shall allow to detect COMSAS after transmitting COMSAS. Derived from: $OOBI \times 512 \times 40$

^a OOBI is different than UI(OOB) defined in SATA (e.g., SAS has tighter clock tolerance). This is a fixed value equal to the UI for 1.5 Gbps with center-spreading SSC, regardless of the actual transfer rate being used to create the burst time.

NOTE 36 - Previous versions of this standard defined OOBI based on the nominal UI for 1.5 Gbps with physical link rate long term stability tolerance (see table 53 in 5.3.3) but not with SSC modulation (see table 75 in 5.3.8.1). Interconnects compliant with previous versions of this standard may have assumed phys had that characteristic. To interoperate with interconnects compliant with previous versions of this standard, phys should create OOB burst times and idle times based on the UI for 1.5 Gbps without SSC modulation (e.g., if SSC is disabled, reflecting physical link rate long term stability but not SSC modulation).

6.6.2 Transmitting OOB signals

Table 88 describes the OOB signal transmitter requirements for the burst time, idle time, negation times, and signal times that are used to form each OOB signal.

Table 88 — OOB signal transmitter device requirements

Signal	Burst time	Idle time	Negation time	Signal time ^e
COMWAKE	160 OOBI ^a	160 OOBI ^a	280 OOBI ^b	2 200 OOBI ^g
COMINIT/COMRESET	160 OOBI ^a	480 OOBI ^c	800 OOBI ^d	4 640 OOBI ⁱ
COMSAS	160 OOBI ^a	1 440 OOBI ^f	2 400 OOBI ^h	12 000 OOBI ^j

^a 160 OOBI is nominally 106.6 ns (see table 87).
^b 280 OOBI is nominally 186.6 ns.
^c 480 OOBI is nominally 320 ns.
^d 800 OOBI is nominally 533.3 ns.
^e A signal time is six burst times plus six idle times plus one negation time.
^f 1 440 OOBI is nominally 960 ns.
^g 2 200 OOBI (e.g., COMWAKE) is nominally 1 466.6 ns.
^h 2 400 OOBI is nominally 1 600 ns.
ⁱ 4 640 OOBI (e.g., COMINIT/COMRESET) is nominally 3 093.3 ns.
^j 12 000 OOBI (e.g., COMSAS) is nominally 8 000 ns.

To transmit an OOB signal, the transmitter device shall repeat these steps six times:

- 1) transmit D.C. idle for an idle time; and
- 2) transmit an OOB burst with either starting disparity consisting of D24.3 characters or ALIGN (0) primitives for a burst time. The OOB burst should consist of D24.3 characters.

Page: 225

Author: RElliott
Subject: Underline
Date: 6/30/2008 6:16:52 PM
T ACCEPT - DONE

"Based on 1.5 Gbps clock tolerance with center-spreading SSC (see table 53 in 5.3.3 and table 75 in 5.3.8.1)."

s/b

merged with footnote A as:

"Based on:

- a) 1.5 Gbps UI (see table 53 in 5.3.3);
- b) physical link rate long-term stability (see table 54 in 5.3.4); and
- c) center-spreading SSC (see table 75 in 5.3.8.1)."

Author: RElliott
Subject: Underline
Date: 6/30/2008 6:16:52 PM
T ACCEPT - DONE

668.267 ps

s/b

668.26 repeating 6

since the math with fractions is actually:

$(2000 / 3) * (1.0024)$

Also, add a footnote explaining the math: 668.26 ps equals 666.6×1.0024 .

Author: RElliott
Subject: Underline
Date: 6/30/2008 6:16:52 PM
T ACCEPT - DONE

665.067 ps

s/b

665.06 repeating 6

since the math with fractions is actually:

$(2000 / 3) * (1 - 0.0024)$

Also, add a footnote explaining the math: 665.06 ps equals $666.6 \times (1 - .0024)$

Author: hpq-relliott
Subject: Highlight
Date: 6/25/2008 11:30:22 AM
T ACCEPT - DONE (Changed to 13.686 usec, and added "Maximum" to the "Derived from" equation. Per Alvin)

13.65 us is based on nominal OOBI.

It should based based on the maximum OOBI to allow the transmitter to be as slow as possible (largest OOBI) and still have a change to transmit 512 x 40 bits, which yields 13.68610816

Author: RElliott
Subject: Underline
Date: 6/30/2008 6:16:52 PM
T ACCEPT - DONE

Comments from page 225 continued on next page

Table 87 defines the timing specifications for OOB signals.

Table 87 — OOB signal timing specifications

Parameter	Minimum	Nominal	Maximum	Comments
OOB Interval (OOBI) ^a	665.067 ps	666.6 ps	668.267 ps	The time basis for burst times and idle times used to create OOB signals. Based on 1.5 Gbps clock tolerance with center-spreading SSC (see table 53 in 5.3.3 and table 75 in 5.3.8.1).
COMSAS detect timeout	13.65 μs			The minimum time a receiver device shall allow to detect COMSAS after transmitting COMSAS. Derived from: $OOBI \times 512 \times 40$
^a OOBI is different than UI(OOB) defined in SATA (e.g., SAS has tighter clock tolerance). This is a fixed value equal to the UI for 1.5 Gbps with center-spreading SSC, regardless of the actual transfer rate being used to create the burst time.				

NOTE 36 - Previous versions of this standard defined OOBI based on the nominal UI for 1.5 Gbps with physical link rate long term stability tolerance (see table 53 in 5.3.3) but not with SSC modulation (see table 75 in 5.3.8.1). Interconnects compliant with previous versions of this standard may have assumed phys had that characteristic. To interoperate with interconnects compliant with previous versions of this standard, phys should create OOB burst times and idle times based on the UI for 1.5 Gbps without SSC modulation (e.g., if SSC is disabled, reflecting physical link rate long term stability but not SSC modulation).

6.6.2 Transmitting OOB signals

Table 88 describes the OOB signal transmitter requirements for the burst time, idle time, negation times, and signal times that are used to form each OOB signal.

Table 88 — OOB signal transmitter device requirements

Signal	Burst time	Idle time	Negation time	Signal time ^e
COMWAKE	160 OOBI ^a	160 OOBI ^a	280 OOBI ^b	2 200 OOBI ^g
COMINIT/COMRESET	160 OOBI ^a	480 OOBI ^c	800 OOBI ^d	4 640 OOBI ⁱ
COMSAS	160 OOBI ^a	1 440 OOBI ^f	2 400 OOBI ^h	12 000 OOBI ^j

^a 160 OOBI is nominally 106.6 ns (see table 87).
^b 280 OOBI is nominally 186.6 ns.
^c 480 OOBI is nominally 320 ns.
^d 800 OOBI is nominally 533.3 ns.
^e A signal time is six burst times plus six idle times plus one negation time.
^f 1 440 OOBI is nominally 960 ns.
^g 2 200 OOBI (e.g., COMWAKE) is nominally 1 466.6 ns.
^h 2 400 OOBI is nominally 1 600 ns.
ⁱ 4 640 OOBI (e.g., COMINIT/COMRESET) is nominally 3 093.3 ns.
^j 12 000 OOBI (e.g., COMSAS) is nominally 8 000 ns.

To transmit an OOB signal, the transmitter device shall repeat these steps six times:

- 1) transmit D.C. idle for an idle time; and
- 2) transmit an OOB burst with either starting disparity consisting of D24.3 characters or ALIGN (0) primitives for a burst time. The OOB burst should consist of D24.3 characters.

Change this:
"Derived from:
OOBI × 512 × 40"
to a footnote:
"x 13.686 us is 512 x 40 x' Maximum OOBI."

Author: lsi-gpenokie
Subject: Sticky Note
Date: 6/24/2008 1:47:34 PM

 REJECT (All phys must be able to receive OOB signals that were transmitted with or without SSC. A phy receiving from SATA has always had to accommodate +350/-5350 ppm based incoming OOB signals. SAS-2 just makes +2400/-2400 ppm possible for all phys.

The shortest OOBI based burst time or idle time is 160 OOBI. The transmitter sends:
160 x 665.06 (+2400 ppm) = 106.4106 ns
160 x 666.6 (+0 ppm) = 106.6 ns
160 x 666.6 x 1.001 (-100 ppm) = 106.6783 ns
160 x 666.6 x 1.0024 (-2400 ppm) = 106.93 ns
160 x 666.6 x 1.00535 (-5350 ppm) = 107.2383 ns

These all fall well within the window for idle detect of 101.3 ns to 112 ns. There is only a problem if the interconnect degrades the burst/idles from transmitter to receiver so much that 106.67 ns works (e.g. is greater than 101.3 ns) and 106.93 ns fails (e.g. is less than 101.3 ns) - not very likely.

When SSC was added, the physical WG refused a "shall" rule that phys not supporting SSC transmit with tighter tolerance than those that support SSC. However, a "should" rule made it into NOTE 36 and is being upgraded to normative text per another lsi-gpenokie comment. There's no reason to have a sloppier transmitter just to transmit OOB signals.
)

There appears to be conflicting requirements on OOB signals containing SSC. The table appears to require SSC but SSC is optional and not all devices are required to support it. That is correctly stated in the note. The wording in the table has to change to allow SSC to be optional.

Perhaps moving the note into the table as a footnote and deleting the sentence << Based on 1.5 Gbps clock tolerance with center-spreading SSC (see table 53 in 5.3.3 and table 75 in 5.3.8.1). >> and replacing it with a reference to that footnote would solve the problem.

Author: RElliott
Subject: Underline
Date: 6/30/2008 6:16:52 PM

 ACCEPT - DONE

(e.g., SAS has tighter clock tolerance)
s/b

(e.g., SAS has tighter physical link rate long-term stability and different SSC frequency deviation)

Author: RElliott
Subject: Cross-Out
Date: 6/30/2008 6:16:52 PM

 ACCEPT - DONE

Delete:

"This is a fixed value equal to the UI for 1.5 Gbps with center-spreading SSC, regardless of the actual transfer rate being used to create the burst time."

There is no longer an option to create the OOB burst out of anything except 1.5 Gbps content, so this note is no longer helpful. Also, reword the "Based on" wording to specifically mention "1.5 Gbps UI".

Author: RElliott
Subject: Note
Date: 6/30/2008 6:16:52 PM

 ACCEPT - DONE

Comments from page 225 continued on next page

Table 87 defines the timing specifications for OOB signals.

Table 87 — OOB signal timing specifications

Parameter	Minimum	Nominal	Maximum	Comments
OOB Interval (OOBI) ^a	665.067 ps	666.6 ps	668.267 ps	The time basis for burst times and idle times used to create OOB signals. Based on 1.5 Gbps clock tolerance with center-spreading SSC (see table 53 in 5.3.3 and table 75 in 5.3.8.1).
COMSAS detect timeout	13.65 μs			The minimum time a receiver device shall allow to detect COMSAS after transmitting COMSAS. Derived from: $OOBI \times 512 \times 40$

^a OOBI is different than UI(OOB) defined in SATA (e.g., SAS has tighter clock tolerance). This is a fixed value equal to the UI for 1.5 Gbps with center-spreading SSC, regardless of the actual transfer rate being used to create the burst time.

NOTE 36 - Previous versions of this standard defined OOBI based on the nominal UI for 1.5 Gbps with physical link rate long term stability tolerance (see table 53 in 5.3.3) but not with SSC modulation (see table 75 in 5.3.8.1). Interconnects compliant with previous versions of this standard may have assumed phys had that characteristic. To interoperate with interconnects compliant with previous versions of this standard, phys should create OOB burst times and idle times based on the UI for 1.5 Gbps without SSC modulation (e.g., if SSC is disabled, reflecting physical link rate long term stability but not SSC modulation).

6.6.2 Transmitting OOB signals

Table 88 describes the OOB signal transmitter requirements for the burst time, idle time, negation times, and signal times that are used to form each OOB signal.

Table 88 — OOB signal transmitter device requirements

Signal	Burst time	Idle time	Negation time	Signal time ^e
COMWAKE	160 OOBI ^a	160 OOBI ^a	280 OOBI ^b	2 200 OOBI ^g
COMINIT/COMRESET	160 OOBI ^a	480 OOBI ^c	800 OOBI ^d	4 640 OOBI ⁱ
COMSAS	160 OOBI ^a	1 440 OOBI ^f	2 400 OOBI ^h	12 000 OOBI ^j

^a 160 OOBI is nominally 106.6 ns (see table 87).
^b 280 OOBI is nominally 186.6 ns.
^c 480 OOBI is nominally 320 ns.
^d 800 OOBI is nominally 533.3 ns.
^e A signal time is six burst times plus six idle times plus one negation time.
^f 1 440 OOBI is nominally 960 ns.
^g 2 200 OOBI (e.g., COMWAKE) is nominally 1 466.6 ns.
^h 2 400 OOBI is nominally 1 600 ns.
ⁱ 4 640 OOBI (e.g., COMINIT/COMRESET) is nominally 3 093.3 ns.
^j 12 000 OOBI (e.g., COMSAS) is nominally 8 000 ns.

To transmit an OOB signal, the transmitter device shall repeat these steps six times:

- 1) transmit D.C. idle for an idle time; and
- 2) transmit an OOB burst with either starting disparity consisting of D24.3 characters or ALIGN (0) primitives for a burst time. The OOB burst should consist of D24.3 characters.

Add a footnote:
666.6 equals 2000 / 3.

Some of the math for derived values isn't quite perfect if the decimal value .6 or even .6666666666 is used. Preserving the fraction yields more accurate results.

● Author: lsi-gpenokie
Subject: Highlight
Date: 5/6/2008 4:07:48 PM

T ACCEPT - DONE (converted the To interoperate... part into normal text, followed by a NOTE containing the rest. That makes the "because" portion a NOTE, but the "should" portion normal)

This note << NOTE 36 - Previous versions of >> should not be a note. It should be normative text.

● Author: RElliott
Subject: Highlight
Date: 6/30/2008 6:16:52 PM

T ACCEPT - DONE
long term
s/b
long-term

● Author: RElliott
Subject: Cross-Out
Date: 6/30/2008 6:16:52 PM

~~**T**~~ ACCEPT - DONE

Delete "(e.g., if SSC is disabled, reflecting physical link rate long term stability but not SSC modulation)"

The "if" doesn't make sense. The statement applies in both cases.

● Author: RElliott
Subject: Highlight
Date: 6/30/2008 6:16:52 PM

T ACCEPT - DONE

long term
s/b
long-term

~~NOTE 37 – Transmitter devices compliant with future versions of this standard may not transmit OOB bursts consisting of ALIGN [0] primitives.~~

The transmitter device shall then transmit D.C. idle for an OOB signal negation time.

The transmitter device shall use signal output levels during burst time and idle time as described in 5.3.6.6.

The D24.3 characters or ALIGN (0) primitives used in OOB signals shall be transmitted at 1.5 Gbps. The OOB burst is only required to generate an envelope for the detection circuitry, as required for any signaling that may be A.C. coupled. A burst of D24.3 characters at 1.5 Gbps is equivalent to a square wave pattern that has a one (~~see 6.3.3~~) for 2 OOB1 and a zero (~~see 6.3.3~~) for 2 OOB1. A transmitter may use this square wave pattern for the OOB signal. The start of the pattern may be one or zero. The signal rise and fall times:

- a) shall be greater than (i.e., slower) or equal to the minimum (i.e., fastest) rise and fall times allowed by the fastest supported physical link rate of the transmitter device (see table 58 in 5.3.6.2); and
- b) shall be less than (i.e., faster) or equal to the maximum (i.e., slowest) rise and fall times allowed at 1.5 Gbps.

● Author: Isi-gpenokie
Subject: Cross-Out
Date: 5/6/2008 4:07:48 PM

T REJECT (for SAS-2, we agreed to allow both D24.3 (the newcomer) and ALIGN (0) (the old one) equally, not making the newcomer an instant "should". This note is a warning that a future standard like SAS-2.1 or SAS-3 is probably going to prohibit ALIGN(0), so designs should start migrating to D24.3.)

Since when did we gain the ability to predict the future? This note << NOTE 37 - Transmitter devices compliant with future versions of this standard may not transmit OOB bursts consisting of ALIGN [0] primitives. >> should be deleted.

● Author: wdc-mevans
Subject: Highlight
Date: 5/6/2008 4:07:48 PM

T REJECT (we might come up with something better than D24.3... what we are sure of is ALIGN(0)s are going away.)

not transmit OOB bursts consisting of ALIGN [0] primitives.
s/b
be required to transmit OOB bursts consisting of D24.3 characters.

● Author: RElliott
Subject: Underline
Date: 6/30/2008 6:16:52 PM

T ACCEPT - DONE

ALIGN [0] primitives
s/b
ALIGN (0) primitives

● Author: RElliott
Subject: Cross-Out
Date: 6/30/2008 6:16:52 PM

T ACCEPT - DONE

(see 6.3.3)

● Author: RElliott
Subject: Cross-Out
Date: 6/30/2008 6:16:52 PM

T ACCEPT - DONE

(see 6.3.3)

Figure 136 describes OOB signal transmission by the SP transmitter (see 6.8). The COMWAKE Transmitted, COMINIT Transmitted, and COMSAS Transmitted messages are sent to the SP state machine (see 6.8).

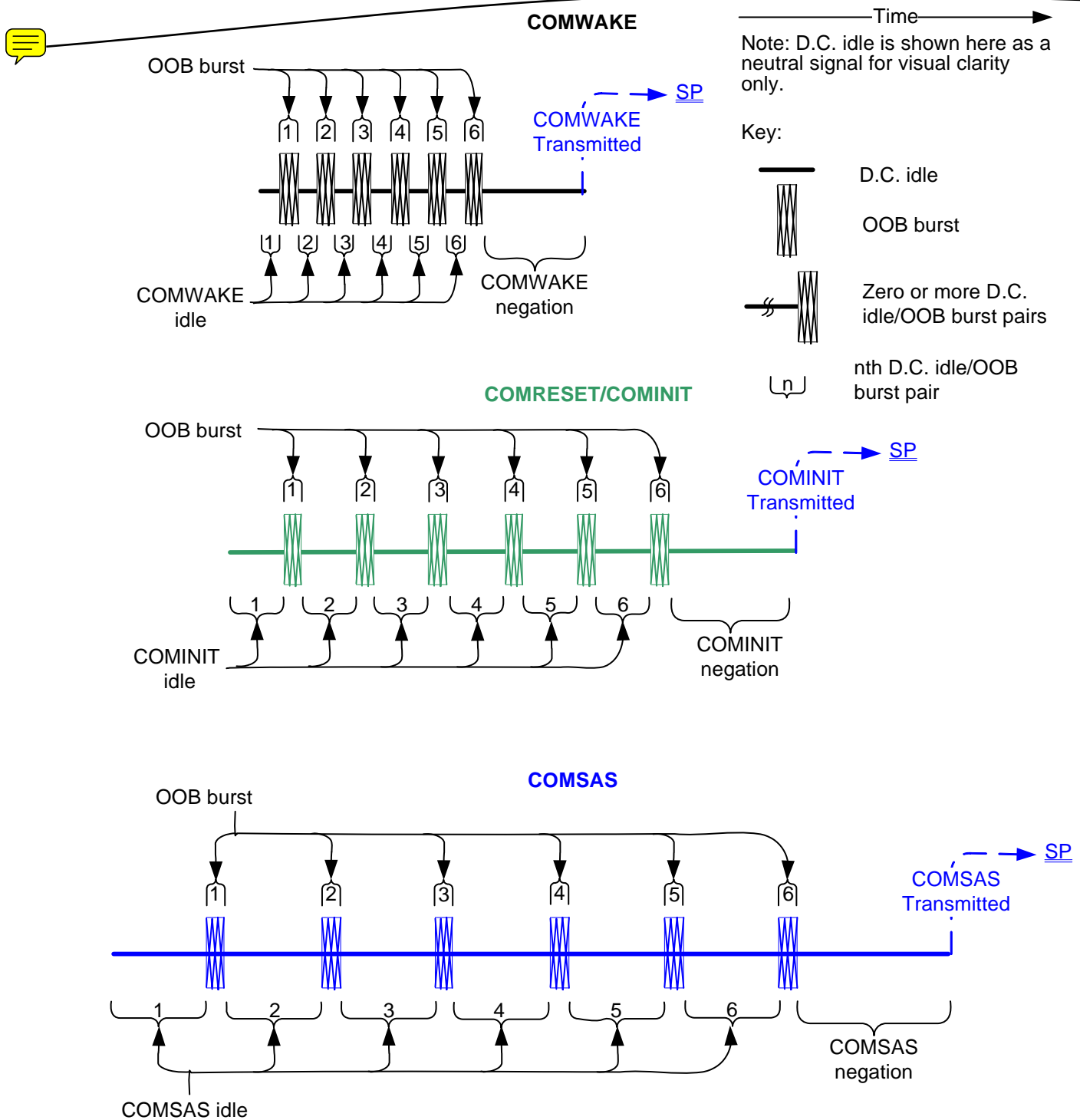



Figure 136 — OOB signal transmission

● Author: RElliott
Subject: Note
Date: 9/1/2008 7:34:20 PM
 ACCEPT - DONE

Move the note to the bottom of the figure

(from Ralph Weber, per ISO editing of SAS-1.1)

6.6.3 Receiving OOB signals

Table 89 describes the OOB signal receiver device requirements for detecting burst times, assuming T_{burst} is the length of the detected burst time. The burst time is not used to distinguish between signals.

Table 89 — OOB signal receiver device burst time detection requirements

Signal	may detect	shall detect
COMWAKE	$T_{burst} \leq 100 \text{ ns}$	$T_{burst} > 100 \text{ ns}$
COMINIT/COMRESET	$T_{burst} \leq 100 \text{ ns}$	$T_{burst} > 100 \text{ ns}$
COMSAS	$T_{burst} \leq 100 \text{ ns}$	$T_{burst} > 100 \text{ ns}$

Table 90 describes the OOB signal receiver device requirements for detecting idle times, assuming T_{idle} is the length of the detected idle time.

Table 90 — OOB signal receiver device idle time detection requirements

Signal	may detect	shall detect	shall not detect
COMWAKE	$35 \text{ ns} \leq T_{idle} < 175 \text{ ns}$	$101.3 \text{ ns} \leq T_{idle} \leq 112 \text{ ns}$	$T_{idle} < 35 \text{ ns}$ or $T_{idle} \geq 175 \text{ ns}$
COMINIT/COMRESET	$175 \text{ ns} \leq T_{idle} < 525 \text{ ns}$	$304 \text{ ns} \leq T_{idle} \leq 336 \text{ ns}$	$T_{idle} < 175 \text{ ns}$ or $T_{idle} \geq 525 \text{ ns}$
COMSAS	$525 \text{ ns} \leq T_{idle} < 1\,575 \text{ ns}$	$911.7 \text{ ns} \leq T_{idle} \leq 1\,008 \text{ ns}$	$T_{idle} < 525 \text{ ns}$ or $T_{idle} \geq 1\,575 \text{ ns}$

Table 91 describes the OOB signal receiver device requirements for detecting negation times, assuming T_{idle} is the length of the detected idle time.

Table 91 — OOB signal receiver device negation time detection requirements

Signal	shall detect
COMWAKE	$T_{idle} > 175 \text{ ns}$
COMINIT/COMRESET	$T_{idle} > 525 \text{ ns}$
COMSAS	$T_{idle} > 1\,575 \text{ ns}$

A receiver device shall detect an OOB signal after receiving four consecutive idle time/burst time pairs (see figure 137) while the SP_DWS state machine (see 6.9) has not achieved dword synchronization (see 6.8.4.9 and 6.8.5.8), and may but should not detect an OOB signal after receiving four consecutive idle time/burst time pairs while the SP_DWS state machine has achieved dword synchronization. It is not an error to receive more than four idle time/burst time pairs. A receiver device shall not detect the same OOB signal again until it has detected the corresponding negation time (e.g., a COMINIT negation time for a COMINIT) or has detected a different OOB signal (e.g., if a receiver device previously detected COMINIT, then receives four sets of COMWAKE idle times followed by burst times, the receiver device detects COMWAKE. The receiver device may then detect COMINIT again).

A SAS receiver device shall detect OOB bursts formed from any of the following:

- a) D24.3 characters at 1.5 Gbps;
- b) ALIGN (0) primitives at 1.5 Gbps; or
- c) ALIGN (0) primitives at 3 Gbps.

NOTE 38 - ALIGN (0) primitives at 3 Gbps provide interoperability with transmitter devices compliant with previous versions of this standard and SATA.

● Author: RElliott
Subject: Note
Date: 6/30/2008 6:16:52 PM
 ACCEPT - DONE

Add table footnote explaining relationship of these receiver device times to the earlier transmitter device times:
Each burst time is transmitted as 160 OOB, which is nominally 106.6 ns (see table 88 in 6.6.2).

● Author: RElliott
Subject: Note
Date: 6/30/2008 6:16:52 PM
 ACCEPT - DONE

Add table footnotes explaining the relationship of these receive times to the transmit times described earlier:

- a) COMWAKE idle time is transmitted as 160 OOB, which is nominally 106.6 ns (see table 88 in 6.6.2).
- b) COMINIT/COMRESET idle time is transmitted as 480 OOB, which is nominally 320 ns.
- c) COMSAS idle time is transmitted as 1 440 OOB, which is nominally 960 ns.

● Author: RElliott
Subject: Note
Date: 6/30/2008 6:16:52 PM
 ACCEPT - DONE

Add table footnotes explaining the relationship of these receive times to the transmit times described earlier:

- a) COMWAKE negation time is transmitted as 280 OOB, which is nominally 186.6 ns (see table 88 in 6.6.2).
- b) COMINIT/COMRESET negation time is transmitted as 800 OOB is nominally 533.3 ns.
- c) COMSAS negation time, which is transmitted as 2 400 OOB, which is nominally 1 600 ns.

● Author: Isi-gpenokie
Subject: Highlight
Date: 5/25/2008 7:16:23 PM
 ACCEPT - DONE (added the commas)

This << and may but should not detect an OOB signal >> should at least be changed to << and may, but should not, detect an OOB signal >> but I would rather see if restated as << and should not detect an OOB signal >>

● Author: RElliott
Subject: Highlight
Date: 6/30/2008 6:16:52 PM
 ACCEPT - DONE

if a receiver device previously detected COMINIT, then receives four sets of COMWAKE idle times followed by burst times, the receiver device detects COMWAKE
s/b

if a receiver device that previously detected COMINIT receives four sets of COMWAKE idle times followed by burst times, then it detects COMWAKE

A SAS receiver device shall not qualify the OOB burst based on the characters received.

Figure 137 describes SAS OOB signal detection by the SP receiver (see 6.8). The COMWAKE Detected, COMWAKE Completed, COMINIT Detected, COMSAS Detected, and COMSAS Completed messages are sent to the SP state machine (see 6.8) to indicate that an OOB signal has been partially or fully detected.

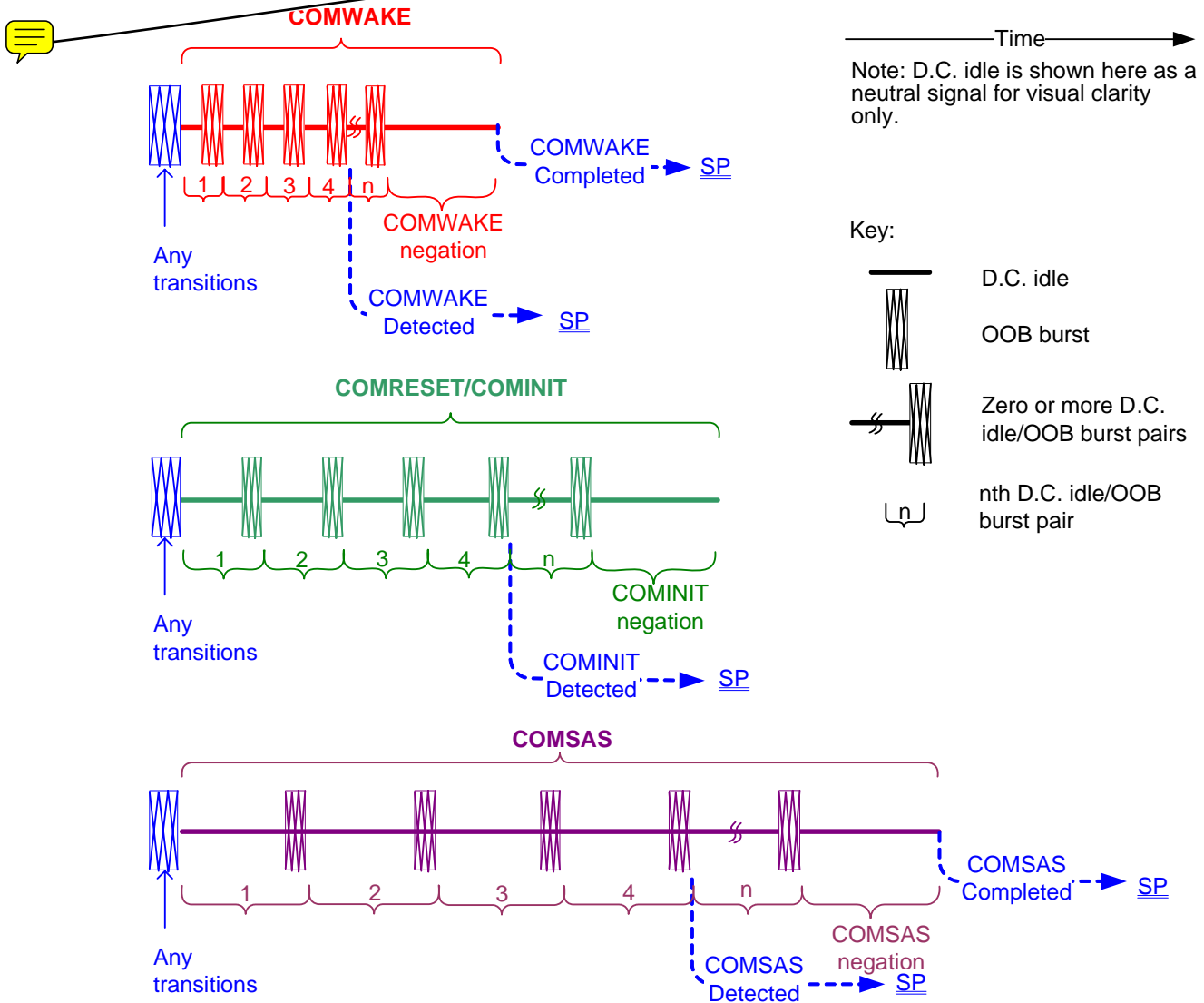



Figure 137 — OOB signal detection

Expander devices shall not forward OOB signals. An expander device shall run the link reset sequence independently on each physical link.

● Author: RElliott

Subject: Note

Date: 9/1/2008 7:18:59 PM

 ACCEPT - DONE

Move the note to the bottom of the figure

(from Ralph Weber, per ISO editing of SAS-1.1)

6.6.4 Transmitting the SATA port selection signal

The SATA port selection signal shown in figure 138 causes the attached SATA port selector to select the attached phy (one of the port selector's host phys) as the active phy (see SATA-2).

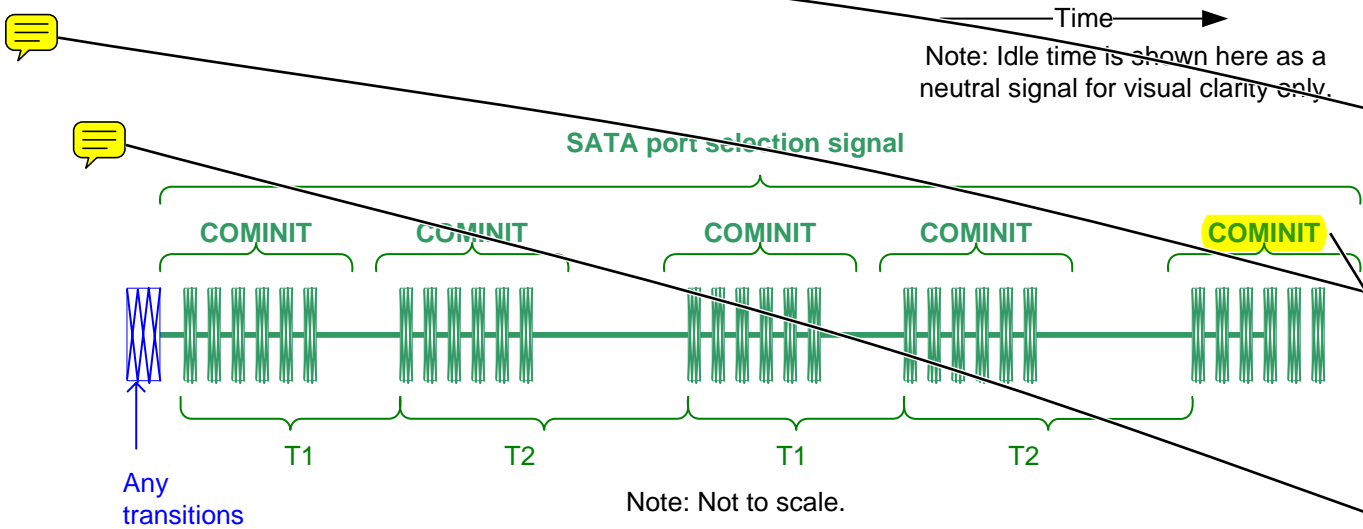

Figure 138 — SATA port selection signal

The SATA port selection signal shall be composed of 5 COMINIT signals, each starting a specified time interval, T1 or T2, as shown in figure 138, after the start of the OOB burst portion of the previous COMINIT signal. The values of T1 and T2 shall be as shown in table 92.

Table 92 — SATA port selection signal transmitter device requirements

Parameter	Time
T1	3×10^6 OOB ^a
T2	12×10^6 OOB ^b

^a 3×10^6 OOB is nominally 2 ms (see table 87).
^b 12×10^6 OOB is nominally 8 ms.

See 6.8.6 and 10.4.3.28 for information on usage of the SATA port selection signal.

6.7 Phy reset sequences

6.7.1 Phy reset sequences overview

The phy reset sequence consists of:

- 1) an OOB sequence (see 6.7.2.1 and 6.7.4.1);
- 2) a speed negotiation sequence (see 6.7.2.2 and 6.7.4.2); and
- 3) if the physical link is a SAS physical link and multiplexing (see 6.10) is enabled (see table 100 in 6.7.4.2.3.3), a multiplexing sequence (see 6.7.4.3).

The phy reset sequence shall only affect the phy, not the port or device containing the phy or other phys in the same port or device.

A phy shall originate a phy reset sequence after:

- a) power on;
- b) hard reset (i.e., receiving a HARD_RESET primitive sequence before an IDENTIFY address frame) (see 4.4.2);

Page: 230

● Author: lsi-gpenokie
Subject: Highlight
Date: 5/25/2008 7:16:47 PM
 REJECT

This << in figure 138 causes the attached SATA port selector to select the >> should be << in figure 138 results in the attached SATA port selector selecting the >>

● Author: lsi-gpenokie
Subject: Highlight
Date: 5/6/2008 4:07:48 PM
 ACCEPT - DONE

This << attached phy (one of the port select >> should be << attached phy (i.e., one of the port select >>

● Author: RElliott
Subject: Note
Date: 9/1/2008 7:14:45 PM
 ACCEPT - DONE

Move the note to the bottom of the figure

(from Ralph Weber, per ISO editing of SAS-1.1)

● Author: RElliott
Subject: Note
Date: 6/30/2008 6:16:52 PM
 ACCEPT - DONE

Turn off Bold text in figure 138 SATA port selection signal

● Author: ktek-dmoore
Subject: Highlight
Date: 5/6/2008 4:07:48 PM
 ACCEPT - DONE
COMINIT

The d.c. idle line in the drawing directly below this word is not complete.

● Author: RElliott
Subject: Underline
Date: 6/30/2008 6:16:52 PM
 ACCEPT - DONE

(see table 87).

s/b

(see table 87 in 6.6.1).

- c) management application layer request (see 6.8.1);
- d) losing dword synchronization and not attempting to re-acquire dword synchronization (see 6.8.4.9 and 6.8.5.8);
- e) Receive Identify Timeout timer expires (see 7.9.4); and
- f) for expander phys, after a hot-plug timeout (see 6.7.5).

A SAS phy may originate a phy reset sequence after a hot-plug timeout (see 6.7.5).

After receiving a HARD_RESET primitive sequence before an IDENTIFY address frame, a phy should start the phy reset sequence within 250 ms.

Table 93 defines phy reset sequence timing parameters used by the SP state machine (see 6.8).

Table 93 — Phy reset sequence timing specifications

Parameter	Minimum	Maximum	Comments
Hot-plug timeout	10 ms	500 ms	The time after which an expander phy shall retry an unsuccessful phy reset sequence, and after which a SAS initiator phy should retry an unsuccessful phy reset sequence (see 6.7.5).

6.7.2 SATA phy reset sequence

6.7.2.1 SATA OOB sequence

Figure 139 shows the SATA OOB sequence between a SATA host and SATA device. The SATA OOB sequence is defined by SATA (see SATA-2 for detailed requirements).

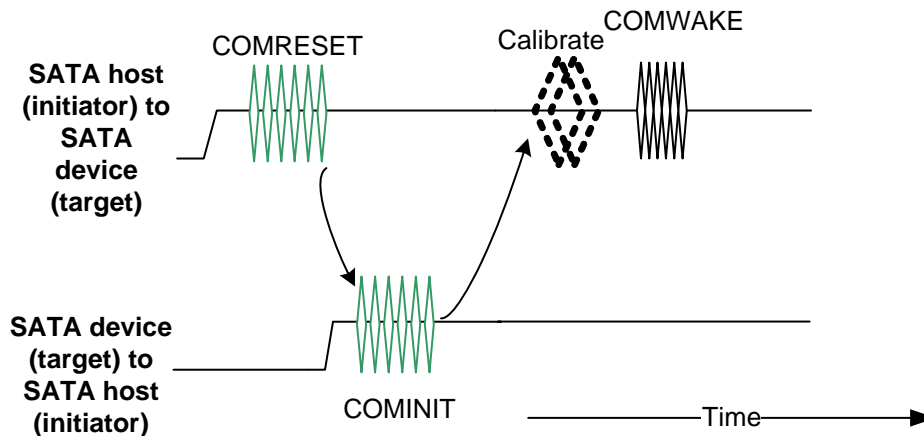

Figure 139 — SATA OOB sequence

● Author: Isi-gpenokie
Subject: Highlight
Date: 5/6/2008 4:07:48 PM

T ACCEPT - DONE

This should be an << or >> as any one of the items in the list will cause a reset sequence.

6.7.2.2 SATA speed negotiation sequence

Figure 140 shows the speed negotiation sequence between a SATA host and SATA device. The SATA speed negotiation sequence is defined by SATA; see SATA-2 for detailed requirements.

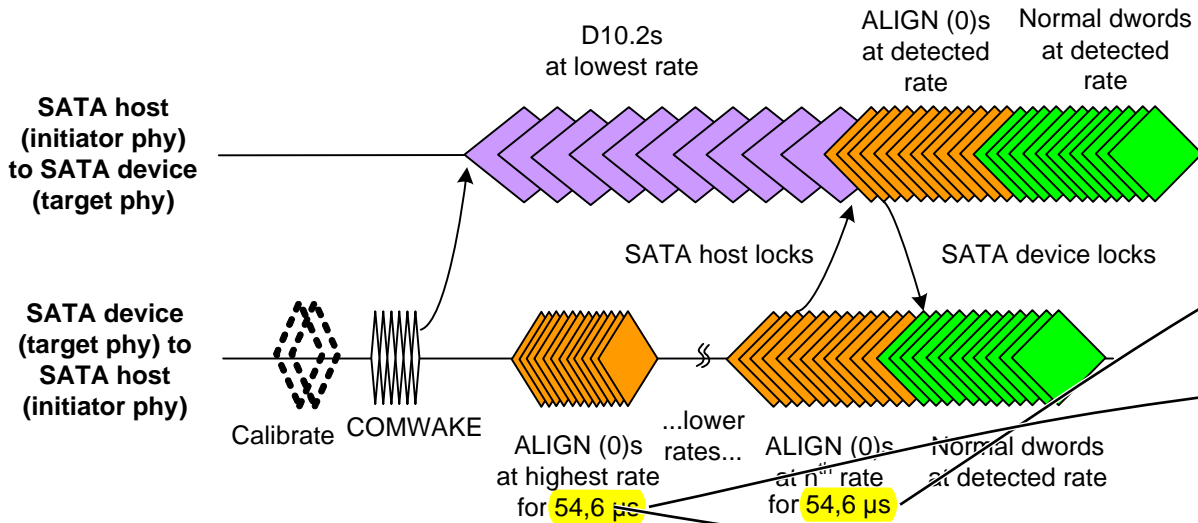

Figure 140 — SATA speed negotiation sequence

Table 94 defines SATA speed negotiation sequence timing parameters used by the SP state machine (see 6.8).

Table 94 — SATA speed negotiation sequence timing specifications

Parameter	Time	Comments
Await ALIGN timeout	1 310 720 OOBIs ^a	The minimum time during SATA speed negotiation that a phy shall allow for an ALIGN (0) to be received after detecting COMWAKE Completed. Derived from: 32 768 × 40 (see SATA-2).
COMWAKE response time	533 ns	The maximum time during SATA speed negotiation after detecting COMWAKE Completed before which a phy shall start transmitting D10.2 characters.
^a 1 310 720 OOBIs is nominally 873.813 μs (see table 87).		

The transmitter device shall use SATA signal output levels during the SATA speed negotiation sequence as described in 5.3.6.6.

6.7.3 SAS to SATA phy reset sequence

SAS initiator phys and expander phys may support SATA (e.g., support being directly attached to a SATA device or a SATA port selector).

To initiate a phy reset sequence a phy shall:

- 1) transmit a COMINIT; and
- 2) in response to receiving a COMINIT, transmit a COMSAS.

The COMSAS identifies the phy as a SAS phy or expander phy instead of a SATA phy.

If a SATA phy is attached to the physical link, it either:

- a) misinterprets the COMSAS to be a COMRESET and responds with a COMINIT; or

● Author: lsi-gpenokie
Subject: Highlight
Date: 5/6/2008 4:07:48 PM
T ACCEPT - DONE ("by SATA." per KnowledgeTek global comment)

This << defined by SATA; see SATA-2 for detailed requirements. >> should be << defined by SATA (see SATA-2). >>

● Author: ktek-dmoore
Subject: Highlight
Date: 6/25/2008 11:32:00 AM
T ACCEPT - DONE
54,6 us
s/b
54.6 us

● Author: ktek-dmoore
Subject: Highlight
Date: 6/25/2008 11:32:22 AM
T ACCEPT - DONE (FrameMaker global regexp searches don't search in Visio files, and Acrobat search doesn't support regexp, so these are hard to find)

54,6 us

I thought the decimal point was back and the comma was banished.
This one and the next one over.

● Author: lsi-bday
Subject: Highlight
Date: 6/25/2008 11:31:21 AM
T ACCEPT - DONE
54,6
s/b
54.6

same elsewhere in diagram

● Author: hpq-relliott
Subject: Highlight
Date: 6/24/2008 11:36:38 AM
T ACCEPT - DONE (SATA 2.6 uses "873.8 us (32768 nominal Gen1 Dwords)". Although maximum OOBI might make more sense than nominal OOBI, that's not what SATA defines. The intention is probably that the clock just run off the transmitter clock, not a separate pure clock source. So, changed to 873.8 us but kept based on the nominal value. Reversed the table footnote and added the word "nominal" in the comments and footnote.

Based on SAS-2 OOBI (+/- 100ppm with +/- 2300 ppm center spreading SSC):

Min (+2400 ppm) = $1310720 * 665.067 = 871.71661813$ us

Nom (+0 ppm) = $1310720 * 666.6 = 873.813$ us

Max (-2400 ppm) = $1310720 * 668.267 = 875.9104853$ us

In SAS-1 (+/- 100 ppm without SSC) that was:

Min (+100 ppm) = $1310720 * 666.6 = 873.725952$ us

Nom (+0 ppm) = $1310720 * 666.6 = 873.513333333$ us

Max (-100 ppm) = $1310720 * 666.733 = 873.90027776$ us

In SATA (with +/- 350 ppm with +/-5000 ppm down-spreading SSC):

Min (+350 ppm) = $1310720 * 666.4333 = 873.507454976$ us

Nom (+0 ppm) = $1310720 * 666.6667 = 873.813$ us

6.7.2.2 SATA speed negotiation sequence

Figure 140 shows the speed negotiation sequence between a SATA host and SATA device. The SATA speed negotiation sequence is defined by SATA; see SATA-2 for detailed requirements.

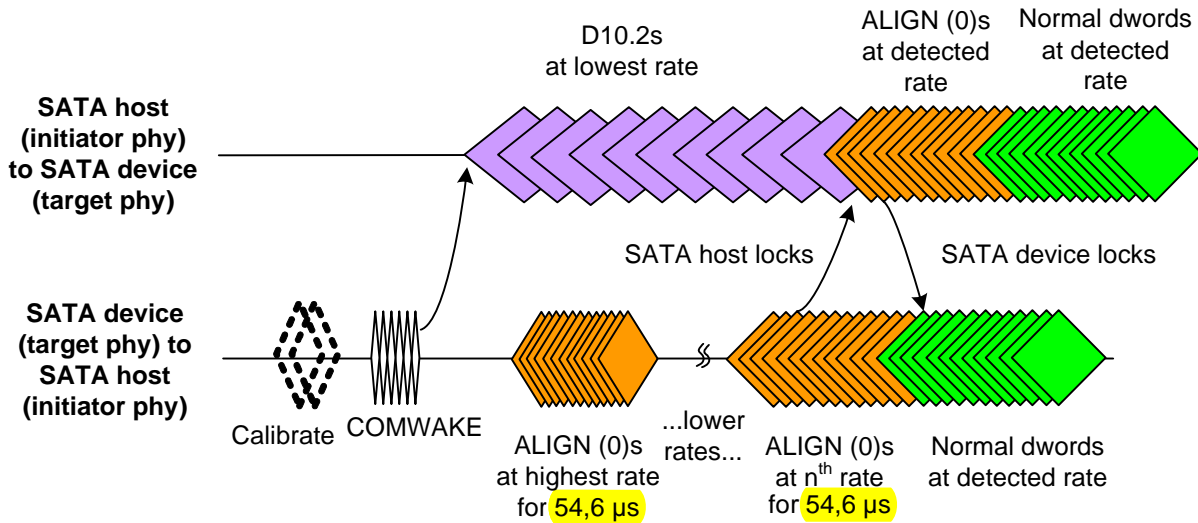

Figure 140 — SATA speed negotiation sequence

Table 94 defines SATA speed negotiation sequence timing parameters used by the SP state machine (see 6.8).

Table 94 — SATA speed negotiation sequence timing specifications

Parameter	Time	Comments
Await ALIGN timeout	1 310 720 OOBIs ^a	The minimum time during SATA speed negotiation that a phy shall allow for an ALIGN (0) to be received after detecting COMWAKE Completed. Derived from: 32 768 × 40 (see SATA-2).
COMWAKE response time	533 ns	The maximum time during SATA speed negotiation after detecting COMWAKE Completed before which a phy shall start transmitting D10.2 characters.

^a 1 310 720 OOBIs is nominally 873.813 μs (see table 87).

The transmitter device shall use SATA signal output levels during the SATA speed negotiation sequence as described in 5.3.6.6.

6.7.3 SAS to SATA phy reset sequence

SAS initiator phys and expander phys may support SATA (e.g., support being directly attached to a SATA device or a SATA port selector).

To initiate a phy reset sequence a phy shall:

- 1) transmit a COMINIT; and
- 2) in response to receiving a COMINIT, transmit a COMSAS.

The COMSAS identifies the phy as a SAS phy or expander phy instead of a SATA phy.

If a SATA phy is attached to the physical link, it either:

- a) misinterprets the COMSAS to be a COMRESET and responds with a COMINIT; or

Max (-5350 ppm) = 1310720 * 670.2333 = 878.488190976 us

So the difference is about 4.675 us.

)

1 310 720 OOB

should be a time value (in us) since this is a receiver timeout value, not a transmitter value.

It should be based on the maximum OOB, allowing the other transmitter the longest legal time to send 32768x40 bits.

Author: RElliott
Subject: Note
Date: 6/30/2008 6:16:52 PM
 ACCEPT - DONE

Add "x nominal OOB" at end of "Derived from: 32768 x 40"

Author: RElliott
Subject: Note
Date: 6/30/2008 6:16:52 PM
 ACCEPT - DONE

Add:
533 ns is 200 x 40 x nominal OOB (see SATA).

as a four note

Author: RElliott
Subject: Underline
Date: 6/30/2008 6:16:52 PM
 ACCEPT - DONE

Merge this footnote:
"a 1 310 720 OOB is nominally 873.813 us (see table 87)."
with the
"Derived from: 32 768 x 40 (see SATA-2)."
line
as:
"a 873.813 us is 32 768 x 40 x nominal OOB (see table 87 in 6.6.1 and SATA)."

Author: intc-mseidel
Subject: Highlight
Date: 6/6/2008 1:46:21 PM
 REJECT (as long as any training sequences in the calibration sequence don't look like COMSAS, no issue should occur. Enough T10 members are participating in Serial ATA that we should be able to ensure that Serial ATA doesn't get confused by COMSAS presence at that time.)

Upcoming SATA phys may have the capability to train their receiver circuitry, especially the new eSATA. In order to exploit this capability, SAS-2 should delay sending COMSAS in order to have time to receive a new OOB pattern (to be defined) that indicates it is talking with a trainable SATA phy. The reception of this new OOB pattern would then trigger a speed and capabilities information exchange with the SATA phy similar to what is done for SAS-2 phys. This is a difficult topic to address, because it has to be accomplished in concert with the SATA specification development. But if we do not make this allowance, then we miss the window of opportunity. Delaying the COMSAS signal by some amount of time will not seriously affect the timeliness of completing the SAS speed negotiation, especially considering the 20 ms of each Train-SNW.

Author: intc-mseidel
Subject: Highlight
Date: 5/6/2008 4:07:48 PM

Comments from page 232 continued on next page

6.7.2.2 SATA speed negotiation sequence

Figure 140 shows the speed negotiation sequence between a SATA host and SATA device. The SATA speed negotiation sequence is defined by SATA; see SATA-2 for detailed requirements.

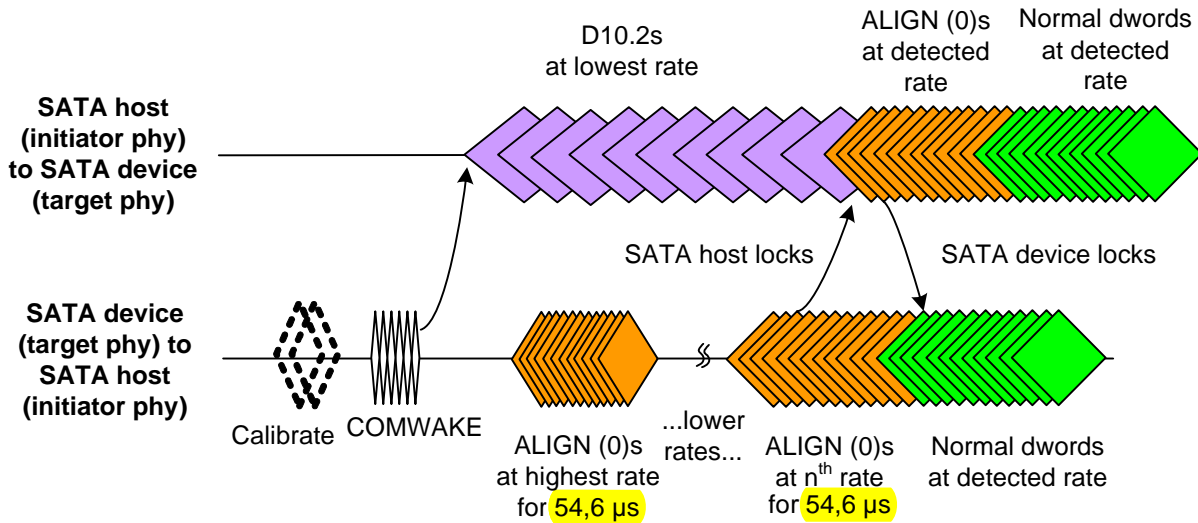

Figure 140 — SATA speed negotiation sequence

Table 94 defines SATA speed negotiation sequence timing parameters used by the SP state machine (see 6.8).

Table 94 — SATA speed negotiation sequence timing specifications

Parameter	Time	Comments
Await ALIGN timeout	1 310 720 OOB _I ^a	The minimum time during SATA speed negotiation that a phy shall allow for an ALIGN (0) to be received after detecting COMWAKE Completed. Derived from: 32 768 × 40 (see SATA-2).
COMWAKE response time	533 ns	The maximum time during SATA speed negotiation after detecting COMWAKE Completed before which a phy shall start transmitting D10.2 characters.
^a 1 310 720 OOB _I is nominally 873.813 μs (see table 87).		

The transmitter device shall use SATA signal output levels during the SATA speed negotiation sequence as described in 5.3.6.6.

6.7.3 SAS to SATA phy reset sequence

SAS initiator phys and expander phys may support SATA (e.g., support being directly attached to a SATA device or a SATA port selector).

To initiate a phy reset sequence a phy shall:

- 1) transmit a COMINIT; and
- 2) in response to receiving a COMINIT, transmit a COMSAS.

The COMSAS identifies the phy as a SAS phy or expander phy instead of a SATA phy.

If a SATA phy is attached to the physical link, it either:

- a) misinterprets the COMSAS to be a COMRESET and responds with a COMINIT; or

T REJECT (targets send COMSAS as well)

Third sentence: "SAS phy or expander phy" s/b "SAS initiator phy or expander phy"

- b) ignores the COMSAS and provides no response within a COMSAS detect timeout.

Either response indicates to the phy that a SATA phy is attached. As a result, the phy shall transmit COMWAKE and enter the SATA speed negotiation sequence (see 6.7.2.2).

Figure 141 shows a reset sequence between a SAS phy or expander phy (i.e., a phy compliant with this standard) and a SATA phy (i.e., a phy in a SATA device, defined by SATA). The two possible cases are presented. The first case is that the SATA phy ignores the COMSAS and provides no response within a COMSAS detect timeout. The second case is that the SATA phy misinterprets the COMSAS to be a COMRESET and responds with a COMINIT. The SP state machine treats these two cases the same, and determines that a SATA phy is attached after a COMSAS detect timeout. The SATA speed negotiation sequence shall be entered after COMWAKE.

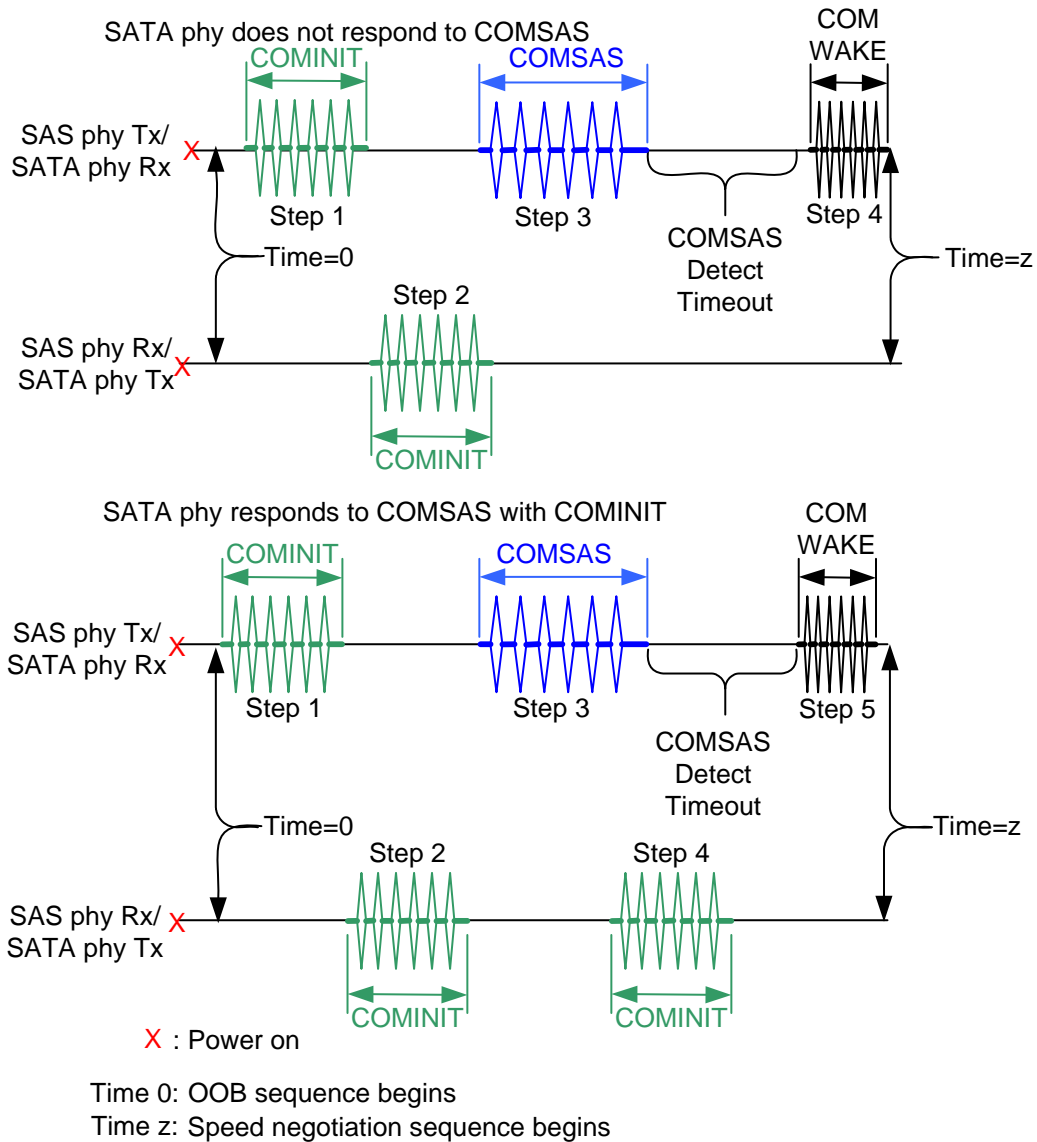

Figure 141 — SAS to SATA OOB sequence

6.7.4 SAS to SAS phy reset sequence

6.7.4.1 SAS OOB sequence

To initiate a SAS OOB sequence a phy shall transmit a COMINIT.

● Author: RElliott
Subject: Highlight
Date: 6/30/2008 6:16:52 PM
T ACCEPT - DONE

a reset sequence
s/b
an OOB sequence

● Author: lsi-gpenokie
Subject: Highlight
Date: 5/6/2008 4:07:48 PM

T ACCEPT - DONE (added "(see 6.8.3.9)" for SP7:AwaitCOMSAS, which is the state that runs the COMSAS Detect Timeout timer and ignores any incoming COMINIT)

Add a reference here to the SP state machine section.

On receipt of a COMINIT a phy shall either:

- a) if the receiving phy has not yet transmitted a COMINIT, transmit a COMINIT followed by a COMSAS;
or
- b) if the receiving phy has transmitted a COMINIT, transmit a COMSAS.

NOTE 39 - If the receiving phy does not respond to a COMINIT within the minimum hot-plug timeout (see 6.7.5), the other phy may transmit another COMINIT. If repeated, this results in a livelock.

On receipt of a COMSAS, if the receiving phy has not yet transmitted a COMSAS, the phy shall transmit a COMSAS.

After completing the transmission of a COMSAS and the successful receipt of a COMSAS the SAS OOB sequence is complete and the SAS speed negotiation sequence begins.

A phy shall distinguish between COMINIT and COMSAS and continue with a SAS speed negotiation sequence (see 6.7.4.2) after completing the SAS OOB sequence.

Page: 234

Author: Isi-gpenokie

Subject: Highlight

Date: 5/6/2008 4:07:48 PM

T REJECT (this is a description of a side-effect, not a rule to be followed. You led the opposition to placing receiver response time limits into the standard in the past, so we are stuck with these implied receiver time limits.)

This note << NOTE 39 - If the receiving phy >> should be normative text.

Author: RElliott

Subject: Highlight

Date: 6/30/2008 6:16:52 PM

T ACCEPT - DONE

this
s/b
then this

Author: RElliott

Subject: Highlight

Date: 6/30/2008 6:16:52 PM

T ACCEPT - DONE

other phy
s/b
attached phy

to match wdc-mevans comments in SP state machine

Author: RElliott

Subject: Highlight

Date: 6/30/2008 6:16:52 PM

T ACCEPT - DONE

the
s/b
then the

Author: RElliott

Subject: Highlight

Date: 6/30/2008 6:16:52 PM

T ACCEPT - DONE

the
s/b
then the

Figure 142 shows several different SAS OOB sequences between phy A and phy B, with phy A starting the SAS OOB sequence at the same time as phy B, before phy B, and before phy B powers on.

Scenario 1: Both SAS phys start SAS OOB sequence at same time

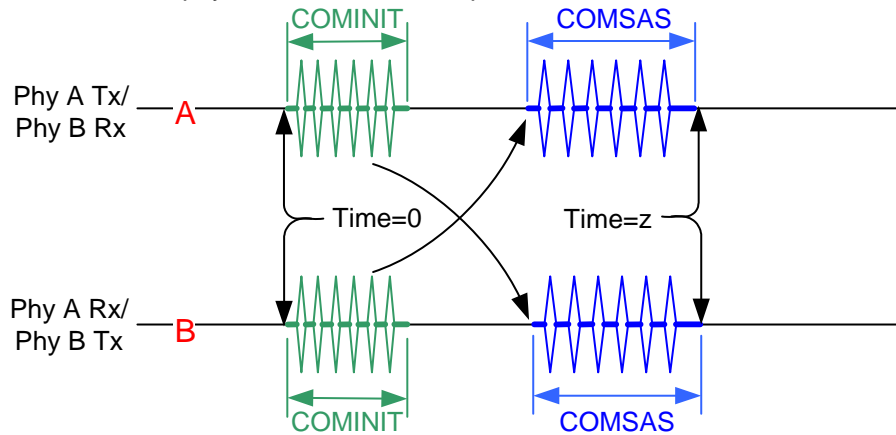

Scenario 2: SAS phy A starts SAS OOB sequence

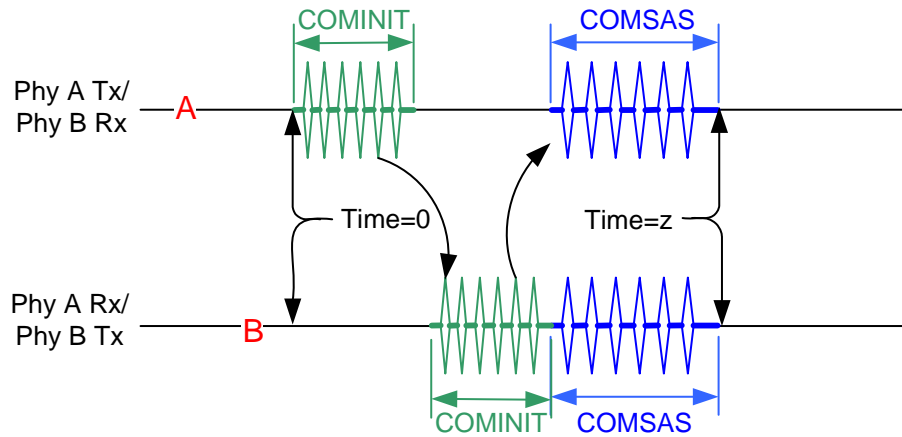

Scenario 3: SAS phy B misses SAS phy A's COMINIT

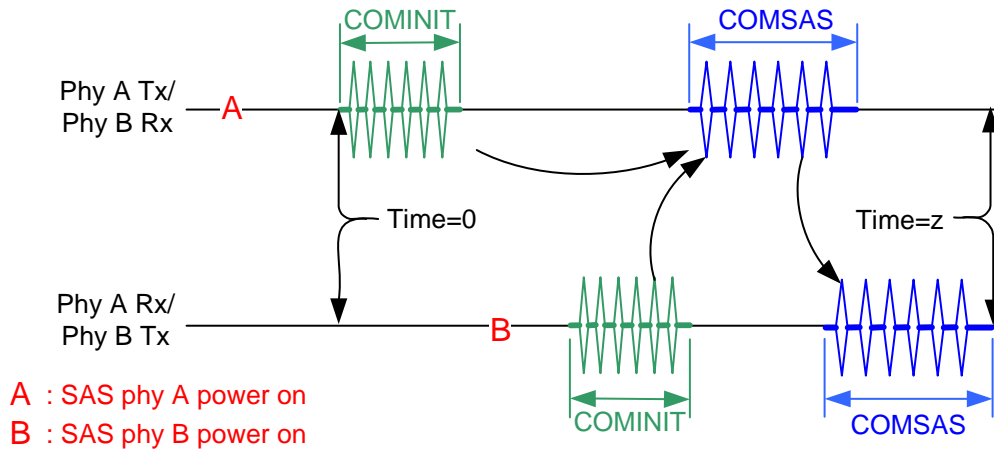

A : SAS phy A power on

B : SAS phy B power on

Time 0: SAS phy reset sequence begins

Time z: SAS speed negotiation sequence begins

Figure 142 — SAS to SAS OOB sequence

This page contains no comments

6.7.4.2 SAS speed negotiation sequence

6.7.4.2.1 SAS speed negotiation sequence overview

The SAS speed negotiation sequence establishes communications between the two phys of a physical link at the highest possible transmission rate.

The SAS speed negotiation sequence is a peer-to-peer negotiation technique that does not assume initiator and target (i.e., ~~host and device~~) roles. The rules for speed negotiation are the same for both participating phys.

The SAS speed negotiation sequence consists of a set of speed negotiation windows (SNWs). Each SNW is identified by a name (e.g., Speed Negotiation Window-1 or SNW-1).

SNWs conform to one of three defined types:

- a) speed negotiation without training: SNW-1, SNW-2 and Final-SNW (see 6.7.4.2.3.2);
- b) phy capabilities exchange: SNW-3 (see 6.7.4.2.3.3); and
- c) speed negotiation with training: Train-SNW (see 6.7.4.2.3.4).

Many of the timing parameters used for defining the SNWs are common to multiple SNW types. All of the timing specifications for all SNW types are defined in 6.7.4.2.2.

A SAS speed negotiation sequence may or may not include all three types of SNWs. Phys may implement a subset of SNWs provided that the subset implements a valid speed negotiation sequence. SAS speed negotiation sequences are defined in 6.7.4.2.4.

The transmitter device shall use SAS signal output levels during the SAS speed negotiation sequence as described in 5.3.6.6.

Author: wdc-mevans

Subject: Cross-Out

Date: 5/6/2008 4:07:48 PM

 REJECT (that's the point of the sentence, to point out to a reader with SATA knowledge that host and device have no meaning.)

(i.e., host and device)

s/b

[Delete these words. Host and device have no meaning for SAS speed negotiation.]

6.7.4.2.2 SAS speed negotiation sequence timing specifications

Table 95 defines the timing specifications for the SAS speed negotiation sequence.

Table 95 — SAS speed negotiation sequence timing specifications

Parameter	Acronym	Time ^a	Comments
Rate change delay time	RCDT	750 000 OOBI ^b	The time the transmitter device shall transmit D.C. idle at the beginning of SNW-1, SNW-2, SNW-3, Final-SNW, and Train-SNW.
Speed negotiation transmit time	SNTT	163 840 OOBI ^c	During SNW-1, SNW-2, and Final-SNW, the time after RCDT during which ALIGN (0) or ALIGN (1) is transmitted. During SNW-3, the time after RCDT in which bit cells and D.C. idle are transmitted.
Speed negotiation lock time	SNLT	153 600 OOBI ^d	The maximum time for a phy to reply with ALIGN (1) during SNW-1, SNW-2, and Final-SNW.
Actual lock time	ALT		The time during SNW-1, SNW-2, and Final-SNW at which actual dword synchronization occurs to the received ALIGN (0) or ALIGN (1) and the phy begins transmitting ALIGN (1) rather than ALIGN (0).
SNW time	SNWT	913 840 OOBI ^e	The duration of SNW-1, SNW-2, SNW-3, or Final-SNW.
Bit cell time	BCT	2 200 OOBI ⁱ	The time to transmit a COMWAKE or D.C. idle during SNW-3.
Maximum training time	MTT	29 998 080 OOBI ^f	The maximum time for training to complete during Train-SNW.
Training lock time	TLT	28 497 920 OOBI ^g	The maximum time for a phy to reply with TRAIN_DONE during Train-SNW.
Actual training time	ATT		The time at which training of the receiver is complete.
Train-SNW time	TWT		The actual duration of Train-SNW.
Maximum Train-SNW time	MTWT	30 748 080 OOBI ^h	The maximum duration of Train-SNW.

^a OOBI is defined in table 87 (see 6.6.1).

^b 750 000 OOBI (e.g., RCDT) is nominally 500 μ s. Equal to: $18\,750 \times 40$.

^c 163 840 OOBI (e.g., SNTT) is nominally 109.226 μ s. Equal to: $4\,096 \times 40$.

^d 153 600 OOBI (e.g., SNLT) is nominally 102.4 μ s. Equal to: $(4\,096 - 256) \times 40$.

^e 913 840 OOBI (e.g., SNWT) is nominally 609.226 μ s. Equal to: RCDT + SNTT.

^f 29 998 080 OOBI (e.g., MTT) is nominally 19.998 719 ms. Equal to: $11\,716 \times 64 \times 40$. This is the time of the maximum number of complete training patterns that fit into 20 ms.

^g 28 497 920 OOBI (e.g., TLT) is nominally 18.998 613 ms. Equal to: $11\,132 \times 64 \times 40$. This is the time of the maximum number of complete training patterns that fit into 19 ms.

^h 30 748 080 OOBI (e.g., MTWT) is nominally 20.498 719 ms. Equal to: RCDT + MTT

ⁱ 2 200 OOBI is nominally 1 466.6 μ s. Equal to the COMWAKE signal time (see table 88 in 6.6.2).

Page: 237

Author: hpq-relliott
Subject: Note
Date: 9/3/2008 6:00:42 PM

 REJECT (
7/08 discussion concluded it's best not to say anything

Add to footnote a:

"A receiver device running a timer based on one of the parameters in this table shall use the maximum OOBI value."

Per discussion with Alvin - leave in OOBI terms, since many of these are also used by the transmitter, but add a footnote explaining that the receiver device shall use the maximum OOBI time when using these values in a timer.

)

Values used in the state machine (COMSAS Detect timeout, AWAIT ALIGN timeout, Hot-Plug Timeout, RCDT, SNLT, SNTT, TLT, and MTT), should be normatively expressed in time values, not OOBIs.

If this phy has a short OOBI and is receiving from another phy which has a long OOBI, this phy needs to allow enough time for the other phy to transmit the desired number of bits.

Author: RElliott
Subject: Underline
Date: 6/30/2008 6:16:52 PM

 ACCEPT - DONE

is complete

s/b

is complete during Train-SNW

Author: RElliott
Subject: Note
Date: 6/30/2008 6:16:52 PM

 ACCEPT - DONE

Add "OOBI" after the end of each of these "Equal to: " sentences just listing numbers.

Author: intc-mseidel
Subject: Highlight
Date: 5/21/2008 7:32:34 PM

 ACCEPT - DONE (Agreed. OOBI of 666.666 ps = 2000/3 ps. $2000 \times 11718 \times 64 \times 40 / 3 = 19.99872$)

The values in Notes f and h should end in "72", not "719(9 repeating)".

Author: intc-mseidel
Subject: Highlight
Date: 5/21/2008 7:32:51 PM

 ACCEPT - DONE (per comment on footnote f)

The values in Notes f and h should end in "72", not "719(9 repeating)".

Author: intc-mseidel
Subject: Highlight
Date: 5/6/2008 4:07:49 PM

 REJECT (that's actually an i, although the small font may make it hard to see on some displays at small zoom levels)

The letter superscripts for Notes ought to proceed alphabetically as one goes down the Table. Note I is out of order.

Author: hpq-relliott
Subject: Highlight

Comments from page 237 continued on next page

6.7.4.2.2 SAS speed negotiation sequence timing specifications

Table 95 defines the timing specifications for the SAS speed negotiation sequence.

Table 95 — SAS speed negotiation sequence timing specifications

Parameter	Acronym	Time ^a	Comments
Rate change delay time	RCDT	750 000 OOBI ^b	The time the transmitter device shall transmit D.C. idle at the beginning of SNW-1, SNW-2, SNW-3, Final-SNW, and Train-SNW.
Speed negotiation transmit time	SNTT	163 840 OOBI ^c	During SNW-1, SNW-2, and Final-SNW, the time after RCDT during which ALIGN (0) or ALIGN (1) is transmitted. During SNW-3, the time after RCDT in which bit cells and D.C. idle are transmitted.
Speed negotiation lock time	SNLT	153 600 OOBI ^d	The maximum time for a phy to reply with ALIGN (1) during SNW-1, SNW-2, and Final-SNW.
Actual lock time	ALT		The time during SNW-1, SNW-2, and Final-SNW at which actual dword synchronization occurs to the received ALIGN (0) or ALIGN (1) and the phy begins transmitting ALIGN (1) rather than ALIGN (0).
SNW time	SNWT	913 840 OOBI ^e	The duration of SNW-1, SNW-2, SNW-3, or Final-SNW.
Bit cell time	BCT	2 200 OOBI ⁱ	The time to transmit a COMWAKE or D.C. idle during SNW-3.
Maximum training time	MTT	29 998 080 OOBI ^f	The maximum time for training to complete during Train-SNW.
Training lock time	TLT	28 497 920 OOBI ^g	The maximum time for a phy to reply with TRAIN_DONE during Train-SNW.
Actual training time	ATT		The time at which training of the receiver is <u>complete</u> .
Train-SNW time	TWT		The actual duration of Train-SNW.
Maximum Train-SNW time	MTWT	30 748 080 OOBI ^h	The maximum duration of Train-SNW.

^a OOBI is defined in table 87 (see 6.6.1).

^b 750 000 OOBI (e.g., RCDT) is nominally 500 μ s. Equal to: 18 750 \times 40.

^c 163 840 OOBI (e.g., SNTT) is nominally 109.226 μ s. Equal to: 4 096 \times 40.

^d 153 600 OOBI (e.g., SNLT) is nominally 102.4 μ s. Equal to: (4 096 - 256) \times 40.

^e 913 840 OOBI (e.g., SNWT) is nominally 609.226 μ s. Equal to: RCDT + SNTT.

^f 29 998 080 OOBI (e.g., MTT) is nominally 19.998 719 ms. Equal to: 11 718 \times 64 \times 40. This is the time of the maximum number of complete training patterns that fit into 20 ms.

^g 28 497 920 OOBI (e.g., TLT) is nominally 18.998 613 ms. Equal to: 11 132 \times 64 \times 40. This is the time of the maximum number of complete training patterns that fit into 19 ms.

^h 30 748 080 OOBI (e.g., MTWT) is nominally 20.498 719 ms. Equal to: RCDT + MTT.

ⁱ 2 200 OOBI is nominally 1 466.6 μ s. Equal to the COMWAKE signal time (see table 88 in 6.6.2).

Date: 6/25/2008 11:33:49 AM

T ACCEPT - DONE

us (micro)

s/b

ns (nano)

● Author: Isi-bday

Subject: Highlight

Date: 6/25/2008 11:33:29 AM

T ACCEPT - DONE

us

s/b

ns

● Author: intc-mseidel

Subject: Highlight

Date: 5/25/2008 3:40:41 PM

T ACCEPT - DONE

The calculation in Note I is incorrect. It should be 1.46(6 repeating) microseconds, not 1466.6(6 repeating).

6.7.4.2.3 Speed negotiation window (SNW) definitions

6.7.4.2.3.1 SNW definitions overview

During each SNW, a phy shall either:

- a) if it supports the SNW, transmit and receive as defined for the SNW; or
- b) if it does not support the SNW, transmit D.C. idle and not receive.

If a phy supports the SNW and receives the expected transmission, then the SNW is valid. If a phy does not receive the expected transmission from the attached phy, then the SNW is invalid.

NOTE 40 - If a phy transmits D.C. idle during a SNW, then the attached phy does not receive the expected transmission and the SNW is invalid.

6.7.4.2.3.2 SNW-1, SNW-2, and Final-SNW

Figure 143 defines SNW-1, SNW-2, and Final-SNW, including:

- a) SNW time (SNWT);
- b) rate change delay time (RCDT);
- c) speed negotiation transmit time (SNTT);
- d) speed negotiation lock time (SNLT); and
- e) actual lock time (ALT).

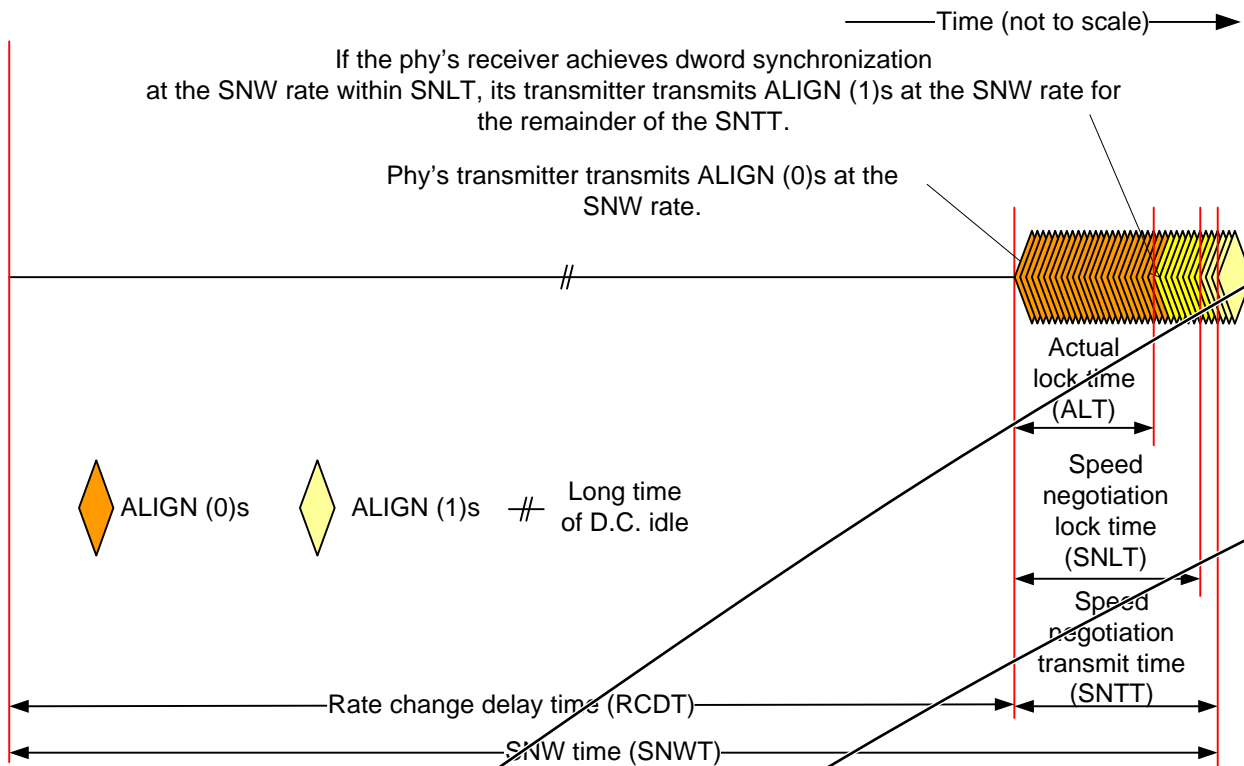

Figure 143 — SNW-1, SNW-2, and Final-SNW

If the phy supports the SNW, it shall transmit:

- 1) D.C. idle for an RCDT; and
- 2) ALIGNs at the SNW rate for the remainder of the SNWT (i.e., for SNTT).

If the phy does not support the SNW, it shall transmit D.C. idle for the entire SNWT.

● Author: intc-mseidel
Subject: Highlight
Date: 6/25/2008 11:07:09 AM

T ACCEPT - DONE (Alvin: "and ignore the SNW information received")

Itemized list element (b) should not dictate that the phy is not to receive, since the state machine transitions are not consistent with a phy possibly being in SP1:Await_COMX while the other phy is transmitting COMWAKES to indicate its capabilities during SNW-3. See related Intel comments in 6.7.4.2.3.

● Author: RElliott
Subject: Highlight
Date: 9/1/2008 7:04:44 PM

T REJECT (
9/1 no disagreement if the definition is carefully read. Leaving as is.

5/5 change "valid" and "invalid" to "successful" and "unsuccessful" when referring to SNWs. Change in all the figures too.)

This usage of "invalid" does not agree with the keyword definition of "invalid".

● Author: lsi-gpenokie
Subject: Highlight
Date: 5/6/2008 4:07:49 PM

T REJECT (this is just providing explanatory information and is NOTE level material)

This note <<NOTE 40 - If a phy >> should be normative text

● Author: RElliott
Subject: Highlight
Date: 6/30/2008 6:16:52 PM

T ACCEPT - DONE

it
s/b
then it

● Author: RElliott
Subject: Highlight
Date: 6/30/2008 6:16:52 PM

T ACCEPT - DONE

it
s/b
then it

Table 96 defines the SNW rate used in SNW-1, SNW-2, and Final-SNW.

Table 96 — SNW rates used in SNW-1, SNW-2, and Final-SNW

SNW	SNW rate
SNW-1	1.5 Gbps
SNW-2	3 Gbps
Final-SNW	Based on SNW-1, SNW-2, and SNW-3 validity: a) 1.5 Gbps if SNW-1 is valid and SNW-2 is invalid; and b) 3 Gbps if SNW-2 is valid and SNW-3 is invalid.

If the phy supports the SNW, it shall attempt to synchronize on an incoming series of dwords at that rate for the SNLT after RCDT. The received dwords may be ALIGN (0) or ALIGN (1) primitives. If the phy achieves dword synchronization within the SNLT, it shall change from transmitting ALIGN (0) primitives to transmitting ALIGN (1) primitives for the remainder of the SNTT (i.e., the remainder of the SNW time). The point at which the phy achieves dword synchronization is called the actual lock time (ALT). If the phy does not achieve dword synchronization within the SNLT, it shall continue transmitting ALIGN (0) primitives for the remainder of the SNTT (i.e., the remainder of the SNW time).

At the end of the SNTT, if a phy is both transmitting and receiving ALIGN (1) primitives, it shall consider the SNW to be valid. If the phy is not both transmitting and receiving ALIGN (1) primitives, it shall consider the SNW to be invalid.

The phy shall disable SSC (see 5.3.8) during SNW-1, SNW-2, and Final-SNW.

6.7.4.2.3.3 SNW-3

SNW-3 allows the phys to exchange phy capabilities to establish phy parameters used in Train-SNW.

Figure 144 defines SNW-3, including:

- a) SNW time (SNWT);
- b) rate change delay time (RCDT); and
- c) speed negotiation transmit time (SNTT).

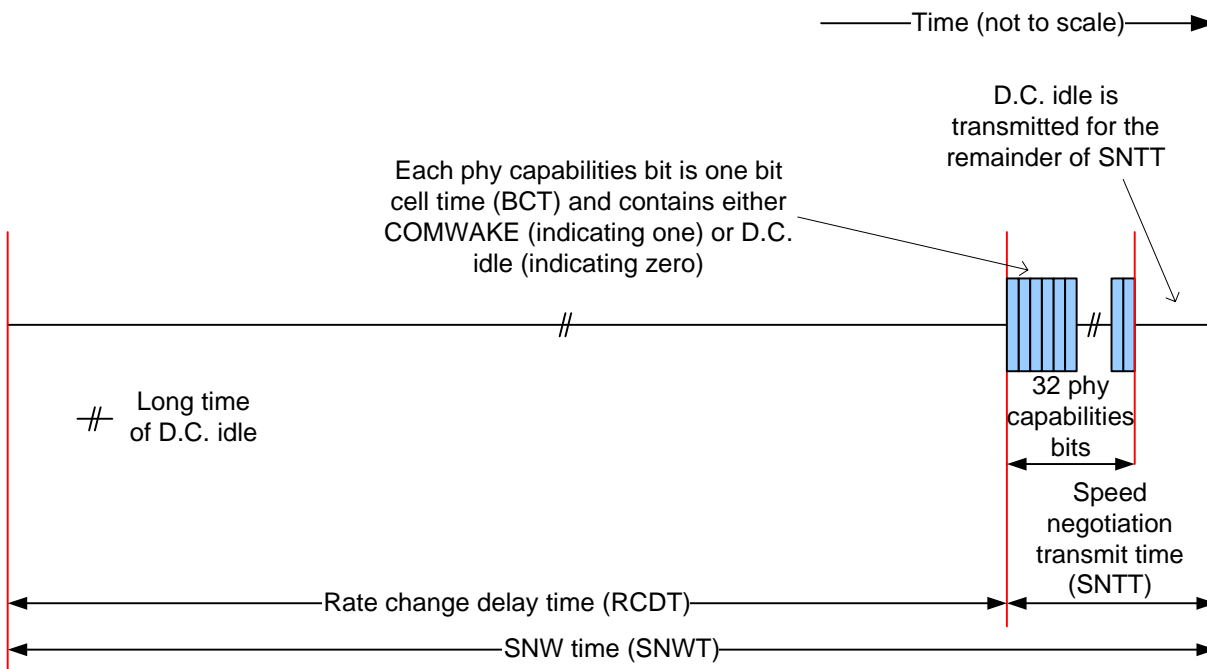



Figure 144 — SNW-3

Page: 239

Author: Isi-gpenokie
Subject: Highlight
Date: 5/6/2008 4:07:49 PM

 ACCEPT - DONE
This should be a << or >> as it is a or b but not both a and b.

Author: wdc-mevans
Subject: Highlight
Date: 5/17/2008 5:35:14 PM

 REJECT (but added "then")
it
s/b
then the phy

Author: wdc-mevans
Subject: Highlight
Date: 5/17/2008 5:35:08 PM

 REJECT (but added "then")
it
s/b
then the phy

Author: Isi-gpenokie
Subject: Sticky Note
Date: 5/17/2008 5:39:31 PM

 ACCEPT - DONE (reworded into two a)b) lists.

If the phy supports the SNW, then after RCDT it shall attempt to attain dword synchronization on an incoming series of dwords (e. g., ALIGN (0) or ALIGN (1) primitives) at that rate for the SNLT:

- a) if the phy achieves dword synchronization within the SNLT, then it shall change from transmitting ALIGN (0) primitives to transmitting ALIGN (1) primitives for the remainder of the SNTT (i.e., the remainder of the SNW time). The point at which the phy achieves dword synchronization is called the actual lock time (ALT); or
- b) if the phy does not achieve dword synchronization within the SNLT, then it shall continue transmitting ALIGN (0) primitives for the remainder of the SNTT (i.e., the remainder of the SNW time).

At the end of the SNTT:

- a) if the phy is both transmitting and receiving ALIGN (1) primitives, then it shall consider the SNW to be valid; or
 - b) if the phy is not both transmitting and receiving ALIGN (1) primitives, then it shall consider the SNW to be invalid.
-)

This would be clearer if it was changed into a 1,2,3 list.

Author: wdc-mevans
Subject: Highlight
Date: 5/17/2008 5:35:03 PM

 REJECT (but added "then")
it
s/b
then the phy

Author: wdc-mevans
Subject: Highlight
Date: 5/17/2008 5:37:08 PM

 REJECT
it
s/b
then the phy

Table 96 defines the SNW rate used in SNW-1, SNW-2, and Final-SNW.

Table 96 — SNW rates used in SNW-1, SNW-2, and Final-SNW

SNW	SNW rate
SNW-1	1.5 Gbps
SNW-2	3 Gbps
Final-SNW	Based on SNW-1, SNW-2, and SNW-3 validity: a) 1.5 Gbps if SNW-1 is valid and SNW-2 is invalid; and b) 3 Gbps if SNW-2 is valid and SNW-3 is invalid.

If the phy supports the SNW, it shall attempt to synchronize on an incoming series of dwords at that rate for the SNLT after RCDT. The received dwords may be ALIGN (0) or ALIGN (1) primitives. If the phy achieves dword synchronization within the SNLT, it shall change from transmitting ALIGN (0) primitives to transmitting ALIGN (1) primitives for the remainder of the SNTT (i.e., the remainder of the SNW time). The point at which phy achieves dword synchronization is called the actual lock time (ALT). If the phy does not achieve dword synchronization within the SNLT, it shall continue transmitting ALIGN (0) primitives for the remainder of the SNTT (i.e., the remainder of the SNW time).

At the end of the SNTT, if a phy is both transmitting and receiving ALIGN (1) primitives, it shall consider the SNW to be valid. If the phy is not both transmitting and receiving ALIGN (1) primitives, it shall consider the SNW to be invalid.

The phy shall disable SSC (see 5.3.8) during SNW-1, SNW-2, and Final-SNW.

6.7.4.2.3.3 SNW-3

SNW-3 allows the phys to exchange phy capabilities to establish phy parameters used in Train-SNW.

Figure 144 defines SNW-3, including:

- a) SNW time (SNWT);
- b) rate change delay time (RCDT); and
- c) speed negotiation transmit time (SNTT).

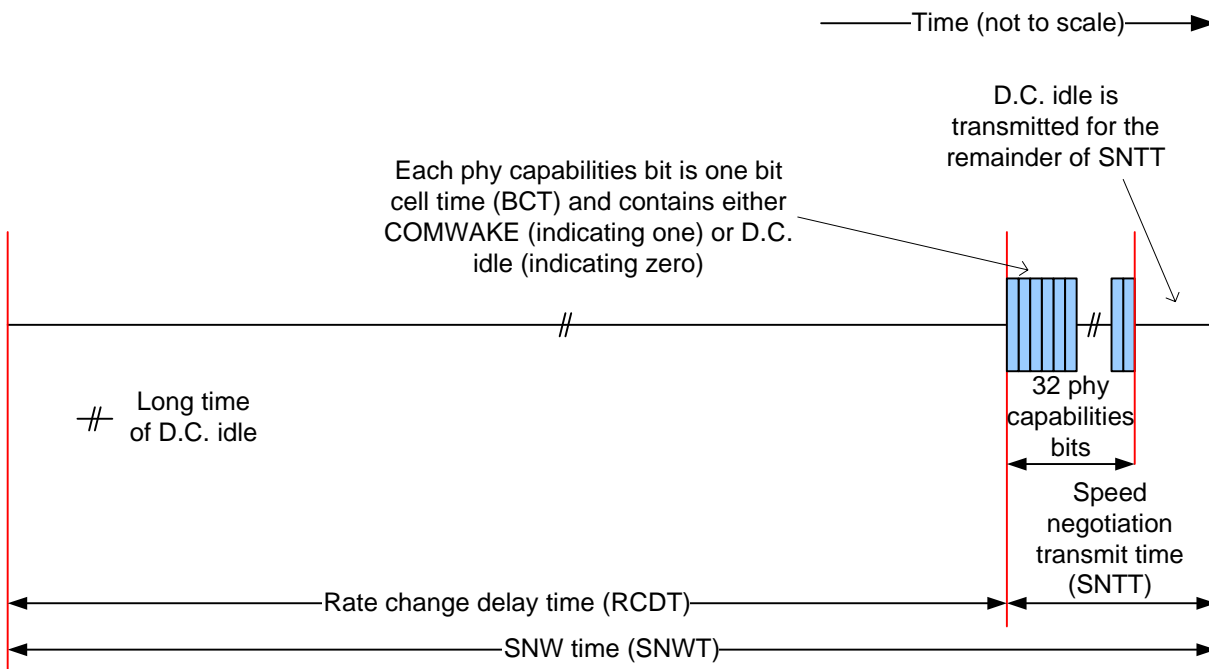

Figure 144 — SNW-3

Author: wdc-mevans
Subject: Highlight
Date: 5/17/2008 5:36:54 PM

TREJECT

it
s/b
then the phy

Author: intc-mseidel
Subject: Highlight
Date: 6/24/2008 8:03:17 PM

TREJECT (Common clock architectures are a bad idea - avoid if possible. Negotiation of 1.5 Gbps or 3 Gbps with SSC is possible via SNW-3; trying to do so during SNW-1 and SNW-2 just invites legacy compatibility problems. There is no reliable hot-plug indication upon which the phy can rely.)

The last sentence is a serious issue for common-clock architectures. They ought to be able to use SSC especially if it has been negotiated on previously and there has not been a hot-plug event, since the other phys on the common clock have it on and the phy that is connected to it has handled SSC previously. It should also be OK to utilize SSC during SNW-1/2/Final; an attached receiver that responds with ALIGN(1) can obviously handle the SSC in the datastream.

Table 97 defines the content of each phy capabilities bit.

Table 97 — SNW-3 phy capabilities bit

Value	Transmitted
One	COMWAKE (see 6.6)
Zero	D.C. idle

If the phy supports SNW-3, it shall:

- 1) transmit D.C. idle for an RCDT;
- 2) transmit 32 phy capabilities bits; and
- 3) transmit D.C. idle for the remainder of SNWT,

and shall receive a 32-bit phy capabilities value from the attached phy. If the attached phy does not support SNW-3, the phy capabilities bits are all set to zero (i.e., D.C. idle).

If the phy does not support SNW-3, the phy shall transmit D.C. idle for the entire SNWT and ignore any SNW-3 phy capabilities bits received.

The first phy capabilities bit is the START bit and is set to one. Each of the remaining 31 phy capabilities bits is set to one or zero. The receiver shall use the START bit to detect the beginning of the phy capabilities bits.

The phy shall consider SNW-3 to be valid if it supports SNW-3 and receive at least one phy capabilities bit set to one. If the phy does not support SNW-3 or does not receive at least one phy capabilities bit set to one, it shall consider SNW-3 to be invalid.

The phy may transmit with SSC enabled or disabled (see 5.3.8) during SNW-3.

Table 98 defines the SNW-3 phy capabilities. For each bit defined as reserved, the phy shall transmit a zero (i.e., D.C. idle) and shall ignore the received value. Byte 0 shall be transmitted first and byte 3 shall be transmitted last. Within each byte, bit 7 shall be transmitted first and bit 0 shall be transmitted last (e.g., overall, the START bit is transmitted first and the PARITY bit is transmitted last).

Table 98 — SNW-3 phy capabilities

Byte/Bit	7	6	5	4	3	2	1	0
0	START (1b)	TX SSC TYPE	Reserved		REQUESTED LOGICAL LINK RATE			
1	Supported settings						Reserved	
	G1 WITHOUT SSC	G1 WITH SSC	G2 WITHOUT SSC	G2 WITH SSC	G3 WITHOUT SSC	G3 WITH SSC		
2	Reserved							
3	Reserved							PARITY

~~The START bit shall be set to one. The phy's receiver shall use this bit to establish the timing for the subsequent bits.~~

A TX SSC TYPE bit set to one indicates that the phy's transmitter uses center-spreading SSC when SSC is enabled (e.g., the phy is an expander phy)(see 5.3.8). A TX SSC TYPE bit set to zero indicates that the phy's transmitter uses down-spreading SSC when SSC is enabled (e.g., the phy is a SAS phy), or that the phy does not support SSC.

NOTE 41 - The phy receiver may use the TX SSC TYPE bit to optimize its CDR circuitry.

Page: 240

Author: RElliott
Subject: Highlight
Date: 6/30/2008 6:16:52 PM

T ACCEPT - DONE
it
s/b
then it

Author: lsi-gpenokie
Subject: Highlight
Date: 8/27/2008 4:22:31 PM

T ACCEPT - DONE (7/15 make it into a two-level list.

5/08 receive is concurrent with transmit, so this item 4 would not necessarily happen after item 3. This is not worthy of a two-level nested list)

This << and shall receive a 32-bit phy capabilities value from the attached phy. >> should be the 4th entry in the list.

Author: RElliott
Subject: Highlight
Date: 6/30/2008 6:16:52 PM

T ACCEPT - DONE
the
s/b
then the

Author: intc-mseidel
Subject: Highlight
Date: 8/31/2008 8:29:02 PM

T ACCEPT - DONE (08-283 incorporated to address the SATA port selector issue. Also see hpq-relliott comment on PDF pg 245 about the port selector problem)

Sentence starting with "If the phy does not support SNW-3,..." does not fit with the SP state machine. If such a phy follows the state machine transitions and is talking with a 6G-only phy then it may enter SP1:Await_COMX and identify the incoming SNW-3 COMWAKE as a SATA port selector.

Author: lsi-bday
Subject: Highlight
Date: 5/6/2008 4:07:49 PM

T REJECT (Each ... is are both singular)
is
s/b
are

Author: lsi-bday
Subject: Highlight
Date: 5/25/2008 3:44:16 PM

T REJECT (the "shall" is in the paragraph below the table)
is
s/b
shall be

Author: lsi-bday
Subject: Highlight
Date: 5/25/2008 3:45:10 PM

T ACCEPT - DONE

Comments from page 240 continued on next page

Table 97 defines the content of each phy capabilities bit.

Table 97 — SNW-3 phy capabilities bit

Value	Transmitted
One	COMWAKE (see 6.6)
Zero	D.C. idle

If the phy supports SNW-3, it shall:

- 1) transmit D.C. idle for an RCDT;
- 2) transmit 32 phy capabilities bits; and
- 3) transmit D.C. idle for the remainder of SNTT,

and shall receive a 32-bit phy capabilities value from the attached phy. If the attached phy does not support SNW-3, the phy capabilities bits are all set to zero (i.e., D.C. idle).

If the phy does not support SNW-3, the phy shall transmit D.C. idle for the entire SNWT and ignore any SNW-3 phy capabilities bits received.

The first phy capabilities bit is the START bit and is set to one. Each of the remaining 31 phy capabilities bits is set to one or zero. The receiver shall use the START bit to detect the beginning of the phy capabilities bits.

The phy shall consider SNW-3 to be valid if it supports SNW-3 and receive at least one phy capabilities bit set to one. If the phy does not support SNW-3 or does not receive at least one phy capabilities bit set to one, it shall consider SNW-3 to be invalid.

The phy may transmit with SSC enabled or disabled (see 5.3.8) during SNW-3.

Table 98 defines the SNW-3 phy capabilities. For each bit defined as reserved, the phy shall transmit a zero (i.e., D.C. idle) and shall ignore the received value. Byte 0 shall be transmitted first and byte 3 shall be transmitted last. Within each byte, bit 7 shall be transmitted first and bit 0 shall be transmitted last (e.g., overall, the START bit is transmitted first and the PARITY bit is transmitted last).

Table 98 — SNW-3 phy capabilities

Byte/Bit	7	6	5	4	3	2	1	0
0	START (1b)	TX SSC TYPE	Reserved		REQUESTED LOGICAL LINK RATE			
1	Supported settings							Reserved
	G1 WITHOUT SSC	G1 WITH SSC	G2 WITHOUT SSC	G2 WITH SSC	G3 WITHOUT SSC	G3 WITH SSC		
2	Reserved							
3	Reserved							PARITY

~~The START bit shall be set to one. The phy's receiver shall use this bit to establish the timing for the subsequent bits.~~

A TX SSC TYPE bit set to one indicates that the phy's transmitter uses center-spreading SSC when SSC is enabled (e.g., the phy is an expander phy)(see 5.3.8). A TX SSC TYPE bit set to zero indicates that the phy's transmitter uses down-spreading SSC when SSC is enabled (e.g., the phy is a SAS phy), or that the phy does not support SSC.

NOTE 41 - The phy receiver may use the TX SSC TYPE bit to optimize its CDR circuitry.

The receiver shall use the START bit to detect the beginning of the phy capabilities bits....

add

"...and establish the timing for the subsequent bits."

● Author: lsi-bday
Subject: Highlight
Date: 5/6/2008 4:07:49 PM

T ACCEPT - DONE
receive
s/b
receives

● Author: ktek-dmoore
Subject: Highlight
Date: 5/6/2008 4:07:49 PM

T ACCEPT - DONE
receive
s/b receives

● Author: wdc-mevans
Subject: Highlight
Date: 5/25/2008 3:42:29 PM

T REJECT (first noun/subject convention, but added then)
it
s/b
then the phy

● Author: lsi-bday
Subject: Cross-Out
Date: 5/25/2008 3:45:54 PM

T REJECT (after a table defining fields, there must be a paragraph describing each one. However, will delete the second sentence, and merge that into the paragraph above the table about the usage of the START bit.)

The START bit shall be set to one. The phy's receiver shall use this bit to establish the timing for the subsequent bits.

● Author: RElliott
Subject: Highlight
Date: 6/30/2008 6:16:52 PM

T ACCEPT - DONE
set to one
s/b
set to the value defined in table 98

The REQUESTED LOGICAL LINK RATE field indicates if the phy supports multiplexing (see 6.10) and, if so, the logical link rate that the phy is requesting. If the phy is managed by an SMP target port, the field is based on the REQUESTED LOGICAL LINK RATE field in the SMP PHY CONTROL function (see 10.4.3.28).

Table 99 defines the requested logical link rate based on the transmitted and received REQUESTED LOGICAL LINK RATE fields.

Table 99 — Requested logical link rate

Transmitted REQUESTED LOGICAL LINK RATE field	Received REQUESTED LOGICAL LINK RATE field	Requested logical link rate
0h (i.e., no multiplexing)	Any	Negotiated physical link rate
8h (i.e., 1.5 Gbps)	8h (i.e., 1.5 Gbps)	1.5 Gbps
	9h (i.e., 3 Gbps)	
	Ah (i.e., 6 Gbps)	
	Bh - Fh (i.e., future rates)	
9h (i.e., 3 Gbps)	8h (i.e., 1.5 Gbps)	1.5 Gbps
	9h (i.e., 3 Gbps)	3 Gbps
	Ah (i.e., 6 Gbps)	
	Bh - Fh (i.e., future rates)	
Ah (i.e., 6 Gbps)	8h (i.e., 1.5 Gbps)	1.5 Gbps
	9h (i.e., 3 Gbps)	3 Gbps
	Ah (i.e., 6 Gbps)	6 Gbps
	Bh - Fh (i.e., future rates)	

Table 100 defines whether or not multiplexing is enabled and defines the negotiated logical link rate based on the requested logical link rate (see table 99) and the negotiated physical link rate (see 6.7.4.2.4).

Table 100 — Multiplexing negotiation

Requested logical link rate (see table 99)	Negotiated physical link rate	Multiplexing	Negotiated logical link rate
1.5 Gbps	1.5 Gbps	Disabled	1.5 Gbps
	3 Gbps	Enabled	1.5 Gbps
	6 Gbps		3 Gbps
3 Gbps	1.5 Gbps	Disabled	1.5 Gbps
	3 Gbps		3 Gbps
	6 Gbps	Enabled	3 Gbps
6 Gbps	1.5 Gbps	Disabled	1.5 Gbps
	3 Gbps		3 Gbps
	6 Gbps		6 Gbps
Negotiated physical link rate	1.5 Gbps	Disabled	1.5 Gbps
	3 Gbps		3 Gbps
	6 Gbps		6 Gbps

Author: RElliott
Subject: Highlight
Date: 6/30/2008 6:16:52 PM
ACCEPT - DONE

T

the
s/b
then the

The supported settings bits include the G1 WITHOUT SSC bit, the G1 WITH SSC bit, the G2 WITHOUT SSC bit, the G2 WITH SSC bit, the G3 WITHOUT SSC bit, and the G3 WITH SSC bit.

A G1 WITHOUT SSC bit set to one indicates that the phy supports G1 (i.e., 1.5 Gbps) without SSC. A G1 WITHOUT SSC bit set to zero indicates that the phy does not support G1 without SSC. If the phy supports SNW-1 and supports SNW-3, then the G1 WITHOUT SSC bit shall be set to one.

A G1 WITH SSC bit set to one indicates that the phy supports G1 (i.e., 1.5 Gbps) with SSC. A G1 WITH SSC bit set to zero indicates that the phy does not support G1 with SSC.

A G2 WITHOUT SSC bit set to one indicates that the phy supports G2 (i.e., 3 Gbps) without SSC. A G2 WITHOUT SSC bit set to zero indicates that the phy does not support G2 without SSC. If the phy supports SNW-2 and supports SNW-3, then the G2 WITHOUT SSC bit shall be set to one.

A G2 WITH SSC bit set to one indicates that the phy supports G2 (i.e., 3 Gbps) with SSC. A G2 WITH SSC bit set to zero indicates that the phy does not support G2 with SSC.

A G3 WITHOUT SSC bit set to one indicates that the phy supports G3 (i.e., 6 Gbps) without SSC. A G3 WITHOUT SSC bit set to zero indicates that the phy does not support G3 without SSC.

A G3 WITH SSC bit set to one indicates that the phy supports G3 (i.e., 6 Gbps) with SSC. A G3 WITH SSC bit set to zero indicates that the phy does not support G3 with SSC.

Table 101 defines the priority of the supported settings bits.

Table 101 — Supported settings bit priorities

Priority	Bit
Highest	G3 WITH SSC bit
...	G3 WITHOUT SSC bit
...	G2 WITH SSC bit
...	G2 WITHOUT SSC bit
...	G1 WITH SSC bit
Lowest	G1 WITHOUT SSC bit

~~If none of the transmitted supported settings bits are equal to their corresponding received supported settings bits, then the phy shall consider a phy reset problem (see 6.7.4.2.4) to have occurred.~~

The PARITY bit provides for error detection of all the SNW-3 phy capabilities bits. The PARITY bit shall be set to one or zero such that the total number of SNW-3 phy capabilities bits that are set to one is even, including the START bit and the PARITY bit. If the PARITY bit received is incorrect based upon the received SNW phy capabilities bits, then the parity is bad and the phy shall consider a phy reset problem (see 6.7.4.2.4) to have occurred.

Author: RElliott
Subject: Cross-Out
Date: 6/30/2008 6:16:52 PM
 ACCEPT - DONE

Delete:

"If none of the transmitted supported settings bits are equal to their corresponding received supported settings bits, then the phy shall consider a phy reset problem (see 6.7.4.2.4) to have occurred."

This is untrue now that the UNSUPPORTED_PHY_ATTACHED value is defined. See related lsi-bday comment on page 246.

Table 102 lists some example SNW-3 phy capabilities values.

Table 102 — Example SNW-3 phy capabilities values

Code ^a	Description
80540000h	Down-spreading SSC G1, G2, and G3 with SSC supported
80FC0001h	Down-spreading SSC G1, G2, and G3 with and without SSC supported
80A80000h	G1, G2, and G3 without SSC supported
C0FC0000h	Center-spreading SSC G1, G2, and G3 with and without SSC supported
C9FC0000h	Center-spreading SSC Requested 3 Gbps logical link rate G1, G2, and G3 with and without SSC supported
C8F00001h	Center-spreading SSC Requested 1.5 Gbps logical link rate G1 and G2 with and without SSC supported
^a Expressed as a 32-bit value with bit 0 (i.e., the START bit) as the MSB and bit 31 as the LSB (i.e., the PARITY bit).	

6.7.4.2.3.4 Train-SNW

Figure 145 defines the Train-SNW, including:

- a) maximum Train-SNW window time (MTWT);
- b) rate change delay time (RCDT);
- c) maximum train time (MTT);
- d) train lock time (TLT); and

Author: RElliott
Subject: Highlight
Date: 7/12/2008 3:37:58 PM
ACCEPT - DONE

bit 0 (i.e., the START bit) as the MSB and bit 31 as the LSB

s/b

byte 0 bit 7 (i.e., the START bit) as the MSB and byte 3 bit 0 as the LSB

since the phy capabilities bits are now described as a 4-byte structure, not a series of 32 bits numbered 0 through 31

e) actual training time (ATT).

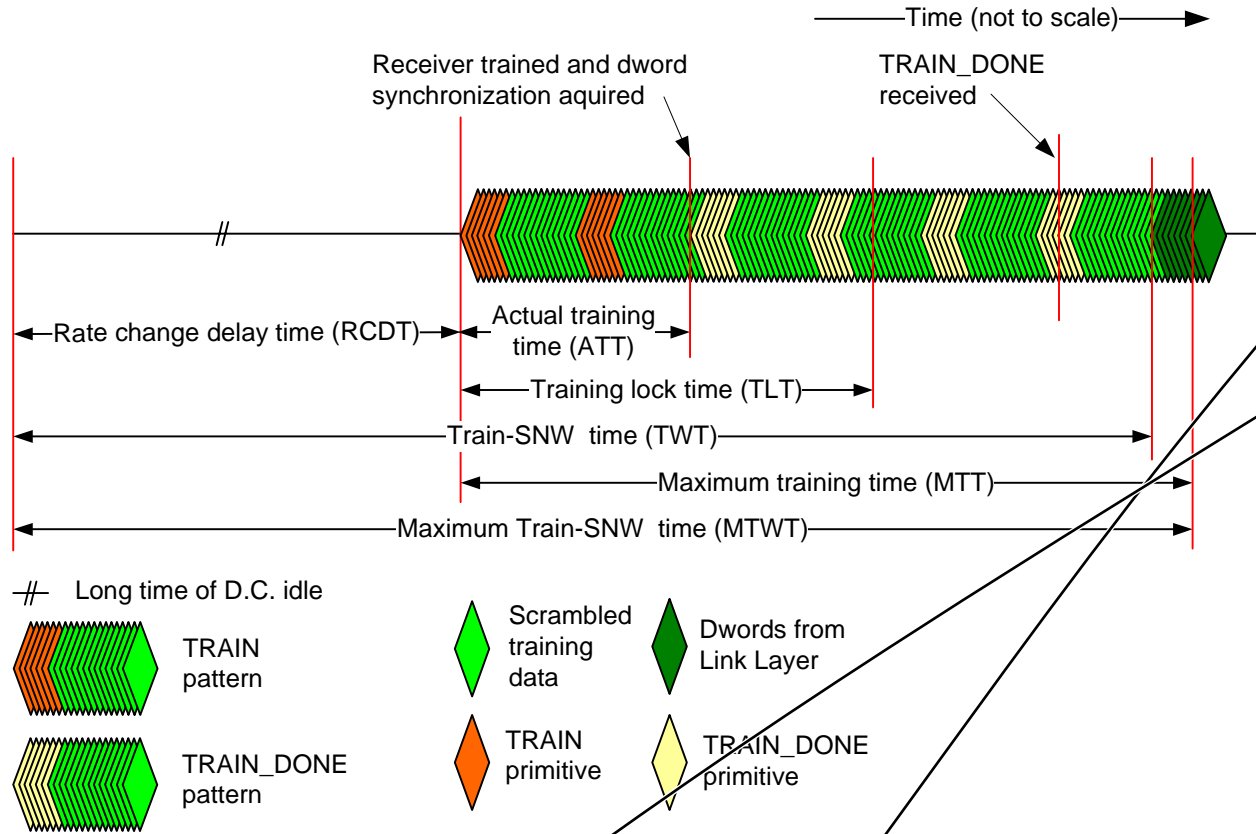

Figure 145 — Train-SNW

The Train-SNW utilizes TRAIN and TRAIN_DONE (see 7.2) to create training patterns, defined in table 103.

Table 103 — Training patterns

Training pattern	Description
TRAIN pattern	Sequence of: 1) TRAIN primitive sequence; and 2) 58 dwords set to 00000000h that are transmitted scrambled and 8b10b encoded.
TRAIN_DONE pattern	Sequence of: 1) TRAIN_DONE primitive sequence; and 2) 58 dwords set to 00000000h that are transmitted scrambled and 8b10b encoded.

The scrambler is the same as that defined for the link layer (see 7.6) and shall be initialized at the end of RCDT. The scrambler shall not be re-initialized for the remainder of the Train-SNW.

The phy shall start transmitting TRAIN patterns at the end of RCDT. The first TRAIN pattern may have either starting disparity. The number of TRAIN patterns transmitted is determined by the time required for the phy's receiver to complete training and acquire dword synchronization. The phy shall transmit at least one TRAIN pattern.

If the phy's receiver is trained and acquires dword synchronization before TLT, then the phy shall stop transmitting TRAIN patterns and start transmitting TRAIN_DONE patterns. The phy shall transmit a minimum of four TRAIN_DONE patterns.

If the phy:

- a) transmits four or more TRAIN_DONE patterns; and

Author: hpq-relliott
Subject: Highlight
Date: 5/6/2008 4:07:49 PM
T ACCEPT - DONE

reword sentence as:
forms training patterns using ...

Author: pmcs-tsymons
Subject: Note
Date: 5/19/2008 10:14:06 AM

T ACCEPT - DONE (yes, transmission of a TRAIN/TRAIN_DONE pattern should be consider atomic and not interrupted. Adding "after completing transmission of the current TRAIN [or TRAIN_DONE] pattern" in two places.)

When a receiver detects either TRAIN or TRAIN_DONE the text is unclear whether the transmitter should complete transmitting an entire TRAIN or TRAIN_DONE pattern, or if it should immediately start to transmit the next state pattern (after transmitting only a partial TRAIN or TRAIN_DONE pattern).

I believe that the intention is that a pattern should always be transmitted in it's entirety before transitioning to the next state. The following text includes suggested changes (in blue) to clarify the text.

6.7.4.2.3.4 Train-SNW

...

The Train-SNW utilizes TRAIN and TRAIN_DONE (see 7.2) to create training patterns, defined in table 103.

-----Table 103 -----

<<add: Each pattern shall be completely transmitted before another pattern or primitive is started. >>

The scrambler is the same as that defined for the link layer (see 7.6) and shall be initialized at the end of RCDT. The scrambler shall not be re-initialized for the remainder of the Train-SNW.

The phy shall start transmitting TRAIN patterns at the end of RCDT. The first TRAIN pattern may have either starting disparity. The number of TRAIN patterns transmitted is determined by the time required for the phy's receiver to complete training and acquire dword synchronization. The phy shall transmit at least one TRAIN pattern.

If the phy's receiver is trained and acquires dword synchronization before TLT, then the phy shall stop transmitting TRAIN patterns and start transmitting TRAIN_DONE patterns. The phy shall transmit a minimum of four TRAIN_DONE patterns.

If the phy:

- a) transmits four or more TRAIN_DONE patterns; and
- b) receives a minimum of one TRAIN_DONE before MTT,

then the phy shall:

- a) stop transmitting TRAIN_DONE patterns << add: when the current pattern is complete; >>
- b) start transmitting dwords from the link layer; and
- c) consider the Train-SNW to be valid.

If the phy does not receive TRAIN_DONE before MTT and transmit four or more TRAIN_DONE patterns, then it shall consider the Train-SNW to be invalid.

Author: intc-mseidel
Subject: Highlight
Date: 5/19/2008 10:15:24 AM

T REJECT (the point of the training sequence is not to provide a precise sequence of known bits that the receiver examines one-by-one. The point is to provide wide spectral content that helps a DFE tune quickly and generally - similar to the tuning it continues to use after training completes, but without worry (yet) that bit errors will cause problems. Either starting disparity suffices for that purpose. The fact that the scrambling continues across the data for all the patterns bolsters this; the first bits are unlikely to be received properly, so the receiver would have trouble doing a bit-by-bit comparison.)

The training sequence is not unique due to an unknown initial running disparity and an unspecified treatment of the random scrambled data during the TRAIN and TRAIN_DONE primitives. The paragraph following Table 103 should add something like "The scrambler shall not run during TRAIN or TRAIN_DONE primitives; the bit pattern produced during the Train-SNW window shall be the same as a continuous scrambled data pattern with TRAIN and TRAIN_DONE primitives inserted at the proper positions." In addition, the next paragraph (second sentence) should change "pattern may have either starting disparity" to "pattern shall start with positive running disparity".

e) actual training time (ATT).

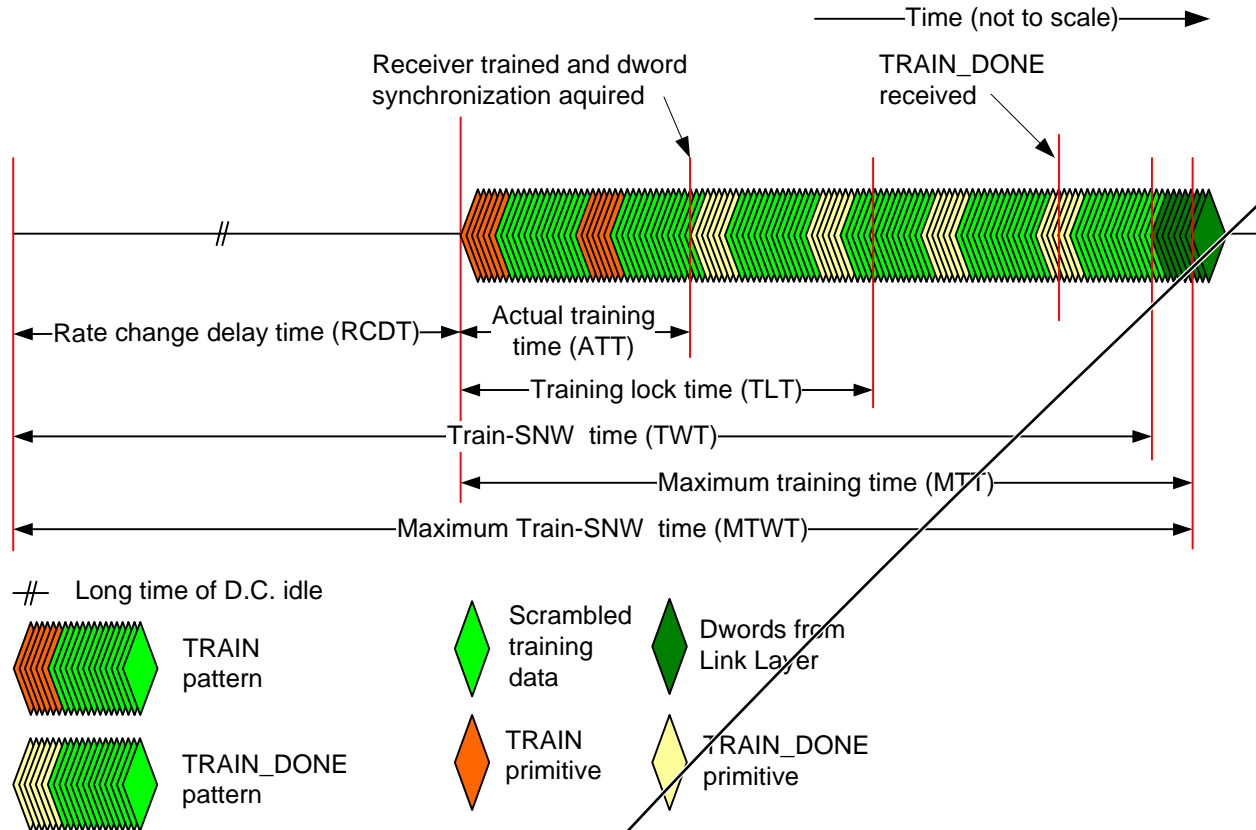

Figure 145 — Train-SNW

The Train-SNW utilizes TRAIN and TRAIN_DONE (see 7.2) to create training patterns, defined in table 103.

Table 103 — Training patterns

Training pattern	Description
TRAIN pattern	Sequence of: 1) TRAIN primitive sequence; and 2) 58 dwords set to 00000000h that are transmitted scrambled and 8b10b encoded.
TRAIN_DONE pattern	Sequence of: 1) TRAIN_DONE primitive sequence; and 2) 58 dwords set to 00000000h that are transmitted scrambled and 8b10b encoded.

The scrambler is the same as that defined for the link layer (see 7.6) and shall be initialized at the end of RCDT. The scrambler shall not be re-initialized for the remainder of the Train-SNW.

The phy shall start transmitting TRAIN patterns at the end of RCDT. The first TRAIN pattern may have either starting disparity. The number of TRAIN patterns transmitted is determined by the time required for the phy's receiver to complete training and acquire dword synchronization. The phy shall transmit at least one TRAIN pattern.

If the phy's receiver is trained and acquires dword synchronization before TLT, then the phy shall stop transmitting TRAIN patterns and start transmitting TRAIN_DONE patterns. The phy shall transmit a minimum of four TRAIN_DONE patterns.

If the phy:

- a) transmits four or more TRAIN_DONE patterns; and

Author: hpq-relliott

Subject: Note

Date: 5/19/2008 10:01:12 AM

 ACCEPT - DONE (as "The phy shall not perform pattern comparison on the data dwords in the training pattern.")

The phy shall not perform pattern comparison on the incoming TRAIN pattern and TRAIN_DONE pattern to train and acquire dword synchronization.

b) receives a minimum of one **TRAIN_DONE** before MTT,
then the phy shall:

- a) stop transmitting TRAIN_DONE patterns;
- b) start transmitting dwords from the link layer; and
- c) consider the Train-SNW to be valid.

If the phy does not receive **TRAIN_DONE** before MTT and **transmit** four or more TRAIN_DONE patterns, then it shall consider the Train-SNW to be invalid.

6.7.4.2.4 SAS speed negotiation sequence

The SAS speed negotiation sequence consists of a set of SNWs (see 6.7.4.2.3) in the order shown in figure 146.

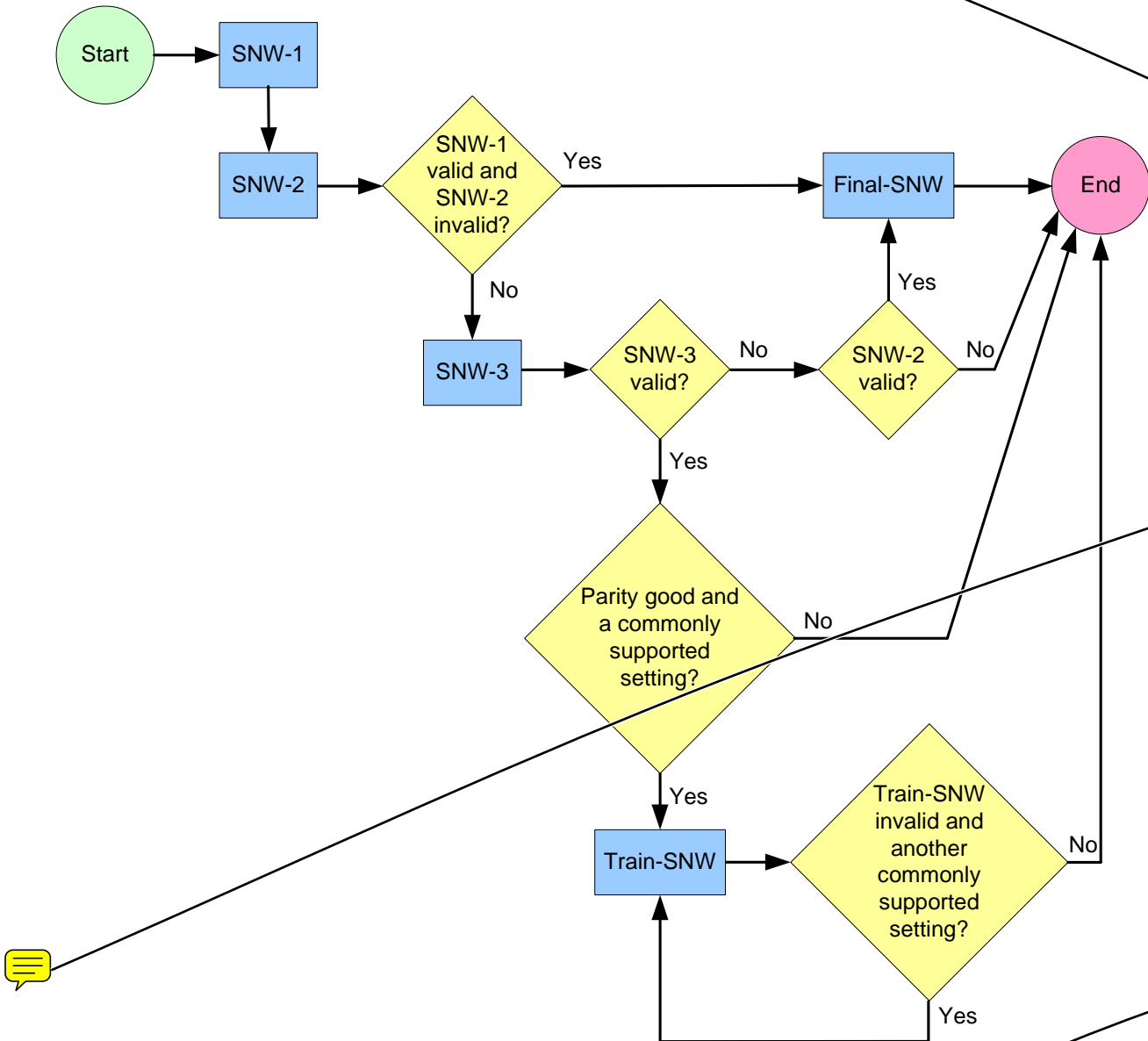

Figure 146 — SAS speed negotiation sequence SNW flowchart

Train-SNW is based on the highest untried commonly supported settings based on the outgoing and incoming SNW-3 supported settings bits (see 6.7.4.2.3).

Page: 245

Author: RElliott
Subject: Highlight
Date: 6/30/2008 6:16:52 PM
ACCEPT - DONE

TRAIN_DONE
s/b
TRAIN_DONE primitive sequence

to clarify that a full TRAIN_DONE pattern is not needed

Author: ktek-dmoore
Subject: Highlight
Date: 5/6/2008 4:07:49 PM
ACCEPT - DONE ("transmits")
transmit

s/b "transmits" or "has transmitted"

Author: RElliott
Subject: Highlight
Date: 6/30/2008 6:16:52 PM
ACCEPT - DONE

TRAIN_DONE
s/b
TRAIN_DONE primitive sequence

to clarify that a full TRAIN_DONE pattern is not needed

Author: hpq-relliott
Subject: Note
Date: 8/27/2008 5:15:32 PM
ACCEPT - DONE (7/14 incorporate 08-283r1 to resolve (SATA port selector issue))

If a phy A that only supports SNW-1 is attached to a phy B that only supports SNW-3, phy A runs:
OOB, SNW-1 (yes) SNW-2 (no), and back to OOB
while phy B runs:
OOB, SNW-1 (no), SNW-2 (no), SNW-3 (yes), and back to OOB.

Since the SNW-3 involves COMWAKE, phy A interprets this as receiving a COMWAKE in response to its COMINIT, which falsely identifies a SATA port selector. Phy A's ATTACHED SATA PORT SELECTOR bit will be set incorrectly in the SMP DISCOVER response.

When phy B runs SNW-1 again and sends COMINIT, that should cause phy A to realize that a SAS device is attached, not a SATA device. However, they may keep repeating this forever.

In 7.11, rule d) causes a Broadcast (Change) when that bit toggles from 0 to 1, so infinite Broadcast (Changes) will result at the hot-plug timeout intervals.

Author: intc-mseidel
Subject: Highlight
Date: 5/19/2008 10:26:27 AM

REJECT (this flowchart just shows the possible orders in which the SNWs are performed. Once they are all performed, whether it was considered successful or not is beyond the scope of the flowchart.)

This figure should indicate where the phy reset problems occur, and an additional decision diamond should be added between the Final-SNW box and the End circle.

Comments from page 245 continued on next page

If a Train-SNW is invalid and there are additional, untried, commonly supported settings exchanged during SNW-3, then a new Train-SNW shall be performed based on the next highest, untried, commonly supported settings.

A phy reset problem occurs if:

- a) ~~after SNW-3, if SNW-1, SNW-2, and SNW-3 are all invalid;~~
- b) after Final-SNW, if Final-SNW is invalid;
- c) ~~after SNW-3, if SNW-3 is valid and:~~
 - A) the parity is bad; or
 - B) ~~there are no commonly supported settings;~~
- or
- d) after a Train-SNW, if the Train-SNW is invalid and there are no additional, untried, commonly supported settings.

Phy reset problems terminate the SAS speed negotiation sequence and are counted and reported in the PHY **RESET PROBLEM COUNT** field in the SMP REPORT PHY ERROR LOG page (see 10.4.3.11) and the Protocol-Specific Port log page (see 10.2.8.1).

Figure 147 shows speed negotiation between a phy A and phy B where phys participate in:

- 1) SNW-1, supported by phy A but not by phy B;
- 2) SNW-2, supported by both phys;
- 3) SNW-3, supported by phy A but not by phy B; and
- 4) Final-SNW negotiating 3 Gbps.

Phy A and phy B detect:

- a) SNW-1 invalid;
- b) SNW-2 valid; and
- c) SNW-3 invalid,

● Author: Isi-bday
Subject: Highlight
Date: 5/6/2008 4:07:49 PM
T ACCEPT - DONE
settings
s/b
setting

● Author: RElliott
Subject: Cross-Out
Date: 6/30/2008 6:16:52 PM
T ACCEPT - DONE
if

● Author: RElliott
Subject: Cross-Out
Date: 6/30/2008 6:16:52 PM
T ACCEPT - DONE

Delete "after SNW-3, if SNW-1, SNW-2, and SNW-3 are all invalid;" to remedy hpq-relliott comment

● Author: hpq-relliott
Subject: Note
Date: 5/19/2008 5:40:08 PM
ACCEPT - DONE (Deleting row a). The state machine transitions from SP14:SAS_Fail to SP8:SAS_Start, which chooses the UNSUPPORTED_PHY_ATTACHED VALUE and transitions to SP1:OOB_COMINIT.

(Deleting row c)B), which also results in the UNSUPPORTED_PHY_ATTACHED value. See Isi-bday comment. Deleted one other sentence related to that incorrect notion.)

Failure to find any supported speed (either by row a) or by row c)B)) is not supposed to be a phy reset problem; that just means two incompatible devices are attached, which is not the same as a broken device being attached or the link having reliability problems (the original meaning). That could be counted with a new counter.

● Author: Isi-gpenokie
Subject: Cross-Out
Date: 6/25/2008 11:09:59 AM
T REJECT (the "and:" is conjoining the phrase "if SNW-3 is valid" with the A)B) list. Either A or B can be chosen. The "or" is conjoining a)b)c)d). An Isi-bday comment gets rid of B) - if that is accepted, then this will become simpler, but the "and" will remain)

This << and >> should be deleted as right now it reads << and: or >>

● Author: Isi-bday
Subject: Cross-Out
Date: 5/19/2008 4:51:30 PM
T ACCEPT - DONE (also added comment on page 242 to delete a sentence with similar intentions)

there are no commonly supported settings

This case is an UNSUPPORTED_PHY_ATTACHED in SP state machine now. So not a reset problem.

● Author: RElliott
Subject: Highlight
Date: 6/30/2008 6:16:52 PM
T ACCEPT - DONE
PHY RESET PROBLEM COUNT field
s/b
smallcaps

If a Train-SNW is invalid and there are additional, untried, commonly supported settings exchanged during SNW-3, then a new Train-SNW shall be performed based on the next highest, untried, commonly supported settings.

A phy reset problem occurs if:

- 
- a) ~~after SNW-3, if SNW-1, SNW-2, and SNW-3 are all invalid;~~
 - b) after Final-SNW, if Final-SNW is invalid;
 - c) after SNW-3, if SNW-3 is valid ~~and:~~
 - A) the parity is bad; or
 - B) ~~there are no commonly supported settings;~~
- or
- d) after a Train-SNW, if the Train-SNW is invalid and there are no additional, untried, commonly supported settings.

Phy reset problems terminate the SAS speed negotiation sequence and are counted and reported in the PHY RESET PROBLEM COUNT field in the SMP REPORT PHY ERROR LOG page (see 10.4.3.11) and the Protocol-Specific Port log page (see 10.2.8.1).

Figure 147 shows speed negotiation between a phy A and phy B where phys participate in:

- 1) SNW-1, supported by phy A but not by phy B;
- 2) SNW-2, supported by both phys;
- 3) SNW-3, supported by phy A but not by phy B; and
- 4) Final-SNW negotiating 3 Gbps.

Phy A and phy B detect:

- a) SNW-1 invalid;
- b) SNW-2 valid; and
- c) SNW-3 invalid,

and proceed to Final-SNW negotiating 3 Gbps.

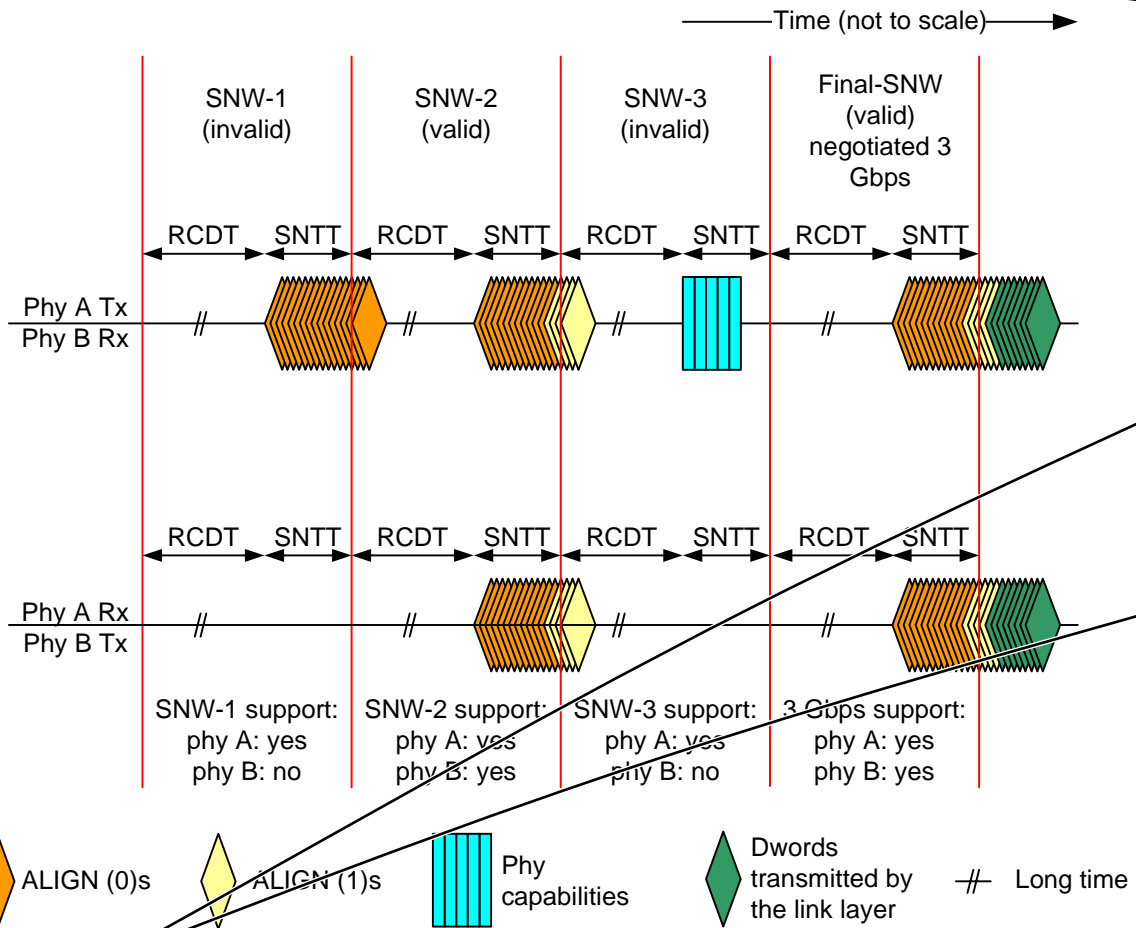

Figure 147 – SAS speed negotiation sequence (phy A: SNW-1 through SNW-3, phy B: SNW-2 only)

Figure 148 shows speed negotiation between a phy A and a phy B where both phys participate in:

- 1) SNW-1, supported by both phys;
- 2) SNW-2, supported by both phys;
- 3) SNW-3, supported by both phys; and
- 4) Train-SNW.

Phy A and phy B detect:

- a) SNW-1 valid;
- b) SNW-2 valid; and
- c) SNW-3 valid,

● Author: Isi-gpenokie

Subject: Highlight

Date: 8/28/2008 3:57:04 PM

 ACCEPT - DONE (change to "After...a)b)c), then the phys proceed")

that makes no sense. The 1)-4) list gives the order. This discusses the results within that order)

This << and proceed to Final-SNW negotiating 3 Gbps. >> should be item d in the above a,b,c list.

● Author: intc-mseidel

Subject: Highlight

Date: 5/19/2008 5:50:47 PM

 REJECT (Figure C.2 shows a phy supporting SNW-1/2/3 negotiating with a phy supporting SNW-1/2. This figure (147) shows a SAS-1.1 phy only supporting SNW-2.)

There should be a SAS speed negotiation sequence diagram indicating how the SAS-2 protocol interacts with legacy SAS-1.1 devices. It could also indicate the interaction with legacy phys.

● Author: RElliott

Subject: Note

Date: 6/30/2008 6:16:52 PM

 ACCEPT - DONE

Make figure 148 the first example, since it is the simplest (both phys support everything)

and proceed to Train-SNW negotiating based on SNW-3 phy capabilities hits

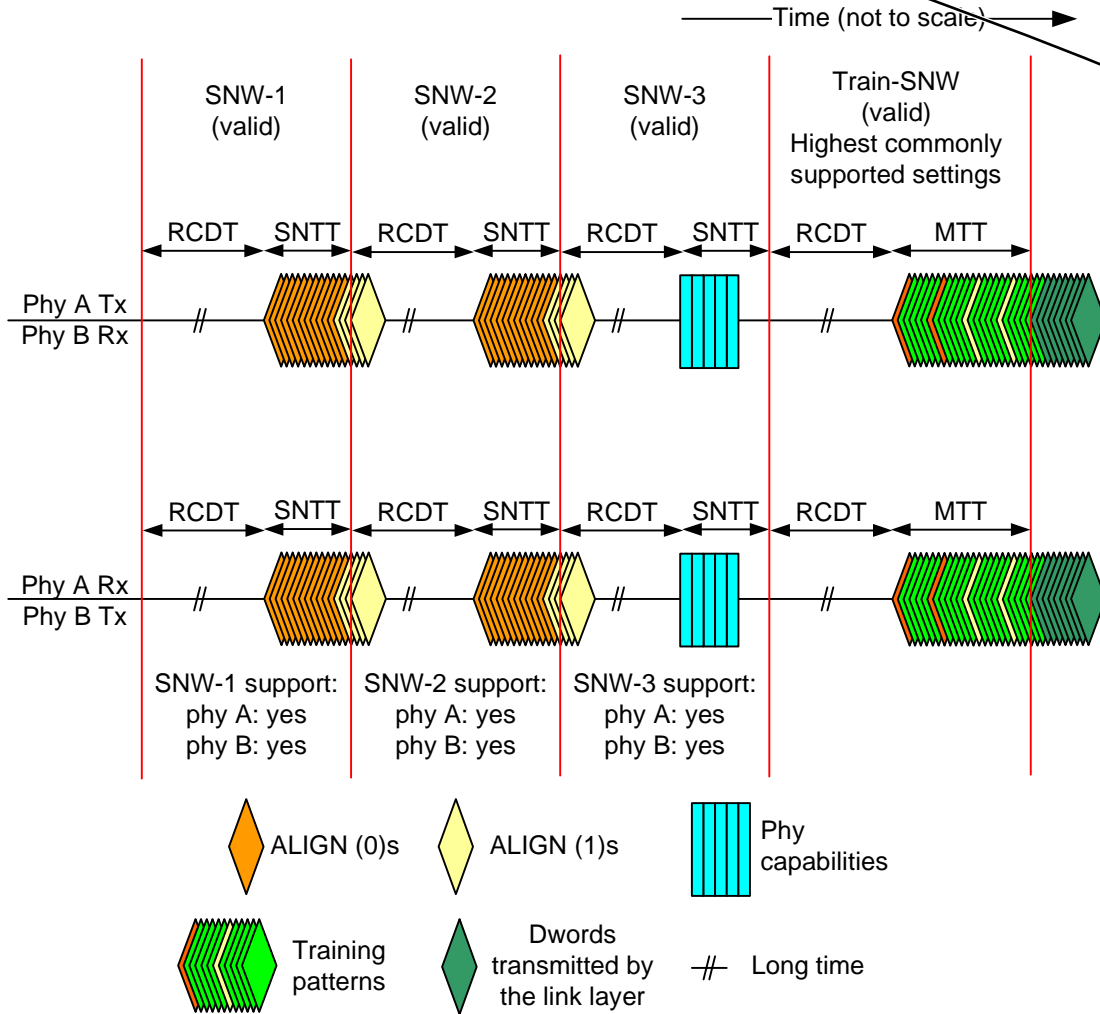

Figure 148 — SAS speed negotiation sequence (both phys SNW-1 through SNW-3)

● Author: Isi-bday

Subject: Cross-Out

Date: 5/19/2008 5:51:55 PM

T REJECT (that word is used in the intro to each of these figures)

negotiating

● Author: Isi-gpenokie

Subject: Highlight

Date: 8/27/2008 5:19:40 PM

T ACCEPT - DONE (change to "After...a)b)c), then the phys proceed" in all such paragraphs)

This << and proceed to Train-SNW negotiating based on SNW-3 phy capabilities bits.

>> should be item d in the above a,b,c list.

Figure 149 shows a speed negotiation sequence where phy B does not achieve dword synchronization during Final-SNW, creating a phy reset problem. If this occurs, the handshake is not complete and the phy reset sequence is retried.

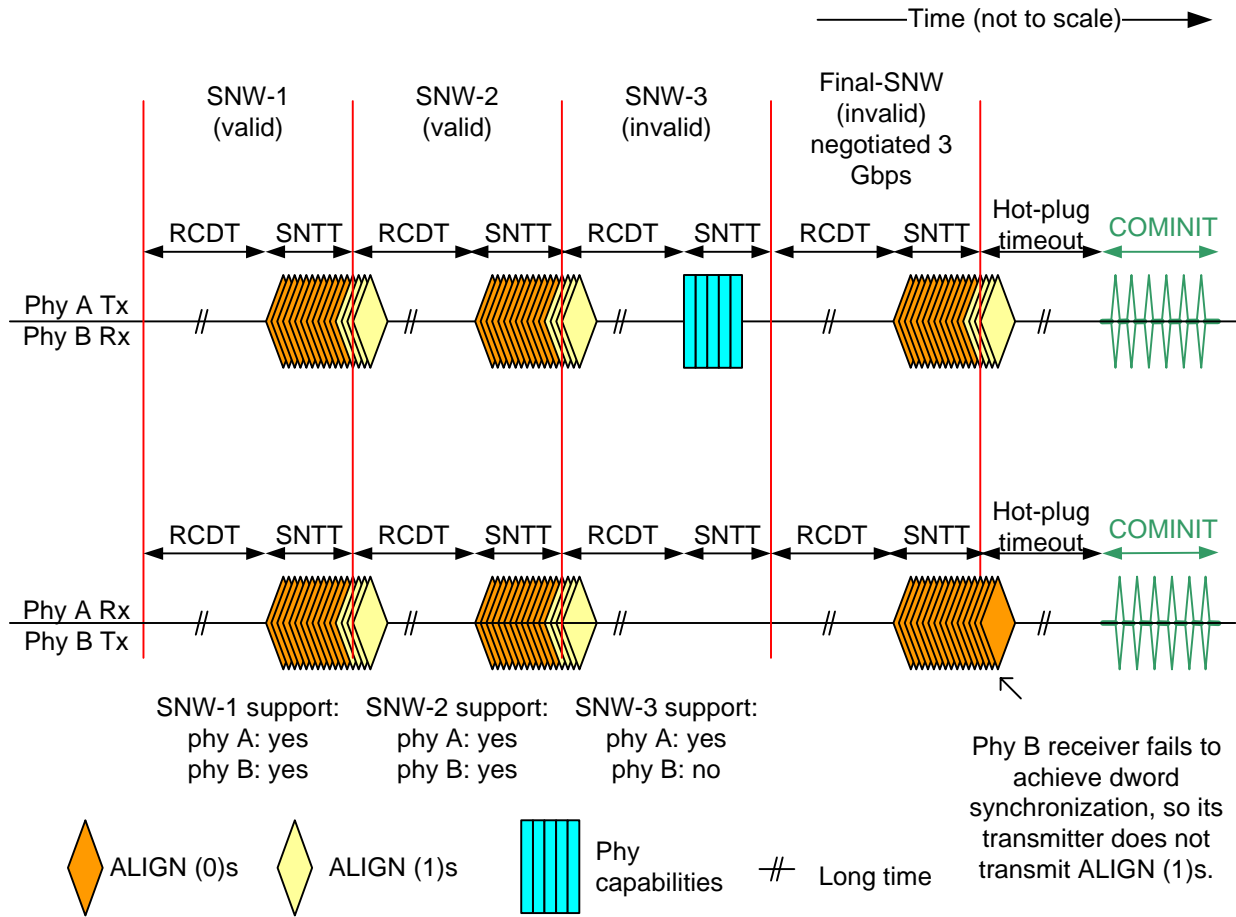

Figure 149 — SAS speed negotiation sequence - phy reset problem in Final-SNW

Author: RElliott
Subject: Highlight
Date: 6/30/2008 6:16:52 PM
ACCEPT - DONE

T

the
s/b
then the

Figure 150 shows a speed negotiation sequence in which a phy reset problem is encountered in SNW-3 because the phys do not exchange the phy capabilities bits properly (e.g., due to a parity error).

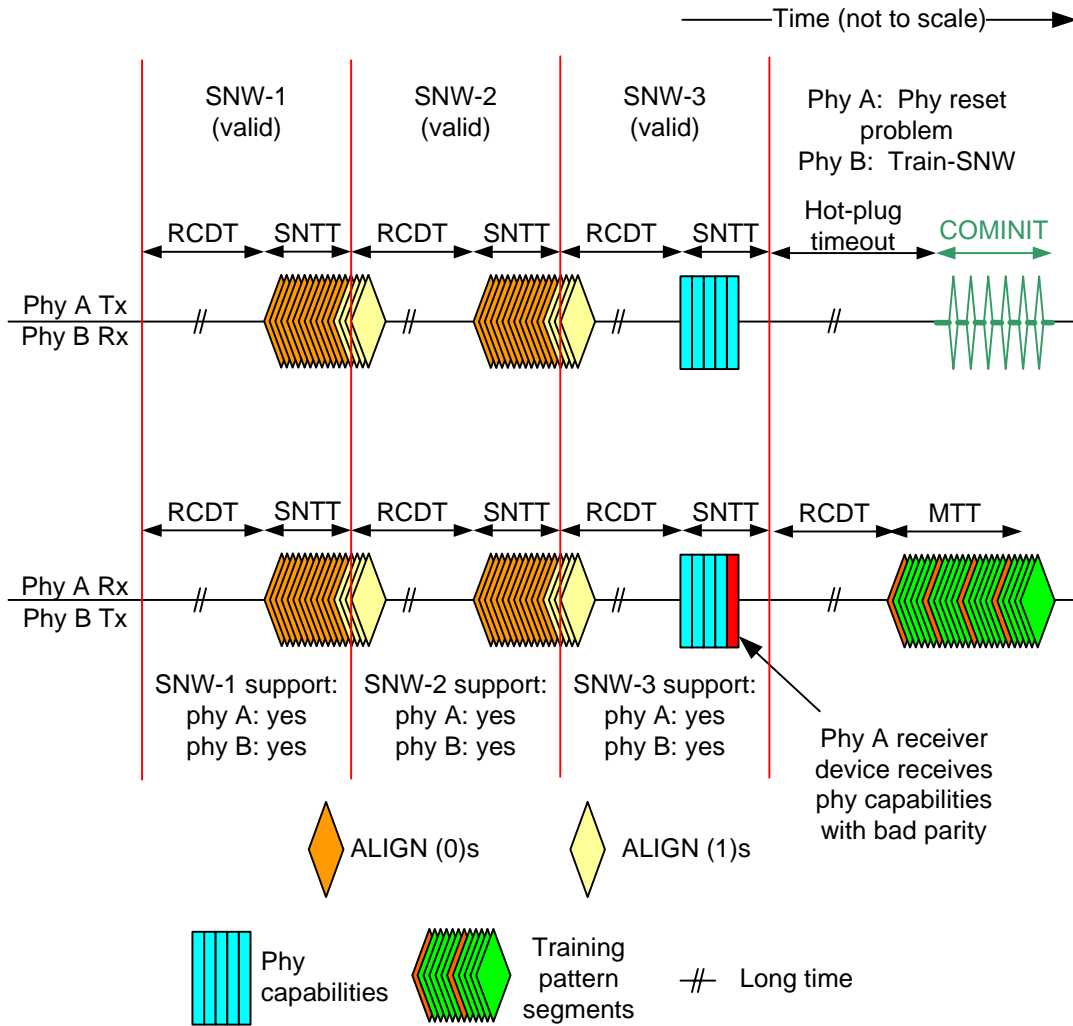

Figure 150 — SAS speed negotiation sequence - phy reset problem in SNW-3

Figure 151 shows a speed negotiation sequence in which a phy reset problem is encountered in Train-SNW because either phy does not complete training within the MTT interval of several training windows exhausting all commonly supported settings exchanged in SNW-3.

Author: Isi-bday

Subject: Highlight

Date: 5/19/2008 8:15:31 PM

T ACCEPT - DONE (as "This example assumes that only one commonly supported setting is exchanged in the phy capabilities bits.")

This figure doesn't show several training windows. Suggest:

... within the MTT interval. This figure illustrates when only a single commonly supported setting was exchanged in SNW-3.

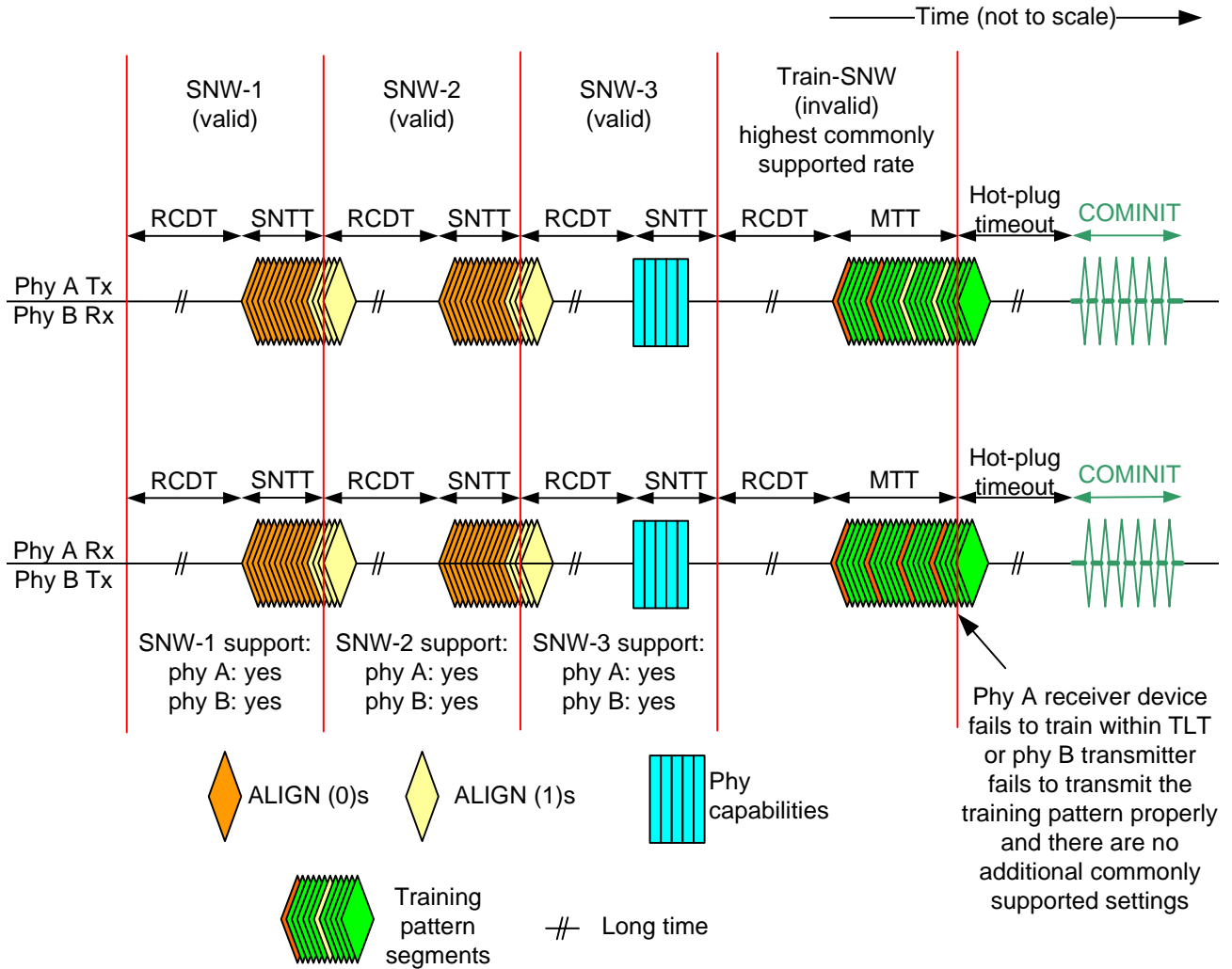

Figure 151 — SAS speed negotiation sequence - phy reset problem in Train-SNW

This page contains no comments

Figure 152 shows two Train-SNWs, if supported settings bits are exchanged that contain more than one commonly supported setting and the Train-SNW using the highest commonly supported setting is invalid, a second Train-SNW is performed using the next highest commonly supported setting.

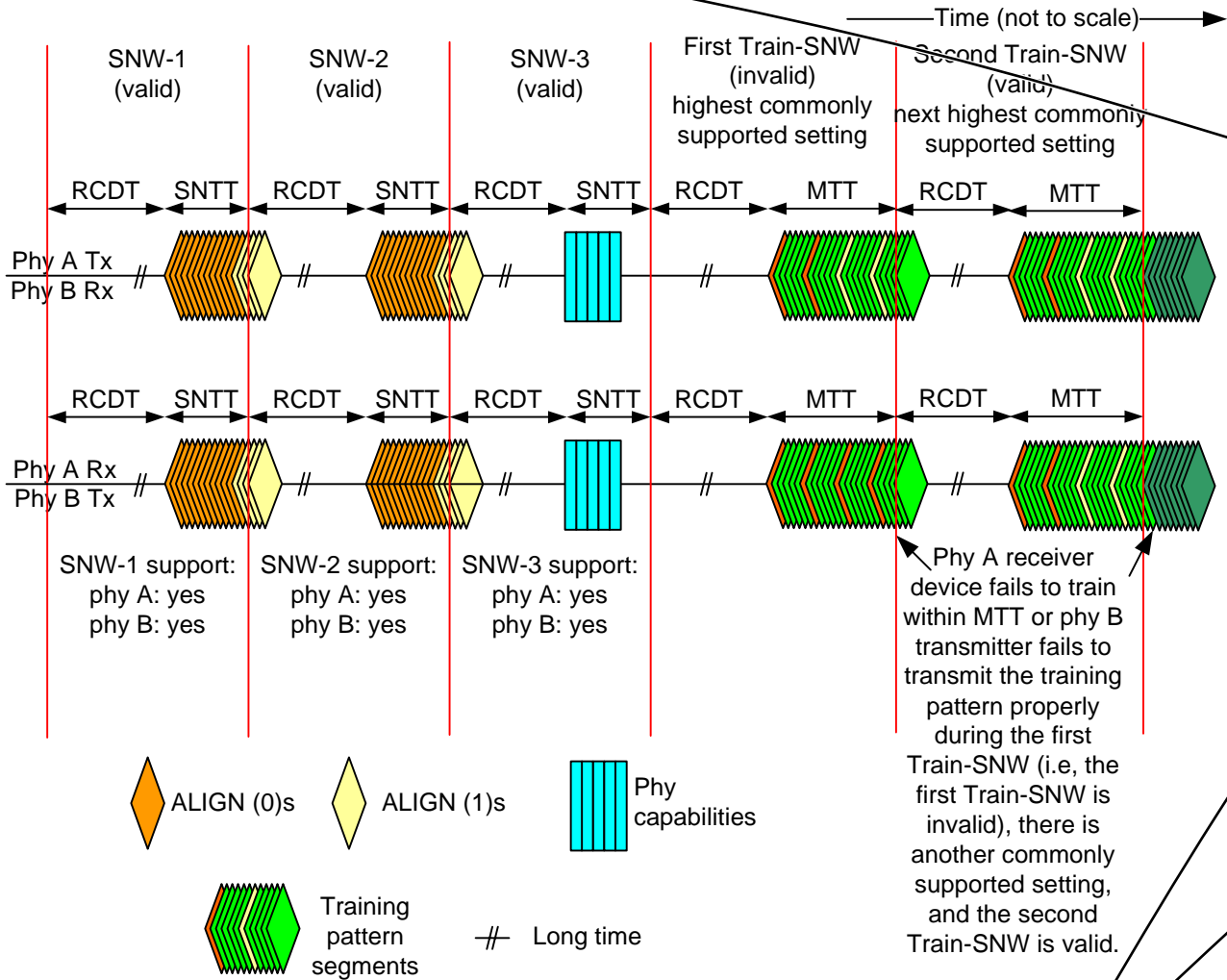

Figure 152 — SAS speed negotiation sequence - multiple Train-SNWs

For more examples of speed negotiations, see Annex C.

6.7.4.3 Multiplexing sequence

If SNW-3 indicates multiplexing (see 6.10) is enabled (see table 100 in 6.7.4.2.3.3), the phy shall transmit the multiplexing sequence immediately after the speed negotiation sequence.

The multiplexing sequence is:

- 1) MUX (LOGICAL LINK 0);
- 2) MUX (LOGICAL LINK 1);
- 3) MUX (LOGICAL LINK 0);
- 4) MUX (LOGICAL LINK 1);
- 5) MUX (LOGICAL LINK 0); and
- 6) MUX (LOGICAL LINK 1).

The phy shall not transmit deletable primitives for physical link rate tolerance management (see 7.3) during the multiplexing sequence.

If SNW-3 indicates multiplexing is not enabled, the phy shall not transmit the multiplexing sequence.

● Author: Isi-bday
Subject: Highlight
Date: 5/25/2008 7:22:45 PM
T REJECT (but changed if to "where" and "a second" to "so a second")

Train-SNWs, if
s/b
Train-SNWs. If

● Author: wdc-mevans
Subject: Highlight
Date: 5/25/2008 3:46:33 PM
T REJECT (2 things ANDED together)

setting and
s/b
setting, and

● Author: RElliott
Subject: Highlight
Date: 6/30/2008 6:16:52 PM
T ACCEPT - DONE

the
s/b
then the

● Author: RElliott
Subject: Highlight
Date: 6/30/2008 6:16:52 PM
T ACCEPT - DONE

the
s/b
then the

The phy shall assign the incoming logical links to its logical phys based on the first MUX primitive it receives:

- a) MUX (LOGICAL LINK 0) indicates the position of logical link 0 and indicates the next dword is in logical link 1; or
- b) MUX (LOGICAL LINK 1) indicates the position of logical link 1 and indicates the next dword is in logical link 0.

The phy shall handle errors during the multiplexing sequence (i.e., after receiving the first MUX primitive) as follows:

- a) If the phy loses dword synchronization, it shall restart the link reset sequence rather than attempt to reestablish dword synchronization;
- b) If the phy receives a dword that is not a MUX primitive before receiving the MUX primitive expected in that position, it shall discard the dword;
- c) If the phy receives an invalid dword, it shall discard the dword; and
- d) If the phy receives a MUX primitive that does not match the MUX primitive expected in that position (i.e., it receives MUX (LOGICAL LINK 1) on logical link 0 or receives MUX (LOGICAL LINK 0) on logical link 1), it shall restart the link reset sequence.

6.7.5 Phy reset sequence after devices are attached

Since SATA and SAS signal cable connectors do not include power lines, it is not possible to detect the physical insertion of the signal cable connector onto a plug. Non-cabled environments may similarly not have a way to detect physical insertion of a device. As a result, every time a phy reset sequence is originated:

- a) expander phys that are enabled but not active shall originate a new phy reset sequence repeatedly, with no more than a hot-plug timeout (see table 93 in 6.7.1) between each attempt, until a speed negotiation sequence completes successfully;
- b) SAS initiator phys should originate a new phy reset sequence after every hot-plug timeout; and
- c) SAS target phys should not originate a new phy reset sequence after their first attempt.

Page: 253

● Author: RElliott
Subject: Underline
Date: 6/30/2008 6:16:52 PM
T ACCEPT - DONE

If
s/b
if

(part of global change to lowercase a)b)c) entries)

● Author: wdc-mevans
Subject: Highlight
Date: 5/25/2008 3:48:19 PM
T REJECT (first noun/subject convention, but added "then")

it
s/b
then the phy

● Author: RElliott
Subject: Underline
Date: 6/30/2008 6:16:52 PM
T ACCEPT - DONE

If
s/b
if

(part of global change to lowercase a)b)c) entries)

● Author: wdc-mevans
Subject: Highlight
Date: 5/25/2008 3:48:26 PM
T REJECT (first noun/subject convention, but added "then")

it
s/b
then the phy

● Author: RElliott
Subject: Underline
Date: 6/30/2008 6:16:52 PM
T ACCEPT - DONE

If
s/b
if

(part of global change to lowercase a)b)c) entries)

● Author: Isi-gpenokie
Subject: Highlight
Date: 5/25/2008 3:48:52 PM
T ACCEPT - DONE

This should be an << or >> as any one of the items in the list could be happen not all have to happen.

Comments from page 253 continued on next page

The phy shall assign the incoming logical links to its logical phys based on the first MUX primitive it receives:

- a) MUX (LOGICAL LINK 0) indicates the position of logical link 0 and indicates the next dword is in logical link 1; or
- b) MUX (LOGICAL LINK 1) indicates the position of logical link 1 and indicates the next dword is in logical link 0.

The phy shall handle errors during the multiplexing sequence (i.e., after receiving the first MUX primitive) as follows:

- a) If the phy loses dword synchronization, it shall restart the link reset sequence rather than attempt to reestablish dword synchronization;
- b) If the phy receives a dword that is not a MUX primitive before receiving the MUX primitive expected in that position, it shall discard the dword;
- c) If the phy receives an invalid dword, it shall discard the dword; and
- d) If the phy receives a MUX primitive that does not match the MUX primitive expected in that position (i.e., it receives MUX (LOGICAL LINK 1) on logical link 0 or receives MUX (LOGICAL LINK 0) on logical link 1), it shall restart the link reset sequence.

6.7.5 Phy reset sequence after devices are attached

Since SATA and SAS signal cable connectors do not include power lines, it is not possible to detect the physical insertion of the signal cable connector onto a plug. Non-cabled environments may similarly not have a way to detect physical insertion of a device. As a result, every time a phy reset sequence is originated:

- a) expander phys that are enabled but not active shall originate a new phy reset sequence repeatedly, with no more than a hot-plug timeout (see table 93 in 6.7.1) between each attempt, until a speed negotiation sequence completes successfully;
- b) SAS initiator phys should originate a new phy reset sequence after every hot-plug timeout; and
- c) SAS target phys should not originate a new phy reset sequence after their first attempt.

Author: wdc-mevans
Subject: Highlight
Date: 5/25/2008 3:48:31 PM
T REJECT (first noun/subject convention, but added "then")
it
s/b
then the phy

Author: RElliott
Subject: Underline
Date: 6/30/2008 6:16:52 PM
T ACCEPT - DONE
If
s/b
if

(part of global change to lowercase a)b)c) entries)

Author: wdc-mevans
Subject: Highlight
Date: 5/25/2008 3:48:41 PM
T REJECT (first noun/subject convention, but added "then")
it
s/b
then the phy

Author: wdc-mevans
Subject: Highlight
Date: 5/21/2008 7:46:33 PM
T REJECT (similarly means the reason is similar to that expressed in the first sentence. Also opens it up to reasons of all sorts.)
similarly
s/b
also

Author: intc-mseidel
Subject: Highlight
Date: 5/6/2008 4:07:49 PM
T REJECT (T10 style using FrameMaker is to use standard capitalization for such references. Word is only capable of capitalizing such references, but is not an example to follow)

"table 93" s/b "Table 93". All such instances of "table" and "figure" that indicate a particular object should be capitalized.

Figure 153 shows how two phys complete the phy reset sequence if the phys are not attached at power on. In this example, phy A and phy B are attached some time before phy B's second hot-plug timeout occurs. Phy B's OOB detection circuitry detects a COMINIT after the attachment, and therefore phy B transmits COMSAS, since it has both transmitted and received a COMINIT. Upon receiving COMSAS, phy A transmits its own COMSAS. The SAS speed negotiation sequence follows.

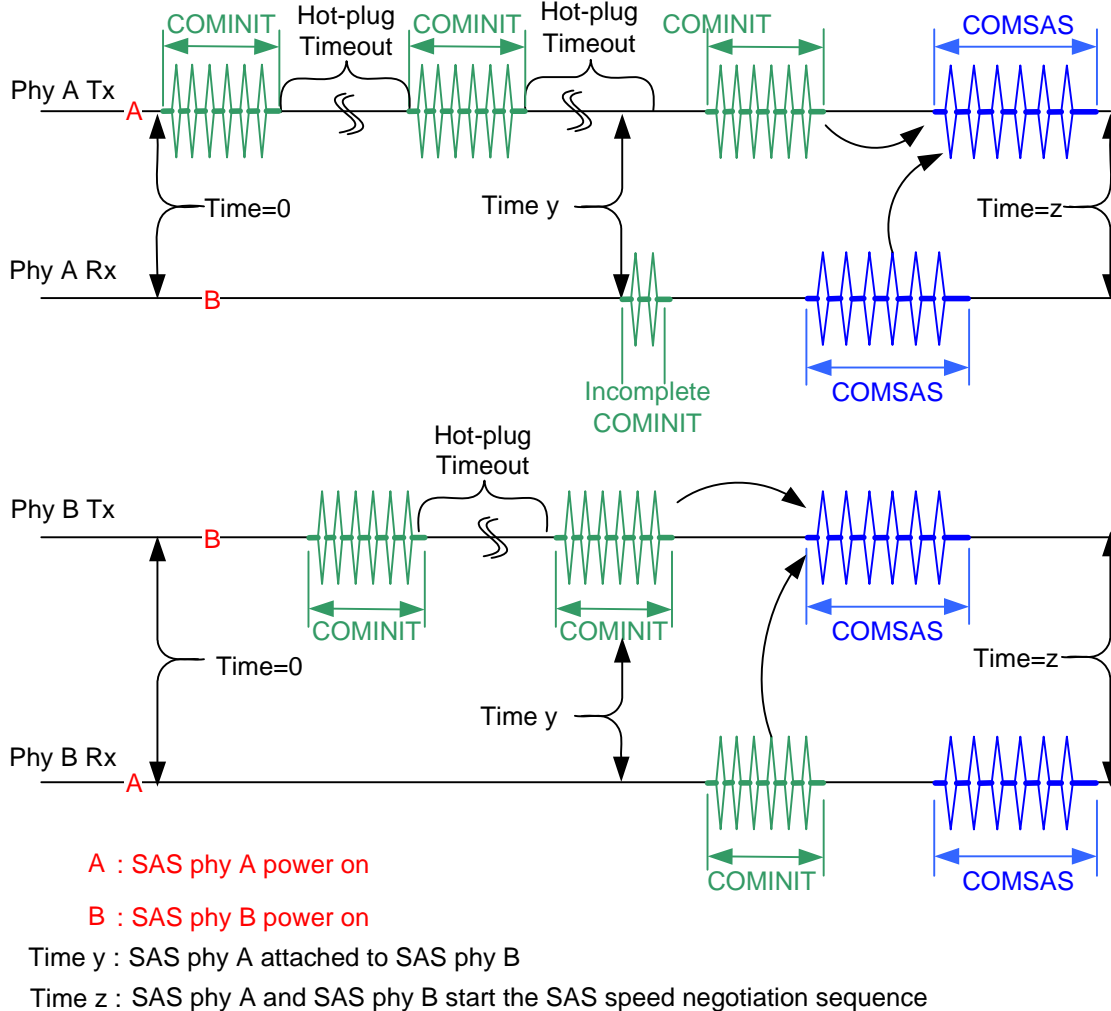

Figure 153 — Hot-plug and the phy reset sequence

6.8 SP (phy layer) state machine

6.8.1 SP state machine overview

The SP state machine controls the phy reset sequence. This state machine consists of three sets of states:

- OOB sequence (OOB) states;
- SAS speed negotiation (SAS) states; and
- SATA host emulation (SATA) states.

This state machine consists of the following states:

- SP0:OOB_COMINIT (see 6.8.3.2)(initial state);
- SP1:OOB_AwaitCOMX (see 6.8.3.3);
- SP2:OOB_NoCOMSASTimeout (see 6.8.3.4);
- SP3:OOB_AwaitCOMINIT_Sent (see 6.8.3.5);
- SP4:OOB_COMSAS (see 6.8.3.6);
- SP5:OOB_AwaitCOMSAS_Sent (see 6.8.3.7);

This page contains no comments

- g) SP6:OOB_AwaitNoCOMSAS (see 6.8.3.8);
- h) SP7:OOB_AwaitCOMSAS (see 6.8.3.9);
- i) SP8:SAS_Start (see 6.8.4.2);
- j) SP9:SAS_WindowNotSupported (see 6.8.4.3);
- k) SP10:SAS_AwaitALIGN (see 6.8.4.4);
- l) SP11:SAS_AwaitALIGN1 (see 6.8.4.5);
- m) SP12:SAS_AwaitSNW (see 6.8.4.6);
- n) SP13:SAS_Pass (see 6.8.4.7);
- o) SP14 SAS_Fail (see 6.8.4.8);
- p) SP15:SAS_PHY_Ready (see 6.8.4.9);
- q) SP16:SATA_COMWAKE (see 6.8.5.2);
- r) SP17:SATA_AwaitCOMWAKE (see 6.8.5.3);
- s) SP18:SATA_AwaitNoCOMWAKE (see 6.8.5.4);
- t) SP19:SATA_AwaitALIGN (see 6.8.5.5);
- u) SP20:SATA_AdjustSpeed (see 6.8.5.6);
- v) SP21:SATA_Transmit_ALIGN (see 6.8.5.7);
- w) SP22:SATA_PHY_Ready (see 6.8.5.8);
- x) SP23:SATA_PM_Partial (see 6.8.5.9);
- y) SP24:SATA_PM_Slumber (see 6.8.5.10);
- z) SP25:SATA_PortSel (see 6.8.6.2);
- aa) SP26:SATA_SpinupHold (see 6.8.7.2);
- ab) SP27:SAS_Settings (see 6.8.4.10);
- ac) SP28:SAS_TrainSetup (see 6.8.4.11);
- ad) SP29:SAS_Train (see 6.8.4.12); and
- ae) SP30:SAS_TrainingDone (see 6.8.4.13).

The SP state machine shall start in the SP0:OOB_COMINIT state after:

- a) a power on;
- b) a hard reset;
- c) receiving a Management Reset request ~~from the management layer~~ (e.g. **from the SMP PHY CONTROL function requesting a phy operation of LINK RESET or HARD RESET in an expander device**); or
- d) receiving a Disable Phy request ~~from the management layer~~ (e.g., **from the SMP PHY CONTROL function requesting a phy operation of DISABLE in an expander device**).

The SP state machine shall maintain a MgmtReset state machine variable to determine whether a Management Reset request has been received. Any SP state that receives a Management Reset request shall set the MgmtReset state machine variable to one before making a transition to the SP0:OOB_COMINIT state (see 6.8.3.2). Any SP state that receives **a power on, or a hard reset** shall set the MgmtReset state machine variable to zero before making a transition to the SP0:OOB_COMINIT state.

The SP state machine shall maintain a Current SNW state machine variable to determine the current SNW (e.g., SNW-1, SNW-2, SNW-3, Final-SNW, Train-SNW, or Unsupported Phy Attached).

If the phy status is available through any of the following:

- a) the SMP DISCOVER response (see 10.4.3.10);
- b) the SMP DISCOVER LIST response (see 10.4.3.15);
- c) the Phy Control And Discover mode page (see 10.2.7.5); or
- d) the Protocol-Specific Port log page (see 10.2.8.1),

then **the SP state machine** shall maintain a ResetStatus state machine variable to determine the NEGOTIATED PHYSICAL LINK RATE field and/or the NEGOTIATED LOGICAL LINK RATE field.

If the phy supports SNW-3, then **the SP state machine** shall maintain a Commonly Supported Settings state machine variable that contains supported settings common between the phy and the attached phy.

If the phy supports SATA port selectors, **the SP state machine** shall maintain a COMWAKE_Received state machine variable to indicate whether a **COMWAKE detected** message was received in the SP0:OOB_COMINIT state or the SP1:OOB_AwaitCOMX state since the last time the SP0:OOB_COMINIT

Author: RElliott
Subject: Highlight
Date: 6/30/2008 6:16:52 PM
 ACCEPT - DONE

SATA_Transmit_ALIGN
s/b
SATA_TransmitALIGN

Author: RElliott
Subject: Note
Date: 8/30/2008 3:30:15 PM
 ACCEPT - DONE

Add:

This state machine receives the following requests from the management application layer or a layer outside the scope of this standard:

- a) Management Reset from the management application layer;
- b) Disable Phy from the management application layer;
- c) Transmit SATA Port Selection Signal from the management application layer;
- d) Enter Partial request from the SATA link layer, if any;
- e) Enter Slumber from the SATA link layer, if any;
- f) Exit Partial from the SATA link layer, if any; and
- g) Exit Slumber from the SATA link layer, if any.

prompted by 08-343.

Further elucidation could be added in chapter 4 about how, if SP reports that SATA is attached:

1. a SAS device morphs into a SATA host (the SATA link layer defined in SATA 2.6 interfaces with SP)
2. an expander device puts its phy under control of a SATA host in an STP/SATA bridge (whose SATA link layer interfaces with SP)

but that is ignored for now.

Author: RElliott
Subject: Highlight
Date: 8/30/2008 3:30:08 PM
 ACCEPT - DONE

The SP state machine
s/b
This state machine

Author: RElliott
Subject: Cross-Out
Date: 8/30/2008 2:50:12 PM
 ACCEPT - DONE

Delete
from the management layer

after adding an overall list of requests above (prompted by 08-343)

Author: RElliott
Subject: Highlight
Date: 8/30/2008 2:50:25 PM

- g) SP6:OOB_AwaitNoCOMSAS (see 6.8.3.8);
- h) SP7:OOB_AwaitCOMSAS (see 6.8.3.9);
- i) SP8:SAS_Start (see 6.8.4.2);
- j) SP9:SAS_WindowNotSupported (see 6.8.4.3);
- k) SP10:SAS_AwaitALIGN (see 6.8.4.4);
- l) SP11:SAS_AwaitALIGN1 (see 6.8.4.5);
- m) SP12:SAS_AwaitSNW (see 6.8.4.6);
- n) SP13:SAS_Pass (see 6.8.4.7);
- o) SP14 SAS_Fail (see 6.8.4.8);
- p) SP15:SAS_PHY_Ready (see 6.8.4.9);
- q) SP16:SATA_COMWAKE (see 6.8.5.2);
- r) SP17:SATA_AwaitCOMWAKE (see 6.8.5.3);
- s) SP18:SATA_AwaitNoCOMWAKE (see 6.8.5.4);
- t) SP19:SATA_AwaitALIGN (see 6.8.5.5);
- u) SP20:SATA_AdjustSpeed (see 6.8.5.6);
- v) SP21:SATA_Transmit_ALIGN (see 6.8.5.7);
- w) SP22:SATA_PHY_Ready (see 6.8.5.8);
- x) SP23:SATA_PM_Partial (see 6.8.5.9);
- y) SP24:SATA_PM_Slumber (see 6.8.5.10);
- z) SP25:SATA_PortSel (see 6.8.6.2);
- aa) SP26:SATA_SpinupHold (see 6.8.7.2);
- ab) SP27:SAS_Settings (see 6.8.4.10);
- ac) SP28:SAS_TrainSetup (see 6.8.4.11);
- ad) SP29:SAS_Train (see 6.8.4.12); and
- ae) SP30:SAS_TrainingDone (see 6.8.4.13).

The SP state machine shall start in the SP0:OOB_COMINIT state after:

- a) a power on;
- b) a hard reset;
- c) receiving a Management Reset request ~~from the management layer (e.g., from the SMP PHY CONTROL function requesting a phy operation of LINK RESET or HARD RESET in an expander device);~~ or
- d) receiving a Disable Phy request ~~from the management layer (e.g., from the SMP PHY CONTROL function requesting a phy operation of DISABLE in an expander device).~~

The SP state machine shall maintain a MgmtReset state machine variable to determine whether a Management Reset request has been received. Any SP state that receives a Management Reset request shall set the MgmtReset state machine variable to one before making a transition to the SP0:OOB_COMINIT state (see 6.8.3.2). Any SP state that receives **a power on, or a hard reset** shall set the MgmtReset state machine variable to zero before making a transition to the SP0:OOB_COMINIT state.

The SP state machine shall maintain a Current SNW state machine variable to determine the current SNW (e.g., SNW-1, SNW-2, SNW-3, Final-SNW, Train-SNW, or Unsupported Phy Attached).

If the phy status is available through any of the following:

- a) the SMP DISCOVER response (see 10.4.3.10);
- b) the SMP DISCOVER LIST response (see 10.4.3.15);
- c) the Phy Control And Discover mode page (see 10.2.7.5); or
- d) the Protocol-Specific Port log page (see 10.2.8.1),

then **the SP state machine** shall maintain a ResetStatus state machine variable to determine the NEGOTIATED PHYSICAL LINK RATE field and/or the NEGOTIATED LOGICAL LINK RATE field.

If the phy supports SNW-3, then **the SP state machine** shall maintain a Commonly Supported Settings state machine variable that contains supported settings common between the phy and the attached phy.

If the phy supports SATA port selectors, **the SP state machine** shall maintain a COMWAKE_Received state machine variable to indicate whether a **COMWAKE detected** message was received in the SP0:OOB_COMINIT state or the SP1:OOB_AwaitCOMX state since the last time the SP0:OOB_COMINIT

TREJECT (moot)

management layer
s/b
management application layer

● Author: wdc-mevans
Subject: Highlight
Date: 5/25/2008 3:50:11 PM

TACCEPT - DONE (with "processing" rather than "receiving")

from the SMP PHY CONTROL function requesting a phy operation of LINK RESET or HARD RESET in an expander device);
s/b
as the result of the management application layer in an expander device receiving an SMP PHY CONTROL function requesting a phy operation of LINK RESET or HARD RESET);

● Author: RElliott
Subject: Cross-Out
Date: 8/30/2008 2:50:17 PM

TACCEPT - DONE

Delete
from the management layer

after adding an overall list of requests above (prompted by 08-343)

● Author: RElliott
Subject: Highlight
Date: 6/30/2008 6:16:52 PM

TACCEPT - DONE

from the
s/b
as a result of processing an

● Author: RElliott
Subject: Highlight
Date: 8/30/2008 2:50:33 PM

TREJECT (moot)

management layer
s/b
management application layer

● Author: RElliott
Subject: Cross-Out
Date: 6/30/2008 6:16:52 PM

TACCEPT - DONE

in an expander device

● Author: RElliott
Subject: Highlight
Date: 8/31/2008 4:50:23 PM

TACCEPT - DONE

The SP state machine
s/b
This state machine

● Author: lsi-gpenokie
Subject: Highlight
Date: 5/25/2008 3:50:27 PM

Comments from page 255 continued on next page

- g) SP6:OOB_AwaitNoCOMSAS (see 6.8.3.8);
- h) SP7:OOB_AwaitCOMSAS (see 6.8.3.9);
- i) SP8:SAS_Start (see 6.8.4.2);
- j) SP9:SAS_WindowNotSupported (see 6.8.4.3);
- k) SP10:SAS_AwaitALIGN (see 6.8.4.4);
- l) SP11:SAS_AwaitALIGN1 (see 6.8.4.5);
- m) SP12:SAS_AwaitSNW (see 6.8.4.6);
- n) SP13:SAS_Pass (see 6.8.4.7);
- o) SP14 SAS_Fail (see 6.8.4.8);
- p) SP15:SAS_PHY_Ready (see 6.8.4.9);
- q) SP16:SATA_COMWAKE (see 6.8.5.2);
- r) SP17:SATA_AwaitCOMWAKE (see 6.8.5.3);
- s) SP18:SATA_AwaitNoCOMWAKE (see 6.8.5.4);
- t) SP19:SATA_AwaitALIGN (see 6.8.5.5);
- u) SP20:SATA_AdjustSpeed (see 6.8.5.6);
- v) SP21:SATA_Transmit_ALIGN (see 6.8.5.7);
- w) SP22:SATA_PHY_Ready (see 6.8.5.8);
- x) SP23:SATA_PM_Partial (see 6.8.5.9);
- y) SP24:SATA_PM_Slumber (see 6.8.5.10);
- z) SP25:SATA_PortSel (see 6.8.6.2);
- aa) SP26:SATA_SpinupHold (see 6.8.7.2);
- ab) SP27:SAS_Settings (see 6.8.4.10);
- ac) SP28:SAS_TrainSetup (see 6.8.4.11);
- ad) SP29:SAS_Train (see 6.8.4.12); and
- ae) SP30:SAS_TrainingDone (see 6.8.4.13).

The SP state machine shall start in the SP0:OOB_COMINIT state after:

- a) a power on;
- b) a hard reset;
- c) receiving a Management Reset request ~~from the management layer~~ (e.g., from the SMP PHY CONTROL function requesting a phy operation of LINK RESET or HARD RESET in an expander device); or
- d) receiving a Disable Phy request ~~from the management layer~~ (e.g., from the SMP PHY CONTROL function requesting a phy operation of DISABLE ~~in an expander device~~).

The SP state machine shall maintain a MgmtReset state machine variable to determine whether a Management Reset request has been received. Any SP state that receives a Management Reset request shall set the MgmtReset state machine variable to one before making a transition to the SP0:OOB_COMINIT state (see 6.8.3.2). Any SP state that receives a power on, or a hard reset shall set the MgmtReset state machine variable to zero before making a transition to the SP0:OOB_COMINIT state.

The SP state machine shall maintain a Current SNW state machine variable to determine the current SNW (e.g., SNW-1, SNW-2, SNW-3, Final-SNW, Train-SNW, or Unsupported Phy Attached).

If the phy status is available through any of the following:

- a) the SMP DISCOVER response (see 10.4.3.10);
- b) the SMP DISCOVER LIST response (see 10.4.3.15);
- c) the Phy Control And Discover mode page (see 10.2.7.5); or
- d) the Protocol-Specific Port log page (see 10.2.8.1),

then **the SP state machine** shall maintain a ResetStatus state machine variable to determine the NEGOTIATED PHYSICAL LINK RATE field and/or the NEGOTIATED LOGICAL LINK RATE field.

If the phy supports SNW-3, then **the SP state machine** shall maintain a Commonly Supported Settings state machine variable that contains supported settings common between the phy and the attached phy.

If the phy supports SATA port selectors, **the SP state machine** shall maintain a COMWAKE_Received state machine variable to indicate whether a COMWAKE detected message was received in the SP0:OOB_COMINIT state or the SP1:OOB_AwaitCOMX state since the last time the SP0:OOB_COMINIT

T ACCEPT - DONE

This << a power on, or a hard reset >> should be << a power on or a hard reset >>. Delete the comma.

● Author: RElliott
Subject: Highlight
Date: 8/30/2008 5:01:00 PM

T ACCEPT - DONE

The SP state machine
s/b
This state machine

● Author: RElliott
Subject: Highlight
Date: 8/30/2008 5:04:54 PM

T ACCEPT - DONE

the SP state machine
s/b
this state machine

● Author: RElliott
Subject: Highlight
Date: 8/30/2008 5:04:05 PM

T ACCEPT - DONE

the SP state machine
s/b
this state machine

● Author: RElliott
Subject: Highlight
Date: 8/30/2008 5:04:15 PM

T ACCEPT - DONE

the SP state machine
s/b
then this state machine

● Author: RElliott
Subject: Highlight
Date: 6/30/2008 6:16:52 PM

T ACCEPT - DONE

COMWAKE detected
s/b
COMWAKE Detected

state was entered, and the SP state machine shall transition to the SP25:SATA_PortSel state whenever it receives a Transmit SATA Port Selection Signal request.

The SP state machine sends the following messages to the SP_DWS state machine (see 6.9):

- a) Start DWS; and
- b) Stop DWS.

The SP state machine receives the following messages from the SP_DWS state machine:

- a) DWS Lost; and
- b) DWS Reset.

The SP state machine shall maintain the timers listed in table 104.

Table 104 — SP state machine timers

Timer	Initial value
COMSAS Detect Timeout timer	COMSAS detect timeout (see table 87 in 6.6.1)
Await ALIGN Timeout timer	Await ALIGN timeout (see table 94 in 6.7.2.2)
Hot-Plug Timeout timer	Hot plug timeout (see table 93 in 6.7.1)
RCDT timer	RCDT (see table 95 in 6.7.4.2)
SNLT timer	SNLT (see table 95 in 6.7.4.2)
SNTT timer	SNTT (see table 95 in 6.7.4.2)
TLT timer	TLT (see table 95 in 6.7.4.2)
MTT timer	MTT (see table 95 in 6.7.4.2)

6.8.2 SP transmitter and receiver

The SP transmitter transmits OOB signals and dwords on the physical link based on messages from the SP state machine (see 6.8).

The SP transmitter receives the following messages from the SP state machine:

- a) Transmit COMINIT;
- b) Transmit COMSAS;
- c) Transmit COMWAKE;
- d) Transmit SATA Port Selection Signal;
- e) Transmit D10.2;
- f) Set Rate with a Physical Link Rate argument, and an SSC On or an SSC Off argument;
- g) Transmit ALIGN with an argument indicating the specific type (e.g., Transmit ALIGN (0));
- h) Transmit Phy Capabilities Bits;
- i) Transmit TRAIN Pattern;
- j) Transmit TRAIN_DONE Pattern; and
- k) Transmit MUX Sequence.

When not otherwise instructed, the SP transmitter transmits D.C. idle.

Upon receiving a Transmit MUX Sequence message, the SP transmitter transmits:

- 1) MUX (LOGICAL LINK 0);
- 2) MUX (LOGICAL LINK 1);
- 3) MUX (LOGICAL LINK 0);
- 4) MUX (LOGICAL LINK 1);
- 5) MUX (LOGICAL LINK 0); and
- 6) MUX (LOGICAL LINK 1).

The SP transmitter shall complete any physical link rate change requested with the Set Rate message within RCDT (see table 95 in 6.7.4.2).

● Author: wdc-mevans
Subject: Highlight
Date: 5/25/2008 7:24:56 PM
T REJECT (but split into an a)b) list which might help)

it
s/b
the SP state machine

● Author: RElliott
Subject: Highlight
Date: 8/30/2008 5:04:37 PM
T ACCEPT - DONE

the SP state machine
s/b
this state machine

● Author: RElliott
Subject: Highlight
Date: 8/30/2008 5:00:43 PM
T ACCEPT - DONE

The SP state machine
s/b
This state machine

● Author: RElliott
Subject: Highlight
Date: 8/30/2008 5:00:46 PM
T ACCEPT - DONE

The SP state machine
s/b
This state machine

● Author: RElliott
Subject: Highlight
Date: 8/30/2008 5:00:50 PM
T ACCEPT - DONE

The SP state machine
s/b
This state machine

● Author: RElliott
Subject: Highlight
Date: 8/31/2008 8:52:13 PM
T ACCEPT - DONE

f) Set Rate with a Physical Link Rate argument, and an SSC On or an SSC Off argument;

Split this into:

- f) Set Physical Link Rate with an argument specifying the physical link rate (e.g., 1.5 Gbps, 3 Gbps, or 6 Gbps);
 - g) Set SSC with an argument of On or Off;
-

The SP transmitter sends the following messages to the SP state machine:

- a) COMINIT Transmitted;
- b) COMSAS Transmitted;
- c) COMWAKE Transmitted;
- d) SATA Port Selection Signal Transmitted;
- e) TRAIN_DONE Pattern Transmitted;
- f) Phy Capabilities Bits Transmitted; and
- g) MUX Sequence Transmitted.

The SP receiver receives OOB signals and dwords from the physical link and sends messages to the SP state machine indicating what it has received.

The SP receiver receives the following messages from the SP state machine:

- a) Set Rate with a Physical Link Rate argument, ~~and an SSC On argument or an SSC Off argument;~~
- b) Start Training; and
- c) Abort Training.

The SP receiver sends the following messages to the SP state machine:

- a) COMINIT Detected;
- b) COMSAS Detected;
- c) COMWAKE Detected;
- d) COMSAS Completed;
- e) COMWAKE Completed;
- f) ALIGN Received with an argument indicating the specific type (e.g., ALIGN Received (0));
- g) Phy Capabilities Bits Received with arguments indicating the supported settings bits received;
- h) Training Completed;
- i) TRAIN_DONE Received; and
- j) Dword Received.

The ALIGN Received, Dword Received, and TRAIN_DONE Received messages are only sent when the SP_DWS state machine has achieved dword synchronization.

For SATA speed negotiation, the ALIGN Received (0) message includes an argument containing the physical link rate at which the ALIGN (0) primitives were detected. For SAS speed negotiation, only ALIGNs at the physical link rate specified by the last Set Rate message received by the SP transmitter cause ALIGN Received messages.

The SP transmitter relationship to other transmitters is defined in 4.3.2. The SP receiver relationship to other receivers is defined in 4.3.3.

Page: 257

Author: wdc-mevans

Subject: Highlight

Date: 5/21/2008 7:51:57 PM

T ACCEPT - DONE (deleted sentence, incorporating the concepts into the "SP receiver sends " sentence below as "The SP receiver sends the following messages to the SP state machine indicating OOB signals and dwords received from the physical link". This matches the wording used in all the other XYZ receiver sections.)

it
s/b
the SP receiver

Author: RElliott

Subject: Cross-Out

Date: 8/31/2008 8:37:39 PM

T ACCEPT - DONE

Delete:

and an SSC On argument or an SSC Off argument;

The receiver (unlike the transmitter) doesn't care if SSC is on or off

Author: RElliott

Subject: Highlight

Date: 8/31/2008 8:49:05 PM

T ACCEPT - DONE

Set Rate with a Physical Link Rate argument

Change to:

Set Physical Link Rate with an argument specifying the physical link rate (e.g., 1.5 Gbps, 3 Gbps, or 6 Gbps);

Author: RElliott

Subject: Note

Date: 8/31/2008 8:38:20 PM

T ACCEPT - DONE

Add "Receive Phy Capabilities Bits" which will be sent by SP when it starts RCDT

Author: RElliott

Subject: Note

Date: 6/30/2008 6:16:52 PM

T ACCEPT - DONE

Add:

The SP receiver receives the following messages from the SP_DWS state machine (see 6.9):

- a) Sync Acquired; and
 - b) Sync Lost.
-

Author: elx-bmartin

Subject: Highlight

Date: 9/1/2008 3:17:41 PM

T ACCEPT - DONE (7/15 add a message at the beginning of RCDT called Receive Phy Capabilities Bits. When the SP receiver gets this, assume it hunts for the bits for a SNW time, then stops on its own (avoiding need for SP to send Start and Stop messages))

- g) Phy Capabilities Bits Received with arguments indicating the supported settings bits received;

There is no text or diagrams that indicate how this message is generated by the SP receiver. There are qualifications on when the SP receiver should be looking for the Phy Capabilities Bits based on the state of the SP state machine.

Comments from page 257 continued on next page

The SP transmitter sends the following messages to the SP state machine:

- a) COMINIT Transmitted;
- b) COMSAS Transmitted;
- c) COMWAKE Transmitted;
- d) SATA Port Selection Signal Transmitted;
- e) TRAIN_DONE Pattern Transmitted;
- f) Phy Capabilities Bits Transmitted; and
- g) MUX Sequence Transmitted.

The SP receiver receives OOB signals and dwords from the physical link and sends messages to the SP state machine indicating what **it** has received.

The SP receiver receives the following messages from the SP state machine:

- a) **Set Rate with a Physical Link Rate argument, and an SSC On argument or an SSC Off argument;**
- b) Start Training; and
- c) Abort Training.

The SP receiver sends the following messages to the SP state machine:

- a) COMINIT Detected;
- b) COMSAS Detected;
- c) COMWAKE Detected;
- d) COMSAS Completed;
- e) COMWAKE Completed;
- f) ALIGN Received with an argument indicating the specific type (e.g., ALIGN Received (0));
- g) **Phy Capabilities Bits Received with arguments indicating the supported settings bits received;**
- h) Training Completed;
- i) TRAIN_DONE Received; and
- j) Dword Received.

The ALIGN Received, Dword Received, and TRAIN_DONE Received messages are only sent **when** the SP_DWS state machine has achieved dword synchronization.

For SATA speed negotiation, the ALIGN Received (0) message includes an argument containing the physical link rate at which the ALIGN (0) primitives were detected. For SAS speed negotiation, only ALIGNs at the physical link rate specified by **the last Set Rate message received by the SP transmitter** cause ALIGN Received messages.

The SP transmitter relationship to other transmitters is defined in 4.3.2. The SP receiver relationship to other receivers is defined in 4.3.3.

● Author: RElliott
Subject: Note
Date: 6/30/2008 6:16:52 PM
ACCEPT - DONE (added "with an argument of Good Parity or Bad Parity")

Should Phy Capabilities Bits Received return an argument of Good Parity/Bad Parity, Parity Good/Bad, or what?

This is used later on a few times, questioned by Isi-bday

● Author: RElliott
Subject: Highlight
Date: 6/30/2008 6:16:52 PM
ACCEPT - DONE

when
s/b
after

● Author: RElliott
Subject: Highlight
Date: 8/31/2008 8:49:38 PM
ACCEPT - DONE

the last Set Rate message received by the SP transmitter

s/b
.. the SP receiver

The SP transmitter and SP receiver each receive the message

and change Set Rate to Set Physical Link Rate

6.8.3 OOB sequence states

6.8.3.1 OOB sequence states overview

Figure 154 shows the OOB sequence states. These states are indicated by state names with a prefix of OOB.

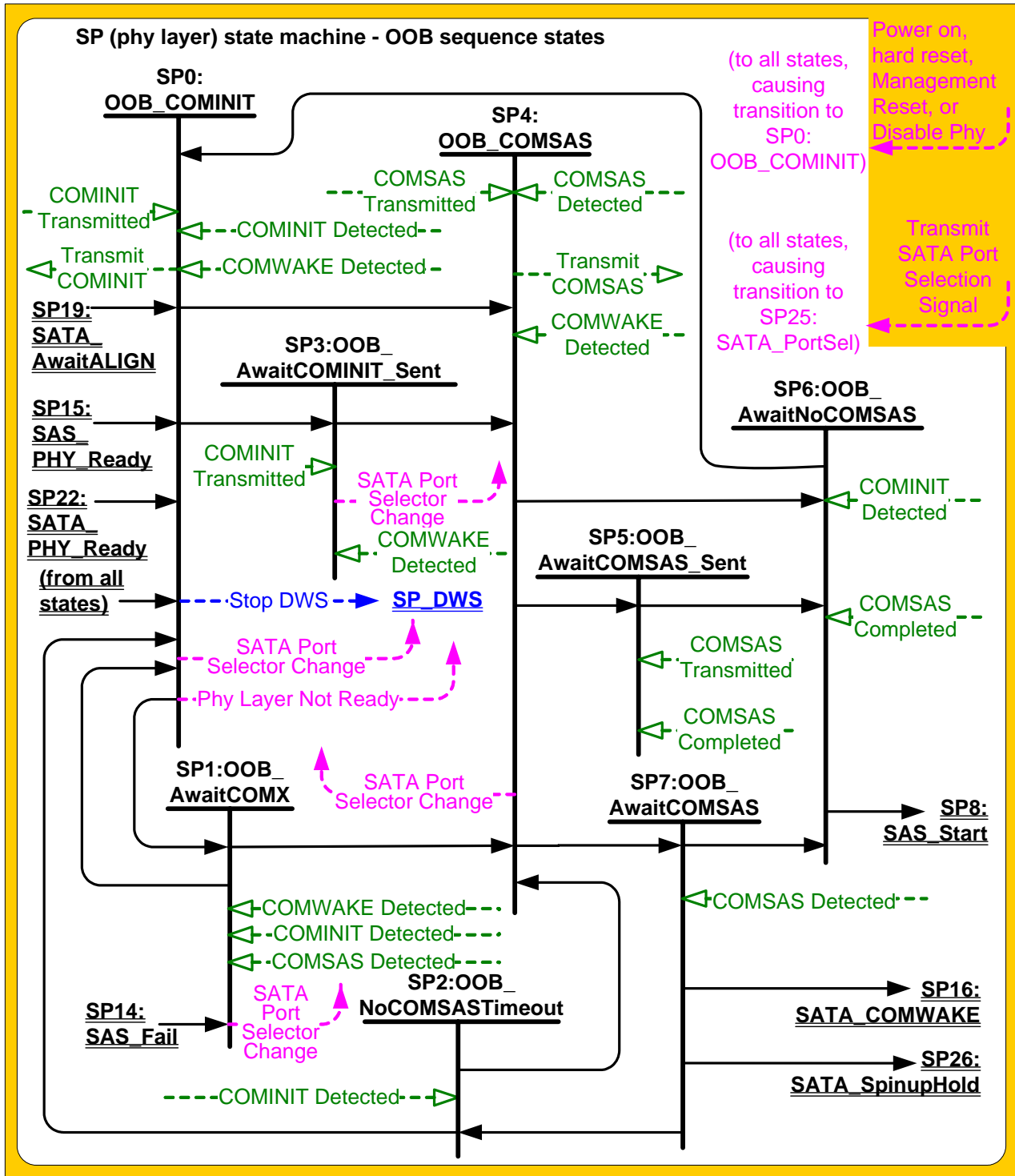

Figure 154 — SP (phy layer) state machine - OOB sequence states

This page contains no comments

6.8.3.2 SP0:OOB_COMINIT state

6.8.3.2.1 State description

This state is the initial state for this state machine.

Upon entry into this state, the phy shall:

- a) set the COMWAKE_Received state machine variable to zero;
- b) send a Stop DWS message to the SP_DWS state machine;
- c) send a Phy Layer Not Ready confirmation to the link layer;
- d) set the ATTACHED SATA DEVICE bit to zero in the SMP DISCOVER response (see 10.4.3.10);
- e) if this state was entered due to power on, set the ATTACHED SATA PORT SELECTOR bit to zero in the SMP DISCOVER response (see 10.4.3.10); and
- f) if this state was not entered because of a Disable Phy request, send a Transmit COMINIT message to the SP transmitter.

If this state was entered because of a Disable Phy request, then upon entry into this state, this state shall:

- a) ignore COMINIT Detected messages until this state is re-entered due to a power on, hard reset, or Management Reset request; and
- b) set the ResetStatus state machine variable to DISABLED.

If this state was entered due to power on or hard reset, then upon entry into this state, this state shall set the ResetStatus state machine variable to UNKNOWN.

If this state was entered because of a Management Reset request, then upon entry into this state, this state shall:

- a) if the ResetStatus state machine variable is not set to RESET_IN_PROGRESS, SPINUP_HOLD, G1, G2, or G3, set the ResetStatus state machine variable to UNKNOWN; or
- b) if the ResetStatus state machine variable is set to RESET_IN_PROGRESS, SPINUP_HOLD, G1, G2, or G3, set the ResetStatus state machine variable to RESET_IN_PROGRESS.

If this state was not entered due to a power on, hard reset, Disable Phy, or Management Reset request, then upon entry into this state, this state shall:

- a) if the ResetStatus state machine variable is not set to PHY_RESET_PROBLEM, SPINUP_HOLD, or UNSUPPORTED_PHY_ATTACHED, set the ResetStatus state machine variable to UNKNOWN; or
- b) if the ResetStatus state machine variable is set to PHY_RESET_PROBLEM, SPINUP_HOLD, or UNSUPPORTED_PHY_ATTACHED, not change the ResetStatus state machine variable.

If the phy supports SATA port selectors and this state receives a COMWAKE Detected message, this state shall:

- a) if the ResetStatus state machine variable is not set to PHY_RESET_PROBLEM, SPINUP_HOLD, or UNSUPPORTED_PHY_ATTACHED, set the ResetStatus state machine variable to PORT_SELECTOR;
- b) set the COMWAKE_Received state machine variable to one; and
- c) if the ATTACHED SATA PORT SELECTOR bit is set to zero in the SMP DISCOVER response (see 10.4.3.10):
 - A) set the ATTACHED SATA PORT SELECTOR bit to one in the SMP DISCOVER response; and
 - B) send a SATA Port Selector Change confirmation to the link layer.

This state machine waits for receipt of a COMINIT Transmitted message and/or a COMINIT Detected message.

6.8.3.2.2 Transition SP0:OOB_COMINIT to SP1:OOB_AwaitCOMX

This transition shall occur if this state receives a COMINIT Transmitted message and has not received a COMINIT Detected message.

● Author: RElliott
Subject: Highlight
Date: 6/30/2008 6:16:52 PM
T ACCEPT - DONE

set
s/b
then set

● Author: RElliott
Subject: Highlight
Date: 6/30/2008 6:16:52 PM
T ACCEPT - DONE

send
s/b
then send

● Author: RElliott
Subject: Highlight
Date: 6/30/2008 6:16:52 PM
T ACCEPT - DONE

set
s/b
then set

● Author: RElliott
Subject: Highlight
Date: 6/30/2008 6:16:52 PM
T ACCEPT - DONE

set
s/b
then set

● Author: RElliott
Subject: Highlight
Date: 6/30/2008 6:16:52 PM
T ACCEPT - DONE

set
s/b
then set

● Author: RElliott
Subject: Highlight
Date: 6/30/2008 6:16:52 PM
T ACCEPT - DONE

not
s/b
then not

● Author: RElliott
Subject: Highlight
Date: 6/30/2008 6:16:52 PM
T ACCEPT - DONE

6.8.3.2 SP0:OOB_COMINIT state

6.8.3.2.1 State description

This state is the initial state for this state machine.

Upon entry into this state, the phy shall:

- a) set the COMWAKE_Received state machine variable to zero;
- b) send a Stop DWS message to the SP_DWS state machine;
- c) send a Phy Layer Not Ready confirmation to the link layer;
- d) set the ATTACHED SATA DEVICE bit to zero in the SMP DISCOVER response (see 10.4.3.10);
- e) if this state was entered due to power on, **set** the ATTACHED SATA PORT SELECTOR bit to zero in the SMP DISCOVER response (see 10.4.3.10); and
- f) if this state was not entered because of a Disable Phy request, **send** a Transmit COMINIT message to the SP transmitter.

If this state was entered because of a Disable Phy request, then upon entry into this state, this state shall:

- a) ignore COMINIT Detected messages until this state is re-entered due to a power on, hard reset, or Management Reset request; and
- b) set the ResetStatus state machine variable to DISABLED.

If this state was entered due to power on or hard reset, then upon entry into this state, this state shall set the ResetStatus state machine variable to UNKNOWN.

If this state was entered because of a Management Reset request, then upon entry into this state, this state shall:

- a) if the ResetStatus state machine variable is not set to RESET_IN_PROGRESS, SPINUP_HOLD, G1, G2, or G3, **set** the ResetStatus state machine variable to UNKNOWN; or
- b) if the ResetStatus state machine variable is set to RESET_IN_PROGRESS, SPINUP_HOLD, G1, G2, or G3, **set** the ResetStatus state machine variable to RESET_IN_PROGRESS.

If this state was not entered due to a power on, hard reset, Disable Phy, or Management Reset request, then upon entry into this state, this state shall:

- a) if the ResetStatus state machine variable is not set to PHY_RESET_PROBLEM, SPINUP_HOLD, or UNSUPPORTED_PHY_ATTACHED, **set** the ResetStatus state machine variable to UNKNOWN; or
- b) if the ResetStatus state machine variable is set to PHY_RESET_PROBLEM, SPINUP_HOLD, or UNSUPPORTED_PHY_ATTACHED, **not** change the ResetStatus state machine variable.

If the phy supports SATA port selectors and this state receives a COMWAKE Detected message, this state shall:

- a) if the ResetStatus state machine variable is not set to PHY_RESET_PROBLEM, SPINUP_HOLD, or UNSUPPORTED_PHY_ATTACHED, **set** the ResetStatus state machine variable to PORT_SELECTOR;
- b) set the COMWAKE_Received state machine variable to one; and
- c) if the ATTACHED SATA PORT SELECTOR bit is set to zero in the SMP DISCOVER response (see 10.4.3.10):
 - A) set the ATTACHED SATA PORT SELECTOR bit to one in the SMP DISCOVER response; and
 - B) send a SATA Port Selector Change confirmation to the link layer.

This state machine waits for receipt of a COMINIT Transmitted message and/or a COMINIT Detected message.

6.8.3.2.2 Transition SP0:OOB_COMINIT to SP1:OOB_AwaitCOMX

This transition shall occur if this state receives a COMINIT Transmitted message and has not received a COMINIT Detected message.

set
s/b
then set

Author: RElliott
Subject: Highlight
Date: 6/30/2008 6:16:52 PM

T ACCEPT - DONE

:
s/b
, then:

6.8.3.2.3 Transition SP0:OOB_COMINIT to SP3:OOB_AwaitCOMINIT_Sent

This transition shall occur if this state receives a COMINIT Detected message and has not received a COMINIT Transmitted message.

6.8.3.2.4 Transition SP0:OOB_COMINIT to SP4:OOB_COMSAS

This transition shall occur if this state receives both a COMINIT Transmitted message and a COMINIT Detected message.

6.8.3.3 SP1:OOB_AwaitCOMX state

6.8.3.3.1 State description

Upon entry into this state, the phy shall initialize and start the Hot-Plug Timeout timer if this phy is:

- a) an expander phy; or
- b) an initiator phy or target phy implementing the Hot-Plug Timeout timer.

If the phy supports SATA port selectors and this state receives a COMWAKE Detected message, this state shall:

- a) if the ResetStatus state machine variable is not set to PHY_RESET_PROBLEM, SPINUP_HOLD, or UNSUPPORTED_PHY_ATTACHED, set the ResetStatus state machine variable to PORT_SELECTOR;
- b) set the COMWAKE_Received state machine variable to one; and
- c) if the ATTACHED SATA PORT SELECTOR bit is set to zero in the SMP DISCOVER response (see 10.4.3.10):
 - A) set the ATTACHED SATA PORT SELECTOR bit to one in the SMP DISCOVER response; and
 - B) send a SATA Port Selector Change confirmation to the link layer.

6.8.3.3.2 Transition SP1:OOB_AwaitCOMX to SP0:OOB_COMINIT

This transition shall occur if the Hot-Plug Timeout timer expires.

If the COMWAKE_Received state machine variable is set to zero and the ATTACHED SATA PORT SELECTOR bit is set to one in the SMP DISCOVER response (see 10.4.3.10), the state machine shall, before the transition:

- a) set the ATTACHED SATA PORT SELECTOR bit to zero in the SMP DISCOVER response; and
- b) send a SATA Port Selector Change confirmation to the link layer.

Before the transition, if this state was entered from SP0:OOB_COMINIT, this state shall set the ResetStatus state machine variable to UNKNOWN.

6.8.3.3.3 Transition SP1:OOB_AwaitCOMX to SP4:OOB_COMSAS

This transition shall occur after receiving either a COMINIT Detected message or a COMSAS Detected message. If COMSAS Detected was received, this transition shall include a COMSAS Detected argument.

If the ATTACHED SATA PORT SELECTOR bit is set to one in the SMP DISCOVER response (see 10.4.3.10), the state machine shall, before the transition:

- a) set the ATTACHED SATA PORT SELECTOR bit to zero in the SMP DISCOVER response; and
- b) send a SATA Port Selector Change confirmation to the link layer.

6.8.3.4 SP2:OOB_NoCOMSASTimeout state

6.8.3.4.1 State description

Upon entry into this state, the phy shall initialize and start the Hot-Plug Timeout timer if this phy is:

- a) this phy is an expander phy; or
- b) this phy is an initiator phy or target phy implementing the Hot-Plug Timeout timer.

Author: intc-mseidel

Subject: Highlight

Date: 8/27/2008 5:20:12 PM

T ACCEPT - DONE (7/14 incorporate 08-283r1 to resolve (SATA port selector issue). See hpq-relliott comment on PDF pg 245)

There is potential for a phy to become confused during Speed Negotiation during this state. Consider Phy1 supporting only 6G talking with Phy2 supporting only 1.5G, 3G, and SATA, or 1.5G and SATA. Phy2 will transmit ALIGN during SNW-1 and SNW-2, while Phy1 will transmit D.C. idle. During SNW-3, Phy1 will transmit COMWAKEs as part of the phy capabilities data, but Phy2 will have transitioned to SP1:OOB_AwaitCOMX from SP14:SAS_Fail, since the maximum SAS speed negotiation window has been attempted and there have not been any successful negotiated physical link rates. Once in the SP1:Await_COMX state, Phy2 will detect COMWAKE and (if it supports SATA port selectors) then decide that the attached phy is a SATA port selector. Phy2 would then run the TRANSMIT SATA PORT SELECTION SIGNAL phy operation, which sends a sequence of five COMINIT OOB signals. There should be a note in the standard explaining this interaction, and also we should ensure that the state machines don't do anything funny under all combinations of SAS/SATA Gen1/2/3 support. For example, when the Gen1-only phy decides it is connected to a SATA port selector, it can send a SATA port selection signal consisting of several COMINITs. These COMINITs can reset the Gen3 phy, causing an endless cycle.

Author: RElliott

Subject: Highlight

Date: 6/30/2008 6:16:52 PM

T ACCEPT - DONE

set
s/b
then set

Author: RElliott

Subject: Highlight

Date: 6/30/2008 6:16:52 PM

T ACCEPT - DONE

:
s/b
, then:

Author: RElliott

Subject: Highlight

Date: 6/30/2008 6:16:52 PM

T ACCEPT - DONE

the
s/b
then the

Author: RElliott

Subject: Cross-Out

Date: 6/30/2008 6:16:52 PM

T ACCEPT - DONE

either

Author: RElliott

Subject: Highlight

Date: 6/30/2008 6:16:52 PM

T ACCEPT - DONE

this
s/b

6.8.3.2.3 Transition SP0:OOB_COMINIT to SP3:OOB_AwaitCOMINIT_Sent

This transition shall occur if this state receives a COMINIT Detected message and has not received a COMINIT Transmitted message.

6.8.3.2.4 Transition SP0:OOB_COMINIT to SP4:OOB_COMSAS

This transition shall occur if this state receives both a COMINIT Transmitted message and a COMINIT Detected message.

6.8.3.3 SP1:OOB_AwaitCOMX state

6.8.3.3.1 State description

Upon entry into this state, the phy shall initialize and start the Hot-Plug Timeout timer if this phy is:

- a) an expander phy; or
- b) an initiator phy or target phy implementing the Hot-Plug Timeout timer.

If the phy supports SATA port selectors and this state receives a COMWAKE Detected message, this state shall:

- a) if the ResetStatus state machine variable is not set to PHY_RESET_PROBLEM, SPINUP_HOLD, or UNSUPPORTED_PHY_ATTACHED, set the ResetStatus state machine variable to PORT_SELECTOR;
- b) set the COMWAKE_Received state machine variable to one; and
- c) if the ATTACHED SATA PORT SELECTOR bit is set to zero in the SMP DISCOVER response (see 10.4.3.10):
 - A) set the ATTACHED SATA PORT SELECTOR bit to one in the SMP DISCOVER response; and
 - B) send a SATA Port Selector Change confirmation to the link layer.

6.8.3.3.2 Transition SP1:OOB_AwaitCOMX to SP0:OOB_COMINIT

This transition shall occur if the Hot-Plug Timeout timer expires.

If the COMWAKE_Received state machine variable is set to zero and the ATTACHED SATA PORT SELECTOR bit is set to one in the SMP DISCOVER response (see 10.4.3.10), the state machine shall, before the transition:

- a) set the ATTACHED SATA PORT SELECTOR bit to zero in the SMP DISCOVER response; and
- b) send a SATA Port Selector Change confirmation to the link layer.

Before the transition, if this state was entered from SP0:OOB_COMINIT, this state shall set the ResetStatus state machine variable to UNKNOWN.

6.8.3.3.3 Transition SP1:OOB_AwaitCOMX to SP4:OOB_COMSAS

This transition shall occur after receiving either a COMINIT Detected message or a COMSAS Detected message. If COMSAS Detected was received, this transition shall include a COMSAS Detected argument.

If the ATTACHED SATA PORT SELECTOR bit is set to one in the SMP DISCOVER response (see 10.4.3.10), the state machine shall, before the transition:

- a) set the ATTACHED SATA PORT SELECTOR bit to zero in the SMP DISCOVER response; and
- b) send a SATA Port Selector Change confirmation to the link layer.

6.8.3.4 SP2:OOB_NoCOMSASTimeout state

6.8.3.4.1 State description

Upon entry into this state, the phy shall initialize and start the Hot-Plug Timeout timer if this phy is:

- a) this phy is an expander phy; or
- b) this phy is an initiator phy or target phy implementing the Hot-Plug Timeout timer.

then this

Author: RElliott
Subject: Highlight
Date: 6/30/2008 6:16:52 PM
ACCEPT - DONE

the
s/b
then the

6.8.3.4.2 Transition SP2:OOB_NoCOMSASTimeout to SP0:OOB_COMINIT

This transition shall occur if the Hot-Plug Timeout timer expires.

6.8.3.4.3 Transition SP2:OOB_NoCOMSASTimeout to SP4:OOB_COMSAS

This transition shall occur after receiving a COMINIT Detected message.

6.8.3.5 SP3:OOB_AwaitCOMINIT_Sent state**6.8.3.5.1 State description**

This state waits for a COMINIT Transmitted message.

If the phy supports SATA port selectors and this state receives a COMWAKE Detected message, this state shall:

- a) if the ResetStatus state machine variable is not set to PHY_RESET_PROBLEM, SPINUP_HOLD, or UNSUPPORTED_PHY_ATTACHED, set the ResetStatus state machine variable to PORT_SELECTOR; and
- b) if the ATTACHED SATA PORT SELECTOR bit is set to zero in the SMP DISCOVER response (see 10.4.3.10):
 - A) set the ATTACHED SATA PORT SELECTOR bit to one in the SMP DISCOVER response; and
 - B) send a SATA Port Selector Change confirmation to the link layer.

6.8.3.5.2 Transition SP3:OOB_AwaitCOMINIT_Sent to SP4:OOB_COMSAS

This transition shall occur after receiving a COMINIT Transmitted message.

6.8.3.6 SP4:OOB_COMSAS state**6.8.3.6.1 State description**

Upon entry into this state, the phy shall send a Transmit COMSAS message to the SP transmitter.

This state waits for receipt of a COMSAS Transmitted message and/or a COMSAS Detected message.

If the phy supports SATA port selectors and this state receives a COMWAKE Detected message, this state shall:

- a) if the ResetStatus state machine variable is not set to PHY_RESET_PROBLEM, SPINUP_HOLD, or UNSUPPORTED_PHY_ATTACHED, set the ResetStatus state machine variable to PORT_SELECTOR; and
- b) if the ATTACHED SATA PORT SELECTOR bit is set to zero in the SMP DISCOVER response (see 10.4.3.10):
 - A) set the ATTACHED SATA PORT SELECTOR bit to one in the SMP DISCOVER response; and
 - B) send a SATA Port Selector Change confirmation to the link layer.

6.8.3.6.2 Transition SP4:OOB_COMSAS to SP5:OOB_AwaitCOMSAS_Sent

This transition shall occur if this state receives a COMSAS Detected message or this state was entered with a COMSAS Detected argument, and this state has not received a COMSAS Transmitted message.

If the ATTACHED SATA PORT SELECTOR bit is set to one in the SMP DISCOVER response (see 10.4.3.10), the state machine shall set the ATTACHED SATA PORT SELECTOR bit to zero in the SMP DISCOVER response and send a SATA Port Selector Change confirmation to the link layer before the transition.

6.8.3.6.3 Transition SP4:OOB_COMSAS to SP6:OOB_AwaitNoCOMSAS

This transition shall occur if this state receives both a COMSAS Transmitted message and a COMSAS Detected message.

● Author: RElliott
Subject: Highlight
Date: 6/30/2008 6:16:52 PM
T ACCEPT - DONE

set
s/b
then set

● Author: RElliott
Subject: Highlight
Date: 6/30/2008 6:16:52 PM
T ACCEPT - DONE

:
s/b
, then:

● Author: RElliott
Subject: Highlight
Date: 6/30/2008 6:16:52 PM
T ACCEPT - DONE

this
s/b
then this

● Author: RElliott
Subject: Highlight
Date: 6/30/2008 6:16:52 PM
T ACCEPT - DONE

set
s/b
then set

● Author: RElliott
Subject: Highlight
Date: 6/30/2008 6:16:52 PM
T ACCEPT - DONE

:
s/b
, then:

● Author: RElliott
Subject: Highlight
Date: 6/30/2008 6:16:52 PM
T ACCEPT - DONE

the
s/b
then the

If the ATTACHED SATA PORT SELECTOR bit is set to one in the SMP DISCOVER response (see 10.4.3.10), the state machine shall set the ATTACHED SATA PORT SELECTOR bit to zero in the SMP DISCOVER response and send a SATA Port Selector Change confirmation to the link layer before the transition.

6.8.3.6.4 Transition SP4:OOB_COMSAS to SP7:OOB_AwaitCOMSAS

This transition shall occur if this state receives a COMSAS Transmitted message and has not received a COMSAS Detected message.

6.8.3.7 SP5:OOB_AwaitCOMSAS_Sent state

6.8.3.7.1 State description

This state waits for receipt of a COMSAS Transmitted message.

6.8.3.7.2 Transition SP5:OOB_AwaitCOMSAS_Sent to SP6:OOB_AwaitNoCOMSAS

This transition shall occur after receiving a COMSAS Transmitted message.

If this state received a COMSAS Completed message, it shall include a COMSAS Completed argument with the transition.

6.8.3.8 SP6:OOB_AwaitNoCOMSAS state

6.8.3.8.1 State description

This state machine waits for a COMSAS Completed message, which indicates that COMSAS has been completely received.

6.8.3.8.2 Transition SP6:OOB_AwaitNoCOMSAS to SP0:OOB_COMINIT

This transition shall occur after receiving a COMINIT Detected message.

Before the transition, this state shall set the ResetStatus state machine variable to UNKNOWN.

6.8.3.8.3 Transition SP6:OOB_AwaitNoCOMSAS to SP8:SAS_Start

This transition shall occur after receiving a COMSAS Completed message, or shall occur if a COMSAS Completed argument was received in the transition.

6.8.3.9 SP7:OOB_AwaitCOMSAS state

6.8.3.9.1 State description

Upon entry into this state, the phy shall initialize and start the COMSAS Detect Timeout timer.

6.8.3.9.2 Transition SP7:OOB_AwaitCOMSAS to SP2:OOB_NoCOMSASTimeout

This transition shall occur if the phy does not support SATA and the COMSAS Detect Timeout timer expires. The state machine shall set the MgmtReset state machine variable to zero before the transition.

6.8.3.9.3 Transition SP7:OOB_AwaitCOMSAS to SP6:OOB_AwaitNoCOMSAS

This transition shall occur after receiving a COMSAS Detected message.

The state machine shall set the MgmtReset state machine variable to zero before the transition.

The state machine shall set the ATTACHED SATA PORT SELECTOR bit to zero in the SMP DISCOVER response (see 10.4.3.10). If the ATTACHED SATA PORT SELECTOR bit in the SMP DISCOVER response was set to one prior to this transition, the state machine shall send a SATA Port Selector Change confirmation to the link layer before the transition.

● Author: RElliott
Subject: Highlight
Date: 6/30/2008 6:16:52 PM
T ACCEPT - DONE

the
s/b
then the

● Author: wdc-mevans
Subject: Highlight
Date: 5/25/2008 7:26:21 PM
T REJECT (but added "then")

it
s/b
then this state

6.8.3.9.4 Transition SP7:OOB_AwaitCOMSAS to SP16:SATA_COMWAKE

This transition shall occur if:

- a) the phy supports SATA;
- b) the COMSAS Detect Timeout timer expires; and
 - A) the MgmtReset state machine variable is set to one; or
 - B) the phy does not implement SATA spinup hold.

The state machine shall set the MgmtReset state machine variable to zero before the transition.

The state machine shall set the ATTACHED SATA DEVICE bit to one in the SMP DISCOVER response (see 10.4.3.10) before the transition.

6.8.3.9.5 Transition SP7:OOB_AwaitCOMSAS to SP26:SATA_SpinupHold

This transition shall occur if:

- a) the phy supports SATA;
- b) the COMSAS Detect Timeout timer expires;
- c) the phy implements SATA spinup hold; and
- d) the MgmtReset state machine variable is set to zero.

The state machine shall set the ATTACHED SATA DEVICE bit to one in the SMP DISCOVER response (see 10.4.3.10) before the transition.

6.8.4 SAS speed negotiation states

6.8.4.1 SAS speed negotiation states overview

Figure 155 shows the SAS speed negotiation states, in which the phy has detected that it is attached to a SAS phy or expander phy rather than a SATA phy, and performs the SAS speed negotiation sequence. These states are indicated by state names with a prefix of SAS.

● Author: wdc-mevans
Subject: Highlight
Date: 5/25/2008 7:26:45 PM

T REJECT (this is a definition of the whole not a subset)

states, in
s/b
states in

● Author: wdc-mevans
Subject: Highlight
Date: 5/21/2008 6:09:24 PM

T REJECT

and performs
s/b
and the states in the state machine perform

● Author: RElliott
Subject: Note
Date: 6/30/2008 6:16:52 PM
 ACCEPT - DONE

SP8 to SP1 transition is missing

This is taken if SP14:SAS_Fail runs out of SNWs and none have been valid. Rather than going right to SP1 as in SAS-1.1, SAS-2 visits SP8 first...

● Author: RElliott
Subject: Highlight
Date: 8/31/2008 9:09:48 PM
 ACCEPT - DONE

Set Rate

Change to
Set Physical Link Rate
and
Set SSC

Figure 156 shows the SAS speed negotiation states related to SNW-3 and Train-SNW.

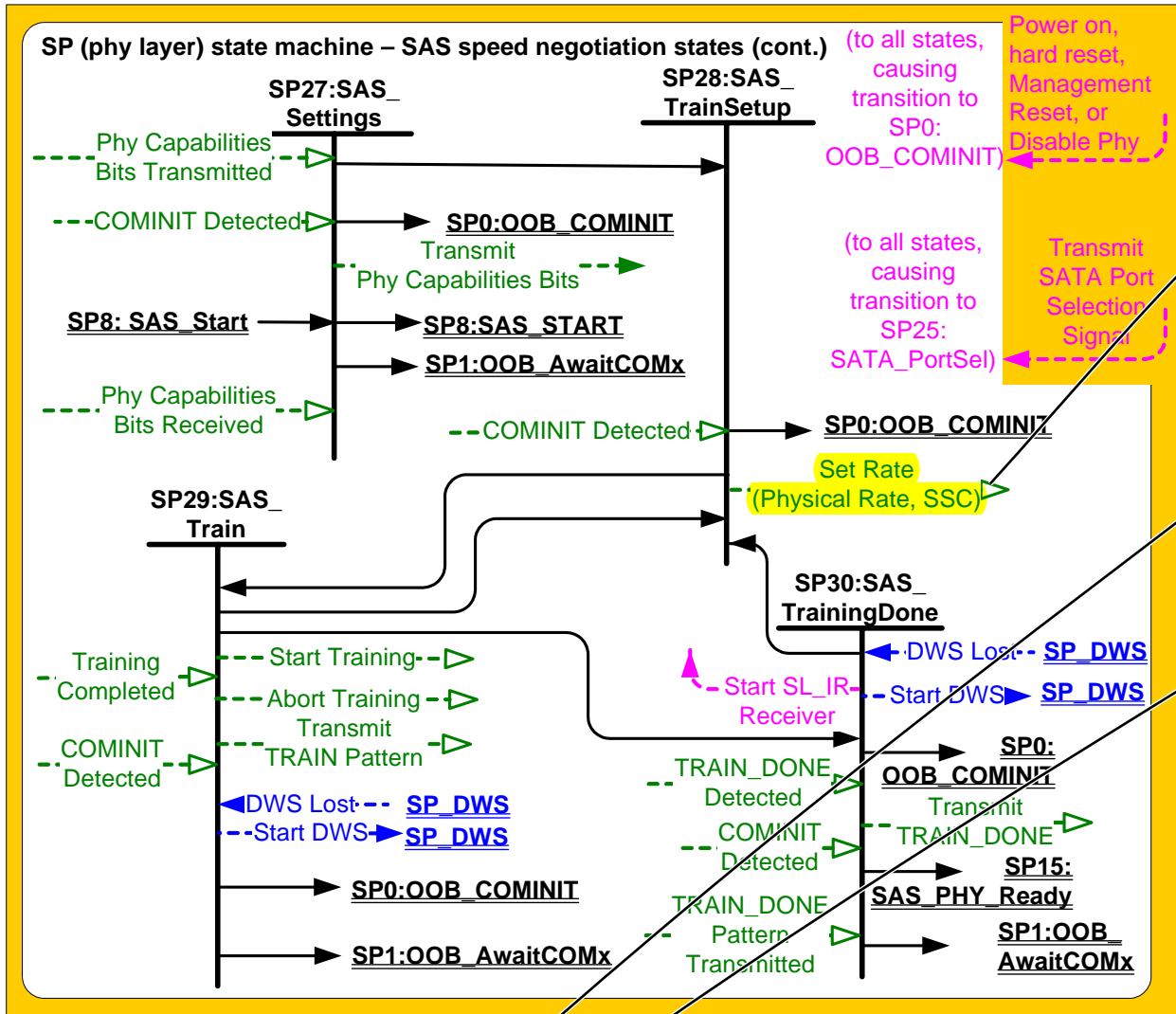

Figure 156 — SP (phy layer) state machine - SAS speed negotiation states for SNW-3 and Train-SNW

6.8.4.2 SP8:SAS_Start state

6.8.4.2.1 State description

This is the initial state for the SAS speed negotiation sequence.

Upon entry into this state, the phy shall initialize and start the RCDT timer.

If this state is entered from SP6:OOB_AwaitNoCOMSAS, then the Current SNW state machine variable shall be set to SNW-1. If this state is not entered from SP6:OOB_AwaitNoCOMSAS, then the Current SNW state machine variable shall be set to:

- a) SNW-2 if the Current SNW state machine variable is set to SNW-1;
- a) SNW-3 if the Current SNW state machine variable is set to SNW-2, and either SNW-1 is invalid or SNW-2 is valid;
- b) Final-SNW if the Current SNW state machine variable is set to SNW-2, SNW-1 is valid, and SNW-2 is invalid;
- c) Final-SNW if the Current SNW state machine variable is set to SNW-3, SNW-3 is invalid, and SNW-2 is valid; or
- d) Unsupported Phy Attached if the Current SNW state machine variable is set to SNW-3, SNW-3 is invalid, and SNW-2 is invalid.

● Author: RElliott
Subject: Highlight
Date: 8/31/2008 9:30:44 PM
T ACCEPT - DONE

Set Rate (Physical Rate, SSC)

Split into
Set Physical Link Rate
and Set SSC

● Author: Isi-bday
Subject: Highlight
Date: 5/25/2008 7:27:15 PM
T ACCEPT - DONE

a)
list is not incrementing correctly.

● Author: stx-goulder
Subject: Highlight
Date: 5/6/2008 4:07:49 PM
T ACCEPT - DONE

a) There are two item a's. The list should be itemized a through e.

After the Current SNW state machine variable is updated, if the Current SNW state machine variable is not set to Unsupported Phy Attached, then this state shall:

- a) ~~initialize and start the RCDT timer; and~~
- b) if the SNW specified by the Current SNW state machine variable is supported, send a Set Rate message to the SP transmitter and SP receiver with:
 - A) the Physical Link Rate argument set to 1.5 Gbps and an SSC Off argument, if the Current SNW state machine variable is set to SNW-1;
 - B) the Physical Link Rate argument set to 3 Gbps and an SSC Off argument, if the Current SNW state machine variable is set to SNW-2;
 - C) the Physical Link Rate argument set to 1.5 Gbps and an SSC Off argument, if the Current SNW state machine variable is set to Final-SNW, SNW-1 was valid and SNW-2 was invalid;
 - D) the Physical Link Rate argument set to 3 Gbps and an SSC Off argument, if the Current SNW state machine variable is set to Final-SNW and SNW-2 was valid; or
 - E) the Physical Link Rate argument set to 1.5 Gbps and either an SSC On argument or an SSC Off argument, if the Current SNW state machine variable is set to SNW-3.

During this state D.C. idle shall be transmitted.

6.8.4.2.2 Transition SP8:SAS_Start to SP0:OOB_COMINIT

This transition shall occur after receiving a COMINIT Detected message.

Before the transition, this state shall set the ResetStatus state machine variable to UNKNOWN.

6.8.4.2.3 Transition SP8:SAS_Start to SP1:OOB_AwaitCOMX

This transition shall occur if the Current SNW state machine variable is set to Unsupported Phy Attached.

Before the transition, this state shall set the ResetStatus state machine variable to UNSUPPORTED_PHY_ATTACHED.

6.8.4.2.4 Transition SP8:SAS_Start to SP9:SAS_WindowNotSupported

This transition shall occur after the RCDT timer expires if the SNW indicated by the Current SNW state machine variable is not supported.

6.8.4.2.5 Transition SP8:SAS_Start to SP10:SAS_AwaitALIGN

This transition shall occur after the RCDT timer expires if:

- a) the Current SNW state machine variable is not set to SNW-3; and
- b) the SNW indicated by the Current SNW state machine variable is supported.

6.8.4.2.6 Transition SP8:SAS_Start to SP27:SAS_Settings

This transition shall occur after the RCDT timer expires if:

- a) the Current SNW state machine variable is set to SNW-3; and
- b) SNW-3 is supported.

6.8.4.3 SP9:SAS_WindowNotSupported state

6.8.4.3.1 State description

Upon entry into this state, the phy shall initialize and start the SNTT timer.

During this state D.C. idle shall be transmitted.

6.8.4.3.2 Transition SP9:SAS_WindowNotSupported to SP14:SAS_Fail

This transition shall occur after the SNTT timer expires.

● Author: lsi-bday
Subject: Cross-Out
Date: 6/25/2008 11:16:40 AM
 ACCEPT - DONE (reworded as:

After the Current SNW state machine variable is updated, if:
a) the Current SNW state machine variable is not set to Unsupported Phy Attached; and
b) the SNW specified by the Current SNW state machine variable is supported,
then this state shall send a Set Rate message to the SP transmitter and SP receiver with:
a) the Physical Link Rate argument set to 1.5 Gbps and an SSC Off argument, if the Current SNW state machine variable is set to SNW-1;
...
)

initialize and start the RCDT timer

Not needed here, since this is already listed upon entry into this state.

● Author: lsi-gpenokie
Subject: Highlight
Date: 5/25/2008 7:27:30 PM
 ACCEPT - DONE

This << supported, send a Set >> should be << supported, then send a Set >>

● Author: RElliott
Subject: Note
Date: 8/31/2008 9:31:46 PM
 ACCEPT - DONE

Convert A)B)C)D)E) into a table, with question columns of:
Current SNW
Other conditions

and answer columns of:
Message(s) to SP transmitter
Messages to SP receiver

Change Set Rate into two messages: Set Physical Link Rate and Set SSC since the receiver doesn't care (as much) about SSC (see other comments)

● Author: lsi-bday
Subject: Highlight
Date: 8/31/2008 8:58:19 PM

 ACCEPT - DONE (Agree, that Set Rate is bogus. Deleting as part of converting this to a table. Setting SSC on or off is still important, though, since we allow SSC to be enabled during SNW-3.)

the Physical Link Rate argument set to 1.5 Gbps.

Is 1.5G operation required? If not, then setting to 1.5 isn't a requirement here, since OOB signalling with "effective" 1.5G OOB signal can happen with transmitter being set to something higher. I think item E can be deleted, since the appropriate Set Rate will happen prior to training.

● Author: wdc-mevans
Subject: Highlight
Date: 5/25/2008 7:28:02 PM

 REJECT (there are 136 instances of "after receiving" vs 17 of "after this state receives". The shorter wording wins.)

receiving
s/b

After the Current SNW state machine variable is updated, if the Current SNW state machine variable is not set to Unsupported Phy Attached, then this state shall:

- a) ~~initialize and start the RCDT timer~~; and
- b) if the SNW specified by the Current SNW state machine variable is supported, send a Set Rate message to the SP transmitter and SP receiver with:
 - A) the Physical Link Rate argument set to 1.5 Gbps and an SSC Off argument, if the Current SNW state machine variable is set to SNW-1;
 - B) the Physical Link Rate argument set to 3 Gbps and an SSC Off argument, if the Current SNW state machine variable is set to SNW-2;
 - C) the Physical Link Rate argument set to 1.5 Gbps and an SSC Off argument, if the Current SNW state machine variable is set to Final-SNW, SNW-1 was valid and SNW-2 was invalid;
 - D) the Physical Link Rate argument set to 3 Gbps and an SSC Off argument, if the Current SNW state machine variable is set to Final-SNW and SNW-2 was valid; or
 - E) the Physical Link Rate argument set to 1.5 Gbps and either an SSC On argument or an SSC Off argument, if the Current SNW state machine variable is set to SNW-3.

During this state D.C. idle shall be transmitted.

6.8.4.2.2 Transition SP8:SAS_Start to SP0:OOB_COMINIT

This transition shall occur after receiving a COMINIT Detected message.

Before the transition, this state shall set the ResetStatus state machine variable to UNKNOWN.

6.8.4.2.3 Transition SP8:SAS_Start to SP1:OOB_AwaitCOMX

This transition shall occur if the Current SNW state machine variable is set to Unsupported Phy Attached.

Before the transition, this state shall set the ResetStatus state machine variable to UNSUPPORTED_PHY_ATTACHED.

6.8.4.2.4 Transition SP8:SAS_Start to SP9:SAS_WindowNotSupported

This transition shall occur after the RCDT timer expires if the SNW indicated by the Current SNW state machine variable is not supported.

6.8.4.2.5 Transition SP8:SAS_Start to SP10:SAS_AwaitALIGN

This transition shall occur after the RCDT timer expires if:

- a) the Current SNW state machine variable is not set to SNW-3; and
- b) the SNW indicated by the Current SNW state machine variable is supported.

6.8.4.2.6 Transition SP8:SAS_Start to SP27:SAS_Settings

This transition shall occur after the RCDT timer expires if:

- a) the Current SNW state machine variable is set to SNW-3; and
- b) SNW-3 is supported.

6.8.4.3 SP9:SAS_WindowNotSupported state

6.8.4.3.1 State description

Upon entry into this state, the phy shall initialize and start the SNTT timer.

During this state D.C. idle shall be transmitted.

6.8.4.3.2 Transition SP9:SAS_WindowNotSupported to SP14:SAS_Fail

This transition shall occur after the SNTT timer expires.

this state receives

6.8.4.4 SP10:SAS_AwaitALIGN state**6.8.4.4.1 State description**

Upon entry into this state, the phy shall:

- a) initialize and start the SNTT timer and SNLT timer;
- b) send a Start DWS message to the SP_DWS state machine; and
- c) repeatedly send Transmit ALIGN (0) messages to the SP transmitter.

Each time this state receives a DWS Lost message, this state may send a Start DWS message to the SP_DWS state machine to re-acquire dword synchronization without running a new link reset sequence.

6.8.4.4.2 Transition SP10:SAS_AwaitALIGN to SP0:OOB_COMINIT

This transition shall occur after receiving a DWS Lost message if this state does not send a Start DWS message, or after receiving a COMINIT Detected message.

Before the transition, this state shall set the ResetStatus state machine variable to UNKNOWN.

6.8.4.4.3 Transition SP10:SAS_AwaitALIGN to SP11:SAS_AwaitALIGN1

This transition shall occur if this state receives an ALIGN Received (0) message before the SNLT timer expires.

6.8.4.4.4 Transition SP10:SAS_AwaitALIGN to SP12:SAS_AwaitSNW

This transition shall occur if this state receives an ALIGN Received (1) message before the SNLT timer expires.

6.8.4.4.5 Transition SP10:SAS_AwaitALIGN to SP14:SAS_Fail

This transition shall occur if the SNTT timer expires.

6.8.4.5 SP11:SAS_AwaitALIGN1 state**6.8.4.5.1 State description**

This state shall repeatedly send Transmit ALIGN (1) messages to the SP transmitter.

Each time this state receives a DWS Lost message, this state may send a Start DWS message to the SP_DWS state machine to re-acquire dword synchronization without running a new link reset sequence.

6.8.4.5.2 Transition SP11:SAS_AwaitALIGN1 to SP0:OOB_COMINIT

This transition shall occur after receiving a DWS Lost message if this state does not send a Start DWS message, or after receiving a COMINIT Detected message.

Before the transition, this state shall set the ResetStatus state machine variable to UNKNOWN.

6.8.4.5.3 Transition SP11:SAS_AwaitALIGN1 to SP12:SAS_AwaitSNW

This transition shall occur if this state receives an ALIGN Received (1) message before the SNLT timer expires. This indicates that the other phy has been able to achieve dword synchronization in the current SNW.

6.8.4.5.4 Transition SP11:SAS_AwaitALIGN1 to SP14:SAS_Fail

This transition shall occur if the SNTT timer expires. This indicates that the other phy has not been able to achieve dword synchronization in the current SNW.

● Author: wdc-mevans

Subject: Highlight

Date: 5/25/2008 7:28:24 PM

T REJECT (there are 136 instances of "after receiving" vs 17 of "after this state receives". The shorter wording wins.)

receiving

s/b

this state receives

● Author: wdc-mevans

Subject: Highlight

Date: 5/25/2008 7:28:35 PM

T REJECT

receiving

s/b

this state receives

● Author: wdc-mevans

Subject: Highlight

Date: 5/21/2008 6:02:16 PM

T ACCEPT - DONE (converted into an a)b) list)

message, or

s/b

message or

● Author: wdc-mevans

Subject: Highlight

Date: 5/21/2008 6:10:21 PM

T ACCEPT - DONE

other

s/b

attached

● Author: wdc-mevans

Subject: Highlight

Date: 5/21/2008 6:10:34 PM

T ACCEPT - DONE

other

s/b

attached

6.8.4.6 SP12:SAS_AwaitSNW state**6.8.4.6.1 State description**

This state shall repeatedly send Transmit ALIGN (1) messages to the SP transmitter.

If the Current SNW state machine variable is set to Final-SNW, this state shall send a Start SL_IR Receiver confirmation to the link layer.

Each time this state receives a DWS Lost message, this state may send a Start DWS message to the SP_DWS state machine to re-acquire dword synchronization without running a new link reset sequence.

This state waits for the SNTT timer to expire or for a Stop SNTT request.

6.8.4.6.2 Transition SP12:SAS_AwaitSNW to SP0:OOB_COMINIT

This transition shall occur after receiving a DWS Lost message if this state does not send a Start DWS message, or after receiving a COMINIT Detected message.

Before the transition, this state shall set the ResetStatus state machine variable to UNKNOWN.

6.8.4.6.3 Transition SP12:SAS_AwaitSNW to SP13:SAS_Pass

This transition shall occur after the SNTT timer expires or after receiving a Stop SNTT request.

6.8.4.7 SP13:SAS_Pass state**6.8.4.7.1 State description**

This state determines if:

- a) another SAS SNW is required; or
- b) the SAS speed negotiation sequence is complete.

Each time this state receives a DWS Lost message, this state may send a Start DWS message to the SP_DWS state machine to re-acquire dword synchronization without running a new link reset sequence.

6.8.4.7.2 Transition SP13:SAS_Pass to SP0:OOB_COMINIT

This transition shall occur after receiving a DWS Lost message if this state does not send a Start DWS message, or after receiving a COMINIT Detected message.

Before the transition, this state shall set the ResetStatus state machine variable to UNKNOWN.

6.8.4.7.3 Transition SP13:SAS_Pass to SP8:SAS_Start

This transition shall occur if the Current SNW state machine variable is not set to Final-SNW.

6.8.4.7.4 Transition SP13:SAS_Pass to SP15:SAS_PHY_Ready

This transition shall occur if the Current SNW state machine variable is set to Final-SNW.

6.8.4.8 SP14:SAS_Fail state**6.8.4.8.1 State description**

This state determines if:

- a) another SAS SNW is required; or
- b) the SAS speed negotiation sequence is complete.

6.8.4.8.2 Transition SP14:SAS_Fail to SP1:OOB_AwaitCOMX

This transition shall occur if the Current SNW state machine variable is set to Final-SNW.

Before the transition, this state shall set the ResetStatus state machine variable to PHY_RESET_PROBLEM.

● Author: wdc-mevans
Subject: Highlight
Date: 5/25/2008 7:28:57 PM
T REJECT

receiving
s/b
this state receives

● Author: wdc-mevans
Subject: Highlight
Date: 5/25/2008 7:29:31 PM
T REJECT (but converted into an a)b) list)

message, or after receiving
s/b
message or after this state receives

● Author: wdc-mevans
Subject: Highlight
Date: 5/25/2008 7:29:57 PM
T REJECT

receiving
s/b
this state receives

● Author: wdc-mevans
Subject: Highlight
Date: 5/21/2008 6:03:23 PM
T REJECT (but converted into an a)b) list)

message, or after receiving
s/b
message or after this state receives

6.8.4.8.3 Transition SP14:SAS_Fail to SP8:SAS_Start

This transition shall occur if the Current SNW state machine variable is not set to Final-SNW.

6.8.4.9 SP15:SAS_PHY_Ready state

6.8.4.9.1 State description

This state waits for a COMINIT Detected message, a DWS Lost message, or a DWS Reset message.

Upon entry into this state, the phy shall:

- a) if multiplexing is enabled (see table 100 in 6.7.4.2.3.3):
 - 1) send a Transmit MUX Sequence message to the SP transmitter; and
 - 2) after receiving MUX Sequence Transmitted, send a Phy Layer Ready (SAS) confirmation to the link layer ~~to indicate that the physical link has been brought up successfully in SAS mode;~~
- b) if multiplexing is not enabled, ~~send a Phy Layer Ready (SAS) confirmation to the link layer to indicate that the physical link has been brought up successfully in SAS mode;~~
- c) if the SP transmitter is transmitting at 1.5 Gbps, ~~set the ResetStatus state machine variable to G1;~~
- d) if the SP transmitter is transmitting at 3 Gbps, ~~set the ResetStatus state machine variable to G2; and~~
- e) if the SP transmitter is transmitting at 6 Gbps, ~~set the ResetStatus state machine variable to G3.~~

While in this state ~~dw~~ words from the link ~~layer~~ are transmitted ~~at the negotiated physical link rate at the rate~~ established in the previous SNW.

If multiplexing is disabled, ~~each~~ time this state receives a DWS Lost message, this state may send a Start DWS message to the SP_DWS state machine to re-acquire dword synchronization without running a new link reset sequence.

NOTE 42 - If multiplexing is enabled and this state receives a DWS Lost message, this state does not send a Start DWS message and the state machine transitions to SP0:OOB_COMINIT.

6.8.4.9.2 Transition SP15:SAS_PHY_Ready to SP0:OOB_COMINIT

This transition shall occur ~~after~~:

- a) ~~receiving~~ a DWS Lost message, if this state does not send a Start DWS message;
- b) ~~receiving~~ a DWS Lost message followed by a COMINIT Detected message, if this state does not send a Start DWS message; or
- c) ~~receiving~~ a DWS Reset message.

~~This transition may but should not occur after receiving~~ a COMINIT Detected message before receiving a DWS Lost ~~message, or after receiving~~ a COMINIT Detected message after sending a Start DWS message (i.e., the SP state machine should ignore COMINIT Detected messages unless the SP_DWS state machine has indicated loss of dword synchronization).

6.8.4.10 SP27:SAS_Settings state

6.8.4.10.1 State description

This state transmits and receives phy capabilities bits.

Upon entry to this state, the phy shall:

- a) initialize and start the SNTT timer;
- b) set the Commonly Supported Settings state machine variable to indicate that there are no commonly supported settings; and
- c) send a Transmit Phy Capabilities Bits message to the SP transmitter.

If a Phy Capabilities Bits Received message is received with the argument of ~~parity good~~, then this state shall set the Commonly Supported Settings state machine variable to the supported settings that are set to one in both the transmitted and received phy capabilities bits.

This state waits for the SNTT timer to expire.

Page: 269

● Author: RElliott
Subject: Highlight
Date: 6/30/2008 6:16:52 PM
T ACCEPT - DONE

:
s/b
, then:

● Author: Isi-gpenokie
Subject: Cross-Out
Date: 6/24/2008 8:15:56 PM
T ACCEPT - DONE

This <<to indicate that the physical link has been brought up successfully in SAS mode >> add nothing to the standard and should be deleted.

● Author: Isi-gpenokie
Subject: Cross-Out
Date: 6/24/2008 8:16:03 PM
T ACCEPT - DONE

This << to indicate that the physical link has been brought up successfully in SAS mode >> adds nothing to the standard and should be deleted.

● Author: RElliott
Subject: Highlight
Date: 6/30/2008 6:16:52 PM
T ACCEPT - DONE

send
s/b
then send

● Author: RElliott
Subject: Highlight
Date: 6/30/2008 6:16:52 PM
T ACCEPT - DONE

set
s/b
then set

● Author: RElliott
Subject: Highlight
Date: 6/30/2008 6:16:52 PM
T ACCEPT - DONE

set
s/b
then set

● Author: RElliott
Subject: Highlight
Date: 6/30/2008 6:16:52 PM
T ACCEPT - DONE

set
s/b

Comments from page 269 continued on next page

6.8.4.8.3 Transition SP14:SAS_Fail to SP8:SAS_Start

This transition shall occur if the Current SNW state machine variable is not set to Final-SNW.

6.8.4.9 SP15:SAS_PHY_Ready state

6.8.4.9.1 State description

This state waits for a COMINIT Detected message, a DWS Lost message, or a DWS Reset message.

Upon entry into this state, the phy shall:

- a) if multiplexing is enabled (see table 100 in 6.7.4.2.3.3):
 - 1) send a Transmit MUX Sequence message to the SP transmitter; and
 - 2) after receiving MUX Sequence Transmitted, send a Phy Layer Ready (SAS) confirmation to the link layer ~~to indicate that the physical link has been brought up successfully in SAS mode;~~
- b) if multiplexing is not enabled, **send** a Phy Layer Ready (SAS) confirmation to the link layer ~~to indicate that the physical link has been brought up successfully in SAS mode;~~
- c) if the SP transmitter is transmitting at 1.5 Gbps, **set** the ResetStatus state machine variable to G1;
- d) if the SP transmitter is transmitting at 3 Gbps, **set** the ResetStatus state machine variable to G2; and
- e) if the SP transmitter is transmitting at 6 Gbps, **set** the ResetStatus state machine variable to G3.

While in this **state** ~~words~~ from the link **layer** are transmitted **at the negotiated physical link rate at the rate** established in the previous SNW.

If multiplexing is disabled, **each** ~~time~~ this state receives a DWS Lost message, this state may send a Start DWS message to the SP_DWS state machine to re-acquire ~~word~~ synchronization without running a new link reset sequence.

NOTE 42 - If multiplexing is enabled and this state receives a DWS Lost message, this state does not send a Start DWS message and the state machine transitions to SP0:OOB_COMINIT.

6.8.4.9.2 Transition SP15:SAS_PHY_Ready to SP0:OOB_COMINIT

This transition shall occur **after**:

- a) ~~receiving~~ a DWS Lost message, if this state does not send a Start DWS message;
- b) ~~receiving~~ a DWS Lost message followed by a COMINIT Detected message, if this state does not send a Start DWS message; or
- c) ~~receiving~~ a DWS Reset message.

This transition may but should not occur after receiving a COMINIT Detected message before receiving a DWS Lost **message, or after receiving** a COMINIT Detected message after sending a Start DWS message (i.e., the SP state machine should ignore COMINIT Detected messages unless the SP_DWS state machine has indicated loss of dword synchronization).

6.8.4.10 SP27:SAS_Settings state

6.8.4.10.1 State description

This state transmits and receives phy capabilities bits.

Upon entry to this state, the phy shall:

- a) initialize and start the SNTT timer;
- b) set the Commonly Supported Settings state machine variable to indicate that there are no commonly supported settings; and
- c) send a Transmit Phy Capabilities Bits message to the SP transmitter.

If a Phy Capabilities Bits Received message is received with the argument of **parity good**, then this state shall set the Commonly Supported Settings state machine variable to the supported settings that are set to one in both the transmitted and received phy capabilities bits.

This state waits for the SNTT timer to expire.

then set

Author: RElliott
Subject: Highlight
Date: 6/30/2008 6:16:52 PM

T ACCEPT - DONE (changed to:
"at the negotiated physical link rate (i.e., the rate established in the previous SNW)")

at the negotiated physical link rate at the rate

doesn't make sense

Author: lsi-bday
Subject: Highlight
Date: 6/24/2008 8:13:32 PM

T REJECT (just one of each layer. There may be multiple "link layer state machines")

layer
s/b
layer(s)

could be multiple link layers if muxxing.

Author: RElliott
Subject: Highlight
Date: 6/30/2008 6:16:52 PM

T ACCEPT - DONE

state
s/b
state,

Author: RElliott
Subject: Highlight
Date: 6/30/2008 6:16:52 PM

T ACCEPT - DONE

each
s/b
then each

Author: lsi-gpenokie
Subject: Highlight
Date: 5/25/2008 7:30:47 PM

T REJECT (State descriptions define what the state machine must do when it receives certain combinations of inputs; they do not cover what the state machine must not do when infinite other possible combinations of inputs occur. The previous paragraph dictates what happens when multiplexing is disabled and DWS Lost arrives. This note explains what happens when multiplexing is enabled and DWS Lost arrives - NOTHING SPECIAL. There is no extra requirement to define here; the behavior in the note is just pointing out what happens based on the existing rules.)

This note <<NOTE 42 - If multiplexing is enabled and this state receives a DWS Lost message, this state does not send a Start DWS message and the state machine transitions to SP0:OOB_COMINIT. >> contains at least 2 requirements. One requirement << If multiplexing is enabled and this state receives a DWS Lost message, this state does not send a Start DWS message >> should be in this section. The other << If multiplexing is enabled and this state receives a DWS Lost message, the state machine transitions to SP0:OOB_COMINIT. >> should be in the transition to OOB_COMINIT section.

Author: wdc-mevans
Subject: Highlight
Date: 5/25/2008 7:31:41 PM

T REJECT (but added "receiving" here)

after:
s/b
after this state receives:

Comments from page 269 continued on next page

6.8.4.8.3 Transition SP14:SAS_Fail to SP8:SAS_Start

This transition shall occur if the Current SNW state machine variable is not set to Final-SNW.

6.8.4.9 SP15:SAS_PHY_Ready state

6.8.4.9.1 State description

This state waits for a COMINIT Detected message, a DWS Lost message, or a DWS Reset message

Upon entry into this state, the phy shall:

- a) if multiplexing is enabled (see table 100 in 6.7.4.2.3.3):
 - 1) send a Transmit MUX Sequence message to the SP transmitter; and
 - 2) after receiving MUX Sequence Transmitted, send a Phy Layer Ready (SAS) confirmation to the link layer ~~to indicate that the physical link has been brought up successfully in SAS mode;~~
- b) if multiplexing is not enabled, **send** a Phy Layer Ready (SAS) confirmation to the link layer ~~to indicate that the physical link has been brought up successfully in SAS mode;~~
- c) if the SP transmitter is transmitting at 1.5 Gbps, **set** the ResetStatus state machine variable to G1;
- d) if the SP transmitter is transmitting at 3 Gbps, **set** the ResetStatus state machine variable to G2; and
- e) if the SP transmitter is transmitting at 6 Gbps, **set** the ResetStatus state machine variable to G3.

While in this **state** **dw**ords from the link **layer** are transmitted **at the negotiated physical link rate at the rate** established in the previous SNW.

If multiplexing is disabled, **each** time this state receives a DWS Lost message, this state may send a Start DWS message to the SP_DWS state machine to re-acquire dword synchronization without running a new link reset sequence.

NOTE 42 - If multiplexing is enabled and this state receives a DWS Lost message, this state does not send a Start DWS message and the state machine transitions to SP0:OOB_COMINIT.

6.8.4.9.2 Transition SP15:SAS_PHY_Ready to SP0:OOB_COMINIT

This transition shall occur **after**:

- a) ~~receiving~~ a DWS Lost message, if this state does not send a Start DWS message;
- b) ~~receiving~~ a DWS Lost message followed by a COMINIT Detected message, if this state does not send a Start DWS message; or
- c) ~~receiving~~ a DWS Reset message.

This transition may but should not occur after receiving a COMINIT Detected message before receiving a DWS Lost message, or after receiving a COMINIT Detected message after sending a Start DWS message (i.e., the SP state machine should ignore COMINIT Detected messages unless the SP_DWS state machine has indicated loss of dword synchronization).

6.8.4.10 SP27:SAS_Settings state

6.8.4.10.1 State description

This state transmits and receives phy capabilities bits.

Upon entry to this state, the phy shall:

- a) initialize and start the SNTT timer;
- b) set the Commonly Supported Settings state machine variable to indicate that there are no commonly supported settings; and
- c) send a Transmit Phy Capabilities Bits message to the SP transmitter.

If a Phy Capabilities Bits Received message is received with the argument of **parity good**, then this state shall set the Commonly Supported Settings state machine variable to the supported settings that are set to one in both the transmitted and received phy capabilities bits.

This state waits for the SNTT timer to expire.

● Author: wdc-mevans
Subject: Cross-Out
Date: 5/25/2008 7:31:50 PM
TACCEPT - DONE

receiving
[Delete this word based on the above change.]

● Author: wdc-mevans
Subject: Cross-Out
Date: 5/25/2008 7:31:55 PM
TACCEPT - DONE

receiving
[Delete this word based on the above change.]

● Author: wdc-mevans
Subject: Cross-Out
Date: 5/25/2008 7:32:00 PM
TACCEPT - DONE

receiving
[Delete this word based on the above change.]

● Author: wdc-mevans
Subject: Cross-Out
Date: 5/25/2008 7:32:39 PM
TREJECT

may but
[Delete the redundant words.]

● Author: wdc-mevans
Subject: Highlight
Date: 5/25/2008 7:32:48 PM
TREJECT

receiving
s/b
this state receives

● Author: lsi-gpenokie
Subject: Highlight
Date: 5/25/2008 7:32:26 PM
TACCEPT - DONE (with commas)

This << This transition may but should not occur after >> should at least be changed to << This transition may, but should not, occur after >> but I would rather see if restated as << This transition should not occur after I >>

● Author: wdc-mevans
Subject: Highlight
Date: 5/25/2008 7:33:06 PM
TREJECT

receiving
s/b
this state receives

● Author: wdc-mevans
Subject: Highlight
Date: 5/25/2008 7:34:57 PM
TREJECT (but converted into an a)b) list which might help)

message, or

6.8.4.8.3 Transition SP14:SAS_Fail to SP8:SAS_Start

This transition shall occur if the Current SNW state machine variable is not set to Final-SNW.

6.8.4.9 SP15:SAS_PHY_Ready state

6.8.4.9.1 State description

This state waits for a COMINIT Detected message, a DWS Lost message, or a DWS Reset message.

Upon entry into this state, the phy shall:

- a) if multiplexing is enabled (see table 100 in 6.7.4.2.3.3):
 - 1) send a Transmit MUX Sequence message to the SP transmitter; and
 - 2) after receiving MUX Sequence Transmitted, send a Phy Layer Ready (SAS) confirmation to the link layer ~~to indicate that the physical link has been brought up successfully in SAS mode;~~
- b) if multiplexing is not enabled, **send** a Phy Layer Ready (SAS) confirmation to the link layer ~~to indicate that the physical link has been brought up successfully in SAS mode;~~
- c) if the SP transmitter is transmitting at 1.5 Gbps, **set** the ResetStatus state machine variable to G1;
- d) if the SP transmitter is transmitting at 3 Gbps, **set** the ResetStatus state machine variable to G2; and
- e) if the SP transmitter is transmitting at 6 Gbps, **set** the ResetStatus state machine variable to G3.

While in this **state** **dw**ords from the link **layer** are transmitted **at the negotiated physical link rate at the rate** established in the previous SNW.

If multiplexing is disabled, **each** time this state receives a DWS Lost message, this state may send a Start DWS message to the SP_DWS state machine to re-acquire dword synchronization without running a new link reset sequence.

NOTE 42 - If multiplexing is enabled and this state receives a DWS Lost message, this state does not send a Start DWS message and the state machine transitions to SP0:OOB_COMINIT.

6.8.4.9.2 Transition SP15:SAS_PHY_Ready to SP0:OOB_COMINIT

This transition shall occur **after**:

- a) ~~receiving~~ a DWS Lost message, if this state does not send a Start DWS message;
- b) ~~receiving~~ a DWS Lost message followed by a COMINIT Detected message, if this state does not send a Start DWS message; or
- c) ~~receiving~~ a DWS Reset message.

This transition may but should not occur after receiving a COMINIT Detected message before receiving a DWS Lost **message, or after receiving** a COMINIT Detected message after sending a Start DWS message (i.e., the SP state machine should ignore COMINIT Detected messages unless the SP_DWS state machine has indicated loss of dword synchronization).

6.8.4.10 SP27:SAS_Settings state

6.8.4.10.1 State description

This state transmits and receives phy capabilities bits.

Upon entry to this state, the phy shall:

- a) initialize and start the SNTT timer;
- b) set the Commonly Supported Settings state machine variable to indicate that there are no commonly supported settings; and
- c) send a Transmit Phy Capabilities Bits message to the SP transmitter.

If a Phy Capabilities Bits Received message is received with the argument of **parity good**, then this state shall set the Commonly Supported Settings state machine variable to the supported settings that are set to one in both the transmitted and received phy capabilities bits.

This state waits for the SNTT timer to expire.

s/b
message or

Author: lsi-bday
Subject: Highlight
Date: 6/24/2008 8:09:59 PM
T ACCEPT - DONE

parity good
s/b
good parity

6.8.4.10.2 Transition SP27:SAS_Settings to SP0:OOB_COMINIT

This transition shall occur after **receiving** a COMINIT Detected message.

Before the transition, this state shall set the ResetStatus state machine variable to UNKNOWN.

6.8.4.10.3 Transition SP27:SAS_Settings to SP1:OOB_AwaitCOMX

This transition shall occur after the SNTT timer expires if:

- a) a Phy Capabilities Bits Received message is received with an argument of **parity bad**; or
- b) no commonly supported settings exist after the Commonly Supported Settings state machine variable is set as a result of receiving a Phy Capabilities Bits Received message.

Before the transition, this state shall:

- a) if a Phy Capabilities Bits Received message is received with an argument of **parity bad**, set the ResetStatus state machine variable to PHY_RESET_PROBLEM; or
- b) if no commonly supported settings exist after the Commonly Supported Settings state machine variable is set, **set** the ResetStatus state machine variable to UNSUPPORTED_PHY_ATTACHED.

6.8.4.10.4 Transition SP27:SAS_Settings to SP8:SAS_Start

This transition shall occur if:

- a) the SNTT timer expires; and
- b) a Phy Capabilities Bits Received message is not received during this state.

6.8.4.10.5 Transition SP27:SAS_Settings to SP28:SAS_TrainSetup

This transition shall occur:

- a) after the SNTT timer expires; and
- b) if the Commonly Supported Settings state machine variable indicates there is at least one commonly supported setting.

6.8.4.11 SP28:SAS_TrainSetup**6.8.4.11.1 State description**

Upon entry into this state, the phy shall:

- a) initialize and start the RCDT timer; and
- b) send a **Set Rate message to the SP transmitter and receiver** with the arguments set to reflect the highest priority commonly supported setting contained in the Commonly Supported Settings state machine variable.

After the **Set Rate** message is sent, the Commonly Supported Settings state machine variable shall be set to indicate that the **supported settings bit used for the Set Rate message** is no longer in common.

During this state D.C. idle shall be transmitted.

6.8.4.11.2 Transition SP28:SAS_TrainSetup to SP0:OOB_COMINIT

This transition shall occur after **receiving** a COMINIT Detected message.

Before the transition, this state shall set the ResetStatus state machine variable to UNKNOWN.

6.8.4.11.3 Transition SP28:SAS_TrainSetup to SP29:SAS_Train

This transition shall occur after the RCDT timer expires.

● Author: wdc-mevans
Subject: Highlight
Date: 5/25/2008 7:35:17 PM
T REJECT

receiving
s/b
this state receives

● Author: lsi-bday
Subject: Highlight
Date: 6/24/2008 8:10:06 PM
T ACCEPT - DONE

parity bad;
s/b
bad parity;

● Author: RElliott
Subject: Highlight
Date: 6/30/2008 6:16:52 PM
T ACCEPT - DONE

set
s/b
then set

● Author: lsi-bday
Subject: Highlight
Date: 6/24/2008 8:10:14 PM
T ACCEPT - DONE

parity bad,
s/b
bad parity,

● Author: RElliott
Subject: Highlight
Date: 6/30/2008 6:16:52 PM
T ACCEPT - DONE

set
s/b
then set

● Author: RElliott
Subject: Highlight
Date: 8/31/2008 9:01:31 PM
T ACCEPT - DONE

Set Rate message to the SP transmitter and receiver
s/b
Set Physical Link Rate message to the SP transmitter and to the SP receiver and send a Set SSC message to the SP transmitter

● Author: RElliott
Subject: Highlight
Date: 8/31/2008 9:32:24 PM
T ACCEPT - DONE

Set Rate

6.8.4.10.2 Transition SP27:SAS_Settings to SP0:OOB_COMINIT

This transition shall occur after receiving a COMINIT Detected message.

Before the transition, this state shall set the ResetStatus state machine variable to UNKNOWN.

6.8.4.10.3 Transition SP27:SAS_Settings to SP1:OOB_AwaitCOMX

This transition shall occur after the SNTT timer expires if:

- a) a Phy Capabilities Bits Received message is received with an argument of parity bad; or
- b) no commonly supported settings exist after the Commonly Supported Settings state machine variable is set as a result of receiving a Phy Capabilities Bits Received message.

Before the transition, this state shall:

- a) if a Phy Capabilities Bits Received message is received with an argument of parity bad, set the ResetStatus state machine variable to PHY_RESET_PROBLEM; or
- b) if no commonly supported settings exist after the Commonly Supported Settings state machine variable is set, set the ResetStatus state machine variable to UNSUPPORTED_PHY_ATTACHED.

6.8.4.10.4 Transition SP27:SAS_Settings to SP8:SAS_Start

This transition shall occur if:

- a) the SNTT timer expires; and
- b) a Phy Capabilities Bits Received message is not received during this state.

6.8.4.10.5 Transition SP27:SAS_Settings to SP28:SAS_TrainSetup

This transition shall occur:

- a) after the SNTT timer expires; and
- b) if the Commonly Supported Settings state machine variable indicates there is at least one commonly supported setting.

6.8.4.11 SP28:SAS_TrainSetup**6.8.4.11.1 State description**

Upon entry into this state, the phy shall:

- a) initialize and start the RCDT timer; and
- b) send a Set Rate message to the SP transmitter and receiver with the arguments set to reflect the highest priority commonly supported setting contained in the Commonly Supported Settings state machine variable.

After the Set Rate message is sent, the Commonly Supported Settings state machine variable shall be set to indicate that the supported settings bit used for the Set Rate message is no longer in common.

During this state D.C. idle shall be transmitted.

6.8.4.11.2 Transition SP28:SAS_TrainSetup to SP0:OOB_COMINIT

This transition shall occur after receiving a COMINIT Detected message.

Before the transition, this state shall set the ResetStatus state machine variable to UNKNOWN.

6.8.4.11.3 Transition SP28:SAS_TrainSetup to SP29:SAS_Train

This transition shall occur after the RCDT timer expires.

Change to
Set Physical Link Rate messages and Set SSC message

● Author: RElliott
Subject: Highlight
Date: 8/31/2008 9:00:56 PM

T ACCEPT - DONE

supported settings bit used for the Set Rate message

s/b

selected supported settings bit

● Author: wdc-mevans
Subject: Highlight
Date: 5/25/2008 7:35:21 PM

T REJECT

receiving

s/b

this state receives

6.8.4.12 SP29:SAS_Train state**6.8.4.12.1 State description**

Upon entry into this state, the phy shall:

- a) initialize and start the MTT timer;
- b) initialize and start the TLT timer;
- c) send a Start Training message to the SP receiver; and
- d) send a Start DWS message to the SP_DWS state machine.

This state shall repeatedly send Transmit TRAIN Pattern messages to the SP transmitter.

Each time this state receives a DWS Lost message, this state shall send a Start DWS message to the SP_DWS state machine to re-acquire dword synchronization.

If the MTT timer expires, then this state shall send an Abort Training message to the SP receiver.

6.8.4.12.2 Transition SP29:SAS_Train to SP0:OOB_COMINIT

This transition shall occur after receiving a COMINIT Detected message.

Before the transition, this state shall set the ResetStatus state machine variable to UNKNOWN.

6.8.4.12.3 Transition SP29:SAS_Train to SP1:OOB_AwaitCOMX

This transition shall occur if

- a) the MTT timer expires; and
- b) the Commonly Supported Settings state machine variable does not contain additional commonly supported settings.

This is a phy reset problem.

Before the transition, this state shall set the ResetStatus state machine variable to PHY_RESET_PROBLEM.

6.8.4.12.4 Transition SP29:SAS_Train to SP30:SAS_TrainingDone

This transition shall occur if:

- a) this state receives a Training Completed message before the TLT timer expires; and
- b) dword synchronization is acquired.

6.8.4.12.5 Transition SP29:SAS_Train to SP28:SAS_TrainSetup

This transition shall occur if:

- a) the MTT timer expires; and
- b) the Commonly Supported Settings state machine variable contains additional commonly supported settings.

6.8.4.13 SP30:SAS_TrainingDone state**6.8.4.13.1 State description**

This state shall repeatedly send Transmit TRAIN_DONE Pattern messages to the SP transmitter.

Each time this state receives a DWS Lost message, this state may send a Start DWS message to the SP_DWS state machine to re-acquire dword synchronization without running a new link reset sequence.

This state waits for the MTT timer to expire or a TRAIN_DONE Received message from the receiver.

This state shall send a Start SL_IR Receiver confirmation to the link layer when a TRAIN_DONE Received message is received.

Page: 271

● Author: wdc-mevans
Subject: Highlight
Date: 5/25/2008 7:35:44 PM

 REJECT

receiving
s/b
this state receives

● Author: lsi-gpenokie
Subject: Highlight
Date: 8/27/2008 5:25:44 PM

 ACCEPT - DONE (7/17 move the definition of a "phy reset problem" into the state machine description. Then make the transition just based on that.)

This << This transition shall occur if
a) the MTT timer expires; and
b) the Commonly Supported Settings state machine variable does not contain additional commonly supported settings.
This is a phy reset problem. >> should be << This transition shall occur if there is a phy reset problem as a result of:
a) the MTT timer expiring; and
b) the Commonly Supported Settings state machine variable not containing additional commonly supported settings. >>

● Author: lsi-bday
Subject: Highlight
Date: 6/9/2008 2:30:44 PM

 REJECT (it already says "before... and" so the transition won't occur if the TLT has expired. The "before" wording is used elsewhere)

this state receives a Training Completed message before the TLT timer expires; and
b) dword synchronization is acquired.

s/b

a) The TLT timer has not expired,
b) this state receives a Training Complete message; and
c) dword synchronization is acquired.

(We do not want to make this transition if dword sync is acquired after the TLT time.)

● Author: RElliott
Subject: Note
Date: 6/30/2008 6:16:52 PM

 ACCEPT - DONE

Move "to SP28" section ahead of "to SP30" section

6.8.4.13.2 Transition SP30:SAS_TrainingDone to SP0:OOB_COMINIT

This transition shall occur **after:**

- a) ~~receiving a DWS Lost message~~ if this state does not send a Start DWS message; or
- b) ~~receiving a COMINIT Detected message.~~

Before the transition, this state shall set the ResetStatus state machine variable to UNKNOWN.

6.8.4.13.3 Transition SP30:SAS_TrainingDone to SP4:OOB_AwaitCOMX

This transition shall occur if:

- a) TRAIN_DONE Received message is not received before the MTT timer expires; and
- b) the Commonly Supported Settings state machine variable does not contain additional commonly supported settings.

~~This is a phy reset problem.~~

Before the transition, this state shall set the ResetStatus state machine variable to PHY_RESET_PROBLEM.

6.8.4.13.4 Transition SP30:SAS_TrainingDone to SP28:SAS_TrainSetup

This transition shall occur if:

- a) the MTT timer expires; and
- b) the Commonly Supported Settings state machine variable contains additional commonly supported settings.

6.8.4.13.5 Transition SP30:SAS_TrainingDone to SP15:SAS_PHY_Ready

This transition shall occur if this state receives:

- a) at least four TRAIN_DONE Pattern Transmitted messages; and
- b) a TRAIN_DONE Received message before the MTT timer expires.

6.8.5 SATA host emulation states**6.8.5.1 SATA host emulation states overview**

Figure 157 shows the SATA host emulation states, in which the phy has detected that it is attached to a SATA phy and behaves as if it were a SATA host **phy, initiating** the SATA speed negotiation sequence. These states are indicated by state names with a prefix of SATA.

The power management states defined in this standard are for SAS initiator phys that **support SATA;** **expander devices** that support SATA do not support power management ~~in this standard.~~

Page: 272

● Author: wdc-mevans
Subject: Highlight
Date: 5/25/2008 7:37:06 PM
T REJECT (but moved "receiving" here)

after:
s/b
after this state receives:

● Author: wdc-mevans
Subject: Cross-Out
Date: 5/25/2008 7:36:48 PM
T ACCEPT - DONE

receiving
[Delete this word based on the above change.]

● Author: wdc-mevans
Subject: Cross-Out
Date: 5/25/2008 7:36:55 PM
T ACCEPT - DONE

receiving
[Delete this word based on the above change.]

● Author: Isi-gpenokie
Subject: Highlight
Date: 8/27/2008 5:25:52 PM
T ACCEPT - DONE (7/17 apply solution on pg 271)

This << This transition shall occur if:
a) TRAIN_DONE Received message is not received before the MTT timer expires; and
b) the Commonly Supported Settings state machine variable does not contain additional commonly supported settings.
This is a phy reset problem. >> should be << This transition shall occur if there is a phy reset problem as a result of:
a) the TRAIN_DONE Received message not being received before the MTT timer expires; and
b) the Commonly Supported Settings state machine variable not containing additional commonly supported settings. >>

● Author: wdc-mevans
Subject: Cross-Out
Date: 5/25/2008 7:37:50 PM
T REJECT (no, that's a very important phrase)

This is a phy reset problem.
s/b
[Delete the editorial comment.]

● Author: wdc-mevans
Subject: Highlight
Date: 5/25/2008 7:39:46 PM
T ACCEPT - DONE

phy, initiating
s/b
phy initiating

● Author: Isi-gpenokie
Subject: Highlight
Date: 5/25/2008 7:38:58 PM
T ACCEPT - DONE

Comments from page 272 continued on next page

6.8.4.13.2 Transition SP30:SAS_TrainingDone to SP0:OOB_COMINIT

This transition shall occur **after:**

- a) ~~receiving~~ a DWS Lost message if this state does not send a Start DWS message; or
- b) ~~receiving~~ a COMINIT Detected message.

Before the transition, this state shall set the ResetStatus state machine variable to UNKNOWN.

6.8.4.13.3 Transition SP30:SAS_TrainingDone to SP1:OOB_AwaitCOMX

This transition shall occur if:

- a) TRAIN_DONE Received message is not received before the MTT timer expires; and
- b) the Commonly Supported Settings state machine variable does not contain additional commonly supported settings.

~~This is a phy reset problem.~~

Before the transition, this state shall set the ResetStatus state machine variable to PHY_RESET_PROBLEM.

6.8.4.13.4 Transition SP30:SAS_TrainingDone to SP28:SAS_TrainSetup

This transition shall occur if:

- a) the MTT timer expires; and
- b) the Commonly Supported Settings state machine variable contains additional commonly supported settings.

6.8.4.13.5 Transition SP30:SAS_TrainingDone to SP15:SAS_PHY_Ready

This transition shall occur if this state receives:

- a) at least four TRAIN_DONE Pattern Transmitted messages; and
- b) a TRAIN_DONE Received message before the MTT timer expires.

6.8.5 SATA host emulation states**6.8.5.1 SATA host emulation states overview**

Figure 157 shows the SATA host emulation states, in which the phy has detected that it is attached to a SATA phy and behaves as if it were a SATA host **phy, initiating** the SATA speed negotiation sequence. These states are indicated by state names with a prefix of SATA.

The power management states defined in this standard are for SAS initiator phys that **support SATA;** **expander devices** that support SATA do not support power management ~~in this standard.~~

This << support SATA; expander devices >> should be << support SATA. Expander devices >>

● Author: wdc-mevans
Subject: Highlight
Date: 5/25/2008 7:38:47 PM

 ACCEPT - DONE

SATA; expander
s/b
SATA. Expander

● Author: RElliott
Subject: Cross-Out
Date: 6/30/2008 6:16:52 PM

 ACCEPT - DONE

Delete "in this standard" which is awkward wording

Author: RElliott
Subject: Highlight
Date: 8/31/2008 9:38:17 PM
ACCEPT - DONE



Set Rate

Change to
Set Physical Link Rate

6.8.5.2 SP16:SATA_COMWAKE state**6.8.5.2.1 State description**

This state shall send a Transmit COMWAKE message to the SP transmitter and wait for a COMWAKE Transmitted message.

6.8.5.2.2 Transition SP16:SATA_COMWAKE to SP17:SATA_AwaitCOMWAKE

This transition shall occur after receiving a COMWAKE Transmitted message.

6.8.5.3 SP17:SATA_AwaitCOMWAKE state**6.8.5.3.1 State description**

This state waits for COMWAKE to be received.

6.8.5.3.2 Transition SP17:SATA_AwaitCOMWAKE to SP0:OOB_COMINIT

This transition shall occur after receiving a COMINIT Detected message.

6.8.5.3.3 Transition SP17:SATA_AwaitCOMWAKE to SP18:SATA_AwaitNoCOMWAKE

This transition shall occur after receiving a COMWAKE Detected message.

6.8.5.4 SP18:SATA_AwaitNoCOMWAKE state**6.8.5.4.1 State description**

This state waits for a COMWAKE Completed message.

6.8.5.4.2 Transition SP18:SATA_AwaitNoCOMWAKE to SP0:OOB_COMINIT

This transition shall occur after receiving a COMINIT Detected message.

Before the transition, this state shall set the ResetStatus state machine variable to UNKNOWN.

6.8.5.4.3 Transition SP18:SATA_AwaitNoCOMWAKE to SP19:SATA_AwaitALIGN

This transition shall occur after receiving a COMWAKE Completed message.

6.8.5.5 SP19:SATA_AwaitALIGN state**6.8.5.5.1 State description**

Upon entry into this state, the phy shall send a Start DWS message to the SP_DWS state machine.

This state shall:

- a) repeatedly send Transmit D10.2 messages to the SP transmitter;
- b) initialize and start the Await ALIGN Timeout timer; and
- c) wait for an ALIGN Received (0) message to be received or for the Await ALIGN Timeout timer to expire.

The phy shall start transmitting D10.2 characters no later than a COMWAKE response time (see 6.7.2.2) after entry into this state.

6.8.5.5.2 Transition SP19:SATA_AwaitALIGN to SP0:OOB_COMINIT

This transition shall occur if the Await ALIGN Timeout timer expires or after receiving a DWS Lost message, or after receiving a COMINIT Detected message.

● Author: wdc-mevans
Subject: Highlight
Date: 5/25/2008 7:40:17 PM
T REJECT

receiving
s/b
this state receives

● Author: wdc-mevans
Subject: Highlight
Date: 5/25/2008 7:40:21 PM
T REJECT

receiving
s/b
this state receives

● Author: wdc-mevans
Subject: Highlight
Date: 5/25/2008 7:40:23 PM
T REJECT

receiving
s/b
this state receives

● Author: wdc-mevans
Subject: Highlight
Date: 5/25/2008 7:40:25 PM
T REJECT

receiving
s/b
this state receives

● Author: wdc-mevans
Subject: Highlight
Date: 5/25/2008 7:40:29 PM
T REJECT

receiving
s/b
this state receives

● Author: Isi-bday
Subject: Highlight
Date: 8/31/2008 9:47:48 PM

T ACCEPT - DONE (8/31 Added (which handles the D10.2 rate), but note that other intricacies of SATA speed negotiation are not mentioned like how the receiver decides the rate of the incoming ALIGNs and communicates that to SP and the transmitter.

7/9 do it. Bumping speeds is handled in SP20, but the initial speed is missing)

Need to include new list item to send a Set Rate to the transmitter.

a) Send a Set Rate to the SP transmitter with a Physical Link Rate argument set to the lowest supported link rate, and either an SSC On argument or an SSC Off argument.

Also update figure to have the "Set Rate" arrow from this state.

6.8.5.2 SP16:SATA_COMWAKE state**6.8.5.2.1 State description**

This state shall send a Transmit COMWAKE message to the SP transmitter and wait for a COMWAKE Transmitted message.

6.8.5.2.2 Transition SP16:SATA_COMWAKE to SP17:SATA_AwaitCOMWAKE

This transition shall occur after **receiving** a COMWAKE Transmitted message.

6.8.5.3 SP17:SATA_AwaitCOMWAKE state**6.8.5.3.1 State description**

This state waits for COMWAKE to be received.

6.8.5.3.2 Transition SP17:SATA_AwaitCOMWAKE to SP0:OOB_COMINIT

This transition shall occur after **receiving** a COMINIT Detected message.

6.8.5.3.3 Transition SP17:SATA_AwaitCOMWAKE to SP18:SATA_AwaitNoCOMWAKE

This transition shall occur after **receiving** a COMWAKE Detected message.

6.8.5.4 SP18:SATA_AwaitNoCOMWAKE state**6.8.5.4.1 State description**

This state waits for a COMWAKE Completed message.

6.8.5.4.2 Transition SP18:SATA_AwaitNoCOMWAKE to SP0:OOB_COMINIT

This transition shall occur after **receiving** a COMINIT Detected message.

Before the transition, this state shall set the ResetStatus state machine variable to UNKNOWN.

6.8.5.4.3 Transition SP18:SATA_AwaitNoCOMWAKE to SP19:SATA_AwaitALIGN

This transition shall occur after **receiving** a COMWAKE Completed message.

6.8.5.5 SP19:SATA_AwaitALIGN state**6.8.5.5.1 State description**

Upon entry into this state, the phy shall send a Start DWS message to the SP_DWS state machine.

This state shall:

- a) repeatedly send Transmit D10.2 messages to the SP transmitter;
- b) initialize and start the Await ALIGN Timeout timer; and
- c) wait for an ALIGN Received (0) message to be received or for the Await ALIGN Timeout timer to expire.

The phy shall start transmitting D10.2 characters no later than a COMWAKE response time (see 6.7.2.2) after entry into this state.

6.8.5.5.2 Transition SP19:SATA_AwaitALIGN to SP0:OOB_COMINIT

This transition shall occur if the Await ALIGN Timeout timer expires or after receiving a DWS Lost message, or after receiving a COMINIT Detected message.

Author: RElliott
Subject: Highlight
Date: 6/30/2008 6:16:52 PM

T ACCEPT - DONE

This transition shall occur if the Await ALIGN Timeout timer expires or after receiving a DWS Lost message, or after receiving a COMINIT Detected message.

s/b

a)b)c) list

Before the transition, this state shall:

- a) if the Await ALIGN Timeout timer expires, set the ResetStatus state machine variable to UNSUPPORTED_PHY_ATTACHED;
- b) after receiving a DWS Lost message, set the ResetStatus state machine variable to UNKNOWN; or
- c) after receiving a COMINIT Detected message, set the ResetStatus state machine variable to UNKNOWN.

6.8.5.5.3 Transition SP19:SATA_AwaitALIGN to SP20:SATA_AdjustSpeed

This transition shall occur if this state receives an ALIGN Received (0) message before the Await ALIGN Timeout timer expires. The ALIGN Received (0) message indicates an ALIGN (0) was received at any of the physical link rates supported by this phy.

6.8.5.6 SP20:SATA_AdjustSpeed state

6.8.5.6.1 State description

This state waits for the SP transmitter to adjust to the same physical link rate of the ALIGNs that were detected by the receiver circuitry.

This state shall:

- 1) send a Set Rate message to the SP transmitter; and
- 2) repeatedly send Transmit D10.2 messages to the SP transmitter.

6.8.5.6.2 Transition SP20:SATA_AdjustSpeed to SP0:OOB_COMINIT

This transition shall occur after receiving a DWS Lost message, or after receiving a COMINIT Detected message.

Before the transition, this state shall set the ResetStatus state machine variable to UNKNOWN.

6.8.5.6.3 Transition SP20:SATA_AdjustSpeed to SP21:SATA_TransmitALIGN

This transition shall occur after receiving a Transmitter Ready message.

6.8.5.7 SP21:SATA_TransmitALIGN state

6.8.5.7.1 State description

This state shall repeatedly send Transmit ALIGN (0) messages to the SP transmitter.

6.8.5.7.2 Transition SP21:SATA_TransmitALIGN to SP0:OOB_COMINIT

This transition shall occur after receiving a DWS Lost message, or after receiving a COMINIT Detected message.

Before the transition, this state shall set the ResetStatus state machine variable to UNKNOWN.

6.8.5.7.3 Transition SP21:SATA_TransmitALIGN to SP22:SATA_PHY_Ready

This transition shall occur after receiving three consecutive Dword Received messages containing primitives other than ALIGN (0).

6.8.5.8 SP22:SATA_PHY_Ready state

6.8.5.8.1 State description

While in this state dwords from the link layer are transmitted at the negotiated physical link rate at the rate established in the previous state.

Page: 275

Author: RElliott
Subject: Highlight
Date: 6/30/2008 6:16:52 PM
T ACCEPT - DONE

set
s/b
then set

Author: RElliott
Subject: Highlight
Date: 8/31/2008 9:06:31 PM
T ACCEPT - DONE

Set Rate message to the SP transmitter
s/b

Set Physical Link Rate message to the SP transmitter with an argument specifying the physical link rate of the ALIGNs that were detected by the receiver circuitry;

It doesn't say how it figures that out. Since this is part of SATA host emulation, that seems fair to leave as an exercise for the reader.

We'll also remain quiet about setting SSC.

We'll also remain quiet about how the receiver tests different speeds that it supports. SP doesn't implement that check (for SATA) - the SP receiver must do so on its own.

Author: RElliott
Subject: Highlight
Date: 6/30/2008 6:16:52 PM
T ACCEPT - DONE

T message, or after receiving
s/b
message or

Author: wdc-mevans
Subject: Highlight
Date: 5/25/2008 7:40:32 PM
T REJECT

receiving
s/b
this state receives

Author: wdc-mevans
Subject: Highlight
Date: 5/25/2008 7:40:37 PM
T REJECT

receiving
s/b
this state receives

Author: RElliott
Subject: Highlight
Date: 6/30/2008 6:16:52 PM
T ACCEPT - DONE

T message, or after receiving
s/b
message or

Comments from page 275 continued on next page

Before the transition, this state shall:

- a) if the Await ALIGN Timeout timer expires, set the ResetStatus state machine variable to UNSUPPORTED_PHY_ATTACHED;
- b) after receiving a DWS Lost message, set the ResetStatus state machine variable to UNKNOWN; or
- c) after receiving a COMINIT Detected message, set the ResetStatus state machine variable to UNKNOWN.

6.8.5.5.3 Transition SP19:SATA_AwaitALIGN to SP20:SATA_AdjustSpeed

This transition shall occur if this state receives an ALIGN Received (0) message before the Await ALIGN Timeout timer expires. The ALIGN Received (0) message indicates an ALIGN (0) was received at any of the physical link rates supported by this phy.

6.8.5.6 SP20:SATA_AdjustSpeed state

6.8.5.6.1 State description

This state waits for the SP transmitter to adjust to the same physical link rate of the ALIGNs that were detected by the receiver circuitry.

This state shall:

- 1) send a Set Rate message to the SP transmitter; and
- 2) repeatedly send Transmit D10.2 messages to the SP transmitter.

6.8.5.6.2 Transition SP20:SATA_AdjustSpeed to SP0:OOB_COMINIT

This transition shall occur after receiving a DWS Lost message, or after receiving a COMINIT Detected message.

Before the transition, this state shall set the ResetStatus state machine variable to UNKNOWN.

6.8.5.6.3 Transition SP20:SATA_AdjustSpeed to SP21:SATA_TransmitALIGN

This transition shall occur after receiving a Transmitter Ready message.

6.8.5.7 SP21:SATA_TransmitALIGN state

6.8.5.7.1 State description

This state shall repeatedly send Transmit ALIGN (0) messages to the SP transmitter.

6.8.5.7.2 Transition SP21:SATA_TransmitALIGN to SP0:OOB_COMINIT

This transition shall occur after receiving a DWS Lost message, or after receiving a COMINIT Detected message.

Before the transition, this state shall set the ResetStatus state machine variable to UNKNOWN.

6.8.5.7.3 Transition SP21:SATA_TransmitALIGN to SP22:SATA_PHY_Ready

This transition shall occur after receiving three consecutive Dword Received messages containing primitives other than ALIGN (0).

6.8.5.8 SP22:SATA_PHY_Ready state

6.8.5.8.1 State description

While in this state dwords from the link layer are transmitted at the negotiated physical link rate at the rate established in the previous state.

Author: wdc-mevans
Subject: Highlight
Date: 5/25/2008 7:41:04 PM

T REJECT

receiving
s/b
this state receives

Author: wdc-mevans
Subject: Highlight
Date: 5/25/2008 7:41:07 PM

T REJECT

receiving
s/b
this state receives

Author: RElliott
Subject: Highlight
Date: 6/30/2008 6:16:52 PM

T ACCEPT - DONE (changed to:
"at the negotiated physical link rate (i.e., the rate established in the previous state)")

at the negotiated physical link rate at the rate

doesn't make sense

Upon entry into this state, this state shall:

- a) if the SP transmitter is transmitting at 1.5 Gbps, set the ResetStatus state machine variable to G1;
- b) if the SP transmitter is transmitting at 3 Gbps, set the ResetStatus state machine variable to G2; or
- c) if the SP transmitter is transmitting at 6 Gbps, set the ResetStatus state machine variable to G3.

This state shall send a Phy Layer Ready (SATA) confirmation to the link layer to indicate that the physical link has been brought up successfully in SATA mode.

This state waits for a COMINIT Detected message, a DWS Lost message, or a DWS Reset message.

Each time this state receives a DWS Lost message, this state may send a Start DWS message to the SP_DWS state machine to re-acquire dword synchronization without running a new link reset sequence.

6.8.5.8.2 Transition SP22:SATA_PHY_Ready to SP0:OOB_COMINIT

This transition shall occur after:

- a) receiving a DWS Lost message, if this state does not send a Start DWS message;
- a) receiving a DWS Lost message followed by a COMINIT Detected message, if this state does not send a Start DWS message; or
- b) receiving a DWS Reset message.

This transition may but should not occur after receiving a COMINIT Detected message before receiving a DWS Lost message, or after receiving a COMINIT Detected message after sending a Start DWS message (i.e., the SP state machine should ignore COMINIT Detected messages unless the SP_DWS state machine has indicated loss of dword synchronization).

6.8.5.8.3 Transition SP22:SATA_PHY_Ready to SP23:SATA_PM_Partial

This transition shall occur after receiving an Enter Partial request.

6.8.5.8.4 Transition SP22:SATA_PHY_Ready to SP24:SATA_PM_Slumber

This transition shall occur after receiving an Enter Slumber request.

6.8.5.9 SP23:SATA_PM_Partial state

6.8.5.9.1 State description

This state waits for a COMWAKE Detected message or an Exit Partial request.

6.8.5.9.2 Transition SP23:SATA_PM_Partial to SP0:OOB_COMINIT

This transition shall occur after receiving a COMINIT Detected message.

Before the transition, this state shall set the ResetStatus state machine variable to UNKNOWN.

6.8.5.9.3 Transition SP23:SATA_PM_Partial to SP16:SATA_COMWAKE

This transition shall occur after receiving a Exit Partial request.

6.8.5.9.4 Transition SP23:SATA_PM_Partial to SP18:SATA_AwaitNoCOMWAKE

This transition shall occur after receiving a COMWAKE Detected message.

6.8.5.10 SP24:SATA_PM_Slumber state

6.8.5.10.1 State description

This state waits for a COMWAKE Detected message or an Exit Slumber request.

6.8.5.10.2 Transition SP24:SATA_PM_Slumber to SP0:OOB_COMINIT

This transition shall occur after receiving a COMINIT Detected message.

Author: RElliott
Subject: Highlight
Date: 6/30/2008 6:16:52 PM
T ACCEPT - DONE

set
s/b
then set

Author: RElliott
Subject: Highlight
Date: 6/30/2008 6:16:52 PM
T ACCEPT - DONE

set
s/b
then set

Author: RElliott
Subject: Highlight
Date: 6/30/2008 6:16:52 PM
T ACCEPT - DONE

set
s/b
then set

Author: RElliott
Subject: Cross-Out
Date: 6/30/2008 6:16:52 PM
~~**T**~~ ACCEPT - DONE

Delete
"to indicate that the physical link
has been brought up successfully in SATA mode"
to match lsi-gpenokie comment on SP15:SAS_PHY_Ready

Author: wdc-mevans
Subject: Highlight
Date: 6/24/2008 8:16:43 PM
T REJECT (deleted phrase instead, to match lsi-gpenokie comment on SP15:SAS_PHY_Ready)

brought up successfully
s/b
established

Author: wdc-mevans
Subject: Highlight
Date: 5/25/2008 7:42:27 PM
T REJECT (but pulled in "receiving")

after:
s/b
after this state receives:

Author: wdc-mevans
Subject: Cross-Out
Date: 5/25/2008 7:42:02 PM

Upon entry into this state, this state shall:

- a) if the SP transmitter is transmitting at 1.5 Gbps, set the ResetStatus state machine variable to G1;
- b) if the SP transmitter is transmitting at 3 Gbps, set the ResetStatus state machine variable to G2; or
- c) if the SP transmitter is transmitting at 6 Gbps, set the ResetStatus state machine variable to G3.

This state shall send a Phy Layer Ready (SATA) confirmation to the link layer ~~to indicate that the physical link has been brought up successfully in SATA mode.~~

This state waits for a COMINIT Detected message, a DWS Lost message, or a DWS Reset message.

Each time this state receives a DWS Lost message, this state may send a Start DWS message to the SP_DWS state machine to re-acquire dword synchronization without running a new link reset sequence.

6.8.5.8.2 Transition SP22:SATA_PHY_Ready to SP0:OOB_COMINIT

This transition shall occur after:

- a) ~~receiving a DWS Lost message, if this state does not send a Start DWS message;~~
- a) receiving a DWS Lost message followed by a COMINIT Detected message, if this state does not send a Start DWS message; or
- b) ~~receiving a DWS Reset message.~~

~~This transition may but should not occur after receiving a COMINIT Detected message before receiving a DWS Lost message, or after receiving a COMINIT Detected message after sending a Start DWS message (i.e., the SP state machine should ignore COMINIT Detected messages unless the SP_DWS state machine has indicated loss of dword synchronization).~~

6.8.5.8.3 Transition SP22:SATA_PHY_Ready to SP23:SATA_PM_Partial

This transition shall occur after receiving an Enter Partial request.

6.8.5.8.4 Transition SP22:SATA_PHY_Ready to SP24:SATA_PM_Slumber

This transition shall occur after receiving an Enter Slumber request.

6.8.5.9 SP23:SATA_PM_Partial state

6.8.5.9.1 State description

This state waits for a COMWAKE Detected message or an Exit Partial request.

6.8.5.9.2 Transition SP23:SATA_PM_Partial to SP0:OOB_COMINIT

This transition shall occur after receiving a COMINIT Detected message.

Before the transition, this state shall set the ResetStatus state machine variable to UNKNOWN.

6.8.5.9.3 Transition SP23:SATA_PM_Partial to SP16:SATA_COMWAKE

This transition shall occur after receiving a Exit Partial request.

6.8.5.9.4 Transition SP23:SATA_PM_Partial to SP18:SATA_AwaitNoCOMWAKE

This transition shall occur after receiving a COMWAKE Detected message.

6.8.5.10 SP24:SATA_PM_Slumber state

6.8.5.10.1 State description

This state waits for a COMWAKE Detected message or an Exit Slumber request.

6.8.5.10.2 Transition SP24:SATA_PM_Slumber to SP0:OOB_COMINIT

This transition shall occur after receiving a COMINIT Detected message.

 ACCEPT - DONE

receiving
[Delete this word based on the above change.]

● Author: wdc-mevans
Subject: Cross-Out
Date: 5/25/2008 7:42:08 PM

 ACCEPT - DONE

receiving
[Delete this word based on the above change.]

● Author: RElliott
Subject: Highlight
Date: 7/9/2008 10:03:34 AM

 ACCEPT - DONE

a)
s/b
b)

(from Ralph Weber, ENDL)

● Author: wdc-mevans
Subject: Cross-Out
Date: 5/25/2008 7:42:15 PM

 ACCEPT - DONE

receiving
[Delete this word based on the above change.]

● Author: wdc-mevans
Subject: Cross-Out
Date: 5/25/2008 7:43:21 PM

 REJECT

may but
s/b
[Delete redundant words.]

● Author: lsi-gpenokie
Subject: Highlight
Date: 5/25/2008 7:43:12 PM

 ACCEPT - DONE (with commas)

This << This transition may but should not occur after >> should at least be changed to << This transition may, but should not, occur after >> but I would rather see if restated as << This transition should not occur after >>

● Author: wdc-mevans
Subject: Highlight
Date: 5/25/2008 7:43:46 PM

 REJECT (but split into a)b) list which might help)

message, or
s/b
message or

● Author: wdc-mevans
Subject: Highlight
Date: 5/25/2008 7:43:28 PM

 REJECT

receiving
s/b

Upon entry into this state, this state shall:

- a) if the SP transmitter is transmitting at 1.5 Gbps, set the ResetStatus state machine variable to G1;
- b) if the SP transmitter is transmitting at 3 Gbps, set the ResetStatus state machine variable to G2; or
- c) if the SP transmitter is transmitting at 6 Gbps, set the ResetStatus state machine variable to G3.

This state shall send a Phy Layer Ready (SATA) confirmation to the link layer ~~to indicate that the physical link has been brought up successfully in SATA mode.~~

This state waits for a COMINIT Detected message, a DWS Lost message, or a DWS Reset message.

Each time this state receives a DWS Lost message, this state may send a Start DWS message to the SP_DWS state machine to re-acquire dword synchronization without running a new link reset sequence.

6.8.5.8.2 Transition SP22:SATA_PHY_Ready to SP0:OOB_COMINIT

This transition shall occur after:

- a) ~~receiving~~ a DWS Lost message, if this state does not send a Start DWS message;
- a) receiving a DWS Lost message followed by a COMINIT Detected message, if this state does not send a Start DWS message; or
- b) ~~receiving~~ a DWS Reset message.

This transition ~~may but should not occur~~ after receiving a COMINIT Detected message before receiving a DWS Lost message, or after receiving a COMINIT Detected message after sending a Start DWS message (i.e., the SP state machine should ignore COMINIT Detected messages unless the SP_DWS state machine has indicated loss of dword synchronization).

6.8.5.8.3 Transition SP22:SATA_PHY_Ready to SP23:SATA_PM_Partial

This transition shall occur after receiving an Enter Partial request.

6.8.5.8.4 Transition SP22:SATA_PHY_Ready to SP24:SATA_PM_Slumber

This transition shall occur after receiving an Enter Slumber request.

6.8.5.9 SP23:SATA_PM_Partial state

6.8.5.9.1 State description

This state waits for a COMWAKE Detected message or an Exit Partial request.

6.8.5.9.2 Transition SP23:SATA_PM_Partial to SP0:OOB_COMINIT

This transition shall occur after receiving a COMINIT Detected message.

Before the transition, this state shall set the ResetStatus state machine variable to UNKNOWN.

6.8.5.9.3 Transition SP23:SATA_PM_Partial to SP16:SATA_COMWAKE

This transition shall occur after receiving a Exit Partial request.

6.8.5.9.4 Transition SP23:SATA_PM_Partial to SP18:SATA_AwaitNoCOMWAKE

This transition shall occur after receiving a COMWAKE Detected message.

6.8.5.10 SP24:SATA_PM_Slumber state

6.8.5.10.1 State description

This state waits for a COMWAKE Detected message or an Exit Slumber request.

6.8.5.10.2 Transition SP24:SATA_PM_Slumber to SP0:OOB_COMINIT

This transition shall occur after receiving a COMINIT Detected message.

this state receives

● Author: wdc-mevans
Subject: Highlight
Date: 5/25/2008 7:43:33 PM
TREJECT

receiving
s/b
this state receives

● Author: wdc-mevans
Subject: Highlight
Date: 5/25/2008 7:43:53 PM
TREJECT

receiving
s/b
this state receives

● Author: RElliott
Subject: Highlight
Date: 6/30/2008 6:16:52 PM
TACCEPT - DONE

a Exit
s/b
an Exit

● Author: wdc-mevans
Subject: Highlight
Date: 5/25/2008 7:43:57 PM
TREJECT

receiving
s/b
this state receives

● Author: wdc-mevans
Subject: Highlight
Date: 5/25/2008 7:44:01 PM
TREJECT

receiving
s/b
this state receives

Before the transition, this state shall set the ResetStatus state machine variable to UNKNOWN.

6.8.5.10.3 Transition SP24:SATA_PM_Slumber to SP16:SATA_COMWAKE

This transition shall occur after receiving a ~~Exit Slumber~~ request.

6.8.5.10.4 Transition SP24:SATA_PM_Slumber to SP18:SATA_AwaitCOMWAKE

This transition shall occur after receiving a COMWAKE Detected message.

6.8.6 SATA port selector state SP25:SATA_PortSel

6.8.6.1 State description

Figure 158 shows the SP25:SATA_PortSel state. This state controls transmission of the SATA port selection signal when a specified phy processes a Transmit SATA Port Selection Signal request.

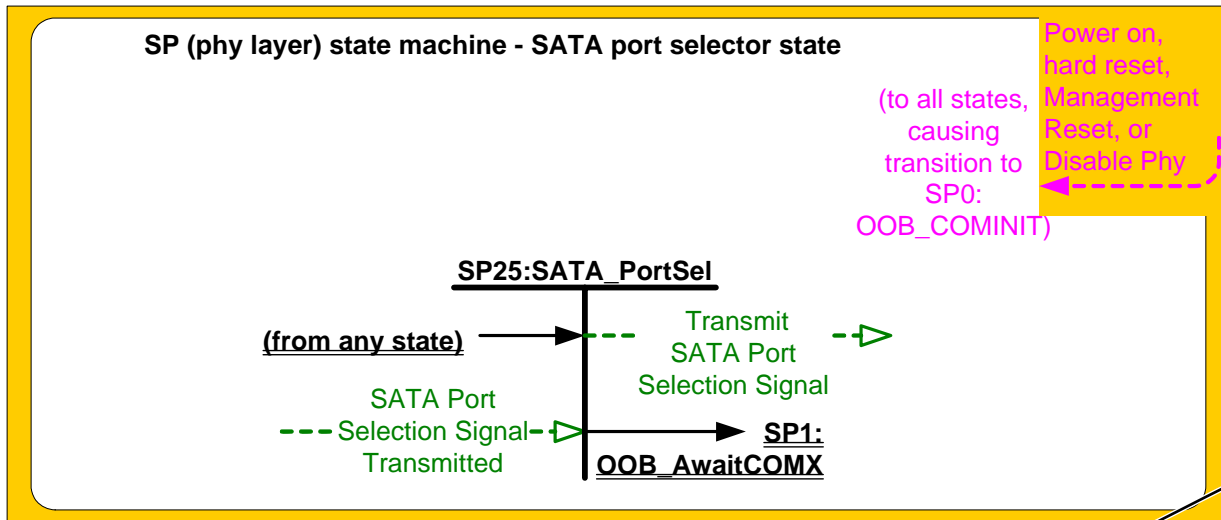

Figure 158 — SP (phy layer) state machine – SATA port selector state

Upon entry into this state, the phy shall:

- a) set the ResetStatus state machine variable to UNKNOWN;
- b) send a Transmit SATA Port Selection Signal message to the SP transmitter;
- c) set the ATTACHED SATA PORT SELECTOR bit to zero in the SMP DISCOVER response (see 10.4.3.10); and
- d) set the ATTACHED SATA DEVICE bit to zero in the SMP DISCOVER response.

6.8.6.2 Transition SP25:SATA_PortSel to SP1:OOB_AwaitCOMX

This transition shall occur after receiving a SATA Port Selection Signal Transmitted message.

● Author: RElliott
Subject: Highlight
Date: 6/30/2008 6:16:52 PM
T ACCEPT - DONE

a Exit
s/b
an Exit

● Author: wdc-mevans
Subject: Highlight
Date: 5/25/2008 7:44:07 PM
T REJECT

receiving
s/b
this state receives

● Author: wdc-mevans
Subject: Highlight
Date: 5/25/2008 7:44:10 PM
T REJECT

receiving
s/b
this state receives

● Author: wdc-mevans
Subject: Highlight
Date: 5/25/2008 7:44:14 PM
T REJECT

receiving
s/b
this state receives

6.8.7 SATA spinup hold state SP26:SATA_SpinupHold

6.8.7.1 State description

Figure 159 shows the SP26:SATA_SpinupHold state.

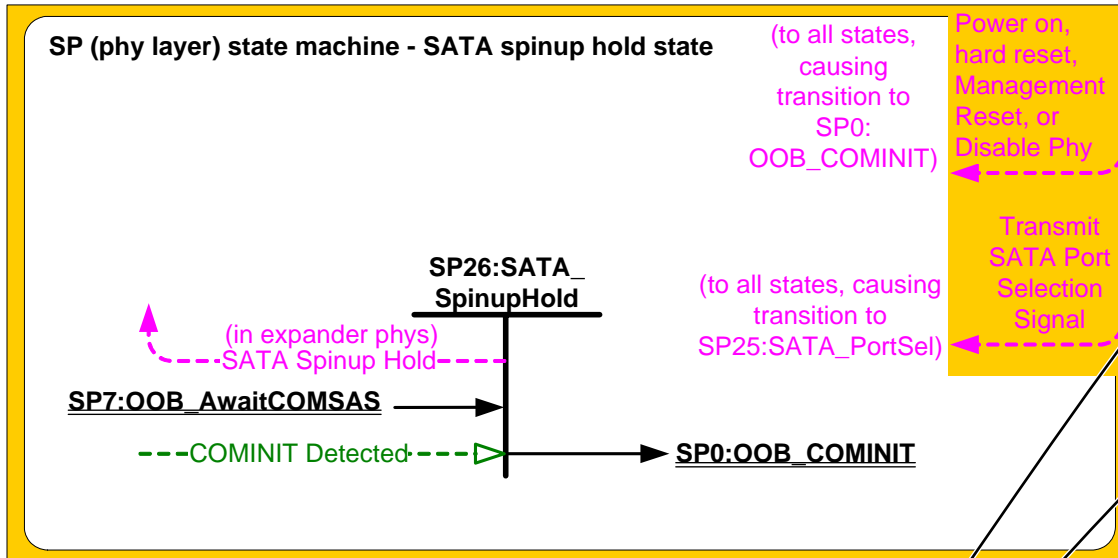

Figure 159 — SP (phy layer) state machine - SATA spinup hold state

Upon entry into this state, this state shall:

- a) if the ResetStatus state machine variable is set to SPINUP_HOLD, not change the ResetStatus state machine variable; or
- b) if the ResetStatus state machine variable is not set to SPINUP_HOLD:
 - A) set the ResetStatus state machine variable to SPINUP_HOLD; and
 - B) if this state machine is in an expander phy, send a SATA Spinup Hold confirmation to the link layer.

6.8.7.2 Transition SP26:SATA_SpinupHold to SP0:OOB_COMINIT

This transition shall occur if this state receives a COMINIT Detected message.

6.9 SP_DWS (phy layer dword synchronization) state machine

6.9.1 SP_DWS state machine overview

Each phy includes an SP_DWS state machine and an SP_DWS receiver.

The SP_DWS state machine establishes the same dword boundaries at the receiver as at the attached transmitter by searching for control characters. The SP_DWS receiver monitors and decodes the incoming data stream and forces K28.5 characters into the first character position to effectively perform dword alignment when requested by the SP_DWS state machine. K28.5 characters with either positive or negative disparity shall be accepted. The SP_DWS receiver continues to reestablish dword alignment by forcing received K28.5 characters into the first character position until a K28.5-based primitive (i.e., K28.5, Dxx.y, Dxx.y, Dxx.y) with correct disparity on each data character is detected. The resultant primitives, dwords and valid dword indicators (e.g., encoding error indicators) are sent to this state machine to enable it to determine the dword synchronization policy.

After dword synchronization has been achieved, this state machine monitors invalid dwords that are received. When an invalid dword is detected, it requires two valid dwords to nullify its effect. When four invalid dwords are detected without nullification, dword synchronization is considered lost.

● Author: RElliott
Subject: Highlight
Date: 6/30/2008 6:16:52 PM
T ACCEPT - DONE

not
s/b
then not

● Author: RElliott
Subject: Highlight
Date: 6/30/2008 6:16:52 PM
T ACCEPT - DONE

:
s/b
, then:

● Author: RElliott
Subject: Highlight
Date: 6/30/2008 6:16:52 PM
T ACCEPT - DONE

send
s/b
then send

● Author: wdc-mevans
Subject: Cross-Out
Date: 5/25/2008 7:45:58 PM
T ACCEPT - DONE

effectively
[Delete the unnecessary word.]

● Author: wdc-mevans
Subject: Highlight
Date: 5/25/2008 7:47:11 PM
T ACCEPT - DONE

it requires two valid dwords to nullify its effect. When four invalid dwords are detected without nullification, dword synchronization is considered lost.
s/b
receipt of two valid dwords is required to nullify the effect of receiving the invalid dword. When four invalid dwords in a row are detected, dword synchronization is considered lost.

While dword synchronization is lost, the data stream received is invalid and dwords shall not be passed to the link layer.

This state machine consists of the following states:

- a) SP_DWS0:AcquireSync (see 6.9.3)(initial state);
- b) SP_DWS1:Valid1 (see 6.9.4);
- c) SP_DWS2:Valid2 (see 6.9.5);
- d) SP_DWS3:SyncAcquired (see 6.9.6);
- e) SP_DWS4:Lost1 (see 6.9.7);
- f) SP_DWS5:Lost1Recovered (see 6.9.8);
- g) SP_DWS6:Lost2 (see 6.9.9);
- h) SP_DWS7:Lost2Recovered (see 6.9.10);
- i) SP_DWS8:Lost3 (see 6.9.11); and
- j) SP_DWS9:Lost3Recovered (see 6.9.12).

This state machine shall start in the SP_DWS0:AcquireSync state after:

- a) power on;
- b) hard reset;
- c) receiving a Management Reset request ~~from the management layer~~ (e.g., ~~from the SMP PHY CONTROL function requesting a phy operation of LINK RESET or HARD RESET in an expander device~~);
- d) receiving a Disable Phy request ~~from the management layer~~ (e.g., ~~from the SMP PHY CONTROL function requesting a phy operation of DISABLE in an expander device~~); or
- e) receiving a Stop DWS message from the SP state machine.

This state machine receives the following messages from the SP state machine (see 6.8).

- a) Start DWS; and
- b) Stop DWS.

This state machine sends the following messages to the SP state machine:

- a) DWS Lost; and
- b) DWS Reset.

The SP_DWS state machine shall maintain the timers listed in table 105.

Table 105 — SP_DWS timers

Timer	Initial value
DWS Reset Timeout timer	1 ms

Page: 279

Author: RElliott
Subject: Note
Date: 8/30/2008 2:49:15 PM

 ACCEPT - DONE

Add:

The SP_DWS state machine receives the following requests:

- a) Management Reset from the management application layer; and
- b) Disable Phy from the management application layer;

prompted by 08-343

Author: RElliott
Subject: Cross-Out
Date: 8/30/2008 2:49:50 PM

 ACCEPT - DONE

Delete
from the management layer

after adding an overall list of requests above (prompted by 08-343)

Author: RElliott
Subject: Highlight
Date: 6/30/2008 6:16:52 PM

 ACCEPT - DONE

from the
s/b
as a result of processing an

Author: RElliott
Subject: Highlight
Date: 8/30/2008 2:51:00 PM

 REJECT (moot)

management layer
s/b
management application layer

Author: RElliott
Subject: Cross-Out
Date: 6/30/2008 6:16:52 PM

 ACCEPT - DONE

in an expander device

Author: RElliott
Subject: Cross-Out
Date: 8/30/2008 2:49:56 PM

 ACCEPT - DONE

Delete
from the management layer

after adding an overall list of requests above (prompted by 08-343)

Author: RElliott
Subject: Highlight

Comments from page 279 continued on next page

While dword synchronization is lost, the data stream received is invalid and dwords shall not be passed to the link layer.

This state machine consists of the following states:

- a) SP_DWS0:AcquireSync (see 6.9.3)(initial state);
- b) SP_DWS1:Valid1 (see 6.9.4);
- c) SP_DWS2:Valid2 (see 6.9.5);
- d) SP_DWS3:SyncAcquired (see 6.9.6);
- e) SP_DWS4:Lost1 (see 6.9.7);
- f) SP_DWS5:Lost1Recovered (see 6.9.8);
- g) SP_DWS6:Lost2 (see 6.9.9);
- h) SP_DWS7:Lost2Recovered (see 6.9.10);
- i) SP_DWS8:Lost3 (see 6.9.11); and
- j) SP_DWS9:Lost3Recovered (see 6.9.12).

This state machine shall start in the SP_DWS0:AcquireSync state after:

- a) power on;
- b) hard reset;
- c) receiving a Management Reset request ~~from the management layer~~ (e.g., ~~from the~~ SMP PHY CONTROL function requesting a phy operation of LINK RESET or HARD RESET ~~in an expander device~~);
- d) receiving a Disable Phy request ~~from the management layer~~ (e.g., ~~from the~~ SMP PHY CONTROL function requesting a phy operation of DISABLE ~~in an expander device~~); or
- e) receiving a Stop DWS message from the SP state machine.

This state machine receives the following messages from the SP state machine (see 6.8):

- a) Start DWS; and
- b) Stop DWS.

This state machine sends the following messages to the SP state machine:

- a) DWS Lost; and
- b) DWS Reset.

The SP_DWS state machine shall maintain the timers listed in table 105.

Table 105 — SP_DWS timers

Timer	Initial value
DWS Reset Timeout timer	1 ms

Date: 6/30/2008 6:16:52 PM

T ACCEPT - DONE

from the
s/b
as a result of processing an

● Author: RElliott
Subject: Highlight
Date: 8/30/2008 2:51:08 PM

T REJECT (moot)

management layer
s/b
management application layer

● Author: RElliott
Subject: Cross-Out
Date: 6/30/2008 6:16:52 PM

T ACCEPT - DONE

in an expander device

● Author: RElliott
Subject: Highlight
Date: 8/30/2008 5:01:28 PM

T ACCEPT - DONE

The SP_DWS state machine
s/b
This state machine

● Author: RElliott
Subject: Highlight
Date: 8/30/2008 4:55:37 PM

T ACCEPT - DONE

timers
s/b
state machine timers

Figure 160 shows the SP_DWS state machine.

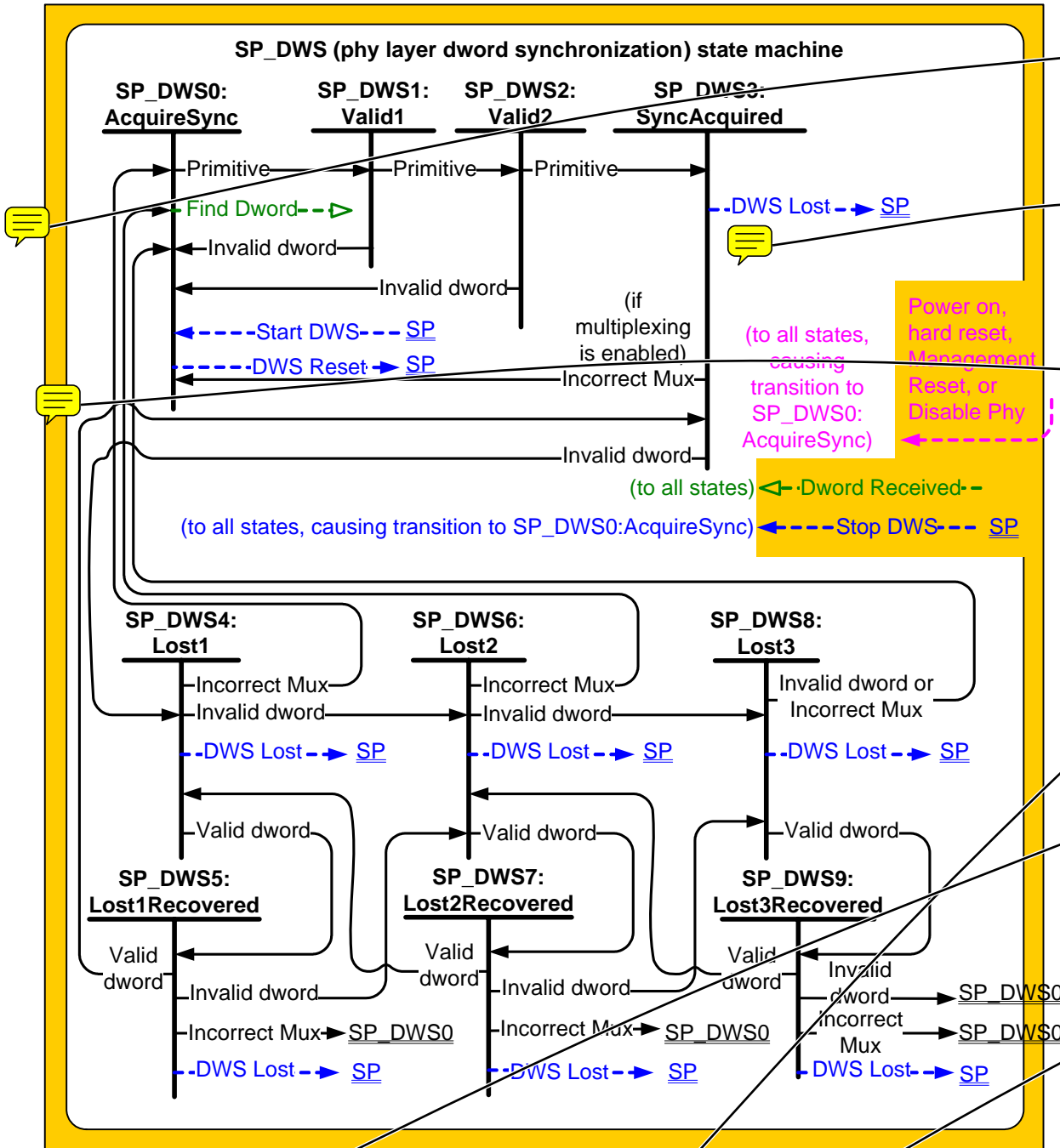

Figure 160 — SP_DWS (phy layer dword synchronization) state machine

6.9.2 SP_DWS receiver

The SP_DWS receiver receives the following messages from the SP_DWS state machine:

- a) Find Dword.

The SP_DWS receiver sends the following messages to the SP_DWS state machine:

- a) Dword Received (Primitive);
- b) Dword Received (Data Dword);
- c) Dword Received (Invalid); and
- d) Incorrect Mux Received.

● Author: RElliott
Subject: Note
Date: 6/30/2008 6:16:52 PM
 ACCEPT - DONE

Add a green Sync Lost message to the SP receiver (not the SP_DWS receiver) from SP_DWS0

● Author: RElliott
Subject: Note
Date: 6/30/2008 6:16:52 PM
 ACCEPT - DONE

Add a green Sync Aquired message
to the SP receiver (not the SP_DWS receiver) from SP_DWS3

● Author: lsi-gpenokie
Subject: Sticky Note
Date: 6/25/2008 10:48:56 AM
 REJECT (this is the last state machine with useful information in the state transitions, and is thus the most useful.)

This appears to be the last of the state machine drawings that contain meaningless information on the state transitions. Delete this.

● Author: RElliott
Subject: Highlight
Date: 6/30/2008 6:16:52 PM
 ACCEPT - DONE

messages
s/b
message

● Author: RElliott
Subject: Note
Date: 6/30/2008 6:16:52 PM
 ACCEPT - DONE

Add Sync Acquired from SP_DWS state machine

● Author: RElliott
Subject: Highlight
Date: 6/30/2008 6:16:52 PM
 ACCEPT - DONE

after:
sends the following messages to the SP_DWS state machine
add:
indicating dwords received from the physical link

to match the wording used in all the other XYZ receiver sections

The SP_DWS receiver also sends Dword Received confirmations to the link layer state machine receivers (e.g., SL_IR, SL, SSP, SMP, and XL). If multiplexing is enabled (see table 100 in 6.7.4.2.3.3), the SP_DWS receiver shall use the first incoming MUX primitive to determine the logical phy to which it sends each Dword Received confirmation and shall not send a Dword Received confirmation until it receives the first incoming MUX primitive.

Upon receiving a Find Dword message, the SP_DWS receiver shall monitor the input data stream and force each K28.5 character detected into the first character position of a possible dword. If the next three characters are data characters with correct disparity, it shall send the dword as a Dword Received (Primitive) message to the SP_DWS state machine. Until it receives another Find Dword message, for every four characters it receives it shall:

- send a Dword Received (Invalid) message to the SP_DWS state machine if the dword is an invalid dword (see 3.1.114);
- send a Dword Received (Primitive) message to the SP_DWS state machine if the dword is a primitive (i.e., the dword contains a K28.5 character in the first character position followed by three data characters); or
- send a Dword Received (Data Dword) message to the SP_DWS state machine if the dword is a data dword (i.e., it is not an invalid dword or a primitive).

The SP_DWS receiver relationship to other receivers is defined in 4.3.3.

6.9.3 SP_DWS0:AcquireSync state

6.9.3.1 State description

This is the initial state of this state machine.

After receiving a Start DWS message, this state shall:

- send a Find Dword message to the SP_DWS receiver; and
- initialize and start the DWS Reset Timeout timer;

If this state is entered from SP_DWS1:Valid1 or SP_DWS2:Valid2, this state shall send a Find Dword message to the SP_DWS receiver, and the DWS Reset Timeout timer shall continue running.

~~If this state is entered from SP_DWS1:Valid1 or SP_DWS2:Valid2 and the DWS Reset Timeout timer has expired, this state may send a DWS Reset message to the SP state machine (e.g., if the phy chooses to initiate a new link reset sequence because dword synchronization has been lost for too long).~~

This state shall not send a DWS Reset message to the SP until the DWS Reset Timeout timer expires.

If the DWS Reset Timeout timer expires, this state may send a DWS Reset message to the SP state machine.

6.9.3.2 Transition SP_DWS0:AcquireSync to SP_DWS1:Valid1

This transition shall occur after sending a Find Dword message and receiving a Dword Received (Primitive) message.

6.9.4 SP_DWS1:Valid1 state

6.9.4.1 State description

This state is reached after one valid primitive has been received. This state waits for a second valid primitive or an invalid dword.

The DWS Reset Timeout timer shall continue running.

6.9.4.2 Transition SP_DWS1:Valid1 to SP_DWS0:AcquireSync

This transition shall occur after receiving a Dword Received (Invalid) message or after the DWS Reset Timeout timer expires.

Author: RElliott
Subject: Underline
Date: 6/30/2008 6:16:52 PM
T ACCEPT - DONE

The SP_DWS receiver also sends Dword Received confirmations to the link layer state machine receivers (e.g., SL_IR, SL, SSP, SMP, and XL).

s/b

When the SP_DWS receiver receives a Sync Acquired message, it shall send the most recently received primitive and all subsequent dwords to the link layer state machine receivers (e.g., SL_IR, SL, SSP, SMP, and XL) as Dword Received confirmations.

It doesn't send every Dword Received while searching for dword sync; just those after dword sync has been achieved.

This does let Dwords trickle upstream during SNWs (e.g. ALIGNs during SNW-1 and SNW-2). The link layers shouldn't care about any of them; there are no SOAFs or such inside the SNWs that would trigger any behavior. Plus, if SP has not yet reached a PHY_Ready state, the link layer state machines should still be hibernating.

Author: RElliott
Subject: Highlight
Date: 6/30/2008 6:16:52 PM
T ACCEPT - DONE

the

s/b

then the

Author: wdc-mevans
Subject: Highlight
Date: 5/21/2008 7:53:27 PM
T REJECT

it

s/b

the SP_DWS receiver

Author: wdc-mevans
Subject: Highlight
Date: 5/21/2008 7:53:32 PM
T REJECT

it

s/b

the SP_DWS receiver

Author: hpq-relliott
Subject: Note
Date: 6/25/2008 10:49:48 AM

 ACCEPT - DONE (Added Sync Acquired message from SP_DWS to SP_DWS receiver, which tells it to start forwarding Dword confirmations up to the link layer.)

SP_DWS doesn't send Dword Received confirmations upstream until the phy reset sequence is completed. Some feedback from SP is needed to know when this happens.

Author: wdc-mevans
Subject: Highlight
Date: 5/21/2008 7:55:02 PM
T ACCEPT - DONE (but added "then")

The SP_DWS receiver also sends Dword Received confirmations to the link layer state machine receivers (e.g., SL_IR, SL, SSP, SMP, and XL). If multiplexing is enabled (see table 100 in 6.7.4.2.3.3), the SP_DWS receiver shall use the first incoming MUX primitive to determine the logical phy to which it sends each Dword Received confirmation and shall not send an Dword Received confirmations until it receives the first incoming MUX primitive.

Upon receiving a Find Dword message, the SP_DWS receiver shall monitor the input data stream and force each K28.5 character detected into the first character position of a possible dword. If the next three characters are data characters with correct disparity, it shall send the dword as a Dword Received (Primitive) message to the SP_DWS state machine. Until it receives another Find Dword message, for every four characters it receives it shall:

- a) send a Dword Received (Invalid) message to the SP_DWS state machine if the dword is an invalid dword (see 3.1.114);
- b) send a Dword Received (Primitive) message to the SP_DWS state machine if the dword is a primitive (i.e., the dword contains a K28.5 character in the first character position followed by three data characters); or
- c) send a Dword Received (Data Dword) message to the SP_DWS state machine if the dword is a data dword (i.e., it is not an invalid dword or a primitive).

The SP_DWS receiver relationship to other receivers is defined in 4.3.3.

6.9.3 SP_DWS0:AcquireSync state

6.9.3.1 State description

This is the initial state of this state machine.

After receiving a Start DWS message, this state shall:

- a) send a Find Dword message to the SP_DWS receiver; and
- b) initialize and start the DWS Reset Timeout timer;

If this state is entered from SP_DWS1:Valid1 or SP_DWS2:Valid2, this state shall send a Find Dword message to the SP_DWS receiver, and the DWS Reset Timeout timer shall continue running.

~~If this state is entered from SP_DWS1:Valid1 or SP_DWS2:Valid2 and the DWS Reset Timeout timer has expired, this state may send a DWS Reset message to the SP state machine (e.g., if the phy chooses to initiate a new link reset sequence because dword synchronization has been lost for too long).~~

This state shall not send a DWS Reset message to the SP until the DWS Reset Timeout timer expires.

If the DWS Reset Timeout timer expires, this state may send a DWS Reset message to the SP state machine.

6.9.3.2 Transition SP_DWS0:AcquireSync to SP_DWS1:Valid1

This transition shall occur after sending a Find Dword message and receiving a Dword Received (Primitive) message.

6.9.4 SP_DWS1:Valid1 state

6.9.4.1 State description

This state is reached after one valid primitive has been received. This state waits for a second valid primitive or an invalid dword.

The DWS Reset Timeout timer shall continue running.

6.9.4.2 Transition SP_DWS1:Valid1 to SP_DWS0:AcquireSync

This transition shall occur after receiving a Dword Received (Invalid) message or after the DWS Reset Timeout timer expires.

it
s/b
the SP_DWS receiver

● Author: wdc-mevans
Subject: Highlight
Date: 5/21/2008 7:55:16 PM
 REJECT
it
s/b
the SP_DWS receiver

● Author: wdc-mevans
Subject: Highlight
Date: 5/21/2008 7:55:09 PM
 ACCEPT - DONE
it
s/b
the SP_DWS receiver

● Author: RElliott
Subject: Note
Date: 6/30/2008 6:16:52 PM
 ACCEPT - DONE

In SP_DWS0, send Sync Lost to the SP receiver whenever Find Dword is sent to the SP_DWS receiver

● Author: RElliott
Subject: Highlight
Date: 6/30/2008 6:16:52 PM
 ACCEPT - DONE
this
s/b
then this

● Author: wdc-mevans
Subject: Highlight
Date: 5/25/2008 7:48:00 PM
 ACCEPT - DONE
receiver. and
s/b
receiver, and

● Author: lsi-gpenokie
Subject: Highlight
Date: 5/6/2008 4:07:49 PM
 ACCEPT - DONE

In this << SP_DWS receiver. and the DWS Reset >> it looks like the comma is really a period.

● Author: elx-bmartin
Subject: Cross-Out
Date: 5/21/2008 7:58:18 PM
 ACCEPT - DONE (merged the two, keeping the e.g.)

delete
"If this state is entered from SP_DWS1:Valid1 or SP_DWS2:Valid2 and the DWS Reset Timeout timer has expired, this state may send a DWS Reset message to the SP state machine (e.g., if the phy chooses to initiate a new link reset sequence because dword synchronization has been lost for too long)."

This paragraph is a subset of this last paragraph in this subclause.

● Author: lsi-bday

The SP_DWS receiver also sends Dword Received confirmations to the link layer state machine receivers (e.g., SL_IR, SL, SSP, SMP, and XL). If multiplexing is enabled (see table 100 in 6.7.4.2.3.3), the SP_DWS receiver shall use the first incoming MUX primitive to determine the logical phy to which it sends each Dword Received confirmation and shall not send an Dword Received confirmations until it receives the first incoming MUX primitive.

Upon receiving a Find Dword message, the SP_DWS receiver shall monitor the input data stream and force each K28.5 character detected into the first character position of a possible dword. If the next three characters are data characters with correct disparity, it shall send the dword as a Dword Received (Primitive) message to the SP_DWS state machine. Until it receives another Find Dword message, for every four characters it receives it shall:

- a) send a Dword Received (Invalid) message to the SP_DWS state machine if the dword is an invalid dword (see 3.1.114);
- b) send a Dword Received (Primitive) message to the SP_DWS state machine if the dword is a primitive (i.e., the dword contains a K28.5 character in the first character position followed by three data characters); or
- c) send a Dword Received (Data Dword) message to the SP_DWS state machine if the dword is a data dword (i.e., it is not an invalid dword or a primitive).

The SP_DWS receiver relationship to other receivers is defined in 4.3.3.

6.9.3 SP_DWS0:AcquireSync state

6.9.3.1 State description

This is the initial state of this state machine.

After receiving a Start DWS message, this state shall:

- a) send a Find Dword message to the SP_DWS receiver; and
- b) initialize and start the DWS Reset Timeout timer;

If this state is entered from SP_DWS1:Valid1 or SP_DWS2:Valid2, this state shall send a Find Dword message to the SP_DWS receiver, and the DWS Reset Timeout timer shall continue running.

~~If this state is entered from SP_DWS1:Valid1 or SP_DWS2:Valid2 and the DWS Reset Timeout timer has expired, this state may send a DWS Reset message to the SP state machine (e.g., if the phy chooses to initiate a new link reset sequence because dword synchronization has been lost for too long).~~

This state shall not send a DWS Reset message to the SP until the DWS Reset Timeout timer expires.

If the DWS Reset Timeout timer expires, this state may send a DWS Reset message to the SP state machine.

6.9.3.2 Transition SP_DWS0:AcquireSync to SP_DWS1:Valid1

This transition shall occur after sending a Find Dword message and receiving a Dword Received (Primitive) message.

6.9.4 SP_DWS1:Valid1 state

6.9.4.1 State description

This state is reached after one valid primitive has been received. This state waits for a second valid primitive or an invalid dword.

The DWS Reset Timeout timer shall continue running.

6.9.4.2 Transition SP_DWS1:Valid1 to SP_DWS0:AcquireSync

This transition shall occur after receiving a Dword Received (Invalid) message or after the DWS Reset Timeout timer expires.

Subject: Cross-Out

Date: 5/21/2008 7:58:32 PM

 ACCEPT - DONE (merged the two, keeping the e.g.)

If this state is entered from SP_DWS1:Valid1 or SP_DWS2:Valid2 and the DWS Reset Timeout timer has expired, this state may send a DWS Reset message to the SP state machine (e.g., if the phy chooses to initiate a new link reset sequence because dword synchronization has been lost for too long).

Redundant with last sentence in this section.

● Author: wdc-mevans

Subject: Highlight

Date: 5/25/2008 7:48:23 PM

 REJECT (2 things ANDED)

:Valid2 and

s/b

:Valid2, and

● Author: wdc-mevans

Subject: Highlight

Date: 5/21/2008 8:01:25 PM

 REJECT

chooses to initiate

s/b

initiates

● Author: RElliott

Subject: Highlight

Date: 6/30/2008 6:16:52 PM

 ACCEPT - DONE

this

s/b

then this

● Author: wdc-mevans

Subject: Highlight

Date: 5/25/2008 7:48:53 PM

 REJECT

receiving

s/b

receives

● Author: wdc-mevans

Subject: Highlight

Date: 5/25/2008 7:48:45 PM

 REJECT (there are 54 uses of "after sending" vs 9 uses of "after this state sends." Similar usage is found in the "receiving" phrases as well. The shorter phrase wins.)

sending

s/b

this state sends

● Author: wdc-mevans

Subject: Highlight

Date: 5/25/2008 7:49:01 PM

 REJECT

receiving

s/b

this state receives

Comments from page 281 continued on next page

The SP_DWS receiver also sends Dword Received confirmations to the link layer state machine receivers (e.g., SL_IR, SL, SSP, SMP, and XL). If multiplexing is enabled (see table 100 in 6.7.4.2.3.3), the SP_DWS receiver shall use the first incoming MUX primitive to determine the logical phy to which it sends each Dword Received confirmation and shall not send an Dword Received confirmations until it receives the first incoming MUX primitive.

Upon receiving a Find Dword message, the SP_DWS receiver shall monitor the input data stream and force each K28.5 character detected into the first character position of a possible dword. If the next three characters are data characters with correct disparity, it shall send the dword as a Dword Received (Primitive) message to the SP_DWS state machine. Until it receives another Find Dword message, for every four characters it receives it shall:

- a) send a Dword Received (Invalid) message to the SP_DWS state machine if the dword is an invalid dword (see 3.1.114);
- b) send a Dword Received (Primitive) message to the SP_DWS state machine if the dword is a primitive (i.e., the dword contains a K28.5 character in the first character position followed by three data characters); or
- c) send a Dword Received (Data Dword) message to the SP_DWS state machine if the dword is a data dword (i.e., it is not an invalid dword or a primitive).

The SP_DWS receiver relationship to other receivers is defined in 4.3.3.

6.9.3 SP_DWS0:AcquireSync state

6.9.3.1 State description

This is the initial state of this state machine.

After receiving a Start DWS message, this state shall:

- a) send a Find Dword message to the SP_DWS receiver; and
- b) initialize and start the DWS Reset Timeout timer;

If this state is entered from SP_DWS1:Valid1 or SP_DWS2:Valid2, this state shall send a Find Dword message to the SP_DWS receiver, and the DWS Reset Timeout timer shall continue running.

~~If this state is entered from SP_DWS1:Valid1 or SP_DWS2:Valid2 and the DWS Reset Timeout timer has expired, this state may send a DWS Reset message to the SP state machine (e.g., if the phy chooses to initiate a new link reset sequence because dword synchronization has been lost for too long).~~

This state shall not send a DWS Reset message to the SP until the DWS Reset Timeout timer expires.

If the DWS Reset Timeout timer expires, this state may send a DWS Reset message to the SP state machine.

6.9.3.2 Transition SP_DWS0:AcquireSync to SP_DWS1:Valid1

This transition shall occur after sending a Find Dword message and receiving a Dword Received (Primitive) message.

6.9.4 SP_DWS1:Valid1 state

6.9.4.1 State description

This state is reached after one valid primitive has been received. This state waits for a second valid primitive or an invalid dword.

The DWS Reset Timeout timer shall continue running.

6.9.4.2 Transition SP_DWS1:Valid1 to SP_DWS0:AcquireSync

This transition shall occur after receiving a Dword Received (Invalid) message or after the DWS Reset Timeout timer expires.

6.9.4.3 Transition SP_DWS1:Valid1 to SP_DWS2:Valid2

This transition shall occur after **receiving** a Dword Received (Primitive) message.

6.9.5 SP_DWS2:Valid2 state**6.9.5.1 State description**

This state is reached after two valid primitives have been received without adjusting the dword synchronization. This state waits for a third valid primitive or an invalid dword.

The DWS Reset Timeout timer shall continue running.

6.9.5.2 Transition SP_DWS2:Valid2 to SP_DWS0:AcquireSync

This transition shall occur after **receiving** a Dword Received (Invalid) message or after the DWS Reset Timeout timer expires.

6.9.5.3 Transition SP_DWS2:Valid2 to SP_DWS3:SyncAcquired

This transition shall occur after **receiving** a Dword Received (Primitive) message.

6.9.6 SP_DWS3:SyncAcquired state**6.9.6.1 State description**

This state is reached after three valid primitives have been received without adjusting the dword synchronization.

The most recently received primitive and all subsequent dwords shall be forwarded for processing by the link layer.

This state waits for a Dword Received (Invalid) message, which indicates that dword synchronization **might** be lost, or an Incorrect Mux Received message, which indicates that dword synchronization is lost.

If an Incorrect Mux Received message is received, **this** state shall send a DWS Lost message to the SP state machine.

6.9.6.2 Transition SP_DWS3:SyncAcquired to SP_DWS0:AcquireSync

This transition shall occur after **sending** a DWS Lost message.

6.9.6.3 Transition SP_DWS3:SyncAcquired to SP_DWS4:Lost1

This transition shall occur after **receiving** a Dword Received (Invalid) message.

6.9.7 SP_DWS4:Lost1 state**6.9.7.1 State description**

This state is reached when one invalid dword has been received and not nullified. This state waits for a Dword Received message or an Incorrect Mux Received message.

If an Incorrect Mux Received message is received, **this** state shall send a DWS Lost message to the SP state machine.

6.9.7.2 Transition SP_DWS4:Lost1 to SP_DWS0:AcquireSync

This transition shall occur after **sending** a DWS Lost message.

6.9.7.3 Transition SP_DWS4:Lost1 to SP_DWS5:Lost1Recovered

This transition shall occur after **receiving** a Dword Received (Data Dword) message or a Dword Received (Primitive) message.

● Author: wdc-mevans
Subject: Highlight
Date: 5/25/2008 7:49:07 PM
 REJECT

receiving
s/b
this state receives

● Author: wdc-mevans
Subject: Highlight
Date: 5/25/2008 7:49:12 PM
 REJECT

receiving
s/b
this state receives

● Author: wdc-mevans
Subject: Highlight
Date: 5/25/2008 7:49:15 PM
 REJECT

receiving
s/b
this state receives

● Author: RElliott
Subject: Note
Date: 6/30/2008 6:16:52 PM
 ACCEPT - DONE

Upon entry to SP_DWS3, send Sync Acquired to the SP receiver

● Author: wdc-mevans
Subject: Highlight
Date: 6/25/2008 9:44:17 AM
 REJECT ("may" is defined as granting "flexibility of choice". Dword Received (Invalid) doesn't have anything to do with choice or granting any entity permission to do something or not do something; it is an indication that dword synchronization might possibly have been lost.)

might
s/b
may

● Author: RElliott
Subject: Highlight
Date: 6/30/2008 6:16:52 PM
 ACCEPT - DONE

this
s/b
then this

● Author: wdc-mevans
Subject: Highlight
Date: 5/25/2008 7:49:30 PM
 REJECT

sending
s/b

6.9.4.3 Transition SP_DWS1:Valid1 to SP_DWS2:Valid2

This transition shall occur after **receiving** a Dword Received (Primitive) message.

6.9.5 SP_DWS2:Valid2 state**6.9.5.1 State description**

This state is reached after two valid primitives have been received without adjusting the dword synchronization. This state waits for a third valid primitive or an invalid dword.

The DWS Reset Timeout timer shall continue running.

6.9.5.2 Transition SP_DWS2:Valid2 to SP_DWS0:AcquireSync

This transition shall occur after **receiving** a Dword Received (Invalid) message or after the DWS Reset Timeout timer expires.

6.9.5.3 Transition SP_DWS2:Valid2 to SP_DWS3:SyncAcquired

This transition shall occur after **receiving** a Dword Received (Primitive) message.

6.9.6 SP_DWS3:SyncAcquired state**6.9.6.1 State description**

This state is reached after three valid primitives have been received without adjusting the dword synchronization.

The most recently received primitive and all subsequent dwords shall be forwarded for processing by the link layer.

This state waits for a Dword Received (Invalid) message, which indicates that dword synchronization **might** be lost, or an Incorrect Mux Received message, which indicates that dword synchronization is lost.

If an Incorrect Mux Received message is received, **this** state shall send a DWS Lost message to the SP state machine.

6.9.6.2 Transition SP_DWS3:SyncAcquired to SP_DWS0:AcquireSync

This transition shall occur after **sending** a DWS Lost message.

6.9.6.3 Transition SP_DWS3:SyncAcquired to SP_DWS4:Lost1

This transition shall occur after **receiving** a Dword Received (Invalid) message.

6.9.7 SP_DWS4:Lost1 state**6.9.7.1 State description**

This state is reached when one invalid dword has been received and not nullified. This state waits for a Dword Received message or an Incorrect Mux Received message.

If an Incorrect Mux Received message is received, **this** state shall send a DWS Lost message to the SP state machine.

6.9.7.2 Transition SP_DWS4:Lost1 to SP_DWS0:AcquireSync

This transition shall occur after **sending** a DWS Lost message.

6.9.7.3 Transition SP_DWS4:Lost1 to SP_DWS5:Lost1Recovered

This transition shall occur after **receiving** a Dword Received (Data Dword) message or a Dword Received (Primitive) message.

this state sends

● Author: wdc-mevans
Subject: Highlight
Date: 5/25/2008 7:49:34 PM
T REJECT

receiving
s/b
this state receives

● Author: RElliott
Subject: Highlight
Date: 6/30/2008 6:16:52 PM
T ACCEPT - DONE

this
s/b
then this

● Author: wdc-mevans
Subject: Highlight
Date: 5/25/2008 7:49:37 PM
T REJECT

sending
s/b
this state sends

● Author: wdc-mevans
Subject: Highlight
Date: 5/25/2008 7:49:40 PM
T REJECT

receiving
s/b
this state receives

6.9.7.4 Transition SP_DWS4:Lost1 to SP_DWS6:Lost2

This transition shall occur after **receiving** a Dword Received (Invalid) message.

6.9.8 SP_DWS5:Lost1Recovered state**6.9.8.1 State description**

This state is reached when a valid dword has been received after one invalid dword had been received. This state waits for a Dword Received message or an Incorrect Mux Received message.

If an Incorrect Mux Received message is received, **this** state shall send a DWS Lost message to the SP state machine.

6.9.8.2 Transition SP_DWS5:Lost1Recovered to SP_DWS0:AcquireSync

This transition shall occur after **sending** a DWS Lost message.

6.9.8.3 Transition SP_DWS5:Lost1Recovered to SP_DWS3:SyncAcquired

This transition shall occur after **receiving** a Dword Received (Data Dword) message or a Dword Received (Primitive) message.

6.9.8.4 Transition SP_DWS5:Lost1Recovered to SP_DWS6:Lost2

This transition shall occur after **receiving** a Dword Received (Invalid) message.

6.9.9 SP_DWS6:Lost2 state**6.9.9.1 State description**

This state is reached when two invalid dwords have been received and not nullified. This state waits for a Dword Received message or an Incorrect Mux Received message.

If an Incorrect Mux Received message is received, **this** state shall send a DWS Lost message to the SP state machine.

6.9.9.2 Transition SP_DWS6:Lost2 to SP_DWS0:AcquireSync

This transition shall occur after **sending** a DWS Lost message.

6.9.9.3 Transition SP_DWS6:Lost2 to SP_DWS7:Lost2Recovered

This transition shall occur after **receiving** a Dword Received (Data Dword) message or a Dword Received (Primitive) message.

6.9.9.4 Transition SP_DWS6:Lost2 to SP_DWS8:Lost3

This transition shall occur after **receiving** a Dword Received (Invalid) message.

6.9.10 SP_DWS7:Lost2Recovered state**6.9.10.1 State description**

This state is reached when a valid dword has been received after two invalid dwords had been received. This state waits for a Dword Received message or an Incorrect Mux Received message.

If an Incorrect Mux Received message is received, **this** state shall send a DWS Lost message to the SP state machine.

6.9.10.2 Transition SP_DWS7:Lost2Recovered to SP_DWS0:AcquireSync

This transition shall occur after **sending** a DWS Lost message.

● Author: wdc-mevans
Subject: Highlight
Date: 5/25/2008 7:49:42 PM
T REJECT

receiving
s/b
this state receives

● Author: RElliott
Subject: Highlight
Date: 6/30/2008 6:16:52 PM
T ACCEPT - DONE

this
s/b
then this

● Author: wdc-mevans
Subject: Highlight
Date: 5/25/2008 7:49:45 PM
T REJECT

sending
s/b
this state sends

● Author: wdc-mevans
Subject: Highlight
Date: 5/25/2008 7:49:48 PM
T REJECT

receiving
s/b
this state receives

● Author: wdc-mevans
Subject: Highlight
Date: 5/25/2008 7:49:50 PM
T REJECT

receiving
s/b
this state receives

● Author: RElliott
Subject: Highlight
Date: 6/30/2008 6:16:52 PM
T ACCEPT - DONE

this
s/b
then this

● Author: wdc-mevans
Subject: Highlight
Date: 5/25/2008 7:49:53 PM
T REJECT

sending
s/b

6.9.7.4 Transition SP_DWS4:Lost1 to SP_DWS6:Lost2

This transition shall occur after **receiving** a Dword Received (Invalid) message.

6.9.8 SP_DWS5:Lost1Recovered state

6.9.8.1 State description

This state is reached when a valid dword has been received after one invalid dword had been received. This state waits for a Dword Received message or an Incorrect Mux Received message.

If an Incorrect Mux Received message is received, **this** state shall send a DWS Lost message to the SP state machine.

6.9.8.2 Transition SP_DWS5:Lost1Recovered to SP_DWS0:AcquireSync

This transition shall occur after **sending** a DWS Lost message.

6.9.8.3 Transition SP_DWS5:Lost1Recovered to SP_DWS3:SyncAcquired

This transition shall occur after **receiving** a Dword Received (Data Dword) message or a Dword Received (Primitive) message.

6.9.8.4 Transition SP_DWS5:Lost1Recovered to SP_DWS6:Lost2

This transition shall occur after **receiving** a Dword Received (Invalid) message.

6.9.9 SP_DWS6:Lost2 state

6.9.9.1 State description

This state is reached when two invalid dwords have been received and not nullified. This state waits for a Dword Received message or an Incorrect Mux Received message.

If an Incorrect Mux Received message is received, **this** state shall send a DWS Lost message to the SP state machine.

6.9.9.2 Transition SP_DWS6:Lost2 to SP_DWS0:AcquireSync

This transition shall occur after **sending** a DWS Lost message.

6.9.9.3 Transition SP_DWS6:Lost2 to SP_DWS7:Lost2Recovered

This transition shall occur after **receiving** a Dword Received (Data Dword) message or a Dword Received (Primitive) message.

6.9.9.4 Transition SP_DWS6:Lost2 to SP_DWS8:Lost3

This transition shall occur after **receiving** a Dword Received (Invalid) message.

6.9.10 SP_DWS7:Lost2Recovered state

6.9.10.1 State description

This state is reached when a valid dword has been received after two invalid dwords had been received. This state waits for a Dword Received message or an Incorrect Mux Received message.

If an Incorrect Mux Received message is received, **this** state shall send a DWS Lost message to the SP state machine.

6.9.10.2 Transition SP_DWS7:Lost2Recovered to SP_DWS0:AcquireSync

This transition shall occur after **sending** a DWS Lost message.

this state sends

● Author: wdc-mevans
Subject: Highlight
Date: 5/25/2008 7:49:55 PM
TREJECT

receiving
s/b
this state receives

● Author: wdc-mevans
Subject: Highlight
Date: 5/25/2008 7:50:00 PM
TREJECT

receiving
s/b
this state receives

● Author: RElliott
Subject: Highlight
Date: 6/30/2008 6:16:52 PM
TACCEPT - DONE

this
s/b
then this

● Author: wdc-mevans
Subject: Highlight
Date: 5/25/2008 7:50:02 PM
TREJECT

sending
s/b
this state sends

6.9.10.3 Transition SP_DWS7:Lost2Recovered to SP_DWS4:Lost1

This transition shall occur after **receiving** a Dword Received (Data Dword) message or a Dword Received (Primitive) message.

6.9.10.4 Transition SP_DWS7:Lost2Recovered to SP_DWS8:Lost3

This transition shall occur after **receiving** a Dword Received (Invalid) message.

6.9.11 SP_DWS8:Lost3 state**6.9.11.1 State description**

This state is reached when three invalid dwords have been received and not nullified. This state waits for a Dword Received message or an Incorrect Mux Received message.

If a Dword Received (Invalid) message is received (i.e., the fourth non-nullified invalid dword is received), **this** state shall send a DWS Lost message to the SP state machine.

If an Incorrect Mux Received message is received, **this** state shall send a DWS Lost message to the SP state machine.

6.9.11.2 Transition SP_DWS8:Lost3 to SP_DWS0:AcquireSync

This transition shall occur after **sending** a DWS Lost message.

6.9.11.3 Transition SP_DWS8:Lost3 to SP_DWS9:Lost3Recovered

This transition shall occur after **receiving** a Dword Received (Data Dword) message or a Dword Received (Primitive) message.

6.9.12 SP_DWS9:Lost3Recovered state**6.9.12.1 State description**

This state is reached when a valid dword has been received after three invalid dwords had been received. This state waits for a Dword Received message or an Incorrect Mux Received message.

If a Dword Received (Invalid) message is received (i.e., the fourth non-nullified invalid dword is received), **this** state shall send a DWS Lost message to the SP state machine.

If an Incorrect Mux Received message is received, **this** state shall send a DWS Lost message to the SP state machine.

6.9.12.2 Transition SP_DWS9:Lost3Recovered to SP_DWS0:AcquireSync

This transition shall occur after **sending** a DWS Lost message.

6.9.12.3 Transition SP_DWS9:Lost3Recovered to SP_DWS6:Lost2

This transition shall occur after receiving a Dword Received (Data Dword) message or a Dword Received (Primitive) message.

6.10 Multiplexing

If SNW-3 indicates multiplexing is enabled (see table 100 in 6.7.4.2.3.3), **the** phy shall begin multiplexing immediately after the multiplexing sequence (see 6.7.4.3).

● Author: wdc-mevans
Subject: Highlight
Date: 5/25/2008 7:50:05 PM
T REJECT

receiving
s/b
this state receives

● Author: wdc-mevans
Subject: Highlight
Date: 5/25/2008 7:50:07 PM
T REJECT

receiving
s/b
this state receives

● Author: RElliott
Subject: Highlight
Date: 6/30/2008 6:16:52 PM
T ACCEPT - DONE

this
s/b
then this

● Author: RElliott
Subject: Highlight
Date: 6/30/2008 6:16:52 PM
T ACCEPT - DONE

this
s/b
then this

● Author: wdc-mevans
Subject: Highlight
Date: 5/25/2008 7:50:10 PM
T REJECT

sending
s/b
this state sends

● Author: wdc-mevans
Subject: Highlight
Date: 5/25/2008 7:50:12 PM
T REJECT

receiving
s/b
this state receives

● Author: RElliott
Subject: Highlight
Date: 6/30/2008 6:16:52 PM
T ACCEPT - DONE

this
s/b
then this

6.9.10.3 Transition SP_DWS7:Lost2Recovered to SP_DWS4:Lost1

This transition shall occur after **receiving** a Dword Received (Data Dword) message or a Dword Received (Primitive) message.

6.9.10.4 Transition SP_DWS7:Lost2Recovered to SP_DWS8:Lost3

This transition shall occur after **receiving** a Dword Received (Invalid) message.

6.9.11 SP_DWS8:Lost3 state

6.9.11.1 State description

This state is reached when three invalid dwords have been received and not nullified. This state waits for a Dword Received message or an Incorrect Mux Received message.

If a Dword Received (Invalid) message is received (i.e., the fourth non-nullified invalid dword is received), **this** state shall send a DWS Lost message to the SP state machine.

If an Incorrect Mux Received message is received, **this** state shall send a DWS Lost message to the SP state machine.

6.9.11.2 Transition SP_DWS8:Lost3 to SP_DWS0:AcquireSync

This transition shall occur after **sending** a DWS Lost message.

6.9.11.3 Transition SP_DWS8:Lost3 to SP_DWS9:Lost3Recovered

This transition shall occur after **receiving** a Dword Received (Data Dword) message or a Dword Received (Primitive) message.

6.9.12 SP_DWS9:Lost3Recovered state

6.9.12.1 State description

This state is reached when a valid dword has been received after three invalid dwords had been received. This state waits for a Dword Received message or an Incorrect Mux Received message.

If a Dword Received (Invalid) message is received (i.e., the fourth non-nullified invalid dword is received), **this** state shall send a DWS Lost message to the SP state machine.

If an Incorrect Mux Received message is received, **this** state shall send a DWS Lost message to the SP state machine.

6.9.12.2 Transition SP_DWS9:Lost3Recovered to SP_DWS0:AcquireSync

This transition shall occur after **sending** a DWS Lost message.

6.9.12.3 Transition SP_DWS9:Lost3Recovered to SP_DWS6:Lost2

This transition shall occur after receiving a Dword Received (Data Dword) message or a Dword Received (Primitive) message.

6.10 Multiplexing

If SNW-3 indicates multiplexing is enabled (see table 100 in 6.7.4.2.3.3), **the** phy shall begin multiplexing immediately after the multiplexing sequence (see 6.7.4.3).

Author: RElliott
Subject: Highlight
Date: 6/30/2008 6:16:52 PM
T ACCEPT - DONE
this
s/b
then this

Author: wdc-mevans
Subject: Highlight
Date: 5/25/2008 7:50:15 PM
T REJECT
sending
s/b
this state sends

Author: RElliott
Subject: Highlight
Date: 6/30/2008 6:16:52 PM
T ACCEPT - DONE
the
s/b
then the

Figure 161 shows multiplexing disabled (i.e., one logical link).

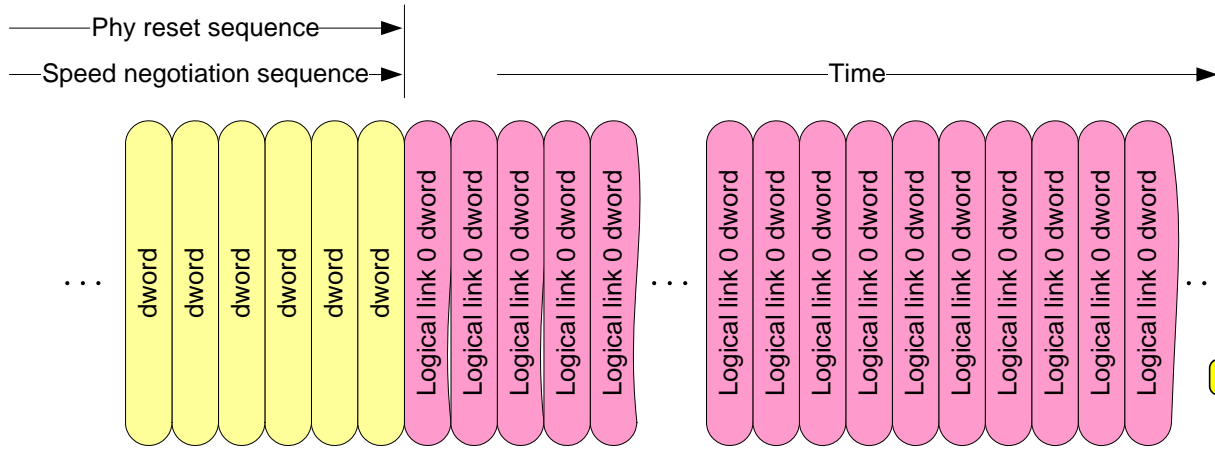

Figure 161 — Multiplexing disabled

Figure 162 shows multiplexing enabled (i.e., two logical links).

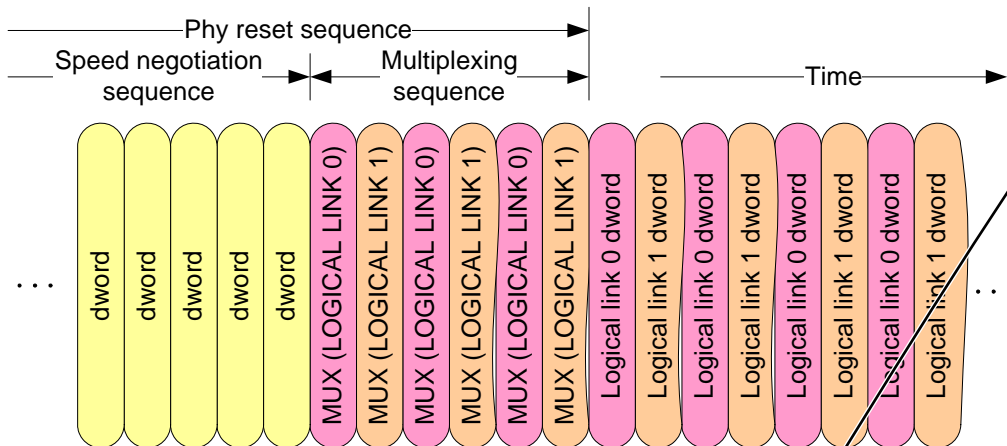

Figure 162 — Multiplexing enabled

After the multiplexing sequence completes, each logical phy shall honor the deletable primitive insertion requirements for physical link rate tolerance management defined in 7.3. The logical phys shall ignore MUX primitives.

If a phy with multiplexing enabled ever loses dword synchronization, it shall restart the link reset sequence rather than attempt to reestablish dword synchronization.

Once the multiplexing sequence is complete, the phy shall not perform another multiplexing sequence until a new link reset sequence.

Once the multiplexing sequence is complete:

- a) a logical phy originating dwords shall transmit MUX as a deletable primitive (e.g., in place on an ALIGN) at least once every millisecond; and
- b) a logical phy forwarding dwords should transmit MUX as a deletable primitive at least once every millisecond to confirm the logical link numbers.

Transmitting NOTIFY has higher priority than transmitting MUX.

NOTE 43 - Periodic MUX transmission is for the convenience of logic analyzers and to provide additional assurance that the receiving phy is in agreement with the transmitting phy.

● Author: RElliott

Subject: Note

Date: 8/31/2008 6:38:30 PM

 ACCEPT - LAST (Visio wavy lines - unknown what causes this or how to fix it)

fix Visio curves

● Author: wdc-mevans

Subject: Highlight

Date: 5/25/2008 3:47:34 PM

 REJECT (first noun/subject convention, but added then)

it

s/b

then the phy

● Author: RElliott

Subject: Highlight

Date: 6/30/2008 6:16:52 PM

 ACCEPT - DONE

in place on

s/b

substituted in place of

If a phy ever receives a MUX primitive that does not match the MUX primitive expected in that position (i.e., it receives MUX (LOGICAL LINK 1) on logical link 0 or receives MUX (LOGICAL LINK 0) on logical link 1), it shall perform a link reset sequence.

6.11 Spin-up

If a SAS target device receives COMSAS during the reset sequence, it shall not spin-up until allowed by the SA_PC state machine (see 10.2.10).

Expander devices that detect an attached SATA phy may halt the automatic phy reset sequence after the COMSAS Detect Timeout (see 6.8) to delay spin-up; this is called SATA spin-up hold. This is reported in the NEGOTIATED PHYSICAL LINK RATE field in the SMP DISCOVER response (see 10.4.3.10) and is released with the SMP PHY CONTROL function (see 10.4.3.28).

NOTE 44 - Enclosures supporting both SATA devices and SAS target devices may need to sequence power to each attached device to avoid excessive power consumption, during power on, since the SATA devices may spin-up automatically after power on if staggered spin-up is not implemented (see SATA-2).

Page: 286

● Author: wdc-mevans
Subject: Highlight
Date: 5/22/2008 10:01:43 AM
T REJECT (first noun/subject convention)

it
s/b
the phy

● Author: wdc-mevans
Subject: Highlight
Date: 5/22/2008 10:03:32 AM
T REJECT (first noun/subject convention, but added "then")

it
s/b
then the phy

● Author: wdc-mevans
Subject: Highlight
Date: 5/21/2008 8:08:24 PM
T ACCEPT - DONE (5/5 WG likes:
... then it shall not temporarily consume additional power (e.g., to spin up rotating media) until allowed...
)

spin-up
s/b
activate its spindle motor

● Author: wdc-mevans
Subject: Highlight
Date: 5/25/2008 7:51:03 PM
T REJECT (first noun/subject convention, but added "then")

it
s/b
then the SAS target device

● Author: RElliott
Subject: Highlight
Date: 6/30/2008 6:16:52 PM
T ACCEPT - DONE

reset sequence
s/b
OOB sequence

● Author: wdc-mevans
Subject: Highlight
Date: 5/21/2008 8:09:00 PM
T REJECT (but moving reference to "spin up" to the e.g. level everywhere)

device receives
s/b
device containing a spindle motor for rotating medium

● Author: wdc-mevans
Subject: Highlight
Date: 5/21/2008 8:09:20 PM

Comments from page 286 continued on next page

If a phy ever receives a MUX primitive that does not match the MUX primitive expected in that position (i.e., it receives MUX (LOGICAL LINK 1) on logical link 0 or receives MUX (LOGICAL LINK 0) on logical link 1), it shall perform a link reset sequence.

6.11 Spin-up

If a SAS target device receives COMSAS during the reset sequence, it shall not spin-up until allowed by the SA_PC state machine (see 10.2.10).

Expander devices that detect an attached SATA phy may halt the automatic phy reset sequence after the COMSAS Detect Timeout (see 6.8) to delay spin-up; this is called SATA spinup hold. This is reported in the NEGOTIATED PHYSICAL LINK RATE field in the SMP DISCOVER response (see 10.4.3.10) and is released with the SMP PHY CONTROL function (see 10.4.3.28).

NOTE 44 - Enclosures supporting both SATA devices and SAS target devices may need to sequence power to each attached device to avoid excessive power consumption during power on, since the SATA devices may spin-up automatically after power on if staggered spin-up is not implemented (see SATA-2).

TREJECT (but changing to "temporary consumption of additional power")

spin-up

s/b

spindle motor activation

● Author: lsi-gpenokie

Subject: Highlight

Date: 8/27/2008 5:31:29 PM

TACCEPT - DONE (Add a glossary entry for "SATA spinup hold". Change to "The resulting SATA spinup hold is reported in..."

it would be unclear the extent of the phrase that the i.e. is rephrasing, and there is nothing wrong with semicolons)

This << to delay spin-up; this is called SATA spinup hold. This >> should be << to delay spin-up (i.e., SATA spinup hold). This >>

● Author: wdc-mevans

Subject: Cross-Out

Date: 5/6/2008 4:07:49 PM

TREJECT (the enclosure would not be doing this because it wants to... it's required to avoid power supply problems. The words are

important)

need to

s/b

[Delete unnecessary words.]

7 Link layer

7.1 Link layer overview

The link layer defines primitives, address frames, and connections. Link layer state machines interface to the port layer and the phy layer and perform the identification and hard reset sequences, connection management, and SSP, STP, and SMP specific frame transmission and reception.

7.2 Primitives

7.2.1 Primitives overview

Primitives are dwords whose first character is a K28.3 or K28.5. Primitives are not considered big-endian or little-endian; they are just interpreted as first, second, third, and last characters. Table 106 defines the primitive format.

Table 106 — Primitive format

Character	Description
First	K28.5 control character (for primitives defined in this standard) or K28.3 control character (for primitives defined by SATA).
Second	Constant data character.
Third	Constant data character.
Last	Constant data character.

Author: ibm-ted-vojnovich

Subject: Note

Date: 6/28/2008 1:38:45 PM

 REJECT (the main advice is: don't send the hard reset. It's only supposed to be used if an initiator thinks the target device is totally broken, providing the closest simulation of the old RESET# line in parallel SCSI that we can offer in a serial interconnect.

SAS-1 included an I_T NEXUS RESET task management function to solve this problem for most cases (e.g., as the initiator response to an I/O timeout); initiators do not disturb others when they use that.

SAS-2 includes more workarounds, as some initiators and targets did not support I_T NEXUS RESET like they should have:

- a) Broadcast (Asynchronous Event) provides notification that a logical unit underwent a reset; and
- b) QUERY UNIT ATTENTION task management function reports the reason for a Broadcast (Asynchronous Event)

We could perhaps add some text in chapter 4 or an informative annex explaining the way to use these tools, but that always generates arguments that we shouldn't "favor" one solution. SCSI always defines target behavior but rarely prescribes initiator behavior.

)

Section 7: Hard resets create real problems in expander solutions. For example, the following has been seen (and worked around with some vendor specific functions/broadcast async functions):

4 initiators ==>EXP A==>RAID controller. When initiator 1 sends a hard reset to the RAID controller, the port is reset...this, in turn, filters up to initiators 2,3,4 who intern issue their own hard resets...and so on and so on. This hard reset storm is a problem that may need some thinking from a fabric paradigm view.

ie...would think at least some description of behavior or approach should be used for hard resets in a fabric paradigm.

Author: ibm-ted-vojnovich

Subject: Note

Date: 5/25/2008 8:20:09 PM

 REJECT (5/5

1. the expander can be set up to a paranoid level that reverts a phy to zone group 0 (no access) if the link ever goes down, letting the zone manager go check the address if it wants before reestablishing permissions.
2. If the zone manager changes and zone permission table entries or zone phy information, the expander sends a Broadcast (Change) to at least all affected zone groups during the unlock step (see 4.9.6.5). This way initiators learn that their drives have disappeared or new drives have been added.
3. The issue of route table entries for subtractive phys being optimized away, causing shifting of entries of an expander is replaced by an end device, goes away if self-configuring expanders are used. Self-configuration is required for zoning.
4. Exposing the zone group field to the endpoints was considered and rejected. It is not secure; the concept of zoning is that you trust everything in the ZPSDS and don't trust anything outside. Any incoming zone group field would have to be ignored. Outgoing fields were considered to allow non-zoning expanders to still try and filter Broadcasts (with no guarantee they do so correctly), but this was dropped. It is not backwards compatible, so expanders would have to filter based on SAS version.

)

Section 7: Broadcast change may need to think about the following: 4 initiators==>EXP A==> 4 disks such that initiator 1 is zoned to disk 1, 2 to 2, 3 to 3.. Now assume some initiator specific info on each disk (ie OS for server 1, different OS for server 2, etc). If the admin, inadvertently rearranges the disks (because needed to service expander or whatever), the SAS fabric would say all is fine even though there was an actual change. This leads to data corruption issues or, at the very least, an unusable system until admin figures out the problem (brute force, assuming admin even thought this was the issue, of 16 disk configurations until finding the correct one).

I think some method of scoreboarding the SAS address of targets to PHYs (present anyway since routing tables need to know this) would allow a broadcast change event if the table changed (currently does not). I am **NOT talking about address based zoning.. that is much more complicated I think. I view this one as a big deal!!! I dont think this can be deferred to SES and I don't think one can assume this will not happen.**

I could be had in forcing the initiator to track this table since they do discovery anyway. Anyway, think there needs to be some discussion on this front!!!!

Routing behavior "perception" seems to vary from vendor to vendor. In essence, when an expander is has a subtractive port, some initiator vendors believe (either have seen or FUD) that the routing table will be rearranged on the fly and thus get them confused when they update their entries. Would think some clarification is in order on what the behavior should be.

Zone group present in the open frame seems way to complicated and, frankly, turns this into an "implicit context protocol" which has not been used in 15 years on the networking side (TCP/IP, UDP, etc). Specifically, since the end point

7 Link layer

7.1 Link layer overview

The link layer defines primitives, address frames, and connections. Link layer state machines interface to the port layer and the phy layer and perform the identification and hard reset sequences, connection management, and SSP, STP, and SMP specific frame transmission and reception.

7.2 Primitives

7.2.1 Primitives overview

Primitives are dwords whose first character is a K28.3 or K28.5. Primitives are not considered big-endian or little-endian; they are just interpreted as first, second, third, and last characters. Table 106 defines the primitive format.

Table 106 — Primitive format

Character	Description
First	K28.5 control character (for primitives defined in this standard) or K28.3 control character (for primitives defined by SATA).
Second	Constant data character.
Third	Constant data character.
Last	Constant data character.

transmitter (initiator) transmits zone group =0 and the last expander before the receiver (target) transmits zone group=0, basically the end points have no clue what the zone group is. Therefore any artificial processing involves the receiver to go and look at the routing and permissions tables to figure what zone group the transmitter was in to figure out what the receiver should do with information. Seems real convoluted!!!! Since the receiver typically ignores the field why not use the following on page 332

A) May be set to 0 or may have source zone group when transmitted by end point (aka entering the zone domain because end point)

B) Set to zone group when transmitted by expander with inside ZPDS = 0 (aka leaving the zone domain because expander is at the boundary)

C) Set to zone group when transmitted by expander with inside ZPDS=1 (aka staying within zone domain because expander and link is still in zone domain)

D) May be ignored or acted on by receiver end point (aka leaving the zone domain because end point)

E) May be ignored or acted on by receiving expander with inside ZPDS=0 (aka arriving from another zone domain)

F) Acted on by receiving expander with inside ZPDS=1 (aka staying within zone domain because link and expander is still in zone domain)

This allows the end points to have the zone group info available if needed. Aka if transmitter does not support....set to 0...if receiver wants to act on it...notes 0 and treat as if one be zone domain (ZG=0 means all can see all) or not valid and take some default action. I view this as pretty important

This then puts the burden on the implementation to support...perhaps over time....but the point is that the approach is defined in the standard.

Author: Isi-gpenokie

Subject: Highlight

Date: 5/25/2008 8:20:40 PM

TREJECT (a single comma is not valid for joining independent clauses; at the very least, a coordinating conjunction such as "and" would be needed. Since the second clause uses a pronoun "they" introduced by the prior sentence, and is referring to the endianness concept discussed by the prior sentence rather than a concept threading through the whole paragraph, it is better grammar to join them with a semicolon rather than create two independent sentences.)

This << little-endian; they are just interpreted as first, >> should be << little-endian, they are interpreted as first, >>

7.2.2 Primitive summary

Table 107 defines the deletable primitives.

Table 107 — Deletable primitives

Primitive	Use ^a	From ^b			To ^b			Primitive sequence type ^c
		I	E	T	I	E	T	
ALIGN (0)	All, SpNeg							Single
ALIGN (1)		I	E	T	I	E	T	
ALIGN (2)	All							
ALIGN (3)								
MUX (LOGICAL LINK 0)	All	I	E	T	I	E	T	Single
MUX (LOGICAL LINK 1)								
NOTIFY (ENABLE SPINUP)	All	I	E				T	Single
NOTIFY (POWER LOSS EXPECTED)		I	E				T	
NOTIFY (RESERVED 1)					I	E	T	
NOTIFY (RESERVED 2)					I	E	T	

^a The Use column indicates when the primitive is used:
a) NoConn: SAS logical links, outside connections;
b) Conn: SAS logical links, inside connections,
c) All: SAS logical links, both outside connections or inside any type of connection;
d) STP: SAS logical links, inside STP connections; or
e) SpNeg: ~~SAS physical links~~, during speed negotiation.

^b The From and To columns indicate the type of ports that originate each primitive or are the intended destinations of each primitive:
a) I for SAS initiator ports;
b) E for expander ports; and
c) T for SAS target ports.
Expander ports are not considered originators of primitives that are passing through from expander port to expander port.

^c The Primitive sequence type columns indicate whether the primitive is ~~sent as~~ a single primitive sequence, a repeated primitive sequence, a continued primitive sequence, a triple primitive sequence, or a redundant primitive sequence (see 7.2.4).

● Author: elx-nayalasangmayajula

Subject: Note

Date: 5/6/2008 4:07:49 PM

 REJECT (no, because they're not sent back-to-back. The sender might only be able to slip them into the data stream every 1/128 dwords or so.)

Section 7.2.5.3.3 states that NOTIFY (POWER LOSS EXPECTED) should be transmitted 3 times, so this should be a triple primitive sequence?

● Author: lsi-bday

Subject: Cross-Out

Date: 5/25/2008 8:21:07 PM

 ACCEPT - DONE (changed to "All: SAS logical links and SATA physical links" and "SAS: SAS logical links, both outside connections or inside any type of connection." Changed ALIGN(0) to "All, SpNeg", ALIGN(1) to "SAS, SpNeg", and remaining "All"s to "SAS". Same in table 108.)

SAS physical links,

SATA also uses ALIGN(0) for speed negotiation.

● Author: RElliott

Subject: Cross-Out

Date: 6/30/2008 6:16:52 PM

 ACCEPT - DONE

sent as

Table 108 defines the primitives **not specific to the type of connection.**

Table 108 — Primitives not specific to type of connection (part 1 of 2)

Primitive	Use ^a	From ^b			To ^b			Primitive sequence type ^c
		I	E	T	I	E	T	
AIP (NORMAL)	NoConn		E					Extended
AIP (RESERVED 0)								
AIP (RESERVED 1)								
AIP (RESERVED 2)					I	E	T	
AIP (RESERVED WAITING ON PARTIAL)								
AIP (WAITING ON CONNECTION)			E					
AIP (WAITING ON DEVICE)			E					
AIP (WAITING ON PARTIAL)			E					
BREAK	All	I	E	T	I	E	T	Redundant
BREAK_REPLY	All	I	E	T	I	E	T	Redundant
BROADCAST (CHANGE)	NoConn	I	E		I			Redundant
BROADCAST (SES)				T	I			
BROADCAST (EXPANDER)			E		I			
BROADCAST (ASYNCHRONOUS EVENT)				T	I			
BROADCAST (RESERVED 3)								
BROADCAST (RESERVED 4)								
BROADCAST (RESERVED CHANGE 0)					I			
BROADCAST (RESERVED CHANGE 1)					I			
CLOSE (CLEAR AFFILIATION)	STP	I					T	Triple
CLOSE (NORMAL)	Conn	I		T				
CLOSE (RESERVED 0)					I		T	
CLOSE (RESERVED 1)								
EOAF	NoConn	I	E	T	I	E	T	Single
ERROR	All		E		I	E	T	Single
HARD_RESET	NoConn	I	E		I	E	T	Redundant
OPEN_ACCEPT	NoConn	I		T	I		T	Single

Page: 289

Author: stx-gouldner

Subject: Highlight

Date: 5/25/2008 8:21:22 PM

TREJECT (5/5 Gerry has no better suggestion)

not specific to the type of connection.

This seems to be an inappropriate title for Table 108. The table includes a "use" column which does specify a particular connection type in which the primitive is used, so they are specific to that type of connection. How about "not specific to SSP, SMP, or STP connection".

Author: stx-gouldner

Subject: Highlight

Date: 5/6/2008 4:07:49 PM

TREJECT (CLOSE is considered outside the connection, not inside it. CLOSE is intercepted by an expander, unlike the primitives inside connections which tend to be just blindly forwarded)

STP

Why isn't this primitive in table 110 (primitives only used inside STP connections)? The description qualifies it for that table.

Author: stx-gouldner

Subject: Highlight

Date: 5/6/2008 4:07:49 PM

TREJECT (CLOSE is considered outside the connection, not inside it. CLOSE is intercepted by an expander, unlike the primitives inside connections which tend to be just blindly forwarded)

Conn

Why isn't this type of primitive in Table 109 (primitives only used within SSP and SMP connections)? The table description qualifies it to be.

Table 108 — Primitives not specific to type of connection (part 2 of 2)

Primitive	Use ^a	From ^b			To ^b			Primitive sequence type ^c
		I	E	T	I	E	T	
OPEN_REJECT (BAD DESTINATION)	NoConn		E					Single
OPEN_REJECT (CONNECTION RATE NOT SUPPORTED)		I	E	T				
OPEN_REJECT (NO DESTINATION)			E					
OPEN_REJECT (PATHWAY BLOCKED)			E					
OPEN_REJECT (PROTOCOL NOT SUPPORTED)		I		T				
OPEN_REJECT (RESERVED ABANDON 1)								
OPEN_REJECT (RESERVED ABANDON 2)					I		T	
OPEN_REJECT (RESERVED ABANDON 3)								
OPEN_REJECT (RESERVED CONTINUE 0)								
OPEN_REJECT (RESERVED CONTINUE 1)								
OPEN_REJECT (RESERVED INITIALIZE 0)								
OPEN_REJECT (RESERVED INITIALIZE 1)								
OPEN_REJECT (RESERVED STOP 0)								
OPEN_REJECT (RESERVED STOP 1)								
OPEN_REJECT (RETRY)		I	E	T				
OPEN_REJECT (STP RESOURCES BUSY)			E	T	I			
OPEN_REJECT (WRONG DESTINATION)		I		T			T	
OPEN_REJECT (ZONE VIOLATION)		E		I				
SOAF	NoConn	I	E	T	I	E	T	Single
TRAIN	SpNeg	I	E	T	I	E	T	Redundant
TRAIN_DONE								

^a The Use column indicates when the primitive is used:
a) NoConn: SAS logical links, outside connections;
b) Conn: SAS logical links, inside connections;
c) All: SAS logical links, both outside connections or inside any type of connection;
d) STP: SAS logical links, inside STP connections; or
e) SpNeg: SAS physical links, during speed negotiation.

^b The From and To columns indicate the type of ports that originate each primitive or are the intended destinations of each primitive:
a) I for SAS initiator ports;
b) E for expander ports; and
c) T for SAS target ports.
Expander ports are not considered originators of primitives that are passing through from expander port to expander port.

^c The Primitive sequence type columns indicate whether the primitive is ~~sent as~~ a single primitive sequence, a repeated primitive sequence, a continued primitive sequence, an extended primitive sequence, a triple primitive sequence, or a redundant primitive sequence (see 7.2.4).

Author: RElliott
Subject: Cross-Out
Date: 6/30/2008 6:16:52 PM
 ACCEPT - DONE

sent as

Table 109 defines the primitives used only inside SSP and SMP connections.

Table 109 — Primitives used only inside SSP and SMP connections

Primitive	Use ^a	From ^b			To ^b			Primitive sequence type ^c
		I	E	T	I	E	T	
ACK	SSP	I		T	I		T	Single
CREDIT_BLOCKED	SSP	I		T	I		T	Single
DONE (ACK/NAK TIMEOUT)	SSP	I		T	I		T	Single
DONE (CREDIT TIMEOUT)		I		T				
DONE (NORMAL)		I		T				
DONE (RESERVED 0)								
DONE (RESERVED 1)								
DONE (RESERVED TIMEOUT 0)								
DONE (RESERVED TIMEOUT 1)								
EOF		SSP, SMP	I					
NAK (CRC ERROR)	SSP	I		T	I		T	Single
NAK (RESERVED 0)								
NAK (RESERVED 1)								
NAK (RESERVED 2)								
RRDY (NORMAL)	SSP	I		T	I		T	Single
RRDY (RESERVED 0)								
RRDY (RESERVED 1)								
SOF	SSP, SMP	I		T	I		T	Single

^a The Use column indicates when the primitive is used:
a) SSP: SAS logical links, inside SSP connections; or
b) SMP: SAS logical links, inside SMP connections.

^b The From and To columns indicate the type of ports that originate each primitive or are the intended destinations of each primitive:
a) I for SSP initiator ports and SMP initiator ports;
b) E for expander ports; and
c) T for SSP target ports and SMP target ports.
Expander ports are not considered originators of primitives that are passing through from expander port to expander port.

^c The Primitive sequence type columns indicate whether the primitive is sent as a single primitive sequence, a repeated primitive sequence, a continued primitive sequence, an extended primitive sequence, a triple primitive sequence, or a redundant primitive sequence (see 7.2.4).

● Author: Isi-bday
Subject: Highlight
Date: 5/6/2008 4:07:49 PM
T ACCEPT - DONE ("being forwarded")

passing
s/b
forwarding dwords

same comment applies in other tables.

● Author: RElliott
Subject: Cross-Out
Date: 6/30/2008 6:16:52 PM
T ACCEPT - DONE

sent as

Table 110 lists the primitives used only inside STP connections and on SATA physical links.

Table 110 — Primitives used only inside STP connections and on SATA physical links

Primitive	Use ^a	From ^b			To ^b			Primitive sequence type ^c
		I	E	T	I	E	T	
SATA_CONT	STP, SATA	I		T	I		T	Single
SATA_DMAT	STP, SATA	I		T	I		T	Single
SATA_EOF	STP, SATA	I		T	I		T	Single
SATA_ERROR ^d	SATA		E				T	Single
SATA_HOLD	STP, SATA	I		T	I		T	Continued
SATA_HOLDA	STP, SATA	I		T	I		T	Continued
SATA_PMACK	STP, SATA							Repeated
SATA_PMNAK	STP, SATA	I	E				T	Repeated
SATA_PMREQ_P	STP, SATA							Continued
SATA_PMREQ_S	STP, SATA							Continued
SATA_R_ERR	STP, SATA	I		T	I		T	Continued
SATA_R_IP	STP, SATA	I		T	I		T	Continued
SATA_R_OK	STP, SATA	I		T	I		T	Continued
SATA_R_RDY	STP, SATA	I		T	I		T	Continued
SATA_SOF	STP, SATA	I		T	I		T	Single
SATA_SYNC	STP, SATA	I		T	I		T	Continued
SATA_WTRM	STP, SATA	I		T	I		T	Continued
SATA_X_RDY	STP, SATA	I		T	I		T	Continued

^a The Use column indicates when the primitive is used:
a) STP: SAS logical links, inside STP connections; or
b) SATA: SATA physical links.

^b The From and To columns indicate the type of ports that originate each primitive or are the intended destinations of each primitive:
a) I for STP initiator ports and SATA host ports;
b) E for expander ports; and
c) T for STP target ports and SATA device ports.
Expander ports are not considered originators of primitives that are passing through from expander port to expander port.

^c The Primitive sequence type columns indicate whether the primitive is ~~sent as~~ a single primitive sequence, a repeated primitive sequence, a continued primitive sequence, an extended primitive sequence, a triple primitive sequence, or a redundant primitive sequence (see 7.2.4).

^d Although included in this table, SATA_ERROR is not a primitive (see 3.1.172) since it starts with K28.6. It does not appear inside STP connections. It is an invalid dword, used by expander devices forwarding an error onto a SATA physical link (see 7.2.8.1).

Author: RElliott
Subject: Cross-Out
Date: 6/30/2008 6:16:52 PM
 ACCEPT - DONE

sent as

7.2.3 Primitive encodings

Table 111 defines the primitive encoding for deletable primitives.

Table 111 — Primitive encoding for deletable primitives

Primitive	Character				Hexadecimal
	1 st	2 nd	3 rd	4 th (last)	
ALIGN (0)	K28.5	D10.2	D10.2	D27.3	BC4A4A7Bh
ALIGN (1)	K28.5	D07.0	D07.0	D07.0	BC070707h
ALIGN (2)	K28.5	D01.3	D01.3	D01.3	BC616161h
ALIGN (3)	K28.5	D27.3	D27.3	D27.3	BC7B7B7Bh
MUX (LOGICAL LINK 0)	K28.5	D02.0	D16.7	D31.4	BC02F09Fh
MUX (LOGICAL LINK 1)	K28.5	D04.7	D31.4	D27.4	BCE49F9Bh
NOTIFY (ENABLE SPINUP)	K28.5	D31.3	D31.3	D31.3	BC7F7F7Fh
NOTIFY (POWER LOSS EXPECTED)	K28.5	D31.3	D07.0	D01.3	BC7F0761h
NOTIFY (RESERVED 1)	K28.5	D31.3	D01.3	D07.0	BC7F6107h
NOTIFY (RESERVED 2)	K28.5	D31.3	D10.2	D10.2	BC7F4A4Ah

This page contains no comments

Table 112 defines the primitive encoding for primitives not specific to type of connection.

Table 112 — Primitive encoding for primitives not specific to type of connection (part 1 of 2)

Primitive	Character				Hexadecimal
	1 st	2 nd	3 rd	4 th (last)	
AIP (NORMAL)	K28.5	D27.4	D27.4	D27.4	BC9B9B9Bh
AIP (RESERVED 0)	K28.5	D27.4	D31.4	D16.7	BC9B9FF0h
AIP (RESERVED 1)	K28.5	D27.4	D16.7	D30.0	BC9BF01Eh
AIP (RESERVED 2)	K28.5	D27.4	D29.7	D01.4	BC9BFD81h
AIP (RESERVED WAITING ON PARTIAL)	K28.5	D27.4	D01.4	D07.3	BC9B8167h
AIP (WAITING ON CONNECTION)	K28.5	D27.4	D07.3	D24.0	BC9B6718h
AIP (WAITING ON DEVICE)	K28.5	D27.4	D30.0	D29.7	BC9B1EFDh
AIP (WAITING ON PARTIAL)	K28.5	D27.4	D24.0	D04.7	BC9B18E4h
BREAK	K28.5	D02.0	D24.0	D07.3	BC021867h
BREAK_REPLY	K28.5	D02.0	D29.7	D16.7	BC02FDF0h
BROADCAST (CHANGE)	K28.5	D04.7	D02.0	D01.4	BCE40281h
BROADCAST (SES)	K28.5	D04.7	D07.3	D29.7	BCE467FDh
BROADCAST (EXPANDER)	K28.5	D04.7	D01.4	D24.0	BCE48118h
BROADCAST (ASYNCHRONOUS EVENT)	K28.5	D04.7	D04.7	D04.7	BCE4E4E4h
BROADCAST (RESERVED 3)	K28.5	D04.7	D16.7	D02.0	BCE4F002h
BROADCAST (RESERVED 4)	K28.5	D04.7	D29.7	D30.0	BCE4FD1Eh
BROADCAST (RESERVED CHANGE 0)	K28.5	D04.7	D24.0	D31.4	BCE4189Fh
BROADCAST (RESERVED CHANGE 1)	K28.5	D04.7	D27.4	D07.3	BCE49B67h
CLOSE (CLEAR AFFILIATION)	K28.5	D02.0	D07.3	D04.7	BC0267E4h
CLOSE (NORMAL)	K28.5	D02.0	D30.0	D27.4	BC021E9Bh
CLOSE (RESERVED 0)	K28.5	D02.0	D31.4	D30.0	BC029F1Eh
CLOSE (RESERVED 1)	K28.5	D02.0	D04.7	D01.4	BC02E481h
EOAF	K28.5	D24.0	D07.3	D31.4	BC18679Fh

This page contains no comments

Table 112 — Primitive encoding for primitives not specific to type of connection (part 2 of 2)

Primitive	Character				Hexadecimal
	1 st	2 nd	3 rd	4 th (last)	
ERROR	K28.5	D02.0	D01.4	D29.7	BC0281FDh
HARD_RESET	K28.5	D02.0	D02.0	D02.0	BC020202h
OPEN_ACCEPT	K28.5	D16.7	D16.7	D16.7	BCF0F0F0h
OPEN_REJECT (BAD DESTINATION)	K28.5	D31.4	D31.4	D31.4	BC9F9F9Fh
OPEN_REJECT (CONNECTION RATE NOT SUPPORTED)	K28.5	D31.4	D04.7	D29.7	BC9FE4FDh
OPEN_REJECT (NO DESTINATION)	K28.5	D29.7	D29.7	D29.7	BCFDFFDFh
OPEN_REJECT (PATHWAY BLOCKED)	K28.5	D29.7	D16.7	D04.7	BCFDFF0E4h
OPEN_REJECT (PROTOCOL NOT SUPPORTED)	K28.5	D31.4	D29.7	D07.3	BC9FFD67h
OPEN_REJECT (RESERVED ABANDON 1)	K28.5	D31.4	D30.0	D16.7	BC9F1EF0h
OPEN_REJECT (RESERVED ABANDON 2)	K28.5	D31.4	D07.3	D02.0	BC9F6702h
OPEN_REJECT (RESERVED ABANDON 3)	K28.5	D31.4	D01.4	D30.0	BC9F811Eh
OPEN_REJECT (RESERVED CONTINUE 0)	K28.5	D29.7	D02.0	D30.0	BCFD021Eh
OPEN_REJECT (RESERVED CONTINUE 1)	K28.5	D29.7	D24.0	D01.4	BCFD1881h
OPEN_REJECT (RESERVED INITIALIZE 0)	K28.5	D29.7	D30.0	D31.4	BCFD1E9Fh
OPEN_REJECT (RESERVED INITIALIZE 1)	K28.5	D29.7	D07.3	D16.7	BCFD67F0h
OPEN_REJECT (RESERVED STOP 0)	K28.5	D29.7	D31.4	D07.3	BCFD9F67h
OPEN_REJECT (RESERVED STOP 1)	K28.5	D29.7	D04.7	D27.4	BCFDE49Bh
OPEN_REJECT (RETRY)	K28.5	D29.7	D27.4	D24.0	BCFD9B18h
OPEN_REJECT (STP RESOURCES BUSY)	K28.5	D31.4	D27.4	D01.4	BC9F9B81h
OPEN_REJECT (WRONG DESTINATION)	K28.5	D31.4	D16.7	D24.0	BC9FF018h
OPEN_REJECT (ZONE VIOLATION)	K28.5	D31.4	D02.0	D27.4	BC9F029Bh
SOAF	K28.5	D24.0	D30.0	D01.4	BC181E81h
TRAIN	K28.5	D30.3	D30.3	D30.3	BC7E7E7Eh
TRAIN_DONE	K28.5	D30.3	D30.3	D10.2	BC7E7E4Ah

This page contains no comments

Table 113 defines the primitive encodings for primitives used only inside SSP and SMP connections.

Table 113 — Primitive encoding for primitives used only inside SSP and SMP connections

Primitive	Character				Hexadecimal
	1 st	2 nd	3 rd	4 th (last)	
ACK	K28.5	D01.4	D01.4	D01.4	BC818181h
CREDIT_BLOCKED	K28.5	D01.4	D07.3	D30.0	BC81671Eh
DONE (ACK/NAK TIMEOUT)	K28.5	D30.0	D01.4	D04.7	BC1E81E4h
DONE (CREDIT TIMEOUT)	K28.5	D30.0	D07.3	D27.4	BC1E679Bh
DONE (NORMAL)	K28.5	D30.0	D30.0	D30.0	BC1E1E1Eh
DONE (RESERVED 0)	K28.5	D30.0	D16.7	D01.4	BC1EF081h
DONE (RESERVED 1)	K28.5	D30.0	D29.7	D31.4	BC1EFD9Fh
DONE (RESERVED TIMEOUT 0)	K28.5	D30.0	D27.4	D29.7	BC1E9BFDh
DONE (RESERVED TIMEOUT 1)	K28.5	D30.0	D31.4	D24.0	BC1E9F18h
EOF	K28.5	D24.0	D16.7	D27.4	BC18F09Bh
NAK (CRC ERROR)	K28.5	D01.4	D27.4	D04.7	BC819BE4h
NAK (RESERVED 0)	K28.5	D01.4	D31.4	D29.7	BC819FFDh
NAK (RESERVED 1)	K28.5	D01.4	D04.7	D24.0	BC81E418h
NAK (RESERVED 2)	K28.5	D01.4	D16.7	D07.3	BC81F067h
RRDY (NORMAL)	K28.5	D01.4	D24.0	D16.7	BC8118F0h
RRDY (RESERVED 0)	K28.5	D01.4	D02.0	D31.4	BC81029Fh
RRDY (RESERVED 1)	K28.5	D01.4	D30.0	D02.0	BC811E02h
SOF	K28.5	D24.0	D04.7	D07.3	BC18E467h

This page contains no comments

Table 114 lists the primitive encodings for primitives used only inside STP connections and on SATA physical links.

Table 114 — Primitive encoding for primitives used only inside STP connections and on SATA physical links

Primitive	Character				Hexadecimal
	1 st	2 nd	3 rd	4 th (last)	
SATA_CONT	K28.3	D10.5	D25.4	D25.4	7CAA9999h
SATA_DMAT	K28.3	D21.5	D22.1	D22.1	7CB53636h
SATA_EOF	K28.3	D21.5	D21.6	D21.6	7CB5D5D5h
SATA_ERROR ^{a b}	K28.6	D02.0	D01.4	D29.7	DC0281FDh
SATA_HOLD	K28.3	D10.5	D21.6	D21.6	7CAAD5D5h
SATA_HOLDA	K28.3	D10.5	D21.4	D21.4	7CAA9595h
SATA_PMACK	K28.3	D21.4	D21.4	D21.4	7C959595h
SATA_PMNAK	K28.3	D21.4	D21.7	D21.7	7C95F5F5h
SATA_PMREQ_P	K28.3	D21.5	D23.0	D23.0	7CB51717h
SATA_PMREQ_S	K28.3	D21.4	D21.3	D21.3	7C957575h
SATA_R_ERR	K28.3	D21.5	D22.2	D22.2	7CB55656h
SATA_R_IP	K28.3	D21.5	D21.2	D21.2	7CB55555h
SATA_R_OK	K28.3	D21.5	D21.1	D21.1	7CB53535h
SATA_R_RDY	K28.3	D21.4	D10.2	D10.2	7C954A4Ah
SATA_SOF	K28.3	D21.5	D23.1	D23.1	7CB53737h
SATA_SYNC	K28.3	D21.4	D21.5	D21.5	7C95B5B5h
SATA_WTRM	K28.3	D21.5	D24.2	D24.2	7CB55858h
SATA_X_RDY	K28.3	D21.5	D23.2	D23.2	7CB55757h
^a Except for SATA_ERROR, all values are defined by SATA (see SATA-2). ^b Although included in this table, SATA_ERROR is not a primitive (see 3.1.172) since it starts with K28.6. It does not appear inside STP connections. It is an invalid dword, used by expander devices forwarding an error onto a SATA physical link (see 7.2.8.1).					

This page contains no comments

7.2.4 Primitive sequences

7.2.4.1 Primitive sequences overview

Table 115 summarizes the types of primitive sequences.

Table 115 — Primitive sequences

Primitive sequence type	Number of times the transmitter transmits the primitive to transmit the primitive sequence	Number of times the receiver receives the primitive to detect the primitive sequence	Reference
Single	1	1	7.2.4.2
Repeated	1 or more	1	7.2.4.3
Continued	2 followed by SATA_CONT	1	7.2.4.4
Extended	3	1	7.2.4.5
Triple	3	3	7.2.4.6
Redundant	6	3	7.2.4.7

Any number of deletable primitives may be sent inside primitive sequences without affecting the count or breaking the consecutiveness requirements. Rate matching deletable primitives shall be sent inside primitive sequences inside of connections if rate matching is enabled (see 7.13).

7.2.4.2 Single primitive sequence

Primitives labeled as single primitive sequences (e.g., RRDY, SATA_SOF) shall be transmitted one time to form a single primitive sequence.

Receivers count each primitive received that is labeled as a single primitive sequence as a distinct single primitive sequence.

ALIGNs, NOTIFYs, and MUXs are deletable primitives (see 7.2.5 and 7.3).

7.2.4.3 Repeated primitive sequence

Primitives that form repeated primitive sequences (e.g., SATA_PMACK) shall be transmitted one or more times. Only STP primitives form repeated primitive sequences. Any number of deletable primitives may be sent inside repeated primitive sequences as described in 7.2.4.1.

Figure 163 shows an example of transmitting a repeated primitive sequence.

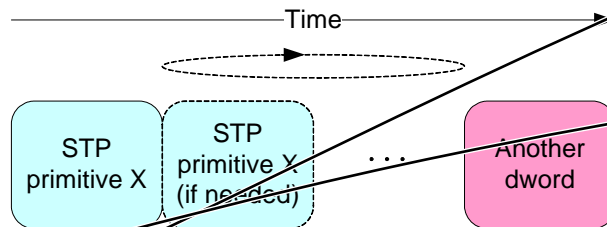

NOTE: Another dword is a dword other than a deletable primitive or STP primitive X

Figure 163 — Transmitting a repeated primitive sequence

Receivers do not count the number of times a repeated primitive is received (i.e., receivers are simply in the state of receiving the primitive). An expander device forwarding a repeated primitive sequence may transmit more repeated primitives than it receives (i.e., expand) or transmit fewer repeated primitives than it receives (i.e, contract).

Page: 298

● Author: RElliott
Subject: Note
Date: 6/30/2008 6:16:52 PM
 ACCEPT - DONE

Convert the long column headers into footnotes. Change the columns to simply Transmit and Receive.

● Author: RElliott
Subject: Highlight
Date: 6/30/2008 6:16:52 PM
 ACCEPT - DONE

sent
s/b
transmitted

● Author: RElliott
Subject: Highlight
Date: 6/30/2008 6:16:52 PM
 ACCEPT - DONE

sent
s/b
transmitted

● Author: RElliott
Subject: Highlight
Date: 6/30/2008 6:16:52 PM
 ACCEPT - DONE

sent
s/b
transmitted

● Author: RElliott
Subject: Highlight
Date: 8/27/2008 5:32:43 PM
 ACCEPT - DONE

NOTE
s/b
Note

● Author: RElliott
Subject: Note
Date: 9/3/2008 4:36:44 PM
 ACCEPT - DONE

Add: While transmitting a repeated primitive sequence, the expander device is considered to be originating (see 7.3.2) rather than forwarding (see 7.3.3) for purposes of deletable primitive insertion.

(from discussions with Jeff Gauvin, LSI. Same as continued primitive sequence comment.)

● Author: wdc-mevans
Subject: Cross-Out
Date: 5/25/2008 8:22:55 PM
 REJECT (deleting it changes the meaning. The point is that receivers don't receive primitive-by-primitive like in SAS; they enter a state where they're continuously receiving a primitive.)

Comments from page 298 continued on next page

7.2.4 Primitive sequences

7.2.4.1 Primitive sequences overview

Table 115 summarizes the types of primitive sequences.

Table 115 — Primitive sequences

Primitive sequence type	Number of times the transmitter transmits the primitive to transmit the primitive sequence	Number of times the receiver receives the primitive to detect the primitive sequence	Reference
Single	1	1	7.2.4.2
Repeated	1 or more	1	7.2.4.3
Continued	2 followed by SATA_CONT	1	7.2.4.4
Extended	3	1	7.2.4.5
Triple	3	3	7.2.4.6
Redundant	6	3	7.2.4.7

Any number of deletable primitives may be sent inside primitive sequences without affecting the count or breaking the consecutiveness requirements. Rate matching deletable primitives shall be sent inside primitive sequences inside of connections if rate matching is enabled (see 7.13).

7.2.4.2 Single primitive sequence

Primitives labeled as single primitive sequences (e.g., RRDY, SATA_SOF) shall be transmitted one time to form a single primitive sequence.

Receivers count each primitive received that is labeled as a single primitive sequence as a distinct single primitive sequence.

ALIGNs, NOTIFYs, and MUXs are deletable primitives (see 7.2.5 and 7.3).

7.2.4.3 Repeated primitive sequence

Primitives that form repeated primitive sequences (e.g., SATA_PMACK) shall be transmitted one or more times. Only STP primitives form repeated primitive sequences. Any number of deletable primitives may be sent inside repeated primitive sequences as described in 7.2.4.1.

Figure 163 shows an example of transmitting a repeated primitive sequence.

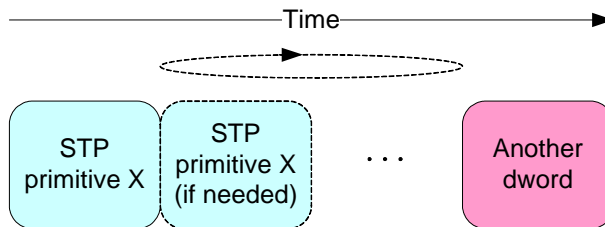

NOTE: Another dword is a dword other than a deletable primitive or STP primitive X

Figure 163 — Transmitting a repeated primitive sequence

Receivers do not count the number of times a repeated primitive is received (i.e., receivers are simply in the state of receiving the primitive). An expander device forwarding a repeated primitive sequence may transmit more repeated primitives than it receives (i.e., expand) or transmit fewer repeated primitives than it receives (i.e, contract).

simply
[Delete the unnecessary word.]

● Author: RElliott
Subject: Highlight
Date: 8/27/2008 5:32:54 PM
T ACCEPT - DONE

NOTE:
s/b
Note

● Author: RElliott
Subject: Highlight
Date: 6/30/2008 6:16:52 PM
T ACCEPT - DONE

sent
s/b
transmitted

● Author: RElliott
Subject: Highlight
Date: 6/30/2008 6:16:52 PM
T ACCEPT - DONE

sent
s/b
transmitted

● Author: RElliott
Subject: Highlight
Date: 6/30/2008 6:16:52 PM
T ACCEPT - DONE

sent
s/b
transmitted

● Author: RElliott
Subject: Highlight
Date: 6/30/2008 6:16:52 PM
T ACCEPT - DONE

sent
s/b
transmitted

Receivers shall detect a triple primitive sequence after the identical primitive is received in three consecutive **dwords**. After detecting a triple primitive sequence, a receiver shall not detect a second instance of the same triple primitive sequence until it has received three consecutive dwords that are not any of the following:

- a) the original primitive; or
- b) a deletable primitive.

Figure 166 shows examples of triple primitive sequences.

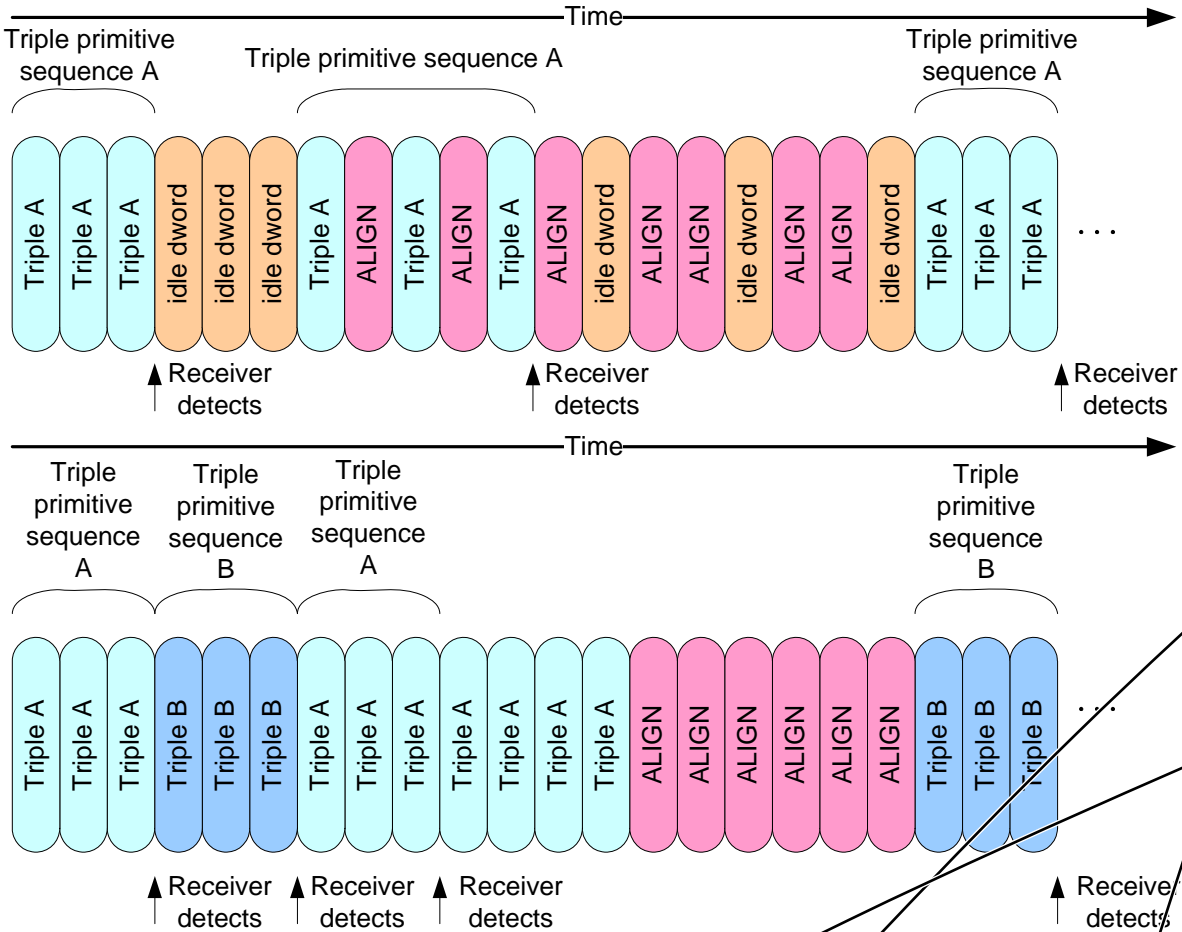

Figure 166 — Triple primitive sequences

7.2.4.7 Redundant primitive sequence

Primitives that form redundant primitive sequences (e.g., BROADCAST (CHANGE)) shall be **sent** six times consecutively. Any number of deletable primitives may be **sent** inside redundant primitive sequences as described in 7.2.4.1.

A receiver shall detect a redundant primitive sequence after the identical primitive is received in any three of six consecutive **dwords**. After detecting a redundant primitive sequence, a receiver shall not detect a second instance of the same redundant primitive sequence until it has received six consecutive dwords that are not any of the following:

- a) the original primitive; or
- b) a deletable primitive.

Page: 300

● Author: wdc-mevans

Subject: Highlight

Date: 5/6/2008 4:07:49 PM

T REJECT (that was just stated in the previous sentence; we can't keep restating it everywhere, or it will be unreadable)

dwords.

s/b

dwords after deletable primitives are deleted.

● Author: RElliott

Subject: Highlight

Date: 6/30/2008 6:16:52 PM

T ACCEPT - DONE

sent

s/b

transmitted

● Author: RElliott

Subject: Highlight

Date: 6/30/2008 6:16:52 PM

T ACCEPT - DONE

sent

s/b

transmitted

● Author: wdc-mevans

Subject: Highlight

Date: 5/6/2008 4:07:49 PM

T REJECT (that was just stated in the previous sentence; we can't keep restating it everywhere, or it will be unreadable)

dwords.

s/b

dwords after deletable primitives are deleted.

Figure 167 shows examples of redundant primitive sequences.

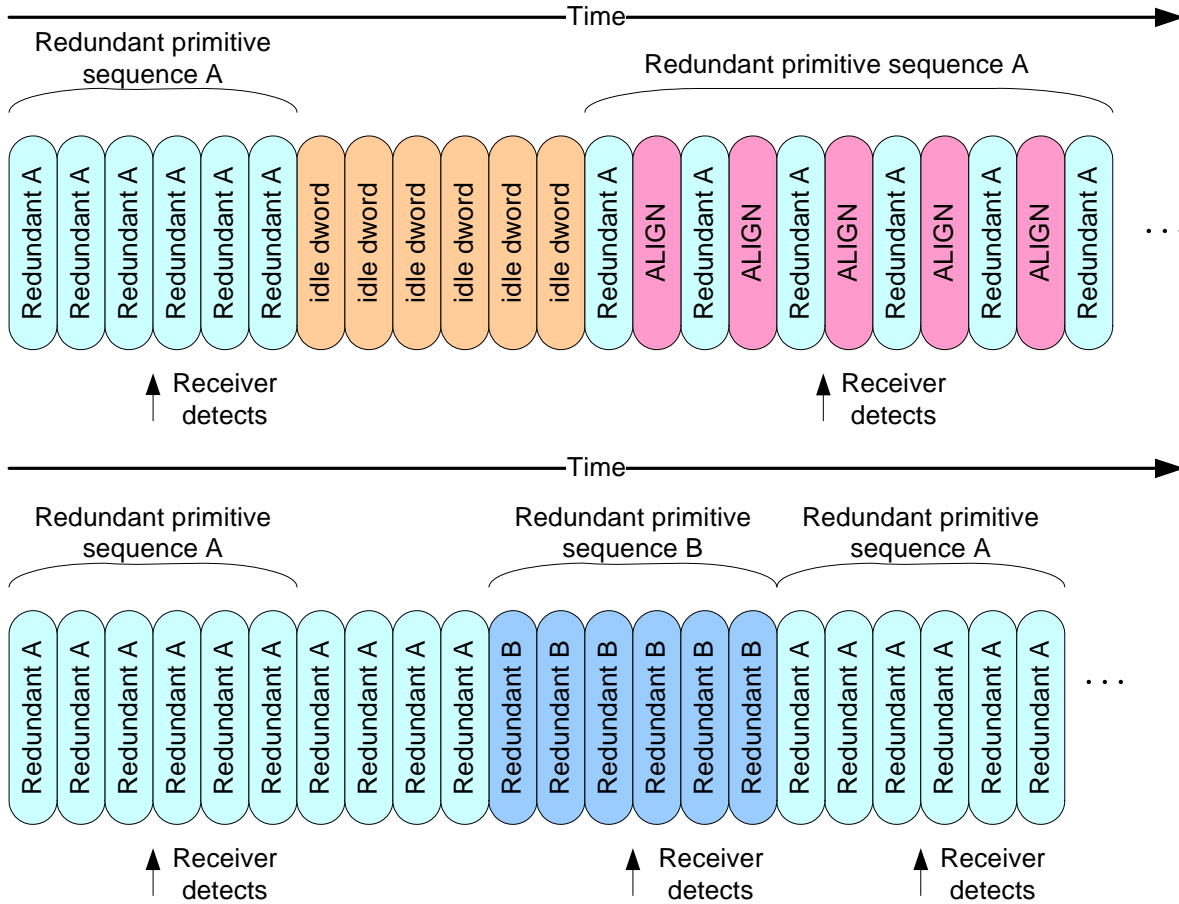

Figure 167 — Redundant primitive sequences

7.2.5 Deletable primitives

7.2.5.1 ALIGN

ALIGNs are used for:

- a) OOB signals (see 6.6);
- b) character and dword alignment during the speed negotiation sequence (see 6.7.4.2);
- c) physical link rate tolerance management after the phy reset sequence (see 7.3); and
- d) rate matching during connections (see 7.13).

ALIGNs are deletable primitives (see 7.3).

This page contains no comments

Table 116 defines the different versions of ALIGN primitives.

Table 116 — ALIGN primitives

Primitive	Description
ALIGN (0)	Used for OOB signals, the speed negotiation sequence, physical link rate tolerance management, and rate matching.
ALIGN (1)	Used for the speed negotiation sequence, physical link rate tolerance management, and rate matching.
ALIGN (2)	Used for physical link rate tolerance management and rate matching.
ALIGN (3)	

Phys may use ALIGN (0) to construct OOB signals as described in 6.6. Phys use ALIGN (0) and ALIGN (1) during the speed negotiation sequence as described in 6.7.4.2. Phys shall rotate through ALIGN (0), ALIGN (1), ALIGN (2), and ALIGN (3) for all ALIGNs sent after the phy reset sequence.

Phys receiving ALIGNs after the phy reset sequence shall not verify the rotation and shall accept any of the ALIGNs at any time.

Phys shall only detect an ALIGN after decoding all four characters in the primitive.

~~NOTE 45 — SATA devices are allowed to decode every dword starting with a K28.5 as an ALIGN, since ALIGN is the only primitive defined starting with K28.5.~~

For physical link rate tolerance management and rate matching, ALIGNs may be replaced by NOTIFYs (see 7.2.5.3) or MUXs (see 7.2.5.2). ALIGNs shall not be replaced by NOTIFYs or MUXs during OOB signals or speed negotiation.

7.2.5.2 MUX (Multiplex)

MUX is used if multiplexing (see 6.10) is enabled (see table 100 in 6.7.4.2.3.3) as follows:

- a) transmitted during the multiplexing sequence (see 6.7.4.3); and
- b) substituted for an ALIGN (see 7.2.5.1) being transmitted for physical link rate tolerance management (see 7.3) or rate matching (see 7.13) to confirm the logical link number.

Substitution of a MUX for an ALIGN may or may not affect the ALIGN rotation (i.e., the MUX may take the place of one of the ALIGNs in the rotation through ALIGN (0), ALIGN (1), ALIGN (2), and ALIGN (3), or it may delay the rotation).

MUXs are deletable primitives (see 7.3). A phy supporting multiplexing shall process MUX primitives in logic running off the received clock without using an elasticity buffer rather than logic after the elasticity buffer, because they are not accompanied by additional deletable primitives (e.g., ALIGNs and/or NOTIFYs).

The versions of MUX are defined in table 117.

Table 117 — MUX primitives

Primitive	Description
MUX (LOGICAL LINK 0)	Establishes the position of dwords in logical link 0.
MUX (LOGICAL LINK 1)	Establishes the position of dwords in logical link 1.

See 6.10 for details on multiplexing.

Author: RElliott
Subject: Highlight
Date: 6/30/2008 6:16:52 PM
 ACCEPT - DONE
sent
s/b
transmitted

Author: RElliott
Subject: Note
Date: 6/30/2008 6:16:52 PM
 ACCEPT - DONE (added NOTE:
"ALIGN rotation is performed on a physical phy basis and is used to reduce radiated emissions."
)

clarify that rotation is on a physical phy basis, not a logical phy basis.

Author: Isi-bday
Subject: Cross-Out
Date: 5/6/2008 4:07:49 PM
 REJECT (the SAS rule in the previous sentence is shall decode all four. This NOTE is highlighting that the rule differs from SATA, which allows for other behavior. If SATA ever prohibits it and becomes the same as SAS, then it'd be appropriate to remove the NOTE)

NOTE 45 - SATA devices are allowed to decode every dword starting with a K28.5 as an ALIGN, since ALIGN is the only primitive defined starting with K28.5.

This is specifically discouraged in SATA 2.6, and so SAS should not encourage it.

Author: RElliott
Subject: Highlight
Date: 6/30/2008 6:16:52 PM
 ACCEPT - DONE

for
s/b
in place of

Author: Isi-bday
Subject: Highlight
Date: 6/20/2008 8:04:44 PM
 ACCEPT - DONE (5/5 "substituted... as defined in 6.10")

substituted
suggest
periodically substituted (see 6.10)

Author: wdc-mevans
Subject: Highlight
Date: 5/30/2008 5:31:07 PM
 REJECT (delete the "it" instead)

it
s/b
transmission of a MUX

Author: wdc-mevans

Table 116 defines the different versions of ALIGN primitives.

Table 116 — ALIGN primitives

Primitive	Description
ALIGN (0)	Used for OOB signals, the speed negotiation sequence, physical link rate tolerance management, and rate matching.
ALIGN (1)	Used for the speed negotiation sequence, physical link rate tolerance management, and rate matching.
ALIGN (2)	Used for physical link rate tolerance management and rate matching.
ALIGN (3)	

Phys may use ALIGN (0) to construct OOB signals as described in 6.6. Phys use ALIGN (0) and ALIGN (1) during the speed negotiation sequence as described in 6.7.4.2. Phys shall rotate through ALIGN (0), ALIGN (1), ALIGN (2), and ALIGN (3) for all ALIGNs sent after the phy reset sequence.

Phys receiving ALIGNs after the phy reset sequence shall not verify the rotation and shall accept any of the ALIGNs at any time.

Phys shall only detect an ALIGN after decoding all four characters in the primitive.

~~NOTE 45 — SATA devices are allowed to decode every dword starting with a K28.5 as an ALIGN, since ALIGN is the only primitive defined starting with K28.5.~~

For physical link rate tolerance management and rate matching, ALIGNs may be replaced by NOTIFYs (see 7.2.5.3) or MUXs (see 7.2.5.2). ALIGNs shall not be replaced by NOTIFYs or MUXs during OOB signals or speed negotiation.

7.2.5.2 MUX (Multiplex)

MUX is used if multiplexing (see 6.10) is enabled (see table 100 in 6.7.4.2.3.3) as follows:

- a) transmitted during the multiplexing sequence (see 6.7.4.3); and
- b) substituted for an ALIGN (see 7.2.5.1) being transmitted for physical link rate tolerance management (see 7.3) or rate matching (see 7.13) to confirm the logical link number.

Substitution of a MUX for an ALIGN may or may not affect the ALIGN rotation (i.e., the MUX may take the place of one of the ALIGNs in the rotation through ALIGN (0), ALIGN (1), ALIGN (2), and ALIGN (3), or it may delay the rotation).

MUXs are deletable primitives (see 7.3). A phy supporting multiplexing shall process MUX primitives in logic running off the received clock without using an elasticity buffer rather than logic after the elasticity buffer, because they are not accompanied by additional deletable primitives (e.g., ALIGNs and/or NOTIFYs).

The versions of MUX are defined in table 117.

Table 117 — MUX primitives

Primitive	Description
MUX (LOGICAL LINK 0)	Establishes the position of dwords in logical link 0.
MUX (LOGICAL LINK 1)	Establishes the position of dwords in logical link 1.

See 6.10 for details on multiplexing.

Subject: Highlight
Date: 5/6/2008 4:07:49 PM

TREJECT

they
s/b
the MUXs

7.2.5.3 NOTIFY

7.2.5.3.1 NOTIFY overview

NOTIFY may be transmitted in place of any ALIGN (see 7.2.5.1) being transmitted for physical link rate tolerance management (see 7.3) and rate matching (see 7.13). Substitution of a NOTIFY for an ALIGN may or may not affect the ALIGN rotation (i.e., the NOTIFY may take the place of one of the ALIGNs in the rotation through ALIGN (0), ALIGN (1), ALIGN (2), and ALIGN (3), or it may delay the rotation). A specific NOTIFY shall not be transmitted in more than three consecutive dwords until at least three other dwords have been transmitted.

NOTIFYs are deletable primitives (see 7.3). If a phy supports a specific NOTIFY primitive, it should decode it in logic running off the received clock without using an elasticity buffer rather than logic after the elasticity buffer to avoid missing detection of important information.

NOTIFY shall not be forwarded through expander devices. Expander devices shall substitute an ALIGN for a NOTIFY if necessary.

SAS target devices are not required to detect every transmitted NOTIFY.

The versions of NOTIFY representing different reasons are defined in table 118.

Table 118 — NOTIFY primitives

Primitive	Description	Reference
NOTIFY (ENABLE SPINUP)	Specify to a SAS target device that it may temporarily consume additional power while transitioning into the active or idle power condition state.	7.2.5.3.2
NOTIFY (POWER LOSS EXPECTED)	Specify to a SAS target device that power loss may occur within the time specified by the POWER LOSS TIMEOUT field in the Shared Port Control mode page (see 10.2.7.6).	7.2.5.3.3
NOTIFY (RESERVED 1)	Reserved.	
NOTIFY (RESERVED 2)		

NOTIFY (RESERVED 1) and NOTIFY (RESERVED 2) shall be ignored by all devices.

7.2.5.3.2 NOTIFY (ENABLE SPINUP)

NOTIFY (ENABLE SPINUP) is transmitted by a SAS initiator port or expander port and is used to specify to an SAS target device that it may temporarily consume additional power (e.g., while spinning-up rotating media) while transitioning into the active or idle power condition state. The length of time the SAS target device consumes additional power and the amount of additional power is vendor specific. NOTIFY (ENABLE SPINUP) shall interact with the device's power condition state transitions, controlled by the Power Conditions mode page (see SPC-4) and/or the START STOP UNIT command (see SBC-3), as described in 10.2.10.

SAS initiator devices and expander devices shall use NOTIFY (ENABLE SPINUP) while attached to SSP target devices (i.e., devices that report SSP target port support in their IDENTIFY address frames). They shall transmit one NOTIFY (ENABLE SPINUP) after power on when the enclosure is ready for initial spin-up. After the initial NOTIFY (ENABLE SPINUP), they shall transmit NOTIFY (ENABLE SPINUP) periodically. Otherwise, the selection of when and how often to transmit NOTIFY (ENABLE SPINUP) is outside the scope of this standard.

NOTE 46 - The SAS initiator device or expander device uses NOTIFY (ENABLE SPINUP) to avoid exceeding enclosure power supply capabilities during spin-up of multiple SAS target devices. It may choose to rotate transmitting NOTIFY (ENABLE SPINUP) across all of its ports, distributing it to N ports at a time if the enclosure power supply is capable of powering N SAS target devices spinning up at a time. An expander

● Author: RElliott
Subject: Highlight
Date: 6/30/2008 6:16:52 PM
T ACCEPT - DONE

transmitted
s/b
substituted

● Author: RElliott
Subject: Highlight
Date: 6/30/2008 6:16:52 PM
T ACCEPT - DONE

for
s/b
in place of

● Author: RElliott
Subject: Highlight
Date: 6/30/2008 6:16:52 PM
T ACCEPT - DONE

and
s/b
or

● Author: wdc-mevans
Subject: Highlight
Date: 5/30/2008 5:30:49 PM
T REJECT (delete the "it" instead)

it
s/b
transmission of a NOTIFY

● Author: lsi-bday
Subject: Highlight
Date: 5/25/2008 8:23:54 PM

T REJECT (this is for EMI reduction. If there are lots of back-to-back ALIGNs (e.g., while rate matching 6 Gbps down to 1.5 Gbps), we don't want more than 3 in a row with the exact same pattern. Although redundant primitives are allowed 6-in-a-row, that should be rare; ALIGN substitution could happen more often depending on what meaning is given to future NOTIFYs.)

A specific NOTIFY
shall not be transmitted in more than three consecutive dwords until at least three other dwords have been transmitted.

Why is this a requirement? Suggest deleting it. A little bit in conflict with the POWER LOSS EXPECTED description that says "at least 3 times"

● Author: wdc-mevans
Subject: Highlight
Date: 5/6/2008 4:07:49 PM
T ACCEPT - DONE (that NOTIFY)

it
s/b
the NOTIFY

● Author: wdc-mevans
Subject: Highlight

7.2.5.3 NOTIFY

7.2.5.3.1 NOTIFY overview

NOTIFY may be transmitted in place of any ALIGN (see 7.2.5.1) being transmitted for physical link rate tolerance management (see 7.3) and rate matching (see 7.13). Substitution of a NOTIFY for an ALIGN may or may not affect the ALIGN rotation (i.e., the NOTIFY may take the place of one of the ALIGNs in the rotation through ALIGN (0), ALIGN (1), ALIGN (2), and ALIGN (3), or it may delay the rotation). A specific NOTIFY shall not be transmitted in more than three consecutive dwords until at least three other dwords have been transmitted.

NOTIFYs are deletable primitives (see 7.3). If a phy supports a specific NOTIFY primitive, it should decode it in logic running off the received clock without using an elasticity buffer rather than logic after the elasticity buffer to avoid missing detection of important information.

NOTIFY shall not be forwarded through expander devices. Expander devices shall substitute an ALIGN for a NOTIFY if necessary.

SAS target devices are not required to detect every transmitted NOTIFY.

The versions of NOTIFY representing different reasons are defined in table 118.

Table 118 — NOTIFY primitives

Primitive	Description	Reference
NOTIFY (ENABLE SPINUP)	Specify to a SAS target device that it may temporarily consume additional power while transitioning into the active or idle power condition state.	7.2.5.3.2
NOTIFY (POWER LOSS EXPECTED)	Specify to a SAS target device that power loss may occur within the time specified by the POWER LOSS TIMEOUT field in the Shared Port Control mode page (see 10.2.7.6).	7.2.5.3.3
NOTIFY (RESERVED 1)	Reserved.	
NOTIFY (RESERVED 2)		

NOTIFY (RESERVED 1) and NOTIFY (RESERVED 2) shall be ignored by all devices.

7.2.5.3.2 NOTIFY (ENABLE SPINUP)

NOTIFY (ENABLE SPINUP) is transmitted by a SAS initiator port or expander port and is used to specify to an SAS target device that it may temporarily consume additional power (e.g., while spinning-up rotating media) while transitioning into the active or idle power condition state. The length of time the SAS target device consumes additional power and the amount of additional power is vendor specific. NOTIFY (ENABLE SPINUP) shall interact with the device's power condition state transitions, controlled by the Power Conditions mode page (see SPC-4) and/or the START STOP UNIT command (see SBC-3), as described in 10.2.10.

SAS initiator devices and expander devices shall use NOTIFY (ENABLE SPINUP) while attached to SSP target devices (i.e., devices that report SSP target port support in their IDENTIFY address frames). They shall transmit one NOTIFY (ENABLE SPINUP) after power on when the enclosure is ready for initial spin-up. After the initial NOTIFY (ENABLE SPINUP), they shall transmit NOTIFY (ENABLE SPINUP) periodically. Otherwise, the selection of when and how often to transmit NOTIFY (ENABLE SPINUP) is outside the scope of this standard.

NOTE 46 - The SAS initiator device or expander device uses NOTIFY (ENABLE SPINUP) to avoid exceeding enclosure power supply capabilities during spin-up of multiple SAS target devices. It may choose to rotate transmitting NOTIFY (ENABLE SPINUP) across all of its ports, distributing it to N ports at a time if the enclosure power supply is capable of powering N SAS target devices spinning up at a time. An expander

Date: 5/6/2008 4:07:49 PM

T ACCEPT - DONE

it
s/b
then the phy

Author: wdc-mevans
Subject: Highlight
Date: 5/6/2008 4:07:49 PM

T ACCEPT - DONE

into
s/b
to

Author: wdc-mevans
Subject: Highlight
Date: 5/6/2008 4:07:49 PM

T ACCEPT - DONE

an SAS
s/b
a SAS
[it is interesting to me that this is the only remnant occurrence of this]

Author: wdc-mevans
Subject: Highlight
Date: 5/21/2008 8:12:03 PM

T ACCEPT - DONE (changed to "to spin up" to match phrasing used elsewhere)

spinning-up
s/b
spinning up

Author: RElliott
Subject: Highlight
Date: 6/30/2008 6:16:52 PM

T ACCEPT - DONE

transitioning into
s/b
transitioning to

"transition into" is only used for "into this state". "transition to" is used for all other cases. Corresponds to a comment on table 118 above.

Author: wdc-mevans
Subject: Highlight
Date: 5/21/2008 8:12:45 PM

T REJECT (two things anded/ored together don't get a comma)

SPC-4) and/or
s/b
SPC-4), and/or

Author: wdc-mevans
Subject: Highlight
Date: 5/6/2008 4:07:49 PM

T REJECT (too wordy)

They shall transmit one NOTIFY (ENABLE SPINUP) after power on when the enclosure is ready for initial spin-up. After the initial NOTIFY (ENABLE SPINUP), they shall transmit NOTIFY (ENABLE SPINUP) periodically.

s/b
SAS initiator devices or expander devices shall transmit one NOTIFY (ENABLE SPINUP) after power on when the enclosure is

Comments from page 303 continued on next page

7.2.5.3 NOTIFY

7.2.5.3.1 NOTIFY overview

NOTIFY may be transmitted in place of any ALIGN (see 7.2.5.1) being transmitted for physical link rate tolerance management (see 7.3) and rate matching (see 7.13). Substitution of a NOTIFY for an ALIGN may or may not affect the ALIGN rotation (i.e., the NOTIFY may take the place of one of the ALIGNs in the rotation through ALIGN (0), ALIGN (1), ALIGN (2), and ALIGN (3), or it may delay the rotation). A specific NOTIFY shall not be transmitted in more than three consecutive dwords until at least three other dwords have been transmitted.

NOTIFYs are deletable primitives (see 7.3). If a phy supports a specific NOTIFY primitive, it should decode it in logic running off the received clock without using an elasticity buffer rather than logic after the elasticity buffer to avoid missing detection of important information.

NOTIFY shall not be forwarded through expander devices. Expander devices shall substitute an ALIGN for a NOTIFY if necessary.

SAS target devices are not required to detect every transmitted NOTIFY.

The versions of NOTIFY representing different reasons are defined in table 118.

Table 118 — NOTIFY primitives

Primitive	Description	Reference
NOTIFY (ENABLE SPINUP)	Specify to a SAS target device that it may temporarily consume additional power while transitioning into the active or idle power condition state.	7.2.5.3.2
NOTIFY (POWER LOSS EXPECTED)	Specify to a SAS target device that power loss may occur within the time specified by the POWER LOSS TIMEOUT field in the Shared Port Control mode page (see 10.2.7.6).	7.2.5.3.3
NOTIFY (RESERVED 1)	Reserved.	
NOTIFY (RESERVED 2)		

NOTIFY (RESERVED 1) and NOTIFY (RESERVED 2) shall be ignored by all devices.

7.2.5.3.2 NOTIFY (ENABLE SPINUP)

NOTIFY (ENABLE SPINUP) is transmitted by a SAS initiator port or expander port and is used to specify to an SAS target device that it may temporarily consume additional power (e.g., while spinning-up rotating media) while transitioning into the active or idle power condition state. The length of time the SAS target device consumes additional power and the amount of additional power is vendor specific. NOTIFY (ENABLE SPINUP) shall interact with the device's power condition state transitions, controlled by the Power Conditions mode page (see SPC-4) and/or the START STOP UNIT command (see SBC-3), as described in 10.2.10.

SAS initiator devices and expander devices shall use NOTIFY (ENABLE SPINUP) while attached to SSP target devices (i.e., devices that report SSP target port support in their IDENTIFY address frames). They shall transmit one NOTIFY (ENABLE SPINUP) after power on when the enclosure is ready for initial spin-up. After the initial NOTIFY (ENABLE SPINUP), they shall transmit NOTIFY (ENABLE SPINUP) periodically. Otherwise, the selection of when and how often to transmit NOTIFY (ENABLE SPINUP) is outside the scope of this standard.

NOTE 46 - The SAS initiator device or expander device uses NOTIFY (ENABLE SPINUP) to avoid exceeding enclosure power supply capabilities during spin-up of multiple SAS target devices. It may choose to rotate transmitting NOTIFY (ENABLE SPINUP) across all of its ports, distributing it to N ports at a time if the enclosure power supply is capable of powering N SAS target devices spinning up at a time. An expander

ready for an SSP target device to consume additional power. After transmitting the initial NOTIFY (ENABLE SPINUP), SAS initiator devices and expander devices shall transmit NOTIFY (ENABLE SPINUP) periodically (e.g., once every several milliseconds).

● Author: RElliott
Subject: Note
Date: 6/30/2008 6:16:52 PM

 ACCEPT - DONE

spin up
s/b
temporary consumption of additional power

● Author: RElliott
Subject: Highlight
Date: 6/30/2008 6:16:52 PM

 ACCEPT - DONE

spin-up of
s/b
temporary consumption of additional power by

● Author: RElliott
Subject: Highlight
Date: 6/30/2008 6:16:52 PM

 ACCEPT - DONE

spinning up at a time
s/b
temporarily consuming additional power at the same time

device may allow this timing to be configured by an NVRAM programmed with enclosure-specific sequencing patterns, or may employ more complex, dynamic interaction with the enclosure power supply.

NOTE 47 - NOTIFY (ENABLE SPINUP) should be transmitted as frequently as possible to avoid incurring application layer timeouts.

I_T nexus loss, logical unit reset, and hard reset shall not cause a SAS target device to spin-up automatically on receipt of NOTIFY (ENABLE SPINUP).

A SAS target device with multiple SAS target ports shall honor NOTIFY (ENABLE SPINUP) from all its SAS target ports equivalently (e.g., if a SAS target device contains two SSP target ports A and B, powers on in the Stopped state, and receives a START STOP UNIT command with the START bit set to one through SSP target port A, then a NOTIFY (ENABLE SPINUP) received on SSP target port B causes the SAS target device to spin up its rotating media (see 10.2.10)).

7.2.5.3.3 NOTIFY (POWER LOSS EXPECTED)

NOTIFY (POWER LOSS EXPECTED) is transmitted by a SAS initiator port or expander port and is used to specify to a SAS target device that power loss may occur within the time specified in the POWER LOSS TIMEOUT field in the Shared Port Control mode page (see 10.2.7.6).

NOTIFY (POWER LOSS EXPECTED) shall be transmitted at least three times by the SAS initiator port or expander port.

If a SAS target device supports NOTIFY (POWER LOSS EXPECTED) and receives NOTIFY (POWER LOSS EXPECTED) on an SSP target port, then the device server for each logical unit to which the SSP target port has access shall:

- 1) stop writing data to the media on a block boundary (e.g., all write activity shall continue until a block boundary is reached then all writing shall stop);
- 2) clear all task sets as defined in SAM-4; and
- 3) establish a unit attention condition for the initiator port associated with every I_T nexus as defined in SAM-4 (e.g., with the additional sense code set to COMMANDS CLEARED BY POWER LOSS NOTIFICATION).

If a SAS target device supports NOTIFY (POWER LOSS EXPECTED) and receives NOTIFY (POWER LOSS EXPECTED) on an SSP target port, then the SAS target device shall:

- a) on each phy that receives NOTIFY (POWER LOSS EXPECTED), if there is an SSP connection, then transmit a BREAK on that connection; and
- b) on each phy that does not receive NOTIFY (POWER LOSS EXPECTED), if there is an SSP connection, then transmit a BREAK or a CLOSE on that connection.

The SCSI application layer that receives a Power Loss Expected event shall:

- a) start the power loss timer;
- b) send an Accept_Reject OPENs (Reject SSP) request to all ST_T state machines (i.e., all SSP connection requests result in OPEN_REJECT (RETRY));
- c) if a SCSI Command Received transport protocol service indication is received, then the device server shall abort that command and send an Accept_Reject OPENs (Reject SSP) request to the ST_T state machine on which the SCSI Command Received transport protocol service indication was received; and
- d) if the power loss timeout timer expires, then the SCSI application layer shall send an Accept_Reject OPENs (Accept SSP) request to all ST_T state machines.

~~If any frames are received by the SAS target device after receiving NOTIFY (POWER LOSS EXPECTED) before a connection is closed, then the SAS target device shall discard the received frames.~~

After power on, the power loss timeout timer shall be initialized and stopped until a NOTIFY (POWER LOSS EXPECTED) is received.

Page: 304

Author: RElliott
Subject: Highlight
Date: 6/30/2008 6:16:52 PM
 ACCEPT - DONE

application layer
s/b
SCSI application layer

Author: stx-goulder
Subject: Highlight
Date: 6/28/2008 2:08:46 PM

 ACCEPT - DONE (deleting the paragraph. It's trying to point out that power on is the only event that causes automatic spinup; hard reset, etc. do not.)

I_T nexus loss, logical unit reset, and hard reset shall not cause a SAS target device to spin-up automatically on receipt of NOTIFY (ENABLE SPINUP).

The point of this sentence is unclear. This clause specifies NOTIFY(ENABLE SPINUP) alone gives permission of device to spin up -- does this sentence mean that a reset just before a NOTIFY revokes the spinup permission?

Author: wdc-mevans
Subject: Highlight
Date: 6/28/2008 2:08:12 PM

 REJECT (deleting the paragraph instead.)

I_T nexus loss, logical unit reset, and hard reset shall not cause a SAS target device to spin-up automatically on receipt of NOTIFY (ENABLE SPINUP).

s/b

If a SAS target device is in the Stopped power condition state (see x.x), then the device shall not transition from the Stopped state (e.g., start the device's spindle motor) after an I_T nexus loss, logical unit reset, or hard reset until the device has received both a START STOP UNIT command with the START bit set to one and a NOTIFY (ENABLE SPINUP).

Author: RElliott
Subject: Note
Date: 6/30/2008 6:16:52 PM

 ACCEPT - DONE

spin up
s/b

temporary consumption of additional power

Author: wdc-mevans
Subject: Highlight
Date: 5/6/2008 4:07:49 PM

 ACCEPT - DONE ("received by any of")

from all

s/b

received on any of

Author: wdc-mevans
Subject: Highlight
Date: 5/30/2008 5:34:25 PM

 ACCEPT - DONE

honor

s/b

process a

Comments from page 304 continued on next page

device may allow this timing to be configured by an NVRAM programmed with enclosure-specific sequencing patterns, or may employ more complex, dynamic interaction with the enclosure power supply.

NOTE 47 - NOTIFY (ENABLE SPINUP) should be transmitted as frequently as possible to avoid incurring application layer timeouts.

L_T nexus loss, logical unit reset, and hard reset shall not cause a SAS target device to spin-up automatically on receipt of NOTIFY (ENABLE SPINUP).

A SAS target device with multiple SAS target ports shall honor NOTIFY (ENABLE SPINUP) from all its SAS target ports equivalently (e.g., if a SAS target device contains two SSP target ports A and B, powers on in the Stopped state, and receives a START STOP UNIT command with the START bit set to one through SSP target port A, then a NOTIFY (ENABLE SPINUP) received on SSP target port B causes the SAS target device to spin up its rotating media (see 10.2.10)).

7.2.5.3.3 NOTIFY (POWER LOSS EXPECTED)

NOTIFY (POWER LOSS EXPECTED) is transmitted by a SAS initiator port or expander port and is used to specify to a SAS target device that power loss may occur within the time specified in the POWER LOSS TIMEOUT field in the Shared Port Control mode page (see 10.2.7.6).

NOTIFY (POWER LOSS EXPECTED) shall be transmitted at least three times by the SAS initiator port or expander port.

If a SAS target device supports NOTIFY (POWER LOSS EXPECTED) and receives NOTIFY (POWER LOSS EXPECTED) on an SSP target port, then the device server for each logical unit to which the SSP target port has access shall:

- 1) stop writing data to the media on a block boundary (e.g., all write activity shall continue until a block boundary is reached then all writing shall stop);
- 2) clear all task sets as defined in SAM-4; and
- 3) establish a unit attention condition for the initiator port associated with every L_T nexus as defined in SAM-4 (e.g., with the additional sense code set to COMMANDS CLEARED BY POWER LOSS NOTIFICATION).

If a SAS target device supports NOTIFY (POWER LOSS EXPECTED) and receives NOTIFY (POWER LOSS EXPECTED) on an SSP target port, then the SAS target device shall:

- a) on each phy that receives NOTIFY (POWER LOSS EXPECTED), if there is an SSP connection, then transmit a BREAK on that connection; and
- b) on each phy that does not receive NOTIFY (POWER LOSS EXPECTED), if there is an SSP connection, then transmit a BREAK or a CLOSE on that connection.

The SCSI application layer that receives a Power Loss Expected event shall:

- a) start the power loss timer;
- b) send an Accept_Reject OPENs (Reject SSP) request to all ST_T state machines (i.e., all SSP connection requests result in OPEN_REJECT (RETRY));
- c) if a SCSI Command Received transport protocol service indication is received, then the device server shall abort that command and send an Accept_Reject OPENs (Reject SSP) request to the ST_T state machine on which the SCSI Command Received transport protocol service indication was received; and
- d) if the power loss timeout timer expires, then the SCSI application layer shall send an Accept_Reject OPENs (Accept SSP) request to all ST_T state machines.

~~If any frames are received by the SAS target device after receiving NOTIFY (POWER LOSS EXPECTED) before a connection is closed, then the SAS target device shall discard the received frames.~~

After power on, the power loss timeout timer shall be initialized and stopped until a NOTIFY (POWER LOSS EXPECTED) is received.

Author: wdc-mevans
Subject: Cross-Out
Date: 5/30/2008 5:34:49 PM
 REJECT (this emphasizes that they're equivalent. Moved in front of the new verb "process", however)

equivalently
[Delete the unnecessary word.]

Author: wdc-mevans
Subject: Highlight
Date: 5/6/2008 4:07:49 PM
 REJECT (the "two" is important)

two SSP target ports A and B,
s/b
SSP target port A and SSP target port B,

Author: RElliott
Subject: Highlight
Date: 6/30/2008 6:16:52 PM
 ACCEPT - DONE

causes
s/b
allows

Author: RElliott
Subject: Highlight
Date: 6/30/2008 6:16:52 PM
 ACCEPT - DONE

spin up its rotating media
s/b
temporary consumption of additional power

Author: Isi-bday
Subject: Highlight
Date: 6/28/2008 2:12:17 PM
 ACCEPT - DONE (as "stop writing data to the media as soon as possible withough creating read errors for future reads (e.g., on a direct-access block device, a physical block boundary is reached)". This rule needs to be followed in principle by all device types, not just block devices.)

stop writing data
s/b
if a block device, stop writing data...

Author: wdc-mevans
Subject: Highlight
Date: 5/6/2008 4:07:49 PM
 ACCEPT - DONE

reached then
s/b
reached, then

Author: RElliott
Subject: Note
Date: 6/30/2008 6:16:52 PM
 ACCEPT - DONE

Merge these two paragraphs with the same conditions into one a) and b) list, and shift make the current lists one level deeper.

Author: wdc-mevans

Comments from page 304 continued on next page

device may allow this timing to be configured by an NVRAM programmed with enclosure-specific sequencing patterns, or may employ more complex, dynamic interaction with the enclosure power supply.

NOTE 47 - NOTIFY (ENABLE SPINUP) should be transmitted as frequently as possible to avoid incurring application layer timeouts.

I_T nexus loss, logical unit reset, and hard reset shall not cause a SAS target device to spin-up automatically on receipt of NOTIFY (ENABLE SPINUP).

A SAS target device with multiple SAS target ports shall honor NOTIFY (ENABLE SPINUP) from all its SAS target ports equivalently (e.g., if a SAS target device contains two SSP target ports A and B, powers on in the Stopped state, and receives a START STOP UNIT command with the START bit set to one through SSP target port A, then a NOTIFY (ENABLE SPINUP) received on SSP target port B causes the SAS target device to spin up its rotating media (see 10.2.10)).

7.2.5.3.3 NOTIFY (POWER LOSS EXPECTED)

NOTIFY (POWER LOSS EXPECTED) is transmitted by a SAS initiator port or expander port and is used to specify to a SAS target device that power loss may occur within the time specified in the POWER LOSS TIMEOUT field in the Shared Port Control mode page (see 10.2.7.6).

NOTIFY (POWER LOSS EXPECTED) shall be transmitted at least three times by the SAS initiator port or expander port.

If a SAS target device supports NOTIFY (POWER LOSS EXPECTED) and receives NOTIFY (POWER LOSS EXPECTED) on an SSP target port, then the device server for each logical unit to which the SSP target port has access shall:

- 1) stop writing data to the media on a block boundary (e.g., all write activity shall continue until a block boundary is reached then all writing shall stop);
- 2) clear all task sets as defined in SAM-4; and
- 3) establish a unit attention condition for the initiator port associated with every I_T nexus as defined in SAM-4 (e.g., with the additional sense code set to COMMANDS CLEARED BY POWER LOSS NOTIFICATION).

If a SAS target device supports NOTIFY (POWER LOSS EXPECTED) and receives NOTIFY (POWER LOSS EXPECTED) on an SSP target port, then the SAS target device shall:

- a) on each phy that receives NOTIFY (POWER LOSS EXPECTED), if there is an SSP connection, then transmit a BREAK on that connection; and
- b) on each phy that does not receive NOTIFY (POWER LOSS EXPECTED), if there is an SSP connection, then transmit a BREAK or a CLOSE on that connection.

The SCSI application layer that receives a Power Loss Expected event shall:

- a) start the power loss timer;
- b) send an Accept_Reject OPENs (Reject SSP) request to all ST_T state machines (i.e., all SSP connection requests result in OPEN_REJECT (RETRY));
- c) if a SCSI Command Received transport protocol service indication is received, then the device server shall abort that command and send an Accept_Reject OPENs (Reject SSP) request to the ST_T state machine on which the SCSI Command Received transport protocol service indication was received; and
- d) if the power loss timeout timer expires, then the SCSI application layer shall send an Accept_Reject OPENs (Accept SSP) request to all ST_T state machines.

~~If any frames are received by the SAS target device after receiving NOTIFY (POWER LOSS EXPECTED) before a connection is closed, then the SAS target device shall discard the received frames.~~

After power on, the power loss timeout timer shall be initialized and stopped until a NOTIFY (POWER LOSS EXPECTED) is received.

Subject: Highlight

Date: 5/6/2008 4:07:49 PM

T REJECT (the layer receives the event from another entity in the target device. The target device doesn't receive the event)

layer that

s/b

layer in the SAS target device

Author: lsi-bday

Subject: Cross-Out

Date: 5/30/2008 5:41:38 PM

T ACCEPT - DONE (5/5 keep sentence but downgrade shall to should. Also reworded to active tense:

"If the SAS target device receives any frames after receiving NOTIFY (POWER LOSS EXPECTED) before a connection is closed, then it should discard the received frames.")

If any frames are received by the SAS target device after receiving NOTIFY (POWER LOSS EXPECTED) before a connection is closed, then the SAS target device shall discard the received frames.

I think the requirement to issue BREAK or CLOSE above is sufficient.

7.2.6 Primitives not specific to type of connections

7.2.6.1 AIP (Arbitration in progress)

AIP is **sent** by an expander device after a connection request to specify that the connection request is being processed and specify the status of the connection request.

The versions of AIP representing different statuses are defined in table 119.

Table 119 — AIP primitives

Primitive	Description
AIP (NORMAL)	Expander device has accepted the connection request. This may be sent multiple times (see 7.12.4.3).
AIP (RESERVED 0)	Reserved. Processed the same as AIP (NORMAL).
AIP (RESERVED 1)	
AIP (RESERVED 2)	
AIP (WAITING ON CONNECTION)	Expander device has determined the routing for the connection request, but either the destination phys are all being used for connections or there are insufficient routing resources to complete the connection request. This may be sent multiple times (see 7.12.4.3).
AIP (WAITING ON DEVICE)	Expander device has determined the routing for the connection request and forwarded it to the output physical link. This is sent one time (see 7.12.4.3).
AIP (WAITING ON PARTIAL)	Expander device has determined the routing for the connection request, but the destination phys are all busy with other partial pathways. This may be sent multiple times (see 7.12.4.3).
AIP (RESERVED WAITING ON PARTIAL)	Reserved. Processed the same as AIP (WAITING ON PARTIAL).

See 7.12 for details on connections.

7.2.6.2 BREAK

BREAK is used to abort a connection request or break a connection.

See 7.12.6 and 7.12.8 for details on breaking connections.

7.2.6.3 BREAK_REPLY

BREAK_REPLY is used to confirm the receipt of a BREAK.

See 7.12.6 and 7.12.8 for details on breaking connections.

7.2.6.4 BROADCAST

BROADCASTs are used to notify **all SAS ports** in a **domain of an event**.

● Author: RElliott
Subject: Highlight
Date: 6/30/2008 6:16:52 PM
T ACCEPT - DONE
sent
s/b
transmitted

● Author: RElliott
Subject: Highlight
Date: 6/30/2008 6:16:52 PM
T ACCEPT - DONE
sent
s/b
transmitted

● Author: RElliott
Subject: Highlight
Date: 6/30/2008 6:16:52 PM
T ACCEPT - DONE
sent
s/b
transmitted

● Author: RElliott
Subject: Highlight
Date: 6/30/2008 6:16:52 PM
T ACCEPT - DONE
sent
s/b
transmitted

● Author: RElliott
Subject: Highlight
Date: 6/30/2008 6:16:52 PM
T ACCEPT - DONE
sent
s/b
transmitted

● Author: RElliott
Subject: Highlight
Date: 6/30/2008 6:16:52 PM
T ACCEPT - DONE

of an event
s/b
about certain events

to match wording in 4.1.13

● Author: RElliott
Subject: Highlight
Date: 6/30/2008 6:16:52 PM

7.2.6 Primitives not specific to type of connections

7.2.6.1 AIP (Arbitration in progress)

AIP is **sent** by an expander device after a connection request to specify that the connection request is being processed and specify the status of the connection request.

The versions of AIP representing different statuses are defined in table 119.

Table 119 — AIP primitives

Primitive	Description
AIP (NORMAL)	Expander device has accepted the connection request. This may be sent multiple times (see 7.12.4.3).
AIP (RESERVED 0)	Reserved. Processed the same as AIP (NORMAL).
AIP (RESERVED 1)	
AIP (RESERVED 2)	
AIP (WAITING ON CONNECTION)	Expander device has determined the routing for the connection request, but either the destination phys are all being used for connections or there are insufficient routing resources to complete the connection request. This may be sent multiple times (see 7.12.4.3).
AIP (WAITING ON DEVICE)	Expander device has determined the routing for the connection request and forwarded it to the output physical link. This is sent one time (see 7.12.4.3).
AIP (WAITING ON PARTIAL)	Expander device has determined the routing for the connection request, but the destination phys are all busy with other partial pathways. This may be sent multiple times (see 7.12.4.3).
AIP (RESERVED WAITING ON PARTIAL)	Reserved. Processed the same as AIP (WAITING ON PARTIAL).

See 7.12 for details on connections.

7.2.6.2 BREAK

BREAK is used to abort a connection request or break a connection.

See 7.12.6 and 7.12.8 for details on breaking connections.

7.2.6.3 BREAK_REPLY

BREAK_REPLY is used to confirm the receipt of a BREAK.

See 7.12.6 and 7.12.8 for details on breaking connections.

7.2.6.4 BROADCAST

BROADCASTs are used to notify **all SAS ports** in a **domain of an event**.

T ACCEPT - DONE

domain
s/b
SAS domain

● Author: RElliott
Subject: Highlight
Date: 6/30/2008 6:16:52 PM

T ACCEPT - DONE

all SAS ports
s/b
SAS ports and expander devices

to match a change in 4.1.13 per lsi-bbesmer

The versions of BROADCAST representing different Broadcast types are defined in table 120.

Table 120 — BROADCAST primitives

Primitive	Description
BROADCAST (CHANGE)	Broadcast (Change)
BROADCAST (RESERVED CHANGE 0)	Broadcast (Reserved Change 0)
BROADCAST (RESERVED CHANGE 1)	Broadcast (Reserved Change 1)
BROADCAST (SES)	Broadcast (SES)
BROADCAST (EXPANDER)	Broadcast (Expander)
BROADCAST (ASYNCHRONOUS EVENT)	Broadcast (Asynchronous Event)
BROADCAST (RESERVED 3)	Broadcast (Reserved 3)
BROADCAST (RESERVED 4)	Broadcast (Reserved 4)

A phy that has not completed the link reset sequence shall not transmit a BROADCAST. A phy shall not transmit a BROADCAST inside a connection.

A BROADCAST received by a phy that has not completed the link reset sequence shall be ignored.

~~See 4.1.13 for definitions of Broadcasts.~~

7.2.6.5 CLOSE

CLOSE is used to close a connection. This primitive may be originated by a SAS initiator port or a SAS target port.

The versions of CLOSE representing different reasons are defined in table 121.

Table 121 — CLOSE primitives

Primitive	Description
CLOSE (CLEAR AFFILIATION)	Close an open STP connection and clear the affiliation (see 7.17.4). Processed the same as CLOSE (NORMAL) if: <ol style="list-style-type: none"> the connection is not an STP connection; the connection is an STP connection, but affiliations are not implemented by the STP target port; or the connection is an STP connection, but an affiliation is not present.
CLOSE (NORMAL)	Close a connection.
CLOSE (RESERVED 0)	Reserved. Processed the same as CLOSE (NORMAL).
CLOSE (RESERVED 1)	

See 7.12.7 for details on closing connections.

7.2.6.6 EOAF (End of address frame)

EOAF specifies the end of an address frame.

See 7.8 for details on address frames.

● Author: stx-ghoulder

Subject: Highlight

Date: 5/25/2008 8:25:38 PM

T ACCEPT - DONE (change "representing different Broadcast types" to "representing different Broadcasts (see table 7 in 4.1.13)" and delete the last paragraph of this section. Keep the table column, though - it's what translates all-caps BROADCAST primitives into the mixed-case Broadcast term (just like the SMP ZONED BROADCAST function defines which field values correspond to each Broadcast)

Description

None of these descriptions provide useful information. The description column contents should be replaced with a reference to Table 7, which does have a useful description.

● Author: stx-ghoulder

Subject: Highlight

Date: 5/6/2008 4:07:49 PM

T ACCEPT - DONE (although we don't say that for all the other NoConn primitives like SOAF and EOAF, this one could be particularly confusing and I agree this sentence would be helpful)

ignored.

Should this sentence be added? "A BROADCAST received inside a connection shall be ignored."

● Author: RElliott

Subject: Cross-Out

Date: 6/30/2008 6:16:52 PM

T ACCEPT - DONE

Delete:

See 4.1.13 for definitions of Broadcasts.

and replace by referencing table 7 in 4.1.13 earlier, above table 120

7.2.6.7 ERROR

ERROR should be sent by an expander device when it is forwarding dwords from a SAS physical link or SATA physical link to a SAS physical link and it receives an invalid dword or an ERROR.

NOTE 48 - Since an 8b10b coding error in one dword is sometimes not detected until the next dword (see table 86 in 6.3.5), expander devices should avoid deleting invalid dwords or ERRORS unless necessary (e.g., if the elasticity buffer is full) to avoid hiding evidence that an error has occurred.

See 7.15 for details on error handling by expander devices.

7.2.6.8 HARD_RESET

HARD_RESET is used to force a phy to generate a hard reset to its port. This primitive is only valid after the phy reset sequence without an intervening identification sequence (see 4.4) and shall be ignored at other times.

7.2.6.9 OPEN_ACCEPT

OPEN_ACCEPT specifies the acceptance of a connection request.

See 7.12 for details on connection requests.

7.2.6.10 OPEN_REJECT

OPEN_REJECT specifies that a connection request has been rejected and specifies the reason for the rejection. The result of some OPEN_REJECTs is to abandon (i.e., not retry) the connection request and the result of other OPEN_REJECTs is to retry the connection request.

● Author: RElliott
Subject: Highlight
Date: 6/30/2008 6:16:52 PM

T ACCEPT - DONE
sent
s/b
transmitted

● Author: wdc-mevans
Subject: Highlight
Date: 5/6/2008 4:07:49 PM

T REJECT
it
s/b
the expander device

● Author: RElliott
Subject: Highlight
Date: 6/30/2008 6:16:52 PM

T ACCEPT - DONE
hard reset
s/b
hard reset (see 4.4.2)

● Author: wdc-mevans
Subject: Highlight
Date: 5/6/2008 4:07:49 PM

T ACCEPT - DONE
request and
s/b
request, and

All of the OPEN_REJECT versions defined in table 122 shall result in the originating port abandoning the connection request.

Table 122 — Abandon-class OPEN_REJECT primitives

Primitive	Originator	Description
OPEN_REJECT (BAD DESTINATION)	Expander phy	A connection request routes to a destination expander phy in the same expander port as the source expander phy and the expander port is using the direct routing method (see 4.6.7.1).
OPEN_REJECT (CONNECTION RATE NOT SUPPORTED)	Any phy	<p>The requested connection rate is not supported on some physical link on the pathway between the source phy and destination phy. When a SAS initiator phy is directly attached to a SAS target phy, the requested connection rate is not supported by the destination phy.</p> <p>If the connection rate is 1.5 Gbps, this shall be considered an abandon-class OPEN_REJECT.</p> <p>If the connection rate is greater than 1.5 Gbps, the connection request shall be modified and reattempted as described in 7.8.3.</p>
OPEN_REJECT (PROTOCOL NOT SUPPORTED)	Destination phy	Phy with destination SAS address exists but the destination phy does not support the requested initiator/target role, protocol, initiator connection tag, or features (i.e., the values in the INITIATOR PORT bit, the PROTOCOL field, the INITIATOR CONNECTION TAG field, and/or the FEATURES field in the OPEN address frame are not supported).
OPEN_REJECT (RESERVED ABANDON 1)	Unknown	Reserved. Process the same as OPEN_REJECT (WRONG DESTINATION).
OPEN_REJECT (RESERVED ABANDON 2)		
OPEN_REJECT (RESERVED ABANDON 3)		
OPEN_REJECT (STP RESOURCES BUSY)	Destination phy	STP target port with destination SAS address exists but the STP target port supports affiliations and is not able to establish an affiliation with this STP initiator port (e.g., because it has reached its maximum number of affiliations), or the STP target port does not support affiliations and all of the available ATA task file registers have been allocated to other STP initiator ports (see 7.17.4). Process the same as OPEN_REJECT (WRONG DESTINATION) for non-STP connection requests.
OPEN_REJECT (WRONG DESTINATION)	Destination phy	The destination SAS address does not match the SAS address of the SAS port to which the connection request was delivered.
OPEN_REJECT (ZONE VIOLATION)	Zoning expander phy	The connection request is from a zone group that does not have permission to access the zone group that contains the destination phy according to the zone permission table of an unlocked zoning expander device.

Author: RElliott
Subject: Highlight
Date: 6/30/2008 6:16:52 PM
T ACCEPT - DONE
this
s/b
then this

Author: RElliott
Subject: Highlight
Date: 6/30/2008 6:16:52 PM
T ACCEPT - DONE
the
s/b
then the

Author: wdc-mevans
Subject: Highlight
Date: 5/25/2008 8:26:18 PM
T ACCEPT - DONE

exists but
s/b
exists, but

Author: Isi-gpenokie
Subject: Highlight
Date: 5/8/2008 8:57:17 PM
T ACCEPT - DONE

This << requested initiator/target role, >> should be << requested initiator role, target role, >> .

Author: wdc-mevans
Subject: Highlight
Date: 5/25/2008 8:26:55 PM
T ACCEPT - DONE
exists but
s/b
exists, but

Author: wdc-mevans
Subject: Highlight
Date: 5/25/2008 8:27:14 PM
T REJECT (first noun/subject convention)

it
s/b
the STP target port

Author: Isi-gpenokie
Subject: Highlight
Date: 5/25/2008 8:27:03 PM
T REJECT (first noun/subject convention)

This << because it has reached its >> should be << the STP target port has reached its >>

Author: RElliott
Subject: Highlight
Date: 6/30/2008 6:16:52 PM

All of the OPEN_REJECT versions defined in table 122 shall result in the originating port abandoning the connection request.

Table 122 — Abandon-class OPEN_REJECT primitives

Primitive	Originator	Description
OPEN_REJECT (BAD DESTINATION)	Expander phy	A connection request routes to a destination expander phy in the same expander port as the source expander phy and the expander port is using the direct routing method (see 4.6.7.1).
OPEN_REJECT (CONNECTION RATE NOT SUPPORTED)	Any phy	<p>The requested connection rate is not supported on some physical link on the pathway between the source phy and destination phy. When a SAS initiator phy is directly attached to a SAS target phy, the requested connection rate is not supported by the destination phy.</p> <p>If the connection rate is 1.5 Gbps, this shall be considered an abandon-class OPEN_REJECT.</p> <p>If the connection rate is greater than 1.5 Gbps, the connection request shall be modified and reattempted as described in 7.8.3.</p>
OPEN_REJECT (PROTOCOL NOT SUPPORTED)	Destination phy	Phy with destination SAS address exists but the destination phy does not support the requested initiator/target role, protocol, initiator connection tag, or features (i.e., the values in the INITIATOR PORT bit, the PROTOCOL field, the INITIATOR CONNECTION TAG field, and/or the FEATURES field in the OPEN address frame are not supported).
OPEN_REJECT (RESERVED ABANDON 1)	Unknown	Reserved. Process the same as OPEN_REJECT (WRONG DESTINATION).
OPEN_REJECT (RESERVED ABANDON 2)		
OPEN_REJECT (RESERVED ABANDON 3)		
OPEN_REJECT (STP RESOURCES BUSY)	Destination phy	STP target port with destination SAS address exists but the STP target port supports affiliations and is not able to establish an affiliation with this STP initiator port (e.g., because it has reached its maximum number of affiliations), or the STP target port does not support affiliations and all of the available ATA task file registers have been allocated to other STP initiator ports (see 7.17.4). Process the same as OPEN_REJECT (WRONG DESTINATION) for non-STP connection requests.
OPEN_REJECT (WRONG DESTINATION)	Destination phy	The destination SAS address does not match the SAS address of the SAS port to which the connection request was delivered.
OPEN_REJECT (ZONE VIOLATION)	Zoning expander phy	The connection request is from a zone group that does not have permission to access the zone group that contains the destination phy according to the zone permission table of an unlocked zoning expander device.

T ACCEPT - DONE

ATA task file registers
s/b
affiliation contexts

All of the OPEN_REJECT versions defined in table 123 shall result in the originating port retrying the connection request.

Table 123 — Retry-class OPEN_REJECT primitives

Primitive	Originator	Description
OPEN_REJECT (NO DESTINATION) ^a	Expander phy	An expander device in the pathway is not configuring and determines that: a) there is no such destination phy; b) the connection request routes to a destination expander phy in the same expander port as the source expander phy and the expander port is using the subtractive routing method; or c) the SAS address is valid for an STP target port in an STP/SATA bridge, but the initial Register - Device to Host FIS has not been successfully received (see 10.4.3.12).
OPEN_REJECT (PATHWAY BLOCKED) ^b	Expander phy	An expander device determined the pathway was blocked by higher priority connection requests.
OPEN_REJECT (RESERVED CONTINUE 0) ^c	Unknown	Reserved. Process the same as OPEN_REJECT (RETRY).
OPEN_REJECT (RESERVED CONTINUE 1) ^c		
OPEN_REJECT (RESERVED INITIALIZE 0) ^a	Unknown	Reserved. Process the same as OPEN_REJECT (NO DESTINATION).
OPEN_REJECT (RESERVED INITIALIZE 1) ^a		
OPEN_REJECT (RESERVED STOP 0) ^b	Unknown	Reserved. Process the same as OPEN_REJECT (PATHWAY BLOCKED).
OPEN_REJECT (RESERVED STOP 1) ^b		
OPEN_REJECT (RETRY) ^c	Destination phy or zoning expander phy	Either: a) a phy with destination SAS address exists but is temporarily not able to accept connections (see 7.16.1, 7.17.5, and 7.18.3); b) an expander device in the pathway is configuring and would otherwise have returned OPEN_REJECT (NO DESTINATION)(see 4.7.2 and 7.12.4.2.5); c) an expander device in the pathway is locked and would otherwise have returned OPEN_REJECT (ZONE VIOLATION)(see 4.9.3.5 and 7.12.4.2.5); or d) an expander device in the pathway has reduced functionality (see 4.6.8 and 7.12.4.2.5).
^a If the I_T Nexus Loss timer is already running, it continues running; if it is not already running, it is initialized and started. Stop retrying the connection request if the I_T Nexus Loss timer expires. ^b If the I_T Nexus Loss timer is already running, it continues running. Stop retrying the connection request if the I_T Nexus Loss timer expires. ^c If the I_T Nexus Loss timer (see 8.2.2) is already running, it is stopped.		

NOTE 49 - Some SAS logical phys compliant with earlier versions of this standard also transmit OPEN_REJECT (RETRY) if they receive an OPEN address frame while their SL_CC state machines are in the SL_CC5:BreakWait state (see 7.14.4.7).

● Author: stx-ghoulder

Subject: Highlight

Date: 6/2/2008 10:18:12 AM

T REJECT (no, that's a very crucial sentence. If an expander is in the middle of configuring, it returns OPEN_REJECT (RETRY) instead of OPEN_REJECT (NO DESTINATION). Added "(see 4.7.2)" in case the word "configuring" is not understood by someone without an expander focus.)

is not configuring and

Delete this phrase, it adds nothing useful and may have a confusing meaning to some readers.

● Author: wdc-mevans

Subject: Highlight

Date: 5/25/2008 8:27:42 PM

T REJECT (2 things ANDED)

phy and

s/b

phy, and

● Author: RElliott

Subject: Highlight

Date: 6/30/2008 6:16:52 PM

T ACCEPT - DONE

after

configuring

add

(see 4.7.2)

● Author: Isi-gpenokie

Subject: Highlight

Date: 5/25/2008 8:28:04 PM

T ACCEPT - DONE (dropped the semicolon, kept the it)

This << continues running; if it is not already running, it is >> should be << continues running. If the I_T Nexus Loss timer is not already running, it is >>

When a SAS logical phy detects more than one reason to transmit an OPEN_REJECT, the SL_CC state machine determines the priority in the SL_CC2:Selected state (see 7.14.4.4).

When an expander logical phy detects more than one reason to transmit an OPEN_REJECT, the ECM determines the priority (see 7.12.4).

See 7.12 for details on connection requests.

7.2.6.11 SOAF (Start of address frame)

SOAF specifies the start of an address frame.

See 7.8 for details on address frames.

7.2.6.12 TRAIN

TRAIN is used during Train-SNW during speed negotiation.

See 6.7.4.2.3.4 for details on Train-SNW.

7.2.6.13 TRAIN_DONE

TRAIN_DONE is used during Train-SNW during speed negotiation.

See 6.7.4.2.3.4 for details on Train-SNW.

7.2.7 Primitives used only inside SSP and SMP connections

7.2.7.1 ACK (Acknowledge)

ACK specifies the positive acknowledgement of an SSP frame.

See 7.16.3 for details on SSP frame transmission.

7.2.7.2 CREDIT_BLOCKED

CREDIT_BLOCKED specifies that no more **credit is** going to be sent during this connection.

See 7.16.4 for details on SSP flow control.

7.2.7.3 DONE

DONE is used to start closing an SSP connection and specify a reason for doing so. This primitive may be originated by an SSP initiator port or an SSP target port. DONE is not used **to close** an SMP or STP connection.

● Author: wdc-mevans

Subject: Highlight

Date: 5/25/2008 8:28:21 PM

T ACCEPT - DONE ("no more RRDYs are going to be transmitted during this connection (i.e., credit is not going to be increased)")

credit is

s/b

RRDYs are

● Author: wdc-mevans

Subject: Highlight

Date: 5/6/2008 4:07:49 PM

T ACCEPT - DONE

to close

s/b

during

The versions of DONE representing different reasons are defined in table 124. The SSP state machine describes when these are used (see 7.16.8).

Table 124 — DONE primitives

Primitive	Description
DONE (ACK/NAK TIMEOUT)	The SSP state machine (see 7.16.8) timed out waiting for an ACK or NAK, and the phy is going to transmit BREAK in 1 ms unless DONE is received within 1 ms of transmitting the DONE (ACK/NAK TIMEOUT).
DONE (RESERVED TIMEOUT 0)	Reserved. Processed the same as DONE (ACK/NAK TIMEOUT).
DONE (RESERVED TIMEOUT 1)	
DONE (NORMAL)	Finished transmitting all frames.
DONE (RESERVED 0)	Reserved. Processed the same as DONE (NORMAL).
DONE (RESERVED 1)	
DONE (CREDIT TIMEOUT)	The SSP state machine (see 7.16.8) timed out waiting for an RRDY or received a CREDIT BLOCKED, and the phy is going to transmit BREAK if it provides transmit frame credit for 1 ms without receiving a frame or a DONE.

See 7.16.7 for details on closing SSP connections.

7.2.7.4 EOF (End of frame)

EOF specifies the end of an SSP or SMP frame.

See 7.16.3 for details on SSP frame transmission and 7.18.1 for details on SMP frame transmission.

7.2.7.5 NAK (Negative acknowledgement)

NAK specifies the negative acknowledgement of an SSP frame and the reason for doing so.

The versions of NAK representing different reasons are defined in table 125.

Table 125 — NAK primitives

Primitive	Description
NAK (CRC ERROR)	The frame had a bad CRC, or an invalid dword or an ERROR was received during frame reception.
NAK (RESERVED 0)	Reserved. Processed the same as NAK (CRC ERROR).
NAK (RESERVED 1)	
NAK (RESERVED 2)	

See 7.16.3 for details on SSP frame transmission.

7.2.7.6 RRDY (Receiver ready)

RRDY is used to increase SSP frame credit.

● Author: RElliott
Subject: Highlight
Date: 6/30/2008 6:16:52 PM
T ACCEPT - DONE

SSP state machine describes
s/b
SSP state machines describe

● Author: RElliott
Subject: Highlight
Date: 6/30/2008 6:16:52 PM
T ACCEPT - DONE

SSP state machine
s/b
SSP state machines

● Author: RElliott
Subject: Highlight
Date: 6/30/2008 6:16:52 PM
T ACCEPT - DONE

SSP state machine
s/b
SSP state machines

The versions of RRDY representing different reasons are defined in table 126.

Table 126 — RRDY primitives

Primitive	Description
RRDY (NORMAL)	Increase transmit frame credit by one.
RRDY (RESERVED 0)	Reserved. Processed the same as RRDY (NORMAL).
RRDY (RESERVED 1)	

A phy shall not transmit RRDY after transmitting CREDIT_BLOCKED in a connection. See 7.16.4 for details on SSP flow control.

7.2.7.7 SOF (Start of frame)

SOF specifies the start of an SSP or SMP frame.

See 7.16.3 for details on SSP frame transmission and 7.18.1 for details on SMP frame transmission.

7.2.8 Primitives used only inside STP connections and on SATA physical links

7.2.8.1 SATA_ERROR

SATA_ERROR should be sent by an expander device when it is forwarding dwords from a SAS logical link to a SATA physical link and it receives an invalid dword or an ERROR.

NOTE 50 - Since an 8b10b coding error in one dword is sometimes not detected until the next dword (see table 86 in 6.3.5), expander devices should avoid deleting invalid dwords or ERRORS unless necessary (e.g., if the elasticity buffer is full) to avoid hiding evidence that an error has occurred.

See 6.9 for details on error handling by expander devices.

Although included in this subclause, SATA_ERROR is not a primitive (see 3.1.172) since it starts with K28.6. It does not appear inside STP connections. It is an invalid dword.

7.2.8.2 SATA_PMACK, SATA_PMNAK, SATA_PMREQ_P, and SATA_PMREQ_S (Power management acknowledgements and requests)

SATA_PMREQ_P and SATA_PMREQ_S request entry into the interface power management partial and slumber states. SATA_PMACK is used to accept a power management request. SATA_PMNAK is used to reject a power management request.

See 7.10 for rules on handling the power management primitives.

7.2.8.3 SATA_HOLD and SATA_HOLDA (Hold and hold acknowledge)

See 7.17.2 for rules on STP flow control, which uses SATA_HOLD and SATA_HOLDA.

7.2.8.4 SATA_R_RDY and SATA_X_RDY (Receiver ready and transmitter ready)

When a SATA port has a frame to transmit, it transmits SATA_X_RDY and waits for SATA_R_RDY before transmitting the frame.

7.2.8.5 Other primitives used inside STP connections and on SATA physical links

Other primitives used in STP connections and on SATA physical links are defined in SATA.

● Author: RElliott
Subject: Highlight
Date: 6/30/2008 6:16:52 PM
T ACCEPT - DONE

when it
s/b
while the expander device

● Author: RElliott
Subject: Highlight
Date: 6/30/2008 6:16:52 PM
T ACCEPT - DONE

sent
s/b
transmitted

● Author: wdc-mevans
Subject: Highlight
Date: 6/2/2008 10:07:22 AM
T REJECT (deleting instead... no need to repeat the noun)

it
s/b
the expander device

● Author: RElliott
Subject: Highlight
Date: 8/31/2008 5:23:07 PM
T ACCEPT - DONE

It
s/b
SATA_ERROR

● Author: RElliott
Subject: Highlight
Date: 8/31/2008 5:23:18 PM
T ACCEPT - DONE

It
s/b
SATA_ERROR

7.3 Physical link rate tolerance management

7.3.1 Physical link rate tolerance management overview

The internal clock for a phy is typically based on a PLL with its own clock generator and is used when transmitting dwords on the physical link. When receiving, however, dwords need to be latched based on a clock derived from the input bit stream itself. Although the input clock is nominally a fixed frequency, it may differ slightly from the internal clock frequency up to the physical link rate tolerance defined in table 53 (see 5.3.3). Over time:

- a) if the input clock is faster than the internal clock, the phy receiver may receive a dword and not be able to forward it to an internal buffer; this is called an overrun; or
- b) if the input clock is slower than the internal clock, the phy receiver may not have a dword when needed in an internal buffer; this is called an underrun.

To solve this problem, phy transmitters insert deletable primitives (see 7.2.5) in the dword stream. Phy receivers may pass deletable primitives through to their internal buffers, or may strip them out when an overrun occurs. Phy receivers add deletable primitives when an underrun occurs. The internal logic shall ignore all deletable primitives that arrive in the internal buffers.

Circuitry (e.g., an elasticity buffer) is required to absorb the slight differences in frequencies between the phys. Figure 168 shows an example of an elasticity buffer. The frequency tolerance for a phy is specified in 5.3.3.

Author: elx-bmartin
Subject: Comment on Text
Date: 6/28/2008 2:40:33 PM

TACCEPT - DONE (Agreed. This section doesn't really care about the internal to transmitter design challenge, so will ignore it.

Changed first sentences to:

"A phy may have three clocks:

- a) an internal clock (e.g., based on a PLL clock generator);
- b) a transmit clock (e.g., based on a PLL clock generator with SSC, if SSC is enabled). Used when transmitting dwords on the physical link; and
- c) a receive clock, derived from the input bit stream. Used when receiving dwords from the physical link."

This is not totally true when you are doing SSC in an expander. When doing SSC there is a need to have elasticity or some other buffering/insertion between the internal clock and the transmitter.

Author: wdc-mevans
Subject: Highlight
Date: 5/25/2008 8:29:15 PM

TACCEPT - DONE (" Although the input clock nominally has the same fixed frequency as the internal clock, the input clock may differ")

it
s/b
the input clock frequency

Author: wdc-mevans
Subject: Cross-Out
Date: 5/25/2008 8:28:59 PM

TREJECT (it's important - these differences could easily be overlooked if we didn't highlight the issue)

slightly
s/b
[Delete the unnecessary word.]

Author: lsi-gpenokie
Subject: Highlight
Date: 5/25/2008 8:29:30 PM

TACCEPT - DONE (reworded as "if the input clock is faster than the internal clock, an overrun occurs if the phy receiver receives a dword and is not able to forward it to an internal receive buffer;")

This << internal buffer; this is called an overrun >> should be << internal buffer (i.e., an overrun) >>

Author: lsi-gpenokie
Subject: Highlight
Date: 5/25/2008 8:29:39 PM

TACCEPT - DONE (reworded as "if the input clock is slower than the internal clock, an underrun occurs if the phy receiver is not able to obtain a dword from an internal transmit buffer when needed")

This << internal buffer; this is called an underrun >> should be << internal buffer (i.e., an underrun) >>

Author: wdc-mevans
Subject: Highlight
Date: 5/25/2008 8:29:50 PM

TACCEPT - DONE ("To avoid overruns and underruns,")

To solve this problem,
s/b
In order to solve the problems of overruns and underruns,

Author: intc-mseidel
Subject: Highlight

7.3 Physical link rate tolerance management

7.3.1 Physical link rate tolerance management overview

The internal clock for a phy is typically based on a PLL with its own clock generator and is used when transmitting dwords on the physical link. When receiving, however, dwords need to be latched based on a clock derived from the input bit stream itself. Although the input clock is nominally a fixed frequency, it may differ slightly from the internal clock frequency up to the physical link rate tolerance defined in table 53 (see 5.3.3). Over time:

- a) if the input clock is faster than the internal clock, the phy receiver may receive a dword and not be able to forward it to an internal buffer; this is called an overrun; or
- b) if the input clock is slower than the internal clock, the phy receiver may not have a dword when needed in an internal buffer; this is called an underrun.

To solve this problem, phy transmitters insert deletable primitives (see 7.2.5) in the dword stream. Phy receivers may pass deletable primitives through to their internal buffers, or may strip them out when an overrun occurs. Phy receivers add deletable primitives when an underrun occurs. The internal logic shall ignore all deletable primitives that arrive in the internal buffers.

Circuitry (e.g., an elasticity buffer) is required to absorb the slight differences in frequencies between the phys. Figure 168 shows an example of an elasticity buffer. The frequency tolerance for a phy is specified in 5.3.3.

Date: 5/25/2008 8:30:10 PM

TREJECT (no, they pretty much must do so. What else are they going to send? It'd be complicated to try to send idle dwords or continued primitives at this time)

Second paragraph, third sentence: ""Phy receivers add deletable" s/b "Phy receivers may add deletable"

The depth of the elasticity buffer is vendor-specific but shall accommodate the physical link rate tolerance management deletable primitive insertion requirements in table 127 (see 7.3.2).

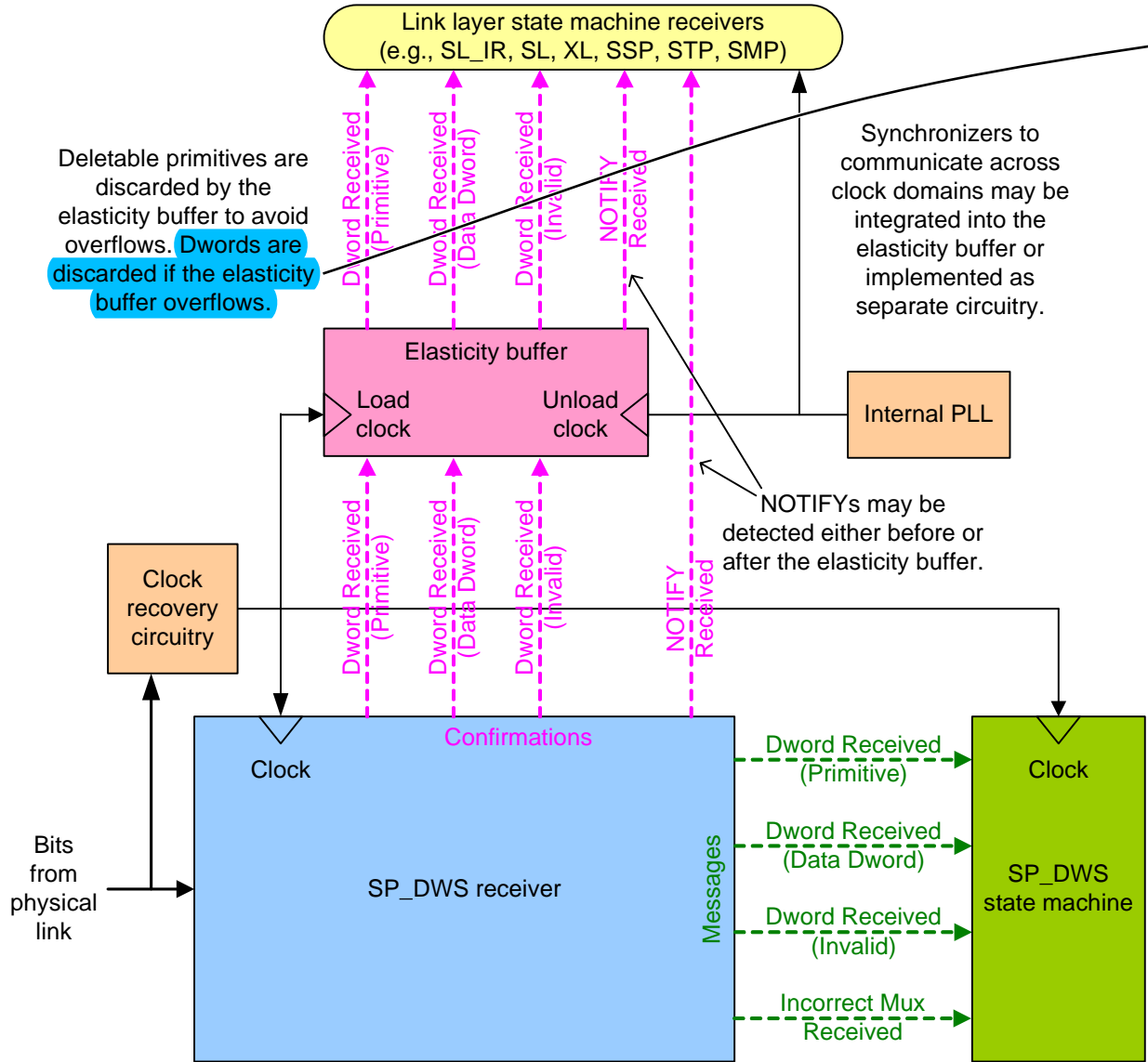

Figure 168 — Elasticity buffer

Author: stx-ghoulder

Subject: Highlight

Date: 5/6/2008 4:07:49 PM

TREJECT (first sentence says why deletable primitives are discarded - to avoid the second sentence. Second sentence says what happens to any dwords if an overflow occurs - they are discarded.)

Dwords are discarded if the elasticity buffer overflows.

This sentence is redundant with the previous sentence. Change this to "ALIGN primitives may be added to prevent buffer underflows" or just delete it.

7.3.2 Phys originating dwords

A logical phy that is the original source for the dword stream (i.e., a logical phy that is not an expander logical phy forwarding dwords from another expander logical phy) shall insert deletable primitives for physical link rate tolerance management after the phy reset sequence completes as described in table 127.

Table 127 — Physical link rate tolerance management deletable primitive insertion requirement

Physical link rate	Requirement
1.5 Gbps	One deletable primitive within every 128 dwords ^a
3 Gbps	Two deletable primitives within every 256 dwords ^b
6 Gbps	Four deletable primitives within every 512 dwords
^a Phys compliant with previous versions of this standard were required to insert one deletable primitive within every 2 048 dwords at 1.5 Gbps. ^b Phys compliant with previous versions of this standard were required to insert two deletable primitives within every 4 096 dwords at 3 Gbps.	

NOTE 51 - These numbers account for the worst case clock frequency differences between the fastest phy transmitter and the slowest phy receiver (e.g., a center-spreading expander phy originating dwords in an STP connection at +2 400 ppm that are forwarded to a down-spreading SATA device with an internal clock at -5 350 ppm). The difference of 7 750 ppm (i.e., 0.775 % or 1/129) is less than the ALIGN insertion rate of 1/128 (i.e., 7 813 ppm or 0.781 25 %), ensuring there are enough deletable primitives for the phy receiver to delete without having to buffer dwords.

Deletable primitives inserted for physical link rate tolerance management are in addition to deletable primitives inserted for rate matching (see 7.13). See Annex H for a summary of their combined requirements.

See 7.2.5.1 for details on rotating through ALIGN (0), ALIGN (1), ALIGN (2), and ALIGN (3). NOTIFYs may also be transmitted in place of ALIGNs (see 7.2.5.3) on SAS logical links. MUXs may also be transmitted in place of ALIGNs on multiplexed SAS physical links.

7.3.3 Expander phys forwarding dwords

An expander device that is forwarding dwords (i.e., is not the original source) is allowed to insert or delete as many deletable primitives as required to match the transmit and receive connection rates. It is not required to transmit the number of deletable primitives for physical link rate tolerance management described in table 127 when forwarding to a SAS logical link. ~~It shall increase or reduce that number based on clock frequency differences between the phy transmitting the dwords to the expander device and the expander device's receiving phy (e.g., if receiving at -100 ppm and transmitting at +100 ppm, it transmits fewer deletable primitives than it receives).~~

The expander device is also required to insert deletable primitives for rate matching (see 7.13). During an STP connection, the expander device shall:

- a) preserve the incoming rate of any additional deletable primitives that it receives that are not discarded because of physical link rate tolerance management or rate matching (e.g. the 1/128 deletable primitives received from an originating STP initiator phy compliant with previous versions of this standard for STP initiator phy throttling); or
- b) transmit one deletable primitive within every 128 dwords,

without discarding any data dwords or primitives. It may reduce the length of repeated primitive sequences (i.e., primitive, SATA_CONT, and data dword sequences).

NOTE 52 - One possible implementation for expander devices forwarding dwords is for the expander device to delete all deletable primitives received and to insert deletable primitives at the transmit phy whenever its elasticity buffer is empty.

The STP target port of an STP/SATA bridge is allowed to insert or delete as many deletable primitives as required to match the transmit and receive connection rates. It is not required to transmit any particular

Page: 315

Author: RElliott
Subject: Highlight
Date: 6/30/2008 6:16:52 PM
T ACCEPT - DONE (5/5 "is originating the dwords"...)

original source

Need better wording to avoid confusion with the OPEN sender

Author: intc-mseidel
Subject: Highlight
Date: 5/25/2008 8:30:52 PM
T ACCEPT - DONE (added "This standard has a higher frequency due to SSC (see xx).")

Notes a and b should include short explanation why insertion requirement is now so different, something like: "The different requirement in this version is due to the worst-case presence of different types of SSC in the datastream."

Author: Isi-gpenokie
Subject: Highlight
Date: 5/6/2008 4:07:49 PM
T ACCEPT - DONE

Tihs << NOTE 51 - These numbers >> should be made into a table footnote c in the above table.

Author: Isi-gpenokie
Subject: Highlight
Date: 6/28/2008 2:42:09 PM
T ACCEPT - LAST (check in last revision; problem went away incidentally when converted into a note. No automatic mechanism in place. Don't want to put non-blocking spaces around the / in this case.)

Set up frame to prevent a line brake on a << / >>.

Author: RElliott
Subject: Highlight
Date: 6/30/2008 6:16:52 PM
T ACCEPT - DONE

ALIGN insertion rate
s/b
deletable primitive insertion rate

Author: RElliott
Subject: Highlight
Date: 6/30/2008 6:16:52 PM
T ACCEPT - DONE (5/5 " i.e., is not originating dwords")

Need better phrase for "original source" to avoid confusion with the sender of the OPEN. This statement applies to both directions.

Author: wdc-mevans
Subject: Highlight
Date: 5/25/2008 8:32:54 PM
T REJECT (need to refer only to the "expander device that is forwarding" per the first sentence)

It
s/b
An expander device

Author: elx-bmartin
Subject: Cross-Out
Date: 6/28/2008 2:53:32 PM
T REJECT (5/5 change to "It shall increase or reduce that number based on clock frequency differences between the expander

Comments from page 315 continued on next page

7.3.2 Phys originating dwords

A logical phy that is the **original source** for the dword stream (i.e., a logical phy that is not an expander logical phy forwarding dwords from another expander logical phy) shall insert deletable primitives for physical link rate tolerance management after the phy reset sequence completes as described in table 127.

Table 127 — Physical link rate tolerance management deletable primitive insertion requirement

Physical link rate	Requirement
1.5 Gbps	One deletable primitive within every 128 dwords ^a
3 Gbps	Two deletable primitives within every 256 dwords ^b
6 Gbps	Four deletable primitives within every 512 dwords
^a Phys compliant with previous versions of this standard were required to insert one deletable primitive within every 2 048 dwords at 1.5 Gbps. ^b Phys compliant with previous versions of this standard were required to insert two deletable primitives within every 4 096 dwords at 3 Gbps.	

NOTE 51 - These numbers account for the worst case clock frequency differences between the fastest phy transmitter and the slowest phy receiver (e.g., a center-spreading expander phy originating dwords in an STP connection at +2 400 ppm that are forwarded to a down-spreading SATA device with an internal clock at -5 350 ppm). The difference of 7 750 ppm (i.e., 0.775 % or 1/129) is less than the **ALIGN insertion rate of 1/128** (i.e., 7 813 ppm or 0.781 25 %), ensuring there are enough deletable primitives for the phy receiver to delete without having to buffer dwords.

Deletable primitives inserted for physical link rate tolerance management are in addition to deletable primitives inserted for rate matching (see 7.13). See Annex H for a summary of their combined requirements.

See 7.2.5.1 for details on rotating through ALIGN (0), ALIGN (1), ALIGN (2), and ALIGN (3). NOTIFYs may also be transmitted in place of ALIGNs (see 7.2.5.3) on SAS logical links. MUXs may also be transmitted in place of ALIGNs on multiplexed SAS physical links.

7.3.3 Expander phys forwarding dwords

An expander device that is forwarding dwords (i.e., is not the **original source**) is allowed to insert or delete as many deletable primitives as required to match the transmit and receive connection rates. **It** is not required to transmit the number of deletable primitives for physical link rate tolerance management described in table 127 when **forwarding to** a SAS logical link. ~~It shall increase or reduce that number based on clock frequency differences between the phy transmitting the dwords to the expander device and the expander device's receiving phy (e.g., if receiving at -100 ppm and transmitting at +100 ppm, it transmits fewer deletable primitives than it receives).~~

The expander device is also required to insert deletable primitives for rate matching (see 7.13). During an STP connection, the expander device shall:

- preserve the incoming rate of any additional deletable primitives that **it** receives that are not discarded because of physical link rate tolerance management or rate matching (e.g. the 1/128 deletable primitives received from an originating STP initiator phy compliant with previous versions of this standard for STP initiator phy throttling); or
- transmit one deletable primitive within every 128 dwords,

without discarding any data dwords or primitives. **It** may reduce the length of repeated primitive sequences (i.e., primitive, SATA_CONT, and data dword sequences).

NOTE 52 - One possible implementation for expander devices forwarding dwords is for the expander device to delete all deletable primitives received and to insert deletable primitives at the transmit phy whenever its elasticity buffer is empty.

The STP target port of an STP/SATA bridge is allowed to insert or delete as many deletable primitives as required to match the transmit and receive connection rates. **It** is not required to transmit any particular

device's receiving phy and the expander device's transmitting phy (e.g., if receiving at -100 ppm and transmitting at +100 ppm, then it transmits fewer deletable primitives that it receives". This plus bolstering the earlier description of transmitting with SSC should help).

It shall increase or reduce that number based on clock frequency differences between the phy transmitting the dwords to the expander device and the expander device's receiving phy (e.g., if receiving at -100 ppm and transmitting at +100 ppm, it transmits fewer deletable primitives that it receives).

Delete this sentence. This does not clarify the difference of three different clock domains that are caused by SSC.

Author: wdc-mevans

Subject: Highlight

Date: 5/25/2008 8:34:01 PM

T REJECT (only one "number" in the previous sentence, and don't want to repeat the whole "for physical link rate tolerance management" phrase)

that number based

s/b

the number of deletable primitives transmitted based

Author: wdc-mevans

Subject: Highlight

Date: 5/25/2008 8:32:47 PM

T REJECT (still need to refer only to the "expander device that is forwarding" per the first sentence)

It

s/b

An expander device

Author: wdc-mevans

Subject: Highlight

Date: 5/25/2008 8:31:45 PM

T ACCEPT - DONE

forwarding to

s/b

forwarding dwords to

Author: elx-bmartin

Subject: Highlight

Date: 5/25/2008 8:34:18 PM

T ACCEPT - DONE

that

s.b.

than

Author: wdc-mevans

Subject: Highlight

Date: 5/25/2008 8:34:34 PM

T REJECT

it

s/b

the expander device

Author: wdc-mevans

Subject: Highlight

Date: 5/25/2008 8:34:48 PM

T REJECT

It

s/b

An expander device

7.3.2 Phys originating dwords

A logical phy that is the **original source** for the dword stream (i.e., a logical phy that is not an expander logical phy forwarding dwords from another expander logical phy) shall insert deletable primitives for physical link rate tolerance management after the phy reset sequence completes as described in table 127.

Table 127 — Physical link rate tolerance management deletable primitive insertion requirement

Physical link rate	Requirement
1.5 Gbps	One deletable primitive within every 128 dwords ^a
3 Gbps	Two deletable primitives within every 256 dwords ^b
6 Gbps	Four deletable primitives within every 512 dwords
^a Phys compliant with previous versions of this standard were required to insert one deletable primitive within every 2 048 dwords at 1.5 Gbps. ^b Phys compliant with previous versions of this standard were required to insert two deletable primitives within every 4 096 dwords at 3 Gbps.	

NOTE 51 - These numbers account for the worst case clock frequency differences between the fastest phy transmitter and the slowest phy receiver (e.g., a center-spreading expander phy originating dwords in an STP connection at +2 400 ppm that are forwarded to a down-spreading SATA device with an internal clock at -5 350 ppm). The difference of 7 750 ppm (i.e., 0.775 % or 1/129) is less than the **ALIGN insertion rate of 1/128** (i.e., 7 813 ppm or 0.781 25 %), ensuring there are enough deletable primitives for the phy receiver to delete without having to buffer dwords.

Deletable primitives inserted for physical link rate tolerance management are in addition to deletable primitives inserted for rate matching (see 7.13). See Annex H for a summary of their combined requirements.

See 7.2.5.1 for details on rotating through ALIGN (0), ALIGN (1), ALIGN (2), and ALIGN (3). NOTIFYs may also be transmitted in place of ALIGNs (see 7.2.5.3) on SAS logical links. MUXs may also be transmitted in place of ALIGNs on multiplexed SAS physical links.

7.3.3 Expander phys forwarding dwords

An expander device that is forwarding dwords (i.e., is not the **original source**) is allowed to insert or delete as many deletable primitives as required to match the transmit and receive connection rates. **It** is not required to transmit the number of deletable primitives for physical link rate tolerance management described in table 127 when **forwarding to** a SAS logical link. ~~It shall increase or reduce that number based on clock frequency differences between the phy transmitting the dwords to the expander device and the expander device's receiving phy (e.g., if receiving at -100 ppm and transmitting at +100 ppm, it transmits fewer deletable primitives than it receives).~~

The expander device is also required to insert deletable primitives for rate matching (see 7.13). During an STP connection, the expander device shall:

- preserve the incoming rate of any additional deletable primitives that **it** receives that are not discarded because of physical link rate tolerance management or rate matching (e.g. the 1/128 deletable primitives received from an originating STP initiator phy compliant with previous versions of this standard for STP initiator phy throttling); or
- transmit one deletable primitive within every 128 dwords,

without discarding any data dwords or primitives. **It** may reduce the length of repeated primitive sequences (i.e., primitive, SATA_CONT, and data dword sequences).

NOTE 52 - One possible implementation for expander devices forwarding dwords is for the expander device to delete all deletable primitives received and to insert deletable primitives at the transmit phy whenever its elasticity buffer is empty.

The STP target port of an STP/SATA bridge is allowed to insert or delete as many deletable primitives as required to match the transmit and receive connection rates. **It** is not required to transmit any particular

Author: wdc-mevans
Subject: Highlight
Date: 5/25/2008 8:35:09 PM

TREJECT

It
s/b
The STP target port

number of deletable primitives for physical link rate tolerance management when forwarding to a SAS logical link and is not required to ensure that any deletable primitives it transmits are in pairs.

NOTE 53 - Due to physical link rate tolerance management deletable primitive removal, the STP target port may not receive a pair of deletable primitives every 256 dwords, even if the STP initiator port transmitted them in pairs. However, the rate of the dword stream allows for deletable primitive insertion by the STP/SATA bridge. One possible implementation is for the STP/SATA bridge to delete all deletable primitives received by the STP target port and to insert two consecutive ALIGNs at the SATA host port when its elasticity buffer is empty or when 254 non-ALIGN dwords have been transmitted. It may need to buffer up to 2 dwords concurrently being received by the STP target port while it does so.

7.4 Idle physical links

Idle dwords are vendor-specific data dwords which are scrambled (see 7.6).

Phys shall transmit idle dwords if there are no other dwords to transmit and:

- a) no connection is open; or
- b) an SSP or SMP connection is open.

SATA_SYNC is a continued primitive sequence which may contain vendor-specific data dwords (see 7.2.4.4) which are scrambled (see 7.6) during an STP connection.

7.5 CRC

7.5.1 CRC overview

All frames include cyclic redundancy check (CRC) values to help detect transmission errors.

Frames transmitted in an STP connection shall include a CRC as defined by SATA (see SATA-2). Address frames, SSP frames, and SMP frames shall include a CRC as defined by this standard.

Annex D contains information on CRC generation/checker implementation.

Table 128 defines notation used in the following text describing CRC calculation. Arithmetic is modulo 2.

Table 128 — CRC notation and definitions (part 1 of 2)

Notation	Definition
$T(i)$	A transformation over the non-negative integers (i.e., Z^+): $T(i) = i + 7 - 2(i \bmod 8), i \geq 0, i \in Z^+$
$F(x)$	A polynomial representing the bits covered by the CRC: $F(x) = b_0x^{(k-1)} + b_1x^{(k-2)} + \dots + b_{(k-2)}x + b_{(k-1)}$ where: k is the number of bits b_i describes a bit, where the bit index i denotes that bit b_i is more significant than bit $b_{(i+1)}$ For example, if the frame, except for the CRC field, contains one data dword set to 516F3019h (i.e., $F(x) = 516F3019h$), then: $F(x) = x^{30} + x^{28} + x^{24} + x^{22} + x^{21} + x^{19} + x^{18} + x^{17} + x^{16} + x^{13} + x^{12} + x^4 + x^3 + x$ (i.e., $F(x) = 8AF60C98h$)
$F_t(x)$	$F(x)$ with the bit positions of each byte transposed (i.e., bit 7 is bit 0, bit 6 is bit 1, etc.): $F_t(x) = b_{T(0)}x^{(k-1)} + b_{T(1)}x^{(k-2)} + \dots + b_{T(k-2)}x + b_{T(k-1)}$ For example, if the frame, except for the CRC field, contains one data dword set to 516F3019h (i.e., $F(x) = 516F3019h$), then: $F_t(x) = x^{31} + x^{27} + x^{25} + x^{23} + x^{22} + x^{21} + x^{20} + x^{18} + x^{17} + x^{11} + x^{10} + x^7 + x^4 + x^3$ (i.e., $F_t(x) = 8AF60C98h$)

This page contains no comments

Table 128 — CRC notation and definitions (part 2 of 2)

Notation	Definition
$L(x)$	The identity polynomial of degree 31 (i.e., a polynomial with all of the coefficients set to one): $L(x) = x^{31} + x^{30} + \dots + x + 1$ (i.e., $L(x) = \text{FFFFFFFFh}$)
$G(x)$	The CRC generator polynomial (i.e., the divisor polynomial): $G(x) = x^{32} + x^{26} + x^{23} + x^{22} + x^{16} + x^{12} + x^{11} + x^{10} + x^8 + x^7 + x^5 + x^4 + x^2 + x + 1$ (i.e., $G(x) = 1_04C11DB7h$)
$R(x)$	The remainder polynomial, which is of degree less than 32.
$R_t(x)$	$R(x)$ with the bit positions of each byte transposed.
$Q(x)$	A quotient polynomial resulting from CRC calculation by the transmitter. This value is discarded.
$Q'(x)$	A quotient polynomial resulting from CRC calculation by the receiver. This value is discarded.
$M(x)$	A polynomial representing the transmitted frame including the CRC field, which is of degree $k+31$.
$M'(x)$	A polynomial representing the received frame including the received CRC field. If the received frame has no errors, then $M'(x) = M(x)$ and $M'(x)$ is of degree $k+31$.
$M'_t(x)$	$M'(x)$ with the bit positions of each byte transposed.
$R'(x)$	The result of finding the remainder of an error-free reception of $M(x)$, and also the remainder of $x^{32}L(x) / G(x)$, which is a unique constant polynomial: $R'(x) = x^{31} + x^{30} + x^{26} + x^{25} + x^{24} + x^{18} + x^{15} + x^{14} + x^{12} + x^{11} + x^{10} + x^8 + x^6 + x^5 + x^4 + x^3 + x + 1$ (i.e., $R'(x) = \text{C704DD7Bh}$)
$R'_t(x)$	$R'(x)$ with the bit positions of each byte transposed: $R'_t(x) = x^{28} + x^{27} + x^{26} + x^{23} + x^{22} + x^{20} + x^{19} + x^{18} + x^{17} + x^{16} + x^{14} + x^{10} + x^5 + 1$ (i.e., $R'_t(x) = 1\text{CDF4421h}$)

7.5.2 CRC generation

The CRC is calculated from $F(x)$ as follows:

$$x^k L(x) + x^{32} F_t(x) = Q(x) G(x) + R(x)$$

That is:

- 1) the frame $F(x)$, not including the CRC field, is transposed into $F_t(x)$;
- 2) the first 32 bits of the transposed frame are inverted (i.e., $x^k L(x)$ is added);
- 3) 32 bits of zero are appended to the end (i.e., $F_t(x)$ is multiplied by x^{32}); and
- 4) this result is divided by the generator polynomial $G(x)$ to find the remainder $R(x)$.

The transmitter shall present $M(x)$ to the 8b10b encoder:

$$M(x) = x^{32} F(x) + L(x) + R_t(x)$$

That is, the inverted transposed remainder is appended to the end of the frame, then this result (i.e., $M(x)$) is presented to the 8b10b encoder for transmission.

For the purposes of CRC computation, inverting the first 32 bits of a frame may be performed by one of the following methods:

- a) inverting the first 32 bits of the frame $F(x)$ and seeding the CRC remainder register with 00000000h;
- b) seeding the CRC remainder register with FFFFFFFFh; or
- c) prepending the constant 62F52692h to $F(x)$ and seeding the CRC remainder register with 00000000h.

This page contains no comments

NOTE 54 - The bit order of F(x) used to calculate the CRC is the same order as the bit transmission order (i.e., the bits within each byte encoded into a data dword are transposed to match the implicit transposition in the 8b10b encoding process).

Figure 169 shows the CRC process for an address frame, an SSP frame and SMP frame.

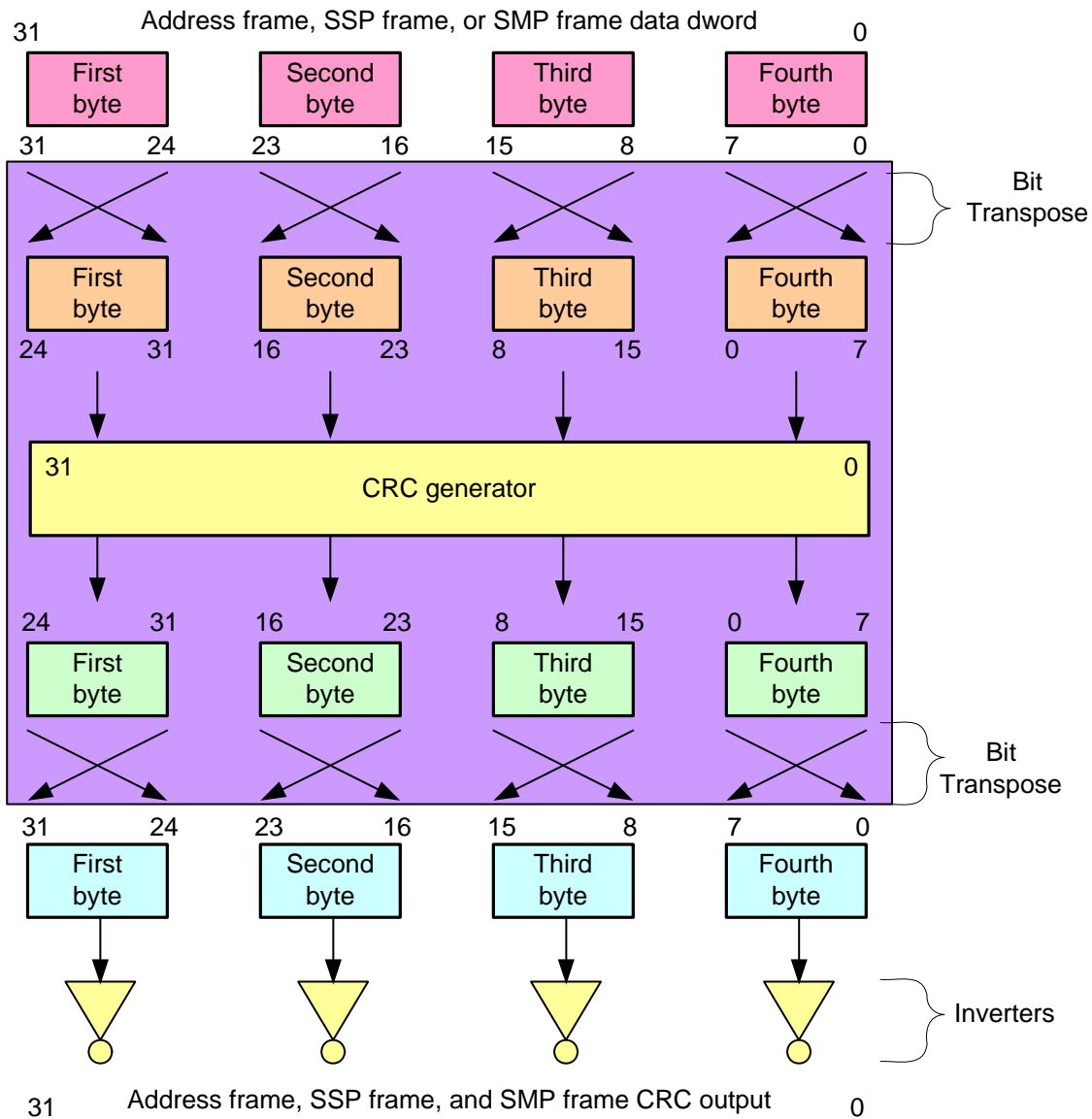

Figure 169 — Address frame, SSP frame, and SMP frame CRC bit ordering

This page contains no comments

Dwords in STP frames are little-endian and are fed into the STP CRC generator without swapping bits within each byte and without inverting the output like the SAS CRC generator. Figure 170 shows the STP CRC bit ordering.

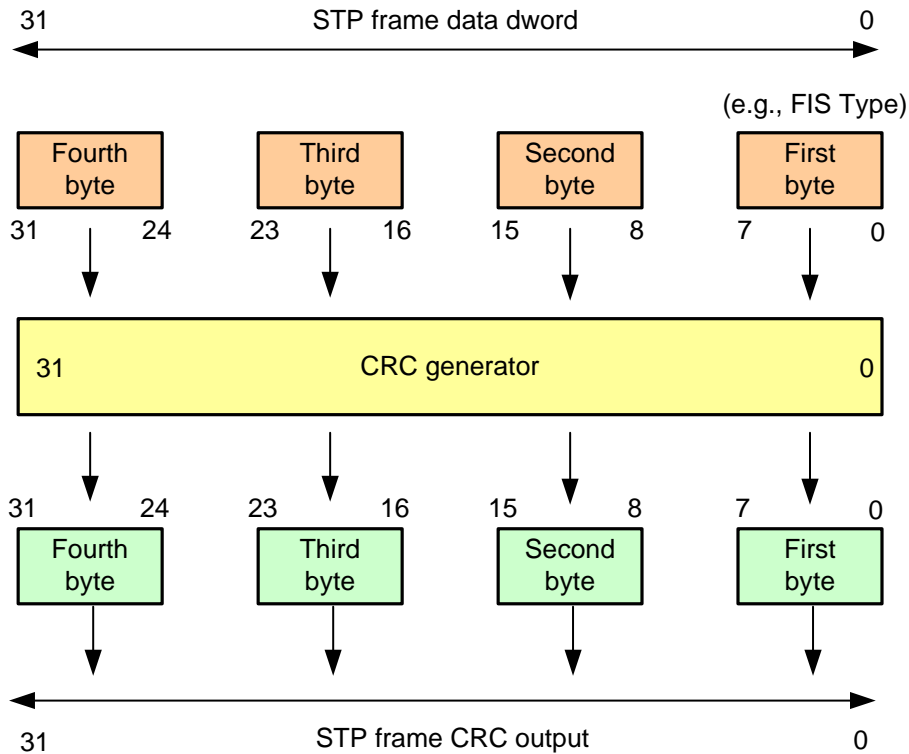

Figure 170 — STP frame CRC bit ordering

Since STP is little-endian, the first byte of a dword is in bits 7:0 rather than 31:24 as in SSP and SMP. As a result, the first byte contains the least-significant bit. In SSP and SMP, the first byte contains the most-significant bit.

See 7.7 for details on how the CRC generator fits into the dword flow along with the scrambler.

7.5.3 CRC checking

The CRC of received frame is calculated by the receiver in the same manner that it is generated by the transmitter.

That is:

- 1) the received frame $M'(x)$, including the CRC field, is transposed into $M_t'(x)$;
- 2) the first 32 bits of the received transposed frame are inverted;
- 3) 32 bits of zero are appended to the end; and
- 4) this result is divided by the generator polynomial $G(x)$ to find the remainder.

A received frame that has not incurred any CRC detectable errors during transmission generates a remainder equal to $R'(x)$.

If there were no transmission errors, then the received frame $M'(x)$ equals $M(x)$:

$$M'(x) = M(x) = x^{32}F(x) + L(x) + R_t(x)$$

The CRC $R'(x)$ is derived as follows:

$$\begin{aligned} x^{(k+32)}L(x) + x^{32}M_t'(x) &= x^{(k+32)}L(x) + x^{32}(x^{32}F_t(x) + L(x) + R(x)) \\ &= x^{32}Q(x)G(x) + x^{32}L(x) \end{aligned}$$

This page contains no comments

However, $G(x)$ divides $x^{32}L(x)$:

$$x^{32}L(x) = Q'(x)G(x) + R'(x)$$

Since $L(x)$ and $G(x)$ are known and constant, $R'(x)$ is known and constant and is expected by the receiver after calculating the CRC of a received frame.

From the previous two results:

$$x^{(k+32)}L(x) + x^{32}(x^{32}F_t(x) + L(x) + R(x)) = (x^{32}Q(x) + Q'(x))G(x) + R'(x)$$

$R'(x)$ is then transposed and inverted, in the same manner as is done by the transmitter, to obtain:

$$R_t'(x) + L(x) = 1CDF4421h$$

Alternatively to this process, the receiver may check the CRC validity of the frame by stripping off the last 32 bits, leaving $F(x)$, and calculating the CRC as defined in 7.5.2. The frame has a valid CRC if the result $L(x) + R_t(x)$ equals the last 32 bits of the frame which were stripped.

See 7.7 for details on where the CRC checker fits into the dword flow along with the descrambler.

7.6 Scrambling

Scrambling is used to reduce the probability of long strings of repeated patterns appearing on the physical link.

All data dwords are scrambled. Table 129 lists the scrambling for different types of data dwords.

Table 129 — Scrambling for different data dword types

Connection state	Data dword type	Description of scrambling
Outside connections	SAS idle dword	When a connection is not open and there are no other dwords to transmit, vendor-specific scrambled data dwords shall be transmitted.
	Address frame	After an SOAF, all data dwords shall be scrambled until the EOAF.
Inside SSP connection	SSP frame	After an SOF, all data dwords shall be scrambled until the EOF.
	SSP idle dword	When there are no other dwords to transmit, vendor-specific scrambled data dwords shall be transmitted.
Inside SMP connection	SMP frame	After an SOF, all data dwords shall be scrambled until the EOF.
	SMP idle dword	When there are no other dwords to transmit, vendor-specific scrambled data dwords shall be transmitted.
Inside STP connection	STP frame	After a SATA_SOF, all data dwords shall be scrambled until the SATA_EOF.
	Continued primitive	After a SATA_CONT, vendor-specific scrambled data dwords shall be transmitted until a primitive other than a deletable primitive is transmitted.

Data dwords being transmitted shall be XORed with a defined pattern to produce a scrambled value encoded and transmitted on the physical link. Received data dwords shall be XORed with the same pattern after decoding to produce the original data dword value, provided there are no transmission errors.

The pattern that is XORed with the data dwords is defined by the output of a linear feedback shift register implemented with the following polynomial:

$$G(x) = x^{16} + x^{15} + x^{13} + x^4 + 1.$$

Author: wdc-mevans

Subject: Highlight

Date: 5/6/2008 4:07:49 PM

T REJECT (only 2 things being ANDED)

open and

s/b

open, and

The output of the pattern generator is 16 bits wide. For each data **word** the output of the generator is applied to the lower 16 bits (i.e., bits 15 through 0) of the 32-bit data dword being **transmitted or received; the next output of the generator is applied to the upper 16 bits** (i.e., bits 31 through 16).

NOTE 55 - Scrambling is not based on data feedback, so the sequence of values XORed with the data being transmitted is constant.

The value of the linear feedback shift register shall be initialized at each SOF and SOAF to FFFFh.

For detailed requirements about scrambling of data dwords following SATA_SOF and SOF_CONT, see SATA-2.

NOTE 56 - STP scrambling uses two linear feedback shift registers, since continued primitive sequences may occur inside STP frames and the STP frame and the continued primitive sequence have independent scrambling patterns.

Annex F contains information on scrambling implementations.

● Author: RElliott
Subject: Underline
Date: 6/30/2008 6:16:52 PM
T ACCEPT - DONE

The output of the pattern generator is 16 bits wide. For each data dword the output of the generator is applied to the lower 16 bits (i.e., bits 15 through 0) of the 32-bit data dword being transmitted or received; the next output of the generator is applied to the upper 16 bits (i.e., bits 31 through 16).

s/b

The output of the pattern generator is 16 bits wide. For each data dword, two outputs of the pattern generator are used as follows:
a) the first output of the generator is applied to the lower 16 bits (i.e., bits 15 through 0) of the 32-bit data dword being transmitted or received; and
b) the second output of the generator is applied to the upper 16 bits (i.e., bits 31 through 16).

● Author: RElliott
Subject: Highlight
Date: 6/30/2008 6:16:52 PM
T ACCEPT - DONE

dword
s/b
dword,

● Author: Isi-gpenokie
Subject: Highlight
Date: 5/30/2008 5:51:44 PM
T REJECT (converted into an unordered list instead with other changes; new comment added)

This << transmitted or received; the next output of the generator is applied to the upper 16 bits >> should be << transmitted or received with the next output of the generator applied to the upper 16 bits >>

● Author: Isi-gpenokie
Subject: Highlight
Date: 5/6/2008 4:07:49 PM
T REJECT (This is just explanatory material and is of NOTE quality)

This note << NOTE 55 - Scrambling is not based >> should be made into normative text.

7.7 Bit order of CRC and scrambler

Figure 171 shows how data dwords and primitives are routed to the bit transmission logic in figure 134 (see 6.5). Data dwords go through the CRC generator and scrambler.

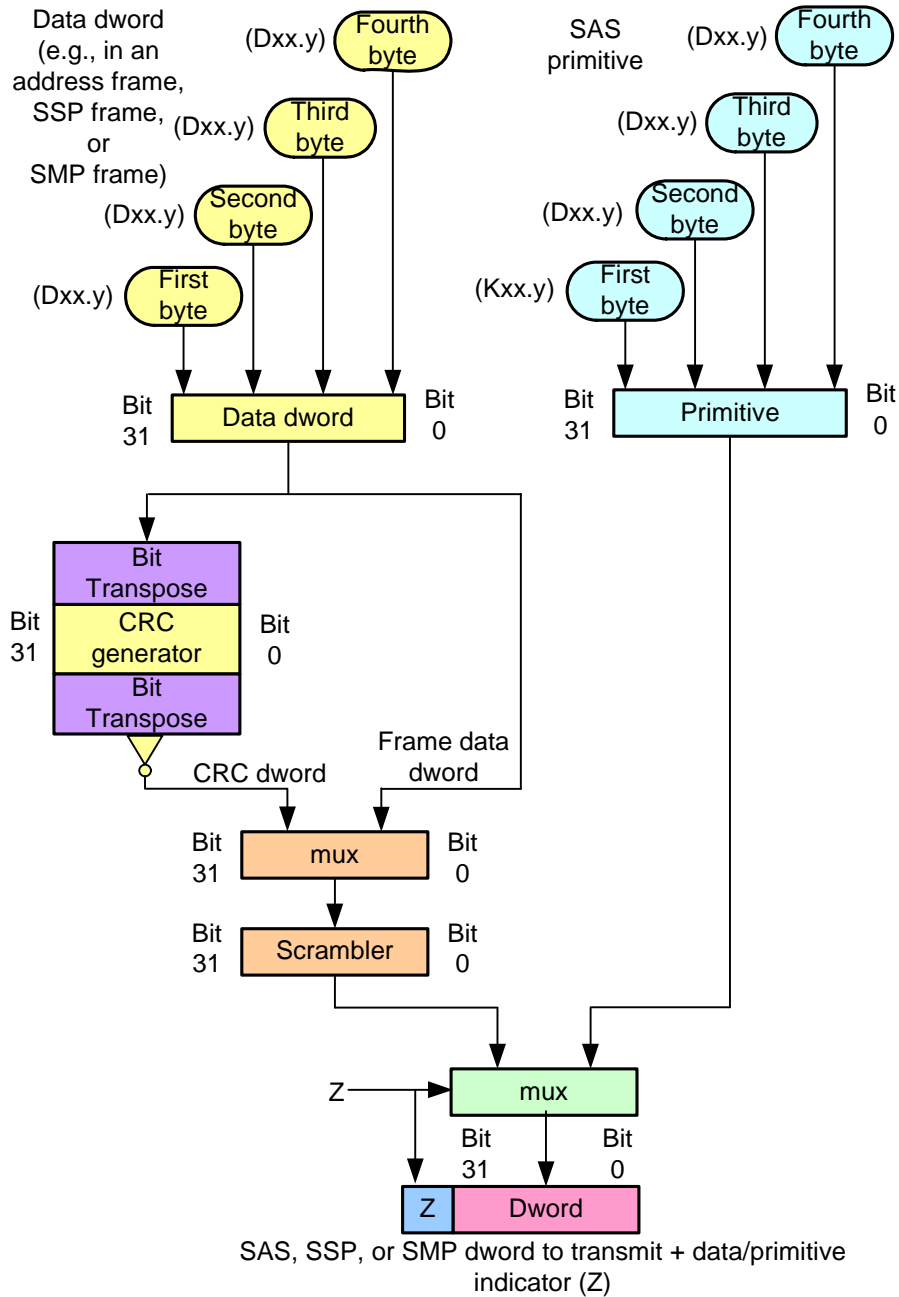

Figure 171 — Transmit path bit ordering

This page contains no comments

Figure 172 shows the routing of dwords received from the bit reception logic in figure 135 (see 6.5).

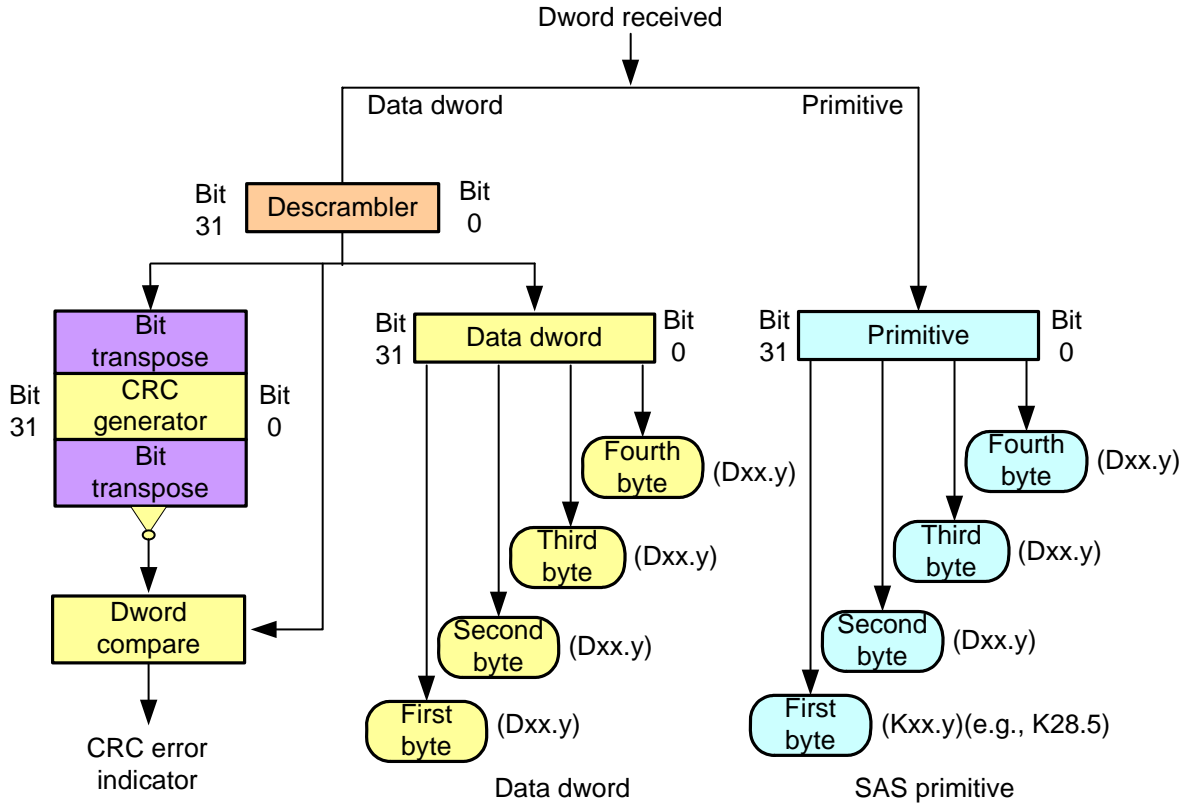

Figure 172 — Receive path bit ordering

This page contains no comments

Figure 173 shows the STP transmit path bit ordering.

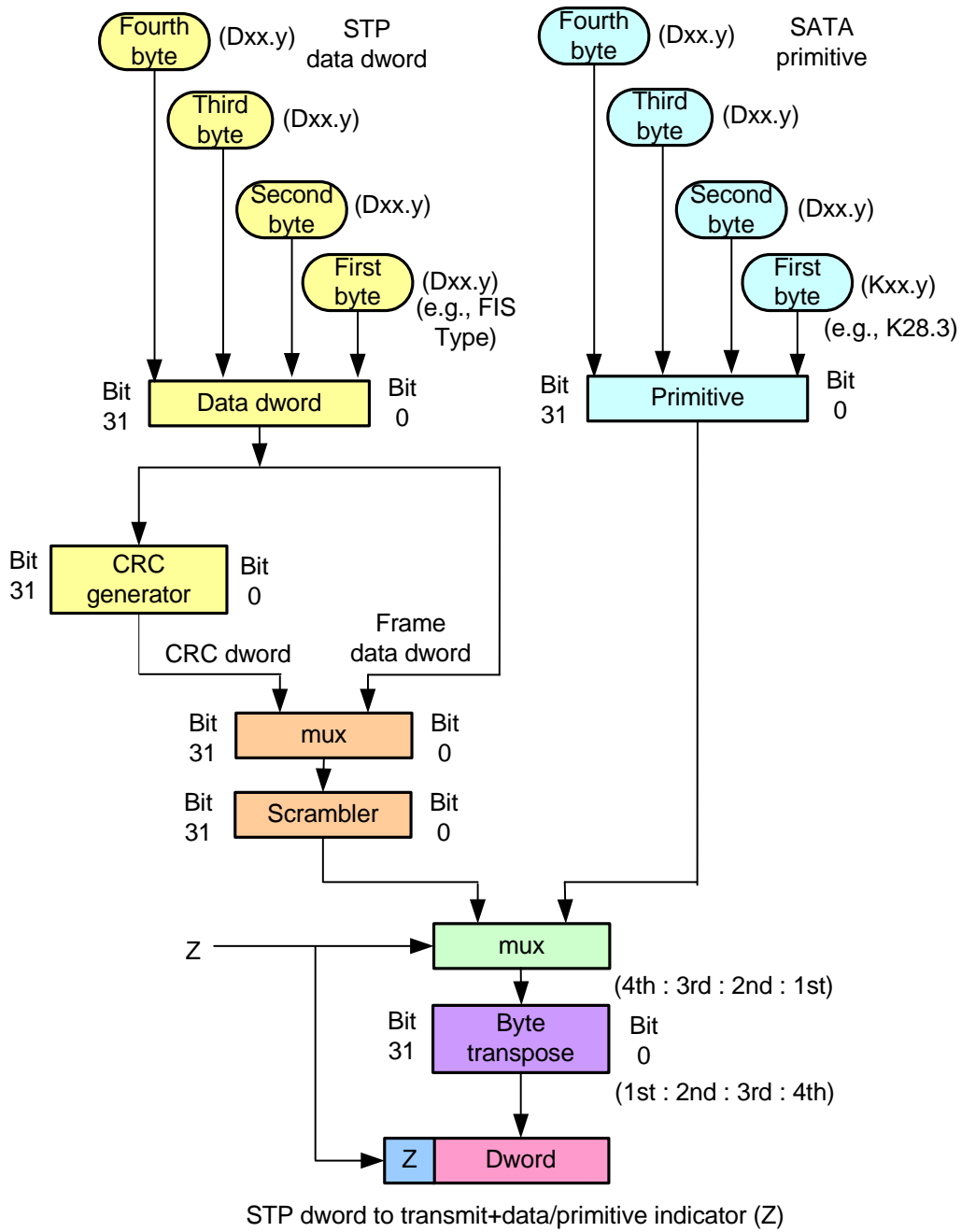

Figure 173 — STP transmit path bit ordering

This page contains no comments

Figure 174 shows the STP receive path bit ordering.

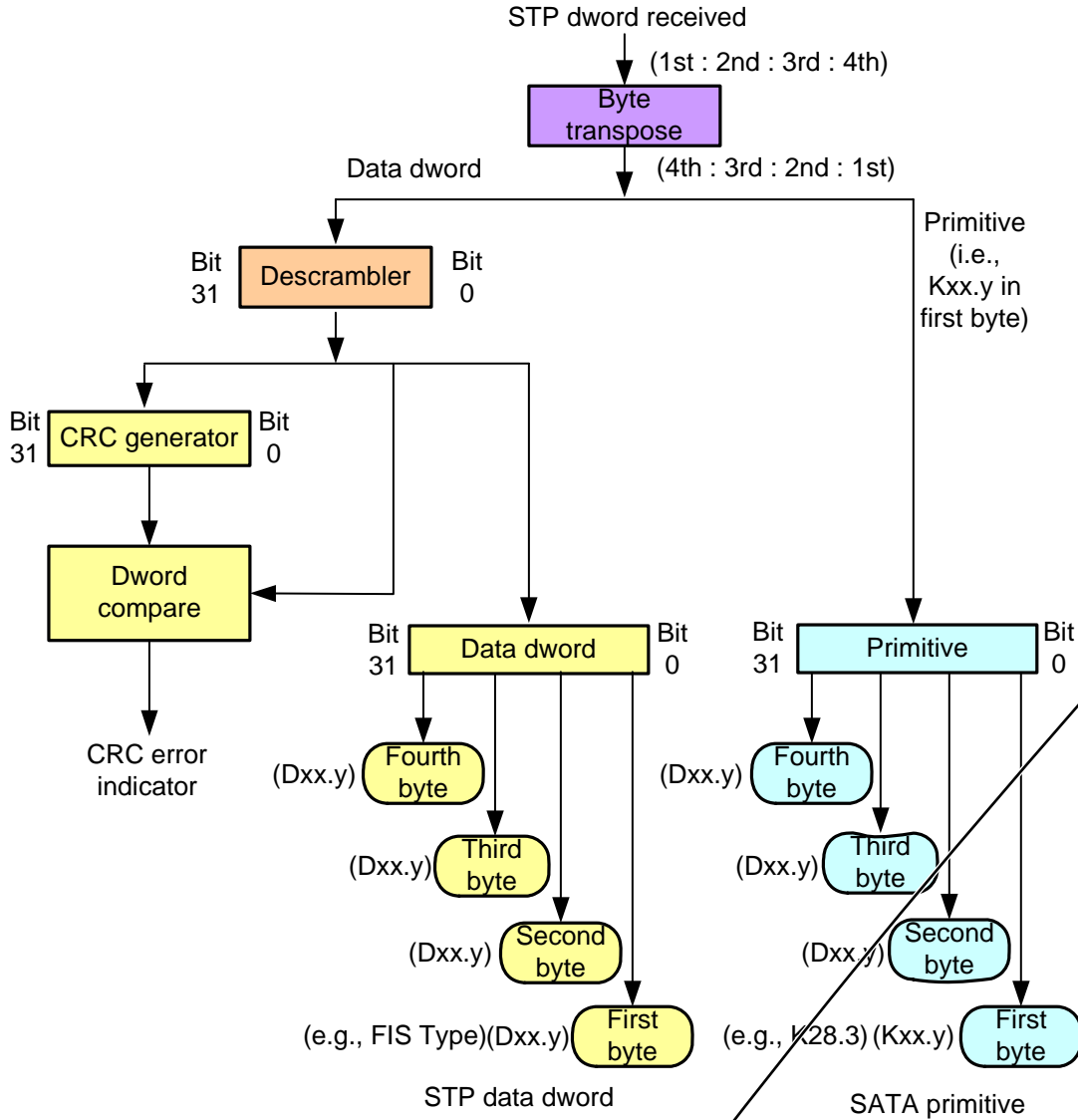

Figure 174 — STP receive path bit ordering

7.8 Address frames

7.8.1 Address frames overview

Address frames are used for the identification sequence and for connection requests. Address frames are preceded by SOAF and followed by EOAF as shows in figure 175.

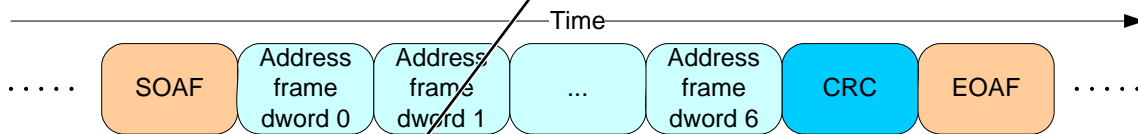

Figure 175 — Address frame transmission

Address frames shall only be sent outside connections. Address frames shall not be terminated early. All data dwords in an address frame shall be scrambled.

● Author: wdc-mevans

Subject: Highlight

Date: 5/30/2008 5:56:10 PM

T ACCEPT - DONE ("Partial address frames (i.e., not containing the number of data dwords defined for the frame) shall not be transmitted.")

Address frames shall not be terminated early.

s/b

When an address frame is transmitted, the number of data dwords defined for the frame shall be transmitted.

● Author: RElliott

Subject: Highlight

Date: 6/30/2008 6:16:52 PM

T ACCEPT - DONE

sent

s/b

transmitted

Table 130 defines the address frame format.

Table 130 — Address frame format

Byte/Bit	7	6	5	4	3	2	1	0
0					ADDRESS FRAME TYPE			
1	Frame type dependent bytes							
27								
28	(MSB)	CRC						
31								(LSB)

The ADDRESS FRAME TYPE field indicates the type of address frame and is defined in table 131. This field determines the definition of the frame type dependent bytes.

Table 131 — ADDRESS FRAME TYPE field

Code	Address frame type	Description
0h	IDENTIFY	Identification sequence
1h	OPEN	Connection request
All others	Reserved	

The CRC field contains a CRC value (see 7.5) that is computed over the entire address frame prior to the CRC field.

Address frames with unknown address frame types, incorrect lengths, or CRC errors shall be ignored by the recipient.

This page contains no comments

7.8.2 IDENTIFY address frame

Table 132 defines the IDENTIFY address frame format used for the identification sequence. The IDENTIFY address frame is sent by each logical phy after the phy reset sequence completes if the physical link is a SAS physical link. The IDENTIFY address frame sent by each logical phy in a physical phy shall be identical.

Table 132 — IDENTIFY address frame format

Byte\Bit	7	6	5	4	3	2	1	0	
0	Reserved	DEVICE TYPE			ADDRESS FRAME TYPE (0h)				
1	Reserved			REASON					
2	Reserved			SSP INITIATOR PORT	STP INITIATOR PORT	SMP INITIATOR PORT	Restricted (for OPEN address frame)		
3	Reserved			SSP TARGET PORT	STP TARGET PORT	SMP TARGET PORT	Restricted (for OPEN address frame)		
4	DEVICE NAME								
11	SAS ADDRESS								
12	PHY IDENTIFIER								
19	PHY IDENTIFIER								
20	PHY IDENTIFIER								
21	Reserved				INSIDE ZPSDS PERSISTENT	REQUESTED INSIDE ZPSDS	BREAK_REPLY CAPABLE		
22	Reserved								
27	Reserved								
28	(MSB)	CRC							
31							(LSB)		

The DEVICE TYPE field indicates the type of device containing the phy, and is defined in table 133.

Table 133 — DEVICE TYPE field

Code	Description
001b	End device
010b	Expander device
011b	Expander device compliant with a previous version of this standard
All others	Reserved

The ADDRESS FRAME TYPE field shall be set to 0h.

● Author: RElliott
Subject: Highlight
Date: 6/30/2008 6:16:52 PM
T ACCEPT - DONE
sent
s/b
transmitted

● Author: RElliott
Subject: Highlight
Date: 6/30/2008 6:16:52 PM
T ACCEPT - DONE
sent
s/b
transmitted

● Author: RElliott
Subject: Highlight
Date: 6/30/2008 6:16:52 PM
T ACCEPT - DONE
Oh
s/b
the value defined in table 132

The REASON field indicates the reason for the link reset sequence and is defined in table 134.

Table 134 — REASON field

Code	Description
0h	Unknown reason
1h	Power on
2h	Hard reset (e.g., phy received a HARD_RESET primitive during the hard reset sequence)(see 4.4.2), or SMP PHY CONTROL function HARD RESET phy operation (see 10.4.3.28)
3h	SMP PHY CONTROL function LINK RESET phy operation, or TRANSMIT SATA PORT SELECTION SIGNAL phy operation (see 10.4.3.28)
4h	Loss of dword synchronization (see 6.9)
5h	After the multiplexing sequence completes, MUX (LOGICAL LINK 0) received in logical link 1 or MUX (LOGICAL LINK 1) received in logical link 0 (see 6.10).
6h	I_T nexus loss timer expired in the STP target port of an STP/SATA bridge when the phy was attached to a SATA device (see 4.5)
7h	Break Timeout Timer expired (see 7.12.8)
8h	Phy test function stopped (see 10.4.3.29)
9h	Expander device reduced functionality (see 4.6.8)
Ah - Fh	Reserved

An SSP INITIATOR PORT bit set to one indicates that an SSP initiator port is present. An SSP INITIATOR PORT bit set to zero indicates that an SSP initiator port is not present. Expander devices shall set the SSP INITIATOR PORT bit to zero.

An STP INITIATOR PORT bit set to one indicates that an STP initiator port is present. An STP INITIATOR PORT bit set to zero indicates that an STP initiator port is not present. Expander devices shall set the STP INITIATOR PORT bit to zero.

An SMP INITIATOR PORT bit set to one indicates that an SMP initiator port is present. An SMP INITIATOR PORT bit set to zero indicates that an SMP initiator port is not present. Expander devices may set the SMP INITIATOR PORT bit to one.

An SSP TARGET PORT bit set to one indicates that an SSP target port is present. An SSP TARGET PORT bit set to zero indicates that an SSP target port is not present. Expander devices shall set the SSP TARGET PORT bit to zero.

An STP TARGET PORT bit set to one indicates that an STP target port is present. An STP TARGET PORT bit set to zero indicates that an STP target port is not present. Expander devices shall set the STP TARGET PORT bit to zero.

An SMP TARGET PORT bit set to one indicates that an SMP target port is present. An SMP TARGET PORT bit set to zero indicates that an SMP target port is not present. Expander devices shall set the SMP TARGET PORT bit to one.

The DEVICE NAME field indicates the device name (see 4.2.4) of the SAS device or expander device transmitting the IDENTIFY address frame. A DEVICE NAME field set to 00000000 00000000h indicates the device name is not provided in this field.

NOTE 57 - In expander devices, the DEVICE NAME field, if not set to 00000000 00000000h, contains the same value as the SAS ADDRESS field.

● Author: lsi-bbesmer

Subject: Note

Date: 6/28/2008 2:43:54 PM

 ACCEPT - DONE (5/5 accept the proposed wording)

Clarification needed on what to set REASON to for wide-ports?

For example, if have 4-wide port (Phys 0-3), and receive HR on Phy 0, is REASON set to 2 for all 4 phys, or just Phy 0?

Proposed wording from George Penokie:

Hard reset (e.g., the port containing this phy received a HARD_RESET primitive during the hard reset sequence)(see 4.4.2), or SMP PHY CONTROL function HARD RESET phy operation (see 10.4.3.28)

● Author: lsi-gpenokie

Subject: Highlight

Date: 5/6/2008 4:07:49 PM

 REJECT (this is just exhibiting a side-effect of the other rules. If upgraded into normative text, it would look like a special rule that needs to be followed)

This note << NOTE 57 - In expander devices, the >> should be made into normative text.

For SAS ports, the SAS ADDRESS field indicates the port identifier (see 4.2.7) of the SAS port transmitting the IDENTIFY address frame. For expander ports, the SAS ADDRESS field indicates the device name (see 4.2.4) of the expander device transmitting the IDENTIFY address frame.

The PHY IDENTIFIER field indicates the phy identifier of the phy transmitting the IDENTIFY address frame.

The REQUESTED INSIDE ZPSDS bit indicates the value of the REQUESTED INSIDE ZPSDS bit in the zone phy information (see 4.9.3.1) at the time the IDENTIFY address frame is transmitted. If the phy transmitting the IDENTIFY address frame is contained in an end device, a non-zoning expander device, or a zoning expander device with zoning disabled, then the REQUESTED INSIDE ZPSDS bit shall be set to zero.

The INSIDE ZPSDS PERSISTENT bit indicates the value of the INSIDE ZPSDS PERSISTENT bit in the zone phy information (see 4.9.3.1) at the time the IDENTIFY address frame is transmitted. If the phy transmitting the IDENTIFY address frame is contained in an end device, a non-zoning expander device, or a zoning expander device with zoning disabled, then the INSIDE ZPSDS PERSISTENT bit shall be set to zero.

The BREAK_REPLY CAPABLE field indicates that the phy is capable of responding to received BREAK primitive sequences with a BREAK_REPLY primitive sequence (see 7.12.5).

See 4.1.4 for additional requirements concerning the DEVICE TYPE field, SSP INITIATOR PORT bit, STP INITIATOR PORT bit, SMP INITIATOR PORT bit, SSP TARGET PORT bit, STP TARGET PORT bit, SMP TARGET PORT bit, and SAS ADDRESS field.

The CRC field is defined in 7.8.1.

● Author: Isi-bbesmer
Subject: Highlight
Date: 5/25/2008 8:36:28 PM
T ACCEPT - DONE

DEVICE TYPE field,
s/b
DEVICE TYPE field, BREAK_REPLY CAPABLE bit,

● Author: RElliott
Subject: Highlight
Date: 6/30/2008 6:16:52 PM
T ACCEPT - DONE

bit,
s/b
bit, the

several times in this paragraph

7.8.3 OPEN address frame

Table 135 defines the OPEN address frame format used for connection requests.

Table 135 — OPEN address frame format

Byte/Bit	7	6	5	4	3	2	1	0
0	INITIATOR PORT	PROTOCOL			ADDRESS FRAME TYPE (1h)			
1	FEATURES				CONNECTION RATE			
2	(MSB)	INITIATOR CONNECTION TAG						(LSB)
3								
4								
11	DESTINATION SAS ADDRESS							
12								
19	SOURCE SAS ADDRESS							
20	SOURCE ZONE GROUP							
21	PATHWAY BLOCKED COUNT							
22	(MSB)	ARBITRATION WAIT TIME						(LSB)
23								
24								
27	MORE COMPATIBLE FEATURES							
28	(MSB)	CRC						(LSB)
31								

An INITIATOR PORT bit set to one specifies that the source port is acting as a SAS initiator port. An INITIATOR PORT bit set to zero specifies that the source port is acting as a SAS target port. If a SAS target/initiator port sets the INITIATOR PORT bit to one, it shall operate only in its initiator role during the connection. If a SAS target/initiator port sets the INITIATOR PORT bit to zero, it shall operate only in its target role during the connection.

If a SAS target/initiator port accepts an OPEN address frame with the INITIATOR PORT bit set to one, it shall operate only in its target role during the connection. If a SAS target/initiator port accepts an OPEN address frame with the INITIATOR PORT bit set to zero, it shall operate only in its initiator role during the connection.

● Author: lsi-gpenokie
Subject: Highlight
Date: 5/25/2008 8:36:47 PM

T ACCEPT - DONE

This << If a SAS target/initiator port sets the INITIATOR PORT bit to one >> should be << If a SAS port sets the INITIATOR PORT bit to one >>

● Author: lsi-gpenokie
Subject: Highlight
Date: 5/25/2008 8:36:56 PM

T ACCEPT - DONE

This << If a SAS target/initiator port sets the INITIATOR PORT bit to >> should be << If a SAS port sets the INITIATOR PORT bit to >>

● Author: lsi-gpenokie
Subject: Highlight
Date: 5/25/2008 8:37:04 PM

T ACCEPT - DONE

This << If a SAS target/initiator port accepts an >> should be << If a SAS port accepts an >>

● Author: lsi-gpenokie
Subject: Highlight
Date: 5/25/2008 8:37:11 PM

T ACCEPT - DONE

This << If a SAS target/initiator port accepts >> should be << If a SAS port accepts >>

The PROTOCOL field specifies the protocol for the connection being requested and is defined in table 136.

Table 136 — PROTOCOL field

Code	Description
000b	SMP
001b	SSP
010b	STP
All others	Reserved

The ADDRESS FRAME TYPE field shall be set to 1h.

The FEATURES field specifies any additional features that are incompatible with previous versions of this standard and is defined in table 137.

Table 137 — FEATURES field

Code	Description
0h	No additional features
All others	Reserved

The CONNECTION RATE field specifies the connection rate (see 4.1.12) being requested between the source and destination, and is defined in table 138.

Table 138 — CONNECTION RATE field

Code	Description
8h	1.5 Gbps
9h	3 Gbps
Ah	6 Gbps
Bh - Fh	Reserved for future connection rates
All others	Reserved

A SAS initiator port shall set the initial CONNECTION RATE field to:

- the highest supported connection rate supported by a potential pathway as determined during the discover process (e.g., based on the logical link rates of each logical link reported in the SMP DISCOVER responses); or
- the logical link rate of the logical phy used to transmit the OPEN address frame.

If a SAS initiator port selected a connection rate based on discover process information but the connection request results in OPEN_REJECT (CONNECTION RATE NOT SUPPORTED), the discover process information is no longer current and should be run again.

A SAS target port shall set the initial CONNECTION RATE field to:

- the last known good connection rate established with the SAS initiator port; or
- for the first frame it intends to transmit in the connection, the connection rate that was used by the SAS initiator port to deliver the command or task management function for that frame.

Each time a connection request with a connection rate greater than 1.5 Gbps results in OPEN_REJECT (CONNECTION RATE NOT SUPPORTED), the SAS port shall reattempt the connection request with a lower

● Author: RElliott
Subject: Highlight
Date: 6/30/2008 6:16:52 PM
T ACCEPT - DONE

1h
s/b
the value defined in table 135

● Author: RElliott
Subject: Highlight
Date: 6/30/2008 6:16:52 PM
T ACCEPT - DONE

the
s/b
then the

● Author: wdc-mevans
Subject: Highlight
Date: 5/25/2008 8:37:32 PM
T ACCEPT - DONE ("and the discover process should")

and should
s/b
and the process should

● Author: wdc-mevans
Subject: Highlight
Date: 5/25/2008 8:38:27 PM
T REJECT (first noun/subject convention)

it
s/b
the SAS target port

● Author: lsi-gpenokie
Subject: Highlight
Date: 5/25/2008 8:38:22 PM
T REJECT (first noun/subject convention)

This << frame it intends to transmit >> should be << frame the SAS target port intends to transmit >>

● Author: wdc-mevans
Subject: Highlight
Date: 5/25/2008 8:41:22 PM
T REJECT (7.12.2.2 uses the word "results")

Each time a connection request with a connection rate greater than 1.5 Gbps results in OPEN_REJECT (CONNECTION RATE NOT SUPPORTED),
s/b
Each time a SAS port receives an OPEN_REJECT (CONNECTION RATE NOT SUPPORTED) in response to a connection request including a connection rate greater than 1.5 Gbps,

connection rate (e.g., drop from 6 Gbps to 3 Gbps or 1.5 Gbps) and send the same frames in the resulting connection that it intended to send at the initial connection rate.

The INITIATOR CONNECTION TAG field is used for SSP and STP connection requests to provide a SAS initiator port an alternative to using the SAS target port's SAS address for context lookup when the SAS target port originates a connection request. SSP or STP initiator ports shall set the INITIATOR CONNECTION TAG field to FFFFh if they do not require the field be provided by the SAS target port. If they do require the field to be provided, an SSP or STP initiator port should set the INITIATOR CONNECTION TAG field to a unique value per SAS target port. When requesting a connection to a SAS initiator port, a SAS target port shall set the INITIATOR CONNECTION TAG field to the most recent value received or the value received in one of the connection requests for one of the outstanding commands or task management functions from the SAS initiator port. A SAS initiator port shall use the same INITIATOR CONNECTION TAG field value for all connection requests to the same SAS target port, and shall only change the INITIATOR CONNECTION TAG field value when it has no commands or task management functions outstanding to that SAS target port. SAS target ports are not required to check consistency of the INITIATOR CONNECTION TAG field in different connection requests from the same SAS initiator port. SMP initiator ports shall set the INITIATOR CONNECTION TAG field to FFFFh for SMP connection requests.

The DESTINATION SAS ADDRESS field specifies the port identifier (see 4.2.7) of the SAS port to which a connection is being requested.

The SOURCE SAS ADDRESS field specifies the port identifier (see 4.2.7) of the SAS port that originated the OPEN address frame.

The SOURCE ZONE GROUP field identifies the zone group of the phy making the connection request. ~~Zone group values between 128 and 255, inclusive, are reserved.~~ The SOURCE ZONE GROUP field shall be:

- a) set to zero when transmitted by an end device;
- b) set to zero when transmitted by an expander device on a phy with the INSIDE ZPSDS bit set to zero;
- c) set to the source zone group for the outgoing connection request as described in table 33 (see 4.9.3.5) when transmitted by an expander device on a phy with the INSIDE ZPSDS bit set to one;
- d) ignored when received by an end device;
- e) ignored when received by an expander device on a phy with the INSIDE ZPSDS bit set to zero; and
- f) used to determine the source zone group for the incoming connection request as described in table 33 (see 4.9.3.5) when received by an expander device on a phy with the INSIDE ZPSDS bit set to one.

The PATHWAY BLOCKED COUNT field specifies the number of times the port has retried this connection request due to receiving OPEN_REJECT (PATHWAY BLOCKED), OPEN_REJECT (RESERVED STOP 0), or OPEN_REJECT (RESERVED STOP 1). The port shall not increment the PATHWAY BLOCKED COUNT value past FFh. If the port changes connection requests, it shall set the PATHWAY BLOCKED COUNT field to 00h.

The ARBITRATION WAIT TIME field specifies how long the port transmitting the OPEN address frame has been waiting for a connection request to be accepted or rejected. This time is maintained by the port layer in an Arbitration Wait Time timer (see 8.2.2). For values from 0000h to 7FFFh, the Arbitration Wait Time timer increments in one microsecond steps. For values from 8000h to FFFFh, the Arbitration Wait Time timer

Page: 332

● Author: wdc-mevans
Subject: Highlight
Date: 5/30/2008 5:57:06 PM
T ACCEPT - DONE

it
s/b
the SAS port

● Author: lsi-gpenokie
Subject: Highlight
Date: 5/30/2008 5:57:20 PM
T ACCEPT - DONE

This << connection that it intended to send at the >> should be << connection that the SAS port intended to send at the >>

● Author: RElliott
Subject: Highlight
Date: 8/27/2008 5:50:24 PM
T ACCEPT - DONE

they

Change this sentence to singular, and add a "then" for the "if"

● Author: wdc-mevans
Subject: Highlight
Date: 5/30/2008 5:58:24 PM
T ACCEPT - DONE ("that this field be")

field be
s/b
field to be

● Author: RElliott
Subject: Highlight
Date: 8/27/2008 5:45:39 PM
T ACCEPT - DONE

they

Reword paragraph as singular

● Author: lsi-gpenokie
Subject: Highlight
Date: 5/30/2008 5:59:24 PM
T REJECT ("per" is used many times)

This << unique value per SAS target port >> should be << unique value for each SAS target port >>

● Author: wdc-mevans
Subject: Highlight
Date: 5/30/2008 6:00:00 PM
T REJECT (first noun/subject convention)

it
s/b
the SAS initiator port

● Author: lsi-gpenokie
Subject: Highlight

Comments from page 332 continued on next page

connection rate (e.g., drop from 6 Gbps to 3 Gbps or 1.5 Gbps) and send the same frames in the resulting connection that it intended to send at the initial connection rate.

The INITIATOR CONNECTION TAG field is used for SSP and STP connection requests to provide a SAS initiator port an alternative to using the SAS target port's SAS address for context lookup when the SAS target port originates a connection request. SSP or STP initiator ports shall set the INITIATOR CONNECTION TAG field to FFFFh if they do not require the field be provided by the SAS target port. If they do require the field to be provided, an SSP or STP initiator port should set the INITIATOR CONNECTION TAG field to a unique value per SAS target port. When requesting a connection to a SAS initiator port, a SAS target port shall set the INITIATOR CONNECTION TAG field to the most recent value received or the value received in one of the connection requests for one of the outstanding commands or task management functions from the SAS initiator port. A SAS initiator port shall use the same INITIATOR CONNECTION TAG field value for all connection requests to the same SAS target port, and shall only change the INITIATOR CONNECTION TAG field value when it has no commands or task management functions outstanding to that SAS target port. SAS target ports are not required to check consistency of the INITIATOR CONNECTION TAG field in different connection requests from the same SAS initiator port. SMP initiator ports shall set the INITIATOR CONNECTION TAG field to FFFFh for SMP connection requests.

The DESTINATION SAS ADDRESS field specifies the port identifier (see 4.2.7) of the SAS port to which a connection is being requested.

The SOURCE SAS ADDRESS field specifies the port identifier (see 4.2.7) of the SAS port that originated the OPEN address frame.

The SOURCE ZONE GROUP field identifies the zone group of the phy making the connection request. ~~Zone group values between 128 and 255, inclusive, are reserved.~~ The SOURCE ZONE GROUP field shall be:

- a) set to zero when transmitted by an end device;
- b) set to zero when transmitted by an expander device on a phy with the INSIDE ZPSDS bit set to zero;
- c) set to the source zone group for the outgoing connection request as described in table 33 (see 4.9.3.5) when transmitted by an expander device on a phy with the INSIDE ZPSDS bit set to one;
- d) ignored when received by an end device;
- e) ignored when received by an expander device on a phy with the INSIDE ZPSDS bit set to zero; and
- f) used to determine the source zone group for the incoming connection request as described in table 33 (see 4.9.3.5) when received by an expander device on a phy with the INSIDE ZPSDS bit set to one.

The PATHWAY BLOCKED COUNT field specifies the number of times the port has retried this connection request due to receiving OPEN_REJECT (PATHWAY BLOCKED), OPEN_REJECT (RESERVED STOP 0), or OPEN_REJECT (RESERVED STOP 1). The port shall not increment the PATHWAY BLOCKED COUNT value past FFh. If the port changes connection requests, it shall set the PATHWAY BLOCKED COUNT field to 00h.

The ARBITRATION WAIT TIME field specifies how long the port transmitting the OPEN address frame has been waiting for a connection request to be accepted or rejected. This time is maintained by the port layer in an Arbitration Wait Time timer (see 8.2.2). For values from 0000h to 7FFFh, the Arbitration Wait Time timer increments in one microsecond steps. For values from 8000h to FFFFh, the Arbitration Wait Time timer

Date: 5/30/2008 6:01:03 PM

T REJECT (first noun/subject convention means "it" is "A SAS initiator port." If you read the rest of the sentence, you should see that "SAS target port...to that SAS target port" would make no sense)

This << value when it has no >> should be << value when that SAS target port has no >>

● Author: wdc-mevans

Subject: Highlight

Date: 8/27/2008 5:50:00 PM

T ACCEPT - DONE (7/17 change to an a)b) list

not logically ANDing here, so comma + and is OK for independent clauses)

port, and

s/b

port and

● Author: lsi-bbesmer

Subject: Cross-Out

Date: 5/6/2008 4:07:49 PM

T ACCEPT - DONE

T Zone group values between 128 and 255, inclusive, are reserved.

Proposal 07-017r2 SAS-2 SAS-2 More zone groups (Steve Johnson, LSI Logic)

● Author: RElliott

Subject: Highlight

Date: 6/30/2008 6:16:52 PM

T ACCEPT - DONE

zero

s/b

00h

● Author: RElliott

Subject: Highlight

Date: 6/30/2008 6:16:52 PM

T ACCEPT - DONE

zero

s/b

00h

● Author: lsi-gpenokie

Subject: Highlight

Date: 5/6/2008 4:07:49 PM

T ACCEPT - DONE

This << and >> should be << or >> as only one case is true not all.

increments in one millisecond steps. The maximum value represents 32 767 ms + 32 768 μ s. Table 139 describes several values of the ARBITRATION WAIT TIME field. See 7.12.3 for details on arbitration fairness.

Table 139 — ARBITRATION WAIT TIME field

Code	Description
0000h	0 μ s
0001h	1 μ s
...	...
7FFFh	32 767 μ s
8000h	0 ms + 32 768 μ s
8001h	1 ms + 32 768 μ s
...	...
FFFFh	32 767 ms + 32 768 μ s

The MORE COMPATIBLE FEATURES field shall be set to zero. The destination phy shall ignore the MORE COMPATIBLE FEATURES field.

The CRC field is defined in 7.8.1.

7.9 Identification and hard reset sequence

7.9.1 Identification and hard reset sequence overview

After the phy reset sequence (see 6.7) has been completed indicating the physical link is using SAS rather than SATA, each logical phy either:

- a) performs an identification sequence by transmitting one or three IDENTIFY address frames (see 7.8.2); or
- b) performs a hard reset sequence by transmitting a HARD_RESET primitive sequence (see 7.2.6.8).

~~If multiplexing (see 6.10) is enabled (see table 100 in 6.7.4.2.3.3), the identification sequence and hard reset sequence begin with a multiplexing sequence (see 6.7.4.3).~~

Author: RElliott
Subject: Highlight
Date: 6/30/2008 6:16:52 PM
T ACCEPT - DONE

The destination phy shall ignore
s/b
A phy receiving an OPEN address frame

Author: RElliott
Subject: Highlight
Date: 6/30/2008 6:16:52 PM
T ACCEPT - DONE

zero
s/b
the value defined in table 135

and add "(00000000h)" to table 135

Author: RElliott
Subject: Highlight
Date: 6/30/2008 6:16:52 PM
T ACCEPT - DONE

7.9 Identification and hard reset sequence

Rename this to "7.9 Link reset sequence".
Move the SL_IR state machine subclause to the 7.xx level.
Rename 7.9.1 as well.

Chapter 6 defines the phy reset sequence, so chapter 7 should define the link reset sequence. Currently, chapter 4 is the only place that defines "link reset sequence".

Author: RElliott
Subject: Cross-Out
Date: 6/30/2008 6:16:52 PM
~~T~~ ACCEPT - DONE

Deleted "If multiplexing (see 6.10) is enabled (see table 100 in 6.7.4.2.3.3), the identification sequence and hard reset sequence begin with a multiplexing sequence (see 6.7.4.3)." per lsi-bday comment

Author: RElliott
Subject: Highlight
Date: 6/30/2008 6:16:52 PM
T ACCEPT - DONE

the
s/b
then the

Author: lsi-bday
Subject: Highlight
Date: 5/25/2008 8:43:28 PM
T ACCEPT - DONE

(deleting the entire paragraph solves the problem. This was leftover when the multiplexing sequence was not part of the phy reset sequence defined in 6.7; now that it is defined there, this paragraph is unnecessary. The previous paragraph uses the term "logical phy" correctly, implying that multiplexing was already negotiated.)

begin

increments in one millisecond steps. The maximum value represents 32 767 ms + 32 768 μ s. Table 139 describes several values of the ARBITRATION WAIT TIME field. See 7.12.3 for details on arbitration fairness.

Table 139 — ARBITRATION WAIT TIME field

Code	Description
0000h	0 μ s
0001h	1 μ s
...	...
7FFFh	32 767 μ s
8000h	0 ms + 32 768 μ s
8001h	1 ms + 32 768 μ s
...	...
FFFFh	32 767 ms + 32 768 μ s

The MORE COMPATIBLE FEATURES field shall be set to zero. The destination phy shall ignore the MORE COMPATIBLE FEATURES field.

The CRC field is defined in 7.8.1.

7.9 Identification and hard reset sequence

7.9.1 Identification and hard reset sequence overview

After the phy reset sequence (see 6.7) has been completed indicating the physical link is using SAS rather than SATA, each logical phy either:

- a) performs an identification sequence by transmitting one or three IDENTIFY address frames (see 7.8.2); or
- b) performs a hard reset sequence by transmitting a HARD_RESET primitive sequence (see 7.2.6.8).

~~If multiplexing (see 6.10) is enabled (see table 100 in 6.7.4.2.3.3), the identification sequence and hard reset sequence begin with a multiplexing sequence (see 6.7.4.3).~~

s/b
is preceded by

Muxxing sequence is not part of (begins) the id or hard reset sequence.. it's part of the phy reset sequence.

Figure 176 shows two phys with multiplexing disabled performing the identification sequence. Only one IDENTIFY address frame is shown in this example.

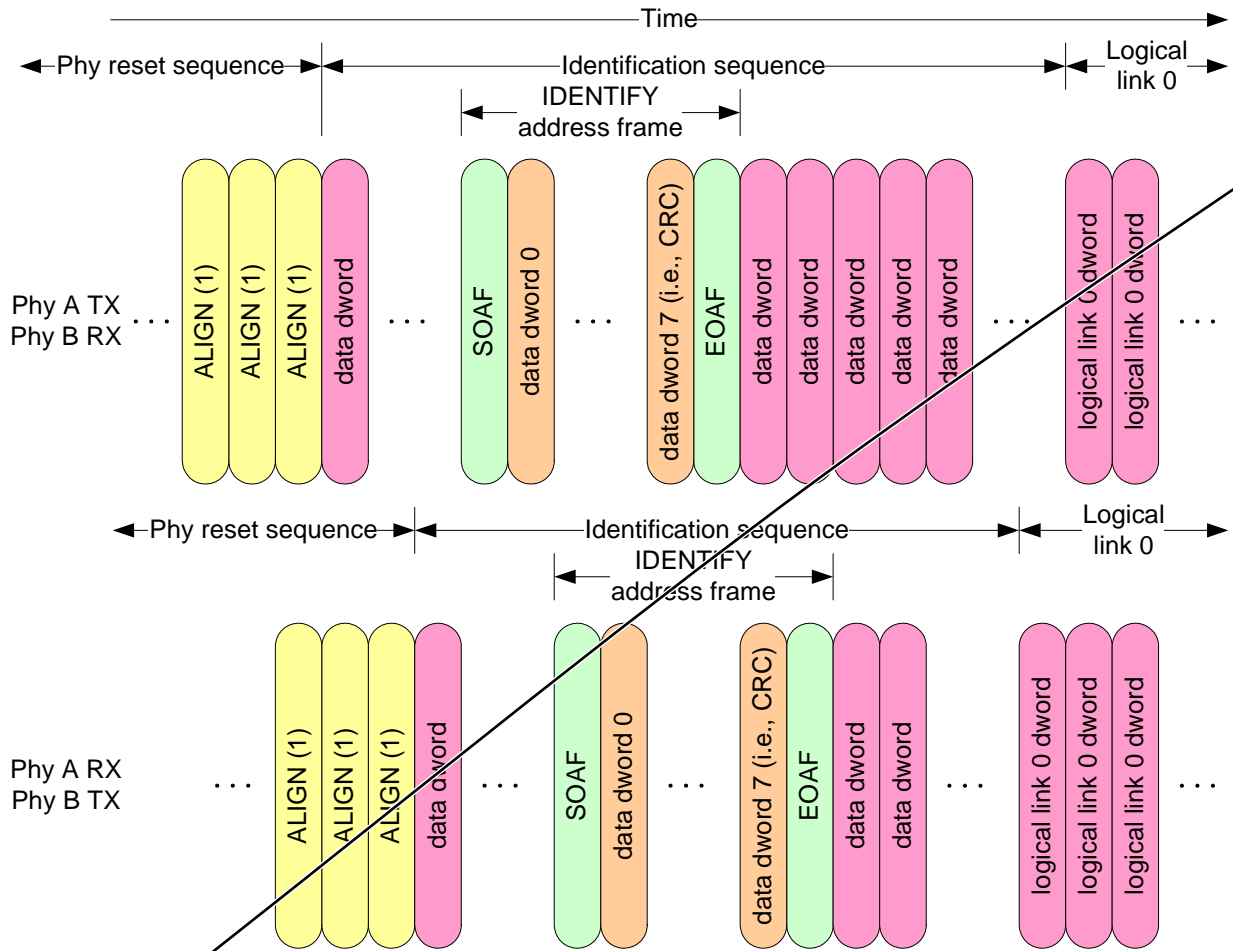

NOTE: Phys transmit deletable primitives for physical link rate tolerance management after the phy reset sequence.

Figure 176 — Identification sequence

Author: RElliott
Subject: Highlight
Date: 8/27/2008 5:51:07 PM
ACCEPT - DONE



NOTE
s/b
Note

Figure 177 shows phy A performing the identification sequence and phy B performing the hard reset sequence. Multiplexing is disabled and only one IDENTIFY address frame is shown in this example.

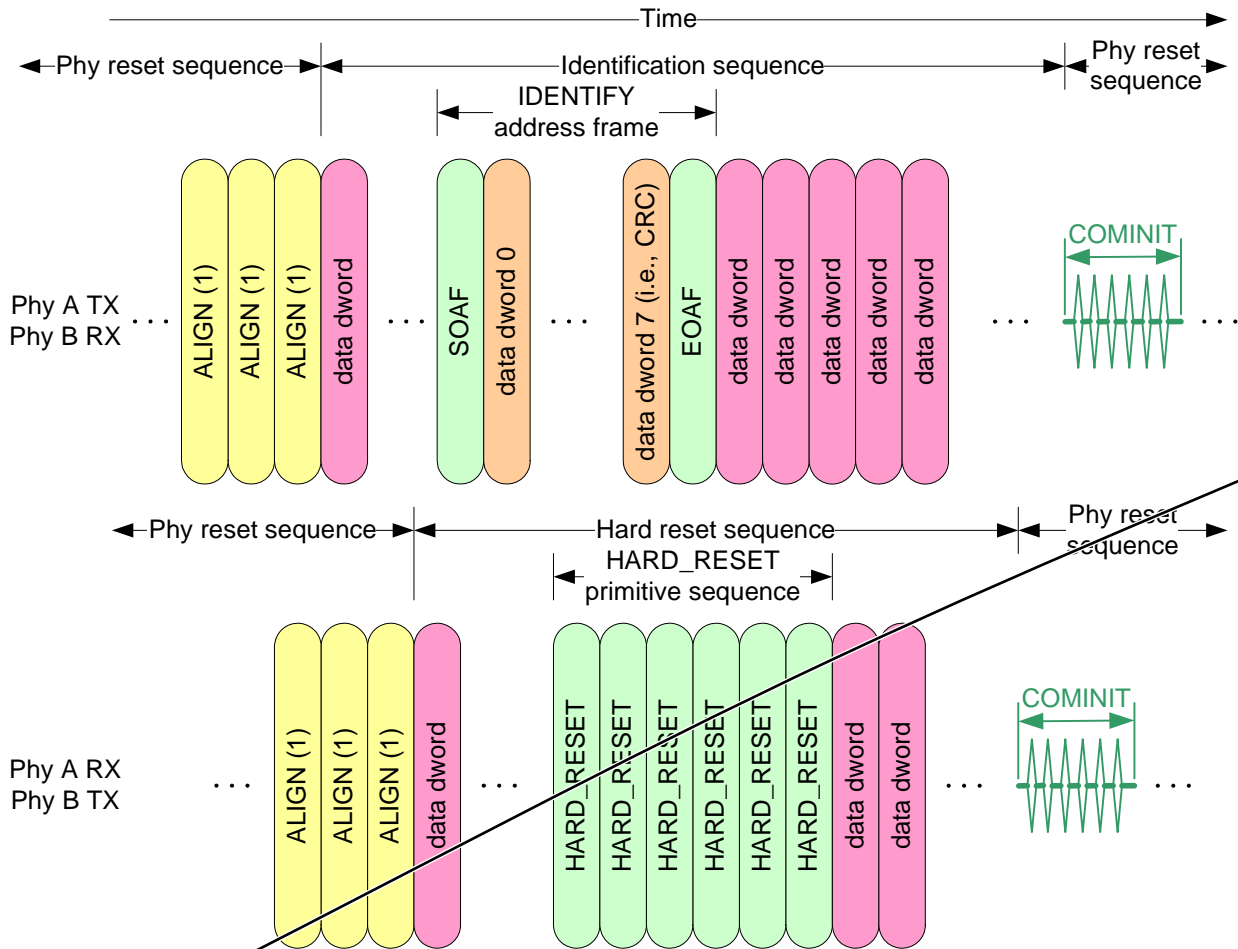

NOTE: Phys transmit deletable primitives for physical link rate tolerance management after the phy reset sequence.

Figure 177 — Hard reset sequence

Each logical phy receives an IDENTIFY address frame or a HARD_RESET primitive sequence from the logical phy to which it is attached. The combination of a phy reset sequence, an optional hard reset sequence followed by another phy reset sequence, and an identification sequence is called a link reset sequence (see 4.4.1).

If a phy receives a valid IDENTIFY address frame within 1 ms of phy reset sequence completion, the SAS address in the outgoing IDENTIFY address frame(s) and the SAS address in the incoming IDENTIFY address frame determine the port to which a phy belongs (see 4.1.4). The phy ignores subsequent IDENTIFY address frames and HARD_RESET primitives until another phy reset sequence occurs.

If a phy receives a HARD_RESET primitive sequence within 1 ms of phy reset sequence completion, it shall be considered a reset event and cause a hard reset (see 4.4.2) of the port containing that phy.

If a phy does not receive a HARD_RESET primitive sequence or a valid IDENTIFY address frame within 1 ms of phy reset sequence completion, it shall restart the phy reset sequence.

7.9.2 SAS initiator device rules

After a link reset sequence, or after receiving a Broadcast (Change), a management application client behind an SMP initiator port should perform a discover process (see 4.7).

Author: RElliott
Subject: Underline
Date: 6/30/2008 6:16:52 PM
T ACCEPT - DONE

A performing the identification sequence and phy B performing the hard reset sequence

s/b

phy A attempting to perform the identification sequence and phy B performing the hard reset sequence. Because phy A receives a HARD_RESET primitive sequence, a hard reset sequence actually occurs.

"identification sequence" usually means both transmit and receive of an IDENTIFY address frame, not just transmit. The new wording better agrees with this convention.

Author: RElliott
Subject: Highlight
Date: 8/27/2008 5:51:47 PM
T ACCEPT - DONE

NOTE

s/b

Note

Author: RElliott
Subject: Underline
Date: 6/30/2008 6:16:52 PM
T ACCEPT - DONE

Change:

The combination of a phy reset sequence, an optional hard reset sequence followed by another phy reset sequence, and an identification sequence is called a link reset sequence (see 4.4.1).

to this (and move it above the figures):

For SATA, a link reset sequence is a phy reset sequence (see 6.7).

For SAS, a link reset sequence is either:

a) the following sequence:

- 1) a phy reset sequence indicating that the physical link is using SAS rather than SATA; and
- 2) an identification sequence,

or

b) the following sequence:

- 1) a phy reset sequence indicating that the physical link is using SAS rather than SATA;
 - 2) a hard reset sequence;
 - 3) another phy reset sequence indicating that the physical link is using SAS rather than SATA; and
 - 4) an identification sequence.
-

Author: RElliott
Subject: Underline
Date: 6/30/2008 6:16:52 PM
T ACCEPT - DONE

phy

s/b

logical phy

Author: RElliott
Subject: Highlight
Date: 6/30/2008 6:16:52 PM
T ACCEPT - DONE

the

s/b

then the

Figure 177 shows phy A performing the identification sequence and phy B performing the hard reset sequence. Multiplexing is disabled and only one IDENTIFY address frame is shown in this example.

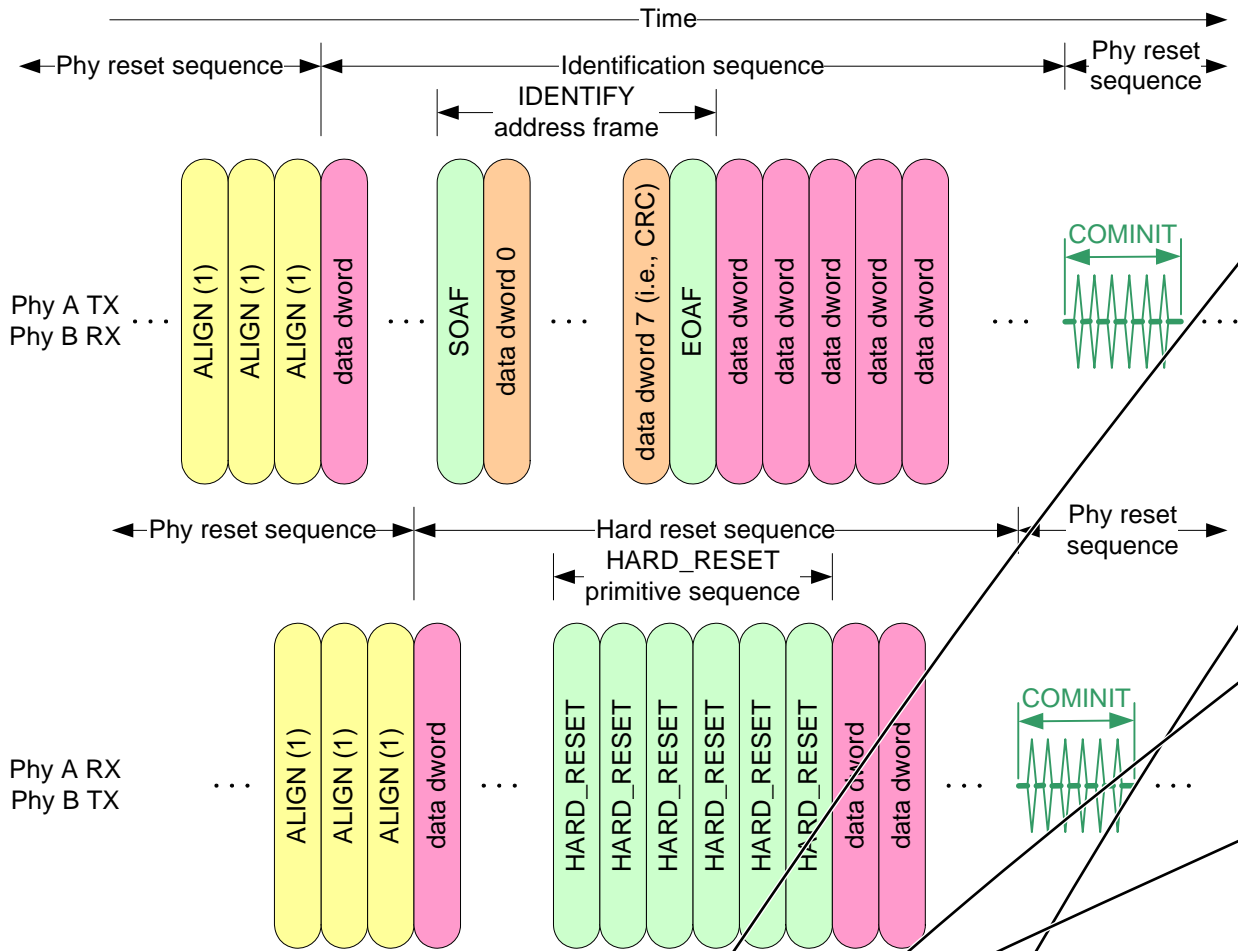

NOTE: Phys transmit deletable primitives for physical link rate tolerance management after the phy reset sequence.

Figure 177 — Hard reset sequence

Each logical phy receives an IDENTIFY address frame or a HARD_RESET primitive sequence from the logical phy to which it is attached. The combination of a phy reset sequence, an optional hard reset sequence followed by another phy reset sequence, and an identification sequence is called a link reset sequence (see 4.4.1).

If a phy receives a valid IDENTIFY address frame within 1 ms of phy reset sequence completion, the SAS address in the outgoing IDENTIFY address frame(s) and the SAS address in the incoming IDENTIFY address frame determine the port to which a phy belongs (see 4.1.4). The phy ignores subsequent IDENTIFY address frames and HARD_RESET primitives until another phy reset sequence occurs.

If a phy receives a HARD_RESET primitive sequence within 1 ms of phy reset sequence completion, it shall be considered a reset event and cause a hard reset (see 4.4.2) of the port containing that phy.

If a phy does not receive a HARD_RESET primitive sequence or a valid IDENTIFY address frame within 1 ms of phy reset sequence completion, it shall restart the phy reset sequence.

7.9.2 SAS initiator device rules

After a link reset sequence, or after receiving a Broadcast (Change), a management application client behind an SMP initiator port should perform a discover process (see 4.7).

Author: stx-ghoulder

Subject: Highlight

Date: 6/9/2008 2:55:48 PM

T ACCEPT - DONE (5/5 add "see 7.9.4.4.3.1" - the SL_IR_RIF2 description that has the specific criteria)

valid IDENTIFY address

I have two questions: (1) What is a valid IDENTIFY address frame? If the frame contents are different from the last phy reset with no hard reset in between, does this make it invalid? (2) What should happen if an invalid IDENTIFY frame is received? Should hard reset be assumed?

Author: RElliott

Subject: Underline

Date: 6/30/2008 6:16:52 PM

T ACCEPT - DONE

phy

s/b

logical phy

Author: RElliott

Subject: Underline

Date: 6/30/2008 6:16:52 PM

T ACCEPT - DONE

a phy

s/b

the logical phy

Author: RElliott

Subject: Underline

Date: 6/30/2008 6:16:52 PM

T ACCEPT - DONE

phy

s/b

logical phy

Author: wdc-mevans

Subject: Highlight

Date: 5/22/2008 4:39:48 PM

T REJECT (but changed to "then the phy shall consider this to be a reset event, and the port containing the phy shall process a hard reset (see 4.4.2). to match wording in 4.4.2.1)

it shall be considered a reset event and cause

s/b

then this shall be considered a reset event, and the phy shall cause

Author: RElliott

Subject: Underline

Date: 6/30/2008 6:16:52 PM

T ACCEPT - DONE

phy

s/b

logical phy

Author: RElliott

Subject: Underline

Date: 6/30/2008 6:16:52 PM

T ACCEPT - DONE

Comments from page 335 continued on next page

Figure 177 shows phy A performing the identification sequence and phy B performing the hard reset sequence. Multiplexing is disabled and only one IDENTIFY address frame is shown in this example.

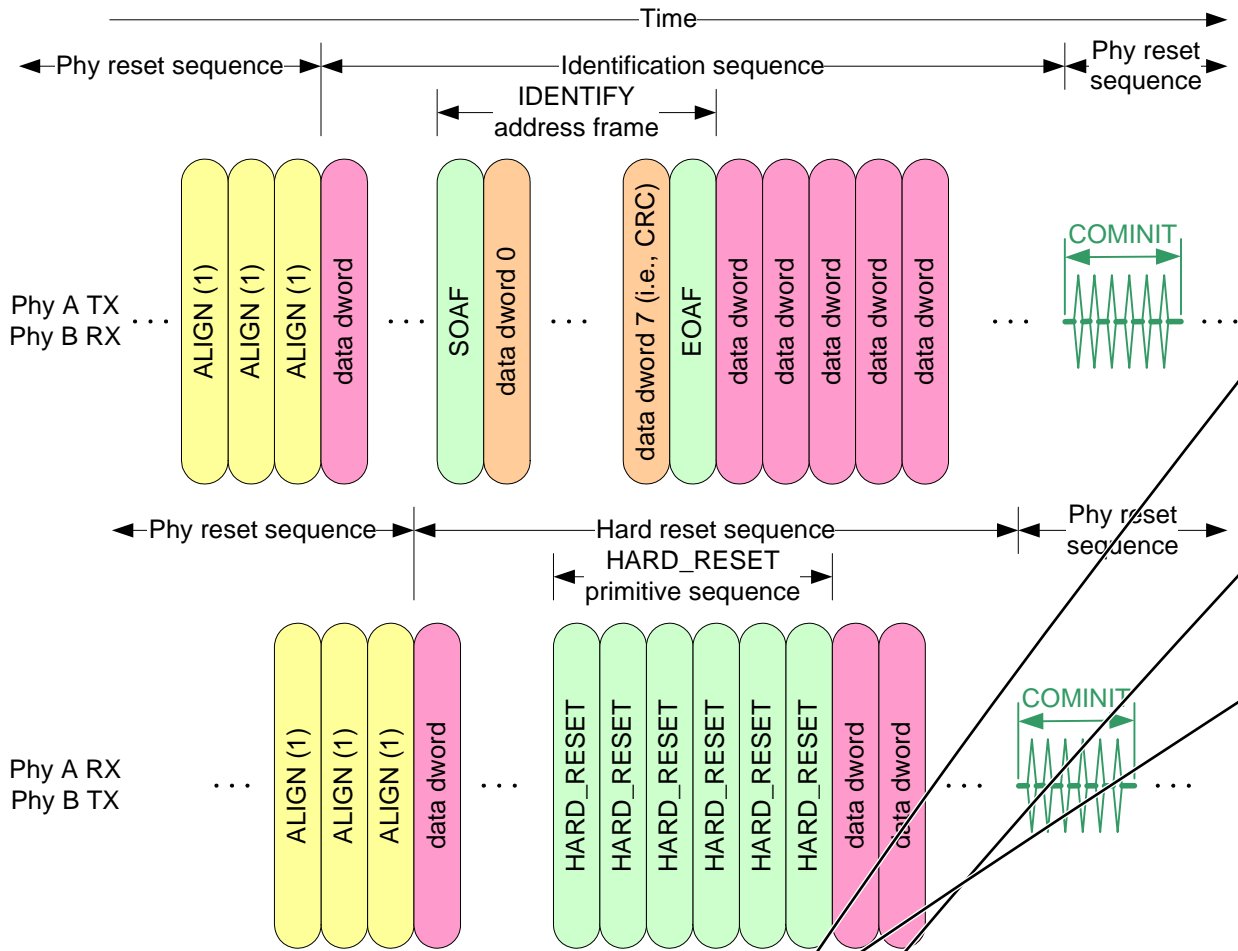

NOTE: Phys transmit deletable primitives for physical link rate tolerance management after the phy reset sequence.

Figure 177 — Hard reset sequence

Each logical phy receives an IDENTIFY address frame or a HARD_RESET primitive sequence from the logical phy to which it is attached. The combination of a phy reset sequence, an optional hard reset sequence followed by another phy reset sequence, and an identification sequence is called a link reset sequence (see 4.4.1).

If a phy receives a valid IDENTIFY address frame within 1 ms of phy reset sequence completion, the SAS address in the outgoing IDENTIFY address frame(s) and the SAS address in the incoming IDENTIFY address frame determine the port to which a phy belongs (see 4.1.4). The phy ignores subsequent IDENTIFY address frames and HARD_RESET primitives until another phy reset sequence occurs.

If a phy receives a HARD_RESET primitive sequence within 1 ms of phy reset sequence completion, it shall be considered a reset event and cause a hard reset (see 4.4.2) of the port containing that phy.

If a phy does not receive a HARD_RESET primitive sequence or a valid IDENTIFY address frame within 1 ms of phy reset sequence completion, it shall restart the phy reset sequence.

7.9.2 SAS initiator device rules

After a link reset sequence, or after receiving a Broadcast (Change), a management application client behind an SMP initiator port should perform a discover process (see 4.7).

phy
s/b
logical phy

● Author: wdc-mevans
Subject: Highlight
Date: 6/28/2008 4:15:59 PM
 ACCEPT - DONE (as "then the physical phy containing the logical phy" to clarify that this wipes out other logical phys too)

it
s/b
then the phy

● Author: RElliott
Subject: Highlight
Date: 6/30/2008 6:16:52 PM
 ACCEPT - DONE

SAS initiator device rules
s/b
SAS initiator device handling of link reset sequences

● Author: RElliott
Subject: Note
Date: 9/3/2008 5:23:41 PM
 ACCEPT - DONE

Move 7.9.2 content in 4.7, since it is all about application client requirements (not link layer related)

When a discover process is performed after a link reset sequence, the management application client discovers all the devices in the SAS domain. When a discover process is performed after a Broadcast (Change), the management application client determines which devices have been added to or removed from the SAS domain.

The discover information may be used to select connection rates for connection requests (see 7.8.3).

7.9.3 Expander device rules

After completing the link reset sequence on a phy and completing internal initialization, the ECM within an expander device shall be capable of routing connection requests through that phy. The expander device may return OPEN_REJECT (NO DESTINATION) until it is ready to process connection requests.

After a link reset sequence, or after receiving a Broadcast (Change), the management application client behind an SMP initiator port in a self-configuring expander device shall follow the SAS initiator device rules (see 7.9.2) to perform a discover process (see 4.7).

The ECM of an externally configurable expander device is dependent on the completion of the discover process (see 4.7) for routing connection requests using the table routing method.

7.9.4 SL_IR (link layer identification and hard reset) state machines

7.9.4.1 SL_IR state machines overview

The SL_IR (link layer identification and hard reset) state machines control the flow of dwords on the physical link that are associated with the identification and hard reset sequences. The state machines are as follows:

- a) SL_IR_TIR (transmit IDENTIFY or HARD_RESET) state machine (see 7.9.4.3);
- b) SL_IR_RIF (receive IDENTIFY address frame) state machine (see 7.9.4.4); and
- c) SL_IR_IRC (identification and hard reset control) state machine (see 7.9.4.5).

The SL_IR state machines send the following messages to the SL state machines (see 7.14) in SAS devices or the XL (see 7.15) state machine in expander devices:

- a) Enable Disable SAS Link (Enable); and
- b) Enable Disable SAS Link (Disable).

The SL_IR_IRC state machine shall maintain the timers listed in table 140.

Table 140 — SL_IR_IRC timers

Timer	Initial value
Receive Identify Timeout timer	1 ms

Page: 336

● Author: RElliott
Subject: Highlight
Date: 6/30/2008 6:16:52 PM
 ACCEPT - DONE

Expander device rules
s/b
Expander device handling of link reset sequences

● Author: RElliott
Subject: Note
Date: 9/3/2008 5:24:08 PM
 ACCEPT - DONE

Move 7.9.3 middle paragraph into 4.7, since it is about application client requirements (not link layer related)

● Author: wdc-mevans
Subject: Highlight
Date: 5/22/2008 5:06:46 PM
 REJECT (first noun/subject convention)

it
s/b
the expander device

● Author: hpq-relliott
Subject: Note
Date: 9/3/2008 5:24:52 PM
 ACCEPT - DONE (moved application client rules from 7.9.2 and 7.9.3 into new section 4.7.2 Starting the discover process)

Mentioning Broadcast (Change) in 7.9.2 and 7.9.3 is not ideal, since 7.9 is the identification and hard reset sequence section. The general application client rules for handling direct attached resets as well as Broadcast (Changes) belongs elsewhere.

● Author: RElliott
Subject: Highlight
Date: 6/30/2008 6:16:52 PM
 ACCEPT - DONE

Move 7.9.4 up one level to become 7.9.

This parallels how SL_CC and XL are at the 7.xx level, not buried inside the 7.xx Connections section.

● Author: wdc-mevans
Subject: Highlight
Date: 5/6/2008 4:07:49 PM
 REJECT (the applicable noun here is "dwords" which is plural)

are
s/b
is

● Author: RElliott
Subject: Highlight
Date: 9/1/2008 3:53:33 PM
 ACCEPT - DONE

Comments from page 336 continued on next page

When a discover process is performed after a link reset sequence, the management application client discovers all the devices in the SAS domain. When a discover process is performed after a Broadcast (Change), the management application client determines which devices have been added to or removed from the SAS domain.

The discover information may be used to select connection rates for connection requests (see 7.8.3).

7.9.3 Expander device rules



After completing the link reset sequence on a phy and completing internal initialization, the ECM within an expander device shall be capable of routing connection requests through that phy. The expander device may return OPEN_REJECT (NO DESTINATION) until it is ready to process connection requests.



After a link reset sequence, or after receiving a Broadcast (Change), the management application client behind an SMP initiator port in a self-configuring expander device shall follow the SAS initiator device rules (see 7.9.2) to perform a discover process (see 4.7).

The ECM of an externally configurable expander device is dependent on the completion of the discover process (see 4.7) for routing connection requests using the table routing method.

7.9.4 SL_IR (link layer identification and hard reset) state machines

7.9.4.1 SL_IR state machines overview

The SL_IR (link layer identification and hard reset) state machines control the flow of dwords on the physical link that are associated with the identification and hard reset sequences. The state machines are as follows:

- a) SL_IR_TIR (transmit IDENTIFY or HARD_RESET) state machine (see 7.9.4.3);
- b) SL_IR_RIF (receive IDENTIFY address frame) state machine (see 7.9.4.4); and
- c) SL_IR_IRC (identification and hard reset control) state machine (see 7.9.4.5).

The SL_IR state machines send the following messages to the SL state machines (see 7.14) in SAS devices or the XL (see 7.15) state machine in expander devices:

- a) Enable Disable SAS Link (Enable); and
- b) Enable Disable SAS Link (Disable).

The SL_IR_IRC state machine shall maintain the timers listed in table 140.

Table 140 — SL_IR_IRC timers

Timer	Initial value
Receive Identify Timeout timer	1 ms

XL (see 7.15) state machine
s/b
XL state machine (see 7.15)

● Author: RElliott
Subject: Highlight
Date: 8/30/2008 5:02:44 PM
T ACCEPT - DONE

The SL_IR_IRC state machine
s/b
This state machine

● Author: RElliott
Subject: Highlight
Date: 8/30/2008 4:53:23 PM
T ACCEPT - DONE

timers
s/b
state machine timers

Figure 178 shows the SL_IR state machines.

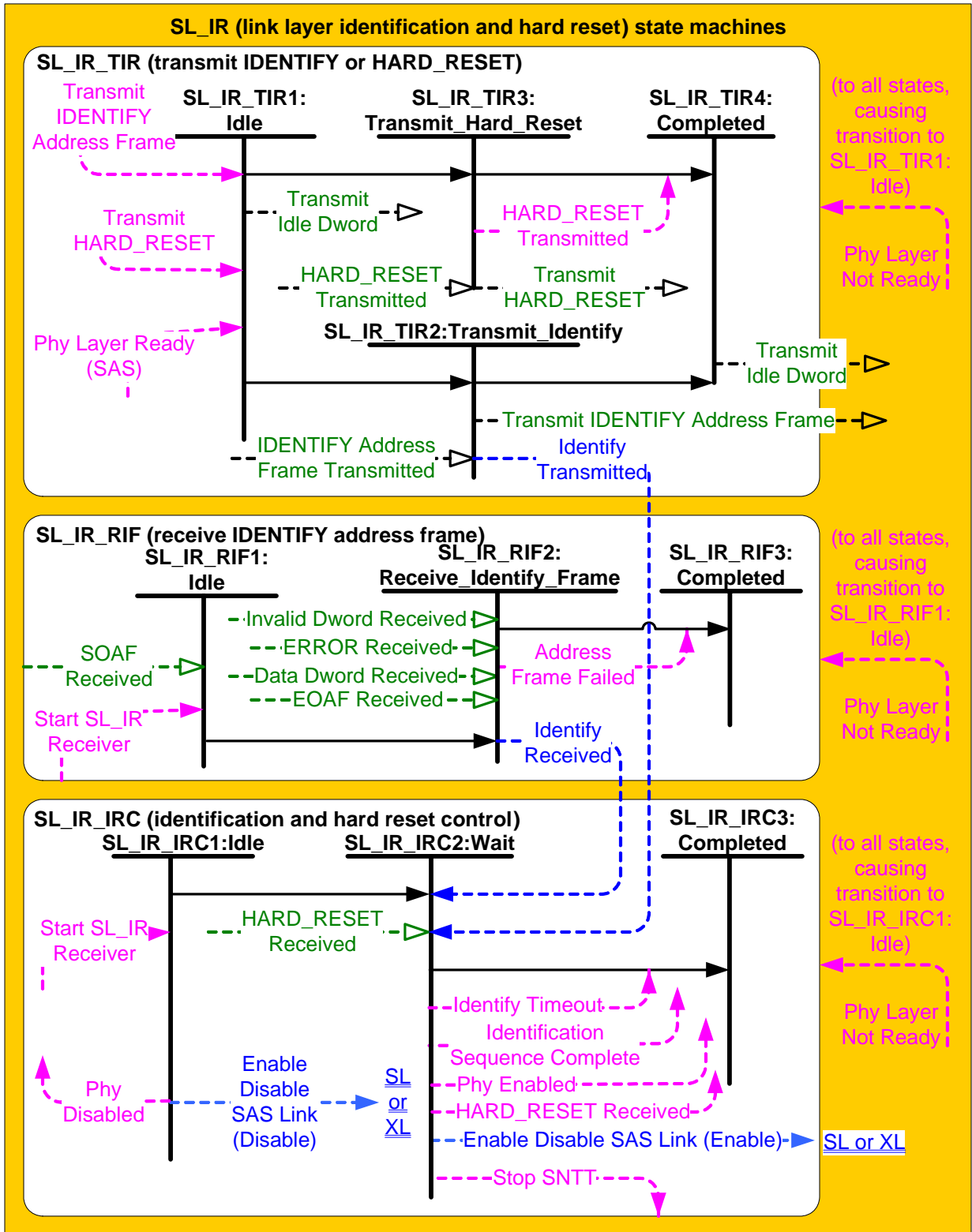

Figure 178 — SL_IR (link layer identification and hard reset) state machines

This page contains no comments

7.9.4.2 SL_IR transmitter and receiver

The SL_IR transmitter receives the following messages from the SL_IR state machines indicating primitive sequences, frames, and dwords to transmit:

- a) Transmit IDENTIFY Address Frame;
- b) Transmit HARD_RESET; and
- c) Transmit Idle Dword.

Upon receiving a Transmit IDENTIFY Address Frame message, the SL_IR transmitter shall transmit:

- 1) SOAF;
- 2) data dwords;
- 3) EOAF; and
- 4) at least 3 idle dwords.

NOTE 58 - Phys compliant with previous versions of this standard were not required to transmit idle dwords after EOAF.

The SL_IR transmitter sends the following messages to the SL_IR state machines:

- a) HARD_RESET Transmitted; and
- b) IDENTIFY Address Frame Transmitted.

The SL_IR receiver sends the following messages to the SL_IR state machines indicating primitive sequences and dwords received from the SP_DWS receiver (see 6.9.2):

- a) SOAF Received;
- b) Data Dword Received;
- c) EOAF Received;
- d) ERROR Received;
- e) Invalid Dword Received; and
- f) HARD_RESET Received.

The SL_IR receiver shall not require reception of any idle dwords after an IDENTIFY address frame.

The SL_IR receiver shall ignore all other dwords.

The SL_IR transmitter relationship to other transmitters is defined in 4.3.2. The SL_IR receiver relationship to other receivers is defined in 4.3.3.

7.9.4.3 SL_IR_TIR (transmit IDENTIFY or HARD_RESET) state machine

7.9.4.3.1 SL_IR_TIR state machine overview

The SL_IR_TIR state machine's function is to transmit one or three IDENTIFY address frames or a HARD_RESET primitive after the phy layer enables the link layer. This state machine consists of the following states:

- a) SL_IR_TIR1:Idle (see 7.9.4.3.2)(initial state);
- b) SL_IR_TIR2:Transmit_Identify (see 7.9.4.3.3);
- c) SL_IR_TIR3:Transmit_Hard_Reset (see 7.9.4.3.4); and
- d) SL_IR_TIR4:Completed (see 7.9.4.3.5).

This state machine shall start in the SL_IR_TIR1:Idle state. This state machine shall transition to the SL_IR_TIR1:Idle state from any other state after receiving a Phy Layer Not Ready confirmation.

7.9.4.3.2 SL_IR_TIR1:Idle state

7.9.4.3.2.1 State description

This state shall request idle dwords be transmitted by repeatedly sending Transmit Idle Dword messages to the SL_IR transmitter.

● Author: hpq-relliott

Subject: Note

Date: 6/28/2008 5:06:59 PM

 ACCEPT - DONE (added:

"NOTE If multiplexing is enabled, each SL_IR_IRC state machine sends a Stop SNTT request to the phy layer. The phy layer honors the first request and ignores the second request.")

need to clarify how SP works with two SL_IRs in multiplexing. Does each one send Stop SNTT upon receiving its IDENTIFY address frame?

● Author: RElliott

Subject: Note

Date: 8/30/2008 3:00:26 PM

 ACCEPT - DONE

Add:

The SL_IR_TIR state machine receives the following requests from the management application layer:

- a) Transmit IDENTIFY Address Frame; and
- b) Transmit HARD_RESET.

prompted by 08-343

7.9.4.3.2.2 Transition SL_IR_TIR1:Idle to SL_IR_TIR2:Transmit_Identify

This transition shall occur after both:

- a) a Phy Layer Ready (SAS) confirmation is received; and
- b) a Transmit IDENTIFY Address Frame request is received.

7.9.4.3.2.3 Transition SL_IR_TIR1:Idle to SL_IR_TIR3:Transmit_Hard_Reset

This transition shall occur after both:

- a) a Phy Layer Ready (SAS) confirmation is received; and
- b) a Transmit HARD_RESET request is received.

7.9.4.3.3 SL_IR_TIR2:Transmit_Identify state

7.9.4.3.3.1 State description

Upon entry into this state, this state shall send either one or three Transmit IDENTIFY Address Frame messages to the SL_IR transmitter.

NOTE 59 - Phys compliant with previous versions of this standard only transmitted one Transmit IDENTIFY Address Frame message.

After this state receives an IDENTIFY Address Frame Transmitted message in response to its first Transmit IDENTIFY Address Frame message, this state shall send an Identify Transmitted message to the SL_IR_IRC state machine.

7.9.4.3.3.2 Transition SL_IR_TIR2:Transmit_Identify to SL_IR_TIR4:Completed

If this state sends one Transmit IDENTIFY Address Frame message, this transition shall occur after sending an Identify Transmitted message to the SL_IR_IRC state machine.

If this state sends three Transmit IDENTIFY Address Frame messages, this transition shall occur after receiving three Identify Transmitted messages.

7.9.4.3.4 SL_IR_TIR3:Transmit_Hard_Reset state

7.9.4.3.4.1 State description

Upon entry into this state, this state shall send a Transmit HARD_RESET message to the SL_IR transmitter.

After this state receives a HARD_RESET Transmitted message, this state shall send a HARD_RESET Transmitted confirmation to the management application layer.

7.9.4.3.4.2 Transition SL_IR_TIR3:Transmit_Hard_Reset to SL_IR_TIR4:Completed

This transition shall occur after sending a HARD_RESET Transmitted confirmation to the management application layer.

7.9.4.3.5 SL_IR_TIR4:Completed state

This state shall request idle dwords be transmitted by repeatedly sending Transmit Idle Dword messages to the SL_IR transmitter.

7.9.4.4 SL_IR_RIF (receive IDENTIFY address frame) state machine

7.9.4.4.1 SL_IR_RIF state machine overview

The SL_IR_RIF state machine receives an IDENTIFY address frame and checks the IDENTIFY address frame to determine if the frame should be accepted or discarded by the link layer.

● Author: RElliott
Subject: Highlight
Date: 6/30/2008 6:16:52 PM
T ACCEPT - DONE

this
s/b
then this

● Author: RElliott
Subject: Highlight
Date: 6/30/2008 6:16:52 PM
T ACCEPT - DONE

this
s/b
then this

This state machine consists of the following states:

- a) SL_IR_RIF1:Idle (see 7.9.4.4.2)(initial state);
- b) SL_IR_RIF2:Receive_Identify_Frame (see 7.9.4.4.3); and
- c) SL_IR_RIF3:Completed (see 7.9.4.4.4).

This state machine shall start in the SL_IR_RIF1:Idle state. This state machine shall transition to the SL_IR_RIF1:Idle state from any other state after receiving a Phy Layer Not Ready confirmation.

7.9.4.4.2 SL_IR_RIF1:Idle state

7.9.4.4.2.1 State description

This state waits for an SOAF to be received from the physical link, indicating an address frame is arriving.

7.9.4.4.2.2 Transition SL_IR_RIF1:Idle to SL_IR_RIF2:Receive_Identify_Frame

This transition shall occur after both:

- a) a Start SL_IR Receiver confirmation is received; and
- b) an SOAF Received message is received.

7.9.4.4.3 SL_IR_RIF2:Receive_Identify_Frame state

7.9.4.4.3.1 State description

This state receives the dwords of an address frame and the EOAF.

If this state receives an SOAF Received message, then this state shall discard any previously received dwords for the address frame, ~~send an Address Frame Failed confirmation to the management application layer~~ to indicate that an invalid address frame was received, and start receiving the new address frame.

If this state receives more than eight Data Dword Received messages after an SOAF Received message and before an EOAF Received message, then this state shall discard the address frame and send an Address Frame Failed confirmation to the management application layer to indicate that an invalid address frame was received.

If this state receives an Invalid Dword Received message or an ERROR Received message after an SOAF Received message and before an EOAF Received message, then this state shall:

- a) ignore the invalid dword or ERROR; **or**
- b) discard the address frame and send an Address Frame Failed confirmation to the management application layer to indicate that an invalid address frame was received.

After receiving an EOAF Received message, this state shall check if it the received frame is a valid IDENTIFY address frame.

This state shall accept an IDENTIFY address frame and send an Identify Received message to the SL_IR_IRC state machine if:

- a) the ADDRESS FRAME TYPE field is set to 0h (i.e., IDENTIFY);
- b) the number of bytes between the SOAF and EOAF is 32; and
- c) the CRC field contains a good CRC.

Otherwise, this state shall discard the address frame and send an Address Frame Failed confirmation to the management application layer to indicate that an invalid address frame was received.

7.9.4.4.3.2 Transition SL_IR_RIF2:Receive_Identify_Frame to SL_IR_RIF3:Completed

This transition shall occur after sending an Identify Received **message confirmation**.

7.9.4.4.4 SL_IR_RIF3:Completed state

This state waits for a Phy Layer Not Ready confirmation.

Author: Isi-bday
Subject: Cross-Out

Date: 5/25/2008 8:45:25 PM

T REJECT (the phy event information counter for phy event source 20h counts these; see table 37 on page 118)

send an Address Frame Failed confirmation to the management application layer.

This confirmation isn't used elsewhere in the spec. With potential for multiple IDENTIFY frames now, it's possible to reach the normal completion after this Address Frame Failed has already been sent. Suggest remove this confirmation, and just rely on either reaching Identification Sequence Complete or Identify Timeout.

Author: RElliott

Subject: Underline

Date: 6/30/2008 6:16:52 PM

T ACCEPT - DONE

after:

more than eight Data Dword Received messages

add:

(i.e., 32 bytes)

Author: Isi-gpenokie

Subject: Highlight

Date: 5/6/2008 4:07:49 PM

T ACCEPT - DONE ("or" is correct - the implementation is allowed to choose either approach - ignore the dword (probably causing a CRC error and a frame length error), or discard the frame containing the dword (without relying on the CRC to go bad or the frame length to be wrong). Changing the preface to "shall either:" to emphasize that)

It seems like this << or >> should be << and >> but that would be a different requirement in that the state would do both a and b rather than have to pick either a or b. I'm not sure which was intended.

Author: RElliott

Subject: Highlight

Date: 8/30/2008 11:55:48 AM

T ACCEPT - DONE

message confirmation

s/b

message

(per 08-343)

7.9.4.5 SL_IR_IRC (identification and hard reset control) state machine

7.9.4.5.1 SL_IR_IRC state machine overview

The SL_IR_IRC state machine ensures that IDENTIFY address frames have been both received and transmitted before enabling the rest of the link layer, and notifies the link layer if a HARD_RESET primitive sequence is received before an IDENTIFY address frame has been received.

This state machine consists of the following states:

- a) SL_IR_IRC1:Idle (see 7.9.4.5.2)(initial state);
- b) SL_IR_IRC2:Wait (see 7.9.4.5.3); and
- c) SL_IR_IRC3:Completed (see 7.9.4.5.4).

This state machine shall start in the SL_IR_IRC1:Idle state. This state machine shall transition to the SL_IR_IRC1:Idle state from any other state after receiving a Phy Layer Not Ready confirmation.

7.9.4.5.2 SL_IR_IRC1:Idle state

7.9.4.5.2.1 State description

This state waits for the link layer to be enabled. Upon entry into this state, this state shall:

- a) send an Enable Disable SAS Link (Disable) message to SL state machines (see 7.14) or XL state machine (see 7.15) halting any link layer activity; and
- b) send a Phy Disabled confirmation to the port layer and the management application layer indicating that the phy is not ready for use.

7.9.4.5.2.2 Transition SL_IR_IRC1:Idle to SL_IR_IRC2:Wait

This transition shall occur after a Start SL_IR Receiver confirmation is received.

7.9.4.5.3 SL_IR_IRC2:Wait state

7.9.4.5.3.1 State description

This state ensures that an IDENTIFY address frame has been received by the SL_IR_RIF state machine and that an IDENTIFY address frame has been transmitted by the SL_IR_TIR state machine before enabling the rest of the link layer. The IDENTIFY address frames may be transmitted and received on the physical link in any order.

After this state receives an Identify Received message, it shall send a Stop SNTT request to the phy layer.

After this state receives an Identify Transmitted message, it shall initialize and start the Receive Identify Timeout timer. If an Identify Received message is received before the Receive Identify Timeout timer expires, this state shall:

- a) send an Identification Sequence Complete confirmation to the management application layer, with arguments carrying the contents of the incoming IDENTIFY address frame;
- b) send an Enable Disable SAS Link (Enable) message to the SL state machines (see 7.14) in a SAS logical phy or the XL state machine (see 7.15) in an expander logical phy indicating that the rest of the link layer may start operation; and
- c) send a Phy Enabled confirmation to the port layer and the management application layer indicating that the phy is ready for use.

If the Receive Identify Timeout timer expires before an Identify Received message is received, this state shall send an Identify Timeout confirmation to the management application layer to indicate that an identify timeout occurred.

If this state receives a HARD_RESET Received message before an Identify Received message is received, this state shall send a HARD_RESET Received confirmation to the port layer and the management application layer and a Stop SNTT request to the phy layer.

● Author: wdc-mevans

Subject: Highlight

Date: 5/25/2008 8:46:02 PM

T REJECT (not logical AND, so comma + and is OK to join independent clauses)

layer, and

s/b

layer and

● Author: RElliott

Subject: Highlight

Date: 6/30/2008 6:16:52 PM

T ACCEPT - DONE

to SL

s/b

to the SL

● Author: wdc-mevans

Subject: Highlight

Date: 5/25/2008 8:46:17 PM

T REJECT

it

s/b

this state

● Author: wdc-mevans

Subject: Highlight

Date: 5/25/2008 8:46:23 PM

T REJECT

it

s/b

this state

● Author: RElliott

Subject: Highlight

Date: 6/30/2008 6:16:52 PM

T ACCEPT - DONE

this

s/b

then this

● Author: RElliott

Subject: Highlight

Date: 6/30/2008 6:16:52 PM

T ACCEPT - DONE

this

s/b

then this

If this state receives a HARD_RESET Received message after an Identify Received message is received, the HARD_RESET Received message shall be ignored.

7.9.4.5.3.2 Transition SL_IR_IRC2:Wait to SL_IR_IRC3:Completed

This transition shall occur after sending a HARD_RESET Received confirmation, Identify Timeout confirmation, or an Identification Sequence Complete and an Phy Enabled confirmation.

7.9.4.5.4 SL_IR_IRC3:Completed state

This state waits for a Phy Layer Not Ready confirmation.

7.10 Power management

SATA interface power management is not supported in STP.

STP initiator ports shall not generate SATA_PMREQ_P, SATA_PMREQ_S, or SATA_PMACK. If an STP initiator port receives SATA_PMREQ_P or SATA_PMREQ_S, it shall reply with SATA_PMNAK.

If an expander device receives SATA_PMREQ_P or SATA_PMREQ_S from a SATA device while an STP connection is not open, it shall not forward it to any STP initiator port and shall reply with SATA_PMNAK. If one of these primitives arrives while an STP connection is open, it may forward the primitive to the STP initiator port.

SCSI idle and standby power conditions, implemented with the START STOP UNIT command (see SBC-3) and the Power Condition mode page (see SPC-4), may be supported by SSP initiator ports and SSP target ports as described in 10.2.10.

ATA idle and standby power modes, implemented with the IDLE, IDLE IMMEDIATE, STANDBY STANDBY IMMEDIATE, and CHECK POWER MODE commands (see ATA8-ACS), may be supported by STP initiator ports. The ATA sleep power mode, implemented with the SLEEP command, shall not be used.

7.11 SAS domain changes (Broadcast (Change) usage)

~~After power on or receiving Broadcast (Change) via an SMP initiator port, the management application client should scan the SAS domain using the discover process (see 4.7) to search for SAS initiator devices, SAS target devices, and expander devices.~~

The expander device shall originate Broadcast (Change) from at least one phy in each expander port other than the expander port that is the cause for originating Broadcast (Change).

Expander devices shall originate Broadcast (Change) for the following expander phy-related reasons:

- a) after an expander phy's SP state machine transitions from the SP15:SAS_PHY_Ready or SP22:SATA_PHY_Ready state to the SP0:OOB_COMINIT state (see 6.8);

NOTE 60 - This occurs when the expander phy is reset or disabled with the SMP PHY CONTROL function DISABLE, LINK RESET, HARD RESET, or TRANSMIT SATA PORT SELECTION SIGNAL phy operations (see 10.4.3.28) as well as when dword synchronization is unexpectedly lost;

- b) after a virtual phy has been disabled with the SMP PHY CONTROL function DISABLE phy operation or started processing a reset requested by the LINK RESET or HARD RESET phy operations (see 10.4.3.28);
- c) after an expander phy's SP state machine reaches the SP26:SATA_SpinupHold state and sends a SATA Spinup Hold confirmation as defined in 6.8.7 and 6.11;
- d) after an expander phy's SP state machine receives a COMWAKE Detected message in states SP0:OOB_COMINIT, SP1:OOB_AwaitCOMX, SP3:OOB_AwaitCOMINIT_Sent, or SP4:OOB_COMSAS if the ATTACHED SATA PORT SELECTOR bit is set to zero in the SMP DISCOVER response (see 10.4.3.10) prior to receiving the COMWAKE detected message (see 6.8.3 and table 272 in 10.4.3.10);
- e) after an expander phy's SP state machine transitions from the SP1:OOB_AwaitCOMX state to the SP0:OOB_COMINIT state if the ATTACHED SATA PORT SELECTOR bit was set to one in the SMP

Page: 342

Author: RElliott
Subject: Highlight
Date: 6/30/2008 6:16:52 PM
T ACCEPT - DONE

the
s/b
then the

Author: RElliott
Subject: Highlight
Date: 6/30/2008 6:16:52 PM
T ACCEPT - DONE

it
s/b
then it

Author: wdc-mevans
Subject: Highlight
Date: 5/25/2008 8:47:02 PM
T ACCEPT - DONE

it
s/b
the primitive

Author: wdc-mevans
Subject: Highlight
Date: 5/22/2008 4:28:58 PM
T REJECT (first noun/subject convention. Added "then" however)

it
s/b
the expander device

Author: Isi-gpenokie
Subject: Highlight
Date: 5/22/2008 4:28:37 PM
T REJECT (first noun/subject convention)

This << not open, it shall not forward >> should be << not open, the expander device shall not forward >>

Author: wdc-mevans
Subject: Highlight
Date: 5/22/2008 4:29:38 PM
T ACCEPT - DONE (plus added "then")

it
s/b
the expander device

Author: Isi-gpenokie
Subject: Highlight
Date: 5/22/2008 4:29:48 PM
T ACCEPT - DONE (plus added "then")

This << connection is open, it may forward the >> should be << connection is open, the expander device may forward the >>

Author: RElliott
Subject: Cross-Out
Date: 9/3/2008 5:20:50 PM
T ACCEPT - DONE

Comments from page 342 continued on next page

If this state receives a HARD_RESET Received message after an Identify Received message is received, the HARD_RESET Received message shall be ignored.

7.9.4.5.3.2 Transition SL_IR_IRC2:Wait to SL_IR_IRC3:Completed

This transition shall occur after sending a HARD_RESET Received confirmation, Identify Timeout confirmation, or an Identification Sequence Complete and an Phy Enabled confirmation.

7.9.4.5.4 SL_IR_IRC3:Completed state

This state waits for a Phy Layer Not Ready confirmation.

7.10 Power management

SATA interface power management is not supported in STP.

STP initiator ports shall not generate SATA_PMREQ_P, SATA_PMREQ_S, or SATA_PMACK. If an STP initiator port receives SATA_PMREQ_P or SATA_PMREQ_S, it shall reply with SATA_PMNAK.

If an expander device receives SATA_PMREQ_P or SATA_PMREQ_S from a SATA device while an STP connection is not open, it shall not forward it to any STP initiator port and shall reply with SATA_PMNAK. If one of these primitives arrives while an STP connection is open, it may forward the primitive to the STP initiator port.

SCSI idle and standby power conditions, implemented with the START STOP UNIT command (see SBC-3) and the Power Condition mode page (see SPC-4), may be supported by SSP initiator ports and SSP target ports as described in 10.2.10.

ATA idle and standby power modes, implemented with the IDLE, IDLE IMMEDIATE, STANDBY, STANDBY IMMEDIATE, and CHECK POWER MODE commands (see ATA8-ACS), may be supported by STP initiator ports. The ATA sleep power mode, implemented with the SLEEP command, shall not be used.

7.11 SAS domain changes (Broadcast (Change) usage)

~~After power on or receiving Broadcast (Change) via an SMP initiator port, the management application client should scan the SAS domain using the discover process (see 4.7) to search for SAS initiator devices, SAS target devices, and expander devices.~~

The expander device shall originate Broadcast (Change) from at least one phy in each expander port other than the expander port that is the cause for originating Broadcast (Change).

Expander devices shall originate Broadcast (Change) for the following expander phy-related reasons:

- a) after an expander phy's SP state machine transitions from the SP15:SAS_PHY_Ready or SP22:SATA_PHY_Ready state to the SP0:OOB_COMINIT state (see 6.8);

NOTE 60 - This occurs when the expander phy is reset or disabled with the SMP PHY CONTROL function DISABLE, LINK RESET, HARD RESET or TRANSMIT SATA PORT SELECTION SIGNAL phy operations (see 10.4.3.28) as well as when dword synchronization is unexpectedly lost;

- b) after a virtual phy has been disabled with the SMP PHY CONTROL function DISABLE phy operation or started processing a reset requested by the LINK RESET or HARD RESET phy operations (see 10.4.3.28);
- c) after an expander phy's SP state machine reaches the SP26:SATA_SpinupHold state and sends a SATA Spinup Hold confirmation as defined in 6.8.7 and 6.11;
- d) after an expander phy's SP state machine receives a COMWAKE Detected message in states SP0:OOB_COMINIT, SP1:OOB_AwaitCOMX, SP3:OOB_AwaitCOMINIT_Sent, or SP4:OOB_COMSAS if the ATTACHED SATA PORT SELECTOR bit is set to zero in the SMP DISCOVER response (see 10.4.3.10) prior to receiving the COMWAKE detected message (see 6.8.3 and table 272 in 10.4.3.10);
- e) after an expander phy's SP state machine transitions from the SP1:OOB_AwaitCOMX state to the SP0:OOB_COMINIT state if the ATTACHED SATA PORT SELECTOR bit was set to one in the SMP

Delete:

After power on or receiving Broadcast (Change) via an SMP initiator port, the management application client should scan the SAS domain using the discover process (see 4.7) to search for SAS initiator devices, SAS target devices, and expander devices.

Already covered by the SAS initiator device and expander device rules, which are being moved into 4.7. Section 7.11 should be about the generation of Broadcast (Change), not the reception of it.

Author: RElliott
Subject: Highlight
Date: 9/3/2008 5:21:19 PM

T ACCEPT - DONE

The expander device
s/n
An expander device

since no expander in particular is being referred to

Author: wdc-mevans
Subject: Highlight
Date: 5/25/2008 8:47:11 PM

T ACCEPT - DONE

each expander port
s/b
each of its expander ports

Author: lsi-bday
Subject: Highlight
Date: 6/2/2008 10:13:34 AM

T REJECT (transition to SP25 is not related to a phy being reset or disabled)

SP0:OOB_COMINIT state
s/b
SP0:OOB_COMINIT or SP25:SATA_PortSel state

Author: lsi-gpenokie
Subject: Highlight
Date: 5/30/2008 6:03:15 PM

T REJECT (this helps avoid confusion with the previous "or" in the sentence)

This << phy operations (see 10.4.3.28) as well as when dword >> should be << phy operations (see 10.4.3.28) and when dword >>

Author: stx-goulder
Subject: Highlight
Date: 5/30/2008 6:03:08 PM

T REJECT (this helps avoid confusion with the previous "or" in the sentence)

as well as

replace with "or".

Author: RElliott
Subject: Highlight
Date: 6/30/2008 6:16:52 PM

T ACCEPT - DONE

;
s/b
.

If this state receives a HARD_RESET Received message after an Identify Received message is received, the HARD_RESET Received message shall be ignored.

7.9.4.5.3.2 Transition SL_IR_IRC2:Wait to SL_IR_IRC3:Completed

This transition shall occur after sending a HARD_RESET Received confirmation, Identify Timeout confirmation, or an Identification Sequence Complete and an Phy Enabled confirmation.

7.9.4.5.4 SL_IR_IRC3:Completed state

This state waits for a Phy Layer Not Ready confirmation.

7.10 Power management

SATA interface power management is not supported in STP.

STP initiator ports shall not generate SATA_PMREQ_P, SATA_PMREQ_S, or SATA_PMACK. If an STP initiator port receives SATA_PMREQ_P or SATA_PMREQ_S, it shall reply with SATA_PMNAK.

If an expander device receives SATA_PMREQ_P or SATA_PMREQ_S from a SATA device while an STP connection is not open, it shall not forward it to any STP initiator port and shall reply with SATA_PMNAK. If one of these primitives arrives while an STP connection is open, it may forward the primitive to the STP initiator port.

SCSI idle and standby power conditions, implemented with the START STOP UNIT command (see SBC-3) and the Power Condition mode page (see SPC-4), may be supported by SSP initiator ports and SSP target ports as described in 10.2.10.

ATA idle and standby power modes, implemented with the IDLE, IDLE IMMEDIATE, STANDBY, STANDBY IMMEDIATE, and CHECK POWER MODE commands (see ATA8-ACS), may be supported by STP initiator ports. The ATA sleep power mode, implemented with the SLEEP command, shall not be used.

7.11 SAS domain changes (Broadcast (Change) usage)

~~After power on or receiving Broadcast (Change) via an SMP initiator port, the management application client should scan the SAS domain using the discover process (see 4.7) to search for SAS initiator devices, SAS target devices, and expander devices.~~

The expander device shall originate Broadcast (Change) from at least one phy in each expander port other than the expander port that is the cause for originating Broadcast (Change).

Expander devices shall originate Broadcast (Change) for the following expander phy-related reasons:

- a) after an expander phy's SP state machine transitions from the SP15:SAS_PHY_Ready or SP22:SATA_PHY_Ready state to the SP0:OOB_COMINIT state (see 6.9);

NOTE 60 - This occurs when the expander phy is reset or disabled with the SMP PHY CONTROL function DISABLE, LINK RESET, HARD RESET, or TRANSMIT SATA PORT SELECTION SIGNAL phy operations (see 10.4.3.28) as well as when dword synchronization is unexpectedly lost.

- b) after a virtual phy has been disabled with the SMP PHY CONTROL function DISABLE phy operation or started processing a reset requested by the LINK RESET or HARD RESET phy operations (see 10.4.3.28);
- c) after an expander phy's SP state machine reaches the SP26:SATA_SpinupHold state and sends a SATA Spinup Hold confirmation as defined in 6.8.7 and 6.11;
- d) after an expander phy's SP state machine receives a COMWAKE Detected message in states SP0:OOB_COMINIT, SP1:OOB_AwaitCOMX, SP3:OOB_AwaitCOMINIT_Sent, or SP4:OOB_COMSAS if the ATTACHED SATA PORT SELECTOR bit is set to zero in the SMP DISCOVER response (see 10.4.3.10) prior to receiving the COMWAKE detected message (see 6.8.3 and table 272 in 10.4.3.10);
- e) after an expander phy's SP state machine transitions from the SP1:OOB_AwaitCOMX state to the SP0:OOB_COMINIT state if the ATTACHED SATA PORT SELECTOR bit was set to one in the SMP

Author: stx-ghoulder

Subject: Highlight

Date: 6/28/2008 5:12:09 PM

T ACCEPT - DONE (Per other comments, we're now treating virtual phys as having some variation on the standard state machines. So, a virtual phy has an SP state machine that conceptually transitions from SP15 to SP0. So, item b) can be deleted without losing anything.)

b) This item seems redundant with Note 60. Can note 60 be reduced to a reference to "dword synchronization unexpectedly lost"?

Author: RElliott

Subject: Highlight

Date: 6/30/2008 6:16:52 PM

T ACCEPT - DONE

theSP26

s/b

the SP26

Author: RElliott

Subject: Highlight

Date: 6/30/2008 6:16:52 PM

T ACCEPT - DONE

"and"

s/b

" and"

Author: lsi-bday

Subject: Highlight

Date: 5/21/2008 10:25:02 PM

T ACCEPT - DONE (agree. The Broadcast also occurs on transitions from SP1 to SP4 , SP4 to SP5, and SP4 to SP6, and SP7 to SP6, none of which are mentioned by e). This change will pick up all of them. It is harder to understand why that confirmation is sent, though...)

d) and e)

Suggest simplifying language to just:

d) after an expander phy's SP state machine sends a SATA Port Selector Change confirmation (see 6.8.3);

Author: RElliott

Subject: Highlight

Date: 6/30/2008 6:16:52 PM

T REJECT (moot as the item was totally reworded)

COMWAKE detected

s/b

COMWAKE Detected

DISCOVER response upon entry to SP1:OOB_AwaitCOMX, and if no **COMWAKE detected** message was received while in SP1:OOB_AwaitCOMX before the transition to SP0:OOB_COMINIT (see 6.8.3.3.2);

- f) after an expander phy completes the link reset sequence (see 7.9);
- g) after a virtual phy has been enabled or completed processing a reset requested by the SMP PHY CONTROL function LINK RESET or HARD RESET phy operations (see 10.4.3.28); and
- h) after an STP/SATA bridge receives an initial Register - Device to host FIS (see 9.3.1).

In zoning expander devices with zoning enabled, forwarding Broadcasts is subject to restrictions defined in 4.9.5.

In zoning expander devices with zoning enabled, a Broadcast (Change) for an expander phy-related reason shall be originated from the source zone group of the expander phy causing the Broadcast (Change) or from zone group 1.

Expander devices shall originate Broadcast (Change) for the following expander device-related reasons:

- a) after a self-configuring expander device has changed its **CONFIGURING bit** from one to zero in the SMP REPORT GENERAL response (see 10.4.3.4) as described in 4.7.2. In zoning expander devices with zoning enabled, the source zone group shall be 01h;
- b) after a locked expander device is unlocked (see 4.9.6.5 and 10.4.3.23), with the source zone group as specified in 4.9.6.5 and 10.4.3.23.

Expander devices shall forward Broadcast (Change) for **the following reasons:**

- a) after an expander phy receives Broadcast (Change).

For a virtual phy, if there is any time after a reset is originated during which connection requests to the attached SAS address result in connection responses of OPEN_REJECT (**NO DESTINATION**), the expander device shall originate the Broadcast (Change) twice, once at the start of the reset (i.e., when the SAS address becomes unavailable) and once at its completion (i.e., when the SAS address becomes available). If there is no such time window, the expander device shall originate the Broadcast (Change) once.

SAS initiator ports may originate Broadcast (Change) to force other SAS initiator ports and expander ports to re-run the discover **process, but should not be sent by** SAS target ports.

~~A SAS initiator port that receives Broadcast (Change) shall follow the SAS initiator device rules (see 7.9.2) to discover and configure the topology.~~

~~An expander device that receives Broadcast (Change) shall follow the expander device rules (see 7.9.3) to discover and configure the topology.~~

See 10.4.3.4 for details on counting Broadcast (Change) origination in an expander device.

7.12 Connections

7.12.1 Connections overview

A connection is opened between a SAS initiator port and a SAS target port before communication begins. A connection is established between one SAS initiator phy in the SAS initiator port and one SAS target phy in the SAS target port.

SSP initiator ports open SSP connections to transmit SCSI commands, task management functions, or transfer write data. SSP target ports open SSP connections to **transfer read data or transmit status.**

SMP initiator ports open SMP connections to transmit SMP requests and receive SMP responses.

STP initiator ports and STP target ports open STP connections to transmit SATA frames. An STP target port in an expander device opens STP connections on behalf of SATA devices.

The OPEN address frame is used to request that a connection be opened (see 7.12.2.1). AIP, OPEN_ACCEPT and OPEN_REJECT are the responses to an OPEN address frame (see 7.12.2.2). BREAK is used to abort connection requests (see 7.12.6) and to unilaterally break a connection (see 7.12.8). CLOSE is used **for orderly closing a connection** (see 7.12.7).

Page: 343

Author: RElliott
Subject: Highlight
Date: 6/30/2008 6:16:52 PM
T REJECT (moot as the item was totally reworded and combined with d))

COMWAKE detected
s/b
COMWAKE Detected

Author: RElliott
Subject: Highlight
Date: 6/30/2008 6:16:52 PM
T ACCEPT - DONE

CONFIGURING bit
s/b
SELF CONFIGURING bit

to match Isi-bbesmer comment on first page

Author: Isi-gpenokie
Subject: Highlight
Date: 5/6/2008 4:07:49 PM
T ACCEPT - DONE

This << be 01h; >> should be << be 01h; and>>

Author: RElliott
Subject: Highlight
Date: 6/30/2008 6:16:52 PM
T ACCEPT - DONE

see 4.9.6.5
s/b
see 4.9.6.5, 4.9.6.6

since zone lock inactivity timer expiration also causes Broadcast (Change)

Author: RElliott
Subject: Highlight
Date: 6/30/2008 6:16:52 PM
T ACCEPT - DONE

in 4.9.6.5
s/b
in 4.9.6.5, 4.9.6.6

since zone lock inactivity timer expiration also causes Broadcast (Change)

Author: Isi-gpenokie
Subject: Highlight
Date: 5/6/2008 4:07:49 PM
T ACCEPT - DONE

This << the following reasons: >> should be << the following reason: >>

Author: Isi-gpenokie
Subject: Highlight
Date: 5/21/2008 10:26:39 PM

Comments from page 343 continued on next page

DISCOVER response upon entry to SP1:OOB_AwaitCOMX, and if no **COMWAKE detected** message was received while in SP1:OOB_AwaitCOMX before the transition to SP0:OOB_COMINIT (see 6.8.3.3.2);

- f) after an expander phy completes the link reset sequence (see 7.9);
- g) after a virtual phy has been enabled or completed processing a reset requested by the SMP PHY CONTROL function LINK RESET or HARD RESET phy operations (see 10.4.3.28); and
- h) after an STP/SATA bridge receives an initial Register - Device to host FIS (see 9.3.1).

In zoning expander devices with zoning enabled, forwarding Broadcasts is subject to restrictions defined in 4.9.5.

In zoning expander devices with zoning enabled, a Broadcast (Change) for an expander phy-related reason shall be originated from the source zone group of the expander phy causing the Broadcast (Change) or from zone group 1.

Expander devices shall originate Broadcast (Change) for the following expander device-related reasons:

- a) after a self-configuring expander device has changed its **CONFIGURING bit** from one to zero in the SMP REPORT GENERAL response (see 10.4.3.4) as described in 4.7.2. In zoning expander devices with zoning enabled, the source zone group shall be 01h;
- b) after a locked expander device is unlocked (see 4.9.6.5 and 10.4.3.23), with the source zone group as specified in 4.9.6.5 and 10.4.3.23.

Expander devices shall forward Broadcast (Change) for **the following reasons:**

- a) after an expander phy receives Broadcast (Change).

For a virtual phy, if there is any time after a reset is originated during which connection requests to the attached SAS address result in connection responses of OPEN_REJECT (**NO DESTINATION**), the expander device shall originate the Broadcast (Change) twice, once at the start of the reset (i.e., when the SAS address becomes unavailable) and once at its completion (i.e., when the SAS address becomes available). If there is no such time window, the expander device shall originate the Broadcast (Change) once.

SAS initiator ports may originate Broadcast (Change) to force other SAS initiator ports and expander ports to re-run the discover **process, but should not be sent by** SAS target ports.

~~A SAS initiator port that receives Broadcast (Change) shall follow the SAS initiator device rules (see 7.9.2) to discover and configure the topology.~~

~~An expander device that receives Broadcast (Change) shall follow the expander device rules (see 7.9.3) to discover and configure the topology.~~

See 10.4.3.4 for details on counting Broadcast (Change) origination in an expander device.

7.12 Connections

7.12.1 Connections overview

A connection is opened between a SAS initiator port and a SAS target port before communication begins. A connection is established between one SAS initiator phy in the SAS initiator port and one SAS target phy in the SAS target port.

SSP initiator ports open SSP connections to transmit SCSI commands, task management functions, or transfer write data. SSP target ports open SSP connections to **transfer read data or transmit status.**

SMP initiator ports open SMP connections to transmit SMP requests and receive SMP responses.

STP initiator ports and STP target ports open STP connections to transmit SATA frames. An STP target port in an expander device opens STP connections on behalf of SATA devices.

The OPEN address frame is used to request that a connection be opened (see 7.12.2.1). AIP, OPEN_ACCEPT and OPEN_REJECT are the responses to an OPEN address frame (see 7.12.2.2). BREAK is used to abort connection requests (see 7.12.6) and to unilaterally break a connection (see 7.12.8). CLOSE is used **for orderly closing a connection** (see 7.12.7).

T ACCEPT - DONE

This << (NO DESTINATION), the expander >> should be << (NO DESTINATION), then the expander >>

● Author: RElliott
Subject: Highlight
Date: 6/30/2008 6:16:52 PM

T ACCEPT - DONE

the
s/b
then the

● Author: lsi-gpenokie
Subject: Highlight
Date: 5/6/2008 4:07:49 PM
T ACCEPT - DONE ("SAS target ports not originate Broadcast (Change).")

This << process, but should not be sent by >> should be << process, but a Broadcast (Change) should not be sent by >>

● Author: RElliott
Subject: Cross-Out
Date: 9/3/2008 5:22:45 PM
~~**T** ACCEPT - DONE~~

Delete:

A SAS initiator port that receives Broadcast (Change) shall follow the SAS initiator device rules (see 7.9.2) to discover and configure the topology.

An expander device that receives Broadcast (Change) shall follow the expander device rules (see 7.9.3) to discover and configure the topology.

This section is for generation only, not reception. 7.9.2 and 7.9.3 are being moved into 4.7 to collect all app client responsibilities in one place.

● Author: lsi-bday
Subject: Highlight
Date: 9/1/2008 3:18:10 PM
T ACCEPT - DONE (comments added next to each change.)

This section should indicate logical phys.

● Author: ibm-steve-wallace
Subject: Highlight
Date: 5/21/2008 10:30:31 PM
T ACCEPT - DONE (as "transfer read data, request write data, and transmit service responses". Also changed "or" to "and" in the previous sentence.)

SSP target ports also open a connection to transfer an XFER_RDY (request write data).

● Author: elx-bmartin
Subject: Highlight
Date: 5/25/2008 8:48:07 PM
T ACCEPT - DONE

a
s.b.
of a

● Author: wdc-mevans
Subject: Highlight
Date: 5/25/2008 8:48:18 PM
T REJECT

for orderly closing a connection
s/b
to close a connection in a normal manner.

Comments from page 343 continued on next page

DISCOVER response upon entry to SP1:OOB_AwaitCOMX, and if no **COMWAKE detected** message was received while in SP1:OOB_AwaitCOMX before the transition to SP0:OOB_COMINIT (see 6.8.3.3.2);

- f) after an expander phy completes the link reset sequence (see 7.9);
- g) after a virtual phy has been enabled or completed processing a reset requested by the SMP PHY CONTROL function LINK RESET or HARD RESET phy operations (see 10.4.3.28); and
- h) after an STP/SATA bridge receives an initial Register - Device to host FIS (see 9.3.1).

In zoning expander devices with zoning enabled, forwarding Broadcasts is subject to restrictions defined in 4.9.5.

In zoning expander devices with zoning enabled, a Broadcast (Change) for an expander phy-related reason shall be originated from the source zone group of the expander phy causing the Broadcast (Change) or from zone group 1.

Expander devices shall originate Broadcast (Change) for the following expander device-related reasons:

- a) after a self-configuring expander device has changed its **CONFIGURING bit** from one to zero in the SMP REPORT GENERAL response (see 10.4.3.4) as described in 4.7.2. In zoning expander devices with zoning enabled, the source zone group shall be 01h;
- b) after a locked expander device is unlocked (see 4.9.6.5 and 10.4.3.23), with the source zone group as specified in 4.9.6.5 and 10.4.3.23.

Expander devices shall forward Broadcast (Change) for **the following reasons:**

- a) after an expander phy receives Broadcast (Change).

For a virtual phy, if there is any time after a reset is originated during which connection requests to the attached SAS address result in connection responses of OPEN_REJECT (**NO DESTINATION**), the expander device shall originate the Broadcast (Change) twice, once at the start of the reset (i.e., when the SAS address becomes unavailable) and once at its completion (i.e., when the SAS address becomes available). If there is no such time window, the expander device shall originate the Broadcast (Change) once.

SAS initiator ports may originate Broadcast (Change) to force other SAS initiator ports and expander ports to re-run the discover **process, but should not be sent by** SAS target ports.

~~A SAS initiator port that receives Broadcast (Change) shall follow the SAS initiator device rules (see 7.9.2) to discover and configure the topology.~~

~~An expander device that receives Broadcast (Change) shall follow the expander device rules (see 7.9.3) to discover and configure the topology.~~

See 10.4.3.4 for details on counting Broadcast (Change) origination in an expander device.

7.12 Connections

7.12.1 Connections overview

A connection is opened between a SAS initiator port and a SAS target port before communication begins. A connection is established between one SAS initiator phy in the SAS initiator port and one SAS target phy in the SAS target port.

SSP initiator ports open SSP connections to transmit SCSI commands, task management functions, or transfer write data. SSP target ports open SSP connections to **transfer read data or transmit status.**

SMP initiator ports open SMP connections to transmit SMP requests and receive SMP responses.

STP initiator ports and STP target ports open STP connections to transmit SATA frames. An STP target port in an expander device opens STP connections on behalf of SATA devices.

The OPEN address frame is used to request that a connection be opened (see 7.12.2.1). AIP, OPEN_ACCEPT and OPEN_REJECT are the responses to an OPEN address frame (see 7.12.2.2). BREAK is used to abort connection requests (see 7.12.6) and to unilaterally break a connection (see 7.12.8). CLOSE is used **for orderly closing a connection** (see 7.12.7).

Connections use a single pathway from the SAS initiator phy to the SAS target phy. While a connection is open, only one pathway shall be used for that connection.

For STP connections, connections may be between the STP initiator port and an STP target port of an STP/SATA bridge in an expander device. The SATA device behind the STP/SATA bridge is not aware of SAS connection management.

A wide port may have separate connections on each of its phys.

7.12.2 Opening a connection

7.12.2.1 Connection request

The OPEN address frame (see 7.8.3) is used to open a connection from a source port to a destination port using one source phy and one destination phy.

To make a connection request, the source port shall transmit an OPEN address frame through an available phy. The source phy shall transmit idle dwords after the OPEN address frame until it receives a response or aborts the connection request with BREAK.

After transmitting an OPEN address frame, the source phy shall initialize and start a 1 ms Open Timeout timer. Whenever an AIP is received, the source phy shall reinitialize and restart the Open Timeout timer. Source phys are not required to enforce a limit on the number of AIPs received before aborting the connection request. When any connection response is received, the source phy shall reinitialize the Open Timeout timer. If the Open Timeout timer expires before a connection response is received, the source phy shall transmit BREAK to abort the connection request (see 7.12.6).

The OPEN address frame flows through expander devices onto intermediate physical links. If an expander device on the pathway is unable to forward the connection request, it returns OPEN_REJECT (see 7.12.4). If the OPEN address frame reaches the destination, it returns either OPEN_ACCEPT or OPEN_REJECT unless the OPEN address frame passed an OPEN address frame from the destination with higher arbitration priority (see 7.12.3). Rate matching shall be used on any physical links in the pathway with negotiated physical link rates that are faster than the requested connection rate (see 7.13).

A wide port should not attempt to establish more connections to a destination port than the destination port width or the width of the narrowest physical link on the pathway to the destination port. A wide port should not attempt to establish more connections than the width of the narrowest common physical link on the pathways to the destination ports of those connections. Additional requirements for STP connection requests are defined in 7.17.5. Additional requirements for SMP connection requests are defined in 7.18.3.

Page: 344

Author: RElliott
Subject: Highlight
Date: 6/30/2008 6:16:52 PM
T ACCEPT - DONE

phys
s/b
logical phys

(per Isi-bday comment on this section)

Author: RElliott
Subject: Highlight
Date: 6/30/2008 6:16:52 PM
T ACCEPT - DONE

one source phy and one destination phy
s/b
one source phy (i.e., one logical phy in the source port) and one destination phy (i.e., one logical phy in the destination port)

Author: RElliott
Subject: Highlight
Date: 6/30/2008 6:16:52 PM
T ACCEPT - DONE

available phy
s/b
available logical phy

(per Isi-bday comment on this section)

Author: wdc-mevans
Subject: Highlight
Date: 5/30/2008 6:03:37 PM
T REJECT (first noun/subject convention)

it
s/b
the phy

Author: RElliott
Subject: Highlight
Date: 6/30/2008 6:16:52 PM
T ACCEPT - DONE

the
s/b
then the

Author: RElliott
Subject: Highlight
Date: 6/30/2008 6:16:52 PM
T ACCEPT - DONE

physical links
s/b
logical links

Comments from page 344 continued on next page

Connections use a single pathway from the SAS initiator phy to the SAS target phy. While a connection is open, only one pathway shall be used for that connection.

For STP connections, connections may be between the STP initiator port and an STP target port of an STP/SATA bridge in an expander device. The SATA device behind the STP/SATA bridge is not aware of SAS connection management.

A wide port may have separate connections on each of its **phys**.

7.12.2 Opening a connection

7.12.2.1 Connection request

The OPEN address frame (see 7.8.3) is used to open a connection from a source port to a destination port using **one source phy and one destination phy**.

To make a connection request, the source port shall transmit an OPEN address frame through an **available phy**. The source phy shall transmit idle dwords after the OPEN address frame until **it** receives a response or aborts the connection request with BREAK.

After transmitting an OPEN address frame, the source phy shall initialize and start a 1 ms Open Timeout timer. Whenever an AIP is received, the source phy shall reinitialize and restart the Open Timeout timer. Source phys are not required to enforce a limit on the number of AIPs received before aborting the connection request. When any connection response is received, the source phy shall reinitialize the Open Timeout timer. If the Open Timeout timer expires before a connection response is received, **the** source phy shall transmit BREAK to abort the connection request (see 7.12.6).

The OPEN address frame flows through expander devices onto intermediate **physical links**. If an expander device on the pathway is unable to forward the connection request, **it** returns OPEN_REJECT (see 7.12.4). If the OPEN address frame reaches the **destination**, **it** returns either OPEN_ACCEPT or OPEN_REJECT unless the OPEN address frame passed an OPEN address frame from the **destination** with higher arbitration priority (see 7.12.3). Rate matching shall be used on any physical links in the pathway with negotiated **physical link** rates that are faster than the requested connection rate (see 7.13).

A wide port should not attempt to establish more connections to a destination port than the destination port width or the width of the narrowest **physical link** on the pathway to the destination port. A wide port should not attempt to establish more connections than the width of the narrowest common **physical link** on the pathways to the destination ports of those connections. Additional requirements for STP connection requests are defined in 7.17.5. Additional requirements for SMP connection requests are defined in 7.18.3.

Author: wdc-mevans
Subject: Highlight
Date: 5/21/2008 10:31:27 PM
 ACCEPT - DONE (as "then that expander device")

it
s/b
the expander device

Author: wdc-mevans
Subject: Highlight
Date: 5/21/2008 10:32:58 PM
 REJECT (That would be incorrect. This indicates the "it" needs clarification. Changed to "phy, then the destination phy")

it
s/b
the expander device

Author: RElliott
Subject: Highlight
Date: 6/30/2008 6:16:52 PM
 ACCEPT - DONE

destination
s/b
destination phy

Author: RElliott
Subject: Highlight
Date: 6/30/2008 6:16:52 PM
 ACCEPT - DONE

destination
s/b
destination phy

Author: Isi-bbesmer
Subject: Highlight
Date: 5/25/2008 8:49:04 PM
 ACCEPT - DONE (and "physical links" to "logical links" a few words earlier)

physical
s/b
logical

Author: Isi-bday
Subject: Highlight
Date: 5/21/2008 10:35:10 PM
 ACCEPT - DONE

physical
s/b
logical

Author: Isi-bbesmer
Subject: Note
Date: 5/21/2008 10:36:18 PM
 ACCEPT - DONE (changed physical link to logical link twice per Isi-bday comments. This seems to fix the problem.)

This paragraph does not take multi-plexing into consideration.

Author: Isi-bday
Subject: Highlight

Comments from page 344 continued on next page

Connections use a single pathway from the SAS initiator phy to the SAS target phy. While a connection is open, only one pathway shall be used for that connection.

For STP connections, connections may be between the STP initiator port and an STP target port of an STP/SATA bridge in an expander device. The SATA device behind the STP/SATA bridge is not aware of SAS connection management.

A wide port may have separate connections on each of its **phys**.

7.12.2 Opening a connection

7.12.2.1 Connection request

The OPEN address frame (see 7.8.3) is used to open a connection from a source port to a destination port using **one source phy and one destination phy**.

To make a connection request, the source port shall transmit an OPEN address frame through an **available phy**. The source phy shall transmit idle dwords after the OPEN address frame until **it** receives a response or aborts the connection request with BREAK.

After transmitting an OPEN address frame, the source phy shall initialize and start a 1 ms Open Timeout timer. Whenever an AIP is received, the source phy shall reinitialize and restart the Open Timeout timer. Source phys are not required to enforce a limit on the number of AIPs received before aborting the connection request. When any connection response is received, the source phy shall reinitialize the Open Timeout timer. If the Open Timeout timer expires before a connection response is received, **the** source phy shall transmit BREAK to abort the connection request (see 7.12.6).

The OPEN address frame flows through expander devices onto intermediate **physical links**. If an expander device on the pathway is unable to forward the connection request, **it** returns OPEN_REJECT (see 7.12.4). If the OPEN address frame reaches the **destination**, **it** returns either OPEN_ACCEPT or OPEN_REJECT unless the OPEN address frame passed an OPEN address frame from the **destination** with higher arbitration priority (see 7.12.3). Rate matching shall be used on any physical links in the pathway with negotiated **physical** link rates that are faster than the requested connection rate (see 7.13).

 A wide port should not attempt to establish more connections to a destination port than the destination port width or the width of the narrowest **physical** link on the pathway to the destination port. A wide port should not attempt to establish more connections than the width of the narrowest common **physical** link on the pathways to the destination ports of those connections. Additional requirements for STP connection requests are defined in 7.17.5. Additional requirements for SMP connection requests are defined in 7.18.3.

Date: 5/21/2008 10:35:20 PM

T ACCEPT - DONE

physical

s/b

logical

Figure 179 shows an example of the simultaneous connection recommendations for wide ports.

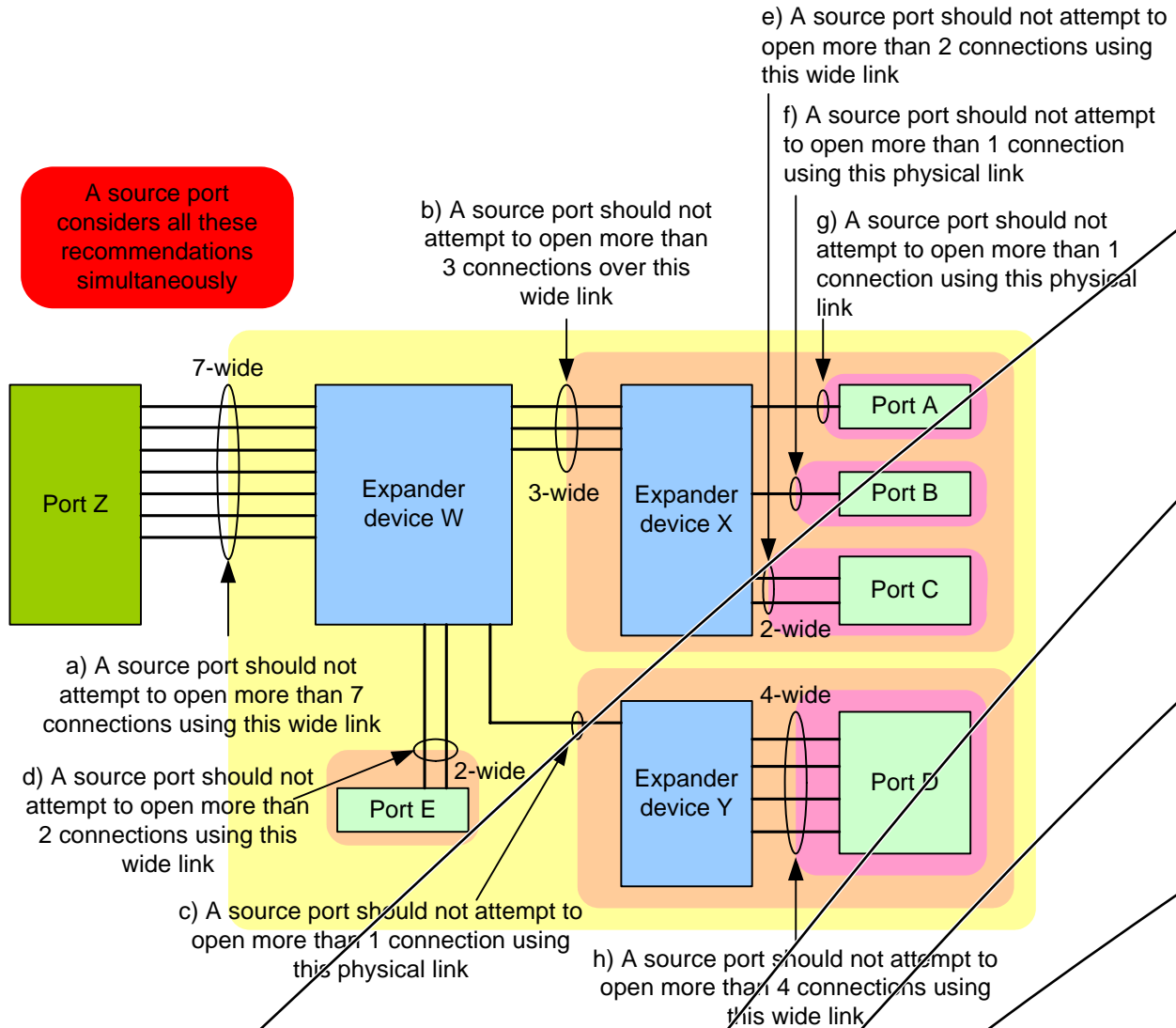

Figure 179 — Example simultaneous connection recommendations for wide ports

In figure 179, some of the recommendations are combined as follows:

- a) recommendations a), b), and e) together mean port Z should not attempt to open more than 2 connections to port C;
- b) recommendations a), b), e), f), and g) together mean that if port Z has 2 connections open to ports A, B, and X, it should not attempt to open more than 1 connection to port C. If it has 6 connections open to ports A, B, D, E, W, X, and Y, it should not attempt to open more than 1 connection to port C; and
- c) recommendations a), c), and h) together mean port Z should not attempt to open more than 1 connection to port D. If it has a connection open to port Y, it should not attempt to open another connection to port D until the first connection is closed.

● Author: Isi-bday
Subject: Highlight
Date: 6/28/2008 6:06:16 PM

T ACCEPT - DONE (added " Multiplexing is disabled in this example.")

In figure 179
This needs statement somewhere saying no multiplexxing in this example.

● Author: RElliott
Subject: Highlight
Date: 8/27/2008 7:01:15 PM

T ACCEPT - DONE

mean
s/b
specify that

● Author: RElliott
Subject: Highlight
Date: 8/27/2008 7:01:20 PM

T ACCEPT - DONE

mean
s/b
specify that

● Author: RElliott
Subject: Highlight
Date: 8/27/2008 7:01:27 PM

T ACCEPT - DONE

mean
s/b
specify that

7.12.2.2 Results of a connection request

After a phy transmits an OPEN address frame, it shall expect one or more of the results listed in table 141.

Table 141 — Connection Results of a connection request

Result	Description
Receive AIP	Arbitration in progress. When an expander device is trying to open a connection to the selected destination port, it returns an AIP to the source phy. The source phy shall reinitialize and restart its Open Timeout timer each time it receives an AIP. AIP is sent by an expander device while it is internally arbitrating for access to an expander port.
Receive OPEN_ACCEPT	Connection request accepted. OPEN_ACCEPT is transmitted by the destination phy.
Receive OPEN_REJECT	Connection request rejected. OPEN_REJECT is transmitted by the destination phy or by an expander device in the partial pathway. The different versions are described in 7.2.6.10. See 4.5 for I_T nexus loss handling. See 7.8.3 for handling of OPEN_REJECT (CONNECTION RATE NOT SUPPORTED) for connection rates greater than 1.5 Gbps.
Receive OPEN address frame	If AIP has been previously received, this indicates an overriding connection request. If AIP has not yet been received, this indicates two connection requests crossing on the physical link. Arbitration fairness determines which one wins (see 7.12.3).
Receive BREAK	The destination phy or an expander device in the partial pathway may reply with BREAK indicating the connection is not being established.
Open Timeout timer expires	The source phy shall abort the connection request by transmitting BREAK (see 7.12.6). See 4.5 for I_T nexus loss handling.

7.12.3 Arbitration fairness

SAS supports least-recently used arbitration fairness for connection requests.

Each SAS port and expander port shall include an Arbitration Wait Time timer which counts the time from the moment when the port makes a connection request until the request is accepted or rejected. The Arbitration Wait Time timer is in the port layer state machine (see 8.2.2). The Arbitration Wait Time timer shall count in microseconds from 0 μ s to 32 767 μ s and in milliseconds from 32 768 μ s to 32 767 ms + 32 768 μ s. The Arbitration Wait Time timer shall stop incrementing when its value reaches 32 767 ms + 32 768 μ s.

A SAS port (i.e., SAS initiator ports and SAS target ports) shall start the Arbitration Wait Time timer when it transmits the first OPEN address frame (see 7.8.3) for the connection request. When the SAS port retransmits the OPEN address frame (e.g., after losing arbitration and handling an inbound OPEN address frame), it shall set the ARBITRATION WAIT TIME field to the current value of the Arbitration Wait Time timer.

A SAS port should set the Arbitration Wait Time timer to zero when it transmits the first OPEN address frame for the connection request. A SAS initiator port or SAS target port may be unfair by setting the ARBITRATION WAIT TIME field in the OPEN address frame (see 7.8.3) to a higher value than its Arbitration Wait Time timer indicates. However, an unfair SAS port shall not set the ARBITRATION WAIT TIME field to a value greater than or equal to 8000h; this limits the amount of unfairness and helps prevent livelocks.

The expander port that receives an OPEN address frame shall set the Arbitration Wait Time timer to the value of the incoming ARBITRATION WAIT TIME field and start the Arbitration Wait Time timer as it arbitrates for internal access to the outgoing expander port. When the expander device transmits the OPEN address frame out another expander port, it shall set the outgoing ARBITRATION WAIT TIME field to the current value of the Arbitration Wait Time timer maintained by the incoming expander port.

Page: 346

Author: wdc-mevans
Subject: Highlight
Date: 5/22/2008 10:04:45 AM
T REJECT (first noun/subject convention)

it
s/b
the phy

Author: RElliott
Subject: Highlight
Date: 6/30/2008 6:16:52 PM
T ACCEPT - DONE

phy
s/b
logical phy

(per Isi-bday comment on this section)

Author: RElliott
Subject: Highlight
Date: 6/30/2008 6:16:52 PM
T ACCEPT - DONE

When
s/b
While

Author: wdc-mevans
Subject: Highlight
Date: 5/21/2008 10:40:28 PM
T REJECT ("expander device" is the first noun and the subject of the sentence, the two normal clues about what "it" is)

it
s/b
the expander device

Author: wdc-mevans
Subject: Highlight
Date: 5/21/2008 10:40:48 PM
T REJECT (first noun/subject convention)

it
s/b
the source phy

Author: RElliott
Subject: Underline
Date: 6/30/2008 6:16:52 PM
T ACCEPT - DONE ("While an expander device is trying to open a connection to the selected destination port (e.g., while it is internally arbitrating for access to an expander port), it...")

Delete "AIP is sent by an expander device while it is internally arbitrating for access to an expander port."
and make it into an e.g. in the second sentence. This avoids the ambiguous "it"

Comments from page 346 continued on next page

7.12.2.2 Results of a connection request

After a phy transmits an OPEN address frame, it shall expect one or more of the results listed in table 141.

Table 141 — Connection Results of a connection request

Result	Description
Receive AIP	Arbitration in progress. When an expander device is trying to open a connection to the selected destination port, it returns an AIP to the source phy. The source phy shall reinitialize and restart its Open Timeout timer each time it receives an AIP. <u>AIP is sent by an expander device while it is internally arbitrating for access to an expander port.</u>
Receive OPEN_ACCEPT	Connection request accepted. OPEN_ACCEPT is transmitted by the destination phy.
Receive OPEN_REJECT	Connection request rejected. OPEN_REJECT is transmitted by the destination phy or by an expander device in the partial pathway. The different versions are described in 7.2.6.10. See 4.5 for I_T nexus loss handling. See 7.8.3 for handling of OPEN_REJECT (CONNECTION RATE NOT SUPPORTED) for connection rates greater than 1.5 Gbps.
Receive OPEN address frame	If AIP has been previously received, this indicates an overriding connection request. If AIP has not yet been received, this indicates two connection requests crossing on the physical link. Arbitration fairness determines which one wins (see 7.12.3).
Receive BREAK	The destination phy or an expander device in the partial pathway may reply with BREAK indicating the connection is not being established.
Open Timeout timer expires	The source phy shall abort the connection request by transmitting BREAK (see 7.12.6). See 4.5 for I_T nexus loss handling.

7.12.3 Arbitration fairness

SAS supports least-recently used arbitration fairness for connection requests.

Each SAS port and expander port shall include an Arbitration Wait Time timer which counts the time from the moment when the port makes a connection request until the request is accepted or rejected. The Arbitration Wait Time timer is in the port layer state machine (see 8.2.2). The Arbitration Wait Time timer shall count in microseconds from 0 μ s to 32 767 μ s and in milliseconds from 32 768 μ s to 32 767 ms + 32 768 μ s. The Arbitration Wait Time timer shall stop incrementing when its value reaches 32 767 ms + 32 768 μ s.

A SAS port (i.e., SAS initiator ports and SAS target ports) shall start the Arbitration Wait Time timer when it transmits the first OPEN address frame (see 7.8.3) for the connection request. When the SAS port retransmits the OPEN address frame (e.g., after losing arbitration and handling an inbound OPEN address frame), it shall set the ARBITRATION WAIT TIME field to the current value of the Arbitration Wait Time timer.

A SAS port should set the Arbitration Wait Time timer to zero when it transmits the first OPEN address frame for the connection request. A SAS initiator port or SAS target port may be unfair by setting the ARBITRATION WAIT TIME field in the OPEN address frame (see 7.8.3) to a higher value than its Arbitration Wait Time timer indicates. However, an unfair SAS port shall not set the ARBITRATION WAIT TIME field to a value greater than or equal to 8000h; this limits the amount of unfairness and helps prevent livelocks.

The expander port that receives an OPEN address frame shall set the Arbitration Wait Time timer to the value of the incoming ARBITRATION WAIT TIME field and start the Arbitration Wait Time timer as it arbitrates for internal access to the outgoing expander port. When the expander device transmits the OPEN address frame out another expander port, it shall set the outgoing ARBITRATION WAIT TIME field to the current value of the Arbitration Wait Time timer maintained by the incoming expander port.

Author: RElliott
Subject: Highlight
Date: 6/30/2008 6:16:52 PM
T REJECT (sentence merged into earlier sentence)

sent
s/b
transmitted

Author: RElliott
Subject: Highlight
Date: 6/30/2008 6:16:52 PM
T ACCEPT - DONE

this
s/b
then this

Author: RElliott
Subject: Highlight
Date: 6/30/2008 6:16:52 PM
T ACCEPT - DONE

this
s/b
then this

Author: RElliott
Subject: Highlight
Date: 6/30/2008 6:16:52 PM
T ACCEPT - DONE

physical link
s/b
logical link

Author: RElliott
Subject: Underline
Date: 6/30/2008 6:16:52 PM
T ACCEPT - DONE

SAS initiator ports and SAS target ports
s/b
a SAS initiator port or a SAS target port
to match the tense of "A SAS port"

Author: wdc-mevans
Subject: Highlight
Date: 5/21/2008 10:41:55 PM
T REJECT (first noun/subject convention)

it
s/b
the SAS port

Author: wdc-mevans
Subject: Highlight
Date: 5/21/2008 10:42:07 PM
T REJECT (first noun/subject convention)

it
s/b

7.12.2.2 Results of a connection request

After a phy transmits an OPEN address frame, it shall expect one or more of the results listed in table 141.

Table 141 — Connection Results of a connection request

Result	Description
Receive AIP	Arbitration in progress. When an expander device is trying to open a connection to the selected destination port, it returns an AIP to the source phy. The source phy shall reinitialize and restart its Open Timeout timer each time it receives an AIP. <u>AIP is sent by an expander device while it is internally arbitrating for access to an expander port.</u>
Receive OPEN_ACCEPT	Connection request accepted. OPEN_ACCEPT is transmitted by the destination phy.
Receive OPEN_REJECT	Connection request rejected. OPEN_REJECT is transmitted by the destination phy or by an expander device in the partial pathway. The different versions are described in 7.2.6.10. See 4.5 for I_T nexus loss handling. See 7.8.3 for handling of OPEN_REJECT (CONNECTION RATE NOT SUPPORTED) for connection rates greater than 1.5 Gbps.
Receive OPEN address frame	If AIP has been previously received, this indicates an overriding connection request. If AIP has not yet been received, this indicates two connection requests crossing on the physical link. Arbitration fairness determines which one wins (see 7.12.3).
Receive BREAK	The destination phy or an expander device in the partial pathway may reply with BREAK indicating the connection is not being established.
Open Timeout timer expires	The source phy shall abort the connection request by transmitting BREAK (see 7.12.6). See 4.5 for I_T nexus loss handling.

7.12.3 Arbitration fairness

SAS supports least-recently used arbitration fairness for connection requests.

Each SAS port and expander port shall include an Arbitration Wait Time timer which counts the time from the moment when the port makes a connection request until the request is accepted or rejected. The Arbitration Wait Time timer is in the port layer state machine (see 8.2.2). The Arbitration Wait Time timer shall count in microseconds from 0 μ s to 32 767 μ s and in milliseconds from 32 768 μ s to 32 767 ms + 32 768 μ s. The Arbitration Wait Time timer shall stop incrementing when its value reaches 32 767 ms + 32 768 μ s.

A SAS port (i.e., SAS initiator ports and SAS target ports) shall start the Arbitration Wait Time timer when it transmits the first OPEN address frame (see 7.8.3) for the connection request. When the SAS port retransmits the OPEN address frame (e.g., after losing arbitration and handling an inbound OPEN address frame), it shall set the ARBITRATION WAIT TIME field to the current value of the Arbitration Wait Time timer.

A SAS port should set the Arbitration Wait Time timer to zero when it transmits the first OPEN address frame for the connection request. A SAS initiator port or SAS target port may be unfair by setting the ARBITRATION WAIT TIME field in the OPEN address frame (see 7.8.3) to a higher value than its Arbitration Wait Time timer indicates. However, an unfair SAS port shall not set the ARBITRATION WAIT TIME field to a value greater than or equal to 8000h; this limits the amount of unfairness and helps prevent livelocks.

The expander port that receives an OPEN address frame shall set the Arbitration Wait Time timer to the value of the incoming ARBITRATION WAIT TIME field and start the Arbitration Wait Time timer as it arbitrates for internal access to the outgoing expander port. When the expander device transmits the OPEN address frame out another expander port, it shall set the outgoing ARBITRATION WAIT TIME field to the current value of the Arbitration Wait Time timer maintained by the incoming expander port.

the SAS port

● Author: wdc-mevans
Subject: Highlight
Date: 5/21/2008 10:42:42 PM
T REJECT (first noun/subject convention)

it
s/b
the SAS port

● Author: lsi-gpenokie
Subject: Highlight
Date: 5/25/2008 8:49:48 PM
T ACCEPT - DONE

This << equal to 8000h; this limits the amount of unfairness and helps >> should be << equal to 8000h to limit the amount of unfairness and help>>

● Author: wdc-mevans
Subject: Highlight
Date: 5/21/2008 10:42:17 PM
T REJECT (first noun/subject convention)

it
s/b
the expander port

● Author: wdc-mevans
Subject: Highlight
Date: 5/21/2008 10:42:28 PM
T REJECT (first noun/subject convention)

it
s/b
the expander port

A SAS port shall stop the Arbitration Wait Time timer and set it to zero when it has no more frames to send.

A SAS port shall stop the Arbitration Wait Time timer and set it to zero when it receives one of the following connection responses:

- a) OPEN_ACCEPT;
- b) OPEN_REJECT (PROTOCOL NOT SUPPORTED);
- c) OPEN_REJECT (RESERVED ABANDON 1);
- d) OPEN_REJECT (RESERVED ABANDON 2);
- e) OPEN_REJECT (RESERVED ABANDON 3);
- f) OPEN_REJECT (STP RESOURCES BUSY); or
- g) OPEN_REJECT (WRONG DESTINATION).

NOTE 61 - Connection responses that are conclusively from the destination phy (see table 122 and table 123 in 7.2.6.10) are included in the list. Except for OPEN_REJECT (RETRY), connection responses that are only from or may be from expander phys are not included.

When an OPEN_REJECT (RETRY) is received:

- a) if the CONTINUE AWT bit is set to one in the Protocol Specific Port mode page (see 10.2.7.4), then a connection response of OPEN_REJECT (RETRY) shall not stop the Arbitration Wait Time timer and shall not set it to zero; or
- b) If the CONTINUE AWT bit is set to zero, then a SAS port shall stop the Arbitration Wait Time timer and set it to zero.

A SAS port should not stop the Arbitration Wait Time timer and set it to zero when it receives an incoming OPEN address frame that has priority over the outgoing OPEN address frame according to table 142, regardless of whether it replies with an OPEN_ACCEPT or an OPEN_REJECT.

When arbitrating for access to an outgoing expander port, the expander device shall select the connection request based on the rules described in 7.12.4.

If two connection requests pass on a physical link, the phy shall determine the winner by comparing OPEN address frame field contents using the arbitration priority described in table 142.

Table 142 — Arbitration priority for OPEN address frames passing on a physical link

Bits 79-64 (79 is MSB)	Bits 63-0 (0 is LSB)
ARBITRATION WAIT TIME field value	SOURCE SAS ADDRESS field value

See 7.8.3 for details on the OPEN address frame and the ARBITRATION WAIT TIME field.

7.12.4 Arbitration inside an expander device

7.12.4.1 Expander phy arbitration requirements

An expander phy shall set its Request Path request Retry Priority Status argument to IGNORE AWT when it requests a path after:

- a) it has forwarded an OPEN address frame to the physical link;
- b) an OPEN address frame is received with higher arbitration priority (see 7.12.3); and
- c) the destination SAS address and connection rate of the received OPEN address frame are not equal to the source SAS address and connection rate of the transmitted OPEN address frame (see 7.15.4 and 7.15.9).

Otherwise, the expander phy shall set the Retry Priority Status argument to NORMAL.

See the XL state machine (see 7.15) for detailed expander phy requirements.

Page: 347

Author: wdc-mevans
Subject: Highlight
Date: 5/21/2008 10:45:03 PM
T REJECT (first noun/subject convention)

it
s/b
the SAS port

Author: wdc-mevans
Subject: Highlight
Date: 5/21/2008 10:43:52 PM
T ACCEPT - DONE (as "the Arbitration Wait Time timer")

it
s/b
the timer

Author: wdc-mevans
Subject: Highlight
Date: 5/21/2008 10:45:08 PM
T REJECT (first noun/subject convention)

it
s/b
the SAS port

Author: wdc-mevans
Subject: Highlight
Date: 5/21/2008 10:43:48 PM
T ACCEPT - DONE (as "the Arbitration Wait Time timer")

it
s/b
the timer

Author: RElliott
Subject: Note
Date: 9/3/2008 6:52:09 PM
 ACCEPT - DONE

OPEN_REJECT (ZONE VIOLATION) belongs here

Author: wdc-mevans
Subject: Cross-Out
Date: 5/25/2008 8:50:05 PM
T REJECT (this is important; several connection responses may or may not be from the destination phy. The list only includes the ones that are definitely from the destination phy.)

conclusively
s/b
[Delete the unnecessary word.]

Author: lsi-gpenokie
Subject: Highlight
Date: 5/25/2008 8:50:17 PM
T REJECT (the SAS port doesn't know if it receives them from the destination phy or not, so that cannot be normative text. It's informative that we know some of them must be from the destination phy and others are questionable.)

This note<< NOTE 61 - Connection >> should be modified by deleting the 1st sentence and change << receives one of the

Comments from page 347 continued on next page

A SAS port shall stop the Arbitration Wait Time timer and set **it** to zero when **it** has no more frames to send.

A SAS port shall stop the Arbitration Wait Time timer and set **it** to zero when **it** receives one of the following connection responses:



- a) OPEN_ACCEPT;
- b) OPEN_REJECT (PROTOCOL NOT SUPPORTED);
- c) OPEN_REJECT (RESERVED ABANDON 1);
- d) OPEN_REJECT (RESERVED ABANDON 2);
- e) OPEN_REJECT (RESERVED ABANDON 3);
- f) OPEN_REJECT (STP RESOURCES BUSY); or
- g) OPEN_REJECT (WRONG DESTINATION).

NOTE 61 - Connection responses that are **conclusively** from the destination phy (see table 122 and table 123 in 7.2.6.10) are included in the list. Except for OPEN_REJECT (RETRY), connection responses that are only from or may be from expander phys are not included.

When an OPEN_REJECT (RETRY) is received:

- a) if the CONTINUE AWT bit is set to one in the Protocol-Specific Port mode page (see 10.2.7.4), then a connection response of OPEN_REJECT (RETRY) shall not stop the Arbitration Wait Time timer and shall not set **it** to zero, or
- b) If the CONTINUE AWT bit is set to zero, then a SAS port shall stop the Arbitration Wait Time timer and set **it** to zero.

A SAS port should not stop the Arbitration Wait Time timer and set **it** to zero when **it** receives an incoming OPEN address frame that has priority over the outgoing OPEN address frame according to table 142, regardless of whether **it** replies with an OPEN_ACCEPT or an OPEN_REJECT.

When arbitrating for access to an outgoing expander port, the expander device shall select the connection request based on the rules described in 7.12.4.

If two connection requests pass on a **physical link**, the **phy** shall determine the winner by comparing OPEN address frame field contents using the arbitration priority described in table 142.

Table 142 — Arbitration priority for OPEN address frames passing on a physical link

Bits 79-64 (79 is MSB)	Bits 63-0 (0 is LSB)
ARBITRATION WAIT TIME field value	SOURCE SAS ADDRESS field value

See 7.8.3 for details on the OPEN address frame and the ARBITRATION WAIT TIME field.

7.12.4 Arbitration inside an expander device

7.12.4.1 Expander phy arbitration requirements

An **expander phy** shall set its Request Path request Retry Priority Status argument to IGNORE AWT when **it** requests a path after:

- a) **it has forwarded an** OPEN address frame to the **physical link**;
- b) an OPEN address frame **is received** with higher arbitration priority (see 7.12.3); and
- c) the destination SAS address and connection rate of the received OPEN address frame are not equal to the source SAS address and connection rate of the transmitted OPEN address frame (see 7.15.4 and 7.15.9).

Otherwise, the **expander phy** shall set the Retry Priority Status argument to NORMAL.

See the XL state machine (see 7.15) for detailed **expander phy** requirements.

following connection responses >> to << receives one of the following connection responses from a destination phy (see ...):>>.

Author: wdc-mevans
Subject: Highlight
Date: 5/22/2008 4:31:07 PM
T ACCEPT - DONE (as "the Arbitration Wait Time timer")
it
s/b
the timer

Author: wdc-mevans
Subject: Highlight
Date: 5/22/2008 4:31:02 PM
T ACCEPT - DONE (as "the Arbitration Wait Time timer")
it
s/b
the timer

Author: wdc-mevans
Subject: Highlight
Date: 5/21/2008 10:45:15 PM
T REJECT (first noun/subject convention)
it
s/b
the SAS port

Author: wdc-mevans
Subject: Highlight
Date: 5/22/2008 4:31:31 PM
T ACCEPT - DONE (as "the Arbitration Wait Time timer")
it
s/b
the timer

Author: wdc-mevans
Subject: Highlight
Date: 5/21/2008 10:45:32 PM
T REJECT (first noun/subject convention)
it
s/b
the SAS port

Author: RElliott
Subject: Highlight
Date: 6/30/2008 6:16:52 PM
T ACCEPT - DONE
phy
s/b
logical phy

(per Isi-bday comment on this section)

Author: RElliott
Subject: Highlight
Date: 6/30/2008 6:16:52 PM
T ACCEPT - DONE
the
s/b
then the

A SAS port shall stop the Arbitration Wait Time timer and set **it** to zero when **it** has no more frames to send.

A SAS port shall stop the Arbitration Wait Time timer and set **it** to zero when **it** receives one of the following connection responses:

- a) OPEN_ACCEPT;
-  b) OPEN_REJECT (PROTOCOL NOT SUPPORTED);
- c) OPEN_REJECT (RESERVED ABANDON 1);
- d) OPEN_REJECT (RESERVED ABANDON 2);
- e) OPEN_REJECT (RESERVED ABANDON 3);
- f) OPEN_REJECT (STP RESOURCES BUSY); or
- g) OPEN_REJECT (WRONG DESTINATION).

NOTE 61 - Connection responses that are **conclusively** from the destination phy (see table 122 and table 123 in 7.2.6.10) are included in the list. Except for OPEN_REJECT (RETRY), connection responses that are only from or may be from expander phys are not included.

When an OPEN_REJECT (RETRY) is received:

- a) if the CONTINUE AWT bit is set to one in the Protocol-Specific Port mode page (see 10.2.7.4), then a connection response of OPEN_REJECT (RETRY) shall not stop the Arbitration Wait Time timer and shall not set **it** to zero; or
- b) If the CONTINUE AWT bit is set to zero, then a SAS port shall stop the Arbitration Wait Time timer and set **it** to zero.

A SAS port should not stop the Arbitration Wait Time timer and set **it** to zero when **it** receives an incoming OPEN address frame that has priority over the outgoing OPEN address frame according to table 142, regardless of whether **it** replies with an OPEN_ACCEPT or an OPEN_REJECT.

When arbitrating for access to an outgoing expander port, the expander device shall select the connection request based on the rules described in 7.12.4.

If two connection requests pass on a **physical link**, the **phy** shall determine the winner by comparing OPEN address frame field contents using the arbitration priority described in table 142.

Table 142 — Arbitration priority for OPEN address frames passing on a physical link

Bits 79-64 (79 is MSB)	Bits 63-0 (0 is LSB)
ARBITRATION WAIT TIME field value	SOURCE SAS ADDRESS field value

See 7.8.3 for details on the OPEN address frame and the ARBITRATION WAIT TIME field.

7.12.4 Arbitration inside an expander device

7.12.4.1 Expander phy arbitration requirements

An **expander phy** shall set its Request Path request Retry Priority Status argument to IGNORE AWT when **it** requests a path after:

- a) **it has forwarded an** OPEN address frame to the **physical link**;
- b) an OPEN address frame **is received** with higher arbitration priority (see 7.12.3); and
- c) the destination SAS address and connection rate of the received OPEN address frame are not equal to the source SAS address and connection rate of the transmitted OPEN address frame (see 7.15.4 and 7.15.9).

Otherwise, the **expander phy** shall set the Retry Priority Status argument to NORMAL.

See the XL state machine (see 7.15) for detailed **expander phy** requirements.

Author: RElliott
Subject: Highlight
Date: 6/30/2008 6:16:52 PM
T ACCEPT - DONE

physical link
s/b
logical link

Author: RElliott
Subject: Highlight
Date: 6/30/2008 6:16:52 PM
T ACCEPT - DONE

physical link
s/b
logical link

Author: RElliott
Subject: Highlight
Date: 6/30/2008 6:16:52 PM
T ACCEPT - DONE

Expander phy
s/b
Expander logical phy

(per Isi-bday comment on this section)

Author: wdc-mevans
Subject: Highlight
Date: 5/21/2008 10:45:48 PM
T REJECT (first noun/subject convention)

it
s/b
the expander phy

Author: RElliott
Subject: Highlight
Date: 6/30/2008 6:16:52 PM
T ACCEPT - DONE

expander phy
s/b
expander logical phy

(per Isi-bday comment on this section)

Author: RElliott
Subject: Highlight
Date: 6/30/2008 6:16:52 PM
T ACCEPT - DONE

physical link
s/b
logical link

(per Isi-bday comment on this section)

A SAS port shall stop the Arbitration Wait Time timer and set **it** to zero when **it** has no more frames to send.

A SAS port shall stop the Arbitration Wait Time timer and set **it** to zero when **it** receives one of the following connection responses:

- a) OPEN_ACCEPT;
- b) OPEN_REJECT (PROTOCOL NOT SUPPORTED);
- c) OPEN_REJECT (RESERVED ABANDON 1);
- d) OPEN_REJECT (RESERVED ABANDON 2);
- e) OPEN_REJECT (RESERVED ABANDON 3);
- f) OPEN_REJECT (STP RESOURCES BUSY); or
- g) OPEN_REJECT (WRONG DESTINATION).



NOTE 61 - Connection responses that are **conclusively** from the destination phy (see table 122 and table 123 in 7.2.6.10) are included in the list. Except for OPEN_REJECT (RETRY), connection responses that are only from or may be from expander phys are not included.

When an OPEN_REJECT (RETRY) is received:

- a) if the CONTINUE AWT bit is set to one in the Protocol-Specific Port mode page (see 10.2.7.4), then a connection response of OPEN_REJECT (RETRY) shall not stop the Arbitration Wait Time timer and shall not set **it** to zero; or
- b) If the CONTINUE AWT bit is set to zero, then a SAS port shall stop the Arbitration Wait Time timer and set **it** to zero.

A SAS port should not stop the Arbitration Wait Time timer and set **it** to zero when **it** receives an incoming OPEN address frame that has priority over the outgoing OPEN address frame according to table 142, regardless of whether **it** replies with an OPEN_ACCEPT or an OPEN_REJECT.

When arbitrating for access to an outgoing expander port, the expander device shall select the connection request based on the rules described in 7.12.4.

If two connection requests pass on a **physical link**, the **phy** shall determine the winner by comparing OPEN address frame field contents using the arbitration priority described in table 142.

Table 142 — Arbitration priority for OPEN address frames passing on a physical link

Bits 79-64 (79 is MSB)	Bits 63-0 (0 is LSB)
ARBITRATION WAIT TIME field value	SOURCE SAS ADDRESS field value

See 7.8.3 for details on the OPEN address frame and the ARBITRATION WAIT TIME field.

7.12.4 Arbitration inside an expander device

7.12.4.1 Expander phy arbitration requirements

An **expander phy** shall set its Request Path request Retry Priority Status argument to IGNORE AWT when **it** requests a path after:

- a) **it has forwarded an OPEN address frame to the physical link;**
- b) an OPEN address frame **is received** with higher arbitration priority (see 7.12.3); and
- c) the destination SAS address and connection rate of the received OPEN address frame are not equal to the source SAS address and connection rate of the transmitted OPEN address frame (see 7.15.4 and 7.15.9).

Otherwise, the **expander phy** shall set the Retry Priority Status argument to NORMAL.

See the XL state machine (see 7.15) for detailed **expander phy** requirements.

Author: lsi-gpenokie
Subject: Highlight
Date: 5/25/2008 8:50:33 PM

T REJECT

This << it has forwarded a >> should be << the expander phy has forwarded a >>

Author: wdc-mevans
Subject: Highlight
Date: 5/22/2008 4:31:54 PM

T REJECT (first noun/subject convention)

it
s/b
the expander phy

Author: RElliott
Subject: Highlight
Date: 6/30/2008 6:16:52 PM

T ACCEPT - DONE
"an OPEN address frame is received"

s/b
"it receives an OPEN address frame" to match the tense of style of a)

Author: RElliott
Subject: Highlight
Date: 6/30/2008 6:16:52 PM

T ACCEPT - DONE

expander phy
s/b
expander logical phy

(per lsi-bday comment on this section)

Author: RElliott
Subject: Highlight
Date: 6/30/2008 6:16:52 PM

T ACCEPT - DONE

expander phy
s/b
expander logical phy

(per lsi-bday comment on this section)

7.12.4.2 ECM arbitration requirements

7.12.4.2.1 ECM arbitration requirements overview

The ECM shall arbitrate and assign or deny path resources for Request Path requests (see 4.6.6.3) from each expander phy.

Arbitration includes adherence to the SAS arbitration fairness algorithm and path recovery. Path recovery is used to avoid potential deadlock scenarios within the SAS topology by deterministically choosing which partial pathway(s) to tear down to allow at least one connection to complete.

Several of the Request Path arguments are used for arbitration. The Arbitration Wait Time, Source SAS Address, and Connection Rate arguments are filled in from the received OPEN address frame and are used to by the ECM to compare Request Path requests. The Retry Priority Status argument is used to prevent the Arbitration Wait Time argument from being considered during an arbitration which occurs after a Backoff Retry response is sent by an expander phy (see 7.15.4).

When the ECM in an expander device receives a connection request:

- 1) if the destination SAS address is that of the expander device itself, the ECM shall arbitrate for access to its SMP target port;
- 2) if the destination SAS address matches the SAS address attached to one or more of the expander phys, the ECM shall arbitrate for access to those expander phys;
- 3) if the destination SAS address matches an enabled SAS address in the expander route table for one or more expander phys that is using the table routing method, the ECM shall arbitrate for access to those expander phys; and
- 4) if at least one expander phy is using the subtractive routing method, and the request did not come from one of those expander phys, the ECM shall arbitrate for access to one of those expander phys.

The ECM shall respond to each Request Path request by returning the following confirmations to the requesting expander logical phy while processing the Request Path request:

- a) Arbitrating (Normal) (see 7.12.4.2.2);
- b) Arbitrating (Waiting On Partial) (see 7.12.4.2.2);
- c) Arbitrating (Blocked On Partial) (see 7.12.4.2.2);
- d) Arbitrating (Waiting On Connection) (see 7.12.4.2.2).

The ECM shall complete responding to each Request Path request by returning one of the following confirmations to the requesting expander logical phy:

- a) Arb Won (see 7.12.4.2.3);
- b) Arb Lost (see 7.12.4.2.4); or
- c) Arb Reject (see 7.12.4.2.5).

7.12.4.2.2 Arbitrating confirmations

The ECM shall send an Arbitrating (Normal) confirmation after it has received a Request Path request.

The ECM shall send an Arbitrating (Waiting On Partial) confirmation if it is waiting on a partial pathway (see 4.1.11). The ECM is waiting on a partial pathway if:

- a) there is a destination port capable of routing to the requested destination SAS address;
- b) at least one phy within the destination port supports the requested connection rate;
- c) each of the phys within the destination port is returning a Phy Status (Partial Pathway) or Phy Status (Blocked Partial Pathway) response; and
- d) at least one of the phys within the destination port is returning a Phy Status (Partial Pathway) response.

The ECM shall send an Arbitrating (Blocked On Partial) confirmation if it is waiting on a blocked partial pathway (see 4.1.11). The ECM is waiting on a blocked partial pathway if:

- a) there is a destination port capable of routing to the requested destination SAS address;
- b) at least one phy within the destination port supports the requested connection rate; and

Page: 348

Author: RElliott
Subject: Highlight
Date: 6/30/2008 6:16:52 PM
ACCEPT - DONE

expander phy
s/b
expander logical phy

(per Isi-bday comment on this section)

Author: stx-goulder
Subject: Highlight
Date: 6/28/2008 6:09:39 PM

REJECT (This wording is fine and rather unique. Other terms like "release" have other meanings that could cause confusion. 5/5 release seems to work)

tear down

Is there a better term for this? "release" perhaps? At the very least there should be a glossary entry for this if it stays.

Author: Isi-gpenokie
Subject: Highlight
Date: 5/25/2008 8:51:33 PM

ACCEPT - DONE

This << The Arbitration Wait Time, Source SAS Address, and Connection Rate arguments are filled >> should be << The Arbitration Wait Time argument, Source SAS Address argument, and Connection Rate argument are filled >>

Author: elx-bmartin
Subject: Cross-Out
Date: 5/25/2008 8:51:44 PM

ACCEPT - DONE

to

Author: RElliott
Subject: Highlight
Date: 6/30/2008 6:16:52 PM

ACCEPT - DONE

expander phy
s/b
expander logical phy

(per Isi-bday comment on this section)

Author: RElliott
Subject: Highlight
Date: 6/30/2008 6:16:52 PM

ACCEPT - DONE

the
s/b
then the

Author: RElliott
Subject: Highlight
Date: 6/30/2008 6:16:52 PM

Comments from page 348 continued on next page

7.12.4.2 ECM arbitration requirements

7.12.4.2.1 ECM arbitration requirements overview

The ECM shall arbitrate and assign or deny path resources for Request Path requests (see 4.6.6.3) from each expander phy.

Arbitration includes adherence to the SAS arbitration fairness algorithm and path recovery. Path recovery is used to avoid potential deadlock scenarios within the SAS topology by deterministically choosing which partial pathway(s) to tear down to allow at least one connection to complete.

Several of the Request Path arguments are used for arbitration. The Arbitration Wait Time, Source SAS Address, and Connection Rate arguments are filled in from the received OPEN address frame and are used by the ECM to compare Request Path requests. The Retry Priority Status argument is used to prevent the Arbitration Wait Time argument from being considered during an arbitration which occurs after a Backoff Retry response is sent by an expander phy (see 7.15.4).

When the ECM in an expander device receives a connection request:

- 1) if the destination SAS address is that of the expander device itself, the ECM shall arbitrate for access to its SMP target port;
- 2) if the destination SAS address matches the SAS address attached to one or more of the expander phys, the ECM shall arbitrate for access to those expander phys;
- 3) if the destination SAS address matches an enabled SAS address in the expander route table for one or more expander phys that is using the table routing method, the ECM shall arbitrate for access to those expander phys; and
- 4) if at least one expander phy is using the subtractive routing method, and the request did not come from one of those expander phys, the ECM shall arbitrate for access to one of those expander phys.

The ECM shall respond to each Request Path request by returning the following confirmations to the requesting expander logical phy while processing the Request Path request:

- a) Arbitrating (Normal) (see 7.12.4.2.2);
- b) Arbitrating (Waiting On Partial) (see 7.12.4.2.2);
- c) Arbitrating (Blocked On Partial) (see 7.12.4.2.2);
- d) Arbitrating (Waiting On Connection) (see 7.12.4.2.2).

The ECM shall complete responding to each Request Path request by returning one of the following confirmations to the requesting expander logical phy:

- a) Arb Won (see 7.12.4.2.3);
- b) Arb Lost (see 7.12.4.2.4); or
- c) Arb Reject (see 7.12.4.2.5).

7.12.4.2.2 Arbitrating confirmations

The ECM shall send an Arbitrating (Normal) confirmation after it has received a Request Path request.

The ECM shall send an Arbitrating (Waiting On Partial) confirmation if it is waiting on a partial pathway (see 4.1.11). The ECM is waiting on a partial pathway if:

- a) there is a destination port capable of routing to the requested destination SAS address;
- b) at least one phy within the destination port supports the requested connection rate;
- c) each of the phys within the destination port is returning a Phy Status (Partial Pathway) or Phy Status (Blocked Partial Pathway) response; and
- d) at least one of the phys within the destination port is returning a Phy Status (Partial Pathway) response.

The ECM shall send an Arbitrating (Blocked On Partial) confirmation if it is waiting on a blocked partial pathway (see 4.1.11). The ECM is waiting on a blocked partial pathway if:

- a) there is a destination port capable of routing to the requested destination SAS address;
- b) at least one phy within the destination port supports the requested connection rate; and

T ACCEPT - DONE

expander phys
s/b
expander logical phys

(per Isi-bday comment on this section)

Author: RElliott
Subject: Highlight
Date: 6/30/2008 6:16:52 PM

T ACCEPT - DONE

the
s/b
then the

Author: RElliott
Subject: Highlight
Date: 6/30/2008 6:16:52 PM

T ACCEPT - DONE

the
s/b
then the

Author: RElliott
Subject: Highlight
Date: 6/30/2008 6:16:52 PM

T ACCEPT - DONE

expander phys
s/b
expander logical phys

(per Isi-bday comment on this section)

Author: RElliott
Subject: Highlight
Date: 6/30/2008 6:16:52 PM

T ACCEPT - DONE

expander phys
s/b
expander logical phys

(per Isi-bday comment on this section)

Author: RElliott
Subject: Cross-Out
Date: 6/30/2008 6:16:52 PM

~~**T**~~ ACCEPT - DONE

Author: RElliott
Subject: Highlight
Date: 6/30/2008 6:16:52 PM

7.12.4.2 ECM arbitration requirements

7.12.4.2.1 ECM arbitration requirements overview

The ECM shall arbitrate and assign or deny path resources for Request Path requests (see 4.6.6.3) from each expander phy.

Arbitration includes adherence to the SAS arbitration fairness algorithm and path recovery. Path recovery is used to avoid potential deadlock scenarios within the SAS topology by deterministically choosing which partial pathway(s) to tear down to allow at least one connection to complete.

Several of the Request Path arguments are used for arbitration. The Arbitration Wait Time, Source SAS Address, and Connection Rate arguments are filled in from the received OPEN address frame and are used by the ECM to compare Request Path requests. The Retry Priority Status argument is used to prevent the Arbitration Wait Time argument from being considered during an arbitration which occurs after a Backoff Retry response is sent by an expander phy (see 7.15.4).

When the ECM in an expander device receives a connection request:

- 1) if the destination SAS address is that of the expander device itself, the ECM shall arbitrate for access to its SMP target port;
- 2) if the destination SAS address matches the SAS address attached to one or more of the expander phys, the ECM shall arbitrate for access to those expander phys;
- 3) if the destination SAS address matches an enabled SAS address in the expander route table for one or more expander phys that is using the table routing method, the ECM shall arbitrate for access to those expander phys; and
- 4) if at least one expander phy is using the subtractive routing method, and the request did not come from one of those expander phys, the ECM shall arbitrate for access to one of those expander phys.

The ECM shall respond to each Request Path request by returning the following confirmations to the requesting expander logical phy while processing the Request Path request:

- a) Arbitrating (Normal) (see 7.12.4.2.2);
- b) Arbitrating (Waiting On Partial) (see 7.12.4.2.2);
- c) Arbitrating (Blocked On Partial) (see 7.12.4.2.2);
- d) Arbitrating (Waiting On Connection) (see 7.12.4.2.2).

The ECM shall complete responding to each Request Path request by returning one of the following confirmations to the requesting expander logical phy:

- a) Arb Won (see 7.12.4.2.3);
- b) Arb Lost (see 7.12.4.2.4); or
- c) Arb Reject (see 7.12.4.2.5).

7.12.4.2.2 Arbitrating confirmations

The ECM shall send an Arbitrating (Normal) confirmation after it has received a Request Path request.

The ECM shall send an Arbitrating (Waiting On Partial) confirmation if it is waiting on a partial pathway (see 4.1.11). The ECM is waiting on a partial pathway if:

- a) there is a destination port capable of routing to the requested destination SAS address;
- b) at least one phy within the destination port supports the requested connection rate;
- c) each of the phys within the destination port is returning a Phy Status (Partial Pathway) or Phy Status (Blocked Partial Pathway) response; and
- d) at least one of the phys within the destination port is returning a Phy Status (Partial Pathway) response.

The ECM shall send an Arbitrating (Blocked On Partial) confirmation if it is waiting on a blocked partial pathway (see 4.1.11). The ECM is waiting on a blocked partial pathway if:

- a) there is a destination port capable of routing to the requested destination SAS address;
- b) at least one phy within the destination port supports the requested connection rate; and

T ACCEPT - DONE

expander phy
s/b
expander logical phy

(per Isi-bday comment on this section)

● Author: RElliott
Subject: Highlight
Date: 6/30/2008 6:16:52 PM

T ACCEPT - DONE

expander phys
s/b
expander logical phys

(per Isi-bday comment on this section)

● Author: RElliott
Subject: Highlight
Date: 6/30/2008 6:16:52 PM

T ACCEPT - DONE

the
s/b
then the

● Author: RElliott
Subject: Highlight
Date: 6/30/2008 6:16:52 PM

T ACCEPT - DONE

expander phys
s/b
expander logical phys

(per Isi-bday comment on this section)

● Author: Isi-gpenokie
Subject: Highlight
Date: 5/25/2008 8:52:19 PM

T ACCEPT - DONE

This << (Blocked On Partial) (see 7.12.4.2.2); >> should be << (Blocked On Partial) (see 7.12.4.2.2); and >>

● Author: wdc-mevans
Subject: Highlight
Date: 5/21/2008 10:46:13 PM

T REJECT (first noun/subject convention)

it
s/b
the ECM

● Author: wdc-mevans
Subject: Highlight
Date: 5/22/2008 9:59:57 AM

T REJECT (first noun/subject convention)

Comments from page 348 continued on next page

7.12.4.2 ECM arbitration requirements

7.12.4.2.1 ECM arbitration requirements overview

The ECM shall arbitrate and assign or deny path resources for Request Path requests (see 4.6.6.3) from each expander phy.

Arbitration includes adherence to the SAS arbitration fairness algorithm and path recovery. Path recovery is used to avoid potential deadlock scenarios within the SAS topology by deterministically choosing which partial pathway(s) to tear down to allow at least one connection to complete.

Several of the Request Path arguments are used for arbitration. The Arbitration Wait Time, Source SAS Address, and Connection Rate arguments are filled in from the received OPEN address frame and are used by the ECM to compare Request Path requests. The Retry Priority Status argument is used to prevent the Arbitration Wait Time argument from being considered during an arbitration which occurs after a Backoff Retry response is sent by an expander phy (see 7.15.4).

When the ECM in an expander device receives a connection request:

- 1) if the destination SAS address is that of the expander device itself, the ECM shall arbitrate for access to its SMP target port;
- 2) if the destination SAS address matches the SAS address attached to one or more of the expander phys, the ECM shall arbitrate for access to those expander phys;
- 3) if the destination SAS address matches an enabled SAS address in the expander route table for one or more expander phys that is using the table routing method, the ECM shall arbitrate for access to those expander phys; and
- 4) if at least one expander phy is using the subtractive routing method, and the request did not come from one of those expander phys, the ECM shall arbitrate for access to one of those expander phys.

The ECM shall respond to each Request Path request by returning the following confirmations to the requesting expander logical phy while processing the Request Path request:

- a) Arbitrating (Normal) (see 7.12.4.2.2);
- b) Arbitrating (Waiting On Partial) (see 7.12.4.2.2);
- c) Arbitrating (Blocked On Partial) (see 7.12.4.2.2);
- d) Arbitrating (Waiting On Connection) (see 7.12.4.2.2).

The ECM shall complete responding to each Request Path request by returning one of the following confirmations to the requesting expander logical phy:

- a) Arb Won (see 7.12.4.2.3);
- b) Arb Lost (see 7.12.4.2.4); or
- c) Arb Reject (see 7.12.4.2.5).

7.12.4.2.2 Arbitrating confirmations

The ECM shall send an Arbitrating (Normal) confirmation after it has received a Request Path request.

The ECM shall send an Arbitrating (Waiting On Partial) confirmation if it is waiting on a partial pathway (see 4.1.11). The ECM is waiting on a partial pathway if:

- a) there is a destination port capable of routing to the requested destination SAS address;
- b) at least one phy within the destination port supports the requested connection rate;
- c) each of the phys within the destination port is returning a Phy Status (Partial Pathway) or Phy Status (Blocked Partial Pathway) response; and
- d) at least one of the phys within the destination port is returning a Phy Status (Partial Pathway) response.

The ECM shall send an Arbitrating (Blocked On Partial) confirmation if it is waiting on a blocked partial pathway (see 4.1.11). The ECM is waiting on a blocked partial pathway if:

- a) there is a destination port capable of routing to the requested destination SAS address;
- b) at least one phy within the destination port supports the requested connection rate; and

it
s/b
the ECM

● Author: RElliott
Subject: Highlight
Date: 6/30/2008 6:16:52 PM
T ACCEPT - DONE

phy
s/b
expander logical phy

● Author: RElliott
Subject: Highlight
Date: 6/30/2008 6:16:52 PM
T ACCEPT - DONE

phys
s/b
expander logical phys

● Author: RElliott
Subject: Highlight
Date: 6/30/2008 6:16:52 PM
T ACCEPT - DONE

phys
s/b
expander logical phys

● Author: wdc-mevans
Subject: Highlight
Date: 5/21/2008 10:46:21 PM
T REJECT (first noun/subject convention)

it
s/b
the ECM

● Author: RElliott
Subject: Highlight
Date: 6/30/2008 6:16:52 PM
T ACCEPT - DONE

phy
s/b
expander logical phy

- c) each of the phys within the destination port is returning a Phy Status (Blocked Partial Pathway) response.

The ECM shall send an Arbitrating (Waiting On Connection) confirmation if it is waiting on a connection to complete (see 4.1.12). The ECM is waiting on a connection to complete if:

- a) the connection request is blocked by an active connection; or
- b) there are insufficient routing resources within the expander to complete the connection request.

A connection request shall be considered blocked by an active connection when:

- a) there is a destination port capable of routing to the requested destination SAS address;
- b) at least one phy within the destination port supports the requested connection rate;
- c) each of the phys within the destination port is returning a Phy Status (Partial Pathway), Phy Status (Blocked Partial Pathway), or Phy Status (Connection) response; and
- d) at least one of the phys within the destination port is returning a Phy Status (Connection) response.

7.12.4.2.3 Arb Won confirmation

The ECM shall generate the Arb Won confirmation when all of the following conditions are met:

- a) the Request Path request maps to a destination expander phy that:
 - A) supports the connection rate; and
 - B) is not reporting a Phy Status (Partial Pathway), Phy Status (Blocked Partial Pathway), or Phy Status (Connection) response, unless that expander phy is arbitrating for the requesting expander phy;
- b) there are sufficient routing resources to complete the connection request;
- c) no higher priority Request Path requests are present with the requesting expander phy as the destination; and
- d) the Request Path request is the highest priority Request Path request (see table 143 and table 144) mapping to the destination expander phy (i.e., only send one Arb Won confirmation for Request Path requests to the same destination phy).

If two or more Request Path requests contend and all of the Request Path requests include a Retry Priority Status argument set to NORMAL, the ECM shall select the winner by comparing the OPEN address frame contents described in table 143.

Table 143 — Arbitration priority for contending Request Path requests in the ECM when all requests have Retry Priority Status arguments of NORMAL

Bits 83-68 (83 is MSB)	Bits 67-4	Bits 3-0 (0 is LSB)
ARBITRATION WAIT TIME field value	SOURCE SAS ADDRESS field value	CONNECTION RATE field value

If two or more Request Path requests contend and one or more of the Request Path requests include a Retry Priority Status argument set to IGNORE AWT, the ECM shall select the winner from the set of Request Path requests with Retry Priority Status arguments set to IGNORE AWT by comparing the OPEN address frame contents described in table 144.

Table 144 — Arbitration priority for contending Request Path requests in the ECM among requests with Retry Priority Status arguments of IGNORE AWT

Bits 67-4 (67 is MSB)	Bits 3-0 (0 is LSB)
SOURCE SAS ADDRESS field value	CONNECTION RATE field value

7.12.4.2.4 Arb Lost confirmation

The ECM shall generate the Arb Lost confirmation when all of the following conditions are met:

- a) the Request Path request maps to a destination expander logical phy that:

Author: RElliott
Subject: Highlight
Date: 6/30/2008 6:16:52 PM
T ACCEPT - DONE

phys
s/b
expander logical phys

Author: wdc-mevans
Subject: Highlight
Date: 5/21/2008 10:46:28 PM
T REJECT (first noun/subject convention)

it
s/b
the ECM

Author: RElliott
Subject: Highlight
Date: 6/30/2008 6:16:52 PM
T ACCEPT - DONE

phy
s/b
expander logical phy

Author: RElliott
Subject: Highlight
Date: 6/30/2008 6:16:52 PM
T ACCEPT - DONE

phys
s/b
expander logical phys

Author: RElliott
Subject: Highlight
Date: 6/30/2008 6:16:52 PM
T ACCEPT - DONE

phys
s/b
expander logical phys

Author: RElliott
Subject: Highlight
Date: 6/30/2008 6:16:52 PM
T ACCEPT - DONE

expander phy
s/b
expander logical phy

(per Isi-bday comment on this section)

Author: RElliott
Subject: Highlight
Date: 6/30/2008 6:16:52 PM

- c) each of the **phys** within the destination port is returning a Phy Status (Blocked Partial Pathway) response.

The ECM shall send an Arbitrating (Waiting On Connection) confirmation if **it** is waiting on a connection to complete (see 4.1.12). The ECM is waiting on a connection to complete if:

- a) the connection request is blocked by an active connection; or
- b) there are insufficient routing resources within the expander to complete the connection request.

A connection request shall be considered blocked by an active connection when:

- a) there is a destination port capable of routing to the requested destination SAS address;
- b) at least one **phy** within the destination port supports the requested connection rate;
- c) each of the **phys** within the destination port is returning a Phy Status (Partial Pathway), Phy Status (Blocked Partial Pathway), or Phy Status (Connection) response; and
- d) at least one of the **phys** within the destination port is returning a Phy Status (Connection) response.

7.12.4.2.3 Arb Won confirmation

The ECM shall generate the Arb Won confirmation when all of the following conditions are met:

- a) the Request Path request maps to a destination **expander phy** that:
 - A) supports the connection rate; and
 - B) is not reporting a Phy Status (Partial Pathway), Phy Status (Blocked Partial Pathway), or Phy Status (Connection) response, unless that **expander phy** is arbitrating for the requesting **expander phy**;
- b) there are sufficient routing resources to complete the connection request;
- c) no higher priority Request Path requests are present with the requesting **expander phy** as the destination; and
- d) the Request Path request is the highest priority Request Path request (see table 143 and table 144) mapping to the destination **expander phy** (i.e., only send one Arb Won confirmation for Request Path requests to the same destination phy).

If two or more Request Path requests **contend and** all of the Request Path requests include a Retry Priority Status argument set to NORMAL, **the** ECM shall select the winner by comparing the OPEN address frame contents described in table 143.

Table 143 — Arbitration priority for contending Request Path requests in the ECM when all requests have Retry Priority Status arguments of NORMAL

Bits 83-68 (83 is MSB)	Bits 67-4	Bits 3-0 (0 is LSB)
ARBITRATION WAIT TIME field value	SOURCE SAS ADDRESS field value	CONNECTION RATE field value

If two or more Request Path requests **contend and** one or more of the Request Path requests include a Retry Priority Status argument set to IGNORE AWT, **the** ECM shall select the winner from the set of Request Path requests with Retry Priority Status arguments set to IGNORE AWT by comparing the OPEN address frame contents described in table 144.

Table 144 — Arbitration priority for contending Request Path requests in the ECM among requests with Retry Priority Status arguments of IGNORE AWT

Bits 67-4 (67 is MSB)	Bits 3-0 (0 is LSB)
SOURCE SAS ADDRESS field value	CONNECTION RATE field value

7.12.4.2.4 Arb Lost confirmation

The ECM shall generate the Arb Lost confirmation when all of the following conditions are met:

- a) the Request Path request maps to a destination expander logical phy that:

T ACCEPT - DONE

expander phy
s/b
expander logical phy

(per Isi-bday comment on this section)

● Author: RElliott
Subject: Highlight
Date: 6/30/2008 6:16:52 PM

T ACCEPT - DONE

expander phy
s/b
expander logical phy

(per Isi-bday comment on this section)

● Author: RElliott
Subject: Highlight
Date: 6/30/2008 6:16:52 PM

T ACCEPT - DONE

expander phy
s/b
expander logical phy

(per Isi-bday comment on this section)

● Author: RElliott
Subject: Highlight
Date: 6/30/2008 6:16:52 PM

T ACCEPT - DONE

expander phy
s/b
expander logical phy

(per Isi-bday comment on this section)

● Author: wdc-mevans
Subject: Highlight
Date: 5/21/2008 10:48:28 PM

T REJECT (two conditions ANDED together)

contend and
s/b
contend, and

● Author: RElliott
Subject: Highlight
Date: 6/30/2008 6:16:52 PM

T ACCEPT - DONE

the
s/b
then the

- c) each of the **phys** within the destination port is returning a Phy Status (Blocked Partial Pathway) response.

The ECM shall send an Arbitrating (Waiting On Connection) confirmation if **it** is waiting on a connection to complete (see 4.1.12). The ECM is waiting on a connection to complete if:

- a) the connection request is blocked by an active connection; or
- b) there are insufficient routing resources within the expander to complete the connection request.

A connection request shall be considered blocked by an active connection when:

- a) there is a destination port capable of routing to the requested destination SAS address;
- b) at least one **phy** within the destination port supports the requested connection rate;
- c) each of the **phys** within the destination port is returning a Phy Status (Partial Pathway), Phy Status (Blocked Partial Pathway), or Phy Status (Connection) response; and
- d) at least one of the **phys** within the destination port is returning a Phy Status (Connection) response.

7.12.4.2.3 Arb Won confirmation

The ECM shall generate the Arb Won confirmation when all of the following conditions are met:

- a) the Request Path request maps to a destination **expander phy** that:
 - A) supports the connection rate; and
 - B) is not reporting a Phy Status (Partial Pathway), Phy Status (Blocked Partial Pathway), or Phy Status (Connection) response, unless that **expander phy** is arbitrating for the requesting **expander phy**;
- b) there are sufficient routing resources to complete the connection request;
- c) no higher priority Request Path requests are present with the requesting **expander phy** as the destination; and
- d) the Request Path request is the highest priority Request Path request (see table 143 and table 144) mapping to the destination **expander phy** (i.e., only send one Arb Won confirmation for Request Path requests to the same destination phy).

If two or more Request Path requests **contend and** all of the Request Path requests include a Retry Priority Status argument set to NORMAL, **the** ECM shall select the winner by comparing the OPEN address frame contents described in table 143.

Table 143 — Arbitration priority for contending Request Path requests in the ECM when all requests have Retry Priority Status arguments of NORMAL

Bits 83-68 (83 is MSB)	Bits 67-4	Bits 3-0 (0 is LSB)
ARBITRATION WAIT TIME field value	SOURCE SAS ADDRESS field value	CONNECTION RATE field value

If two or more Request Path requests **contend and** one or more of the Request Path requests include a Retry Priority Status argument set to IGNORE AWT, **the** ECM shall select the winner from the set of Request Path requests with Retry Priority Status arguments set to IGNORE AWT by comparing the OPEN address frame contents described in table 144.

Table 144 — Arbitration priority for contending Request Path requests in the ECM among requests with Retry Priority Status arguments of IGNORE AWT

Bits 67-4 (67 is MSB)	Bits 3-0 (0 is LSB)
SOURCE SAS ADDRESS field value	CONNECTION RATE field value

7.12.4.2.4 Arb Lost confirmation

The ECM shall generate the Arb Lost confirmation when all of the following conditions are met:

- a) the Request Path request maps to a destination expander logical phy that:

Author: wdc-mevans
Subject: Highlight
Date: 5/21/2008 10:48:39 PM
T REJECT (two conditions ANDED together)

contend and
s/b
contend, and

Author: RElliott
Subject: Highlight
Date: 6/30/2008 6:16:52 PM
T ACCEPT - DONE

the
s/b
then the

- A) supports the connection rate; and
- B) is not reporting a Phy Status (Partial Pathway), Phy Status (Blocked Partial Pathway), or Phy Status (Connection) response unless that expander logical phy is arbitrating for the requesting expander logical phy;
- b) there are sufficient routing resources to complete the connection request; and
- c) one of the following conditions are met:
 - A) the destination expander logical phy is making a Request Path request with the requesting expander logical phy as its destination (i.e., when two expander logical phys both receive an OPEN address frame destined for each other, the ECM provides the Arb Lost confirmation to the expander logical phy that received the lowest priority OPEN address frame); or
 - B) the ECM is sending an Arb Won confirmation to another expander logical phy that is using the requesting expander logical phy as the destination.

7.12.4.2.5 Arb Reject confirmation

The ECM shall generate the following Arb Reject confirmation when any of the following conditions are met and all the Arb Won conditions (see 7.12.4.2.3) are not met:

- 1) Arb Reject (Bad Destination) if the source expander logical phy and destination expander logical phy(s) are in the same expander port and are using the direct routing method;
- 2) Arb Reject (Retry) if the expander device is unable to process the connection request because it has reduced functionality (see 4.6.8);
- 3) if the source expander logical phy and destination expander logical phy(s) are in the same expander port and are using the table routing method or the subtractive routing method:
 - A) Arb Reject (No Destination) if the expander device is not configuring; and
 - B) Arb Reject (Retry) if the expander device is configuring;
- 4) if there are no destination expander logical phys (i.e., there is no direct routing or table routing match and there is no subtractive phy):
 - A) Arb Reject (No Destination) if the expander device is not configuring; and
 - B) Arb Reject (Retry) if the expander device is configuring;
- 5) if access to the destination expander logical phy(s) is prohibited by zoning (see 4.9.3):
 - A) Arb Reject (Zone Violation) if the zoning expander device is unlocked; and
 - B) Arb Reject (Retry) if the zoning expander device is locked;
- 6) Arb Reject (Connection Rate Not Supported) if none of the destination expander logical phys supports the connection rate; and
- 7) Arb Reject (Pathway Blocked) if all the destination expander logical phys that support the connection rate contain blocked partial pathways (i.e., are all returning Phy Status (Blocked Partial Pathway) and pathway recovery rules require this Request Path request be rejected to release path resources (see 7.12.4.5).

7.12.4.3 Arbitration status

Arbitration status shall be conveyed between expander devices and by expander devices to SAS endpoints using AIP (see 7.2.6.1). This status is used to monitor the progress of connection attempts and to facilitate pathway recovery as part of deadlock recovery.

The arbitration status of an expander phy is set to the last type of AIP received.

Before an expander device transmits AIP, it may have transmitted an OPEN address frame on the same physical link. Arbitration fairness dictates which OPEN address frame wins (see 7.12.3).

After an expander device transmits an AIP, it shall not transmit an OPEN address frame unless it has higher arbitration priority than the incoming connection request.

After transmitting an AIP primitive sequence, and expander device shall transmit at least one other dword (e.g., an idle dword) before transmitting another AIP primitive sequence.

Expander devices shall transmit at least one AIP every 128 dwords while originating AIP (NORMAL), AIP (WAITING ON PARTIAL), or AIP (WAITING ON CONNECTION).

Page: 350

● Author: Isi-gpenokie
Subject: Highlight
Date: 5/25/2008 8:58:50 PM
 ACCEPT - DONE

This << a Phy Status (Partial Pathway), Phy Status (Blocked Partial Pathway), or Phy Status (Connection) response unless >> should be << a Phy Status (Partial Pathway) response, Phy Status (Blocked Partial Pathway) response, or Phy Status (Connection) response unless >>

● Author: wdc-mevans
Subject: Highlight
Date: 5/30/2008 6:04:48 PM
 ACCEPT - DONE

the following Arb Reject confirmation
s/b
one of the following Arb Reject confirmations

● Author: wdc-mevans
Subject: Highlight
Date: 5/21/2008 10:47:29 PM
 REJECT (two conditions ANDed together)

met and
s/b
met, and

● Author: Isi-gpenokie
Subject: Highlight
Date: 5/25/2008 8:53:13 PM
 ACCEPT - DONE

This << and >> should be an << or >> as only one of the two conditions exist as any time.

● Author: stx-goulder
Subject: Highlight
Date: 6/2/2008 10:20:01 AM
 ACCEPT - DONE (added "(see 4.7.2)". Not adding a glossary entry)

not configuring;

Does this mean "not performing the configuration process"? Or does it mean the configuration process is complete but isn't possible to find a route between these two endpoints? I think this use of "configuring" (or not) needs a glossary entry.

● Author: Isi-gpenokie
Subject: Sticky Note
Date: 5/30/2008 6:06:49 PM
 ACCEPT - DONE (with "an " too)

All the << Arb Reject (...) >> should be << Arb Reject (...) confirmation >>

● Author: Isi-gpenokie
Subject: Highlight
Date: 5/25/2008 8:53:17 PM
 ACCEPT - DONE

This << and >> should be an << or >> as only one of the two conditions exist as any time.

● Author: Isi-gpenokie
Subject: Highlight

Comments from page 350 continued on next page

- A) supports the connection rate; and
- B) is not reporting a Phy Status (Partial Pathway), Phy Status (Blocked Partial Pathway), or Phy Status (Connection) response unless that expander logical phy is arbitrating for the requesting expander logical phy;
- b) there are sufficient routing resources to complete the connection request; and
- c) one of the following conditions are met:
 - A) the destination expander logical phy is making a Request Path request with the requesting expander logical phy as its destination (i.e., when two expander logical phys both receive an OPEN address frame destined for each other, the ECM provides the Arb Lost confirmation to the expander logical phy that received the lowest priority OPEN address frame); or
 - B) the ECM is sending an Arb Won confirmation to another expander logical phy that is using the requesting expander logical phy as the destination.

7.12.4.2.5 Arb Reject confirmation

The ECM shall generate the following Arb Reject confirmation when any of the following conditions are met and all the Arb Won conditions (see 7.12.4.2.3) are not met:

- 1) Arb Reject (Bad Destination) if the source expander logical phy and destination expander logical phy(s) are in the same expander port and are using the direct routing method;
- 2) Arb Reject (Retry) if the expander device is unable to process the connection request because it has reduced functionality (see 4.6.8);
- 3) if the source expander logical phy and destination expander logical phy(s) are in the same expander port and are using the table routing method or the subtractive routing method:
 - A) Arb Reject (No Destination) if the expander device is not configuring; and
 - B) Arb Reject (Retry) if the expander device is configuring;
- 4) if there are no destination expander logical phys (i.e., there is no direct routing or table routing match and there is no subtractive phy):
 - A) Arb Reject (No Destination) if the expander device is not configuring; and
 - B) Arb Reject (Retry) if the expander device is configuring;
- 5) if access to the destination expander logical phy(s) is prohibited by zoning (see 4.9.3):
 - A) Arb Reject (Zone Violation) if the zoning expander device is unlocked; and
 - B) Arb Reject (Retry) if the zoning expander device is locked;
- 6) Arb Reject (Connection Rate Not Supported) if none of the destination expander logical phys supports the connection rate; and
- 7) Arb Reject (Pathway Blocked) if all the destination expander logical phys that support the connection rate contain blocked partial pathways (i.e., are all returning Phy Status (Blocked Partial Pathway)) and pathway recovery rules require this Request Path request be rejected to release path resources (see 7.12.4.5).

7.12.4.3 Arbitration status

Arbitration status shall be conveyed between expander devices and by expander devices to SAS endpoints using AIP (see 7.2.6.1). This status is used to monitor the progress of connection attempts and to facilitate pathway recovery as part of deadlock recovery.

The arbitration status of an expander phy is set to the last type of AIP received.

Before an expander device transmits AIP, it may have transmitted an OPEN address frame on the same physical link. Arbitration fairness dictates which OPEN address frame wins (see 7.12.3).

After an expander device transmits an AIP, it shall not transmit an OPEN address frame unless it has higher arbitration priority than the incoming connection request.

After transmitting an AIP primitive sequence, and expander device shall transmit at least one other dword (e.g., an idle dword) before transmitting another AIP primitive sequence.

Expander devices shall transmit at least one AIP every 128 dwords while originating AIP (NORMAL), AIP (WAITING ON PARTIAL), or AIP (WAITING ON CONNECTION).

Date: 5/25/2008 8:53:23 PM

T ACCEPT - DONE

This << and >> should be an << or >> as only one of the two conditions exist as any time.

● Author: RElliott
Subject: Highlight
Date: 6/30/2008 6:16:52 PM

T ACCEPT - DONE

Pathway)
s/b
Pathway) confirmations

● Author: RElliott
Subject: Highlight
Date: 6/30/2008 6:16:52 PM

T ACCEPT - DONE

expander phy
s/b
expander logical phy

(per Isi-bday comment on this section)

● Author: wdc-mevans
Subject: Highlight
Date: 5/21/2008 10:46:41 PM

T REJECT (first noun/subject convention)

it
s/b
the expander device

● Author: wdc-mevans
Subject: Highlight
Date: 5/21/2008 10:48:03 PM

T REJECT (first noun/subject convention)

it
s/b
the expander device

● Author: wdc-mevans
Subject: Highlight
Date: 5/25/2008 8:54:02 PM

T ACCEPT - DONE

and
s/b
an

NOTE 62 - Expander devices compliant with previous versions of this standard were not required to transmit three consecutive AIP primitives, as AIP was defined as a single primitive sequence (see 7.2.4.2) rather than as an extended primitive sequence (see 7.2.4.5).

Expander devices shall transmit an AIP (e.g., an AIP (NORMAL)) within 128 dwords of receiving an OPEN address frame.

7.12.4.4 Partial Pathway Timeout timer

Each expander phy shall maintain a Partial Pathway Timeout timer. This timer is used to identify potential deadlock conditions and to request resolution by the ECM. An expander phy shall initialize the Partial Pathway Timeout timer to the time it reports in the PARTIAL PATHWAY TIMEOUT VALUE field in the SMP DISCOVER response (see 10.4.3.10) and run the Partial Pathway Timeout timer whenever the ECM provides confirmation to the expander phy that all expander phys within the requested destination port are blocked waiting on partial pathways.

NOTE 63 - The partial pathway timeout value allows flexibility in specifying how long an expander device waits before attempting pathway recovery. The recommended default value (see 10.4.3.10) was chosen to cover a wide range of topologies. Selecting small partial pathway timeout value values within a large topology may compromise performance because of the time a device waits after receiving OPEN_REJECT (PATHWAY BLOCKED) before it retries the connection request. Similarly, selecting large partial pathway timeout value values within a small topology may compromise performance due to waiting longer than necessary to detect pathway blockage.

When the Partial Pathway Timeout timer is not running, an expander phy shall initialize and start the Partial Pathway Timeout timer when all expander phys within the requested destination port contain a blocked partial pathway (i.e., are returning Phy Status (Blocked Partial Pathway)).

NOTE 64 - The Partial Pathway Timeout timer is not initialized and started if one or more of the expander phys within a requested destination port are being used for a connection.

When one of the conditions above is not met, the expander phy shall stop the Partial Pathway Timeout timer. If the timer expires, pathway recovery shall occur (see 7.12.4.5).

7.12.4.5 Pathway recovery

Pathway recovery provides a means to abort connection requests in order to prevent deadlock using pathway recovery priority comparisons. Pathway recovery priority comparisons compare the PATHWAY BLOCKED COUNT fields and SOURCE SAS ADDRESS fields of the OPEN address frames of the blocked connection requests as described in table 145.

Table 145 — Pathway recovery priority

Bits 71-64 (71 is MSB)	Bits 63-0 (0 is LSB)
PATHWAY BLOCKED COUNT field value	SOURCE SAS ADDRESS field value

When the Partial Pathway Timeout timer for an arbitrating expander phy expires (i.e., reaches a value of zero), the ECM shall determine whether to continue the connection request or to abort the connection request.

The ECM shall reply to a connection request with Arb Reject (Pathway Blocked) when:

- a) the Partial Pathway Timeout timer expires; and
- b) the pathway recovery priority of the arbitrating expander phy (i.e., the expander phy requesting the connection) is less than or equal to the pathway recovery priority of any of the expander phys within the destination port that are sending Phy Status (Blocked Partial Pathway) responses to the ECM.

The pathway blocked count and source SAS address values used to form the pathway recovery priority of a destination phy are those of the Request Path request if the phy sent a Request Path request to the ECM or those of the Forward Open indication if the phy received a Forward Open indication from the ECR.

Page: 351

● Author: RElliott
Subject: Highlight
Date: 6/30/2008 6:16:52 PM
T ACCEPT - DONE

expander phy
s/b
expander logical phy

(per Isi-bday comment on this section)

● Author: RElliott
Subject: Highlight
Date: 6/30/2008 6:16:52 PM
T ACCEPT - DONE

expander phy
s/b
expander logical phy

(per Isi-bday comment on this section)

● Author: wdc-mevans
Subject: Highlight
Date: 5/22/2008 4:23:14 PM
T REJECT (but changed "it reports" to "reported" which sidesteps the issue)

it
s/b
the expander device

● Author: RElliott
Subject: Highlight
Date: 6/30/2008 6:16:52 PM
T ACCEPT - DONE

expander phys
s/b
expander logical phys

(per Isi-bday comment on this section)

● Author: RElliott
Subject: Highlight
Date: 6/30/2008 6:16:52 PM
T ACCEPT - DONE

expander phy
s/b
expander logical phy

(per Isi-bday comment on this section)

● Author: wdc-mevans
Subject: Highlight

NOTE 62 - Expander devices compliant with previous versions of this standard were not required to transmit three consecutive AIP primitives, as AIP was defined as a single primitive sequence (see 7.2.4.2) rather than as an extended primitive sequence (see 7.2.4.5).

Expander devices shall transmit an AIP (e.g., an AIP (NORMAL)) within 128 dwords of receiving an OPEN address frame.

7.12.4.4 Partial Pathway Timeout timer

Each expander phy shall maintain a Partial Pathway Timeout timer. This timer is used to identify potential deadlock conditions and to request resolution by the ECM. An expander phy shall initialize the Partial Pathway Timeout timer to the time it reports in the PARTIAL PATHWAY TIMEOUT VALUE field in the SMP DISCOVER response (see 10.4.3.10) and run the Partial Pathway Timeout timer whenever the ECM provides confirmation to the expander phy that all expander phys within the requested destination port are blocked waiting on partial pathways.

NOTE 63 - The partial pathway timeout value allows flexibility in specifying how long an expander device waits before attempting pathway recovery. The recommended default value (see 10.4.3.10) was chosen to cover a wide range of topologies. Selecting small partial pathway timeout value values within a large topology may compromise performance because of the time a device waits after receiving OPEN_REJECT (PATHWAY BLOCKED) before it retries the connection request. Similarly, selecting large partial pathway timeout value values within a small topology may compromise performance due to waiting longer than necessary to detect pathway blockage.

When the Partial Pathway Timeout timer is not running, an expander phy shall initialize and start the Partial Pathway Timeout timer when all expander phys within the requested destination port contain a blocked partial pathway (i.e., are returning Phy Status (Blocked Partial Pathway)).

NOTE 64 - The Partial Pathway Timeout timer is not initialized and started if one or more of the expander phys within a requested destination port are being used for a connection.

When one of the conditions above is not met, the expander phy shall stop the Partial Pathway Timeout timer. If the timer expires, pathway recovery shall occur (see 7.12.4.5).

7.12.4.5 Pathway recovery

Pathway recovery provides a means to abort connection requests in order to prevent deadlock using pathway recovery priority comparisons. Pathway recovery priority comparisons compare the PATHWAY BLOCKED COUNT fields and SOURCE SAS ADDRESS fields of the OPEN address frames of the blocked connection requests as described in table 145.

Table 145 — Pathway recovery priority

Bits 71-64 (71 is MSB)	Bits 63-0 (0 is LSB)
PATHWAY BLOCKED COUNT field value	SOURCE SAS ADDRESS field value

When the Partial Pathway Timeout timer for an arbitrating expander phy expires (i.e., reaches a value of zero), the ECM shall determine whether to continue the connection request or to abort the connection request.

The ECM shall reply to a connection request with Arb Reject (Pathway Blocked) when:

- a) the Partial Pathway Timeout timer expires; and
- b) the pathway recovery priority of the arbitrating expander phy (i.e., the expander phy requesting the connection) is less than or equal to the pathway recovery priority of any of the expander phys within the destination port that are sending Phy Status (Blocked Partial Pathway) responses to the ECM.

The pathway blocked count and source SAS address values used to form the pathway recovery priority of a destination phy are those of the Request Path request if the phy sent a Request Path request to the ECM or those of the Forward Open indication if the phy received a Forward Open indication from the ECR.

Date: 5/22/2008 4:23:57 PM

T REJECT (but changed "it retries" to "retrying", sidestepping the issue)

it
s/b
the device

● Author: RElliott
Subject: Highlight
Date: 6/30/2008 6:16:52 PM

T ACCEPT - DONE

expander phy
s/b
expander logical phy

(per Isi-bday comment on this section)

● Author: RElliott
Subject: Highlight
Date: 6/30/2008 6:16:52 PM

T ACCEPT - DONE

expander phys
s/b
expander logical phys

(per Isi-bday comment on this section)

● Author: RElliott
Subject: Highlight
Date: 6/30/2008 6:16:52 PM

T ACCEPT - DONE

expander phys
s/b
expander logical phys

(per Isi-bday comment on this section)

● Author: Isi-gpenokie
Subject: Highlight
Date: 5/6/2008 4:07:49 PM

T REJECT (This is just explaining a side-effect of all the rules, and is of NOTE quality)

This note << NOTE 64 - The Partial Pathway >> should be made into normative text.

● Author: RElliott
Subject: Highlight
Date: 6/30/2008 6:16:52 PM

T ACCEPT - DONE

expander phy
s/b
expander logical phy

(per Isi-bday comment on this section)

● Author: RElliott

Comments from page 351 continued on next page

NOTE 62 - Expander devices compliant with previous versions of this standard were not required to transmit three consecutive AIP primitives, as AIP was defined as a single primitive sequence (see 7.2.4.2) rather than as an extended primitive sequence (see 7.2.4.5).

Expander devices shall transmit an AIP (e.g., an AIP (NORMAL)) within 128 dwords of receiving an OPEN address frame.

7.12.4.4 Partial Pathway Timeout timer

Each expander phy shall maintain a Partial Pathway Timeout timer. This timer is used to identify potential deadlock conditions and to request resolution by the ECM. An expander phy shall initialize the Partial Pathway Timeout timer to the time it reports in the PARTIAL PATHWAY TIMEOUT VALUE field in the SMP DISCOVER response (see 10.4.3.10) and run the Partial Pathway Timeout timer whenever the ECM provides confirmation to the expander phy that all expander phys within the requested destination port are blocked waiting on partial pathways.

NOTE 63 - The partial pathway timeout value allows flexibility in specifying how long an expander device waits before attempting pathway recovery. The recommended default value (see 10.4.3.10) was chosen to cover a wide range of topologies. Selecting small partial pathway timeout value values within a large topology may compromise performance because of the time a device waits after receiving OPEN_REJECT (PATHWAY BLOCKED) before it retries the connection request. Similarly, selecting large partial pathway timeout value values within a small topology may compromise performance due to waiting longer than necessary to detect pathway blockage.

When the Partial Pathway Timeout timer is not running, an expander phy shall initialize and start the Partial Pathway Timeout timer when all expander phys within the requested destination port contain a blocked partial pathway (i.e., are returning Phy Status (Blocked Partial Pathway)).

NOTE 64 - The Partial Pathway Timeout timer is not initialized and started if one or more of the expander phys within a requested destination port are being used for a connection.

When one of the conditions above is not met, the expander phy shall stop the Partial Pathway Timeout timer. If the timer expires, pathway recovery shall occur (see 7.12.4.5).

7.12.4.5 Pathway recovery

Pathway recovery provides a means to abort connection requests in order to prevent deadlock using pathway recovery priority comparisons. Pathway recovery priority comparisons compare the PATHWAY BLOCKED COUNT fields and SOURCE SAS ADDRESS fields of the OPEN address frames of the blocked connection requests as described in table 145.

Table 145 — Pathway recovery priority

Bits 71-64 (71 is MSB)	Bits 63-0 (0 is LSB)
PATHWAY BLOCKED COUNT field value	SOURCE SAS ADDRESS field value

When the Partial Pathway Timeout timer for an arbitrating expander phy expires (i.e., reaches a value of zero), the ECM shall determine whether to continue the connection request or to abort the connection request.

The ECM shall reply to a connection request with Arb Reject (Pathway Blocked) when:

- a) the Partial Pathway Timeout timer expires; and
- b) the pathway recovery priority of the arbitrating expander phy (i.e., the expander phy requesting the connection) is less than or equal to the pathway recovery priority of any of the expander phys within the destination port that are sending Phy Status (Blocked Partial Pathway) responses to the ECM.

The pathway blocked count and source SAS address values used to form the pathway recovery priority of a destination phy are those of the Request Path request if the phy sent a Request Path request to the ECM or those of the Forward Open indication if the phy received a Forward Open indication from the ECR.

Subject: Highlight
Date: 6/30/2008 6:16:52 PM
T ACCEPT - DONE

pathway
s/b
then pathway

Author: RElliott
Subject: Highlight
Date: 6/30/2008 6:16:52 PM
T ACCEPT - DONE

expander phy
s/b
expander logical phy

(per Isi-bday comment on this section)

Author: RElliott
Subject: Highlight
Date: 6/30/2008 6:16:52 PM
T ACCEPT - DONE

expander phy
s/b
expander logical phy

(per Isi-bday comment on this section)

Author: RElliott
Subject: Highlight
Date: 6/30/2008 6:16:52 PM
T ACCEPT - DONE

expander phy
s/b
expander logical phy

(per Isi-bday comment on this section)

Author: RElliott
Subject: Highlight
Date: 6/30/2008 6:16:52 PM
T ACCEPT - DONE

expander phys
s/b
expander logical phys

(per Isi-bday comment on this section)

Author: RElliott
Subject: Highlight
Date: 6/30/2008 6:16:52 PM
T ACCEPT - DONE

phy
s/b
expander logical phy

NOTE 62 - Expander devices compliant with previous versions of this standard were not required to transmit three consecutive AIP primitives, as AIP was defined as a single primitive sequence (see 7.2.4.2) rather than as an extended primitive sequence (see 7.2.4.5).

Expander devices shall transmit an AIP (e.g., an AIP (NORMAL)) within 128 dwords of receiving an OPEN address frame.

7.12.4.4 Partial Pathway Timeout timer

Each expander phy shall maintain a Partial Pathway Timeout timer. This timer is used to identify potential deadlock conditions and to request resolution by the ECM. An expander phy shall initialize the Partial Pathway Timeout timer to the time it reports in the PARTIAL PATHWAY TIMEOUT VALUE field in the SMP DISCOVER response (see 10.4.3.10) and run the Partial Pathway Timeout timer whenever the ECM provides confirmation to the expander phy that all expander phys within the requested destination port are blocked waiting on partial pathways.

NOTE 63 - The partial pathway timeout value allows flexibility in specifying how long an expander device waits before attempting pathway recovery. The recommended default value (see 10.4.3.10) was chosen to cover a wide range of topologies. Selecting small partial pathway timeout value values within a large topology may compromise performance because of the time a device waits after receiving OPEN_REJECT (PATHWAY BLOCKED) before it retries the connection request. Similarly, selecting large partial pathway timeout value values within a small topology may compromise performance due to waiting longer than necessary to detect pathway blockage.

When the Partial Pathway Timeout timer is not running, an expander phy shall initialize and start the Partial Pathway Timeout timer when all expander phys within the requested destination port contain a blocked partial pathway (i.e., are returning Phy Status (Blocked Partial Pathway)).

NOTE 64 - The Partial Pathway Timeout timer is not initialized and started if one or more of the expander phys within a requested destination port are being used for a connection.

When one of the conditions above is not met, the expander phy shall stop the Partial Pathway Timeout timer. If the timer expires, pathway recovery shall occur (see 7.12.4.5).

7.12.4.5 Pathway recovery

Pathway recovery provides a means to abort connection requests in order to prevent deadlock using pathway recovery priority comparisons. Pathway recovery priority comparisons compare the PATHWAY BLOCKED COUNT fields and SOURCE SAS ADDRESS fields of the OPEN address frames of the blocked connection requests as described in table 145.

Table 145 — Pathway recovery priority

Bits 71-64 (71 is MSB)	Bits 63-0 (0 is LSB)
PATHWAY BLOCKED COUNT field value	SOURCE SAS ADDRESS field value

When the Partial Pathway Timeout timer for an arbitrating expander phy expires (i.e., reaches a value of zero), the ECM shall determine whether to continue the connection request or to abort the connection request.

The ECM shall reply to a connection request with Arb Reject (Pathway Blocked) when:

- a) the Partial Pathway Timeout timer expires; and
- b) the pathway recovery priority of the arbitrating expander phy (i.e., the expander phy requesting the connection) is less than or equal to the pathway recovery priority of any of the expander phys within the destination port that are sending Phy Status (Blocked Partial Pathway) responses to the ECM.

The pathway blocked count and source SAS address values used to form the pathway recovery priority of a destination phy are those of the Request Path request if the phy sent a Request Path request to the ECM or those of the Forward Open indication if the phy received a Forward Open indication from the ECR.

Author: RElliott
Subject: Highlight
Date: 6/30/2008 6:16:52 PM
T ACCEPT - DONE

phy
s/b
expander logical phy

7.12.5 BREAK handling

A phy aborts a connection request (see 7.12.6) and breaks a connection (see 7.12.8) by transmitting a BREAK primitive sequence.

Phys shall enable the BREAK_REPLY method of responding to received BREAK primitive sequences when:

- a) the BREAK_REPLY CAPABLE bit transmitted by the phy in the outgoing IDENTIFY address frame is set to one; and
- b) the BREAK_REPLY CAPABLE bit received by the phy in the incoming IDENTIFY address frame is set to one.

Phys shall disable the BREAK_REPLY method of responding to received BREAK primitive sequences if the BREAK_REPLY CAPABLE bit received by the phy in the incoming IDENTIFY address frame is set to zero.

Phys contained within SAS devices or expander devices that are compliant with this standard shall set the BREAK_REPLY CAPABLE bit to one in their outgoing IDENTIFY address frame.

If the BREAK_REPLY method of responding to received BREAK primitive sequences is enabled, then the phy shall transmit a BREAK_REPLY primitive sequence in response to a received BREAK primitive sequence.

If the BREAK_REPLY method of responding to received BREAK primitive sequences is disabled, then the phy shall transmit a BREAK primitive sequence in response to a received BREAK primitive sequence.

NOTE 65 - Phys compliant with earlier versions of this standard do not set the BREAK_REPLY CAPABLE bit in their outgoing IDENTIFY address frame.

7.12.6 Aborting a connection request

BREAK may be used to abort a connection request. The source phy shall transmit a BREAK after the Open Timeout timer expires or if it chooses to abort its request for any other reason before a connection is established.

After transmitting BREAK, the source phy shall initialize a Break Timeout timer to 1 ms and start the Break Timeout timer.

After a phy transmits a BREAK to abort a connection request, it shall expect one of the results listed in table 146.

Table 146 — Results of aborting a connection request

BREAK_REPLY method of responding to received BREAK primitive sequences	Result	Description
Disabled	Receive BREAK	This confirms that the connection request has been aborted.
	Receive BREAK_REPLY	Ignore.
Enabled	Receive BREAK	The originating phy shall transmit BREAK_REPLY and wait to receive BREAK_REPLY or for the BREAK Timeout timer to expire.
	Receive BREAK_REPLY	This confirms that the connection request has been aborted.
Enabled or disabled	Break Timeout timer expires	The originating phy shall assume the connection request has been aborted.

● Author: RElliott
Subject: Highlight
Date: 6/30/2008 6:16:52 PM
T ACCEPT - DONE

phy
s/b
logical phy

● Author: RElliott
Subject: Highlight
Date: 6/30/2008 6:16:52 PM
T ACCEPT - DONE

Phys
s/b
Logical phy

● Author: RElliott
Subject: Highlight
Date: 6/30/2008 6:16:52 PM
T ACCEPT - DONE

phy
s/b
logical phy

● Author: RElliott
Subject: Highlight
Date: 6/30/2008 6:16:52 PM
T ACCEPT - DONE

phy
s/b
logical phy

● Author: RElliott
Subject: Highlight
Date: 6/30/2008 6:16:52 PM
T ACCEPT - DONE

Phys
s/b
Logical phy

● Author: RElliott
Subject: Highlight
Date: 6/30/2008 6:16:52 PM
T ACCEPT - DONE

phy
s/b
logical phy

7.12.5 BREAK handling

A phy aborts a connection request (see 7.12.6) and breaks a connection (see 7.12.8) by transmitting a BREAK primitive sequence.

Phys shall enable the BREAK_REPLY method of responding to received BREAK primitive sequences when:

- a) the BREAK_REPLY CAPABLE bit transmitted by the phy in the outgoing IDENTIFY address frame is set to one; and
- b) the BREAK_REPLY CAPABLE bit received by the phy in the incoming IDENTIFY address frame is set to one.

Phys shall disable the BREAK_REPLY method of responding to received BREAK primitive sequences if the BREAK_REPLY CAPABLE bit received by the phy in the incoming IDENTIFY address frame is set to zero.

Phys contained within SAS devices or expander devices that are compliant with this standard shall set the BREAK_REPLY CAPABLE bit to one in their outgoing IDENTIFY address frame.

If the BREAK_REPLY method of responding to received BREAK primitive sequences is enabled, then the phy shall transmit a BREAK_REPLY primitive sequence in response to a received BREAK primitive sequence.

If the BREAK_REPLY method of responding to received BREAK primitive sequences is disabled, then the phy shall transmit a BREAK primitive sequence in response to a received BREAK primitive sequence.

NOTE 65 - Phys compliant with earlier versions of this standard do not set the BREAK_REPLY CAPABLE bit in their outgoing IDENTIFY address frame.

7.12.6 Aborting a connection request

BREAK may be used to abort a connection request. The source phy shall transmit a BREAK after the Open Timeout timer expires or if it chooses to abort its request for any other reason before a connection is established.

After transmitting BREAK, the source phy shall initialize a Break Timeout timer to 1 ms and start the Break Timeout timer.

After a phy transmits a BREAK to abort a connection request, it shall expect one of the results listed in table 146.

Table 146 — Results of aborting a connection request

BREAK_REPLY method of responding to received BREAK primitive sequences	Result	Description
Disabled	Receive BREAK	This confirms that the connection request has been aborted.
	Receive BREAK_REPLY	Ignore.
Enabled	Receive BREAK	The originating phy shall transmit BREAK_REPLY and wait to receive BREAK_REPLY or for the BREAK Timeout timer to expire.
	Receive BREAK_REPLY	This confirms that the connection request has been aborted.
Enabled or disabled	Break Timeout timer expires	The originating phy shall assume the connection request has been aborted.

Author: RElliott
Subject: Highlight
Date: 6/30/2008 6:16:52 PM

T ACCEPT - DONE

Phys
s/b
Logical phy

Author: ibm-steve-wallace
Subject: Highlight
Date: 5/6/2008 4:07:49 PM

T REJECT (correct, a SAS-1.1 phy does not automatically get to claim it is a SAS-2 phy. A SAS-2 phy will interoperate with it as well as a SAS-1.1 phy would - the BREAK problems are present)

This cannot be supported on some older devices which do not have the capability to send BREAK_REPLY. So, some older devices may never be able to support this level of SAS.

Author: RElliott
Subject: Highlight
Date: 6/30/2008 6:16:52 PM

T ACCEPT - DONE

phy
s/b
logical phy

Author: RElliott
Subject: Highlight
Date: 6/30/2008 6:16:52 PM

T ACCEPT - DONE

phy
s/b
logical phy

Author: RElliott
Subject: Highlight
Date: 6/30/2008 6:16:52 PM

T ACCEPT - DONE

frame
s/b
frames

Author: wdc-mevans
Subject: Highlight
Date: 5/30/2008 6:07:55 PM

T REJECT

it chooses to abort its
s/b
the phy aborts the

Author: Isi-gpenokie
Subject: Highlight
Date: 5/30/2008 6:08:07 PM

T REJECT (first noun/subject convention)

This << or if it chooses to abort its request >> should be << or if the source phy chooses to abort its request >>

Comments from page 352 continued on next page

7.12.5 BREAK handling

A phy aborts a connection request (see 7.12.6) and breaks a connection (see 7.12.8) by transmitting a BREAK primitive sequence.

Phys shall enable the BREAK_REPLY method of responding to received BREAK primitive sequences when:

- a) the BREAK_REPLY CAPABLE bit transmitted by the phy in the outgoing IDENTIFY address frame is set to one; and
- b) the BREAK_REPLY CAPABLE bit received by the phy in the incoming IDENTIFY address frame is set to one.

Phys shall disable the BREAK_REPLY method of responding to received BREAK primitive sequences if the BREAK_REPLY CAPABLE bit received by the phy in the incoming IDENTIFY address frame is set to zero.

Phys contained within SAS devices or expander devices that are compliant with this standard shall set the BREAK_REPLY CAPABLE bit to one in their outgoing IDENTIFY address frame.

If the BREAK_REPLY method of responding to received BREAK primitive sequences is enabled, then the phy shall transmit a BREAK_REPLY primitive sequence in response to a received BREAK primitive sequence.

If the BREAK_REPLY method of responding to received BREAK primitive sequences is disabled, then the phy shall transmit a BREAK primitive sequence in response to a received BREAK primitive sequence.

NOTE 65 - Phys compliant with earlier versions of this standard do not set the BREAK_REPLY CAPABLE bit in their outgoing IDENTIFY address frame.

7.12.6 Aborting a connection request

BREAK may be used to abort a connection request. The source phy shall transmit a BREAK after the Open Timeout timer expires or if it chooses to abort its request for any other reason before a connection is established.

After transmitting BREAK, the source phy shall initialize a Break Timeout timer to 1 ms and start the Break Timeout timer.

After a phy transmits a BREAK to abort a connection request, it shall expect one of the results listed in table 146.

Table 146 — Results of aborting a connection request

BREAK_REPLY method of responding to received BREAK primitive sequences	Result	Description
Disabled	Receive BREAK	This confirms that the connection request has been aborted.
	Receive BREAK_REPLY	Ignore.
Enabled	Receive BREAK	The originating phy shall transmit BREAK_REPLY and wait to receive BREAK_REPLY or for the BREAK Timeout timer to expire.
	Receive BREAK_REPLY	This confirms that the connection request has been aborted.
Enabled or disabled	Break Timeout timer expires	The originating phy shall assume the connection request has been aborted.

Author: wdc-mevans
Subject: Highlight
Date: 5/25/2008 8:54:43 PM
T REJECT (first noun/subject convention)

it
s/b
the phy

Author: RElliott
Subject: Highlight
Date: 6/30/2008 6:16:52 PM
T ACCEPT - DONE

phy
s/b
source phy

Author: stx-goulder
Subject: Highlight
Date: 5/25/2008 8:55:04 PM
T ACCEPT - DONE

Ignore
expand to "ignore the BREAK_REPLY."

When a logical phy transmitting a BREAK is attached to an expander device, the BREAK or BREAK_REPLY response to the logical phy is generated by the expander logical phy to which the logical phy is attached, not the other SAS logical phy in the connection. If the expander device has transmitted a connection request to the destination, it shall also transmit BREAK to the destination. If the expander device has not transmitted a connection request to the destination, it shall not transmit BREAK to the destination. After transmitting BREAK or BREAK_REPLY back to the source phy, the expander device shall ensure that a connection response does not occur (i.e., the expander device shall not forward dwords from the destination any more). Figure 180 shows an example of BREAK usage. Multiplexing is disabled on all phys in the example.

Case 1: OPEN address frame has not propagated through the expander device:

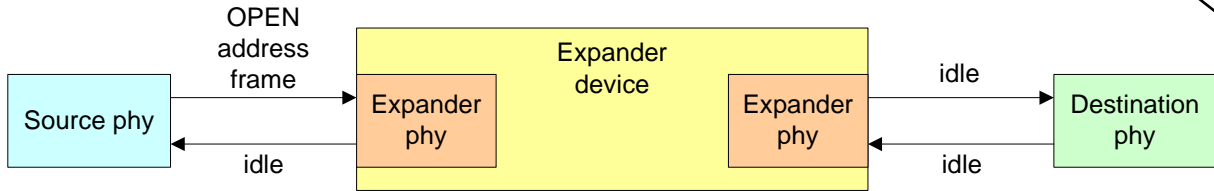

Case 1 result: expander device transmits BREAK_REPLY to the source phy

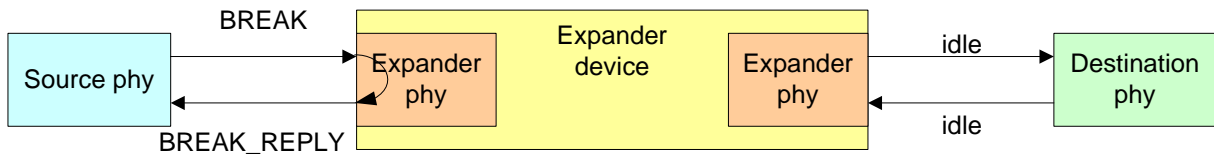

Case 2: OPEN address frame has propagated through the expander device:

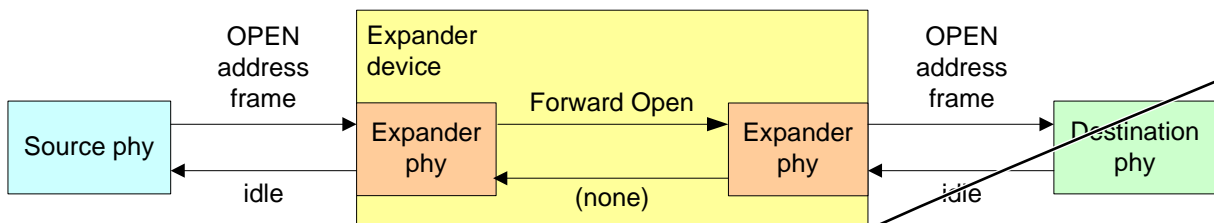

Case 2 result: Expander device transmits BREAK_REPLY to the source phy and BREAK to the destination phy, then waits for BREAK_REPLY from the destination phy

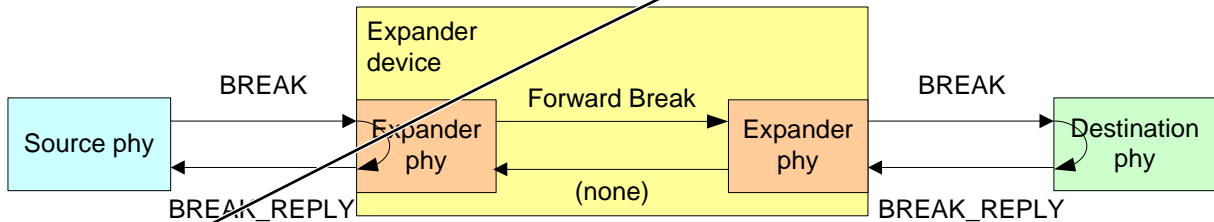

NOTE: if the BREAK_REPLY method of responding to BREAK primitive sequences is disabled, phys transmit BREAK rather than BREAK_REPLY in response to BREAK.

Figure 180 — Aborting a connection request with BREAK

● Author: wdc-mevans

Subject: Highlight

Date: 5/25/2008 8:57:28 PM

T REJECT (first noun/subject convention, but added "then" which was not requested)

it

s/b

the expander device

● Author: wdc-mevans

Subject: Highlight

Date: 5/25/2008 8:57:32 PM

T REJECT (first noun/subject convention, but added "then" which was not requested)

it

s/b

the expander device

● Author: Isi-gpenokie

Subject: Cross-Out

Date: 5/25/2008 8:58:02 PM

T REJECT (but changed to "no longer forward")

Extraneous words that add nothing.

● Author: RElliott

Subject: Highlight

Date: 8/27/2008 5:58:38 PM

T ACCEPT - DONE

NOTE

s/b

Note

Figure 181 shows the sequence for a connection request where the Open Timeout timer expires.

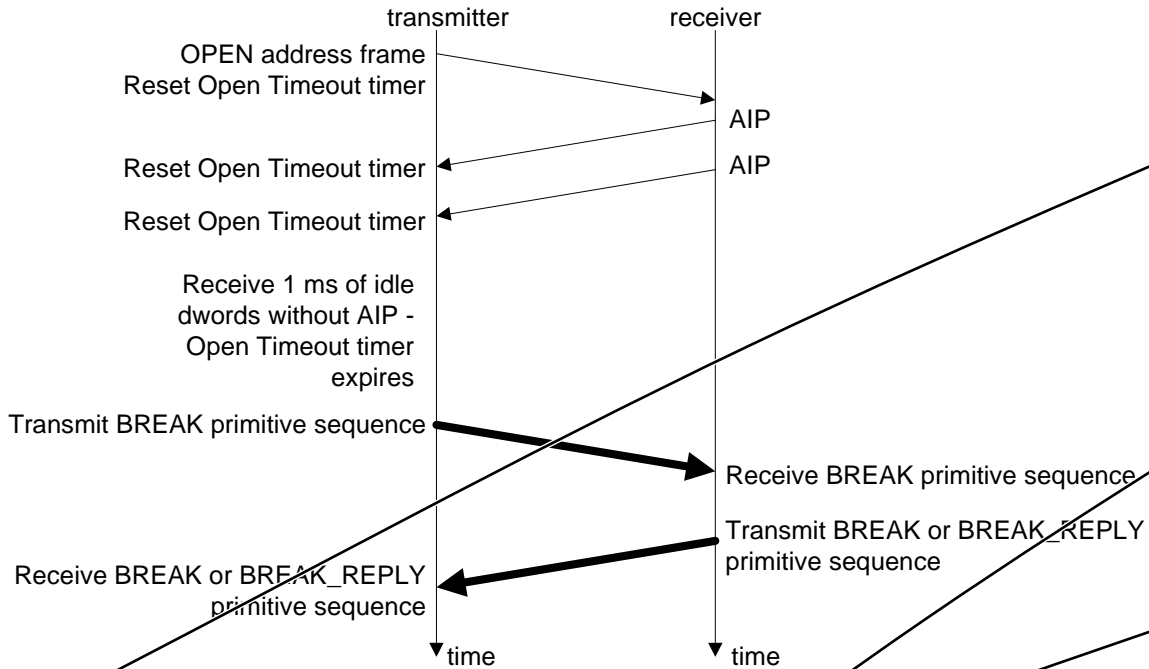

NOTE: if the BREAK_REPLY method of responding to BREAK primitive sequences is disabled, phys transmit BREAK rather than BREAK_REPLY in response to BREAK.

Figure 181 — Connection request timeout example

7.12.7 Closing a connection

CLOSE is used to close a connection of any protocol. See 7.16.7 for details on closing SSP connections, 7.17.6 for details on closing STP connections, and 7.18.4 for details on closing SMP connections.

After transmitting CLOSE, the source phy shall initialize a Close Timeout timer to 1 ms and start the Close Timeout timer.

After a phy transmits CLOSE to close a connection, it shall expect one of the results listed in table 147.

Table 147 — Results of closing a connection

Result	Description
Receive CLOSE	This confirms that the connection has been closed.
Close Timeout timer expires	The originating phy shall attempt to break the connection (see 7.12.8).

No additional dwords for the connection shall follow the CLOSE. Expander devices shall close the full-duplex connection upon forwarding a CLOSE in each direction.

When a phy has both transmitted and received CLOSE, it shall consider the connection closed.

● Author: RElliott
Subject: Highlight
Date: 8/27/2008 5:58:52 PM
T ACCEPT - DONE

NOTE
s/b
Note

● Author: RElliott
Subject: Highlight
Date: 6/30/2008 6:16:52 PM
T ACCEPT - DONE

source phy
s/b
originating phy

● Author: RElliott
Subject: Highlight
Date: 6/30/2008 6:16:52 PM
T ACCEPT - DONE

phy
s/b
logical phy

● Author: wdc-mevans
Subject: Highlight
Date: 5/23/2008 1:25:45 PM
T REJECT (first noun/subject convention)

it
s/b
the phy

● Author: RElliott
Subject: Highlight
Date: 6/30/2008 6:16:52 PM
T ACCEPT - DONE

phy
s/b
logical phy

Figure 182 shows example sequences for closing a connection.

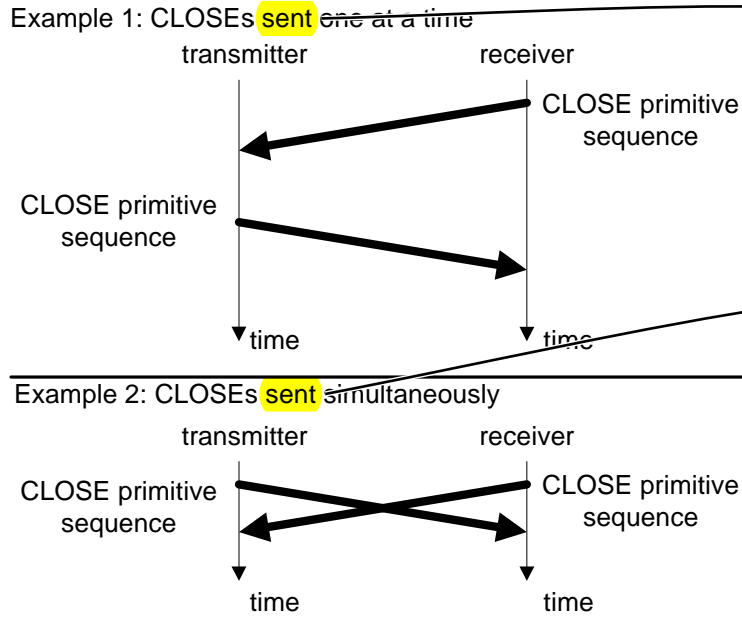

Figure 182 — Closing a connection example

7.12.8 Breaking a connection

In addition to aborting a connection request, BREAK may also be used to break a connection, in cases where CLOSE is not available. After transmitting BREAK, the originating phy shall ignore all incoming dwords except for BREAKs and BREAK_REPLYs.

After transmitting BREAK, the source phy shall initialize a Break Timeout timer to 1 ms and start the Break Timeout timer.

After a phy transmits a BREAK to break a connection, it shall expect one of the results listed in table 148.

Table 148 — Results of breaking a connection

BREAK_REPLY method of responding to received BREAK primitive sequences	Result	Description
Disabled	Receive BREAK	This confirms that the connection has been broken.
	Receive BREAK_REPLY	Ignore.
Enabled	Receive BREAK	The originating phy shall transmit BREAK_REPLY and wait to receive BREAK_REPLY or for the BREAK Timeout timer to expire.
	Receive BREAK_REPLY	This confirms that the connection has been broken.
Enabled or disabled	Break Timeout timer expires	The originating phy shall assume the connection has been broken. The originating phy may perform a link reset sequence.

● Author: RElliott
Subject: Highlight
Date: 6/30/2008 6:16:52 PM
T ACCEPT - DONE
sent
s/b
transmitted

● Author: RElliott
Subject: Highlight
Date: 6/30/2008 6:16:52 PM
T ACCEPT - DONE
sent
s/b
transmitted

● Author: wdc-mevans
Subject: Highlight
Date: 5/30/2008 6:08:34 PM
T ACCEPT - DONE
connection, in
s/b
connection in

● Author: lsi-bday
Subject: Highlight
Date: 6/28/2008 6:11:58 PM
T ACCEPT - DONE (added ", and deletable primitives")
except for BREAKs and BREAK_REPLYs
s/b
except for BREAKs, BREAK_REPLYs, MUXs, and NOTIFYs.

● Author: RElliott
Subject: Highlight
Date: 6/30/2008 6:16:52 PM
T ACCEPT - DONE
source phy
s/b
originating phy

● Author: wdc-mevans
Subject: Highlight
Date: 5/25/2008 9:00:13 PM
T REJECT (first noun/subject convention)
it
s/b
the phy

● Author: RElliott
Subject: Highlight
Date: 6/30/2008 6:16:52 PM
T ACCEPT - DONE
phy

Figure 182 shows example sequences for closing a connection.

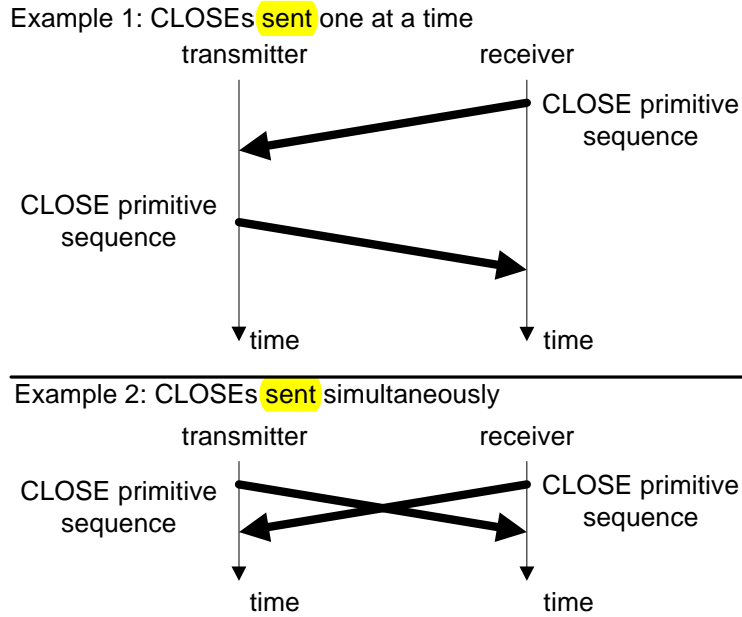

Figure 182 — Closing a connection example

7.12.8 Breaking a connection

In addition to aborting a connection request, BREAK may also be used to break a connection, in cases where CLOSE is not available. After transmitting BREAK, the originating phy shall ignore all incoming dwords except for BREAKs and BREAK_REPLYs.

After transmitting BREAK, the source phy shall initialize a Break Timeout timer to 1 ms and start the Break Timeout timer.

After a phy transmits a BREAK to break a connection, it shall expect one of the results listed in table 148.

Table 148 — Results of breaking a connection

BREAK_REPLY method of responding to received BREAK primitive sequences	Result	Description
Disabled	Receive BREAK	This confirms that the connection has been broken.
	Receive BREAK_REPLY	Ignore.
Enabled	Receive BREAK	The originating phy shall transmit BREAK_REPLY and wait to receive BREAK_REPLY or for the BREAK Timeout timer to expire.
	Receive BREAK_REPLY	This confirms that the connection has been broken.
Enabled or disabled	Break Timeout timer expires	The originating phy shall assume the connection has been broken. The originating phy may perform a link reset sequence.

s/b
logical phy

Author: stx-ghoulder
Subject: Highlight
Date: 5/25/2008 9:01:23 PM

 ACCEPT - DONE
Ignore

replace with "ignore the BREAK_REPLY."

In addition to a BREAK, a connection is considered broken if a link reset sequence starts (i.e., the SP state machine transitions from SP15:SAS_PHY_Ready or SP22:SATA_PHY_Ready to SP0:OOB_COMINIT (see 6.8)).

See 7.16.6 for additional rules on breaking an SSP connection.

7.13 Rate matching

Each successful connection request contains the connection rate (see 4.1.12) of the pathway.

Each logical phy in the pathway shall insert deletable primitives between dwords if its logical link rate is faster than the connection rate as described in table 149.

Table 149 — Rate matching deletable primitive insertion requirements

Logical link rate	Connection rate	Requirement
1.5 Gbps	1.5 Gbps	None
3 Gbps	1.5 Gbps	One deletable primitive within every 2 dwords that are not physical link rate tolerance management deletable primitives (i.e., every overlapping window of 2 dwords)(e.g., a repeating pattern of a deletable primitive followed by a dword, or a repeating pattern of a dword followed by an deletable primitive)
	3 Gbps	None
6 Gbps	1.5 Gbps	Three deletable primitives within every 4 dwords that are not physical link rate tolerance management deletable primitives (i.e., 3 in every overlapping window of 4 dwords)
	3 Gbps	One deletable primitive within every 2 dwords that are not physical link rate tolerance management deletable primitives (i.e., every overlapping window of 2 dwords)(e.g., a repeating pattern of a deletable primitive followed by a dword, or a repeating pattern of a dword followed by an deletable primitive)
	6 Gbps	None

Deletable primitives inserted for rate matching are in addition to deletable primitives inserted for physical link rate tolerance management (see 7.3). See Annex H for a summary of their combined requirements.

This page contains no comments

Figure 183 shows an example of rate matching between a 3 Gbps source phy and a 3 Gbps destination phy, with an intermediate 1.5 Gbps physical link in between them.

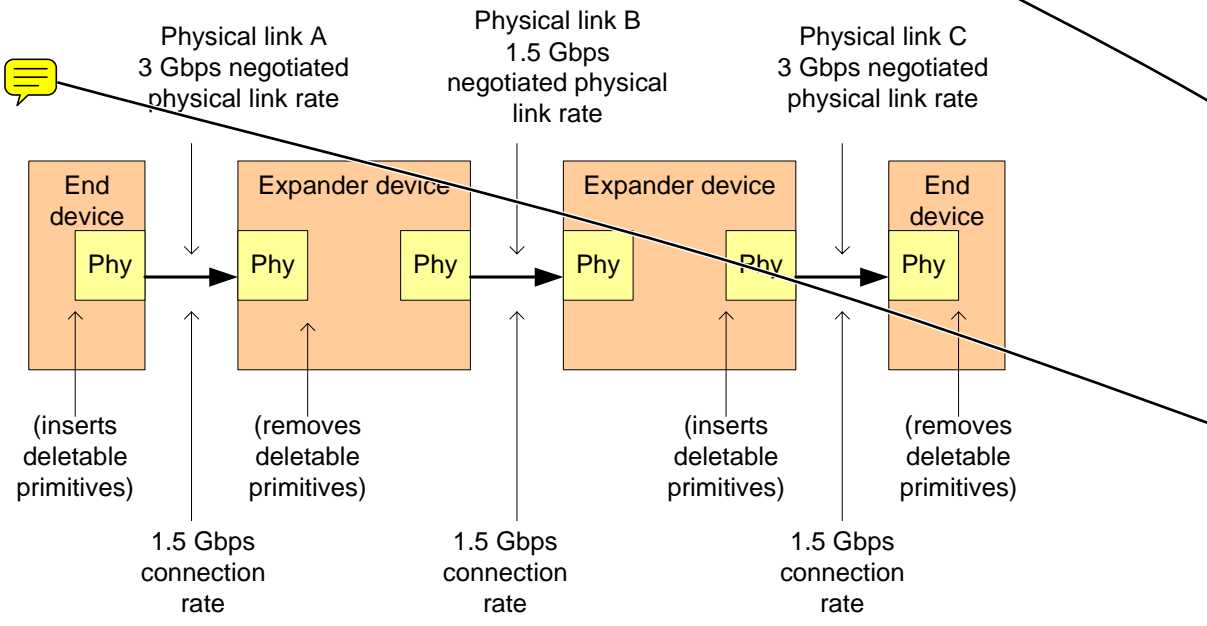

Sample dwords on physical links (from left to right) during a 1.5 Gbps connection:

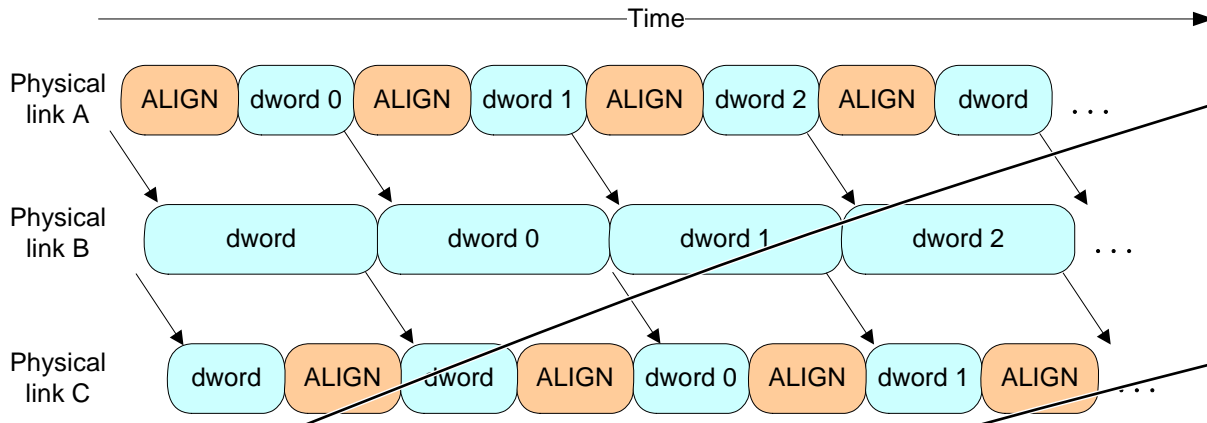

Figure 183 — Rate matching example

A phy originating dwords shall start rate matching at the selected connection rate starting with the first dword that is not a deletable primitive inserted for physical link rate tolerance management following:

- a) transmitting the EOAF for an OPEN address frame; or
- b) transmitting an OPEN_ACCEPT.

An expander phy forwarding dwords shall not insert deletable primitives for rate matching based on counting dwords transmitted. It shall insert deletable primitives whenever it underflows.

The source phy transmits idle dwords including deletable primitives at the selected connection rate while waiting for the connection response. This enables each expander device to start forwarding dwords from the source phy to the destination phy after forwarding an OPEN_ACCEPT.

A phy shall stop inserting deletable primitives for rate matching after:

- a) transmitting the first dword in a CLOSE;
- b) transmitting the first dword in a BREAK;
- c) transmitting the first dword in a BREAK_REPLY;
- d) receiving an OPEN_REJECT for a connection request; or

Page: 357

● Author: RElliott
Subject: Highlight
Date: 6/30/2008 6:16:52 PM
 ACCEPT - DONE

destination phy
s/b
receiving phy

● Author: RElliott
Subject: Highlight
Date: 6/30/2008 6:16:52 PM
 ACCEPT - DONE

source phy
s/b
originating phy

● Author: lsi-bbesmer
Subject: Note
Date: 6/28/2008 6:13:26 PM
 ACCEPT - DONE (added "Multiplexing is disabled in this example.")

Shouldn't these be logical link rates & logical links?

● Author: RElliott
Subject: Highlight
Date: 6/30/2008 6:16:52 PM
 ACCEPT - DONE

phy
s/b
logical phy

● Author: RElliott
Subject: Highlight
Date: 6/30/2008 6:16:52 PM
 ACCEPT - DONE

expander phy
s/b
expander logical phy

● Author: wdc-mevans
Subject: Highlight
Date: 5/30/2008 6:10:40 PM
 REJECT (but joined sentences to eliminate the first "it". We don't use "underflow condition" anywhere.)

It shall insert deletable primitives whenever it underflows.
s/b
An expander phy shall insert deletable primitives whenever an underflow condition occurs.

● Author: RElliott
Subject: Highlight
Date: 6/30/2008 6:16:52 PM
 ACCEPT - DONE

phy
s/b

Comments from page 357 continued on next page

Figure 183 shows an example of rate matching between a 3 Gbps source phy and a 3 Gbps destination phy, with an intermediate 1.5 Gbps physical link in between them.

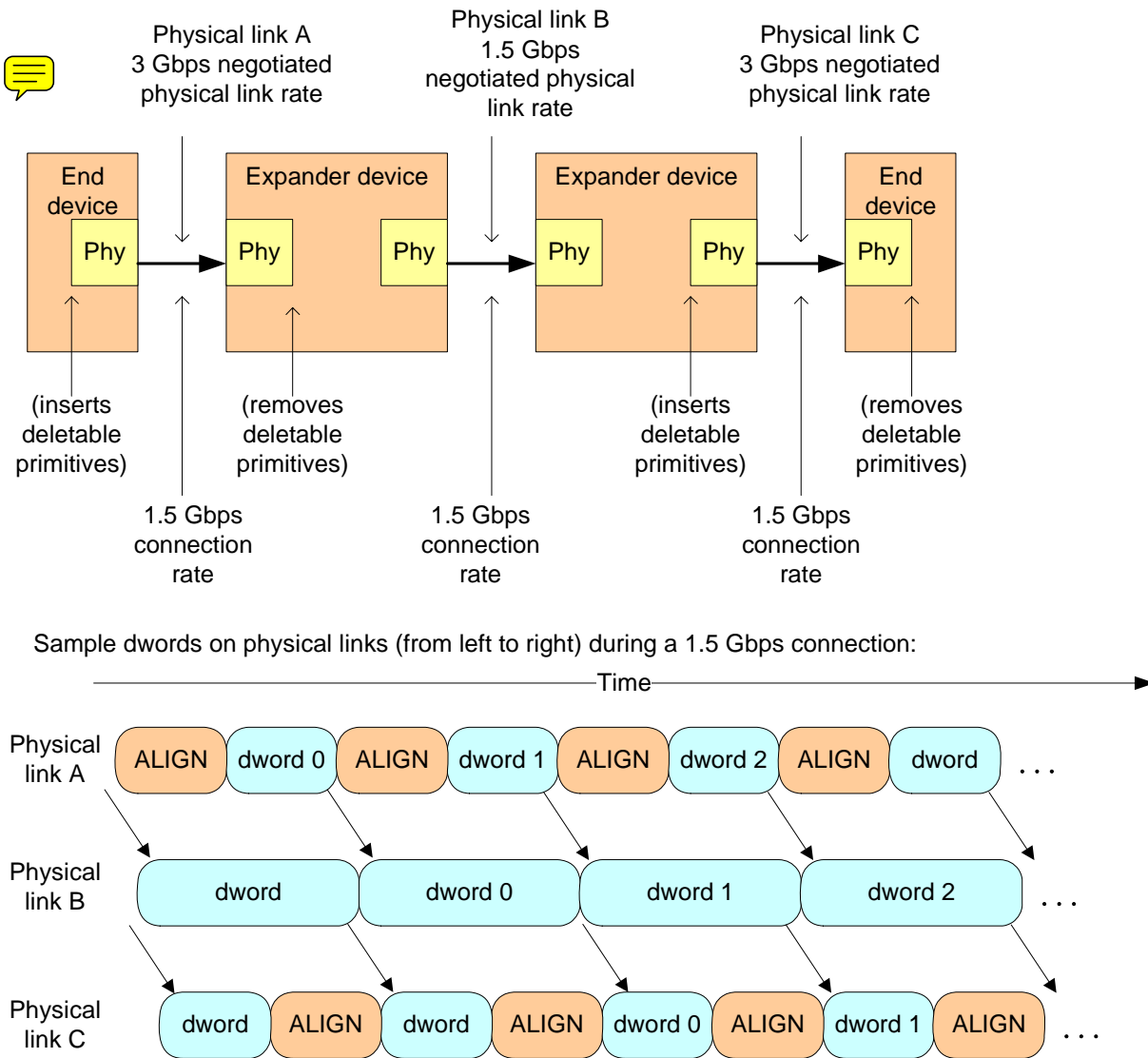

Figure 183 — Rate matching example

A phy originating dwords shall start rate matching at the selected connection rate starting with the first dword that is not a deletable primitive inserted for physical link rate tolerance management following:

- a) transmitting the EOAF for an OPEN address frame; or
- b) transmitting an OPEN_ACCEPT.

An expander phy forwarding dwords shall not insert deletable primitives for rate matching based on counting dwords transmitted. It shall insert deletable primitives whenever it underflows.

The source phy transmits idle dwords including deletable primitives at the selected connection rate while waiting for the connection response. This enables each expander device to start forwarding dwords from the source phy to the destination phy after forwarding an OPEN_ACCEPT.

A phy shall stop inserting deletable primitives for rate matching after:

- a) transmitting the first dword in a CLOSE;
- b) transmitting the first dword in a BREAK;
- c) transmitting the first dword in a BREAK_REPLY;
- d) receiving an OPEN_REJECT for a connection request; or

- e) losing arbitration to a received OPEN address frame.

7.14 SL (link layer for SAS logical phys) state machines

7.14.1 SL state machines overview

The SL (link layer for SAS logical phys) state machines controls connections, handling both connection requests (OPEN address frames), CLOSEs, and BREAKs. The SL state machines are as follows:

- a) SL_RA (receive OPEN address frame) state machine (see 7.14.3); and
- b) SL_CC (connection control) state machine (see 7.14.4).

All the SL state machines shall begin after receiving an Enable Disable SAS Link (Enable) message from the SL_IR state machines.

If a state machine consists of multiple states the initial state is as indicated in the state machine description.

● Author: RElliott
Subject: Highlight
Date: 6/30/2008 6:16:52 PM
T ACCEPT - DONE

controls
s/b
control

● Author: RElliott
Subject: Highlight
Date: 6/30/2008 6:16:52 PM
T ACCEPT - DONE

the
s/b
, then the

Figure 184 shows the SL state machines.

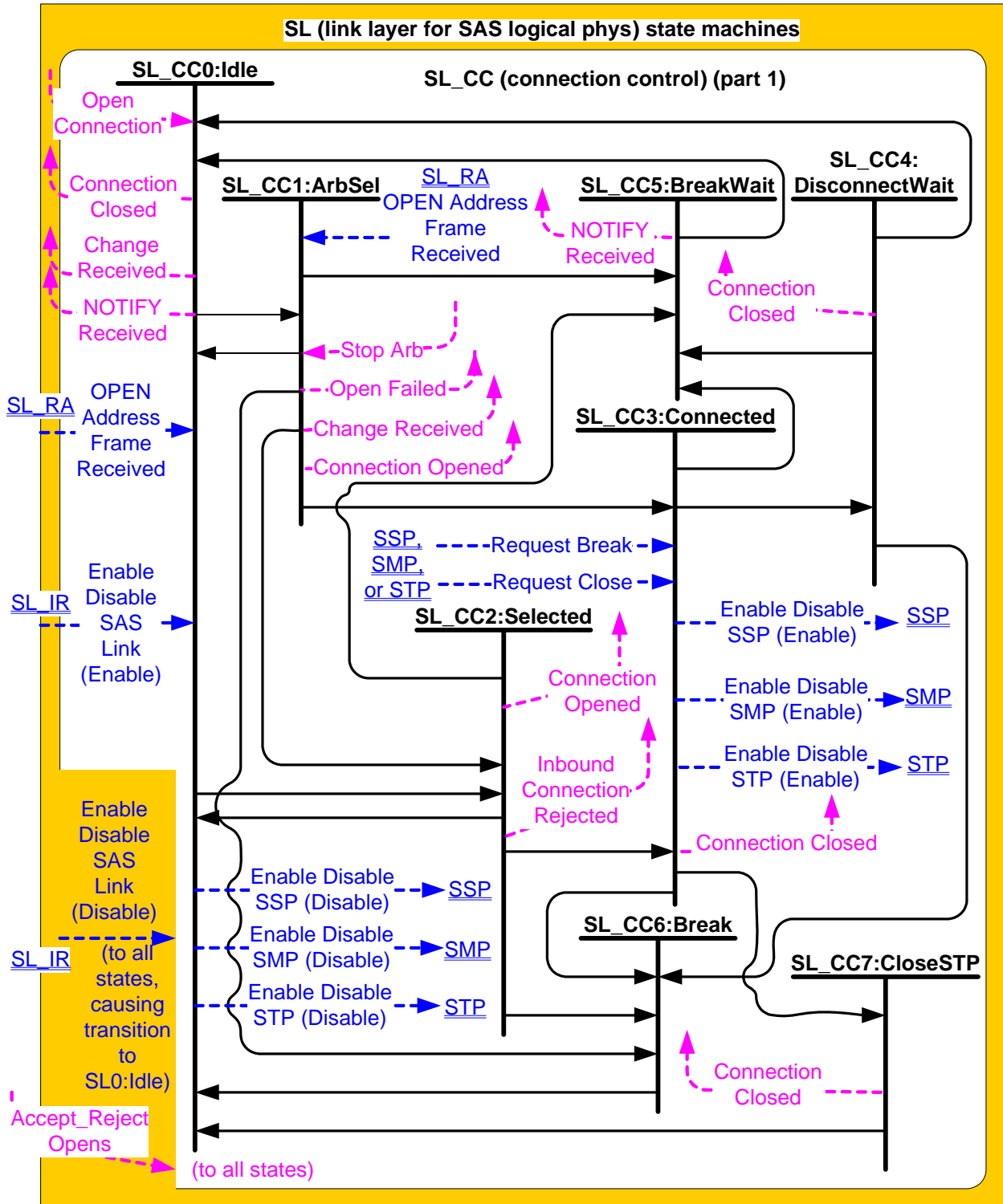

Figure 184 — SL (link layer for SAS logical phys) state machines (part 1)

This page contains no comments

Figure 185 shows the messages sent to the SL transmitter and received from the SL receiver.

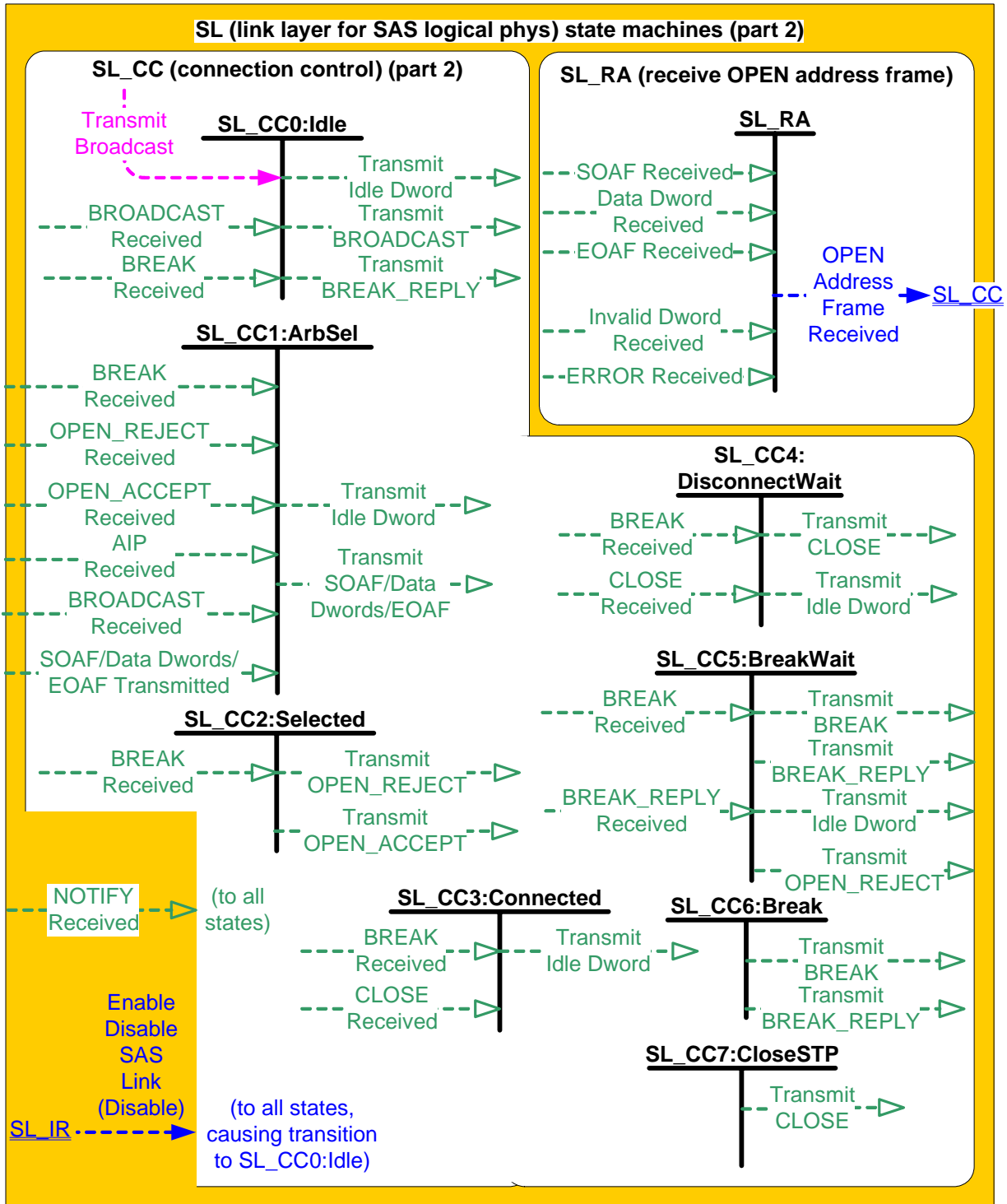

Figure 185 — SL (link layer for SAS logical phys) state machines (part 2)

7.14.2 SL transmitter and receiver

The SL transmitter receives the following messages from the SL state machines specifying primitive sequences, frames, and dwords to transmit:

- a) Transmit Idle Dword;
- b) Transmit SOAF/Data Dwords/EOAF;

This page contains no comments

- c) Transmit OPEN_ACCEPT;
- d) Transmit OPEN_REJECT with an argument indicating the specific type (e.g., Transmit OPEN_REJECT (Retry));
- e) Transmit BREAK;
- f) Transmit BREAK_REPLY;
- g) Transmit BROADCAST; and
- h) Transmit CLOSE with an argument indicating the specific type (e.g., Transmit CLOSE (Normal)).

When the SL transmitter is requested to transmit a dword from any state within any of the SL state machines, it shall transmit that dword. If there are multiple requests to transmit, the following priority should be followed when selecting the dword to transmit:

- 1) BREAK_REPLY;
- 2) BREAK;
- 3) CLOSE;
- 4) OPEN_ACCEPT or OPEN_REJECT;
- 5) SOAF or data dword or EOAF; then
- 6) idle dword.

When there is no outstanding message specifying a dword to transmit, the SL transmitter shall transmit idle dwords.

The SL transmitter sends the following messages to the SL state machines based on dwords that have been transmitted:

- a) SOAF/Data Dwords/EOAF Transmitted.

The SL receiver sends the following messages to the SL state machines indicating primitive sequences and dwords received from the SP_DWS receiver (see 6.9.2):

- a) SOAF Received;
- b) Data Dword Received;
- c) EOAF Received;
- d) BROADCAST Received with an argument indicating the specific type (e.g., BROADCAST Received (Change));
- e) BREAK Received;
- f) BREAK_REPLY Received;
- g) OPEN_ACCEPT Received;
- h) OPEN_REJECT Received with an argument indicating the specific type (e.g., OPEN_REJECT Received (No Destination));
- i) AIP Received;
- j) CLOSE Received with an argument indicating the specific type (e.g., CLOSE Received (Normal));
- k) NOTIFY Received (Power Loss Expected);
- l) ERROR Received; and
- m) Invalid Dword Received.

The SL receiver shall ignore all other dwords.

The SL transmitter relationship to other transmitters is defined in 4.3.2. The SL receiver relationship to other receivers is defined in 4.3.3.

7.14.3 SL_RA (receive OPEN address frame) state machine

The SL_RA state machine's function is to receive address frames and determine if the received address frame is an OPEN address frame and whether or not it was received successfully. This state machine consists of one state.

This state machine receives SOAFs, dwords of an OPEN address frames, and EOAFs.

This state machine shall ignore all messages except SOAF Received, Data Dword Received, and EOAF Received.

Page: 361

● Author: stx-goulder

Subject: Highlight

Date: 5/30/2008 6:11:36 PM

T REJECT (the format is "Transmit ALL CAPS PRIMITIVE NAME (Mixed Case Argument)")

Retry

Should be all CAPs.

● Author: RElliott

Subject: Highlight

Date: 6/30/2008 6:16:52 PM

T ACCEPT - DONE

the

s/b

then the

● Author: wdc-mevans

Subject: Highlight

Date: 5/22/2008 10:10:47 AM

T REJECT (first noun/subject convention)

it

s/b

the SL transmitter

● Author: Isi-gpenokie

Subject: Highlight

Date: 5/30/2008 6:13:56 PM

T ACCEPT - DONE

This << EOAF; then >> should be << EOAF; and >>

● Author: Isi-gpenokie

Subject: Highlight

Date: 5/6/2008 4:07:49 PM

T ACCEPT - DONE

This << following messages to the SL >> should be << following message to the SL >>

● Author: wdc-mevans

Subject: Highlight

Date: 5/30/2008 6:15:51 PM

T ACCEPT - DONE (shortened to "receive address frames and determine if each received address frame is a valid OPEN address frame")

frames and determine if the received address frame is an OPEN address frame and whether or not it was received successfully.

s/b

frames, determine if the received address frame is an OPEN address frame, and determine whether or not the frame was received without error.

If this state machine receives a subsequent SOAF Received message after receiving an SOAF Received message but before receiving an EOAF Received message, then this state machine shall discard the Data Dword Received messages received before the subsequent SOAF Received message.

If this state machine receives more than eight Data Dword Received messages after an SOAF Received message and before an EOAF Received message, then this state machine shall discard the address frame.

If this state machine receives an Invalid Dword Received message or an ERROR Received message after an SOAF Received message and before an EOAF Received message, then this state machine shall:

- a) ignore the invalid dword or ERROR; or
- b) discard the address frame.

After receiving an EOAF Received message, this state machine shall check if the address frame is a valid OPEN address frame.

This state machine shall accept an address frame if:

- a) the ADDRESS FRAME TYPE field is set to 1h (i.e., OPEN);
- b) the number of data dwords between the SOAF and EOAF is 8; and
- c) the CRC field contains a good CRC.

Otherwise, this state machine shall discard the address frame. If the frame is not discarded then this state machine shall send a OPEN Address Frame Received message to the SL_CC0:Idle state and the SL_CC1:ArbSel state with an argument that contains all the data dwords received in the OPEN address frame.

7.14.4 SL_CC (connection control) state machine

7.14.4.1 SL_CC state machine overview

The state machine consists of the following states:

- a) SL_CC0:Idle (see 7.14.4.2)(initial state);
- b) SL_CC1:ArbSel (see 7.14.4.3);
- c) SL_CC2:Selected (see 7.14.4.4);
- d) SL_CC3:Connected (see 7.14.4.5);
- e) SL_CC4:DisconnectWait (see 7.14.4.6);
- f) SL_CC5:BreakWait (see 7.14.4.7);
- g) SL_CC6:Break (see 7.14.4.8); and
- h) SL_CC7:CloseSTP (see 7.14.4.9).

The state machine shall start in the SL_CC0:Idle state. The state machine shall transition to the SL_CC0:Idle state from any other state after receiving an Enable Disable SAS Link (Disable) message from the SL_IR state machines (see 7.9.4).

The SL_CC state machine receives the following messages from the SSP link layer state machine (see 7.16.8), the STP link layer state machine, and SMP link layer state machine (see 7.18.5):

- a) Request Break; and
- b) Request Close.

The SL_CC state machine sends the following messages to the SSP link layer state machine, the STP link layer state machine, and SMP link layer state machine:

- a) Enable Disable SSP (Enable);
- b) Enable Disable SSP (Disable);
- c) Enable Disable STP (Enable);
- d) Enable Disable STP (Disable);
- e) Enable Disable SMP (Enable); and
- f) Enable Disable SMP (Disable).

The SL_CC state machine receives the following messages from the SL_IR state machines (see 7.9.4):

- a) Enable Disable SAS Link (Enable); and

Page: 362

● Author: RElliott

Subject: Note

Date: 9/3/2008 4:50:49 PM

 ACCEPT - DONE (globally, change to these forms:
discard the address frame in progress (for new SOAF)
discard the address frame
discard the frame in progress (for new SOF)
discard the frame

See stx-goulder comment on SSP_RF about discarding SOF too

look for others like this - SMP_IP, SMP_TP

● Author: RElliott

Subject: Underline

Date: 6/30/2008 6:16:52 PM

 ACCEPT - DONE

after:

more than eight Data Dword Received messages

add:

(i.e., 32 bytes)

● Author: Isi-gpenokie

Subject: Highlight

Date: 5/6/2008 4:07:49 PM

 ACCEPT - DONE (added "either" - see earlier comment)

It seems like this << or >> should be << and >> but that would be a different requirement in that the state would do both a and b rather than have to pick either a or b. I'm not sure which was intended.

● Author: RElliott

Subject: Note

Date: 8/30/2008 3:21:31 PM

 ACCEPT - DONE

The state machine receives the following requests from the management application layer:

a) Transmit Broadcast.

prompted by 08-343

● Author: RElliott

Subject: Highlight

Date: 8/30/2008 3:27:29 PM

 ACCEPT - DONE

The SL_CC state machine

s/b

This state machine

● Author: RElliott

Subject: Highlight

Date: 8/30/2008 3:27:34 PM

 ACCEPT - DONE

The SL_CC state machine

s/b

This state machine

Comments from page 362 continued on next page

If this state machine receives a subsequent SOAF Received message after receiving an SOAF Received message but before receiving an EOAF Received message, then this state machine shall discard the Data Dword Received messages received before the subsequent SOAF Received message.

If this state machine receives more than eight Data Dword Received messages after an SOAF Received message and before an EOAF Received message, then this state machine shall discard the address frame.

If this state machine receives an Invalid Dword Received message or an ERROR Received message after an SOAF Received message and before an EOAF Received message, then this state machine shall:

- a) ignore the invalid dword or ERROR; or
- b) discard the address frame.

After receiving an EOAF Received message, this state machine shall check if the address frame is a valid OPEN address frame.

This state machine shall accept an address frame if:

- a) the ADDRESS FRAME TYPE field is set to 1h (i.e., OPEN);
- b) the number of data dwords between the SOAF and EOAF is 8; and
- c) the CRC field contains a good CRC.

Otherwise, this state machine shall discard the address frame. If the frame is not discarded then this state machine shall send a OPEN Address Frame Received message to the SL_CC0:Idle state and the SL_CC1:ArbSel state with an argument that contains all the data dwords received in the OPEN address frame.

7.14.4 SL_CC (connection control) state machine

7.14.4.1 SL_CC state machine overview

The state machine consists of the following states:

- a) SL_CC0:Idle (see 7.14.4.2)(initial state);
- b) SL_CC1:ArbSel (see 7.14.4.3);
- c) SL_CC2:Selected (see 7.14.4.4);
- d) SL_CC3:Connected (see 7.14.4.5);
- e) SL_CC4:DisconnectWait (see 7.14.4.6);
- f) SL_CC5:BreakWait (see 7.14.4.7);
- g) SL_CC6:Break (see 7.14.4.8); and
- h) SL_CC7:CloseSTP (see 7.14.4.9).

The state machine shall start in the SL_CC0:Idle state. The state machine shall transition to the SL_CC0:Idle state from any other state after receiving an Enable/Disable SAS Link (Disable) message from the SL_IR state machines (see 7.9.4).

The SL_CC state machine receives the following messages from the SSP link layer state machine (see 7.16.8), the STP link layer state machine, and SMP link layer state machine (see 7.18.5):

- a) Request Break; and
- b) Request Close.

The SL_CC state machine sends the following messages to the SSP link layer state machine, the STP link layer state machine, and SMP link layer state machine:

- a) Enable/Disable SSP (Enable);
- b) Enable/Disable SSP (Disable);
- c) Enable/Disable STP (Enable);
- d) Enable/Disable STP (Disable);
- e) Enable/Disable SMP (Enable); and
- f) Enable/Disable SMP (Disable).

The SL_CC state machine receives the following messages from the SL_IR state machines (see 7.9.4):

- a) Enable/Disable SAS Link (Enable); and

Author: RElliott
Subject: Highlight
Date: 8/30/2008 3:27:38 PM
ACCEPT - DONE



The SL_CC state machine
s/b
This state machine

- b) Enable Disable SAS Link (Disable).

Any message received by a state that is not referred to in the description of that state or in this subclause shall be ignored.

If this state machine receives an **Accept_Reject Opens** (Accept SSP) request, then this state machine shall set the Reject SSP Opens state machine variable to NO. If this state machine receives an **Accept_Reject Opens** (Reject SSP) request, then this state machine shall set the Reject SSP Opens state machine variable to YES.

If this state machine receives an **Accept_Reject Opens** (Accept SMP) request, then this state machine shall set the Reject SMP Opens state machine variable to NO. If this state machine receives an **Accept_Reject Opens** (Reject SMP) request, then this state machine shall set the Reject SMP Opens state machine variable to YES.

If this state machine receives an **Accept_Reject Opens** (Accept STP) request, then this state machine shall set the Reject STP Opens state machine variable to NO. If this state machine receives an **Accept_Reject Opens** (Reject STP) request, then this state machine shall set the Reject STP Opens state machine variable to YES.

Any detection of an internal error shall cause the SL_CC state machine to transition to the SL_CC5:BreakWait state.

The SL_CC state machine shall maintain the timers listed in table 150.

Table 150 — SL_CC timers

Timer	Initial value
Open Timeout timer	1 ms
Close Timeout timer	1 ms
Break Timeout timer	1 ms

The SL_CC state machine shall maintain the state machine variables listed in table 151.

Table 151 — SL_CC state machine variables

State machine variable	Description
Reject SSP Opens	Used to determine if the SCSI application layer is permitting SSP connection requests to be accepted on this phy .
Reject SMP Opens	Used to determine if the management application layer is permitting SMP connection requests to be accepted on this phy .
Reject STP Opens	Used to determine if the ATA application layer is permitting STP connection requests to be accepted on this phy .

7.14.4.2 SL_CC0:Idle state

7.14.4.2.1 State description

This state is the initial state and is the state that is used when there is no connection pending or established.

Upon entry into this state, this state shall send:

- a) an Enable Disable SSP (Disable) message to the SSP link layer state machines;
- b) an Enable Disable SMP (Disable) message to the SMP link layer state machines;
- c) an Enable Disable STP (Disable) message to the STP link layer state machines; and
- d) a Connection Closed (Transition to Idle) confirmation to the port layer.

● Author: RElliott
Subject: Highlight
Date: 8/30/2008 3:10:26 PM
T ACCEPT - DONE

Accept_Reject Opens
s/b
Accept_Reject OPENS

● Author: RElliott
Subject: Highlight
Date: 8/30/2008 3:10:33 PM
T ACCEPT - DONE

Accept_Reject Opens
s/b
Accept_Reject OPENS

● Author: RElliott
Subject: Highlight
Date: 8/30/2008 3:10:22 PM
T ACCEPT - DONE

Accept_Reject Opens
s/b
Accept_Reject OPENS

● Author: RElliott
Subject: Highlight
Date: 8/30/2008 3:10:17 PM
T ACCEPT - DONE

Accept_Reject Opens
s/b
Accept_Reject OPENS

● Author: RElliott
Subject: Highlight
Date: 8/30/2008 3:10:12 PM
T ACCEPT - DONE

Accept_Reject Opens
s/b
Accept_Reject OPENS

● Author: RElliott
Subject: Highlight
Date: 8/30/2008 3:10:07 PM
T ACCEPT - DONE

Accept_Reject Opens
s/b
Accept_Reject OPENS

b) Enable Disable SAS Link (Disable).

Any message received by a state that is not referred to in the description of that state or in this subclause shall be ignored.

If this state machine receives an **Accept_Reject Opens** (Accept SSP) request, then this state machine shall set the Reject SSP Opens state machine variable to NO. If this state machine receives an **Accept_Reject Opens** (Reject SSP) request, then this state machine shall set the Reject SSP Opens state machine variable to YES.

If this state machine receives an **Accept_Reject Opens** (Accept SMP) request, then this state machine shall set the Reject SMP Opens state machine variable to NO. If this state machine receives an **Accept_Reject Opens** (Reject SMP) request, then this state machine shall set the Reject SMP Opens state machine variable to YES.

If this state machine receives an **Accept_Reject Opens** (Accept STP) request, then this state machine shall set the Reject STP Opens state machine variable to NO. If this state machine receives an **Accept_Reject Opens** (Reject STP) request, then this state machine shall set the Reject STP Opens state machine variable to YES.

Any detection of an internal error shall cause the SL_CC state machine to transition to the SL_CC5:BreakWait state.

The SL_CC state machine shall maintain the timers listed in table 150.

Table 150 — SL_CC timers

Timer	Initial value
Open Timeout timer	1 ms
Close Timeout timer	1 ms
Break Timeout timer	1 ms

The SL_CC state machine shall maintain the state machine variables listed in table 151.

Table 151 — SL_CC state machine variables

State machine variable	Description
Reject SSP Opens	Used to determine if the SCSI application layer is permitting SSP connection requests to be accepted on this phy .
Reject SMP Opens	Used to determine if the management application layer is permitting SMP connection requests to be accepted on this phy .
Reject STP Opens	Used to determine if the ATA application layer is permitting STP connection requests to be accepted on this phy .

7.14.4.2 SL_CC0:Idle state

7.14.4.2.1 State description

This state is the initial state and is the state that is used when there is no connection pending or established.

Upon entry into this state, this state shall send:

- a) an Enable Disable SSP (Disable) message to the SSP link layer state machines;
- b) an Enable Disable SMP (Disable) message to the SMP link layer state machines;
- c) an Enable Disable STP (Disable) message to the STP link layer state machines; and
- d) a Connection Closed (Transition to Idle) confirmation to the port layer.

Author: RElliott
Subject: Highlight
Date: 8/30/2008 3:27:44 PM

T ACCEPT - DONE

The SL_CC state machine
s/b
This state machine

Author: RElliott
Subject: Highlight
Date: 8/30/2008 4:55:08 PM

T ACCEPT - DONE

timers
s/b
state machine timers

Author: RElliott
Subject: Highlight
Date: 8/30/2008 3:27:49 PM

T ACCEPT - DONE

The SL_CC state machine
s/b
This state machine

Author: RElliott
Subject: Highlight
Date: 6/30/2008 6:16:52 PM

T ACCEPT - DONE

phy
s/b
logical phy

Author: RElliott
Subject: Highlight
Date: 6/30/2008 6:16:52 PM

T ACCEPT - DONE

phy
s/b
logical phy

Author: RElliott
Subject: Highlight
Date: 6/30/2008 6:16:52 PM

T ACCEPT - DONE

phy
s/b
logical phy

This state shall request idle dwords be transmitted by repeatedly sending Transmit Idle Dword messages to the SL transmitter (see 7.4).

If a BROADCAST Received (Change) message, BROADCAST Received (Reserved Change 0) message, or BROADCAST Received (Reserved Change 1) message is received, this state shall send a Change Received confirmation to the management layer.

If a Transmit Broadcast request is received with any argument, this state shall send a Transmit BROADCAST message with the same argument to the SL transmitter.

If a BREAK Received message is received and the BREAK_REPLY method of responding to received BREAK primitive sequences is enabled (see 7.12.5), then this state shall send a Transmit BREAK_REPLY message to the SL transmitter.

After this state receives an Enable Disable SAS Link (Enable) confirmation, this state shall:

- a) set the Reject SSP Opens state machine variable to a vendor-specific default value (i.e., YES or NO);
- b) set the Reject SMP Opens state machine variable to a vendor-specific default value (i.e., YES or NO); and
- c) set the Reject STP Opens state machine variable to a vendor-specific default value (i.e., YES or NO).

If this state receives a NOTIFY Received (Power Loss Expected) message and the SAS port that contains this state machine supports NOTIFY (Power Loss Expected) (e.g., the SAS port is a SSP target port), then this state shall send a Notify Received (Power Loss Expected) confirmation to the port layer.

7.14.4.2.2 Transition SL_CC0:Idle to SL_CC1:ArbSel

This transition shall occur after receiving both an Enable Disable SAS Link (Enable) confirmation and an Open Connection request. The Open Connection request includes these arguments:

- a) initiator port bit;
- b) protocol;
- c) connection rate;
- d) initiator connection tag.
- e) destination SAS address;
- f) source SAS address;
- g) pathway blocked count; and
- h) arbitration wait time.

7.14.4.2.3 Transition SL_CC0:Idle to SL_CC2:Selected

This transition shall occur after receiving both an Enable Disable SAS Link (Enable) confirmation and an OPEN Address Frame Received message.

7.14.4.3 SL_CC1:ArbSel state

7.14.4.3.1 State description

This state is used to make a connection request.

Upon entry into this state, this state shall:

- 1) request an OPEN address frame be transmitted by sending a Transmit SOAF/Data Dwords/EOAF message to the SL transmitter with the dwords containing the OPEN address frame with its fields set to the arguments received with the Open Connection request;
- 2) initialize and start the Open Timeout timer; and
- 3) request idle dwords be transmitted by repeatedly sending Transmit Idle Dword messages to the SL transmitter.

This state shall ignore OPEN_REJECT Received and OPEN_ACCEPT Received messages from the time a Transmit SOAF/Data Dwords/EOAF message is sent to the SL transmitter until an SOAF/Data Dwords/EOAF Transmitted message is received from the SL transmitter.

● Author: RElliott
Subject: Highlight
Date: 6/30/2008 6:16:52 PM
T ACCEPT - DONE
this
s/b
then this

● Author: RElliott
Subject: Highlight
Date: 6/30/2008 6:16:52 PM
T ACCEPT - DONE

management layer
s/b
management application layer

● Author: RElliott
Subject: Highlight
Date: 6/30/2008 6:16:52 PM
T ACCEPT - DONE
this
s/b
then this

● Author: wdc-mevans
Subject: Highlight
Date: 5/6/2008 4:07:49 PM
T ACCEPT - DONE
a SSP
s/b
an SSP

● Author: lsi-bday
Subject: Highlight
Date: 8/27/2008 6:00:25 PM
T ACCEPT - DONE (7/14 just add that hand-waving solution. Defer to SAS-2.1 adding any kind of message to the transmitter to turn on Rate Matching)

transmitter.

Suggest adding the following sentence:

See 7.13 for details on rate matching when opening a connection.

If a BROADCAST Received (Change) message, BROADCAST Received (Reserved Change 0) message, or BROADCAST Received (Reserved Change 1) message is received this state shall send a Change Received confirmation to the management layer.

If an AIP Received message is received after requesting the OPEN address frame be transmitted, this state shall reinitialize and restart the Open Timeout timer. The state machine shall not enforce a limit on the number of AIPs received.

If this state receives an OPEN_REJECT Received message listed in table 152 after transmitting the OPEN address frame, this state shall send the corresponding Open Failed confirmation listed in table 152 to the port layer.

Table 152 — OPEN_REJECT Received message to Open Failed confirmation mapping

OPEN_REJECT Received message	Open Failed confirmation
OPEN_REJECT Received (Bad Destination)	Open Failed (Bad Destination)
OPEN_REJECT Received (Connection Rate Not Supported)	Open Failed (Connection Rate Not Supported)
OPEN_REJECT Received (Protocol Not Supported)	Open Failed (Protocol Not Supported)
OPEN_REJECT Received (Reserved Abandon 1)	Open Failed (Reserved Abandon 1)
OPEN_REJECT Received (Reserved Abandon 2)	Open Failed (Reserved Abandon 2)
OPEN_REJECT Received (Reserved Abandon 3)	Open Failed (Reserved Abandon 3)
OPEN_REJECT Received (STP Resources Busy)	Open Failed (STP Resources Busy)
OPEN_REJECT Received (Wrong Destination)	Open Failed (Wrong Destination)
OPEN_REJECT Received (Zone Violation)	Open Failed (Zone Violation)
OPEN_REJECT Received (No Destination)	Open Failed (No Destination)
OPEN_REJECT Received (Pathway Blocked)	Open Failed (Pathway Blocked)
OPEN_REJECT Received (Reserved Continue 0)	Open Failed (Reserved Continue 0)
OPEN_REJECT Received (Reserved Continue 1)	Open Failed (Reserved Continue 1)
OPEN_REJECT Received (Reserved Initialize 0)	Open Failed (Reserved Initialize 0)
OPEN_REJECT Received (Reserved Initialize 1)	Open Failed (Reserved Initialize 1)
OPEN_REJECT Received (Reserved Stop 0)	Open Failed (Reserved Stop 0)
OPEN_REJECT Received (Reserved Stop 1)	Open Failed (Reserved Stop 1)
OPEN_REJECT Received (Retry)	Open Failed (Retry)

7.14.4.3.2 Transition SL_CC1:ArbSel to SL_CC0:Idle

This transition shall occur after sending an Open Failed confirmation.

7.14.4.3.3 Transition SL_CC1:ArbSel to SL_CC2:Selected

This transition shall occur after receiving a SOAF/Data Dwords/EOAF Transmitted message if:

- a) one or more AIP Received messages have been received before an OPEN Address Frame Received message is received (i.e., the incoming OPEN address frame overrides the outgoing OPEN address frame); or
- b) no AIP Received messages have been received before an OPEN Address Frame Received message is received, and the arbitration fairness rules (see 7.12.3) indicate the received OPEN address frame overrides the outgoing OPEN address frame.

● Author: wdc-mevans
Subject: Highlight
Date: 5/25/2008 9:03:39 PM
T ACCEPT - DONE

received this
s/b
received, then this

● Author: RElliott
Subject: Highlight
Date: 6/30/2008 6:16:52 PM
T ACCEPT - DONE

management layer
s/b
management application layer

● Author: RElliott
Subject: Highlight
Date: 6/30/2008 6:16:52 PM
T ACCEPT - DONE

this
s/b
then this

● Author: RElliott
Subject: Highlight
Date: 6/30/2008 6:16:52 PM
T ACCEPT - DONE

this
s/b
then this

The arbitration fairness comparison shall compare:

- a) the value of the arbitration wait time argument in the Open Connection request for the outgoing OPEN address frame; and
- b) the value of the ARBITRATION WAIT TIME field received in the incoming OPEN address frame.

7.14.4.3.4 Transition SL_CC1:ArbSel to SL_CC3:Connected

This transition shall occur if this state receives an SOAF/Data Dwords/EOAF Transmitted message followed by an OPEN_ACCEPT Received message.

If the PROTOCOL field in the transmitted OPEN address frame was set to STP, then this state shall send a Connection Opened (STP, Source Opened) confirmation to the port layer before the transition. This transition shall include an Open STP Connection argument. At this point an STP connection has been opened between the source phy and the destination phy.

If the PROTOCOL field in the transmitted OPEN address frame was set to SSP, then this state shall send a Connection Opened (SSP, Source Opened) confirmation to the port layer before the transition. This transition shall include an Open SSP Connection argument. At this point an SSP connection has been opened between the source phy and the destination phy.

If the PROTOCOL field in the transmitted OPEN address frame was set to SMP, then this state shall send a Connection Opened (SMP, Source Opened) confirmation to the port layer before the transition. This transition shall include an Open SMP Connection argument. At this point an SMP connection has been opened between the source phy and the destination phy.

7.14.4.3.5 Transition SL_CC1:ArbSel to SL_CC5:BreakWait

This transition shall occur after receiving a SOAF/Data Dwords/EOAF Transmitted message if a BREAK Received message has not been received and after:

- a) a Stop Arb request is received and after sending an **Open Failed (Port Layer Request)** confirmation to the port layer;
- b) there is no response to the OPEN address frame before the Open Timeout timer expires and after sending an Open Failed (Open Timeout Occurred) confirmation to the port layer; or
- c) a NOTIFY Received (Power Loss Expected) message is received.

If a NOTIFY Received (Power Loss Expected) message was received and the SAS port that contains this state machine supports NOTIFY (Power Loss Expected) (e.g., the SAS port is **a SSP** target port), then this transition shall include a Power Loss Expected argument.

7.14.4.3.6 **Transition SL_CC1:ArbSel to SL_CC6:Break**

This transition shall occur after:

- a) receiving a SOAF/Data Dwords/EOAF Transmitted message;
- b) receiving a BREAK Received message; and
- c) sending an Open Failed (Break Received) confirmation to the port layer.

7.14.4.4 SL_CC2:Selected state

7.14.4.4.1 State description

This state completes the establishment of an SSP, SMP, or STP connection when an incoming connection request has won arbitration by sending a Transmit OPEN_ACCEPT message, or rejects opening a connection by sending a Transmit OPEN_REJECT message to the SL transmitter.

This state shall respond to an incoming OPEN address frame using the following rules:

- 1) If the OPEN address frame DESTINATION SAS ADDRESS field does not match the SAS address of this port, **this** state shall send a Transmit OPEN_REJECT (Wrong Destination) message to the SL transmitter (see 7.14.4.4.2);

Author: RElliott
Subject: Highlight
Date: 8/30/2008 12:00:03 PM
T ACCEPT - DONE

Open Failed (Port Layer Request)
s/b
Open Failed (Arb Stopped)

per 08-343

Author: wdc-mevans
Subject: Highlight
Date: 5/6/2008 4:07:49 PM
T ACCEPT - DONE

a SSP
s/b
an SSP

Author: lsi-bday
Subject: Highlight
Date: 6/30/2008 9:30:07 AM
T ACCEPT - DONE (5/5 yes)

Transition SL_CC1:ArbSel to SL_CC6:Break

This transition also needs to include a Power Loss Expected argument to the SL_CC6:Break state. Use same wording as the transition to the SL_CC5 state above.

This is to handle case where it receives BREAK, then immediately followed by the NOTIFY, while this state is still sending the OPEN address frame.

Author: RElliott
Subject: Highlight
Date: 6/30/2008 6:16:52 PM
T ACCEPT - DONE

this
s/b
then this

- 2) If the OPEN address frame INITIATOR PORT bit, PROTOCOL field, FEATURES field, and/or INITIATOR CONNECTION TAG field are set to values that are not supported (e.g., a connection request from an SMP target port), **this state shall** send a Transmit OPEN_REJECT (Protocol Not Supported) message to the SL transmitter (see 7.14.4.4.2);
- 3) If the OPEN address frame CONNECTION RATE field is set to a connection rate that is not supported, **this state shall** send a Transmit OPEN_REJECT (Connection Rate Not Supported) message to the SL transmitter (see 7.14.4.4.2);
- 4) If the OPEN address frame PROTOCOL field is set to STP, the STP target port supports affiliations, and the source SAS address is not that of an STP initiator port with an affiliation established ~~on the source SAS address is not that of an STP initiator port with ATA task file register set resources~~ (see 7.17.4), **this state shall** send a Transmit OPEN_REJECT (STP Resources Busy) message to the SL transmitter (see 7.14.4.4.2);
- 5) If the OPEN address frame PROTOCOL field is set to SSP and the Reject SSP Opens state machine variable is set to YES, **this state shall** send a Transmit OPEN_REJECT (Retry) message to the SL transmitter (see 7.14.4.4.2);
- 6) If the OPEN address frame PROTOCOL field is set to SMP and the Reject SMP Opens state machine variable is set to YES, **this state shall** send a Transmit OPEN_REJECT (Retry) message to the SL transmitter (see 7.14.4.4.2);
- 7) If the OPEN address frame PROTOCOL field is set to STP and the Reject STP Opens state machine variable is set to YES, **this state shall** send a Transmit OPEN_REJECT (Retry) message to the SL transmitter (see 7.14.4.4.2);
- 8) If the OPEN address frame PROTOCOL field is set to SSP and the Reject SSP Opens state machine variable is set to NO, **this state shall** send a Transmit OPEN_ACCEPT message to the SL transmitter and send a Connection Opened (SSP, Destination Opened) confirmation to the port layer (see 7.14.4.4.3);
- 9) If the OPEN address frame PROTOCOL field is set to SMP and the Reject SMP Opens state machine variable is set to NO, **this state shall** send a Transmit OPEN_ACCEPT message to the SL transmitter and send a Connection Opened (SMP, Destination Opened) confirmation to the port layer (see 7.14.4.4.3); or
- 10) If the OPEN address frame PROTOCOL field is set to STP and the Reject STP Opens state machine variable is set to NO, **this state shall** send a Transmit OPEN_ACCEPT message to the SL transmitter and send a Connection Opened (STP, Destination Opened) confirmation to the port layer (see 7.14.4.4.3).

If this state sends a Transmit OPEN_REJECT message to the SL **transmitter, it** shall also send an Inbound Connection Rejected confirmation to the port layer.

NOTE 66 - Possible livelock scenarios occur if the BREAK_REPLY method of responding to BREAK primitive sequences is disabled and a SAS logical phy transmits BREAK to abort a connection request (e.g., if its Open Timeout timer expires). SAS logical phys should respond to OPEN Address frames faster than 1 ms to reduce susceptibility to this problem.

7.14.4.4.2 Transition SL_CC2:Selected to SL_CC0:Idle

This transition shall occur **after this state sends** a Transmit OPEN_REJECT message to the SL transmitter.

7.14.4.4.3 Transition SL_CC2:Selected to SL_CC3:Connected

This transition shall occur after sending a Connection Opened **confirmation**.

This transition shall include:

- a) an Open SSP Connection, Open STP Connection, or Open SMP Connection argument based on the requested protocol; and
- b) the received OPEN address frame.

● Author: RElliott
Subject: Highlight
Date: 6/30/2008 6:16:52 PM
T ACCEPT - DONE
this
s/b
then this

● Author: RElliott
Subject: Highlight
Date: 6/30/2008 6:16:52 PM
T ACCEPT - DONE
this
s/b
then this

● Author: RElliott
Subject: Cross-Out
Date: 6/30/2008 6:16:52 PM
T ACCEPT - DONE

delete: "or the source
SAS address is not that of an STP initiator port with ATA task file register set resources"
which seems to already be covered by "STP initiator port with an affiliation context"

● Author: RElliott
Subject: Highlight
Date: 6/30/2008 6:16:52 PM
T ACCEPT - DONE
this
s/b
then this

● Author: RElliott
Subject: Highlight
Date: 6/30/2008 6:16:52 PM
T ACCEPT - DONE
this
s/b
then this

● Author: RElliott
Subject: Highlight
Date: 6/30/2008 6:16:52 PM
T ACCEPT - DONE
this
s/b
then this

● Author: RElliott
Subject: Highlight
Date: 6/30/2008 6:16:52 PM
T ACCEPT - DONE
this
s/b
then this

- 2) If the OPEN address frame INITIATOR PORT bit, PROTOCOL field, FEATURES field, and/or INITIATOR CONNECTION TAG field are set to values that are not supported (e.g., a connection request from an SMP target port), **this** state shall send a Transmit OPEN_REJECT (Protocol Not Supported) message to the SL transmitter (see 7.14.4.4.2);
- 3) If the OPEN address frame CONNECTION RATE field is set to a connection rate that is not supported, **this** state shall send a Transmit OPEN_REJECT (Connection Rate Not Supported) message to the SL transmitter (see 7.14.4.4.2);
- 4) If the OPEN address frame PROTOCOL field is set to STP, the STP target port supports affiliations, and the source SAS address is not that of an STP initiator port with an affiliation established ~~or the source SAS address is not that of an STP initiator port with ATA task file register set resources~~ (see 7.17.4), **this** state shall send a Transmit OPEN_REJECT (STP Resources Busy) message to the SL transmitter (see 7.14.4.4.2);
- 5) If the OPEN address frame PROTOCOL field is set to SSP and the Reject SSP Opens state machine variable is set to YES, **this** state shall send a Transmit OPEN_REJECT (Retry) message to the SL transmitter (see 7.14.4.4.2);
- 6) If the OPEN address frame PROTOCOL field is set to SMP and the Reject SMP Opens state machine variable is set to YES, **this** state shall send a Transmit OPEN_REJECT (Retry) message to the SL transmitter (see 7.14.4.4.2);
- 7) If the OPEN address frame PROTOCOL field is set to STP and the Reject STP Opens state machine variable is set to YES, **this** state shall send a Transmit OPEN_REJECT (Retry) message to the SL transmitter (see 7.14.4.4.2);
- 8) If the OPEN address frame PROTOCOL field is set to SSP and the Reject SSP Opens state machine variable is set to NO, **this** state shall send a Transmit OPEN_ACCEPT message to the SL transmitter and send a Connection Opened (SSP, Destination Opened) confirmation to the port layer (see 7.14.4.4.3);
- 9) If the OPEN address frame PROTOCOL field is set to SMP and the Reject SMP Opens state machine variable is set to NO, **this** state shall send a Transmit OPEN_ACCEPT message to the SL transmitter and send a Connection Opened (SMP, Destination Opened) confirmation to the port layer (see 7.14.4.4.3); or
- 10) If the OPEN address frame PROTOCOL field is set to STP and the Reject STP Opens state machine variable is set to NO, **this** state shall send a Transmit OPEN_ACCEPT message to the SL transmitter and send a Connection Opened (STP, Destination Opened) confirmation to the port layer (see 7.14.4.4.3).

If this state sends a Transmit OPEN_REJECT message to the SL **transmitter, it** shall also send an Inbound Connection Rejected confirmation to the port layer.

NOTE 66 - Possible livelock scenarios occur if the BREAK_REPLY method of responding to BREAK primitive sequences is disabled and a SAS logical phy transmits BREAK to abort a connection request (e.g., if its Open Timeout timer expires). SAS logical phys should respond to OPEN Address frames faster than 1 ms to reduce susceptibility to this problem.

7.14.4.4.2 Transition SL_CC2:Selected to SL_CC0:Idle

This transition shall occur **after this state sends** a Transmit OPEN_REJECT message to the SL transmitter.

7.14.4.4.3 Transition SL_CC2:Selected to SL_CC3:Connected

This transition shall occur after sending a Connection Opened **confirmation.**

This transition shall include:

- a) an Open SSP Connection, Open STP Connection, or Open SMP Connection argument based on the requested protocol; and
- b) the received OPEN address frame.

Author: RElliott
Subject: Highlight
Date: 6/30/2008 6:16:52 PM
T ACCEPT - DONE
this
s/b
then this

Author: RElliott
Subject: Highlight
Date: 6/30/2008 6:16:52 PM
T ACCEPT - DONE
this
s/b
then this

Author: RElliott
Subject: Highlight
Date: 6/30/2008 6:16:52 PM
T ACCEPT - DONE
this
s/b
then this

Author: wdc-mevans
Subject: Highlight
Date: 5/25/2008 9:04:53 PM
T REJECT (first noun/subject convention, but added "then")

transmitter, it
s/b
transmitter, then this state

Author: RElliott
Subject: Highlight
Date: 6/30/2008 6:16:52 PM
T ACCEPT - DONE

after this state sends
s/b
after sending

Author: RElliott
Subject: Highlight
Date: 8/30/2008 12:04:32 PM
T ACCEPT - DONE

confirmation
s/b
confirmation to the port layer

(per 08-343)

7.14.4.4.4 Transition SL_CC2:Selected to SL_CC5:BreakWait

If the SAS port that contains this state machine supports NOTIFY (Power Loss Expected) (e.g., the SAS port is a SSP target port), then this transition shall occur after receiving a NOTIFY Received (Power Loss Expected) message and shall include a Power Loss Expected argument.

7.14.4.4.5 Transition SL_CC2:Selected to SL_CC6:Break

This transition shall occur after a BREAK Received message is received.

7.14.4.5 SL_CC3:Connected state**7.14.4.5.1 State description**

This state enables the SSP, STP, or SMP link layer state machine to transmit dwords during a connection. See 7.13 for details on rate matching during the connection.

If this state is entered from SL_CC1:ArbSel state or the SL_CC2:Selected state with an argument of Open SMP Connection then this state shall send an Enable Disable SMP (Enable) message to the SMP link layer state machines (see 7.18.5).

If this state is entered from SL_CC1:ArbSel state or the SL_CC2:Selected state with an argument of Open SSP Connection then this state shall send an Enable Disable SSP (Enable) message to the SSP link layer state machines (see 7.16.8).

If this state is entered from SL_CC1:ArbSel state or the SL_CC2:Selected state with an argument of Open STP Connection then this state shall send an Enable Disable STP (Enable) message to the STP link layer state machines (see 7.17.8).

This state shall request idle dwords be transmitted by repeatedly sending Transmit Idle Dword messages to the SL transmitter until the SSP, SMP, or STP link layer state machine starts transmitting.

A CLOSE Received message may be received at any time while in this state, but shall be ignored during SSP and SMP connections. If a CLOSE Received (Clear Affiliation) is received during an STP connection this state shall clear any affiliation (see 7.17.4).

7.14.4.5.2 Transition SL_CC3:Connected to SL_CC4:DisconnectWait

This transition shall occur if a Request Close message is received.

7.14.4.5.3 Transition SL_CC3:Connected to SL_CC5:BreakWait

This transition shall occur after sending a Connection Closed (Break Requested) confirmation to the port layer if:

- a) a Request Break message is received and a BREAK Received message has not been received; or
- b) a NOTIFY Received (Power Loss Expected) message is received.

If a NOTIFY Received (Power Loss Expected) message was received and the SAS port that contains this state machine supports NOTIFY (Power Loss Expected) (e.g., the SAS port is a SSP target port), then this state shall include a Power Loss Expected argument.

7.14.4.5.4 Transition SL_CC3:Connected to SL_CC6:Break

This transition shall occur if a BREAK Received message is received and after sending a Connection Closed (Break Received) confirmation to the port layer.

7.14.4.5.5 Transition SL_CC3:Connected to SL_CC7:CloseSTP

This transition shall occur if a CLOSE Received message is received during an STP connection.

Page: 368

● Author: wdc-mevans
Subject: Highlight
Date: 5/6/2008 4:07:49 PM
T ACCEPT - DONE
a SSP
s/b
an SSP

● Author: wdc-mevans
Subject: Highlight
Date: 5/25/2008 9:05:10 PM
T ACCEPT - DONE
Connection then
s/b
Connection, then

● Author: wdc-mevans
Subject: Highlight
Date: 5/25/2008 9:05:13 PM
T ACCEPT - DONE
Connection then
s/b
Connection, then

● Author: wdc-mevans
Subject: Highlight
Date: 5/25/2008 9:05:17 PM
T ACCEPT - DONE
Connection then
s/b
Connection, then

● Author: wdc-mevans
Subject: Highlight
Date: 5/22/2008 5:21:43 PM
T REJECT
state, but
s/b
state but

● Author: RElliott
Subject: Highlight
Date: 6/30/2008 6:16:52 PM
T ACCEPT - DONE
this
s/b
then this

● Author: RElliott
Subject: Highlight
Date: 8/30/2008 12:07:12 PM
T ACCEPT - DONE
After
CLOSE Received (Clear Affiliation)
add "message"

Comments from page 368 continued on next page

7.14.4.4.4 Transition SL_CC2:Selected to SL_CC5:BreakWait

If the SAS port that contains this state machine supports NOTIFY (Power Loss Expected) (e.g., the SAS port is a SSP target port), then this transition shall occur after receiving a NOTIFY Received (Power Loss Expected) message and shall include a Power Loss Expected argument.

7.14.4.4.5 Transition SL_CC2:Selected to SL_CC6:Break

This transition shall occur after a BREAK Received message is received.

7.14.4.5 SL_CC3:Connected state**7.14.4.5.1 State description**

This state enables the SSP, STP, or SMP link layer state machine to transmit dwords during a connection. See 7.13 for details on rate matching during the connection.

If this state is entered from SL_CC1:ArbSel state or the SL_CC2:Selected state with an argument of Open SMP Connection then this state shall send an Enable Disable SMP (Enable) message to the SMP link layer state machines (see 7.18.5).

If this state is entered from SL_CC1:ArbSel state or the SL_CC2:Selected state with an argument of Open SSP Connection then this state shall send an Enable Disable SSP (Enable) message to the SSP link layer state machines (see 7.16.8).

If this state is entered from SL_CC1:ArbSel state or the SL_CC2:Selected state with an argument of Open STP Connection then this state shall send an Enable Disable STP (Enable) message to the STP link layer state machines (see 7.17.8).

This state shall request idle dwords be transmitted by repeatedly sending Transmit Idle Dword messages to the SL transmitter until the SSP, SMP, or STP link layer state machine starts transmitting.

A CLOSE Received message may be received at any time while in this state, but shall be ignored during SSP and SMP connections. If a CLOSE Received (Clear Affiliation) is received during an STP connection, this state shall clear any affiliation (see 7.17.4).

7.14.4.5.2 Transition SL_CC3:Connected to SL_CC4:DisconnectWait

This transition shall occur if a Request Close message is received.

7.14.4.5.3 Transition SL_CC3:Connected to SL_CC5:BreakWait

This transition shall occur after sending a Connection Closed (Break Requested) confirmation to the port layer if:

- a) a Request Break message is received and a BREAK Received message has not been received; or
- b) a NOTIFY Received (Power Loss Expected) message is received.

If a NOTIFY Received (Power Loss Expected) message was received and the SAS port that contains this state machine supports NOTIFY (Power Loss Expected) (e.g., the SAS port is a SSP target port), then this state shall include a Power Loss Expected argument.

7.14.4.5.4 Transition SL_CC3:Connected to SL_CC6:Break

This transition shall occur if a BREAK Received message is received and after sending a Connection Closed (Break Received) confirmation to the port layer.

7.14.4.5.5 Transition SL_CC3:Connected to SL_CC7:CloseSTP

This transition shall occur if a CLOSE Received message is received during an STP connection.

Author: RElliott
Subject: Underline
Date: 6/30/2008 6:16:52 PM

T ACCEPT - DONE (changed to:
state description:

If a Request Break message is received and a BREAK Received message has not been received, then this state shall send a Connection Closed (Break Requested) confirmation to the port layer.

transition:

This transition shall occur:

after sending a Connection Closed (Break Requested) confirmation to the port layer; or
after a NOTIFY Received (Power Loss Expected) message is received, if the SAS port that contains this state machine supports NOTIFY (Power Loss Expected) (e.g., the SAS port is an SSP target port)
)

"after sending a Connection Closed (Break Requested)"

Implicit sending of messages in the transitions is unclear. Move the if/then clause causing the message to be sent into the state description, then based the transition solely upon sending the message (not the cause for the message).

Author: RElliott
Subject: Note
Date: 7/14/2008 5:23:44 PM

 REJECT (7/9 Request Break only originates at SSP and SMP link layers; it's not a request from the higher layer. So, Connection Closed (Break Requested) isn't really responding to a particular request; it's unsolicited and is thus OK to be used for this purpose.)

It is not really sensible to send a Connection Closed (Break Requested) confirmation because of an incoming NOTIFY (Power Loss Expected). That was not requested by this phy, and it is possible the upper layer would miss that (e.g. if it were only looking for it after sending Request Break). The upper layer does need to be notified to stop sending new frames down,

Either a new message should be added:

Connection Closed (Power Loss Expected Received)

or

the existing Notify Received (Power Loss Expected) confirmation (sent by SL_CC0) should be used in the other states.

Author: wdc-mevans
Subject: Highlight
Date: 5/6/2008 4:07:49 PM

T ACCEPT - DONE
a SSP
s/b
an SSP

Author: RElliott
Subject: Underline
Date: 6/30/2008 6:16:52 PM

T ACCEPT - DONE (changed to:
state description:

If a BREAK Received message is received, then this state shall send send a Connection Closed (Break Received) confirmation to the port layer.

transition section:

This transition shall occur after sending a Connection Closed (Break Received) confirmation to the port layer.

"

after sending a Connection Closed
(Break Received) confirmation

7.14.4.4.4 Transition SL_CC2:Selected to SL_CC5:BreakWait

If the SAS port that contains this state machine supports NOTIFY (Power Loss Expected) (e.g., the SAS port is a SSP target port), then this transition shall occur after receiving a NOTIFY Received (Power Loss Expected) message and shall include a Power Loss Expected argument.

7.14.4.4.5 Transition SL_CC2:Selected to SL_CC6:Break

This transition shall occur after a BREAK Received message is received.

7.14.4.5 SL_CC3:Connected state**7.14.4.5.1 State description**

This state enables the SSP, STP, or SMP link layer state machine to transmit dwords during a connection. See 7.13 for details on rate matching during the connection.

If this state is entered from SL_CC1:ArbSel state or the SL_CC2:Selected state with an argument of Open SMP Connection then this state shall send an Enable Disable SMP (Enable) message to the SMP link layer state machines (see 7.18.5).

If this state is entered from SL_CC1:ArbSel state or the SL_CC2:Selected state with an argument of Open SSP Connection then this state shall send an Enable Disable SSP (Enable) message to the SSP link layer state machines (see 7.16.8).

If this state is entered from SL_CC1:ArbSel state or the SL_CC2:Selected state with an argument of Open STP Connection then this state shall send an Enable Disable STP (Enable) message to the STP link layer state machines (see 7.17.8).

This state shall request idle dwords be transmitted by repeatedly sending Transmit Idle Dword messages to the SL transmitter until the SSP, SMP, or STP link layer state machine starts transmitting.

A CLOSE Received message may be received at any time while in this state, but shall be ignored during SSP and SMP connections. If a CLOSE Received (Clear Affiliation) is received during an STP connection, this state shall clear any affiliation (see 7.17.4).

7.14.4.5.2 Transition SL_CC3:Connected to SL_CC4:DisconnectWait

This transition shall occur if a Request Close message is received.

7.14.4.5.3 Transition SL_CC3:Connected to SL_CC5:BreakWait

This transition shall occur after sending a Connection Closed (Break Requested) confirmation to the port layer if:

- a) a Request Break message is received and a BREAK Received message has not been received; or
- b) a NOTIFY Received (Power Loss Expected) message is received.

If a NOTIFY Received (Power Loss Expected) message was received and the SAS port that contains this state machine supports NOTIFY (Power Loss Expected) (e.g., the SAS port is a SSP target port), then this state shall include a Power Loss Expected argument.

7.14.4.5.4 Transition SL_CC3:Connected to SL_CC6:Break

This transition shall occur if a BREAK Received message is received and after sending a Connection Closed (Break Received) confirmation to the port layer.

7.14.4.5.5 Transition SL_CC3:Connected to SL_CC7:CloseSTP

This transition shall occur if a CLOSE Received message is received during an STP connection.

Implicit sending of messages in the transitions is unclear. Move the if/then clause causing the message to be sent into the state description, then based the transition solely upon sending the message (not the cause for the message).

7.14.4.6 SL_CC4:DisconnectWait state

7.14.4.6.1 State description

This state closes the connection and releases all resources associated with the connection.

Upon entry into this state, this state shall:

- 1) send a Transmit CLOSE (Normal) message or Transmit CLOSE (Clear Affiliation) message to the SL transmitter (see 7.17.6); and
- 2) initialize and start the Close Timeout timer.

A CLOSE Received message may be received at any time while in this state. If a **CLOSE Received (Clear Affiliation)** is received during an STP connection, **this state shall clear any affiliation** (see 7.17.4).

NOTE 67 - Possible livelock scenarios occur if the BREAK_REPLY method of responding to received BREAK primitive sequences is disabled and a SAS logical phy transmits BREAK to break a connection (e.g., if its Close Timeout timer expires). SAS logical phys should respond to CLOSE faster than 1 ms to reduce susceptibility to this problem.

7.14.4.6.2 Transition SL_CC4:DisconnectWait to SL_CC0:Idle

This transition shall occur after:

- a) sending a Transmit CLOSE message to the SL transmitter;
- b) receiving a CLOSE Received message; and
- c) sending a Connection Closed (Normal) confirmation to the port layer.

7.14.4.6.3 Transition SL_CC4:DisconnectWait to SL_CC5:BreakWait

This transition shall occur if a NOTIFY Received (Power Loss Expected) message is received or if:

- a) a BREAK Received message has not been received;
- b) no CLOSE Received message is received in response to a Transmit CLOSE message before the Close Timeout timer expires; and
- c) after sending a Connection Closed (Close Timeout) confirmation to the port layer.

If a NOTIFY Received (Power Loss Expected) message was received and the SAS port that contains this state machine supports NOTIFY (Power Loss Expected) (e.g., the SAS port is **a SSP** target port), then this state shall include a Power Loss Expected argument.

7.14.4.6.4 Transition SL_CC4:DisconnectWait to SL_CC6:Break

This transition shall occur after receiving a BREAK Received message and after sending a Connection Closed (Break Received) confirmation to the port layer.

7.14.4.7 SL_CC5:BreakWait state

7.14.4.7.1 State description

This state closes the connection if one is established and releases all resources associated with the connection.

Upon entry into this state, this state shall:

- 1) send a Transmit BREAK message to the SL transmitter; and
- 2) initialize and start the Break Timeout timer.

 If this state is entered with a Power Loss Expected message or this state receives a NOTIFY Received (Power Loss Expected) message and the SAS port that contains this state machine supports NOTIFY (Power Loss Expected) (e.g., the SAS port is a SSP target port), then this state shall send a Notify Received (Power Loss Expected) confirmation to the port layer.

Author: RElliott
Subject: Highlight
Date: 8/30/2008 12:08:13 PM
T ACCEPT - DONE

After
CLOSE Received (Clear Affiliation)

add
"message"

Author: RElliott
Subject: Highlight
Date: 6/30/2008 6:16:52 PM
T ACCEPT - DONE

this
s/b
then this

Author: RElliott
Subject: Underline
Date: 8/27/2008 6:40:00 PM
T ACCEPT - DONE (7/14 incorp 08-293r0 by George Penokie, which reviewed 15 "sending"s)

sending a Connection Closed (Normal) confirmation

Implicit sending of messages in the transitions is unclear. Move the if/then clause causing the message to be sent into the state description, then based the transition solely upon sending the message (not the cause for the message).

Author: wdc-mevans
Subject: Highlight
Date: 5/6/2008 4:07:49 PM
T ACCEPT - DONE

a SSP
s/b
an SSP

Author: RElliott
Subject: Underline
Date: 6/30/2008 6:16:52 PM
T ACCEPT - DONE

If this state is entered with a Power Loss Expected message or this state receives a NOTIFY Received (Power Loss Expected) message and the SAS port that contains this state machine supports NOTIFY (Power Loss Expected) (e.g., the SAS port is a SSP target port),

s/b

If this state:

a) is entered with a Power Loss Expected message; or

b) receives a NOTIFY Received (Power Loss Expected) message and the SAS port that contains this state machine supports NOTIFY (Power Loss Expected) (e.g., the SAS port is an SSP target port),

Author: wdc-mevans
Subject: Highlight
Date: 5/30/2008 6:17:48 PM
T REJECT (converted to a)b) list)

message or

7.14.4.6 SL_CC4:DisconnectWait state

7.14.4.6.1 State description

This state closes the connection and releases all resources associated with the connection.

Upon entry into this state, this state shall:

- 1) send a Transmit CLOSE (Normal) message or Transmit CLOSE (Clear Affiliation) message to the SL transmitter (see 7.17.6); and
- 2) initialize and start the Close Timeout timer.

A CLOSE Received message may be received at any time while in this state. If a **CLOSE Received (Clear Affiliation)** is received during an STP connection, **this** state shall clear any affiliation (see 7.17.4).

NOTE 67 - Possible livelock scenarios occur if the BREAK_REPLY method of responding to received BREAK primitive sequences is disabled and a SAS logical phy transmits BREAK to break a connection (e.g., if its Close Timeout timer expires). SAS logical phys should respond to CLOSE faster than 1 ms to reduce susceptibility to this problem.

7.14.4.6.2 Transition SL_CC4:DisconnectWait to SL_CC0:Idle

This transition shall occur after:

- a) sending a Transmit CLOSE message to the SL transmitter;
- b) receiving a CLOSE Received message; and
- c) sending a Connection Closed (Normal) confirmation to the port layer.

7.14.4.6.3 Transition SL_CC4:DisconnectWait to SL_CC5:BreakWait

This transition shall occur if a NOTIFY Received (Power Loss Expected) message is received or if:

- a) a BREAK Received message has not been received;
- b) no CLOSE Received message is received in response to a Transmit CLOSE message before the Close Timeout timer expires; and
- c) after sending a Connection Closed (Close Timeout) confirmation to the port layer.

If a NOTIFY Received (Power Loss Expected) message was received and the SAS port that contains this state machine supports NOTIFY (Power Loss Expected) (e.g., the SAS port is **a SSP** target port), then this state shall include a Power Loss Expected argument.

7.14.4.6.4 Transition SL_CC4:DisconnectWait to SL_CC6:Break

This transition shall occur after receiving a BREAK Received message and after sending a Connection Closed (Break Received) confirmation to the port layer.

7.14.4.7 SL_CC5:BreakWait state

7.14.4.7.1 State description

This state closes the connection if one is established and releases all resources associated with the connection.

Upon entry into this state, this state shall:

- 1) send a Transmit BREAK message to the SL transmitter; and
- 2) initialize and start the Break Timeout timer.

 If this state is entered with a Power Loss Expected message or this state receives a NOTIFY Received (Power Loss Expected) message and the SAS port that contains this state machine supports NOTIFY (Power Loss Expected) (e.g., the SAS port is a SSP target port), then this state shall send a Notify Received (Power Loss Expected) confirmation to the port layer.

s/b
message, or

● Author: RElliott
Subject: Note
Date: 6/30/2008 6:16:52 PM
 ACCEPT - DONE
Power Loss Expected message
s/b
Power Loss Expected argument

● Author: wdc-mevans
Subject: Highlight
Date: 5/30/2008 6:17:58 PM
 REJECT (converted to a)b) list)
message and
s/b
message, and

● Author: wdc-mevans
Subject: Highlight
Date: 5/6/2008 4:07:49 PM
 ACCEPT - DONE
a SSP
s/b
an SSP

If a BREAK Received message is **received and** the ~~BREAK_REPLY~~ method of responding to received BREAK primitive sequences is enabled (see 7.12.5), then this state shall send a Transmit ~~BREAK_REPLY~~ message to the SL transmitter.

NOTE 68 - Some SAS logical phys compliant with previous versions of this standard send a Transmit OPEN_REJECT (Retry) message to the SL transmitter in response to each OPEN Address Frame Received message received while in this state.

7.14.4.7.2 Transition SL_CC5:BreakWait to SL_CC0:Idle

This transition shall occur after:

- a) receiving a ~~BREAK_REPLY~~ Received message if the ~~BREAK_REPLY~~ method of responding to received BREAK primitive sequences is enabled (see 7.12.5);
- b) receiving a BREAK Received message if the ~~BREAK_REPLY~~ method of responding to received BREAK primitive sequences is disabled (see 7.12.5); or
- c) the Break Timeout timer expires.

7.14.4.8 SL_CC6:Break state

7.14.4.8.1 State description

This state closes any connection and releases all resources associated with this connection.

Upon entry into this state:

- a) if the ~~BREAK_REPLY~~ method of responding to received BREAK primitive sequences is enabled (see 7.12.5), **this** state shall send a Transmit ~~BREAK_REPLY~~ message to the SL transmitter (see 7.14.4.8.2); and
- b) if the ~~BREAK_REPLY~~ method of responding to received BREAK primitive sequences is disabled (see 7.12.5), **this** state shall send a Transmit BREAK message to the SL transmitter.

If this state receives a NOTIFY Received (Power Loss Expected) message and the SAS port that contains this state machine supports NOTIFY (Power Loss Expected) (e.g., the SAS port is a SSP target port), then this state shall send a Notify Received (Power Loss Expected) confirmation to the port layer.

7.14.4.8.2 Transition SL_CC6:Break to SL_CC0:Idle

This transition shall occur after sending a Transmit BREAK message or a Transmit ~~BREAK_REPLY~~ message to the SL transmitter.

7.14.4.9 SL_CC7:CloseSTP state

7.14.4.9.1 State description

This state closes an STP connection and releases all resources associated with the connection.

Upon entry into this state, this state shall:

- 1) send a Transmit CLOSE (Normal) message or Transmit CLOSE (Clear Affiliation) message to the SL transmitter (see 7.17.6); and
- 2) send a Connection Closed (Normal) confirmation to the port layer (see 7.14.4.9.2).

NOTE 69 - Possible livelock scenarios occur if the ~~BREAK_REPLY~~ method of responding to received BREAK primitive sequences is disabled and a SAS logical phy transmits BREAK to break a connection (e.g., if its Close Timeout timer expires). SAS logical phys should respond to CLOSE faster than 1 ms to reduce susceptibility to this problem.

7.14.4.9.2 Transition SL_CC7:CloseSTP to SL_CC0:Idle

This transition shall occur after sending a Connection Closed (Normal) confirmation to the port layer.

Page: 370

● Author: wdc-mevans
Subject: Highlight
Date: 5/25/2008 9:05:53 PM
T REJECT (2 things ANDED)

received and
s/b
received, and

● Author: RElliott
Subject: Note
Date: 6/30/2008 6:16:52 PM
 ACCEPT - DONE

fix font in a)b)c)

● Author: RElliott
Subject: Highlight
Date: 6/30/2008 6:16:52 PM
T ACCEPT - DONE

this
s/b
then this

● Author: RElliott
Subject: Highlight
Date: 6/30/2008 6:16:52 PM
T ACCEPT - DONE

this
s/b
then this

● Author: wdc-mevans
Subject: Highlight
Date: 5/25/2008 9:06:11 PM
T REJECT (2 things ANDED)

message and
s/b
message, and

● Author: lsi-bday
Subject: Highlight
Date: 6/30/2008 9:31:20 AM
T ACCEPT - DONE (added:

If this state:
is entered with a Power Loss Expected argument; or
receives a NOTIFY Received (Power Loss Expected) message and the SAS port that contains this state machine supports NOTIFY
(Power Loss Expected) (e.g., the SAS port is an SSP target port),
then this state shall send a Notify Received (Power Loss Expected) confirmation to the port layer.
)

If this state receives a NOTIFY Received (Power Loss Expected) message

Dependent on earlier comment. Change beginning of sentence to:

If this state is entered with a Power Loss Expected argument, or if this state receives...

Comments from page 370 continued on next page

If a BREAK Received message is **received and** the BREAK_REPLY method of responding to received BREAK primitive sequences is enabled (see 7.12.5), then this state shall send a Transmit BREAK_REPLY message to the SL transmitter.

NOTE 68 - Some SAS logical phys compliant with previous versions of this standard send a Transmit OPEN_REJECT (Retry) message to the SL transmitter in response to each OPEN Address Frame Received message received while in this state.

7.14.4.7.2 Transition SL_CC5:BreakWait to SL_CC0:Idle

This transition shall occur after:

- a) receiving a BREAK_REPLY Received message if the BREAK_REPLY method of responding to received BREAK primitive sequences is enabled (see 7.12.5);
- b) receiving a BREAK Received message if the BREAK_REPLY method of responding to received BREAK primitive sequences is disabled (see 7.12.5); or
- c) the Break Timeout timer expires.

7.14.4.8 SL_CC6:Break state

7.14.4.8.1 State description

This state closes any connection and releases all resources associated with this connection.

Upon entry into this state:

- a) if the BREAK_REPLY method of responding to received BREAK primitive sequences is enabled (see 7.12.5), **this** state shall send a Transmit BREAK_REPLY message to the SL transmitter (see 7.14.4.8.2); and
- b) if the BREAK_REPLY method of responding to received BREAK primitive sequences is disabled (see 7.12.5), **this** state shall send a Transmit BREAK message to the SL transmitter.

If this state receives a NOTIFY Received (Power Loss Expected) message and the SAS port that contains this state machine supports NOTIFY (Power Loss Expected) (e.g., the SAS port is **a SSP** target port), then this state shall send a Notify Received (Power Loss Expected) confirmation to the port layer.

7.14.4.8.2 Transition SL_CC6:Break to SL_CC0:Idle

This transition shall occur after sending a Transmit BREAK message or a Transmit BREAK_REPLY message to the SL transmitter.

7.14.4.9 SL_CC7:CloseSTP state

7.14.4.9.1 State description

This state closes an STP connection and releases all resources associated with the connection.

Upon entry into this state, this state shall:

- 1) send a Transmit CLOSE (Normal) message or Transmit CLOSE (Clear Affiliation) message to the SL transmitter (see 7.17.6); and
- 2) send a Connection Closed (Normal) confirmation to the port layer (see 7.14.4.9.2).

NOTE 69 - Possible livelock scenarios occur if the BREAK_REPLY method of responding to received BREAK primitive sequences is disabled and a SAS logical phy transmits BREAK to break a connection (e.g., if its Close Timeout timer expires). SAS logical phys should respond to CLOSE faster than 1 ms to reduce susceptibility to this problem.

7.14.4.9.2 Transition SL_CC7:CloseSTP to SL_CC0:Idle

This transition shall occur after sending a Connection Closed (Normal) confirmation to the port layer.

Author: wdc-mevans
Subject: Highlight
Date: 5/6/2008 4:07:49 PM
ACCEPT - DONE
a SSP
s/b
an SSP

7.15 XL (link layer for expander logical phys) state machine

7.15.1 XL state machine overview

The XL state machine controls the flow of dwords on the logical link and establishes and maintains connections with another XL state machine as facilitated by the expander function (e.g., the ECM and ECR).

This state machine consists of the following states:

- a) XL0:Idle (see 7.15.3)(initial state);
- b) XL1:Request_Path (see 7.15.4);
- c) XL2:Request_Open (see 7.15.5);
- d) XL3:Open_Confirm_Wait (see 7.15.6);
- e) XL4:Open_Reject (see 7.15.7);
- f) XL5:Forward_Open (see 7.15.8);
- g) XL6:Open_Response_Wait (see 7.15.9);
- h) XL7:Connected (see 7.15.10);
- i) XL8:Close_Wait (see 7.15.11);
- j) XL9:Break (see 7.15.12); and
- k) XL10:Break_Wait (see 7.15.13).

The XL state machine shall start in the XL0:Idle state. The XL state machine shall transition to the XL0:Idle state from any other state after receiving an Enable Disable SAS Link (Disable) message from the SL_IR state machines (see 7.9.4).

The XL state machine receives the following messages from the SL_IR state machines:

- a) Enable Disable SAS Link (Enable); and
- b) Enable Disable SAS Link (Disable).

Any message received by a state that is not referred to in the description of that state shall be ignored.

The XL state machine shall maintain the timers listed in table 153.

Table 153 — XL timers

Timer	Initial value
Partial Pathway Timeout timer	Partial pathway timeout value (see 7.12.4.4)
Break Timeout timer	1 ms

● Author: RElliott
Subject: Highlight
Date: 8/30/2008 3:28:12 PM
T ACCEPT - DONE

The XL state machine
s/b
This state machine

● Author: RElliott
Subject: Highlight
Date: 8/30/2008 3:28:16 PM
T ACCEPT - DONE

The XL state machine
s/b
This state machine

● Author: RElliott
Subject: Highlight
Date: 8/30/2008 3:28:20 PM
T ACCEPT - DONE

The XL state machine
s/b
This state machine

● Author: RElliott
Subject: Highlight
Date: 8/30/2008 4:55:16 PM
T ACCEPT - DONE

timers
s/b
state machine timers

Figure 186 shows several states in the XL state machine.

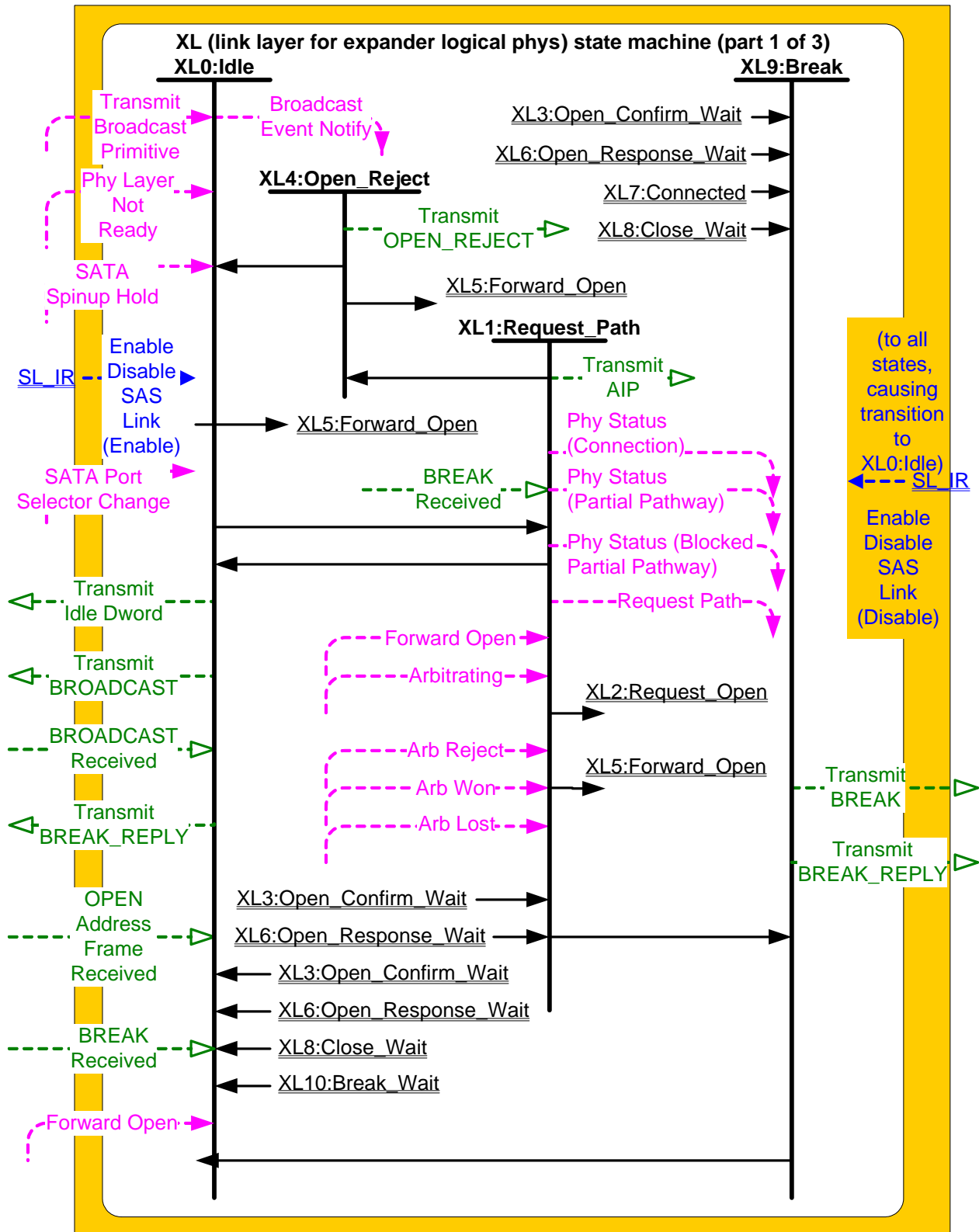

Figure 186 — XL (link layer for expander logical phys) state machine (part 1)

This page contains no comments

Figure 187 shows additional states in the XL state machine.

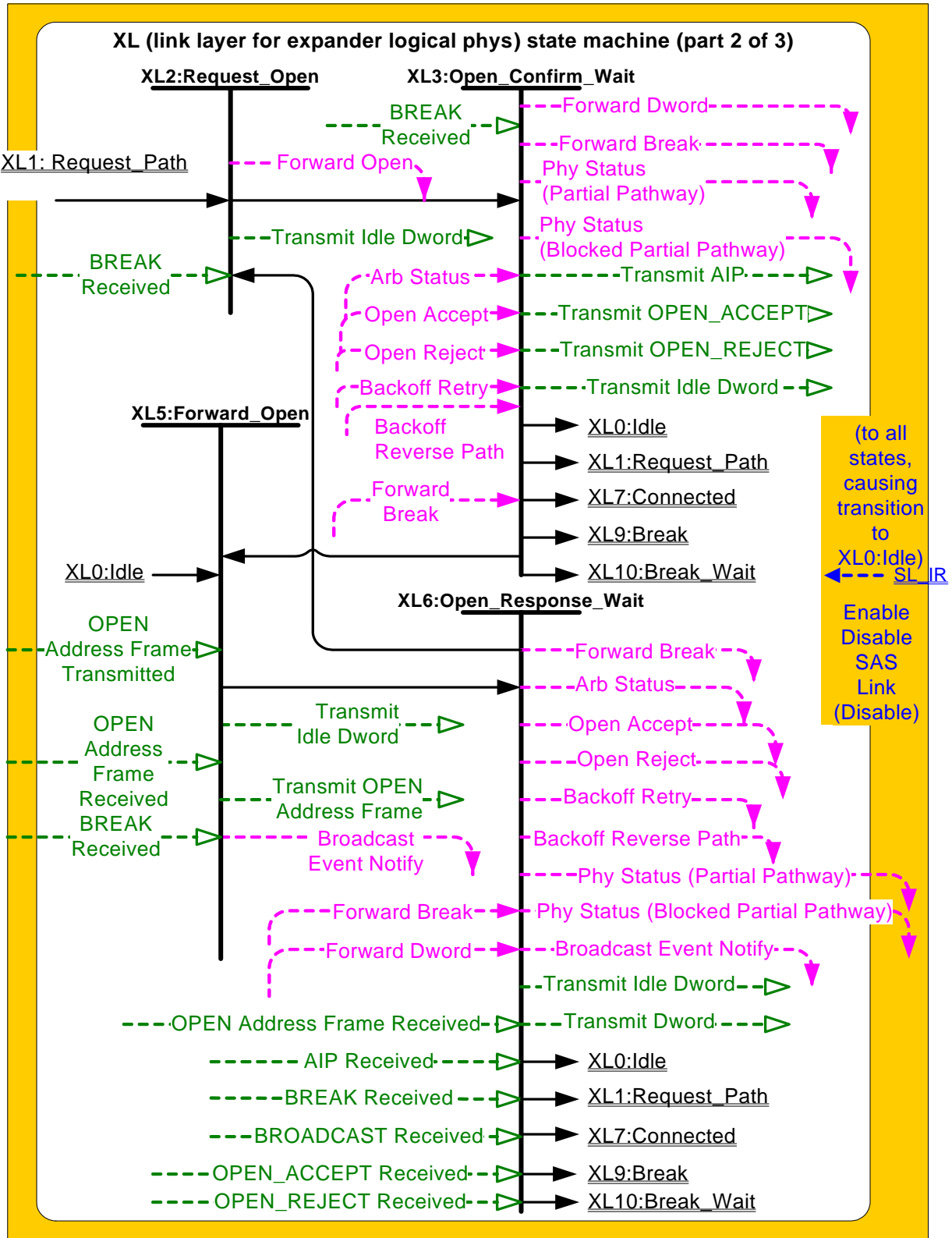

Figure 187 — XL (link layer for expander logical phys) state machine (part 2)

This page contains no comments

Figure 188 shows additional states in the XL state machine.

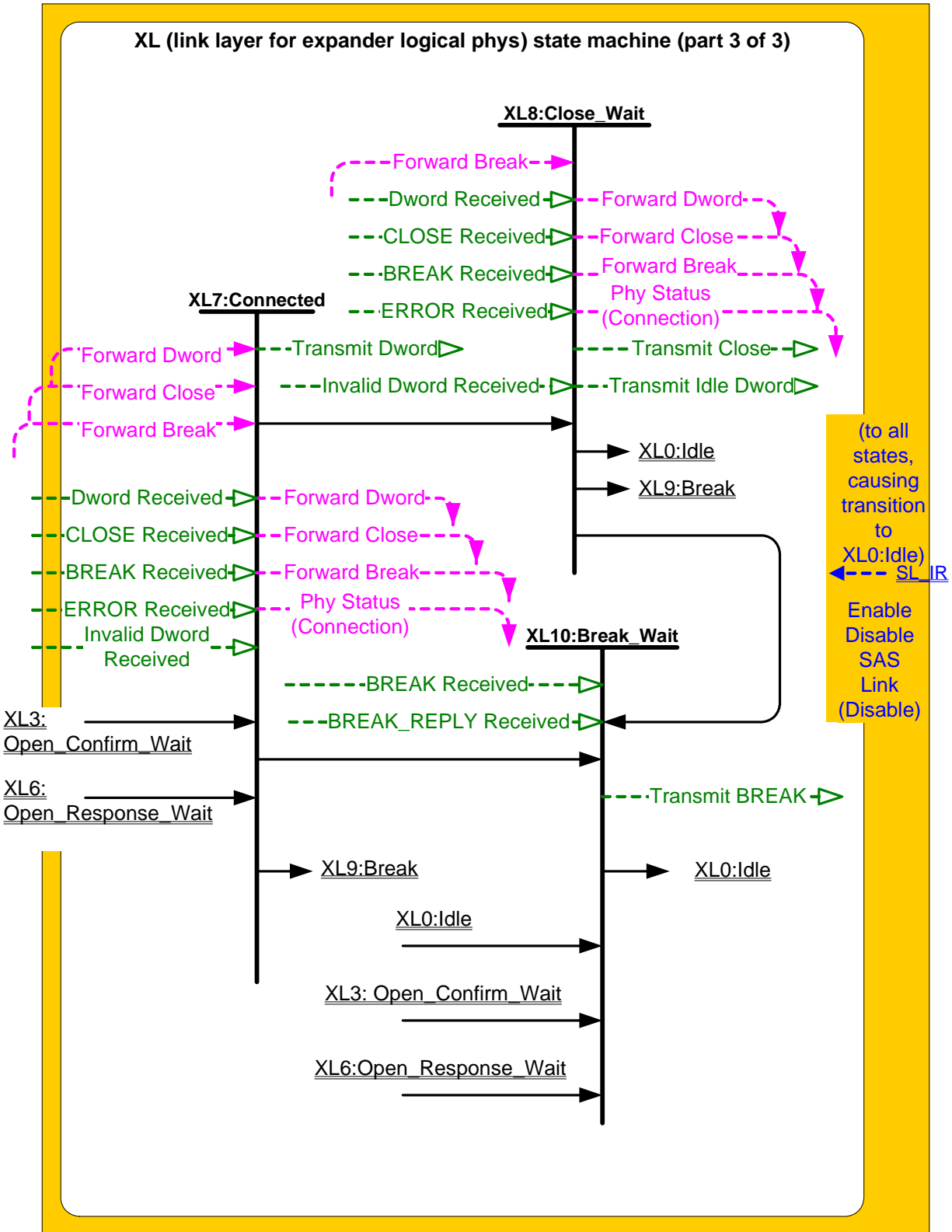

Figure 188 — XL (link layer for expander logical phys) state machine (part 3)

This page contains no comments

7.15.2 XL transmitter and receiver

The XL transmitter receives the following messages from the XL state machine specifying primitive sequences, frames, and dwords to transmit:

- a) Transmit Idle Dword;
- b) Transmit AIP with an argument indicating the specific type (e.g., Transmit AIP (Normal));
- c) Transmit BREAK;
- d) Transmit BREAK_REPLY;
- e) Transmit BROADCAST with an argument indicating the specific type (e.g., Transmit BROADCAST (Change));
- f) Transmit CLOSE with an argument indicating the specific type (e.g., Transmit CLOSE (Normal));
- g) Transmit OPEN_ACCEPT;
- h) Transmit OPEN_REJECT, with an argument indicating the specific type (e.g., Transmit OPEN_REJECT (No Destination));
- i) Transmit OPEN Address Frame; and
- j) Transmit Dword.

The XL transmitter sends the following messages to the XL state machine based on dwords that have been transmitted:

- a) OPEN Address Frame Transmitted.

The XL transmitter shall ensure physical link rate tolerance management requirements are met (see 7.3) while originating dwords.

The XL transmitter shall ensure physical link rate tolerance management requirements are met while forwarding dwords (i.e., during a connection) by inserting or deleting as many deletable primitives as required to match the transmit and receive connection rates (see 7.3.2).

The XL transmitter shall ensure physical link rate tolerance management requirements are met (see 7.3) during and after switching from forwarding dwords to originating dwords, including, for example:

- a) when transmitting BREAK;
- b) when transmitting BREAK_REPLY;
- c) when transmitting CLOSE;
- d) when transmitting an idle dword after closing a connection (i.e., after receiving BREAK, BREAK_REPLY, or CLOSE);
- e) while transmitting a SATA frame to a SAS logical link during an STP connection, when transmitting the first SATA_HOLD in response to detection of SATA_HOLD; and
- f) while receiving dwords of a SATA frame from a SAS logical link during an STP connection, when transmitting SATA_HOLD.

NOTE 70 - The XL transmitter may always insert a deletable primitive before transmitting a BREAK, BREAK_REPLY, CLOSE, or SATA_HOLD to meet physical link rate tolerance management requirements.

The XL transmitter shall insert a deletable primitive before switching from originating dwords to forwarding dwords, including, for example:

- a) when transmitting OPEN_ACCEPT;
- b) when transmitting the last idle dword before a connection is established (i.e., after receiving OPEN_ACCEPT);
- c) while transmitting a SATA frame to a SAS logical link during an STP connection, when transmitting the last dword from the STP flow control buffer in response to release of SATA_HOLD;
- d) while transmitting a SATA frame to a SAS logical link during an STP connection, when transmitting the last SATA_HOLD in response to release of SATA_HOLD (e.g., if the STP flow control buffer is empty); and
- e) while receiving dwords of a SATA frame from a SAS logical link during an STP connection, when transmitting the last SATA_HOLD.

NOTE 71 - This ensures that physical link rate tolerance management requirements are met, even if the forwarded dword stream does not include a deletable primitive until the last possible dword.

● Author: stx-goulder

Subject: Highlight

Date: 5/30/2008 6:22:55 PM

T REJECT (that convention is not used in any of the other "transmitter and receiver" sections)

Dword

add the word "message" after this phrase.

● Author: stx-goulder

Subject: Highlight

Date: 5/30/2008 6:23:03 PM

T REJECT (that convention is not used in any of the other "transmitter and receiver" sections)

Normal)

add the word "message" after this phrase.

● Author: stx-goulder

Subject: Highlight

Date: 5/30/2008 6:23:18 PM

T REJECT (that convention is not used in any of the other "transmitter and receiver" sections)

BREAK

add the word "message" after this phrase.

● Author: stx-goulder

Subject: Highlight

Date: 5/30/2008 6:23:09 PM

T REJECT (that convention is not used in any of the other "transmitter and receiver" sections)

BREAK_REPLY

add the word "message" after this phrase.

● Author: stx-goulder

Subject: Highlight

Date: 5/30/2008 6:23:54 PM

T REJECT (that convention is not used in any of the other "transmitter and receiver" sections)

(Change)

Add "message" after this phrase.

● Author: stx-goulder

Subject: Highlight

Date: 5/30/2008 6:23:24 PM

T REJECT (that convention is not used in any of the other "transmitter and receiver" sections)

(Normal)

Add "message" after this phrase.

● Author: stx-goulder

Subject: Highlight

Date: 5/30/2008 6:23:48 PM

T REJECT (that convention is not used in any of the other "transmitter and receiver" sections)

OPEN_ACCEPT

Add "message" after this phrase.

7.15.2 XL transmitter and receiver

The XL transmitter receives the following messages from the XL state machine specifying primitive sequences, frames, and dwords to transmit:

- a) Transmit Idle Dword;
- b) Transmit AIP with an argument indicating the specific type (e.g., Transmit AIP (Normal));
- c) Transmit BREAK;
- d) Transmit BREAK_REPLY;
- e) Transmit BROADCAST with an argument indicating the specific type (e.g., Transmit BROADCAST (Change));
- f) Transmit CLOSE with an argument indicating the specific type (e.g., Transmit CLOSE (Normal));
- g) Transmit OPEN_ACCEPT;
- h) Transmit OPEN_REJECT, with an argument indicating the specific type (e.g., Transmit OPEN_REJECT (No Destination));
- i) Transmit OPEN Address Frame; and
- j) Transmit Dword.

The XL transmitter sends the following messages to the XL state machine based on dwords that have been transmitted:

- a) OPEN Address Frame Transmitted.

The XL transmitter shall ensure physical link rate tolerance management requirements are met (see 7.3) while originating dwords.

The XL transmitter shall ensure physical link rate tolerance management requirements are met while forwarding dwords (i.e., during a connection) by inserting or deleting as many deletable primitives as required to match the transmit and receive connection rates (see 7.3.2).

The XL transmitter shall ensure physical link rate tolerance management requirements are met (see 7.3) during and after switching from forwarding dwords to originating dwords, including, for example:

- a) when transmitting BREAK;
- b) when transmitting BREAK_REPLY;
- c) when transmitting CLOSE;
- d) when transmitting an idle dword after closing a connection (i.e., after receiving BREAK, BREAK_REPLY, or CLOSE);
- e) while transmitting a SATA frame to a SAS logical link during an STP connection, when transmitting the first SATA_HOLD in response to detection of SATA_HOLD; and
- f) while receiving dwords of a SATA frame from a SAS logical link during an STP connection, when transmitting SATA_HOLD.

NOTE 70 - The XL transmitter may always insert a deletable primitive before transmitting a BREAK, BREAK_REPLY, CLOSE, or SATA_HOLD to meet physical link rate tolerance management requirements.

The XL transmitter shall insert a deletable primitive before switching from originating dwords to forwarding dwords, including, for example:

- a) when transmitting OPEN_ACCEPT;
- b) when transmitting the last idle dword before a connection is established (i.e., after receiving OPEN_ACCEPT);
- c) while transmitting a SATA frame to a SAS logical link during an STP connection, when transmitting the last dword from the STP flow control buffer in response to release of SATA_HOLD;
- d) while transmitting a SATA frame to a SAS logical link during an STP connection, when transmitting the last SATA_HOLD in response to release of SATA_HOLD (e.g., if the STP flow control buffer is empty); and
- e) while receiving dwords of a SATA frame from a SAS logical link during an STP connection, when transmitting the last SATA_HOLD.

NOTE 71 - This ensures that physical link rate tolerance management requirements are met, even if the forwarded dword stream does not include a deletable primitive until the last possible dword.

● Author: stx-goulder

Subject: Highlight

Date: 5/30/2008 6:23:42 PM

T REJECT (that convention is not used in any of the other "transmitter and receiver" sections)

(No Destination)

add the word "message" after this phrase.

● Author: stx-goulder

Subject: Highlight

Date: 5/30/2008 6:23:33 PM

T REJECT (that convention is not used in any of the other "transmitter and receiver" sections)

Frame

Add "message" after this phrase.

● Author: stx-goulder

Subject: Highlight

Date: 5/30/2008 6:23:29 PM

T REJECT (that convention is not used in any of the other "transmitter and receiver" sections)

Dword

Add "message" after this phrase.

● Author: Isi-gpenokie

Subject: Highlight

Date: 5/6/2008 4:07:49 PM

T ACCEPT - DONE

This << following messages to the XL state machine >> should be << following message to the XL state machine >>

The XL transmitter shall ensure rate matching requirements are met during a connection (see 7.13).

When there is no outstanding message specifying a dword to transmit, the XL transmitter shall transmit idle dwords.

The XL receiver sends the following messages to the XL state machine indicating primitive sequences, frames, and dwords received from the SP_DWS receiver (see 6.9.2):

- a) AIP Received with an argument indicating the specific type (e.g., AIP Received (Normal)),
- b) BREAK Received;
- c) BREAK_REPLY Received;
- d) BROADCAST Received;
- e) CLOSE Received;
- f) OPEN_ACCEPT Received;
- g) OPEN_REJECT Received;
- h) OPEN Address Frame Received;
- i) Dword Received with an argument indicating the data dword or primitive received; and
- j) Invalid Dword Received.

The XL receiver shall ignore all other dwords.

While receiving an address frame, if the XL receiver receives an invalid dword or ERROR, then the XL receiver shall:

- a) ignore the invalid dword or ERROR; or
- b) discard the address frame.

The XL transmitter relationship to other transmitters is defined in 4.3.2. The XL receiver relationship to other receivers is defined in 4.3.3.

7.15.3 XL0:Idle state

7.15.3.1 State description

This state is the initial state and is the state that is used when there is no connection pending or established.

If a Phy Layer Not Ready confirmation is received, this state shall send a Broadcast Event Notify (Phy Not Ready) request to the BPP.

If a SATA Spinup Hold confirmation is received, this state shall send a Broadcast Event Notify (SATA Spinup Hold) request to the BPP.

If an Enable Disable SAS Link (Enable) message is received, this state shall send a Broadcast Event Notify (Identification Sequence Complete) request to the BPP.

If a SATA Port Selector Change confirmation is received, this state shall send a Broadcast Event Notify (SATA Port Selector Change) request to the BPP.

If a BROADCAST Received message is received, this state shall send a Broadcast Event Notify request to the BPP with the argument indicating the specific BROADCAST primitive received (e.g., Change Received).

If a Transmit Broadcast indication is received, this state shall send a Transmit BROADCAST message to the XL transmitter with an argument specifying the specific type from the Transmit Broadcast indication. Otherwise, this state shall request idle dwords be transmitted by repeatedly sending Transmit Idle Dword messages to the XL transmitter.

If a BREAK Received message is received and the BREAK_REPLY method of responding to received BREAK primitive sequences is enabled (see 7.12.5), then this state shall send a Transmit BREAK_REPLY message to the XL transmitter.

7.15.3.2 Transition XL0:Idle to XL1:Request_Path

This transition shall occur if:

- a) an Enable Disable SAS Link (Enable) message has been received;

Page: 376

● Author: stx-ghoulder
Subject: Highlight
Date: 5/30/2008 6:24:20 PM
 REJECT (see earlier reply about format)

(Normal
Shouldn't this be all CAPs (i.e., NORMAL)?

● Author: lsi-gpenokie
Subject: Highlight
Date: 5/6/2008 4:07:49 PM
 ACCEPT - DONE (added "either" - see earlier comment)

It seems like this << or >> should be << and >> but that would be a different requirement in that the state would do both a and b rather than have to pick either a or b. I'm not sure which was intended.

● Author: elx-bmartin
Subject: Sticky Note
Date: 9/1/2008 4:23:20 PM
 ACCEPT - DONE (In XL0, added "This state shall repeatedly send Idle requests to the ECM." Added Idle to the list of ECM requests in chapter 4 (including in the figure). In ch7 ECM arbitration requirements overview, added "If the ECM receives an Idle request from a phy that is involved in a connection before it has received a Forward Close request from that phy and sent a Forward Close indication to that phy, then the ECR shall send a Forward Break indication to the destination phy."

7/14 Describe that the ECM/ECR does this.

7/9 the Enable Disable SAS Link message from SL_IR is already in the diagrams and described in the state machine overview, the same as in SL_CC. However, we do need to get a BREAK to occur on the other end. Should XL of the disabled phy do that, or can the ECR do that on its own? 7/9 call prefers having the ECM/ECR do it, rather than asking XL to do something as it is basically being disabled)

As in the SL state machines, there should be a global transition to the XL0 state if a Phy Layer Not Ready confirmation is received; however, if the XL state machine has a connection, it should send a Forward Break request to the ECM. This affects a number of states.

● Author: RElliott
Subject: Highlight
Date: 6/30/2008 6:16:52 PM
 ACCEPT - DONE
this
s/b
then this

● Author: RElliott
Subject: Highlight
Date: 6/30/2008 6:16:52 PM
 ACCEPT - DONE
this
s/b
then this

● Author: RElliott
Subject: Highlight
Date: 6/30/2008 6:16:52 PM
 ACCEPT - DONE
this
s/b

Comments from page 376 continued on next page

The XL transmitter shall ensure rate matching requirements are met during a connection (see 7.13).

When there is no outstanding message specifying a dword to transmit, the XL transmitter shall transmit idle dwords.

The XL receiver sends the following messages to the XL state machine indicating primitive sequences, frames, and dwords received from the SP_DWS receiver (see 6.9.2):

- a) AIP Received with an argument indicating the specific type (e.g., AIP Received (Normal));
- b) BREAK Received;
- c) BREAK_REPLY Received;
- d) BROADCAST Received;
- e) CLOSE Received;
- f) OPEN_ACCEPT Received;
- g) OPEN_REJECT Received;
- h) OPEN Address Frame Received;
- i) Dword Received with an argument indicating the data dword or primitive received; and
- j) Invalid Dword Received.

The XL receiver shall ignore all other dwords.

While receiving an address frame, if the XL receiver receives an invalid dword or ERROR, then the XL receiver shall:

- a) ignore the invalid dword or ERROR; or
- b) discard the address frame.

The XL transmitter relationship to other transmitters is defined in 4.3.2. The XL receiver relationship to other receivers is defined in 4.3.3.

7.15.3 XL0:Idle state

7.15.3.1 State description

This state is the initial state and is the state that is used when there is no connection pending or established.

If a Phy Layer Not Ready confirmation is received, this state shall send a Broadcast Event Notify (Phy Not Ready) request to the BPP.

If a SATA Spinup Hold confirmation is received, this state shall send a Broadcast Event Notify (SATA Spinup Hold) request to the BPP.

If an Enable Disable SAS Link (Enable) message is received, this state shall send a Broadcast Event Notify (Identification Sequence Complete) request to the BPP.

If a SATA Port Selector Change confirmation is received, this state shall send a Broadcast Event Notify (SATA Port Selector Change) request to the BPP.

If a BROADCAST Received message is received, this state shall send a Broadcast Event Notify request to the BPP with the argument indicating the specific BROADCAST primitive received (e.g., Change Received).

If a Transmit Broadcast indication is received, this state shall send a Transmit BROADCAST message to the XL transmitter with an argument specifying the specific type from the Transmit Broadcast indication. Otherwise, this state shall request idle dwords be transmitted by repeatedly sending Transmit Idle Dword messages to the XL transmitter.

If a BREAK Received message is received and the BREAK_REPLY method of responding to received BREAK primitive sequences is enabled (see 7.12.5), then this state shall send a Transmit BREAK_REPLY message to the XL transmitter.

7.15.3.2 Transition XL0:Idle to XL1:Request_Path

This transition shall occur if:

- a) an Enable Disable SAS Link (Enable) message has been received;

then this

● Author: RElliott
Subject: Highlight
Date: 6/30/2008 6:16:52 PM
T ACCEPT - DONE
this
s/b
then this

● Author: RElliott
Subject: Highlight
Date: 6/30/2008 6:16:52 PM
T ACCEPT - DONE
this
s/b
then this

● Author: RElliott
Subject: Highlight
Date: 6/30/2008 6:16:52 PM
T ACCEPT - DONE
this
s/b
then this

● Author: wdc-mevans
Subject: Highlight
Date: 5/23/2008 1:27:03 PM
T REJECT (2 things ANDED)

received and
s/b
received, and

- b) a Forward Open indication is not being received; and
- c) an OPEN Address Frame Received message is received.

This state shall include an OPEN Address Frame Received argument with the transition.

7.15.3.3 Transition XL0:Idle to XL5:Forward_Open

This transition shall occur if:

- a) an Enable Disable SAS Link (Enable) message has been received; and
- b) a Forward Open indication is received.

This transition shall include a set of arguments containing the arguments received in the Forward Open indication.

If an OPEN Address Frame Received message is received, **this** state shall include an OPEN Address Frame Received argument with the transition.

7.15.4 XL1:Request_Path state

7.15.4.1 State description

This state is used to arbitrate for connection resources and to specify the destination of the connection.

If an Arbitrating (Normal) confirmation is received, **this** state shall repeatedly send Transmit AIP (Normal) and Transmit Idle Dword messages to the XL transmitter in accordance with AIP transmission rules (see 7.12.4.3).

If an Arbitrating (Waiting On Partial) or Arbitrating (Blocked On Partial) confirmation is received, **this** state shall repeatedly send Transmit AIP (Waiting On Partial) and Transmit Idle Dword messages to the XL transmitter in accordance with AIP transmission rules (see 7.12.4.3).

If an Arbitrating (Waiting On Partial) confirmation is received, **this** state shall repeatedly send a Phy Status (Partial Pathway) response to the ECM.

If an Arbitrating (Blocked On Partial) confirmation is received, **this** state shall repeatedly send a Phy Status (Blocked Partial Pathway) response to the ECM.

If an Arbitrating (Waiting On Connection) confirmation is received, **this** state shall repeatedly send Transmit AIP (Waiting On Connection) and Transmit Idle Dword messages to the XL transmitter in accordance with AIP transmission rules (see 7.12.4.3).

If an Arbitrating (Waiting On Connection) confirmation is received, **this** state shall repeatedly send a Phy Status (Connection) response to the ECM.

If this state is entered from the XL6:Open_Response_Wait state, **the** Retry Priority Status argument shall be set to IGNORE AWT. If this state is entered from any other state, **the** Retry Priority Status argument shall be set to NORMAL.

Upon entry into this state, this state shall send a Request Path request to the ECM with the following arguments:

- a) initiator port bit;
- b) protocol;
- c) connection rate;
- d) initiator connection tag;
- e) destination SAS address;
- f) source SAS address;
- g) pathway blocked count;
- h) arbitration wait time; and
- i) retry priority status.

This state maintains the Partial Pathway Timeout timer.

If the Partial Pathway Timeout timer is not already running, **the** Partial Pathway Timeout timer shall be initialized and started when an Arbitrating (Blocked On Partial) confirmation is received.

Page: 377

● Author: RElliott
Subject: Highlight
Date: 6/30/2008 6:16:52 PM

T ACCEPT - DONE
this
s/b
then this

● Author: stx-goulder
Subject: Highlight
Date: 5/30/2008 6:25:07 PM

T ACCEPT - DONE (as "messages")

Normal
add the word "message" after this phrase.

● Author: RElliott
Subject: Highlight
Date: 6/30/2008 6:16:52 PM

T ACCEPT - DONE
this
s/b
then this

● Author: RElliott
Subject: Highlight
Date: 6/30/2008 6:16:52 PM

T ACCEPT - DONE
this
s/b
then this

● Author: lsi-gpenokie
Subject: Highlight
Date: 5/25/2008 9:07:53 PM

T ACCEPT - DONE (including an extra "an")

This << Arbitrating (Waiting On Partial) or Arbitrating (Blocked On Partial) confirmation is received >> should be << Arbitrating (Waiting On Partial) confirmation or Arbitrating (Blocked On Partial) confirmation is received >>

● Author: stx-goulder
Subject: Highlight
Date: 5/25/2008 9:08:16 PM

T ACCEPT - DONE (as "messages")

Waiting On Partial
add the word "message" after this phrase.

● Author: lsi-gpenokie
Subject: Highlight
Date: 5/25/2008 9:08:33 PM

T REJECT (see stx-goulder reply instead)

This << send Transmit AIP (Waiting On Partial) and Transmit Idle Dword messages to >> should be << send Transmit AIP (Waiting On Partial) message and Transmit Idle Dword message to >>>

Comments from page 377 continued on next page

- b) a Forward Open indication is not being received; and
- c) an OPEN Address Frame Received message is received.

This state shall include an OPEN Address Frame Received argument with the transition.

7.15.3.3 Transition XL0:Idle to XL5:Forward_Open

This transition shall occur if:

- a) an Enable Disable SAS Link (Enable) message has been received; and
- b) a Forward Open indication is received.

This transition shall include a set of arguments containing the arguments received in the Forward Open indication.

If an OPEN Address Frame Received message is received, this state shall include an OPEN Address Frame Received argument with the transition.

7.15.4 XL1:Request_Path state

7.15.4.1 State description

This state is used to arbitrate for connection resources and to specify the destination of the connection.

If an Arbitrating (Normal) confirmation is received, this state shall repeatedly send Transmit AIP (Normal) and Transmit Idle Dword messages to the XL transmitter in accordance with AIP transmission rules (see 7.12.4.3).

If an Arbitrating (Waiting On Partial) or Arbitrating (Blocked On Partial) confirmation is received, this state shall repeatedly send Transmit AIP (Waiting On Partial) and Transmit Idle Dword messages to the XL transmitter in accordance with AIP transmission rules (see 7.12.4.3).

If an Arbitrating (Waiting On Partial) confirmation is received, this state shall repeatedly send a Phy Status (Partial Pathway) response to the ECM.

If an Arbitrating (Blocked On Partial) confirmation is received, this state shall repeatedly send a Phy Status (Blocked Partial Pathway) response to the ECM.

If an Arbitrating (Waiting On Connection) confirmation is received, this state shall repeatedly send Transmit AIP (Waiting On Connection) and Transmit Idle Dword messages to the XL transmitter in accordance with AIP transmission rules (see 7.12.4.3).

If an Arbitrating (Waiting On Connection) confirmation is received, this state shall repeatedly send a Phy Status (Connection) response to the ECM.

If this state is entered from the XL6:Open_Response_Wait state, the Retry Priority Status argument shall be set to IGNORE AWT. If this state is entered from any other state, the Retry Priority Status argument shall be set to NORMAL.

Upon entry into this state, this state shall send a Request Path request to the ECM with the following arguments:

- a) initiator port bit;
- b) protocol;
- c) connection rate;
- d) initiator connection tag;
- e) destination SAS address;
- f) source SAS address;
- g) pathway blocked count;
- h) arbitration wait time; and
- i) retry priority status.

This state maintains the Partial Pathway Timeout timer.

If the Partial Pathway Timeout timer is not already running, the Partial Pathway Timeout timer shall be initialized and started when an Arbitrating (Blocked On Partial) confirmation is received.

Author: RElliott
Subject: Highlight
Date: 6/30/2008 6:16:52 PM
T ACCEPT - DONE
this
s/b
then this

Author: RElliott
Subject: Highlight
Date: 6/30/2008 6:16:52 PM
T ACCEPT - DONE
this
s/b
then this

Author: RElliott
Subject: Highlight
Date: 6/30/2008 6:16:52 PM
T ACCEPT - DONE
this
s/b
then this

Author: lsi-gpenokie
Subject: Highlight
Date: 5/25/2008 9:09:08 PM
T REJECT (see stx-goulder reply instead)

This << send Transmit AIP (Waiting On Connection) and Transmit Idle Dword messages >> should be << send Transmit AIP (Waiting On Connection) message and Transmit Idle Dword message >>

Author: stx-goulder
Subject: Highlight
Date: 5/25/2008 9:08:53 PM
T ACCEPT - DONE (as "messages")

Waiting On Connection)
add the word "message" after this phrase.

Author: RElliott
Subject: Highlight
Date: 6/30/2008 6:16:52 PM
T ACCEPT - DONE
this
s/b
then this

Author: RElliott
Subject: Highlight
Date: 6/30/2008 6:16:52 PM
T ACCEPT - DONE
the
s/b
then the

- b) a Forward Open indication is not being received; and
- c) an OPEN Address Frame Received message is received.

This state shall include an OPEN Address Frame Received argument with the transition.

7.15.3.3 Transition XL0:Idle to XL5:Forward_Open

This transition shall occur if:

- a) an Enable Disable SAS Link (Enable) message has been received; and
- b) a Forward Open indication is received.

This transition shall include a set of arguments containing the arguments received in the Forward Open indication.

If an OPEN Address Frame Received message is received, this state shall include an OPEN Address Frame Received argument with the transition.

7.15.4 XL1:Request_Path state

7.15.4.1 State description

This state is used to arbitrate for connection resources and to specify the destination of the connection.

If an Arbitrating (Normal) confirmation is received, this state shall repeatedly send Transmit AIP (Normal) and Transmit Idle Dword messages to the XL transmitter in accordance with AIP transmission rules (see 7.12.4.3).

If an Arbitrating (Waiting On Partial) or Arbitrating (Blocked On Partial) confirmation is received, this state shall repeatedly send Transmit AIP (Waiting On Partial) and Transmit Idle Dword messages to the XL transmitter in accordance with AIP transmission rules (see 7.12.4.3).

If an Arbitrating (Waiting On Partial) confirmation is received, this state shall repeatedly send a Phy Status (Partial Pathway) response to the ECM.

If an Arbitrating (Blocked On Partial) confirmation is received, this state shall repeatedly send a Phy Status (Blocked Partial Pathway) response to the ECM.

If an Arbitrating (Waiting On Connection) confirmation is received, this state shall repeatedly send Transmit AIP (Waiting On Connection) and Transmit Idle Dword messages to the XL transmitter in accordance with AIP transmission rules (see 7.12.4.3).

If an Arbitrating (Waiting On Connection) confirmation is received, this state shall repeatedly send a Phy Status (Connection) response to the ECM.

If this state is entered from the XL6:Open_Response_Wait state, the Retry Priority Status argument shall be set to IGNORE AWT. If this state is entered from any other state, the Retry Priority Status argument shall be set to NORMAL.

Upon entry into this state, this state shall send a Request Path request to the ECM with the following arguments:

- a) initiator port bit;
- b) protocol;
- c) connection rate;
- d) initiator connection tag;
- e) destination SAS address;
- f) source SAS address;
- g) pathway blocked count;
- h) arbitration wait time; and
- i) retry priority status.

This state maintains the Partial Pathway Timeout timer.

If the Partial Pathway Timeout timer is not already running, the Partial Pathway Timeout timer shall be initialized and started when an Arbitrating (Blocked On Partial) confirmation is received.

Author: RElliott
Subject: Highlight
Date: 6/30/2008 6:16:52 PM
T ACCEPT - DONE
the
s/b
then the

Author: RElliott
Subject: Highlight
Date: 6/30/2008 6:16:52 PM
T ACCEPT - DONE
the
s/b
then the

If the Partial Pathway Timeout timer is already running, the Partial Pathway Timeout timer shall continue to run if an Arbitrating (Blocked On Partial) confirmation is received.

The Partial Pathway Timeout timer shall be stopped when one of the following confirmations is received:

- a) Arbitrating (Waiting On Partial); or
- b) Arbitrating (Waiting On Connection).

If the Partial Pathway Timeout timer expires, this state shall send a Partial Pathway Timeout Timer Expired request to the ECM.

7.15.4.2 Transition XL1:Request_Path to XL0:Idle

This transition shall occur if:

- a) a BREAK Received message has not been received; and
- b) an Arb Lost confirmation is received.

7.15.4.3 Transition XL1:Request_Path to XL2:Request_Open

This transition shall occur if:

- a) a BREAK Received message has not been received; and
- b) an Arb Won confirmation is received.

7.15.4.4 Transition XL1:Request_Path to XL4:Open_Reject

This transition shall occur if:

- a) a BREAK Received message has not been received; and
- b) an Arb Reject confirmation is received.

This transition shall include an Arb Reject argument corresponding to the Arb Reject confirmation.

7.15.4.5 Transition XL1:Request_Path to XL5:Forward_Open

This transition shall occur if a Forward Open indication is received and none of the following confirmations have been received:

- a) Arbitrating (Normal);
- b) Arbitrating (Waiting On Partial);
- c) Arbitrating (Blocked On Partial);
- d) Arbitrating (Waiting On Connection);
- e) Arb Won;
- f) Arb Lost;
- g) Arb Reject (No Destination);
- h) Arb Reject (Bad Destination);
- i) Arb Reject (Connection Rate Not Supported);
- j) Arb Reject (Zone Violation);
- k) Arb Reject (Pathway Blocked); or
- l) Arb Reject (Retry).

This transition shall include:

- a) an OPEN Address Frame Received argument containing the arguments received in the Forward Open indication; and
- b) a BREAK Received argument if a BREAK Received message was received.

7.15.4.6 Transition XL1:Request_Path to XL9:Break

This transition shall occur after receiving a BREAK Received message if a Forward Open indication has not been received.

● Author: RElliott
Subject: Highlight
Date: 6/30/2008 6:16:52 PM

T ACCEPT - DONE
the
s/b
then the

● Author: RElliott
Subject: Highlight
Date: 6/30/2008 6:16:52 PM

T ACCEPT - DONE
this
s/b
then this

7.15.5 XL2:Request_Open state

7.15.5.1 State description

This state is used to forward an OPEN address frame through the ECR to a destination phy.

This state shall request idle dwords be transmitted by repeatedly sending Transmit Idle Dword messages to the XL transmitter.

Upon entry into this state, this state shall send a Forward Open request to the ECR, received by the destination phy as a Forward Open indication (see 7.15.5.2). The arguments to the Forward Open request are:

- a) initiator port bit;
- b) protocol;
- c) features;
- d) connection rate;
- e) initiator connection tag;
- f) destination SAS address;
- g) source SAS address;
- h) source zone group;
- i) pathway blocked count;
- j) arbitration wait time; and
- k) more compatible features.

7.15.5.2 Transition XL2:Request_Open to XL3:Open_Confirm_Wait

This transition shall occur after sending a Forward Open request to the ECR.

If a BREAK Received message is received, this state shall include a BREAK Received argument with the transition.

7.15.6 XL3:Open_Confirm_Wait state

7.15.6.1 State description

This state waits for confirmation for an OPEN address frame sent on a destination phy.

This state shall send the following messages to the XL transmitter:

- a) Transmit AIP (Normal) when an Arb Status (Normal) confirmation is received;
- b) Transmit AIP (Waiting On Partial) when an Arb Status (Waiting On Partial) confirmation is received;
- c) Transmit AIP (Waiting On Connection) when an Arb Status (Waiting On Connection) confirmation is received;
- d) Transmit AIP (Waiting On Device) when an Arb Status (Waiting On Device) confirmation is received;
- e) Transmit OPEN_ACCEPT when an Open Accept confirmation is received (see 7.15.6.5);
- f) Transmit OPEN_REJECT when an Open Reject confirmation is received with the argument from the Open Reject confirmation, after releasing path resources (see 7.15.6.2); or
- g) request idle dwords be transmitted by repeatedly sending Transmit Idle Dword messages when none of the previous conditions are present.

If a Backoff Retry confirmation is received, this state shall release path resources.

If a BREAK Received message is received or a BREAK Received argument is included in the transition into this state, this state shall send a Forward Break request to the ECR (see 7.15.6.6).

This state shall repeatedly send a Phy Status (Partial Pathway) response to the ECM until an Arb Status (Waiting On Partial) confirmation is received. After an Arb Status (Waiting on Partial) confirmation is received, this state shall repeatedly send a Phy Status (Blocked Partial Pathway) response to the ECM.

If a Dword Received message is received containing a valid dword except a BREAK primitive, this state shall send a Forward Dword request to the ECR containing that dword.

Page: 379

● Author: stx-goulder
Subject: Highlight
Date: 5/30/2008 6:25:18 PM
 REJECT (see previous reply about formatting)

Normal
Shouldn't this be all CAPs (i.e., NORMAL)?

● Author: stx-goulder
Subject: Highlight
Date: 5/30/2008 6:26:45 PM
 ACCEPT - DONE

Waiting On Partial)
add the word "message" after this phrase.

● Author: stx-goulder
Subject: Highlight
Date: 5/30/2008 6:26:48 PM
 ACCEPT - DONE

Waiting On Connection
add the word "message" after this phrase.

● Author: stx-goulder
Subject: Highlight
Date: 5/30/2008 6:26:51 PM
 ACCEPT - DONE

(Waiting On Device)
add the word "message" after this phrase.

● Author: stx-goulder
Subject: Highlight
Date: 5/30/2008 6:26:56 PM
 ACCEPT - DONE

OPEN_ACCEPT
add the word "message" after this phrase.

● Author: lsi-gpenokie
Subject: Sticky Note
Date: 5/30/2008 6:26:35 PM
 ACCEPT - DONE

All the << Transmit AIP (...) >> should be << Transmit AIP (...) message >>

● Author: stx-goulder
Subject: Highlight
Date: 6/30/2008 10:42:17 AM
 ACCEPT - DONE

OPEN_REJECT
add the word "message" after this phrase.

● Author: wdc-mevans
Subject: Highlight

Comments from page 379 continued on next page

7.15.5 XL2:Request_Open state

7.15.5.1 State description

This state is used to forward an OPEN address frame through the ECR to a destination phy.

This state shall request idle dwords be transmitted by repeatedly sending Transmit Idle Dword messages to the XL transmitter.

Upon entry into this state, this state shall send a Forward Open request to the ECR, received by the destination phy as a Forward Open indication (see 7.15.5.2). The arguments to the Forward Open request are:

- a) initiator port bit;
- b) protocol;
- c) features;
- d) connection rate;
- e) initiator connection tag;
- f) destination SAS address;
- g) source SAS address;
- h) source zone group;
- i) pathway blocked count;
- j) arbitration wait time; and
- k) more compatible features.

7.15.5.2 Transition XL2:Request_Open to XL3:Open_Confirm_Wait

This transition shall occur after sending a Forward Open request to the ECR.

If a BREAK Received message is received, this state shall include a BREAK Received argument with the transition.

7.15.6 XL3:Open_Confirm_Wait state

7.15.6.1 State description

This state waits for confirmation for an OPEN address frame sent on a destination phy.

This state shall send the following messages to the XL transmitter:

- a) Transmit AIP (Normal) when an Arb Status (Normal) confirmation is received;
- b) Transmit AIP (Waiting On Partial) when an Arb Status (Waiting On Partial) confirmation is received;
- c) Transmit AIP (Waiting On Connection) when an Arb Status (Waiting On Connection) confirmation is received;
- d) Transmit AIP (Waiting On Device) when an Arb Status (Waiting On Device) confirmation is received;
- e) Transmit OPEN_ACCEPT when an Open Accept confirmation is received (see 7.15.6.5);
- f) Transmit OPEN_REJECT when an Open Reject confirmation is received with the argument from the Open Reject confirmation, after releasing path resources (see 7.15.6.2); or
- g) request idle dwords be transmitted by repeatedly sending Transmit Idle Dword messages when none of the previous conditions are present.

If a Backoff Retry confirmation is received, this state shall release path resources.

If a BREAK Received message is received or a BREAK Received argument is included in the transition into this state, this state shall send a Forward Break request to the ECR (see 7.15.6.6).

This state shall repeatedly send a Phy Status (Partial Pathway) response to the ECM until an Arb Status (Waiting On Partial) confirmation is received. After an Arb Status (Waiting on Partial) confirmation is received, this state shall repeatedly send a Phy Status (Blocked Partial Pathway) response to the ECM.

If a Dword Received message is received containing a valid dword except a BREAK primitive, this state shall send a Forward Dword request to the ECR containing that dword.

Date: 5/25/2008 9:09:23 PM
REJECT (2 things ANDED)

received or
s/b
received, or

Author: elx-bmartin
Subject: Comment on Text
Date: 7/17/2008 8:04:19 PM

REJECT (7/17 Bill agrees to reject.

5/5 if XL3 is not forwarding, the transmitting expander phy's XL6 -> XL7 transition will leave XL7 without a clue about what to send until XL3 receives the OPEN_ACCEPT notification. It is easier if XL3 always forwards. XL6 already has an option to either generate idle dwords or forward dwords, so is not obligated to forward them.)

shall
s/b
may

There should not be any dwords except idle or BREAK received while in this state, so a receiver should be allowed to delete dwords that are should not be here. Additionally in XL6, when a dword is forwarded it may send that dword or just send idles.

Author: lsi-bday
Subject: Highlight
Date: 9/1/2008 4:28:28 PM

ACCEPT - DONE (

9/1 This is already qualified by being dwords in the Dword Received message. In the XL receiver definition of Dword Received, added " Deletable primitives are not included." to delete them at the source.

7/9 use "or deletable primitive" which also covers ALIGNs)

BREAK
s/b
BREAK, MUX, or NOTIFY
or deletable primitive?

Author: wdc-mevans
Subject: Highlight
Date: 5/30/2008 6:27:24 PM
REJECT (that's a critical phrase)

dword except
s/b
dword, except

If:

- a) an Invalid Dword Received message is received; and
- b) the expander logical phy is forwarding to an expander logical phy attached to a SAS logical link,

then the expander logical phy shall:

- a) send an ERROR primitive with the Forward Dword request instead of the invalid dword; or
- b) delete the invalid dword.

If:

- a) an ERROR primitive is received with the Dword Received message or an Invalid Dword Received message is received; and
- b) the expander logical phy is forwarding to an expander phy attached to a SATA physical link,

then the expander logical phy shall:

- a) send a SATA_ERROR with the Forward Dword request instead of the invalid dword or ERROR primitive; or
- b) delete the ERROR primitive or invalid dword.

7.15.6.2 Transition XL3:Open_Confirm_Wait to XL0:Idle

This transition shall occur after sending a Transmit OPEN_REJECT message to the XL transmitter if:

- a) a BREAK Received message has not been received; and
- b) a BREAK Received argument was not included in the transition into this state.

7.15.6.3 Transition XL3:Open_Confirm_Wait to XL1:Request_Path

This transition shall occur after receiving a Backoff Retry confirmation, after releasing path resources if:

- a) a BREAK Received message has not been received; and
- b) a BREAK Received argument was not included in the transition into this state.

7.15.6.4 Transition XL3:Open_Confirm_Wait to XL5:Forward_Open

This transition shall occur after receiving a Backoff Reverse Path confirmation if:

- a) a BREAK Received message has not been received; and
- b) a BREAK Received argument was not included in the transition into this state.

The transition shall include the Backoff Reverse Path arguments (i.e., the OPEN address frame).

7.15.6.5 Transition XL3:Open_Confirm_Wait to XL7:Connected

This transition shall occur after sending a Transmit OPEN_ACCEPT message to the XL transmitter if:

- a) a BREAK Received message has not been received; and
- b) a BREAK Received argument was not included in the transition into this state.

7.15.6.6 Transition XL3:Open_Confirm_Wait to XL9:Break

This transition shall occur after sending a Forward Break request to the ECR.

7.15.6.7 Transition XL3:Open_Confirm_Wait to XL10:Break_Wait

This transition shall occur after receiving a Forward Break indication if:

- a) a BREAK Received message has not been received; and
- b) a BREAK Received argument was not included in the transition into this state.

● Author: Isi-gpenokie
Subject: Highlight
Date: 5/25/2008 9:10:07 PM
T REJECT (written as intended)

It seems like this << or >> should be << and >> but that would be a different requirement in that the state would do both a and b rather than have to pick either a or b. I'm not sure which was intended.

● Author: Isi-gpenokie
Subject: Highlight
Date: 5/25/2008 9:10:21 PM
T REJECT (written as intended)

It seems like this << or >> should be << and >> but that would be a different requirement in that the state would do both a and b rather than have to pick either a or b. I'm not sure which was intended.

7.15.7 XL4:Open_Reject state

7.15.7.1 State description

This state is used to reject a connection request.

This state shall send one of the following messages to the XL transmitter (see 7.15.7.2):

- a) a Transmit OPEN_REJECT (No Destination) message when an Arb Reject (No Destination) argument is received with the transition into this state;
- b) a Transmit OPEN_REJECT (Bad Destination) message when an Arb Reject (Bad Destination) argument is received with the transition into this state;
- c) a Transmit OPEN_REJECT (Connection Rate Not Supported) message when an Arb Reject (Connection Rate Not Supported) argument is received with the transition into this state;
- d) a Transmit OPEN_REJECT (Zone Violation) message when an Arb Reject (Zone Violation) argument is received with the transition into this state;
- e) a Transmit OPEN_REJECT (Pathway Blocked) message when an Arb Reject (Pathway Blocked) argument is received with the transition into this state; or
- f) a Transmit OPEN_REJECT (Retry) message when an Arb Reject (Retry) argument is received with the transition into this state.



7.15.7.2 Transition XL4:Open_Reject to XL0:Idle

This transition shall occur after sending a Transmit OPEN_REJECT message to the XL transmitter.

7.15.7.3 Transition XL4:Open_Reject to XL5:Forward_Open

This transition shall occur if a Forward Open indication is received. This transition shall include an OPEN Address Frame Received argument containing the arguments received in the Forward Open indication.

7.15.8 XL5:Forward_Open state

7.15.8.1 State description

This state is used to transmit an OPEN address frame passed with the transition into this state.

If a BROADCAST Received message is received, this state shall send a Broadcast Event Notify request to the BPP with the argument indicating the specific BROADCAST primitive received (e.g., Change Received).

Upon entry into this state, this state shall send a Transmit OPEN Address Frame message to the XL transmitter with the fields set to the values specified with the transition into this state.

This state shall request idle dwords be transmitted by repeatedly sending Transmit Idle Dword messages to the XL transmitter.

7.15.8.2 Transition XL5:Forward_Open to XL6:Open_Response_Wait

This transition shall occur after receiving an OPEN Address Frame Transmitted message.

If an OPEN Address Frame Received message or argument is received, this state shall include an OPEN Address Frame Received argument with the transition.

If a BREAK Received message or argument is received, this state shall include a BREAK Received argument with the transition.

7.15.9 XL6:Open_Response_Wait state

7.15.9.1 State description

This state waits for a response to a transmitted OPEN address frame and determines the appropriate action to take based on the response.

● Author: elx-bmartin
Subject: Cross-Out
Date: 5/6/2008 4:07:49 PM
 ACCEPT - DONE
g)

● Author: Isi-gpenokie
Subject: Cross-Out
Date: 5/6/2008 4:07:49 PM
 ACCEPT - DONE
Extra item

● Author: wdc-mevans
Subject: Cross-Out
Date: 5/6/2008 4:07:49 PM
 ACCEPT - DONE
g)
s/b
[Delete the extra list item designator.]

● Author: stx-goulder
Subject: Highlight
Date: 5/6/2008 4:07:49 PM
 ACCEPT - DONE
g)
Delete the empty item g).

This state shall either:

- a) request idle dwords be transmitted by repeatedly sending Transmit Idle Dword messages to the XL transmitter, honoring ALIGN insertion rules for rate matching and physical link rate tolerance management; or
- b) send Transmit Dword messages to the XL transmitter to transmit all dwords received with Forward Dword indications.

If a BROADCAST Received message is received before an AIP Received message is received this state shall send a Broadcast Event Notify request to the BPP with the argument indicating the specific BROADCAST primitive received (e.g., Broadcasts).

This state shall send the following responses to the ECR, which are received by the source phy as confirmations:

- a) an Open Accept response when an OPEN_ACCEPT Received message is received (see 7.15.9.5);
- b) an Open Reject response when an OPEN_REJECT Received message is received, after releasing any path resources (see 7.15.9.2);
- c) a Backoff Retry response, after releasing path resources (see 7.15.9.3), when:
 - A) an AIP Received message has not been received;
 - B) an OPEN Address Frame Received message is received or an OPEN Address Frame Received argument is included in the transition into this state containing a higher priority OPEN address frame according to the arbitration fairness comparison (see 7.12.3); and
 - C) the destination SAS address and connection rate of the received OPEN address frame are not equal to the source SAS address and connection rate of the transmitted OPEN address frame;
- d) a Backoff Retry response, after releasing path resources (see 7.15.9.3), when:
 - A) an AIP Received message has been received;
 - B) an OPEN Address Frame Received message is received or an OPEN Address Frame Received argument is included in the transition into this state; and
 - C) the destination SAS address and connection rate of the received OPEN address frame are not equal to the source SAS address and connection rate of the transmitted OPEN address frame;
- e) a Backoff Reverse Path response (see 7.15.9.4) when:
 - A) an AIP Received message has not been received,
 - B) an OPEN Address Frame Received message is received or an OPEN Address Frame Received argument is included in the transition into this state containing a higher priority OPEN address frame according to the arbitration fairness comparison (see 7.12.3); and
 - C) the destination SAS address and connection rate of the received OPEN address frame are equal to the source SAS address and connection rate of the transmitted OPEN address frame;

and
- f) a Backoff Reverse Path response (see 7.15.9.4) when:
 - A) an AIP Received message has been received;
 - B) an OPEN Address Frame Received message is received or an OPEN Address Frame Received argument is included in the transition into this state; and
 - C) the destination SAS address and connection rate of the received OPEN address frame are equal to the source SAS address and connection rate of the transmitted OPEN address frame.

A Backoff Reverse Path response shall include the contents of the OPEN Address Frame Received message or argument.

This state shall send the following responses to the ECR, which are received by the source phy as confirmations:

- a) an Arb Status (Waiting On Device) response upon entry into this state;
- b) an Arb Status (Normal) response when an AIP Received (Normal) message is received;
- c) an Arb Status (Waiting On Partial) response when an AIP Received (Waiting On Partial) message is received;
- d) an Arb Status (Waiting On Connection) response when an AIP Received (Waiting On Connection) message is received; and

● Author: wdc-mevans
Subject: Highlight
Date: 5/25/2008 9:10:48 PM
T ACCEPT - DONE

received this
s/b
received, then this

● Author: RElliott
Subject: Highlight
Date: 8/30/2008 1:42:00 PM
T ACCEPT - DONE

Broadcast Event Notify request to the BPP with the argument indicating the specific BROADCAST primitive received (e.g., Broadcasts)
s/b
Broadcast Event Notify request to the BPP with the argument indicating the specific BROADCAST primitive received (e.g., Broadcast Event Notify (Change Received))

● Author: wdc-mevans
Subject: Highlight
Date: 5/25/2008 9:11:12 PM
T REJECT (2 things ORed)

received or
s/b
received, or

● Author: wdc-mevans
Subject: Highlight
Date: 5/25/2008 9:11:18 PM
T REJECT (2 things ORed)

received or
s/b
received, or

● Author: wdc-mevans
Subject: Highlight
Date: 5/25/2008 9:11:25 PM
T REJECT (2 things ORed)

received or
s/b
received, or

● Author: wdc-mevans
Subject: Highlight
Date: 5/25/2008 9:11:30 PM
T REJECT (2 things ORed)

received or
s/b
received, or

- e) an Arb Status (Waiting On Device) response when an AIP Received (Waiting On Device) message is received.

If a BREAK Received message is received or a BREAK Received argument is included in the transition into this state, this state shall send a Forward Break request to the ECR (see 7.15.9.6).

This state shall repeatedly send a Phy Status (Partial Pathway) response to the ECM until an AIP Received (Waiting On Partial) message is received. After an AIP Received (Waiting On Partial) message is received, this state shall repeatedly send a Phy Status (Blocked Partial Pathway) response to the ECM.

7.15.9.2 Transition XL6:Open_Response_Wait to XL0:Idle

This transition shall occur after sending an Open Reject response to the ECR.

7.15.9.3 Transition XL6:Open_Response_Wait to XL1:Request_Path

This transition shall occur after sending a Backoff Retry response to the ECR.

7.15.9.4 Transition XL6:Open_Response_Wait to XL2:Request_Open

This transition shall occur after sending a Backoff Reverse Path response to the ECR.

7.15.9.5 Transition XL6:Open_Response_Wait to XL7:Connected

This transition shall occur after sending an Open Accept response to the ECR.

7.15.9.6 Transition XL6:Open_Response_Wait to XL9:Break

This transition shall occur after sending a Forward Break response to the ECR.

7.15.9.7 Transition XL6:Open_Response_Wait to XL10:Break_Wait

This transition shall occur after receiving a Forward Break indication if:

- a) a BREAK Received message has not been received; and
- b) a BREAK Received argument was not included in the transition into this state.

7.15.10 XL7:Connected state

7.15.10.1 State description

This state provides a full-duplex circuit between two phys within an expander device.

This state shall send Transmit Dword messages to the XL transmitter to transmit all dwords received with Forward Dword indications. During an STP connection, the expander device may expand or contract a repeated or continued primitive sequence (see 7.2.4).

If this state has not sent a Forward Close request to the ECR, this state shall send Forward Dword requests to the ECR containing each valid dword except BREAK and CLOSE primitives received with Dword Received messages. During an STP connection, the expander device may expand or contract a repeated or continued primitive sequence (see 7.2.4).

If:

- a) an Invalid Dword Received message is received; and
- b) the expander phy is forwarding to an expander logical phy attached to a SAS logical link,

the expander logical phy shall:

- a) send an ERROR primitive with the Forward Dword request instead of the invalid dword; or
- b) delete the invalid dword.

If:

- a) an ERROR primitive is received with the Dword Received message or an Invalid Dword Received message is received; and

Author: lsi-gpenokie
Subject: Highlight
Date: 8/27/2008 6:41:05 PM

T ACCEPT - DONE (7/17 change to "path")

"logical link" is a term for what's on the wire, not what's inside an expander.)

This << circuit >> should be << logical link >> as circuit is not defined and logical link is.

Author: lsi-bday
Subject: Highlight
Date: 9/1/2008 4:29:41 PM

T ACCEPT - DONE (

9/1 "received with Dword Received" is already a qualification, so just added " Deletable primitives are not included" in the XL receiver section defining that message.

7/9 use "or deletable primitive" which also covers ALIGNs)

BREAK

s/b

BREAK, MUX, NOTIFY,

or deletable primitive?

Author: lsi-gpenokie
Subject: Highlight
Date: 5/25/2008 9:12:30 PM

T REJECT (written as intended)

It seems like this << or >> should be << and >> but that would be a different requirement in that the state would do both a and b rather than have to pick either a or b. I'm not sure which was intended.

b) the expander phy is forwarding to an expander logical phy attached to a SATA phy,
the expander logical phy shall:

- a) send a SATA_ERROR with the Forward Dword request instead of the invalid dword or ERROR primitive; or
- b) delete the ERROR primitive or invalid dword.

If a CLOSE Received message is received, this state shall send a Forward Close request to the ECR with the argument from the CLOSE Received message.

If a BREAK Received message is received, this state shall send a Forward Break request to the ECR (see 7.15.10.3).

This state shall repeatedly send a Phy Status (Connection) response to the ECM.

7.15.10.2 Transition XL7:Connected to XL8:Close_Wait

This transition shall occur after receiving a Forward Close indication if a BREAK Received message has not been received.

7.15.10.3 Transition XL7:Connected to XL9:Break

This transition shall occur after sending a Forward Break request to the ECR.

7.15.10.4 Transition XL7:Connected to XL10:Break_Wait

This transition shall occur after receiving a Forward Break indication if a BREAK Received message has not been received.

7.15.11 XL8:Close_Wait state

7.15.11.1 State description

This state closes a connection and releases path resources.

Upon entry into this state, this state shall send a Transmit CLOSE message to the XL transmitter with the argument from the Forward Close indication, then shall request idle dwords be transmitted by repeatedly sending Transmit Idle Dword messages to the XL transmitter.

NOTE 72 - Possible livelock scenarios occur if the BREAK_REPLY method of responding to received BREAK primitive sequences is disabled and a phy transmits BREAK to break a connection (e.g., if its Close Timeout timer expires). Phys should respond to CLOSE faster than 1 ms to reduce susceptibility to this problem.

If a Dword Received message is received containing a valid dword except a BREAK or CLOSE primitive, this state shall send a Forward Dword request to the ECR containing that dword. During an STP connection, the expander device may expand or contract a repeated or continued primitive sequence (see 7.2.4).

If:

- a) an Invalid Dword Received message is received; and
- b) the expander logical phy is forwarding to an expander logical phy attached to a SAS logical link,

the expander logical phy shall:

- a) send an ERROR primitive with the Forward Dword request instead of the invalid dword; or
- b) delete the invalid dword.

If:

- a) an ERROR primitive is received with the Dword Received message or an Invalid Dword Received message is received; and
- b) the expander logical phy is forwarding to an expander phy attached to a SATA physical link,

Page: 384

● Author: lsi-gpenokie
Subject: Highlight
Date: 5/25/2008 9:12:45 PM
T REJECT (written as intended)

It seems like this << or >> should be << and >> but that would be a different requirement in that the state would do both a and b rather than have to pick either a or b. I'm not sure which was intended.

● Author: lsi-gpenokie
Subject: Cross-Out
Date: 6/30/2008 10:06:34 AM
T REJECT (it's used many times, and is introduced in the ECM arbitration requirements overview)

The term << path >> is not defined and could be deleted without losing anything.

● Author: lsi-bday
Subject: Highlight
Date: 9/1/2008 4:30:13 PM
T ACCEPT - DONE (
9/1 added " Deletable primitives are not included" in XL receiver section (see other comments)

7/9 use "or deletable primitive" which also covers ALIGNs)

BREAK
s/b
BREAK, MUX, NOTIFY,

or deletable primitive?

● Author: lsi-gpenokie
Subject: Highlight
Date: 5/25/2008 9:13:04 PM
T REJECT (written as intended)

It seems like this << or >> should be << and >> but that would be a different requirement in that the state would do both a and b rather than have to pick either a or b. I'm not sure which was intended.

the expander logical phy shall:

- a) send a SATA_ERROR with the Forward Dword request instead of the invalid dword or ERROR primitive; **or**
- b) delete the ERROR primitive or invalid dword.

If a CLOSE Received message is received, this state shall release path resources and send a Forward Close request to the ECR with the argument from the CLOSE Received message (see 7.15.11.2).

If a BREAK Received message is received, this state shall send a Forward Break request to the ECR (see 7.15.11.3).

This state shall repeatedly send a Phy Status (Connection) response to the ECM.

7.15.11.2 Transition XL8:Close_Wait to XL0:Idle

This transition shall occur after sending a Forward Close request to the ECR.

7.15.11.3 Transition XL8:Close_Wait to XL9:Break

This transition shall occur after sending a Forward Break request to the ECR.

7.15.11.4 Transition XL8:Close_Wait to XL10:Break_Wait

This transition shall occur after receiving a Forward Break indication if a BREAK Received message has not been received.

7.15.12 XL9:Break state

7.15.12.1 State description

This state closes the **connection if there is one and** releases all path resources associated with the connection.

~~This state shall send a Transmit BREAK message to the XL transmitter (see 7.15.12.2).~~

This state shall:

- a) send a Transmit BREAK_REPLY message to the XL transmitter if the BREAK_REPLY method of responding to received BREAK primitive sequences is enabled (see 7.12.5); and
- b) send a Transmit BREAK message to the XL transmitter if the BREAK_REPLY method of responding to received BREAK primitive sequences is disabled (see 7.12.5).

7.15.12.2 Transition XL9:Break to XL0:Idle

This transition shall occur after sending a Transmit BREAK message or a Transmit BREAK_REPLY message to the XL transmitter.

7.15.13 XL10:Break_Wait state

7.15.13.1 State description

This state closes the connection if there is one and releases path resources associated with the connection.

Upon entry into this state, this state shall:

- 1) send a Transmit BREAK message to the XL transmitter; and
- 2) initialize and start the Break Timeout timer.

If a BREAK Received message is **received and** the BREAK_REPLY method of responding to received BREAK primitive sequences is enabled (see 7.12.5), then this state shall send a Transmit BREAK_REPLY message to the XL transmitter.

Page: 385

Author: Isi-gpenokie
Subject: Highlight
Date: 5/25/2008 9:13:20 PM
T REJECT (written as intended)

It seems like this << or >> should be << and >> but that would be a different requirement in that the state would do both a and b rather than have to pick either a or b. I'm not sure which was intended.

Author: wdc-mevans
Subject: Highlight
Date: 5/30/2008 6:27:57 PM
T ACCEPT - DONE

connection if there is one and
s/b
connection, if there is one, and

Author: elx-bmartin
Subject: Cross-Out
Date: 5/6/2008 4:07:49 PM
T ACCEPT - DONE

This state shall send a Transmit BREAK message to the XL transmitter (see 7.15.12.2).

This sentence should be deleted as it was replaced by the a-b list below.

Author: wdc-mevans
Subject: Highlight
Date: 5/22/2008 4:34:06 PM
T ACCEPT - DONE

connection if there is one and
s/b
connection, if there is one, and

Author: elx-bmartin
Subject: Comment on Text
Date: 9/1/2008 7:02:47 PM

T ACCEPT - DONE (7/15 although the crossbar resources can be released, cannot tell the ECM that the phy itself is free yet, so must continue sending Phy Status indicating that the phy is occupied. Add a new Phy Status (Breaking Connection) and ensure the ECM text uses it everywhere it uses the other Phy Statuses.

6/18 this state doesn't forward anymore starting on entry... so resources can be released immediately)

This state cannot release all resources until a BREAK or BREAK_REPLY has been received. This requirement should be moved into the transition XL10:XL0

Additionally,

This state shall repeatedly send:

- a) Phy Status (Connection) response to the ECM if this state was entered from XL8 or XL7;
 - b) Phy Status (Partial Pathway) response to the ECM if this state was entered from XL3 or XL6 and an AIP Received (Waiting On Partial) message was not received; or
 - c) Phy Status (Blocked Partial Pathway) response to the ECM if this state was entered from XL3 or XL6 and an AIP Received (Waiting On Partial) message was received.
-

Author: wdc-mevans
Subject: Highlight
Date: 5/25/2008 9:14:04 PM
T REJECT (2 things ANDED)

received and

Comments from page 385 continued on next page

the expander logical phy shall:

- a) send a SATA_ERROR with the Forward Dword request instead of the invalid dword or ERROR primitive; **or**
- b) delete the ERROR primitive or invalid dword.

If a CLOSE Received message is received, this state shall release path resources and send a Forward Close request to the ECR with the argument from the CLOSE Received message (see 7.15.11.2).

If a BREAK Received message is received, this state shall send a Forward Break request to the ECR (see 7.15.11.3).

This state shall repeatedly send a Phy Status (Connection) response to the ECM.

7.15.11.2 Transition XL8:Close_Wait to XL0:Idle

This transition shall occur after sending a Forward Close request to the ECR.

7.15.11.3 Transition XL8:Close_Wait to XL9:Break

This transition shall occur after sending a Forward Break request to the ECR.

7.15.11.4 Transition XL8:Close_Wait to XL10:Break_Wait

This transition shall occur after receiving a Forward Break indication if a BREAK Received message has not been received.

7.15.12 XL9:Break state

7.15.12.1 State description

This state closes the **connection if there is one and** releases all path resources associated with the connection.

~~This state shall send a Transmit BREAK message to the XL transmitter (see 7.15.12.2).~~

This state shall:

- a) send a Transmit BREAK_REPLY message to the XL transmitter if the BREAK_REPLY method of responding to received BREAK primitive sequences is enabled (see 7.12.5); and
- b) send a Transmit BREAK message to the XL transmitter if the BREAK_REPLY method of responding to received BREAK primitive sequences is disabled (see 7.12.5).

7.15.12.2 Transition XL9:Break to XL0:Idle

This transition shall occur after sending a Transmit BREAK message or a Transmit BREAK_REPLY message to the XL transmitter.

7.15.13 XL10:Break_Wait state

7.15.13.1 State description

This state closes the connection if there is one and releases path resources associated with the connection.

Upon entry into this state, this state shall:

- 1) send a Transmit BREAK message to the XL transmitter; and
- 2) initialize and start the Break Timeout timer.

If a BREAK Received message is **received and** the BREAK_REPLY method of responding to received BREAK primitive sequences is enabled (see 7.12.5), then this state shall send a Transmit BREAK_REPLY message to the XL transmitter.

s/b
received, and

7.15.13.2 Transition XL10:Break_Wait to XL0:Idle

This transition shall occur after:

- a BREAK_REPLY Received message is received if the BREAK_REPLY method of responding to received BREAK primitive sequences is enabled (see 7.12.5);
- a BREAK Received message is received if the BREAK_REPLY method of responding to received BREAK primitive sequences is disabled (see 7.12.5); or
- the Break Timeout timer expires.

7.16 SSP link layer

7.16.1 Opening an SSP connection

An SSP phy that accepts a connection request (i.e., an OPEN address frame) shall transmit at least one RRDY in that connection within 1 ms of transmitting an OPEN_ACCEPT. If the SSP phy is not able to grant credit, it shall respond with OPEN_REJECT (RETRY) and not accept the connection request.

To prevent livelocks (e.g., where ports are waiting on each other to accept a connection request):

- a SAS phy shall not reject an incoming connection request to an SSP initiator port with OPEN_REJECT (RETRY) because the SAS port containing that SAS phy needs an outgoing connection request to be accepted (e.g., if the SAS phy is used by an SSP initiator port and an SSP target port, they share a buffer, that buffer is being used by the SSP target port, and the SSP target port needs to transmit a frame to another SSP initiator port before it is able to free that buffer);
- a SAS phy may reject an incoming connection request to an SSP initiator port with OPEN_REJECT (RETRY) for any reason that is not dependent on the SAS port containing that SAS phy having an outgoing connection request accepted (e.g., a temporary buffer full condition); and
- a SAS phy may reject an incoming connection request to an SSP target port with OPEN_REJECT (RETRY) for any reason, including because the SAS port containing that SAS phy needs an outgoing connection request to be accepted (e.g., to transmit a frame and empty a buffer).

7.16.2 Full duplex

SSP is a full duplex protocol. An SSP phy may receive an SSP frame or primitive in a connection while it is transmitting an SSP frame or primitive in the same connection. A wide SSP port may send and/or receive SSP frames or primitives concurrently on different connections (i.e., on different phys).

When a connection is open and an SSP phy has no more SSP frames to transmit on that connection, it transmits a DONE to start closing the connection (see 8.2.2.3.5). The other direction may still be active, so the DONE may be followed by one or more of the following primitives: CREDIT_BLOCKED, RRDY, ACK, or NAK.

7.16.3 SSP frame transmission and reception

During an SSP connection, SSP frames are preceded by SOF and followed by EOF as shown in figure 189.

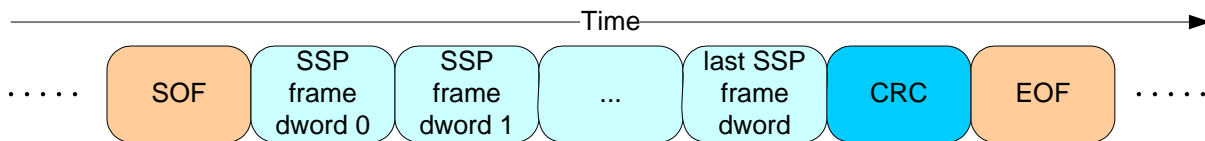

Figure 189 — SSP frame transmission

The last data dword after the SOF prior to the EOF always contains a CRC (see 7.5). The SSP link layer state machine checks that the frame is not too short and that the CRC is valid (see 7.16.8.7).

Receiving SSP phys shall acknowledge SSP frames within 1 ms, if not discarded as described in 7.16.8.7, with either:

- ACK (i.e., positive acknowledgement) if the SSP frame was received into a frame buffer without errors; or

Page: 386

Author: elx-bmartin

Subject: Highlight

Date: 5/25/2008 9:14:18 PM

T REJECT (if BREAKs are having trouble, give up on the phy altogether. I think that is mentioned elsewhere)

c) the Break Timeout timer expires.

If the Break Timeout timer expires, should another BREAK be sent. If another BREAK is not sent, and what was lost was the BREAK, then you still have part of the path tied up in a connection.

Author: wdc-mevans

Subject: Highlight

Date: 5/25/2008 9:14:44 PM

T REJECT (first noun/subject convention, but added "then" even though not requested)

it
s/b
the SSP phy

Author: stx-goulder

Subject: Highlight

Date: 5/25/2008 9:15:15 PM

T REJECT (5/5 fine as is)

shall not reject

This "shall not" case is OK, but there doesn't seem to be any recommendation of what should be done in this situation. Shouldn't such a recommendation be added?

Author: wdc-mevans

Subject: Highlight

Date: 5/25/2008 9:15:30 PM

T REJECT (Isi-gpenokie would then complain)

needs
s/b
requires

Author: wdc-mevans

Subject: Highlight

Date: 5/25/2008 9:15:38 PM

T REJECT (Isi-gpenokie would then complain)

needs
s/b
requires

Author: Isi-gpenokie

Subject: Highlight

Date: 6/2/2008 10:23:11 AM

T REJECT (nothing wrong with "because")

This << including because the SAS port containing >> should be << including the case were the SAS port containing >>

Author: wdc-mevans

Subject: Highlight

Date: 5/25/2008 9:16:26 PM

T ACCEPT - DONE

it
s/b
the SSP phy

Comments from page 386 continued on next page

7.15.13.2 Transition XL10:Break_Wait to XL0:Idle

This transition shall occur after:

- a BREAK_REPLY Received message is received if the BREAK_REPLY method of responding to received BREAK primitive sequences is enabled (see 7.12.5);
- a BREAK Received message is received if the BREAK_REPLY method of responding to received BREAK primitive sequences is disabled (see 7.12.5); or
- the Break Timeout timer expires.

7.16 SSP link layer

7.16.1 Opening an SSP connection

An SSP phy that accepts a connection request (i.e., an OPEN address frame) shall transmit at least one RRDY in that connection within 1 ms of transmitting an OPEN_ACCEPT. If the SSP phy is not able to grant credit, it shall respond with OPEN_REJECT (RETRY) and not accept the connection request.

To prevent livelocks (e.g., where ports are waiting on each other to accept a connection request):

- a SAS phy shall not reject an incoming connection request to an SSP initiator port with OPEN_REJECT (RETRY) because the SAS port containing that SAS phy needs an outgoing connection request to be accepted (e.g., if the SAS phy is used by an SSP initiator port and an SSP target port, they share a buffer, that buffer is being used by the SSP target port, and the SSP target port needs to transmit a frame to another SSP initiator port before it is able to free that buffer);
- a SAS phy may reject an incoming connection request to an SSP initiator port with OPEN_REJECT (RETRY) for any reason that is not dependent on the SAS port containing that SAS phy having an outgoing connection request accepted (e.g., a temporary buffer full condition); and
- a SAS phy may reject an incoming connection request to an SSP target port with OPEN_REJECT (RETRY) for any reason, including because the SAS port containing that SAS phy needs an outgoing connection request to be accepted (e.g., to transmit a frame and empty a buffer).

7.16.2 Full duplex

SSP is a full duplex protocol. An SSP phy may receive an SSP frame or primitive in a connection while it is transmitting an SSP frame or primitive in the same connection. A wide SSP port may send and/or receive SSP frames or primitives concurrently on different connections (i.e., on different phys).

When a connection is open and an SSP phy has no more SSP frames to transmit on that connection, it transmits a DONE to start closing the connection (see 8.2.2.3.5). The other direction may still be active, so the DONE may be followed by one or more of the following primitives: CREDIT_BLOCKED, RRDY, ACK, or NAK.

7.16.3 SSP frame transmission and reception

During an SSP connection, SSP frames are preceded by SOF and followed by EOF as shown in figure 189.

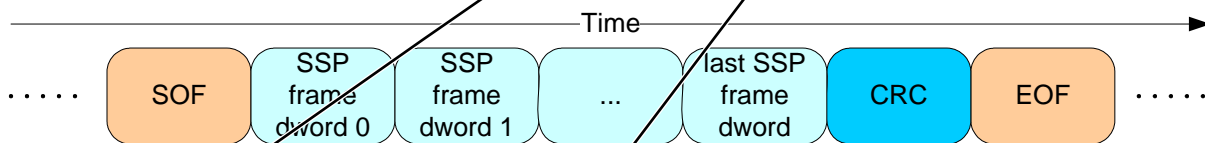

Figure 189 — SSP frame transmission

The last data dword after the SOF prior to the EOF always contains a CRC (see 7.5). The SSP link layer state machine checks that the frame is not too short and that the CRC is valid (see 7.16.8.7).

Receiving SSP phys shall acknowledge SSP frames within 1 ms, if not discarded as described in 7.16.8.7, with either:

- ACK (i.e., positive acknowledgement) if the SSP frame was received into a frame buffer without errors; or

● Author: wdc-mevans
Subject: Highlight
Date: 5/25/2008 9:15:52 PM
T REJECT (2 things ANDED)

open and
s/b
open, and

● Author: lsi-gpenokie
Subject: Highlight
Date: 5/25/2008 9:16:01 PM
T ACCEPT - DONE

This << following primitives: CREDIT_BLOCKED, RRDY, ACK, or NAK. >> should be made into an a,b,c list.

● Author: lsi-bday
Subject: Highlight
Date: 5/30/2008 6:30:12 PM

T ACCEPT - DONE (although this may cause some confusion that the link layer needs to parse the frame type... all it check is the gross length boundaries)

not too short
suggest:
a valid length

● Author: stx-goulder
Subject: Note
Date: 6/30/2008 10:10:48 AM

T ACCEPT - DONE (added:
Other primitives (e.g., CREDIT_BLOCKED, RRDY, ACK, and NAK) may be interspersed between the SOF, data dwords, and EOF.
)

Since I don't see this rule anywhere else, we should insert this sentence here:
"Other primitives may be interspersed during the connection."

- b) NAK (CRC ERROR) (i.e., negative acknowledgement) if the SSP frame was received with a CRC error (i.e., a bad CRC), an invalid dword, or an ERROR primitive.

NOTE 73 - It is not required that frame recipients generate NAK (CRC ERROR) from invalid dwords and ERRORS (see 7.16.8.2).

Either the transport layer (see 9.2.4) retries sending SSP frames that encounter a link layer error (e.g., are NAKed or create an ACK/NAK timeout), or the application layer aborts the SCSI command associated with the SSP frame that encountered a link layer error.

7.16.4 SSP flow control

An SSP phy uses RRDY to grant credit for permission for the other SSP phy in the connection to transmit frames. Each RRDY increments credit by one frame. Frame transmission decrements credit by one frame. Credit of zero frames is established at the beginning of each connection.

SSP phys shall not increment credit past 255 frames.

To prevent deadlocks where an SSP initiator port and SSP target port are both waiting on each other to provide credit, an SSP initiator port shall not refuse to provide credit by withholding RRDY because it needs to transmit a frame itself. It may refuse to provide credit for other reasons (e.g., temporary buffer full conditions).

An SSP target port may refuse to provide credit for any reason, including because it needs to transmit a frame itself.

If credit is zero, SSP phys that are going to be unable to provide credit for 1 ms may send CREDIT_BLOCKED. The other phy may use this to avoid waiting 1 ms to transmit DONE (CREDIT_TIMEOUT) (see 7.16.8).

If credit is nonzero, SSP phys that are going to be unable to provide additional credit for 1 ms, even if they receive frames per the existing credit, may transmit CREDIT_BLOCKED.

After sending CREDIT_BLOCKED, an SSP phy shall not transmit any additional RRDYs in the connection.

7.16.5 Interlocked frames

Table 154 shows which SSP frames shall be interlocked and which are non-interlocked.

Table 154 — SSP frame interlock requirements

SSP frame type	Interlock requirement
COMMAND	Interlocked
TASK	Interlocked
XFER_RDY	Interlocked
DATA	Non-interlocked
RESPONSE	Interlocked
See 9.2 for SSP frame type definitions.	

Before transmitting an interlocked frame, an SSP phy shall wait for all SSP frames to be acknowledged with ACK or NAK, even if credit is available. After transmitting an interlocked frame, an SSP phy shall not transmit another SSP frame until it has been acknowledged with ACK or NAK, even if credit is available.

Before transmitting a non-interlocked frame, an SSP phy shall wait for:

- a) all non-interlocked frames with different tags; and
- b) all interlocked frames;

to be acknowledged with ACK or NAK, even if credit is available.

● Author: Isi-gpenokie
Subject: Highlight
Date: 5/25/2008 9:16:53 PM
T REJECT (that rule is elsewhere, this is just pointing it out)

This note << NOTE 73 - It is not required >> should be normative text.

● Author: stx-goulder
Subject: Highlight
Date: 5/25/2008 9:17:04 PM
T ACCEPT - DONE

application layer
Should be "SCSI application layer".

● Author: wdc-mevans
Subject: Highlight
Date: 5/25/2008 9:17:17 PM
T REJECT (having a frame to transmit, with no concerns about when, is weaker than needing to transmit)

it needs to transmit a frame itself
s/b
the SSP initiator port has a frame to transmit

● Author: wdc-mevans
Subject: Highlight
Date: 5/30/2008 6:30:42 PM
T ACCEPT - DONE

It
s/b
An SSP initiator port

● Author: Isi-gpenokie
Subject: Highlight
Date: 5/25/2008 9:17:57 PM
T REJECT (nothing wrong with "because")

This << reason, including because it needs to transmit >> should be << reason, including the case were it needs to transmit >>

● Author: wdc-mevans
Subject: Highlight
Date: 5/30/2008 6:31:48 PM
T REJECT ("it" follows the first noun/subject convention. "needs to transmit" is quite different than "has a frame to transmit. Only the "need" causes livelocks.)

it needs to transmit a frame itself
s/b
the SSP target port has a frame to transmit

● Author: wdc-mevans
Subject: Highlight
Date: 5/22/2008 4:21:30 PM
T ACCEPT - DONE (as "that interlocked frame")

it
s/b
the frame

● Author: stx-goulder
Subject: Highlight

- b) NAK (CRC ERROR) (i.e., negative acknowledgement) if the SSP frame was received with a CRC error (i.e., a bad CRC), an invalid dword, or an ERROR primitive.

NOTE 73 - It is not required that frame recipients generate NAK (CRC ERROR) from invalid dwords and ERRORS (see 7.16.8.2).

Either the transport layer (see 9.2.4) retries sending SSP frames that encounter a link layer error (e.g., are NAKed or create an ACK/NAK timeout), or the application layer aborts the SCSI command associated with the SSP frame that encountered a link layer error.

7.16.4 SSP flow control

An SSP phy uses RRDY to grant credit for permission for the other SSP phy in the connection to transmit frames. Each RRDY increments credit by one frame. Frame transmission decrements credit by one frame. Credit of zero frames is established at the beginning of each connection.

SSP phys shall not increment credit past 255 frames.

To prevent deadlocks where an SSP initiator port and SSP target port are both waiting on each other to provide credit, an SSP initiator port shall not refuse to provide credit by withholding RRDY because it needs to transmit a frame itself. It may refuse to provide credit for other reasons (e.g., temporary buffer full conditions).

An SSP target port may refuse to provide credit for any reason, including because it needs to transmit a frame itself.

If credit is zero, SSP phys that are going to be unable to provide credit for 1 ms may send CREDIT_BLOCKED. The other phy may use this to avoid waiting 1 ms to transmit DONE (CREDIT TIMEOUT) (see 7.16.8).

If credit is nonzero, SSP phys that are going to be unable to provide additional credit for 1 ms, even if they receive frames per the existing credit, may transmit CREDIT_BLOCKED.

After sending CREDIT_BLOCKED, an SSP phy shall not transmit any additional RRDYs in the connection.

7.16.5 Interlocked frames

Table 154 shows which SSP frames shall be interlocked and which are non-interlocked.

Table 154 — SSP frame interlock requirements

SSP frame type	Interlock requirement
COMMAND	Interlocked
TASK	Interlocked
XFER_RDY	Interlocked
DATA	Non-interlocked
RESPONSE	Interlocked
See 9.2 for SSP frame type definitions.	

Before transmitting an interlocked frame, an SSP phy shall wait for all SSP frames to be acknowledged with ACK or NAK, even if credit is available. After transmitting an interlocked frame, an SSP phy shall not transmit another SSP frame until it has been acknowledged with ACK or NAK, even if credit is available.

Before transmitting a non-interlocked frame, an SSP phy shall wait for:

- a) all non-interlocked frames with different tags; and
- b) all interlocked frames;

to be acknowledged with ACK or NAK, even if credit is available.

Date: 5/25/2008 9:18:19 PM

T ACCEPT - DONE (initiator port transfer tags)

tags

This is an ambiguous tag reference.

Author: lsi-gpenokie

Subject: Highlight

Date: 5/22/2008 4:21:49 PM

T ACCEPT - DONE

This << interlocked frame; >> should be << interlocked frame, >>. The semicolon should be a comma.

After transmitting a non-interlocked frame, an SSP phy may transmit another non-interlocked frame with the same tag if credit is available. The phy shall not transmit:

- a) a non-interlocked frame with a different tag; or
- b) an interlocked frame;

until all SSP frames have been acknowledged with ACK or NAK, even if credit is available.

Interlocking does not prevent transmitting and receiving interlocked frames simultaneously (e.g., an SSP initiator phy could be transmitting a COMMAND frame while receiving XFER_RDY, DATA, or RESPONSE frames for a different command).

An SSP phy may transmit primitives responding to traffic it is receiving (e.g., an ACK or NAK to acknowledge an SSP frame, an RRDY to grant more receive credit, or a CREDIT_BLOCKED to specify that no more RRDYs are going to be transmitted in the connection) while waiting for an interlocked frame it transmitted to be acknowledged. These primitives may also be interspersed within an SSP frame.

Figure 190 shows an example of interlocked frame transmission.

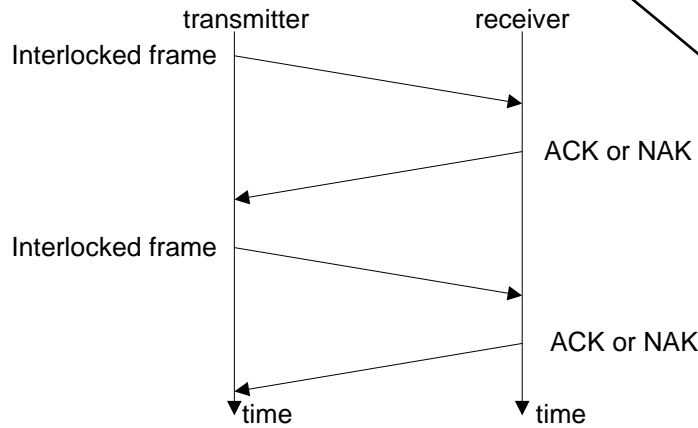

Figure 190 — Interlocked frames

Figure 191 shows an example of non-interlocked frame transmission with the same tags.

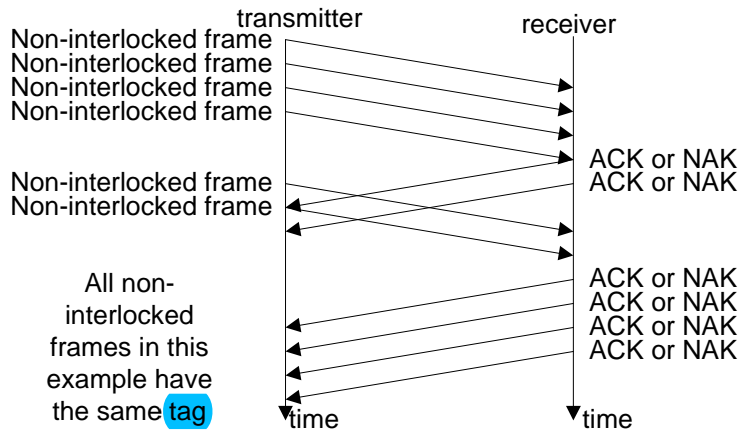

Figure 191 — Non-interlocked frames with the same tag

Page: 388

Author: stx-goulder
Subject: Highlight
Date: 5/25/2008 9:18:39 PM
ACCEPT - DONE (initiator port transfer tag)

tag

Is this a reference to INITIATOR CONNECTION TAG field, or TAG field, or combination of the values in the INITIATOR PORT bit, the PROTOCOL field, the INITIATOR CONNECTION TAG field, and/or the FEATURES field in the OPEN address frame? There are a number of other instances of "tag" that are similarly ambiguous and probably mean a different "tag". Some are arguments. The different tag uses should have a defined term for each or change to referencing a specific TAG field instead.

Author: stx-goulder
Subject: Highlight
Date: 5/25/2008 9:18:48 PM
ACCEPT - DONE (target port transfer tag)

tag

This is an ambiguous tag reference.

Author: lsi-gpenokie
Subject: Highlight
Date: 5/25/2008 9:19:01 PM
ACCEPT - DONE

This << interlocked frame; >> should be << interlocked frame, >>. The semicolon should be a comma.

Author: wdc-mevans
Subject: Highlight
Date: 6/2/2008 10:24:05 AM
ACCEPT - DONE (with "possible" rather than "permissible")

an SSP initiator phy could be transmitting

s/b

it is permissible for an SSP initiator phy to transmit

Author: wdc-mevans
Subject: Highlight
Date: 5/22/2008 4:22:26 PM
REJECT (first noun/subject convention, but added "that")

it

s/b

the SSP phy

Author: wdc-mevans
Subject: Highlight
Date: 5/30/2008 6:32:34 PM
REJECT (first noun/subject convention, but added "that")

it

s/b

that the SSP phy

Author: lsi-gpenokie
Subject: Highlight
Date: 5/30/2008 6:32:50 PM
REJECT (first noun/subject convention, but added "that")

This << interlocked frame it transmitted to >> should be << interlocked frame the SSP phy transmitted to >>

Comments from page 388 continued on next page

After transmitting a non-interlocked frame, an SSP phy may transmit another non-interlocked frame with the same tag if credit is available. The phy shall not transmit:

- a) a non-interlocked frame with a different tag; or
- b) an interlocked frame;

until all SSP frames have been acknowledged with ACK or NAK, even if credit is available.

Interlocking does not prevent transmitting and receiving interlocked frames simultaneously (e.g., an SSP initiator phy could be transmitting a COMMAND frame while receiving XFER_RDY, DATA, or RESPONSE frames for a different command).

An SSP phy may transmit primitives responding to traffic it is receiving (e.g., an ACK or NAK to acknowledge an SSP frame, an RRDY to grant more receive credit, or a CREDIT_BLOCKED to specify that no more RRDYs are going to be transmitted in the connection) while waiting for an interlocked frame it transmitted to be acknowledged. These primitives may also be interspersed within an SSP frame.

Figure 190 shows an example of interlocked frame transmission.

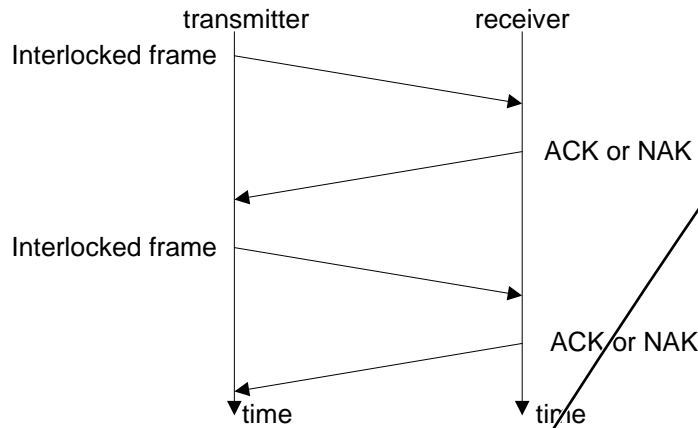

Figure 190 — Interlocked frames

Figure 191 shows an example of non-interlocked frame transmission with the same tags.

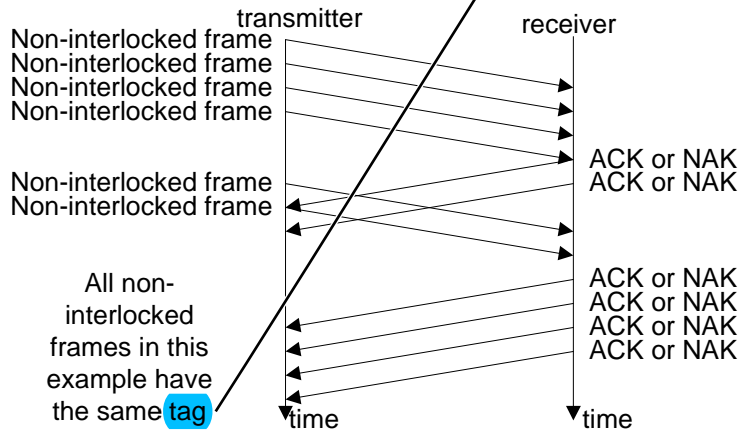

Figure 191 — Non-interlocked frames with the same tag

Author: stx-goulder
Subject: Highlight
Date: 5/25/2008 9:19:33 PM
ACCEPT - DONE (initiator port transfer tag)

tag

This is an ambiguous tag reference.

Author: stx-goulder
Subject: Highlight
Date: 5/25/2008 9:19:37 PM
ACCEPT - DONE (initiator port transfer tag)

tag

This is an ambiguous tag reference.

Figure 192 shows an example of non-interlocked frame transmission with different tags.

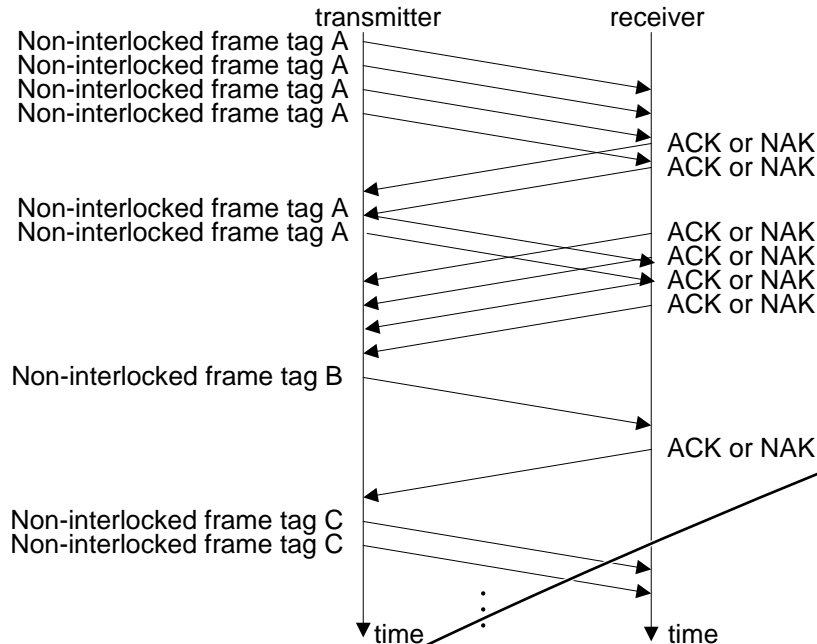

Figure 192 — Non-interlocked frames with different tags

7.16.6 Breaking an SSP connection

In addition to the actions described in 7.12.8, the following shall be the responses by an SSP phy to a broken connection:

- Received frames having no CRC error may be considered valid regardless of whether an ACK has been transmitted in response to the frame prior to the broken connection;
- Transmitted frames for which an ACK has been received prior to a broken connection shall be considered successfully transmitted; and
- Transmitted frames for which an ACK or NAK has not been received prior to a broken connection shall be considered not successfully transmitted.

7.16.7 Closing an SSP connection

DONE shall be exchanged prior to closing an SSP connection (see 8.2.2.3.5). There are several versions of the DONE primitive indicating additional information about why the SSP connection is being closed:

- DONE (NORMAL) specifies normal completion; the transmitter has no more SSP frames to transmit;
- DONE (CREDIT TIMEOUT) specifies that the transmitter still has SSP frames to transmit but did not receive an RRDY granting frame credit within 1 ms, or the transmitter has received a CREDIT_BLOCKED and has consumed all RRDYs received; and
- DONE (ACK/NAK TIMEOUT) specifies that the transmitter transmitted an SSP frame but did not receive the corresponding ACK or NAK within 1 ms. As a result, the ACK/NAK count is not balanced and the transmitter is going to transmit a BREAK in 1 ms unless the recipient replies with DONE and the connection is closed.

If the transmitter has no more SSP frames to transmit and receives a CREDIT_BLOCKED, it may transmit either DONE (NORMAL) or DONE (CREDIT TIMEOUT).

After transmitting DONE, the transmitting phy initializes and starts a 1 ms DONE Timeout timer (see 7.16.8.5).

After transmitting DONE, the transmitting phy shall not transmit any more SSP frames during this connection. However, the phy may transmit ACK, NAK, RRDY, and CREDIT_BLOCKED as needed after transmitting DONE if the other phy is still transmitting SSP frames in the reverse direction. Once an SSP phy has both transmitted and received DONE, it shall close the connection by transmitting CLOSE (NORMAL) (see 7.12.7).

Page: 389

● Author: stx-goulder
Subject: Highlight
Date: 5/25/2008 9:19:51 PM
T ACCEPT - DONE (initiator port transfer tag)

tag
This is an ambiguous tag reference.

● Author: lsi-gpenokie
Subject: Sticky Note
Date: 6/30/2008 2:32:48 PM
T ACCEPT - DONE (Created .txt version of standard and did regexp search for [a-z] [A-Z] in gvim. Added comments by all other instances found.)

Global
This standard uses the convention that a.b.c lists should not have the first word capitalized unless it would be capitalized to other reasons. This list does not comply to that convention and should be fixed.

● Author: lsi-gpenokie
Subject: Highlight
Date: 8/30/2008 12:09:28 PM
T ACCEPT - DONE (as "The type of DONE indicates additional information about why the SSP connection is being closed as follows:" 08-343 asked to remove "primitive." 7/17 work in the "the following")

This << There are several versions of the DONE primitive indicating >> should be << The follow is a list of versions of the DONE primitive that indicate >>

● Author: lsi-gpenokie
Subject: Highlight
Date: 5/30/2008 6:34:21 PM
T ACCEPT - DONE (but swapped the i.e. like this: "that the transmitter has no more SSP frames to transmit (i.e., normal completion)")

This << completion; the transmitter has no more SSP frames to transmit >> should be << completion (i.e., the transmitter has no more SSP frames to transmit) >>

● Author: wdc-mevans
Subject: Highlight
Date: 5/25/2008 9:20:38 PM
T REJECT (first noun/subject convention, but added "then" which was not requested)

it
s/b
the transmitter

● Author: wdc-mevans
Subject: Highlight
Date: 5/25/2008 9:20:54 PM
T REJECT (first noun/subject convention)

it
s/b
the phy

Figure 193 shows the sequence for a closing an SSP connection.

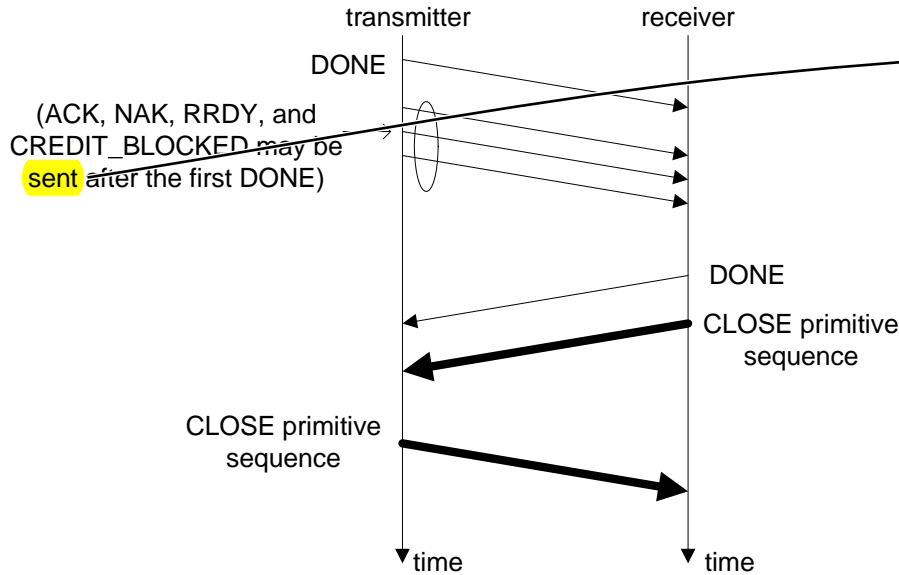

Figure 193 — Closing an SSP connection example

7.16.8 SSP (link layer for SSP phys) state machines

7.16.8.1 SSP state machines overview

The SSP link layer contains several state machines that run in parallel to control the flow of dwords on the physical link during an SSP connection. The SSP state machines are as follows:

- SSP_TIM (transmit interlocked frame monitor) state machine (see 7.16.8.3);
- SSP_TCM (transmit frame credit monitor) state machine (see 7.16.8.4);
- SSP_D (DONE control) state machine (see 7.16.8.5);
- SSP_TF (transmit frame control) state machine (see 7.16.8.6);
- SSP_RF (receive frame control) state machine (see 7.16.8.7);
- SSP_RCM (receive frame credit monitor) state machine (see 7.16.8.8);
- SSP_RIM (receive interlocked frame monitor) state machine (see 7.16.8.9);
- SSP_TC (transmit credit control) state machine (see 7.16.8.10); and
- SSP_TAN (transmit ACK/NAK control) state machine (see 7.16.8.11).

All the SSP state machines shall start after receiving an Enable Disable SSP (Enable) message from the SL state machines (see 7.14).

All the SSP state machines shall terminate after:

- receiving an Enable Disable SSP (Disable) message from the SL state machines;
- receiving a Request Close message from the SSP_D state machine indicating that the connection has been closed;
- receiving a Request Break message from the SSP_D state machine indicating that a BREAK has been transmitted; or
- receiving a NOTIFY Received (Power Loss Expected) message from the SP_DWS receiver if the SAS port that contains this state machine supports NOTIFY (Power Loss Expected) (e.g., the SAS port is a SSP target port).

If a state machine consists of multiple states the initial state is as indicated in the state machine description in this subclause.

● Author: RElliott
Subject: Highlight
Date: 6/30/2008 6:16:52 PM
T ACCEPT - DONE
sent
s/b
transmitted

● Author: wdc-mevans
Subject: Highlight
Date: 5/6/2008 4:07:49 PM
T ACCEPT - DONE
a SSP
s/b
an SSP

● Author: wdc-mevans
Subject: Highlight
Date: 5/25/2008 9:21:13 PM
T ACCEPT - DONE
states the
s/b
states, then the

The SSP state machines shall maintain the timers listed in table 155.

Table 155 — SSP link layer timers

Timer	Initial value	State machine	Reference
ACK/NAK Timeout timer	1 ms	SSP_TIM	7.16.8.3
DONE Timeout timer	1 ms	SSP_D	7.16.8.5
Credit Timeout timer	1 ms	SSP_TF	7.16.8.6

Author: RElliott
Subject: Highlight
Date: 8/30/2008 4:56:28 PM
ACCEPT - DONE



SSP link layer timers
s/b
SSP state machines timers

Figure 194 shows the SSP state machines and states related to frame transmission.

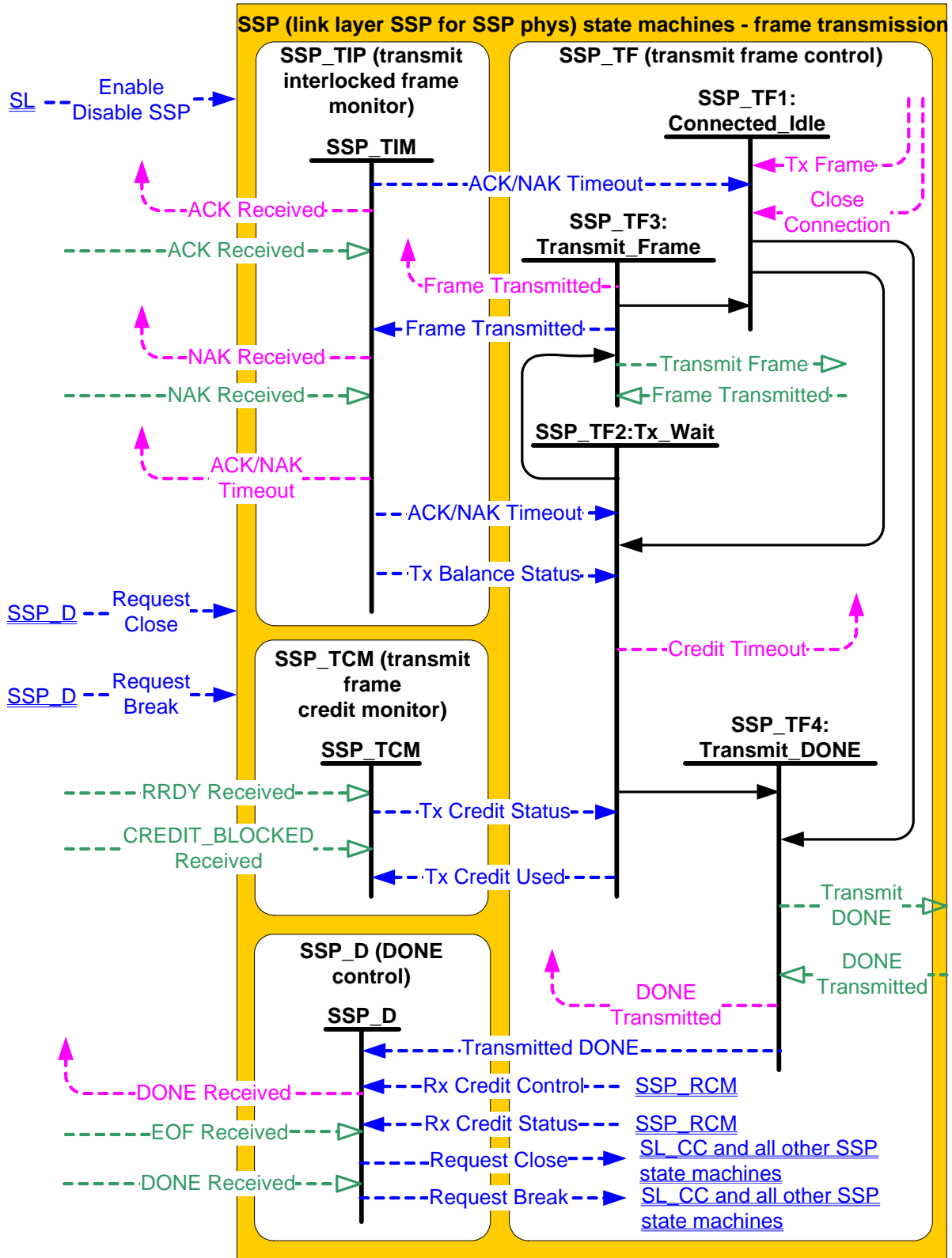

Figure 194 — SSP (link layer for SSP phys) state machines (part 1 - frame transmission)

This page contains no comments

Figure 195 shows the SSP state machines and states related to frame reception.

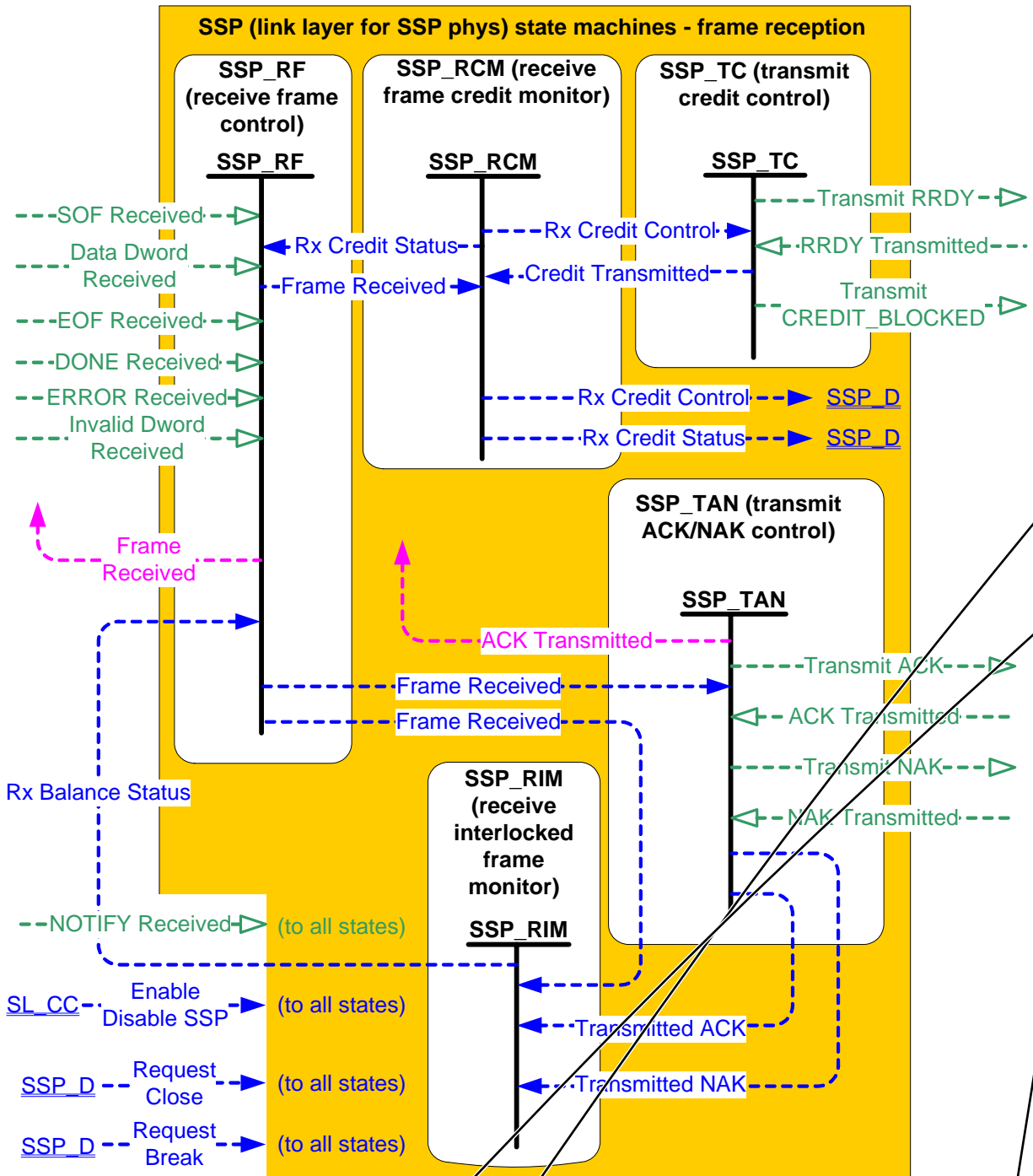

Figure 195 — SSP (link layer for SSP phys) state machines (part 2 - frame reception)

7.16.8.2 SSP transmitter and receiver

The SSP transmitter receives the following messages from the SSP state machines specifying primitive sequences and frames to transmit:

- a) Transmit RRDY with an argument indicating the specific type (e.g., Transmit RRDY (Normal));
- b) Transmit CREDIT_BLOCKED;
- c) Transmit ACK;

● Author: stx-goulder

Subject: Highlight

Date: 5/30/2008 6:34:46 PM

T REJECT (not the convention for "transmitter and receiver" sections)

(Normal)

Add "message" after this phrase.

● Author: stx-goulder

Subject: Highlight

Date: 5/30/2008 6:34:49 PM

T REJECT (not the convention for "transmitter and receiver" sections)

CREDIT_BLOCKED

Add "message" after this phrase.

● Author: stx-goulder

Subject: Highlight

Date: 5/30/2008 6:34:52 PM

T REJECT (not the convention for "transmitter and receiver" sections)

ACK

Add "message" after this phrase.

- d) Transmit NAK with an argument indicating the specific type (e.g., Transmit NAK (CRC Error));
- e) Transmit Frame with an argument containing the frame contents; and
- f) Transmit DONE with an argument indicating the specific type (e.g., Transmit DONE (Normal)).

In response to the Transmit Frame message, the SSP transmitter transmits:

- 1) SOF;
- 2) the frame contents;
- 3) CRC; and
- 4) EOF.

The SSP transmitter sends the following messages to the SSP state machines based on dwords that have been transmitted:

- a) DONE Transmitted;
- b) RRDY Transmitted;
- c) CREDIT_BLOCKED Transmitted;
- d) ACK Transmitted;
- e) NAK Transmitted; and
- f) Frame Transmitted.

When there is no outstanding message specifying a dword to transmit, the SSP transmitter shall transmit idle dwords.

The SSP receiver sends the following messages to the SSP state machines indicating primitive sequences and dwords received from the SP_DWS receiver (see 6.9.2):

- a) ACK Received;
- b) NAK Received;
- c) RRDY Received;
- d) CREDIT_BLOCKED Received;
- e) DONE Received with an argument indicating the specific type (e.g., DONE Received (Normal));
- f) SOF Received;
- g) Data Dword Received;
- h) EOF Received;
- i) NOTIFY Received (Power Loss Expected);
- j) ERROR Received; and
- k) Invalid Dword Received.

The SSP receiver shall ignore all other dwords.

The SSP transmitter relationship to other transmitters is defined in 4.3.2. The SSP receiver relationship to other receivers is defined in 4.3.3.

7.16.8.3 SSP_TIM (transmit interlocked frame monitor) state machine

The SSP_TIM state machine's function is to ensure that ACKs or NAKs are received for each transmitted frame before the ACK/NAK timeout. This state machine consists of one state.

This state machine monitors the number of frames transmitted with a Number Of Frames Transmitted counter and monitors the number of ACKs and NAKs received with a Number Of ACKs/NAKs Received counter. This state machine ensures that an ACK or NAK is received for each frame transmitted and reports an ACK/NAK timeout if they are not.

When the Number Of Frames Transmitted counter equals the Number Of ACKs/NAKs Received counter, the ACK/NAK count is balanced and this state machine shall send the Tx Balance Status (Balanced) message to the SSP_TF2:Tx_Wait state. When the Number Of Frames Transmitted counter does not equal the Number Of ACKs/NAKs Received counter, the ACK/NAK count is not balanced and this state machine shall send the Tx Balance Status (Not Balanced) message to the SSP_TF2:Tx_Wait state.

Each time a Frame Transmitted message is received, this state machine shall increment the Number Of Frames Transmitted counter.

Page: 394

● Author: stx-goulder
Subject: Highlight
Date: 5/30/2008 6:34:56 PM
T REJECT (not the convention for "transmitter and receiver" sections)

(CRC Error)
Add "message" after this phrase.

● Author: stx-goulder
Subject: Highlight
Date: 5/30/2008 6:34:59 PM
T REJECT (not the convention for "transmitter and receiver" sections)

(Normal)
Add "message" after this phrase.

● Author: wdc-mevans
Subject: Highlight
Date: 5/30/2008 6:37:16 PM
T REJECT (that would not match the 8 other similar paragraphs. "relationship" is the noun here, not "receiver", and there is not a multiplicity of relationships between state machine types)

The SSP receiver
s/b
An SSP receiver's

● Author: wdc-mevans
Subject: Highlight
Date: 5/30/2008 6:37:07 PM
T REJECT (that would not match the 8 other similar paragraphs. "relationship" is the noun here, not "transmitter", and there is not a multiplicity of relationships between state machine types)

The SSP transmitter
s/b
An SSP transmitter's

If the ACK/NAK count is not balanced, ~~each time an ACK Received message is received~~, this state machine shall:

- a) increment the Number Of ACKs/NAKs Received counter; and
- b) send an ACK Received confirmation to the port layer.

If the ACK/NAK count is not balanced, ~~each time a NAK Received message is received~~, this state machine shall:

- a) increment the Number Of ACKs/NAKs Received counter; and
- b) send a NAK Received confirmation to the port layer.

If the ACK/NAK count is balanced, ~~the ACK Received message and NAK Received message shall be ignored and the ACK/NAK Timeout timer shall be stopped.~~

~~Each time the ACK/NAK count is not balanced, the ACK/NAK Timeout timer shall be initialized and started. The ACK/NAK Timeout timer shall be re-initialized each time the Number Of ACKs/NAKs Received counter is incremented. If the ACK/NAK Timeout timer expires, this state machine shall send the ACK/NAK Timeout confirmation to the port layer and to the following states:~~

- a) SSP_TF1:Connected_Idle; and
- b) SSP_TF2:Tx_Wait state.

~~When this state machine receives an Enable Disable SSP (Enable) message, Request Close message, or Request Break message, the Number Of Frames Transmitted counter shall be set to zero and the Number Of ACKs/NAKs Received counter shall be set to zero.~~

7.16.8.4 SSP_TCM (transmit frame credit monitor) state machine

The SSP_TCM state machine's function is to ensure that transmit frame credit is available before a frame is transmitted. This state machine consists of one state.

This state machine shall keep track of the number of transmit frame credits available. This state machine shall add one transmit frame credit for each RRDY Received message received and subtract one transmit frame credit for each Tx Credit Used message received.

The CREDIT_BLOCKED Received message indicates that transmit frame credit is blocked. After receiving a CREDIT_BLOCKED Received message, this state machine may ignore additional RRDY Received messages until it receives a Request Close message or a Request Break message.

When transmit frame credit is available, this state machine shall send the Tx Credit Status (Available) message to the SSP_TF2:Tx_Wait state.

When transmit frame credit is not available and transmit frame credit is not blocked, this state machine shall send the Tx Credit Status (Not Available) message to the SSP_TF2:Tx_Wait state.

When transmit frame credit is not available and transmit frame credit is blocked, this state machine shall send the Tx Credit Status (Blocked) message to the SSP_TF2:Tx_Wait state.

When this state machine receives an Enable Disable SSP (Enable) message, a Request Close message, or a Request Break message, this state shall set transmit frame credit to not available and transmit frame credit shall be set to not blocked.

7.16.8.5 SSP_D (DONE control) state machine

The SSP_D state machine's function is to ensure a DONE has been received and transmitted before the SL_CC state machine disables the SSP state machines. This state machine consists of one state.

This state machine ensures that a DONE is received and transmitted before the connection is closed. The DONE may be transmitted and received in any order.

If the DONE Received message has been received before the Transmitted DONE message is received, ~~this~~ state machine shall send the Request Close message to the SL_CC state machine (see 7.14) and all the SSP state machines after receiving the Transmitted DONE message.

● Author: RElliott
Subject: Highlight
Date: 6/30/2008 6:16:52 PM
T ACCEPT - DONE
each
s/b
then each

● Author: RElliott
Subject: Highlight
Date: 6/30/2008 6:16:52 PM
T ACCEPT - DONE
each
s/b
then each

● Author: RElliott
Subject: Highlight
Date: 6/30/2008 6:16:52 PM
T ACCEPT - DONE
the
s/b
then the

● Author: RElliott
Subject: Highlight
Date: 6/30/2008 6:16:52 PM
T ACCEPT - DONE
this
s/b
then this

● Author: RElliott
Subject: Highlight
Date: 6/30/2008 6:16:52 PM
T ACCEPT - DONE
this
s/b
then this

If a DONE Received message, the Transmitted DONE (Normal) message, or the Transmitted DONE (Credit Timeout) message has not been received and the Rx Credit Status (Extended) message or the Rx Credit Control (Blocked) message has been received, then this state shall initialize and start the DONE Timeout timer after receiving the Transmitted DONE (Normal) message or the Transmitted DONE (Credit Timeout) message.

If the DONE Received message has not been received and the Transmitted DONE (Normal) message or the Transmitted DONE (Credit Timeout) message has been received, this state machine shall initialize and start the DONE Timeout timer each time:

- a) the Rx Credit Status (Extended) message is received; or
- b) the Rx Credit Control (Blocked) message is received.

If the Transmitted DONE (Normal) message or the Transmitted DONE (Credit Timeout) message has been received, the DONE Timeout timer shall be reinitialized each time the EOF Received message is received.

If the Transmitted DONE (Normal) message or the Transmitted DONE (Credit Timeout) message has been received, the DONE Timeout timer shall be stopped after:

- a) the Rx Credit Status (Exhausted) message is received; and
- b) the Rx Credit Control (Blocked) message has not been received.

NOTE 74 - Stopping the timer ensures that, if credit remains exhausted long enough that the Credit Timeout timer of the other phy in the connection expires, the other phy is able to transmit a DONE (CREDIT TIMEOUT).

If the DONE Received message has not been received and the Transmitted DONE (ACK/NAK Timeout) message has been received:

- a) this state machine shall initialize and start the DONE Timeout timer; and
- b) this state shall not reinitialize the DONE Timeout timer if an EOF Received message is received.

If the DONE Received message is received before the DONE Timeout timer expires, this state machine shall send the Request Close message to the SL_CC state machine and all the SSP state machines.

If the DONE Received message is not received before the DONE Timeout timer expires, this state machine shall send a Request Break message to the SL_CC state machine and all the SSP state machines.

Any time a DONE Received message is received this state machine shall send a DONE Received confirmation to the port layer. A DONE Received (ACK/NAK Timeout) confirmation informs the port layer that the SSP transmitter is going to close the connection within 1 ms; other DONE Received confirmations (e.g., DONE Received (Close Connection) and DONE Received (Credit Timeout)) may be used by the application layer to decide when to reuse tags.

NOTE 75 - The DONE Timeout timer in one phy (e.g., phy A) may expire concurrently with the ACK/NAK Timeout timer in the other phy (e.g., phy B) in a connection.

For example, if phy A receives DONE (NORMAL) indicating phy B has no more frames to transmit, and phy A then transmits a series of non-interlocked frames where one or more of the SOFs is corrupted, then phy A waits to receive all the ACKs and/or NAKs after transmitting the series of non-interlocked frames. However, since phy B did not receive the full number of SOFs, it does not transmit as many ACKs and/or NAKs as phy A is expecting. The ACK/NAK Timeout timer in phy A expires and phy A transmits DONE (ACK/NAK TIMEOUT). Meanwhile, despite having transmitted DONE, phy B stops receiving frames while phy A is waiting for the final ACKs and/or NAKs. Since phy B does not receive DONE or any more frames, its DONE Timeout timer expires and phy B transmits BREAK.

Since the timers may expire at slightly different times (e.g., due to timer resolution differences), the DONE (ACK/NAK TIMEOUT) may be transmitted before, concurrently with, or after the BREAK. Nevertheless, the phys handle the link layer error (i.e., the ACK/NAK timeout or the DONE timeout) the same way (see 9.2.4.5).

Page: 396

Author: wdc-mevans
Subject: Highlight
Date: 5/25/2008 9:22:22 PM
T ACCEPT - DONE

the
s/b
a

Author: wdc-mevans
Subject: Highlight
Date: 5/25/2008 9:22:14 PM
T ACCEPT - DONE (and many more times in this section; wherever message names appear, "the" was changed to "a" or "an)

the
s/b
a

Author: wdc-mevans
Subject: Highlight
Date: 5/22/2008 10:04:37 AM
T REJECT (2 things being ANDED)

received and
s/b
received, and

Author: wdc-mevans
Subject: Highlight
Date: 5/30/2008 6:38:17 PM
T REJECT (2 things ANDED together)

received and
s/b
received, and

Author: RElliott
Subject: Highlight
Date: 6/30/2008 6:16:52 PM
T ACCEPT - DONE

this
s/b
then this

Author: RElliott
Subject: Highlight
Date: 6/30/2008 6:16:52 PM
T ACCEPT - DONE

the
s/b
then the

Author: RElliott
Subject: Highlight
Date: 6/30/2008 6:16:52 PM
T ACCEPT - DONE

the
s/b
then the

Comments from page 396 continued on next page

If a DONE Received message, the Transmitted DONE (Normal) message, or the Transmitted DONE (Credit Timeout) message has not been received and the Rx Credit Status (Extended) message or the Rx Credit Control (Blocked) message has been received, then this state shall initialize and start the DONE Timeout timer after receiving the Transmitted DONE (Normal) message or the Transmitted DONE (Credit Timeout) message.

If the DONE Received message has not been received and the Transmitted DONE (Normal) message or the Transmitted DONE (Credit Timeout) message has been received, this state machine shall initialize and start the DONE Timeout timer each time:

- a) the Rx Credit Status (Extended) message is received; or
- b) the Rx Credit Control (Blocked) message is received.

If the Transmitted DONE (Normal) message or the Transmitted DONE (Credit Timeout) message has been received, the DONE Timeout timer shall be reinitialized each time the EOF Received message is received.

If the Transmitted DONE (Normal) message or the Transmitted DONE (Credit Timeout) message has been received, the DONE Timeout timer shall be stopped after:

- a) the Rx Credit Status (Exhausted) message is received; and
- b) the Rx Credit Control (Blocked) message has not been received.

NOTE 74 - Stopping the timer ensures that, if credit remains exhausted long enough that the Credit Timeout timer of the other phy in the connection expires, the other phy is able to transmit a DONE (CREDIT TIMEOUT).

If the DONE Received message has not been received and the Transmitted DONE (ACK/NAK Timeout) message has been received:

- a) this state machine shall initialize and start the DONE Timeout timer; and
- b) this state shall not reinitialize the DONE Timeout timer if an EOF Received message is received.

If the DONE Received message is received before the DONE Timeout timer expires, this state machine shall send the Request Close message to the SL_CC state machine and all the SSP state machines.

If the DONE Received message is not received before the DONE Timeout timer expires, this state machine shall send a Request Break message to the SL_CC state machine and all the SSP state machines.

Any time a DONE Received message is received this state machine shall send a DONE Received confirmation to the port layer. A DONE Received (ACK/NAK Timeout) confirmation informs the port layer that the SSP transmitter is going to close the connection within 1 ms; other DONE Received confirmations (e.g., DONE Received (Close Connection) and DONE Received (Credit Timeout)) may be used by the application layer to decide when to reuse tags.

NOTE 75 - The DONE Timeout timer in one phy (e.g., phy A) may expire concurrently with the ACK/NAK Timeout timer in the other phy (e.g., phy B) in a connection.

For example, if phy A receives DONE (NORMAL) indicating phy B has no more frames to transmit, and phy A then transmits a series of non-interlocked frames where one or more of the SOFs is corrupted, then phy A waits to receive all the ACKs and/or NAKs after transmitting the series of non-interlocked frames. However, since phy B did not receive the full number of SOFs, it does not transmit as many ACKs and/or NAKs as phy A is expecting. The ACK/NAK Timeout timer in phy A expires and phy A transmits DONE (ACK/NAK TIMEOUT). Meanwhile, despite having transmitted DONE, phy B stops receiving frames while phy A is waiting for the final ACKs and/or NAKs. Since phy B does not receive DONE or any more frames, its DONE Timeout timer expires and phy B transmits BREAK.

Since the timers may expire at slightly different times (e.g., due to timer resolution differences), the DONE (ACK/NAK TIMEOUT) may be transmitted before, concurrently with, or after the BREAK. Nevertheless, the phys handle the link layer error (i.e., the ACK/NAK timeout or the DONE timeout) the same way (see 9.2.4.5).

● Author: wdc-mevans
Subject: Highlight
Date: 5/25/2008 9:22:49 PM
T REJECT (2 things ANDED together)
received and
s/b
received, and

● Author: RElliott
Subject: Highlight
Date: 6/30/2008 6:16:52 PM
T ACCEPT - DONE
:
s/b
, then:

● Author: RElliott
Subject: Highlight
Date: 6/30/2008 6:16:52 PM
T ACCEPT - DONE
this
s/b
then this

● Author: RElliott
Subject: Highlight
Date: 6/30/2008 6:16:52 PM
T ACCEPT - DONE
this
s/b
then this

● Author: wdc-mevans
Subject: Highlight
Date: 5/25/2008 9:23:00 PM
T ACCEPT - DONE
received this
s/b
received, this

● Author: Isi-gpenokie
Subject: Highlight
Date: 5/30/2008 6:39:07 PM
T REJECT (these are closely related clauses)
This << connection within 1 ms; other DONE Received >> should be << connection within 1 ms. Other DONE Received >>

● Author: RElliott
Subject: Highlight
Date: 8/31/2008 4:52:44 PM
T ACCEPT - DONE
DONE Received (Close Connection)
s/b
DONE Received (Normal)
per 08-343

● Author: stx-ghoulder

If a DONE Received message, the Transmitted DONE (Normal) message, or the Transmitted DONE (Credit Timeout) message has not been received and the Rx Credit Status (Extended) message or the Rx Credit Control (Blocked) message has been received, then this state shall initialize and start the DONE Timeout timer after receiving the Transmitted DONE (Normal) message or the Transmitted DONE (Credit Timeout) message.

If the DONE Received message has not been received and the Transmitted DONE (Normal) message or the Transmitted DONE (Credit Timeout) message has been received, this state machine shall initialize and start the DONE Timeout timer each time:

- a) the Rx Credit Status (Extended) message is received; or
- b) the Rx Credit Control (Blocked) message is received.

If the Transmitted DONE (Normal) message or the Transmitted DONE (Credit Timeout) message has been received, the DONE Timeout timer shall be reinitialized each time the EOF Received message is received.

If the Transmitted DONE (Normal) message or the Transmitted DONE (Credit Timeout) message has been received, the DONE Timeout timer shall be stopped after:

- a) the Rx Credit Status (Exhausted) message is received; and
- b) the Rx Credit Control (Blocked) message has not been received.

NOTE 74 - Stopping the timer ensures that, if credit remains exhausted long enough that the Credit Timeout timer of the other phy in the connection expires, the other phy is able to transmit a DONE (CREDIT TIMEOUT).

If the DONE Received message has not been received and the Transmitted DONE (ACK/NAK Timeout) message has been received:

- a) this state machine shall initialize and start the DONE Timeout timer; and
- b) this state shall not reinitialize the DONE Timeout timer if an EOF Received message is received.

If the DONE Received message is received before the DONE Timeout timer expires, this state machine shall send the Request Close message to the SL_CC state machine and all the SSP state machines.

If the DONE Received message is not received before the DONE Timeout timer expires, this state machine shall send a Request Break message to the SL_CC state machine and all the SSP state machines.

Any time a DONE Received message is received this state machine shall send a DONE Received confirmation to the port layer. A DONE Received (ACK/NAK Timeout) confirmation informs the port layer that the SSP transmitter is going to close the connection within 1 ms; other DONE Received confirmations (e.g., DONE Received (Close Connection) and DONE Received (Credit Timeout)) may be used by the application layer to decide when to reuse tags.

NOTE 75 - The DONE Timeout timer in one phy (e.g., phy A) may expire concurrently with the ACK/NAK Timeout timer in the other phy (e.g., phy B) in a connection.

For example, if phy A receives DONE (NORMAL) indicating phy B has no more frames to transmit, and phy A then transmits a series of non-interlocked frames where one or more of the SOFs is corrupted, then phy A waits to receive all the ACKs and/or NAKs after transmitting the series of non-interlocked frames. However, since phy B did not receive the full number of SOFs, it does not transmit as many ACKs and/or NAKs as phy A is expecting. The ACK/NAK Timeout timer in phy A expires and phy A transmits DONE (ACK/NAK TIMEOUT). Meanwhile, despite having transmitted DONE, phy B stops receiving frames while phy A is waiting for the final ACKs and/or NAKs. Since phy B does not receive DONE or any more frames, its DONE Timeout timer expires and phy B transmits BREAK.

Since the timers may expire at slightly different times (e.g., due to timer resolution differences), the DONE (ACK/NAK TIMEOUT) may be transmitted before, concurrently with, or after the BREAK. Nevertheless, the phys handle the link layer error (i.e., the ACK/NAK timeout or the DONE timeout) the same way (see 9.2.4.5).

Subject: Highlight
Date: 5/25/2008 9:23:10 PM
T ACCEPT - DONE

application layer
Should be "SCSI application layer".

● Author: RElliott
Subject: Highlight
Date: 8/30/2008 12:12:23 PM
T ACCEPT - DONE

after:
reuse tags

add:
(see 10.2.2)

● Author: stx-ghoulder
Subject: Highlight
Date: 5/6/2008 4:07:49 PM

T REJECT (they are linked by the phrase "in a connection". If connections could be established between phys in a wide port, then this would apply. Chapter 4 discusses that loopback case)

NOTE 75 - The DONE Timeout timer in one phy (e.g., phy A) may expire concurrently with the ACK/NAK Timeout timer in the other phy (e.g., phy B) in a connection.

For this note, should the reader assume "phy A" is at one end of a link (e.g., target) and "phy B" is at the other end of the link (e.g., initiator), or can both phys be at the same end of a link (e.g., target phys that are part of a wide link). This needs to be clarified.

● Author: wdc-mevans
Subject: Cross-Out
Date: 5/23/2008 1:27:56 PM

T REJECT (an unsuspecting reader might expect them to epire at the same time; this points out that they are slightly different)

slightly
[Delete the unnecessary word.]

7.16.8.6 SSP_TF (transmit frame control) state machine

7.16.8.6.1 SSP_TF state machine overview

The SSP_TF state machine's function is to control when the SSP transmitter transmits SOF, frame dwords, EOF, and DONE. This state machine consists of the following states:

- a) SSP_TF1:Connected_Idle (see 7.16.8.6.2)(initial state);
- b) SSP_TF2:Tx_Wait (see 7.16.8.6.3);
- c) SSP_TF3:Transmit_Frame (see 7.16.8.6.4); and
- d) SSP_TF4:Transmit_DONE (see 7.16.8.6.5).

This state machine shall start in the SSP_TF1:Connected_Idle state.

7.16.8.6.2 SSP_TF1:Connected_Idle state

7.16.8.6.2.1 State description

This state waits for a request to transmit a frame or to close the connection.

7.16.8.6.2.2 Transition SSP_TF1:Connected_Idle to SSP_TF2:Tx_Wait

This transition shall occur after a Tx Frame request is received or a Close Connection request is received

If a Tx Frame (Balance Required) request was received this transition shall include a Transmit Frame Balance Required argument.

If a Tx Frame (Balance Not Required) request was received this transition shall include a Transmit Frame Balance Not Required argument.

If a Close Connection request was received this transition shall include a Close Connection argument.

7.16.8.6.2.3 Transition SSP_TF1:Connected_Idle to SSP_TF4:Transmit_DONE

This transition shall occur if an ACK/NAK Timeout message is received. This transition shall include an ACK/NAK Timeout argument.

7.16.8.6.3 SSP_TF2:Tx_Wait state

7.16.8.6.3.1 State description

This state monitors the Tx Balance Status message and the Tx Credit Status message to ensure that frames are transmitted and connections are closed at the proper time.

If this state is entered from the SSP_TF1:Connected_Idle state with a Transmit Frame Balance Required argument or a Transmit Frame Balance Not Required argument, and:

- a) if the last Tx Credit Status message received had an argument of Not Available, this state shall initialize and start the Credit Timeout timer; or
- b) if the last Tx Credit Status message had an argument other than Not Available, this state shall stop the Credit Timeout timer.

7.16.8.6.3.2 Transition SSP_TF2:Tx_Wait to SSP_TF3:Transmit_Frame

This transition shall occur if this state was entered from the SSP_TF1:Connected_Idle state with an argument of Transmit Frame Balance Required if:

- a) the last Tx Balance Status message received had an argument of Balanced; and
- b) the last Tx Credit Status message received had an argument of Available.

This transition shall occur if this state was entered from the SSP_TF1:Connected_Idle state with an argument of Transmit Frame Balance Not Required and if the last Tx Credit Status message received had an argument of Available.

This transition shall occur after sending a Tx Credit Used message to the SSP_TCM state machine.

● Author: wdc-mevans
Subject: Highlight
Date: 5/25/2008 9:23:48 PM
T ACCEPT - DONE

received this
s/b
received, then this

● Author: wdc-mevans
Subject: Highlight
Date: 5/25/2008 9:23:51 PM
T ACCEPT - DONE

received this
s/b
received, then this

● Author: wdc-mevans
Subject: Highlight
Date: 5/25/2008 9:23:58 PM
T ACCEPT - DONE

received this
s/b
received, then this

● Author: RElliott
Subject: Highlight
Date: 6/30/2008 6:16:52 PM
T ACCEPT - DONE

this
s/b
then this

● Author: RElliott
Subject: Highlight
Date: 6/30/2008 6:16:52 PM
T ACCEPT - DONE

this
s/b
then this

7.16.8.6.3.3 Transition SSP_TF2:Tx_Wait to SSP_TF4:Transmit_DONE

This transition shall occur and include an ACK/NAK Timeout argument if an ACK/NAK Timeout message is received.

This transition shall occur and include a Close Connection argument if:

- a) this state was entered from the SSP_TF1:Connected_Idle state with an argument of Close Connection; and
- b) the last Tx Balance Status message received had an argument of Balanced.

This transition shall occur after sending a Credit Timeout confirmation and include a Credit Timeout argument if:

- a) this state was entered from the SSP_TF1:Connected_Idle state with a Transmit Frame Balance Required argument or a Transmit Frame Balance Not Required argument;
- b) the Credit Timeout timer expired before a Tx Credit Status message was received with an argument of Available, or the last Tx Credit Status message received had an argument of Blocked;
- c) a Tx Balance Status message was received with an argument of Balanced (i.e., the Credit Timeout argument shall not be included in this transition for this reason unless the ACK/NAK count is balanced); and
- d) an ACK/NAK Timeout message was not received.

7.16.8.6.4 SSP_TF3:Transmit_Frame state**7.16.8.6.4.1 State description**

This state shall request a frame transmission by sending a Transmit Frame message to the SSP transmitter with an argument containing the frame contents. Each time a Transmit Frame message is sent to the SSP transmitter, one SSP frame (i.e., SOF, frame contents, CRC, and EOF) is transmitted.

In this state receiving a Frame Transmitted message indicates that the frame has been transmitted.

7.16.8.6.4.2 Transition SSP_TF3:Transmit_Frame to SSP_TF1:Connected_Idle

This transition shall occur after:

- a) receiving a Frame Transmitted message;
- b) sending an Frame Transmitted message to the SSP_TIM state machine; and
- c) sending a Frame Transmitted confirmation to the port layer.

7.16.8.6.5 SSP_TF4:Transmit_DONE state

This state shall send one of the following messages to an SSP transmitter:

- a) a Transmit DONE (Normal) message if this state was entered from the SSP_TF2:Tx_Wait state with an argument of Close Connection;
- b) a Transmit DONE (ACK/NAK Timeout) message if this state was entered from the SSP_TF2:Tx_Wait state or the SSP_TF1:Connected_Idle state with an argument of ACK/NAK Timeout; or
- c) a Transmit DONE (Credit Timeout) message if this state was entered from the SSP_TF2:Tx_Wait state with an argument of Credit Timeout.

NOTE 76 - Possible livelock scenarios occur if the BREAK_REPLY method of responding to received BREAK primitive sequences is disabled and a SAS logical phy transmits BREAK to break a connection (e.g., if its Done Timeout timer expires). SAS logical phys should respond to DONE faster than 1 ms to reduce susceptibility to this problem.

After a DONE Transmitted message is received this state shall send the DONE Transmitted confirmation to the port layer and send one of the following messages to the SSP_D state machine:

- a) a Transmitted DONE (Normal) message if this state was entered from the SSP_TF2:Tx_Wait state with an argument of Close Connection;

● Author: wdc-mevans
Subject: Highlight
Date: 5/23/2008 1:25:17 PM
T ACCEPT - DONE

NOTE 76 -
s/b
[All of the font in this note should be changed to the proper size.]

● Author: wdc-mevans
Subject: Highlight
Date: 5/25/2008 9:24:09 PM
T ACCEPT - DONE

received this
s/b
received, this

- b) a Transmitted DONE (ACK/NAK Timeout) message if this state was entered from the SSP_TF2:Tx_Wait state or the SSP_TF1:Connected_Idle state with an argument of ACK/NAK Timeout; or
- c) a Transmitted DONE (Credit Timeout) message if this state was entered from the SSP_TF2:Tx_Wait state with an argument of Credit Timeout.

7.16.8.7 SSP_RF (receive frame control) state machine

The SSP_RF state machine's function is to receive frames and determine whether or not those frames were received successfully. This state machine consists of one state.

This state machine:

- a) checks the frame to determine if the frame should be accepted or discarded;
- b) checks the frame to determine if an ACK or NAK should be transmitted; and
- c) sends a Frame Received confirmation to the port layer.

If this state receives a subsequent SOF Received message after receiving an SOF Received message but before receiving an EOF Received message (i.e., SOF, data dwords, SOF, data dwords, and EOF instead of SOF, data dwords, EOF, SOF, data dwords, and EOF), then **this state shall discard the Data Dword Received messages received before the subsequent SOF Received message.**

This state shall discard the frame if:

- a) this state receives more than 263 Data Dword Received messages after an SOF Received message and before an EOF Received message;
- b) this state receives fewer than 7 Data Dword Received messages after an SOF Received message and before an EOF Received message,
- c) this state receives an Rx Credit Status (Credit Exhausted) message; or
- d) this state receives a DONE Received message.

If this state receives an Invalid Dword Received message or an ERROR Received message after receiving an SOF Received message and before receiving an EOF Received message, then this state machine shall:

- a) ignore the invalid dword or ERROR; **or**
- b) discard the frame, send a Frame Received message to the SSP_RCM state machine, send a Frame Received message to the SSP_RIM state machine, and send a Frame Received (Unsuccessful) message to the SSP_TAN state machine.

If the frame is not discarded and the frame CRC is bad, **this** state machine shall:

- a) send a Frame Received message to the SSP_RCM state machine;
- b) send a Frame Received message to the SSP_RIM state machine; and
- c) send a Frame Received (Unsuccessful) message to the SSP_TAN state machine.

If the frame is not discarded and the frame CRC is good, **this** state machine shall send a Frame Received (Successful) message to the SSP_TAN state machine and:

- a) send a Frame Received message to the SSP_RCM state machine;
- b) send a Frame Received message to the SSP_RIM state machine; and
- c) send a Frame Received (Successful) message to the SSP_TAN state machine, and:
 - A) if the last Rx Balance Status message received had an argument of Balanced, **send** a Frame Received (ACK/NAK Balanced) confirmation to the port layer; or
 - B) if the last Rx Balance Status message received had an argument of Not Balanced, **send** a Frame Received (ACK/NAK Not Balanced) confirmation to the port layer.

7.16.8.8 SSP_RCM (receive frame credit monitor) state machine

The SSP_RCM state machine's function is to ensure that there was credit given to the originator for every frame that is received. This state machine consists of one state.

This state machine monitors the receiver's resources and keeps track of the number of RRDYs transmitted versus the number of frames received.

Page: 399

Author: stx-goulder
Subject: Highlight
Date: 9/3/2008 5:02:14 PM
ACCEPT - DONE (yes. Changed to "discard the frame in progress.

7/9 yes. Check for other uses)

this state shall discard the Data Dword Received messages received before the subsequent SOF Received message.

Should this state also discard the first SOF Received message?

Author: RElliott
Subject: Underline
Date: 6/30/2008 6:16:52 PM
ACCEPT - DONE

after:
263 Data Dword Received messages
add:
(i.e., 1052 bytes)

Author: RElliott
Subject: Underline
Date: 6/30/2008 6:16:52 PM
ACCEPT - DONE

after:
7 Data Dword Received messages
add:
(i.e., 28 bytes)

Author: lsi-gpenokie
Subject: Highlight
Date: 5/6/2008 4:07:49 PM
ACCEPT - DONE (added "either" - see earlier comment)

It seems like this << or >> should be << and >> but that would be a different requirement in that the state would do both a and b rather than have to pick either a or b. I'm not sure which was intended.

Author: RElliott
Subject: Highlight
Date: 6/30/2008 6:16:52 PM
ACCEPT - DONE

this
s/b
then this

Author: RElliott
Subject: Highlight
Date: 6/30/2008 6:16:52 PM
ACCEPT - DONE

this
s/b
then this

Author: RElliott
Subject: Highlight
Date: 6/30/2008 6:16:52 PM

Comments from page 399 continued on next page

- b) a Transmitted DONE (ACK/NAK Timeout) message if this state was entered from the SSP_TF2:Tx_Wait state or the SSP_TF1:Connected_Idle state with an argument of ACK/NAK Timeout; or
- c) a Transmitted DONE (Credit Timeout) message if this state was entered from the SSP_TF2:Tx_Wait state with an argument of Credit Timeout.

7.16.8.7 SSP_RF (receive frame control) state machine

The SSP_RF state machine's function is to receive frames and determine whether or not those frames were received successfully. This state machine consists of one state.

This state machine:

- a) checks the frame to determine if the frame should be accepted or discarded;
- b) checks the frame to determine if an ACK or NAK should be transmitted; and
- c) sends a Frame Received confirmation to the port layer.

If this state receives a subsequent SOF Received message after receiving an SOF Received message but before receiving an EOF Received message (i.e., SOF, data dwords, SOF, data dwords, and EOF instead of SOF, data dwords, EOF, SOF, data dwords, and EOF), then **this state shall discard the Data Dword Received messages received before the subsequent SOF Received message.**

This state shall discard the frame if:

- a) this state receives more than 263 Data Dword Received messages after an SOF Received message and before an EOF Received message;
- b) this state receives fewer than 7 Data Dword Received messages after an SOF Received message and before an EOF Received message,
- c) this state receives an Rx Credit Status (Credit Exhausted) message; or
- d) this state receives a DONE Received message.

If this state receives an Invalid Dword Received message or an ERROR Received message after receiving an SOF Received message and before receiving an EOF Received message, then this state machine shall:

- a) ignore the invalid dword or ERROR; **or**
- b) discard the frame, send a Frame Received message to the SSP_RCM state machine, send a Frame Received message to the SSP_RIM state machine, and send a Frame Received (Unsuccessful) message to the SSP_TAN state machine.

If the frame is not discarded and the frame CRC is bad, **this** state machine shall:

- a) send a Frame Received message to the SSP_RCM state machine;
- b) send a Frame Received message to the SSP_RIM state machine; and
- c) send a Frame Received (Unsuccessful) message to the SSP_TAN state machine.

If the frame is not discarded and the frame CRC is good, **this** state machine shall send a Frame Received (Successful) message to the SSP_TAN state machine and:

- a) send a Frame Received message to the SSP_RCM state machine;
- b) send a Frame Received message to the SSP_RIM state machine; and
- c) send a Frame Received (Successful) message to the SSP_TAN state machine, and:
 - A) if the last Rx Balance Status message received had an argument of Balanced, **send** a Frame Received (ACK/NAK Balanced) confirmation to the port layer; or
 - B) if the last Rx Balance Status message received had an argument of Not Balanced, **send** a Frame Received (ACK/NAK Not Balanced) confirmation to the port layer.

7.16.8.8 SSP_RCM (receive frame credit monitor) state machine

The SSP_RCM state machine's function is to ensure that there was credit given to the originator for every frame that is received. This state machine consists of one state.

This state machine monitors the receiver's resources and keeps track of the number of RRDYs transmitted versus the number of frames received.

T ACCEPT - DONE

send
s/b
then send

Author: RElliott
Subject: Highlight
Date: 6/30/2008 6:16:52 PM

T ACCEPT - DONE

send
s/b
then send

Any time resources are released or become available, if this state machine has not sent the Rx Credit Control (Blocked) message to the SSP_TC state machine and the SSP_D state machine, this state machine shall send the Rx Credit Control (Available) message to the SSP_TC state machine. This state machine shall only send the Rx Credit Control (Available) message to the SSP_TC state machine after frame receive resources become available. The specifications for when or how resources become available is outside the scope of this standard.

This state machine may send the Rx Credit Control (Blocked) message to the SSP_TC state machine and the SSP_D state machine when no further receive frame credit is going to become available within a credit timeout (i.e., less than 1 ms), even if frames are received per the existing receive frame credit. After sending the Rx Credit Control (Blocked) message to the SSP_TC state machine and the SSP_D state machine, this state machine shall not send the Rx Credit Control (Available) message to the SSP_TC state machine or the SSP_D state machine for the duration of the current connection.

This state machine shall indicate through the Rx Credit Control message only the amount of resources available to handle received frames (e.g., if this state machine has resources for five frames the maximum number of Rx Credit Control requests with the Available argument outstanding is five).

This state machine shall use the Credit Transmitted message to keep track of the number of RRDYS transmitted. This state machine shall use the Frame Received message to keep a track of the number of frames received.

Any time the number of Credit Transmitted messages received exceeds the number of Frame Received messages received this state machine shall send a Rx Credit Status (Extended) message to the SSP_RF state machine and the SSP_D state machine.

Any time the number of Credit Transmitted messages received equals the number of Frame Received messages received this state machine shall send a Rx Credit Status (Exhausted) message to the SSP_RF state machine and the SSP_D state machine.

If this state machine receives an Enable Disable SSP (Enable) message, Request Close message, or Request Break message, the frame receive resources shall be initialized to the no credit value for the current connection.

7.16.8.9 SSP_RIM (receive interlocked frame monitor) state machine

The SSP_RIM state machine's function is to inform the SSP_RF state machine when the number of ACKs and NAKs transmitted equals the number of the EOFs received. This state machine consists of one state.

This state machine monitors the number of frames received with a Number Of Frames Received counter and monitors the number of ACKs and NAKs transmitted with a Number Of ACKs/NAKs Transmitted counter.

Each time a Frame Received message is received, this state machine shall increment the Number Of Frames Received counter.

Each time an ACK Transmitted message or a NAK Transmitted is received, this state machine shall increment the Number Of ACKs/NAKs Transmitted counter.

When the Number Of Frames Received counter equals the Number Of ACKs/NAKs Transmitted counter, this state machine shall send an Rx Balance Status (Balanced) message to the SSP_RF state machine.

When the Number Of Frames Received counter does not equal the Number Of ACKs/NAKs Transmitted counter, this state machine shall send an Rx Balance Status (Not Balanced) message to the SSP_RF state machine.

When this state machine receives an Enable Disable SSP (Enable) message, Request Close message, or Request Break message, the Number Of Frames Received counter shall be set to zero and the Number Of ACKs/NAKs Transmitted counter shall be set to zero.

7.16.8.10 SSP_TC (transmit credit control) state machine

The SSP_TC state machine's function is to control the sending of requests to transmit an RRDY or CREDIT_BLOCKED. This state machine consists of one state.

● Author: RElliott
Subject: Highlight
Date: 6/30/2008 6:16:52 PM
T ACCEPT - DONE

the
s/b
, then the

● Author: stx-ghoulder
Subject: Highlight
Date: 5/6/2008 4:07:49 PM
T ACCEPT - DONE

Transmitted
Add "message" after this phrase.

Any time this state machine receives a Rx Credit Control (Available) message it shall send a number of Transmit RRDY (Normal) messages to the SSP transmitter as indicated by the amount of resources available to handle received frames (e.g., if the Available argument indicates five RRDYs are to be transmitted this state machine sends five Transmit RRDY (Normal) messages to the SSP transmitter).

Any time this state machine receives a RRDY Transmitted message it shall send a Credit Transmitted message to the SSP_RCM state machine.

Any time this state machine receives a Rx Credit Control (Blocked) message it shall send a Transmit CREDIT_BLOCKED message to the SSP transmitter.

7.16.8.11 SSP_TAN (transmit ACK/NAK control) state machine

The SSP_TAN state machine's function is to control the sending of requests to transmit an ACK or NAK to the SSP transmitter. This state machine consists of one state.

Any time this state machine receives a Frame Received (Successful) message it shall send a Transmit ACK message to the SSP transmitter.

Any time this state machine receives a Frame Received (Unsuccessful) message it shall send a Transmit NAK (CRC Error) message to the SSP transmitter.

If multiple Frame Received (Unsuccessful) messages and Frame Received (Successful) messages are received, then the order in which the Transmit ACK messages and Transmit NAK messages are sent to the SSP transmitter shall be the same order as the Frame Received (Unsuccessful) messages and Frame Received (Successful) messages were received.

Any time this state machine receives an ACK Transmitted message it shall:

- a) send a Transmitted ACK message to the SSP_RIM state machine; and
- b) send an ACK Transmitted confirmation to the port layer.

Any time this state receives a NAK Transmitted argument it shall send a Transmitted NAK message to the SSP_RIM state machine.

7.17 STP link layer

7.17.1 STP frame transmission and reception

STP frame transmission is defined by SATA (see SATA-2). During an STP connection, frames are preceded by SATA_SOF and followed by SATA_EOF as shown in figure 196.

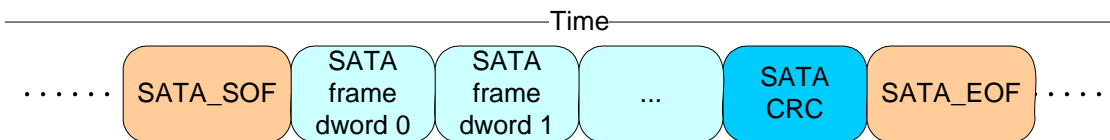

Figure 196 — STP frame transmission

The last data dword after the SOF prior to the EOF always contains a CRC (see 7.5).

Other primitives may be interspersed during the connection as defined by SATA.

Page: 401

● Author: wdc-mevans
Subject: Highlight
Date: 5/22/2008 10:02:42 AM
T REJECT (first noun/subject convention, but added the comma)

message it
s/b
message, this state machine

● Author: RElliott
Subject: Highlight
Date: 6/30/2008 6:16:52 PM
T ACCEPT - DONE

this
s/b
, then this

● Author: wdc-mevans
Subject: Highlight
Date: 5/22/2008 10:06:19 AM
T REJECT (first noun/subject convention, but added comma)

message it
s/b
message, this state machine

● Author: wdc-mevans
Subject: Highlight
Date: 5/22/2008 10:08:22 AM
T REJECT (first noun/subject convention, but added comma)

message it
s/b
message, then this state machine

● Author: wdc-mevans
Subject: Highlight
Date: 5/22/2008 10:06:25 AM
T REJECT (first noun/subject convention, but added comma)

message it
s/b
message, this state machine

● Author: wdc-mevans
Subject: Highlight
Date: 5/22/2008 10:06:31 AM
T REJECT (first noun/subject convention, but added comma)

message it
s/b
message, this state machine

● Author: wdc-mevans
Subject: Highlight
Date: 5/22/2008 10:07:37 AM
T REJECT (first noun/subject convention, but added comma)

message it
s/b

Comments from page 401 continued on next page

Any time this state machine receives a Rx Credit Control (Available) message it shall send a number of Transmit RRDY (Normal) messages to the SSP transmitter as indicated by the amount of resources available to handle received frames (e.g., if the Available argument indicates five RRDYs are to be transmitted this state machine sends five Transmit RRDY (Normal) messages to the SSP transmitter).

Any time this state machine receives a RRDY Transmitted message it shall send a Credit Transmitted message to the SSP_RCM state machine.

Any time this state machine receives a Rx Credit Control (Blocked) message it shall send a Transmit CREDIT_BLOCKED message to the SSP transmitter.

7.16.8.11 SSP_TAN (transmit ACK/NAK control) state machine

The SSP_TAN state machine's function is to control the sending of requests to transmit an ACK or NAK to the SSP transmitter. This state machine consists of one state.

Any time this state machine receives a Frame Received (Successful) message it shall send a Transmit ACK message to the SSP transmitter.

Any time this state machine receives a Frame Received (Unsuccessful) message it shall send a Transmit NAK (CRC Error) message to the SSP transmitter.

If multiple Frame Received (Unsuccessful) messages and Frame Received (Successful) messages are received, then the order in which the Transmit ACK messages and Transmit NAK messages are sent to the SSP transmitter shall be the same order as the Frame Received (Unsuccessful) messages and Frame Received (Successful) messages were received.

Any time this state machine receives an ACK Transmitted message it shall:

- a) send a Transmitted ACK message to the SSP_RIM state machine; and
- b) send an ACK Transmitted confirmation to the port layer

Any time this state receives a NAK Transmitted argument it shall send a Transmitted NAK message to the SSP_RIM state machine.

7.17 STP link layer

7.17.1 STP frame transmission and reception

STP frame transmission is defined by SATA (see SATA-2). During an STP connection, frames are preceded by SATA_SOF and followed by SATA_EOF as shown in figure 196.

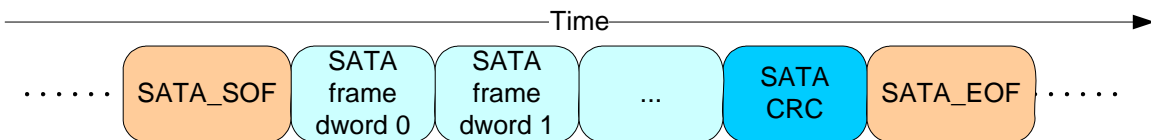

Figure 196 — STP frame transmission

The last data dword after the SOF prior to the EOF always contains a CRC (see 7.5).

Other primitives may be interspersed during the connection as defined by SATA.

message, this state machine

● Author: wdc-mevans
Subject: Highlight
Date: 5/22/2008 10:06:53 AM

T REJECT (first noun/subject convention, but added comma)

argument it

s/b

argument, this state machine

● Author: RElliott
Subject: Highlight
Date: 6/30/2008 6:16:52 PM

T ACCEPT - DONE

state

s/b

state machine

STP encapsulates SATA with connection management. Table 156 summarizes STP link layer differences from the SATA link layer (see SATA-2) that affect behavior during an STP connection.

Table 156 — STP link layer differences from SATA link layer during an STP connection

Feature	Description	Reference
STP flow control	Flow control through an STP connection is point-to-point, not end-to-end. Expander devices accept dwords in an STP flow control buffer after transmitting SATA_HOLD to avoid losing data en-route before the transmitting phy acknowledges the SATA_HOLD with SATA_HOLDA.	7.17.2
Continued primitive sequence	Sustain the continued primitive sequence if a SATA_CONT appears after the continued primitive sequence has begun.	7.17.3

7.17.2 STP flow control

Each STP phy (i.e., STP initiator phy and STP target phy) and expander logical phy through which the STP connection is routed shall implement the SATA flow control protocol on each logical link in the pathway. The flow control primitives are not forwarded through expander devices like other dwords.

When an STP phy or expander phy during an STP connection is receiving a SATA frame and its STP flow control buffer begins to fill up, it shall transmit SATA_HOLD. After transmitting SATA_HOLD, it shall accept at least the following number of data dwords for the SATA frame into its STP flow control buffer:

- a) 24 data dwords at the 1.5 Gbps connection rate;
- b) 28 data dwords at the 3 Gbps connection rate; and
- c) 36 data dwords at the 6 Gbps connection rate.

and shall expect to receive SATA_HOLDA within that number of data dwords. While receiving SATA_HOLDA, it does not place any data dwords into the STP flow control buffer. When the STP flow control buffer empties enough to hold at least that number of data dwords, it shall stop transmitting SATA_HOLD.

When an STP phy or expander phy during an STP connection is transmitting a SATA frame and receives SATA_HOLD, it shall transmit no more than 20 data dwords for the SATA frame and respond with SATA_HOLDA.

NOTE 77 - The STP flow control buffer requirements are based on $(20 + (4 \times 2^n))$ where n is 0 for 1.5 Gbps, 1 for 3 Gbps, and 2 for 6 Gbps. The 20 portion of this equation is based on the frame transmitter requirements (see SATA-2). The (4×2^n) portion of this equation is based on:

- a) One-way propagation time on a 10 m cable = $(5 \text{ ns/m propagation delay}) \times (10 \text{ m cable}) = 50 \text{ ns}$;
- b) Round-trip propagation time on a 10 m cable = 100 ns (e.g., time to send SATA_HOLD and receive SATA_HOLDA);
- c) Time to transmit a 1.5 Gbps dword = $(0.6 \text{ ns/bit unit interval}) \times (40 \text{ bits/dword}) = 26.6 \text{ ns}$; and
- d) Number of 1.5 Gbps dwords on the wire during round-trip propagation time = $(100 \text{ ns} / 26.6 \text{ ns}) = 3.75$.

Receivers may support longer cables by providing larger STP flow control buffer sizes.

When a SATA host phy in an STP/SATA bridge is receiving a SATA frame from a SATA physical link, it shall transmit a SATA_HOLD when it is only capable of receiving 21 more data dwords. It shall stop transmitting SATA_HOLD (e.g., return to transmitting SATA_R_IP) when it is capable of receiving at least 21 more data dwords.

NOTE 78 - SATA requires that frame transmission cease and SATA_HOLDA be transmitted within 20 data dwords of receiving SATA_HOLD. Since the SATA physical link has non-zero propagation time, one dword of margin is included.

When a SATA host phy in an STP/SATA bridge is transmitting a SATA frame to a SATA physical link, it shall transmit no more than 19 data dwords after receiving SATA_HOLD.

Page: 402

Author: wdc-mevans

Subject: Highlight

Date: 5/25/2008 9:25:47 PM

T REJECT (2 things ANDED, and using "the phy" as an abbreviation for "SAS phy or expander phy" is risky)

frame and its STP flow control buffer begins to fill up, it

s/b

frame, and the flow control buffer in the STP phy or expander phy begins to fill up, the phy

Author: wdc-mevans

Subject: Highlight

Date: 5/25/2008 9:26:05 PM

T REJECT (same "it" as the previous sentence)

it

s/b

the STP phy or expander phy

Author: Isi-gpenokie

Subject: Highlight

Date: 5/25/2008 9:26:23 PM

T ACCEPT - DONE

This << and >> should be an << or >> as you can only have one connection rate at a time.

Author: Isi-gpenokie

Subject: Highlight

Date: 5/25/2008 9:27:02 PM

T ACCEPT - DONE

This << connection rate. >> should be << connection rate, >> That's a comma instead of a period.

Author: Isi-gpenokie

Subject: Highlight

Date: 5/25/2008 9:26:48 PM

T REJECT ("it" still refers to "an STP phy or expander phy during an STP connection" from the beginning of the paragraph. Saying just "STP phy" would be wrong.)

This << it does not place any data >> should be << The STP phy does not place any data >>

Author: wdc-mevans

Subject: Highlight

Date: 5/25/2008 9:27:25 PM

T REJECT (same "it" as previous sentence)

it

s/b

the STP phy or expander phy

Author: wdc-mevans

Subject: Highlight

Date: 5/22/2008 5:17:54 PM

T REJECT (but moved the "it" clause to the beginning of the sentence, so it's clearly the same "it" used in the rest of the paragraph)

it

s/b

the STP phy or expander phy

Author: Isi-gpenokie

Subject: Highlight

Date: 5/25/2008 9:26:37 PM

Comments from page 402 continued on next page

STP encapsulates SATA with connection management. Table 156 summarizes STP link layer differences from the SATA link layer (see SATA-2) that affect behavior during an STP connection.

Table 156 — STP link layer differences from SATA link layer during an STP connection

Feature	Description	Reference
STP flow control	Flow control through an STP connection is point-to-point, not end-to-end. Expander devices accept dwords in an STP flow control buffer after transmitting SATA_HOLD to avoid losing data en-route before the transmitting phy acknowledges the SATA_HOLD with SATA_HOLDA.	7.17.2
Continued primitive sequence	Sustain the continued primitive sequence if a SATA_CONT appears after the continued primitive sequence has begun.	7.17.3

7.17.2 STP flow control

Each STP phy (i.e., STP initiator phy and STP target phy) and expander logical phy through which the STP connection is routed shall implement the SATA flow control protocol on each logical link in the pathway. The flow control primitives are not forwarded through expander devices like other dwords.

When an STP phy or expander phy during an STP connection is receiving a SATA frame and its STP flow control buffer begins to fill up, it shall transmit SATA_HOLD. After transmitting SATA_HOLD, it shall accept at least the following number of data dwords for the SATA frame into its STP flow control buffer:

- 24 data dwords at the 1.5 Gbps connection rate;
- 28 data dwords at the 3 Gbps connection rate; and
- 36 data dwords at the 6 Gbps connection rate.

and shall expect to receive SATA_HOLDA within that number of data dwords. While receiving SATA_HOLDA, it does not place any data dwords into the STP flow control buffer. When the STP flow control buffer empties enough to hold at least that number of data dwords, it shall stop transmitting SATA_HOLD.

When an STP phy or expander phy during an STP connection is transmitting a SATA frame and receives SATA_HOLD, it shall transmit no more than 20 data dwords for the SATA frame and respond with SATA_HOLDA.

NOTE 77 - The STP flow control buffer requirements are based on $(20 + (4 \times 2^n))$ where n is 0 for 1.5 Gbps, 1 for 3 Gbps, and 2 for 6 Gbps. The 20 portion of this equation is based on the frame transmitter requirements (see SATA-2). The (4×2^n) portion of this equation is based on:

- One-way propagation time on a 10 m cable = $(5 \text{ ns/m propagation delay}) \times (10 \text{ m cable}) = 50 \text{ ns}$;
- Round-trip propagation time on a 10 m cable = 100 ns (e.g., time to send SATA_HOLD and receive SATA_HOLDA);
- Time to transmit a 1.5 Gbps dword = $(0.6 \text{ ns/bit unit interval}) \times (40 \text{ bits/dword}) = 26.6 \text{ ns}$; and
- Number of 1.5 Gbps dwords on the wire during round-trip propagation time = $(100 \text{ ns} / 26.6 \text{ ns}) = 3.75$.

Receivers may support longer cables by providing larger STP flow control buffer sizes.

When a SATA host phy in an STP/SATA bridge is receiving a SATA frame from a SATA physical link, it shall transmit a SATA_HOLD when it is only capable of receiving 21 more data dwords. It shall stop transmitting SATA_HOLD (e.g., return to transmitting SATA_R_IP) when it is capable of receiving at least 21 more data dwords.

NOTE 78 - SATA requires that frame transmission cease and SATA_HOLDA be transmitted within 20 data dwords of receiving SATA_HOLD. Since the SATA physical link has non-zero propagation time, one dword of margin is included.

When a SATA host phy in an STP/SATA bridge is transmitting a SATA frame to a SATA physical link, it shall transmit no more than 19 data dwords after receiving SATA_HOLD.

T REJECT (but moved the It clause to the beginning of the sentence)

This << dwords, it shall stop transmitting >> should be << dwords, the STAT phy shall stop transmitting >>

● Author: Isi-gpenokie
Subject: Highlight
Date: 5/8/2008 9:05:45 PM

T REJECT

This << it >> should be << the STP phy >>.

● Author: wdc-mevans
Subject: Highlight
Date: 5/25/2008 9:27:38 PM

T REJECT (first noun/subject convention)

it
s/b
the STP phy or expander phy

● Author: RElliott
Subject: Underline
Date: 6/30/2008 6:16:52 PM

T ACCEPT - DONE

One-way
s/b
one-way

(part of global change to lowercase a)b)c) entries)

● Author: RElliott
Subject: Underline
Date: 6/30/2008 6:16:52 PM

T ACCEPT - DONE

Round-trip
s/b
round-trip

(part of global change to lowercase a)b)c) entries)

● Author: RElliott
Subject: Underline
Date: 6/30/2008 6:16:52 PM

T ACCEPT - DONE

Time
s/b
time

(part of global change to lowercase a)b)c) entries)

● Author: RElliott
Subject: Underline
Date: 6/30/2008 6:16:52 PM

T ACCEPT - DONE

Number
s/b
number

STP encapsulates SATA with connection management. Table 156 summarizes STP link layer differences from the SATA link layer (see SATA-2) that affect behavior during an STP connection.

Table 156 — STP link layer differences from SATA link layer during an STP connection

Feature	Description	Reference
STP flow control	Flow control through an STP connection is point-to-point, not end-to-end. Expander devices accept dwords in an STP flow control buffer after transmitting SATA_HOLD to avoid losing data en-route before the transmitting phy acknowledges the SATA_HOLD with SATA_HOLD_A.	7.17.2
Continued primitive sequence	Sustain the continued primitive sequence if a SATA_CONT appears after the continued primitive sequence has begun.	7.17.3

7.17.2 STP flow control

Each STP phy (i.e., STP initiator phy and STP target phy) and expander logical phy through which the STP connection is routed shall implement the SATA flow control protocol on each logical link in the pathway. The flow control primitives are not forwarded through expander devices like other dwords.

When an STP phy or expander phy during an STP connection is receiving a SATA frame and its STP flow control buffer begins to fill up, it shall transmit SATA_HOLD. After transmitting SATA_HOLD, it shall accept at least the following number of data dwords for the SATA frame into its STP flow control buffer:

- 24 data dwords at the 1.5 Gbps connection rate;
- 28 data dwords at the 3 Gbps connection rate; and
- 36 data dwords at the 6 Gbps connection rate.

and shall expect to receive SATA_HOLD_A within that number of data dwords. While receiving SATA_HOLD_A, it does not place any data dwords into the STP flow control buffer. When the STP flow control buffer empties enough to hold at least that number of data dwords, it shall stop transmitting SATA_HOLD.

When an STP phy or expander phy during an STP connection is transmitting a SATA frame and receives SATA_HOLD, it shall transmit no more than 20 data dwords for the SATA frame and respond with SATA_HOLD_A.

NOTE 77 - The STP flow control buffer requirements are based on $(20 + (4 \times 2^n))$ where n is 0 for 1.5 Gbps, 1 for 3 Gbps, and 2 for 6 Gbps. The 20 portion of this equation is based on the frame transmitter requirements (see SATA-2). The (4×2^n) portion of this equation is based on:

- One-way propagation time on a 10 m cable = $(5 \text{ ns/m propagation delay}) \times (10 \text{ m cable}) = 50 \text{ ns}$;
- Round-trip propagation time on a 10 m cable = 100 ns (e.g., time to send SATA_HOLD and receive SATA_HOLD_A);
- Time to transmit a 1.5 Gbps dword = $(0.6 \text{ ns/bit unit interval}) \times (40 \text{ bits/dword}) = 26.6 \text{ ns}$; and
- Number of 1.5 Gbps dwords on the wire during round-trip propagation time = $(100 \text{ ns} / 26.6 \text{ ns}) = 3.75$.

Receivers may support longer cables by providing larger STP flow control buffer sizes.

When a SATA host phy in an STP/SATA bridge is receiving a SATA frame from a SATA physical link, it shall transmit a SATA_HOLD when it is only capable of receiving 21 more data dwords. It shall stop transmitting SATA_HOLD (e.g., return to transmitting SATA_R_IP) when it is capable of receiving at least 21 more data dwords.

NOTE 78 - SATA requires that frame transmission cease and SATA_HOLD_A be transmitted within 20 data dwords of receiving SATA_HOLD. Since the SATA physical link has non-zero propagation time, one dword of margin is included.

When a SATA host phy in an STP/SATA bridge is transmitting a SATA frame to a SATA physical link, it shall transmit no more than 19 data dwords after receiving SATA_HOLD.

(part of global change to lowercase a)b)c) entries)

Author: lsi-gpenokie
Subject: Highlight
Date: 5/25/2008 9:27:53 PM
T REJECT (first noun/subject convention)

This << it >> should be << the STP phy >>.

Author: wdc-mevans
Subject: Highlight
Date: 5/25/2008 9:27:59 PM
T REJECT (first noun/subject convention)

it
s/b
the SATA host phy

Author: lsi-gpenokie
Subject: Highlight
Date: 5/25/2008 9:28:50 PM
T REJECT (same "it" as previous sentence - the "SATA host phy in an STP/SATA bridge"; STP phy is wrong)

This << It >> should be << The STP phy >>.

Author: wdc-mevans
Subject: Highlight
Date: 5/25/2008 9:29:06 PM
T REJECT (carryover from previous sentence)

It
s/b
The SATA host phy

Author: wdc-mevans
Subject: Highlight
Date: 5/25/2008 9:29:12 PM
T REJECT

it
s/b
the phy

Author: wdc-mevans
Subject: Highlight
Date: 5/25/2008 9:29:16 PM
T REJECT

it
s/b
the phy

Author: lsi-gpenokie
Subject: Highlight
Date: 5/25/2008 9:29:46 PM
T REJECT (no, it's the "SATA host phy in an STP/SATA bridge" that "is transmitting...". Not STP)

This << it >> should be << the STP phy >>.

Author: wdc-mevans
Subject: Highlight
Date: 5/25/2008 9:29:58 PM
T REJECT (first noun/subject convention)

it
s/b

Comments from page 402 continued on next page

STP encapsulates SATA with connection management. Table 156 summarizes STP link layer differences from the SATA link layer (see SATA-2) that affect behavior during an STP connection.

Table 156 — STP link layer differences from SATA link layer during an STP connection

Feature	Description	Reference
STP flow control	Flow control through an STP connection is point-to-point, not end-to-end. Expander devices accept dwords in an STP flow control buffer after transmitting SATA_HOLD to avoid losing data en-route before the transmitting phy acknowledges the SATA_HOLD with SATA_HOLD_A.	7.17.2
Continued primitive sequence	Sustain the continued primitive sequence if a SATA_CONT appears after the continued primitive sequence has begun.	7.17.3

7.17.2 STP flow control

Each STP phy (i.e., STP initiator phy and STP target phy) and expander logical phy through which the STP connection is routed shall implement the SATA flow control protocol on each logical link in the pathway. The flow control primitives are not forwarded through expander devices like other dwords.

When an STP phy or expander phy during an STP connection is receiving a SATA frame and its STP flow control buffer begins to fill up, it shall transmit SATA_HOLD. After transmitting SATA_HOLD, it shall accept at least the following number of data dwords for the SATA frame into its STP flow control buffer:

- a) 24 data dwords at the 1.5 Gbps connection rate;
- b) 28 data dwords at the 3 Gbps connection rate; and
- c) 36 data dwords at the 6 Gbps connection rate.

and shall expect to receive SATA_HOLD_A within that number of data dwords. While receiving SATA_HOLD_A, it does not place any data dwords into the STP flow control buffer. When the STP flow control buffer empties enough to hold at least that number of data dwords, it shall stop transmitting SATA_HOLD.

When an STP phy or expander phy during an STP connection is transmitting a SATA frame and receives SATA_HOLD, it shall transmit no more than 20 data dwords for the SATA frame and respond with SATA_HOLD_A.

NOTE 77 - The STP flow control buffer requirements are based on $(20 + (4 \times 2^n))$ where n is 0 for 1.5 Gbps, 1 for 3 Gbps, and 2 for 6 Gbps. The 20 portion of this equation is based on the frame transmitter requirements (see SATA-2). The (4×2^n) portion of this equation is based on:

- a) One-way propagation time on a 10 m cable = $(5 \text{ ns/m propagation delay}) \times (10 \text{ m cable}) = 50 \text{ ns}$;
- b) Round-trip propagation time on a 10 m cable = 100 ns (e.g., time to send SATA_HOLD and receive SATA_HOLD_A);
- c) Time to transmit a 1.5 Gbps dword = $(0.6 \text{ ns/bit unit interval}) \times (40 \text{ bits/dword}) = 26.6 \text{ ns}$; and
- d) Number of 1.5 Gbps dwords on the wire during round-trip propagation time = $(100 \text{ ns} / 26.6 \text{ ns}) = 3.75$.

Receivers may support longer cables by providing larger STP flow control buffer sizes.

When a SATA host phy in an STP/SATA bridge is receiving a SATA frame from a SATA physical link, it shall transmit a SATA_HOLD when it is only capable of receiving 21 more data dwords. It shall stop transmitting SATA_HOLD (e.g., return to transmitting SATA_R_IP) when it is capable of receiving at least 21 more data dwords.

NOTE 78 - SATA requires that frame transmission cease and SATA_HOLD_A be transmitted within 20 data dwords of receiving SATA_HOLD. Since the SATA physical link has non-zero propagation time, one dword of margin is included.

When a SATA host phy in an STP/SATA bridge is transmitting a SATA frame to a SATA physical link, it shall transmit no more than 19 data dwords after receiving SATA_HOLD.

NOTE 79 - SATA assumes that once a SATA_HOLD is transmitted, frame transmission ceases and SATA_HOLDDA arrives within 20 dwords. Since the SATA physical link has non-zero propagation time, one dword of margin is included.



Figure 197 shows STP flow control between:

- a) an STP initiator phy receiving a frame;
- b) an expander device (the first expander device);
- c) an expander device with an STP/SATA bridge (the second expander device); and
- d) a SATA device phy transmitting a frame.

● Author: RElliott

Subject: Note

Date: 9/3/2008 4:41:24 PM



ACCEPT - DONE (added: While transmitting SATA_HOLD or SATA_HOLD_A, the expander device is considered to be originating (see 7.3.2) rather than forwarding (see 7.3.3) for purposes of deletable primitive insertion.

Also added similar, more general rules in the Repeated and Continued primitive sequence sections. SATA_HOLD and SATA_HOLD_A are both Continued, so technically this extra paragraph is not needed in this section, but since HOLD is what prompted the discussion, it seems prudent to mention the rule here)

Need to more clearly define that, when an expander sends HOLD or HOLD_A, it is originating it and is subject to deletable primitive rules in 7.3.2.

(from discussion with Jeff Gauvin, LSI)

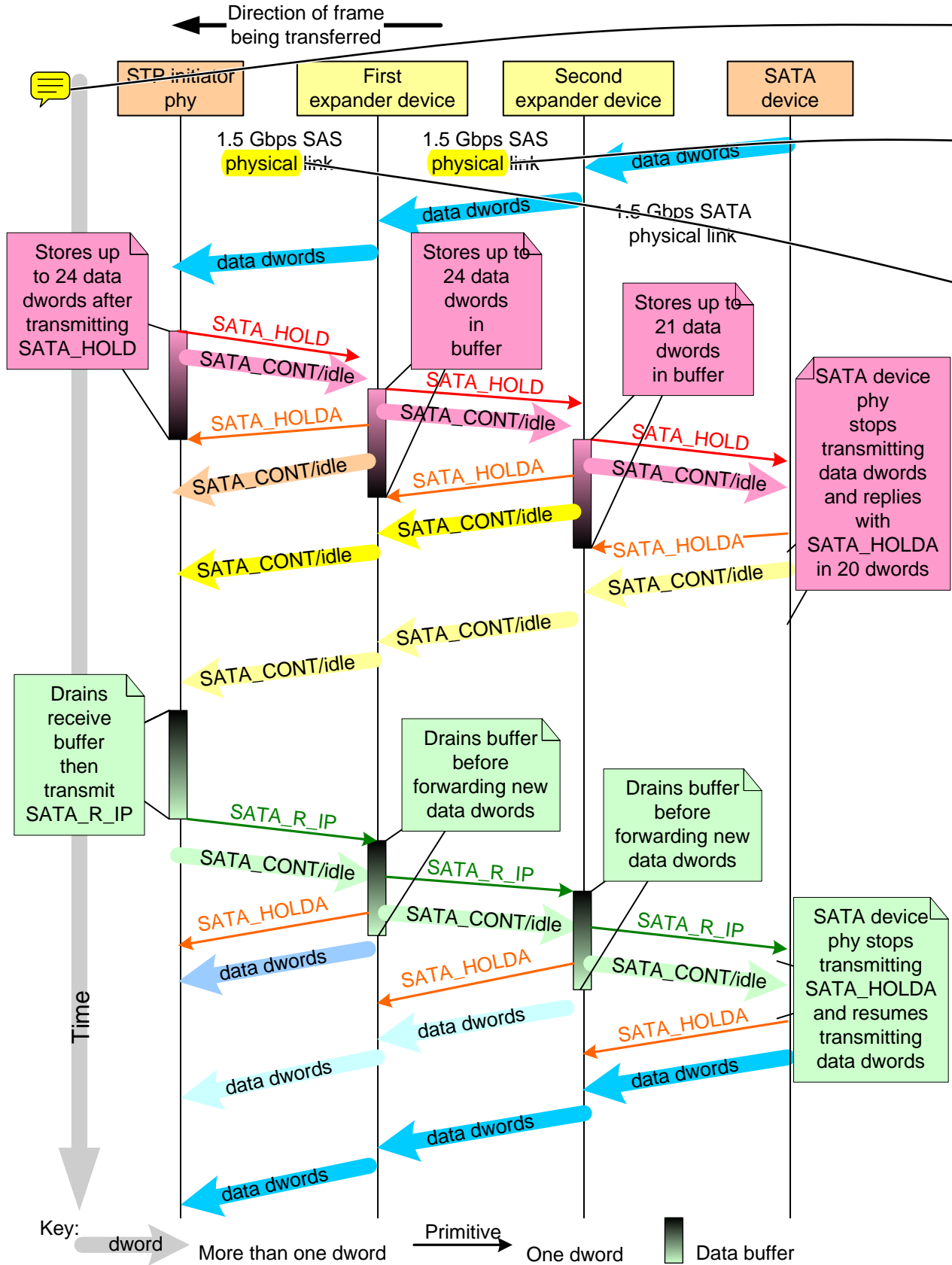

Figure 197 — STP flow control

Page: 404

● Author: RElliott
Subject: Note
Date: 6/30/2008 6:16:52 PM



ACCEPT - DONE

add horizontal lines between column header boxes

● Author: Isi-bbesmer
Subject: Highlight
Date: 5/25/2008 9:30:21 PM



ACCEPT - DONE

physical

s/b

logical

● Author: Isi-bbesmer
Subject: Highlight
Date: 5/25/2008 9:30:17 PM



ACCEPT - DONE

physical

s/b

logical

After the STP initiator phy transmits SATA_HOLD, it receives a SATA_HOLD_A reply from the first expander device within 24 dwords. The first expander device transmits SATA_HOLD to the second expander device and receives SATA_HOLD_A within 24 dwords, buffering data dwords in the STP flow control buffer that it is no longer able to forward to the STP initiator phy. The second expander device transmits SATA_HOLD to the SATA device phy and receives SATA_HOLD_A within 21 dwords, buffering data dwords in the STP flow control buffer that it is no longer able to forward to the first expander device. When the SATA device phy stops transmitting data dwords, its previous data dwords are stored in the STP flow control buffers in both expander devices and the STP initiator phy.

After the STP initiator phy drains its STP flow control buffer and transmits SATA_R_IP, it receives data dwords from the first expander device's STP flow control buffer, followed by data dwords from the second expander device's STP flow control buffer, followed by data dwords from the SATA device phy.

7.17.3 Continued primitive sequence

Primitives that form continued primitive sequences (e.g., SATA_HOLD) shall be:

- 1) transmitted two times;
- 2) be followed by SATA_CONT, if needed; and
- 3) be followed by vendor-specific scrambled data dwords, if needed.

Deletable primitives may be sent inside continued primitive sequences as described in 7.2.4.1.

After the SATA_CONT, during the vendor-specific scrambled data dwords:

- a) a SATA_CONT continues the continued primitive sequence; and
- b) any other STP primitive, including the primitive that is being continued, ends the continued primitive sequence.

Figure 198 shows an example of transmitting a continued primitive sequence.

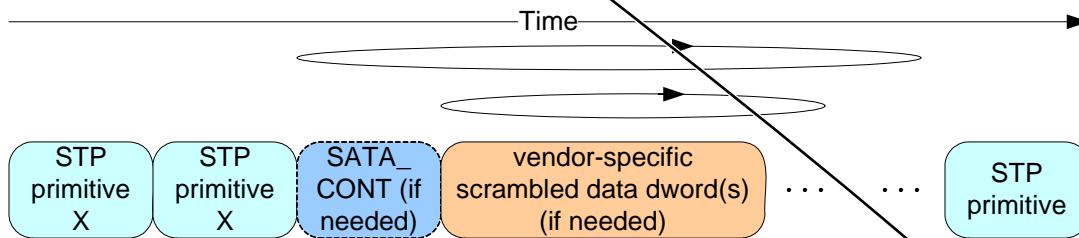

Figure 198 — Transmitting a continued primitive sequence

Receivers shall detect a continued primitive sequence after at least one primitive is received. The primitive may be followed by one or more of the same primitive. The primitive may be followed by one or more SATA_CONTs, each of which may be followed by vendor-specific data dwords. Receivers shall ignore invalid dwords before, during, or after the SATA_CONT(s). Receivers do not count the number of times the continued primitive, the SATA_CONTs, or the vendor-specific data dwords are received (i.e., receivers are simply in the state of receiving the primitive).

Expanders forwarding dwords may or may not detect an incoming sequence of the same primitive and convert it into a continued primitive sequence.

Page: 405

● Author: wdc-mevans
Subject: Highlight
Date: 5/22/2008 10:01:04 AM
T REJECT (first noun/subject convention)

it
s/b
the STP initiator phy

● Author: lsi-gpenokie
Subject: Highlight
Date: 8/27/2008 6:56:05 PM
T ACCEPT - DONE (agree on this one, although the first noun/subject convention works fine - "The first expander device")

I can't figure out what this << it >> is referring to, this needs to be fixed.

● Author: lsi-gpenokie
Subject: Highlight
Date: 5/30/2008 6:41:30 PM
T REJECT (first noun/subject convention - "The second expander device")

I can't figure out what this << it >> is referring to, this needs to be fixed.

● Author: wdc-mevans
Subject: Highlight
Date: 5/30/2008 6:40:26 PM
T REJECT (first noun/subject convention)

it
s/b
the second expander device

● Author: lsi-gpenokie
Subject: Highlight
Date: 5/30/2008 6:41:00 PM
T REJECT (first noun/subject convention - "the SATA device phy")

I can't figure out what this << its >> is referring to, this needs to be fixed.

● Author: lsi-gpenokie
Subject: Highlight
Date: 5/30/2008 6:41:53 PM
T REJECT (first noun/subject convention. And, "thie" is not a word)

This << it >> should be << thie STP initiator phy >>

● Author: wdc-mevans
Subject: Highlight
Date: 5/22/2008 10:10:55 AM
T REJECT (first noun/subject convention)

it
s/b
the STP initiator phy

● Author: RElliott
Subject: Highlight
Date: 6/30/2008 6:16:52 PM
T ACCEPT - DONE

sent
s/b

Comments from page 405 continued on next page

After the STP initiator phy transmits SATA_HOLD, it receives a SATA_HOLDA reply from the first expander device within 24 dwords. The first expander device transmits SATA_HOLD to the second expander device and receives SATA_HOLDA within 24 dwords, buffering data dwords in the STP flow control buffer that it is no longer able to forward to the STP initiator phy. The second expander device transmits SATA_HOLD to the SATA device phy and receives SATA_HOLDA within 21 dwords, buffering data dwords in the STP flow control buffer that it is no longer able to forward to the first expander device. When the SATA device phy stops transmitting data dwords, its previous data dwords are stored in the STP flow control buffers in both expander devices and the STP initiator phy.

After the STP initiator phy drains its STP flow control buffer and transmits SATA_R_IP, it receives data dwords from the first expander device's STP flow control buffer, followed by data dwords from the second expander device's STP flow control buffer, followed by data dwords from the SATA device phy.

7.17.3 Continued primitive sequence

Primitives that form continued primitive sequences (e.g., SATA_HOLD) shall be:

- 1) transmitted two times;
- 2) be followed by SATA_CONT, if needed; and
- 3) be followed by vendor-specific scrambled data dwords, if needed.

Deletable primitives may be sent inside continued primitive sequences as described in 7.2.4.1.

After the SATA_CONT, during the vendor-specific scrambled data dwords:

- a) a SATA_CONT continues the continued primitive sequence; and
- b) any other STP primitive, including the primitive that is being continued, ends the continued primitive sequence.

Figure 198 shows an example of transmitting a continued primitive sequence.

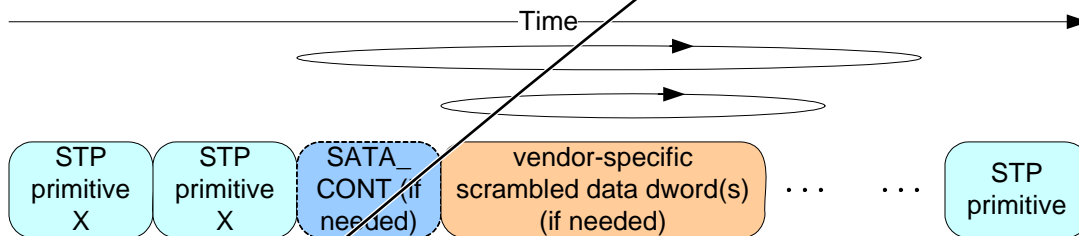

Figure 198 — Transmitting a continued primitive sequence

Receivers shall detect a continued primitive sequence after at least one primitive is received. The primitive may be followed by one or more of the same primitive. The primitive may be followed by one or more SATA_CONTs, each of which may be followed by vendor-specific data dwords. Receivers shall ignore invalid dwords before, during, or after the SATA_CONT(s). Receivers do not count the number of times the continued primitive, the SATA_CONTs, or the vendor-specific data dwords are received (i.e., receivers are simply in the state of receiving the primitive).

Expanders forwarding dwords may or may not detect an incoming sequence of the same primitive and convert it into a continued primitive sequence.

transmitted

● Author: wdc-mevans

Subject: Cross-Out

Date: 5/30/2008 6:42:35 PM

 REJECT (this is an important concept; see reply elsewhere to similar comment on "simply")

(i.e., receivers are simply in the state of receiving the primitive)

[Delete the gratuitous editorial comment, including the "ly" adverb.]

● Author: wdc-mevans

Subject: Highlight

Date: 5/25/2008 9:31:32 PM

 ACCEPT - DONE

it

s/b

the incoming sequence

Figure 199 shows an example of receiving a continued primitive sequence.

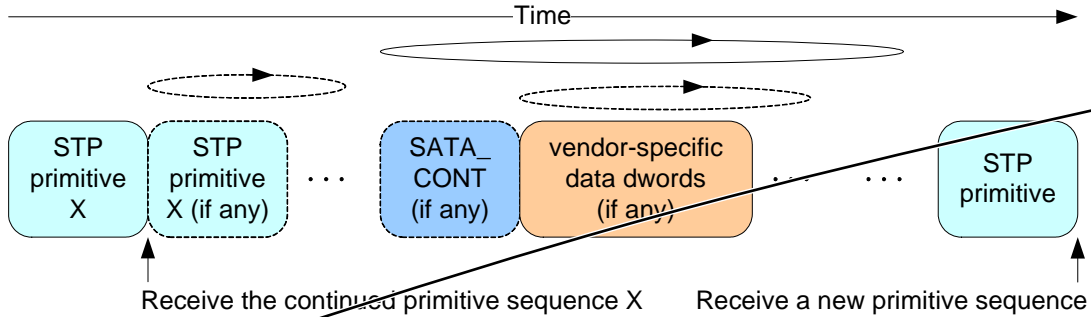

Figure 199 — Receiving a continued primitive sequence

An expander device forwarding a continued primitive sequence may transmit more dwords in the continued primitive sequence than it receives (i.e., expand) or transmit fewer dwords in the continued primitive sequence than it receives (i.e., contract).

7.17.4 Affiliations

The STP target port shall provide coherent access to an ATA task file register set for each STP initiator port from which it accepts connections. It may use affiliations to limit the number of STP initiator ports that establish connections and for which it maintains an ATA task file register set. An affiliation is a state entered by an STP target port where it refuses to accept connection requests from STP initiator ports other than those that have established an affiliation.

STP target ports implement one of the affiliation policies defined in table 157.

Table 157 — Affiliation policies

Affiliation policy	Description
No affiliations	An unlimited number of STP initiator ports are allowed to access the STP target port concurrently. The STP target port is cognizant of the SAS address of the STP initiator port that sends each ATA command.
Multiple affiliations	The STP target port implements more than one affiliation, so a limited number of STP initiator ports are allowed to access the STP target port concurrently. The STP target port implements no more than one affiliation context per STP initiator port.
Single affiliation	The STP target port implements one affiliation, so one STP initiator port is allowed to access the STP target port at a time.

An STP/SATA bridge that supports multiple affiliations shall:

- a) ensure that the SATA NCQ tags in commands issued to the SATA device are unique across all affiliations;
- b) ensure that a non-queued command received in one affiliation context is not issued to the SATA device while another affiliation context has a queued command outstanding to the drive (e.g., the STP target port shall allow all queued commands in the SATA device to complete prior to issuing the non-queued command); and
- c) ensure that a queued command received in one affiliation context is not issued to the SATA device while another affiliation context has a non-queued command outstanding to the drive (e.g., the STP target port shall allow any non-queued command in the SATA device to complete prior to issuing the queued commands).

An STP/SATA bridge that supports multiple affiliations may modify the queue depth reported in the ATA IDENTIFY DEVICE data (see ATA8-ACS) to each STP initiator port to ensure that all the STP initiator ports with affiliations do not send more commands than the SATA device supports.

Page: 406

Author: RElliott

Subject: Note

Date: 9/3/2008 4:34:52 PM

 ACCEPT - DONE (added: While transmitting a continued primitive sequence, the expander device is considered to be originating (see 7.3.2) rather than forwarding (see 7.3.3) for purposes of deletable primitive insertion.)

Retransmitting a continued primitive sequence should be considered originating, not forwarding. Not every dword received is transmitted. During this time, the deletable primitive rules in 7.3.2 need to apply.

(from discussion with Jeff Gauvin, LSI)

Author: wdc-mevans

Subject: Highlight

Date: 5/25/2008 9:31:55 PM

 REJECT (first noun/subject convention)

it
s/b
the expander device

Author: wdc-mevans

Subject: Highlight

Date: 5/25/2008 9:31:59 PM

 REJECT (first noun/subject convention)

it
s/b
the expander device

Author: RElliott

Subject: Highlight

Date: 6/30/2008 6:16:52 PM

 ACCEPT - DONE

an ATA task file register set
s/b
a set of registers called an affiliation context

Author: wdc-mevans

Subject: Highlight

Date: 5/25/2008 9:33:37 PM

 REJECT ("it" is subject of previous sentence)

It
s/b
The STP target port

Author: lsi-gpenokie

Subject: Highlight

Date: 5/16/2008 5:49:51 PM

 REJECT (deleted the second sentence instead.)

This << connections. It may use affiliations to limit >> should I think be << connections. The STP target port may use affiliations to limit >>

Author: wdc-mevans

Subject: Highlight

Date: 5/16/2008 5:48:34 PM

 ACCEPT - DONE

it

Comments from page 406 continued on next page

Figure 199 shows an example of receiving a continued primitive sequence.

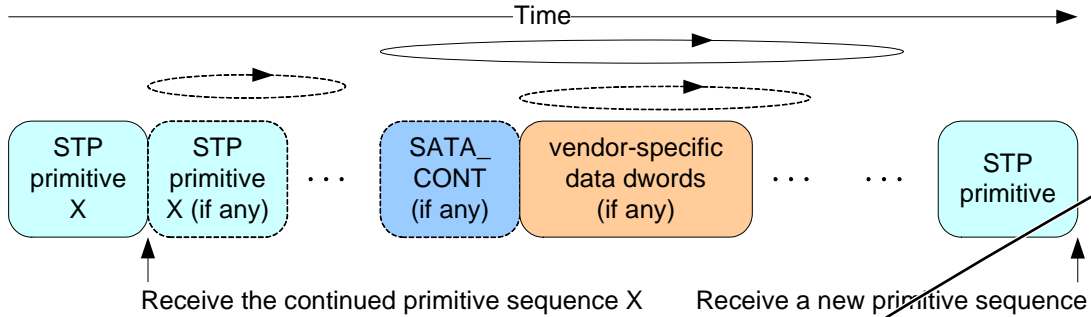

Figure 199 — Receiving a continued primitive sequence

An expander device forwarding a continued primitive sequence may transmit more dwords in the continued primitive sequence than it receives (i.e., expand) or transmit fewer dwords in the continued primitive sequence than it receives (i.e., contract).

7.17.4 Affiliations

The STP target port shall provide coherent access to an ATA task file register set for each STP initiator port from which it accepts connections. It may use affiliations to limit the number of STP initiator ports that establish connections and for which it maintains an ATA task file register set. An affiliation is a state entered by an STP target port where it refuses to accept connection requests from STP initiator ports other than those that have established an affiliation.

STP target ports implement one of the affiliation policies defined in table 157.

Table 157 — Affiliation policies

Affiliation policy	Description
No affiliations	An unlimited number of STP initiator ports are allowed to access the STP target port concurrently. The STP target port is cognizant of the SAS address of the STP initiator port that sends each ATA command.
Multiple affiliations	The STP target port implements more than one affiliation, so a limited number of STP initiator ports are allowed to access the STP target port concurrently. The STP target port implements no more than one affiliation context per STP initiator port.
Single affiliation	The STP target port implements one affiliation, so one STP initiator port is allowed to access the STP target port at a time.

An STP/SATA bridge that supports multiple affiliations shall:

- a) ensure that the SATA NCQ tags in commands issued to the SATA device are unique across all affiliations;
- b) ensure that a non-queued command received in one affiliation context is not issued to the SATA device while another affiliation context has a queued command outstanding to the drive (e.g., the STP target port shall allow all queued commands in the SATA device to complete prior to issuing the non-queued command); and
- c) ensure that a queued command received in one affiliation context is not issued to the SATA device while another affiliation context has a non-queued command outstanding to the drive (e.g., the STP target port shall allow any non-queued command in the SATA device to complete prior to issuing the queued commands).

An STP/SATA bridge that supports multiple affiliations may modify the queue depth reported in the ATA IDENTIFY DEVICE data (see ATA8-ACS) to each STP initiator port to ensure that all the STP initiator ports with affiliations do not send more commands than the SATA device supports.

s/b
the STP target port

Author: wdc-mevans
Subject: Highlight
Date: 5/25/2008 9:32:47 PM
 REJECT

it
s/b
the STP target port

Author: lsi-gpenokie
Subject: Highlight
Date: 5/16/2008 5:50:41 PM
 ACCEPT - DONE

This << which it maintains an ATA >> should I think be << which the STP target port maintains an ATA >>

Author: wdc-mevans
Subject: Highlight
Date: 5/25/2008 9:33:21 PM
 ACCEPT - DONE ("the STP target port")

it
s/b
the STP target port

Author: lsi-gpenokie
Subject: Highlight
Date: 5/16/2008 5:50:25 PM
 ACCEPT - DONE ("the STP target port")

Not sure what this << where it refuses >> is referring to. This needs to be fixed.

Author: lsi-gpenokie
Subject: Highlight
Date: 5/16/2008 5:47:43 PM
 ACCEPT - DONE

This << STP target ports implement one of the affiliation >> should be << STP target ports shall implement one of the affiliation >>

Author: lsi-bbesmer
Subject: Highlight
Date: 5/16/2008 5:47:56 PM
 ACCEPT - DONE ("either no affiliations or multiple affiliations")

multiple affiliations
s/b
no or multiple affiliations

Author: RElliott
Subject: Highlight
Date: 6/30/2008 6:16:52 PM
 ACCEPT - DONE

drive
s/b
SATA device

Author: lsi-bbesmer
Subject: Note
Date: 6/30/2008 10:30:27 AM
 ACCEPT - DONE

Figure 199 shows an example of receiving a continued primitive sequence.

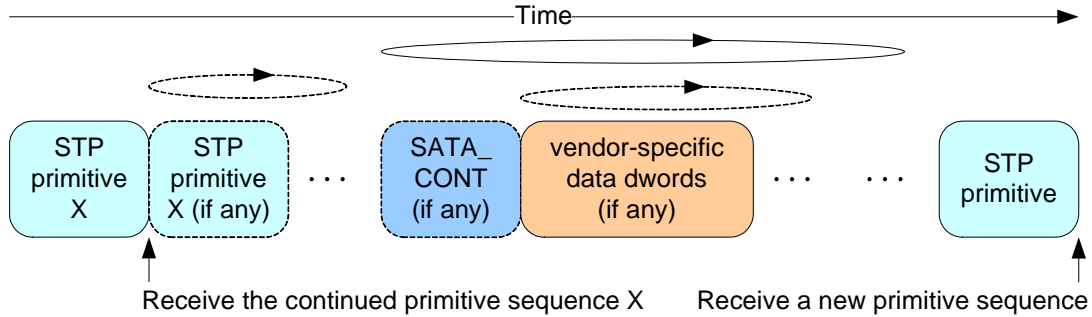



Figure 199 — Receiving a continued primitive sequence

 An expander device forwarding a continued primitive sequence may transmit more dwords in the continued primitive sequence than it receives (i.e., expand) or transmit fewer dwords in the continued primitive sequence than it receives (i.e., contract).

7.17.4 Affiliations

The STP target port shall provide coherent access to an ATA task file register set for each STP initiator port from which it accepts connections. It may use affiliations to limit the number of STP initiator ports that establish connections and for which it maintains an ATA task file register set. An affiliation is a state entered by an STP target port where it refuses to accept connection requests from STP initiator ports other than those that have established an affiliation.

STP target ports implement one of the affiliation policies defined in table 157.

Table 157 — Affiliation policies

Affiliation policy	Description
No affiliations	An unlimited number of STP initiator ports are allowed to access the STP target port concurrently. The STP target port is cognizant of the SAS address of the STP initiator port that sends each ATA command.
Multiple affiliations	The STP target port implements more than one affiliation, so a limited number of STP initiator ports are allowed to access the STP target port concurrently. The STP target port implements no more than one affiliation context per STP initiator port.
Single affiliation	The STP target port implements one affiliation, so one STP initiator port is allowed to access the STP target port at a time.

An STP/SATA bridge that supports multiple affiliations shall:

- a) ensure that the SATA NCQ tags in commands issued to the SATA device are unique across all affiliations;
- b) ensure that a non-queued command received in one affiliation context is not issued to the SATA device while another affiliation context has a queued command outstanding to the drive (e.g., the STP target port shall allow all queued commands in the SATA device to complete prior to issuing the non-queued command); and
- c) ensure that a queued command received in one affiliation context is not issued to the SATA device while another affiliation context has a non-queued command outstanding to the drive (e.g., the STP target port shall allow any non-queued command in the SATA device to complete prior to issuing the queued commands).

 An STP/SATA bridge that supports multiple affiliations may modify the queue depth reported in the ATA IDENTIFY DEVICE data (see ATA8-ACS) to each STP initiator port to ensure that all the STP initiator ports with affiliations do not send more commands than the SATA device supports.

need another rule:

ensure that a non-queued command received in one affiliation context is not issued to the SATA device while another affiliation context has a **non-queued command outstanding to the drive (e.g., the STP target port shall allow the non-queued command in the SATA device to complete prior to issuing the non-queued command)**;

Author: wdc-mevans
Subject: Highlight
Date: 5/25/2008 9:34:03 PM

T ACCEPT - DONE

drive
s/b
SATA device

An STP target port that supports affiliations shall establish an affiliation whenever it accepts a connection request from an STP initiator port that does not already have an affiliation. When the maximum number of affiliations have been established (i.e., all affiliation contexts are in use), the STP target port shall reject all subsequent connection requests from other STP initiator ports with OPEN_REJECT (STP RESOURCES BUSY).

An STP target port shall maintain an affiliation until any of the following occurs:

- a) power on;
- b) the management device server receives an SMP PHY CONTROL request specifying the phy with the affiliation and specifying a phy operation of HARD RESET (see 10.4.3.28) from any SMP initiator port;
- c) the management device server receives an SMP PHY CONTROL request specifying the phy with the affiliation and specifying a phy operation of TRANSMIT SATA PORT SELECTION SIGNAL (see 10.4.3.28) from any SMP initiator port;
- d) the management device server receives an SMP PHY CONTROL request specifying the phy with the affiliation and specifying a phy operation of CLEAR AFFILIATION (see 10.4.3.28) from the same SAS initiator port that has the affiliation.

If a connection is already established to the STP target port on one phy while an SMP PHY CONTROL request specifying a phy operation of CLEAR AFFILIATION is processed by an SMP target port on another phy, the affiliation shall be cleared and the STP target port shall respond to new connection attempts with:

- A) AIP (WAITING ON CONNECTION) and/or OPEN_REJECT (RETRY), if the STP target port is in an expander device; or
- B) OPEN_REJECT (RETRY), if the STP target port is in a SAS device; rather than OPEN_REJECT (STP RESOURCES BUSY);
- e) an STP connection to a phy in the STP target port is closed with CLOSE (CLEAR AFFILIATION); or
- f) the STP target port encounters an I_T nexus loss.

The STP initiator port shall maintain an affiliation starting with the connection in which a command is transmitted until all frames for the command have been delivered. An STP initiator port implementing command queuing (see ATA8-ACS and SATA-2) shall maintain an affiliation while any commands are outstanding. STP initiator ports may keep affiliations for longer tenures, but this is discouraged.

An STP target port that implements affiliations shall implement at least one affiliation context per STP target port. Multiple phys on the same STP target port shall use the same set of affiliation contexts. Support for affiliations is indicated in the SMP REPORT PHY SATA response (see 10.4.3.12).

An STP target port implementing multiple affiliations shall sort the affiliation contexts in a vendor-specific order. In the SMP REPORT PHY SATA response, if the SMP initiator port has the same SAS address as an affiliated STP initiator port, the management device server shall report the affiliation for that SAS address as relative identifier 0 and shall report all additional affiliations with incrementing relative identifiers following the sorted order. If the SMP initiator port does not have the same SAS address as an affiliated STP initiator port, the management device server shall report the affiliation contexts in the vendor-specific order.

● Author: RElliott
Subject: Highlight
Date: 6/30/2008 6:16:52 PM
T ACCEPT - DONE

the
s/b
then the

● Author: lsi-gpenokie
Subject: Highlight
Date: 5/25/2008 9:34:25 PM
T ACCEPT - DONE

This << in a SAS device; >> should be << in a SAS device, >> That's a comma rather than a semicolon.

● Author: lsi-gpenokie
Subject: Highlight
Date: 5/25/2008 9:34:38 PM
T ACCEPT - DONE ("STP initiator ports should not keep affiliations while commands are not outstanding.")

This << STP initiator ports may keep affiliations for longer tenures, but this is discouraged. >> should be << STP initiator ports should not keep affiliations for longer tenures. >> or << STP initiator ports may keep affiliations for longer tenures. >>

● Author: RElliott
Subject: Highlight
Date: 6/30/2008 6:16:52 PM
T ACCEPT - DONE

the
s/b
then the

For example, if the STP target port supports four affiliation contexts sorted in order A, B, C, and D, when returning the SMP REPORT PHY SATA response to an SMP initiator port, the management device server shall report the affiliation contexts as described in table 158.

Table 158 — Affiliation context relative identifier example

Affiliation context containing the SAS address of the SMP initiator port	Affiliation context relative identifier assignment			
	0	1	2	3
A	A	B	C	D
B	B	C	D	A
C	C	D	A	B
D	D	A	B	C
None	A	B	C	D

7.17.5 Opening an STP connection

When the SATA host port in an STP/SATA bridge receives a SATA_X_RDY from the attached SATA device, the STP target port in the STP/SATA bridge shall establish an STP connection to the appropriate STP initiator port.

If an STP/SATA bridge receives a connection request for a SATA device that has not successfully delivered the initial Register – Device to Host FIS, it shall return an OPEN_REJECT (NO DESTINATION).

NOTE 80 - If there is a problem receiving the expected initial Register - Device to Host FIS, the STP/SATA bridge should use SATA_R_ERR to retry until it succeeds. In the DISCOVER response, the ATTACHED SATA DEVICE bit is set to one and the ATTACHED SAS ADDRESS field is valid, but the ATTACHED DEVICE TYPE field is set to 000b (i.e., no device attached) during this time.

If an STP/SATA bridge that retrieves IDENTIFY (PACKET) DEVICE data receives a connection request for a SATA device before it has retrieved the IDENTIFY (PACKET) DEVICE data, it shall return an OPEN_REJECT (NO DESTINATION). If it has a problem retrieving the IDENTIFY (PACKET) DEVICE data (e.g., word 255 (i.e., the Integrity Word) is not correct), the STP/SATA bridge shall set the ATTACHED DEVICE NAME field to zero, set the ATTACHED DEVICE TYPE field to 001b (i.e, end device), and start accepting connections.

A wide STP initiator port shall not request more than one connection at a time to a specific STP target port.

While a wide STP initiator port is waiting for a response to a connection request to an STP target port, a SAS phy in the STP initiator port shall not reject an incoming connection request from that STP target port with OPEN_REJECT (RETRY) because the SAS port containing that SAS phy needs an outgoing connection request to be accepted. The SAS phy may reject an incoming connection request from that STP target port with OPEN_REJECT (RETRY) for any reason that is not dependent on the SAS port containing that SAS phy having an outgoing connection request accepted (e.g., because of a temporary buffer full condition).

If a wide STP initiator port receives an incoming connection request from an STP target port while it has a connection established with that STP target port, it shall reject the request with OPEN_REJECT (RETRY).

A wide STP target port shall not request more than one connection at a time to a specific STP initiator port.

While a wide STP target port is waiting for a response to a connection request or has established a connection to an STP initiator port, it shall:

- a) reject incoming connection requests from that STP initiator port with OPEN_REJECT (RETRY); and
- b) if affiliations are supported and the maximum number of affiliations has been established (i.e., all affiliation contexts are in use), reject incoming connection requests from other STP initiator ports that do not have affiliations with OPEN_REJECT (STP RESOURCES BUSY).

Page: 408

● Author: lsi-gpenokie
Subject: Highlight
Date: 5/25/2008 9:35:08 PM
 ACCEPT - DONE

I do not think putting a shall in a example is a good idea. This << device server shall report the affiliation contexts as described >> should be << device server reports the affiliation contexts as described >>

● Author: RElliott
Subject: Highlight
Date: 6/30/2008 6:16:52 PM
 ACCEPT - DONE

the
s/b
then the

● Author: hpq-relliott
Subject: Note
Date: 8/29/2008 2:50:27 PM
 ACCEPT - DONE (7/14 allow either COMINIT or do nothing.

5/5 either send a COMINIT or just wait and let an initiator deal with it. Expander vendors will research what behavior they currently have and what is best for the future (maybe more than one option))

If there is no affiliation established when a SATA_X_RDY arrives, define what happens. The initial register FIS is normal and expected; anything else is not.

● Author: wdc-mevans
Subject: Highlight
Date: 5/30/2008 6:42:51 PM
 REJECT (first noun/subject convention, but added "then" although not requested)

it
s/b
then the STP/SATA bridge

● Author: RElliott
Subject: Highlight
Date: 6/30/2008 6:16:52 PM
 ACCEPT - DONE

the
s/b
then the

● Author: lsi-gpenokie
Subject: Highlight
Date: 9/3/2008 4:28:22 PM
 ACCEPT - DONE (7/14 SATA state machines appear to resend the initial FIS indefinitely upon receiving R_ERR, so SAS can safely do the same thing)

This note << NOTE 80 - If there is a problem >> should be normative text.

● Author: wdc-mevans
Subject: Highlight
Date: 5/25/2008 9:36:42 PM
 ACCEPT - DONE (as "until the FIS is successfully received.")

Comments from page 408 continued on next page

For example, if the STP target port supports four affiliation contexts sorted in order A, B, C, and D, when returning the SMP REPORT PHY SATA response to an SMP initiator port, the management device server shall report the affiliation contexts as described in table 158.

Table 158 — Affiliation context relative identifier example

Affiliation context containing the SAS address of the SMP initiator port	Affiliation context relative identifier assignment			
	0	1	2	3
A	A	B	C	D
B	B	C	D	A
C	C	D	A	B
D	D	A	B	C
None	A	B	C	D

7.17.5 Opening an STP connection

When the SATA host port in an STP/SATA bridge receives a SATA_X_RDY from the attached SATA device, the STP target port in the STP/SATA bridge shall establish an STP connection to the appropriate STP initiator port.

If an STP/SATA bridge receives a connection request for a SATA device that has not successfully delivered the initial Register – Device to Host FIS, it shall return an OPEN_REJECT (NO DESTINATION).

NOTE 80 - If there is a problem receiving the expected initial Register - Device to Host FIS, the STP/SATA bridge should use SATA_R_ERR to retry until it succeeds. In the DISCOVER response, the ATTACHED SATA DEVICE bit is set to one and the ATTACHED SAS ADDRESS field is valid, but the ATTACHED DEVICE TYPE field is set to 000b (i.e., no device attached) during this time.

If an STP/SATA bridge that retrieves IDENTIFY (PACKET) DEVICE data receives a connection request for a SATA device before it has retrieved the IDENTIFY (PACKET) DEVICE data, it shall return an OPEN_REJECT (NO DESTINATION). If it has a problem retrieving the IDENTIFY (PACKET) DEVICE data (e.g., word 255 (i.e., the Integrity Word) is not correct), the STP/SATA bridge shall set the ATTACHED DEVICE NAME field to zero, set the ATTACHED DEVICE TYPE field to 001b (i.e., end device), and start accepting connections.

A wide STP initiator port shall not request more than one connection at a time to a specific STP target port.

While a wide STP initiator port is waiting for a response to a connection request to an STP target port, a SAS phy in the STP initiator port shall not reject an incoming connection request from that STP target port with OPEN_REJECT (RETRY) because the SAS port containing that SAS phy needs an outgoing connection request to be accepted. The SAS phy may reject an incoming connection request from that STP target port with OPEN_REJECT (RETRY) for any reason that is not dependent on the SAS port containing that SAS phy having an outgoing connection request accepted (e.g., because of a temporary buffer full condition).

If a wide STP initiator port receives an incoming connection request from an STP target port while it has a connection established with that STP target port, it shall reject the request with OPEN_REJECT (RETRY).

A wide STP target port shall not request more than one connection at a time to a specific STP initiator port.

While a wide STP target port is waiting for a response to a connection request or has established a connection to an STP initiator port, it shall:

- a) reject incoming connection requests from that STP initiator port with OPEN_REJECT (RETRY); and
- b) if affiliations are supported and the maximum number of affiliations has been established (i.e., all affiliation contexts are in use), reject incoming connection requests from other STP initiator ports that do not have affiliations with OPEN_REJECT (STP RESOURCES BUSY).

it succeeds.
s/b
the FIS is received without error.

● Author: Isi-gpenokie
Subject: Highlight
Date: 5/25/2008 9:37:48 PM
T REJECT (first noun/subject convention)

This << it >> should be << the STP/SATA bridge >>

● Author: wdc-mevans
Subject: Highlight
Date: 6/5/2008 11:10:00 AM
T REJECT (first noun/subject convention, but added "then")

it
s/b
then the STP/SATA bridge

● Author: wdc-mevans
Subject: Highlight
Date: 5/25/2008 9:37:44 PM
T REJECT (first noun/subject convention)

it
s/b
the STP/SATA bridge

● Author: Isi-gpenokie
Subject: Highlight
Date: 5/25/2008 9:37:36 PM
T REJECT (first noun/subject convention)

This << it >> should be << the STP/SATA bridge >>

● Author: Isi-gpenokie
Subject: Highlight
Date: 5/25/2008 9:37:39 PM
T REJECT (first noun/subject convention)

This << it >> should be << the STP/SATA bridge >>

● Author: wdc-mevans
Subject: Highlight
Date: 8/27/2008 6:56:47 PM
T ACCEPT - DONE (7/17 accept this particular one)

it
s/b
the STP/SATA bridge

● Author: RElliott
Subject: Highlight
Date: 6/30/2008 6:16:52 PM
T ACCEPT - DONE

the STP/SATA bridge
s/b
then it

● Author: Isi-gpenokie
Subject: Highlight
Date: 5/25/2008 9:38:08 PM
T REJECT (nothing wrong with "because")

For example, if the STP target port supports four affiliation contexts sorted in order A, B, C, and D, when returning the SMP REPORT PHY SATA response to an SMP initiator port, the management device server shall report the affiliation contexts as described in table 158.

Table 158 — Affiliation context relative identifier example

Affiliation context containing the SAS address of the SMP initiator port	Affiliation context relative identifier assignment			
	0	1	2	3
A	A	B	C	D
B	B	C	D	A
C	C	D	A	B
D	D	A	B	C
None	A	B	C	D

7.17.5 Opening an STP connection

When the SATA host port in an STP/SATA bridge receives a SATA_X_RDY from the attached SATA device, the STP target port in the STP/SATA bridge shall establish an STP connection to the appropriate STP initiator port.

If an STP/SATA bridge receives a connection request for a SATA device that has not successfully delivered the initial Register – Device to Host FIS, it shall return an OPEN_REJECT (NO DESTINATION).

NOTE 80 - If there is a problem receiving the expected initial Register - Device to Host FIS, the STP/SATA bridge should use SATA_R_ERR to retry until it succeeds. In the DISCOVER response, the ATTACHED SATA DEVICE bit is set to one and the ATTACHED SAS ADDRESS field is valid, but the ATTACHED DEVICE TYPE field is set to 000b (i.e., no device attached) during this time.

If an STP/SATA bridge that retrieves IDENTIFY (PACKET) DEVICE data receives a connection request for a SATA device before it has retrieved the IDENTIFY (PACKET) DEVICE data, it shall return an OPEN_REJECT (NO DESTINATION). If it has a problem retrieving the IDENTIFY (PACKET) DEVICE data (e.g., word 255 (i.e., the Integrity Word) is not correct), the STP/SATA bridge shall set the ATTACHED DEVICE NAME field to zero, set the ATTACHED DEVICE TYPE field to 001b (i.e., end device), and start accepting connections.

A wide STP initiator port shall not request more than one connection at a time to a specific STP target port.

While a wide STP initiator port is waiting for a response to a connection request to an STP target port, a SAS phy in the STP initiator port shall not reject an incoming connection request from that STP target port with OPEN_REJECT (RETRY) because the SAS port containing that SAS phy needs an outgoing connection request to be accepted. The SAS phy may reject an incoming connection request from that STP target port with OPEN_REJECT (RETRY) for any reason that is not dependent on the SAS port containing that SAS phy having an outgoing connection request accepted (e.g., because of a temporary buffer full condition).

If a wide STP initiator port receives an incoming connection request from an STP target port while it has a connection established with that STP target port, it shall reject the request with OPEN_REJECT (RETRY).

A wide STP target port shall not request more than one connection at a time to a specific STP initiator port.

While a wide STP target port is waiting for a response to a connection request or has established a connection to an STP initiator port, it shall:

- a) reject incoming connection requests from that STP initiator port with OPEN_REJECT (RETRY); and
- b) if affiliations are supported and the maximum number of affiliations has been established (i.e., all affiliation contexts are in use), reject incoming connection requests from other STP initiator ports that do not have affiliations with OPEN_REJECT (STP RESOURCES BUSY).

This << (RETRY) because the SAS port containing that SAS phy needs an outgoing >> should be << (RETRY) as a result of the SAS port containing that SAS phy needing an outgoing >>

Author: wdc-mevans

Subject: Highlight

Date: 5/25/2008 9:38:33 PM

T REJECT (that change loses the concept that it NEEDs the connection request to be accepted. It might be designed such that it is attempting to establish a connection, but doesn't mind if it is not accepted.)

needs an outgoing connection request to be accepted

s/b

is attempting to establish a connection to transmit a FIS.

Author: lsi-gpenokie

Subject: Highlight

Date: 5/25/2008 9:38:52 PM

T REJECT (first noun/subject convention)

This << it >> should I think be << the STP initiator port >>

Author: wdc-mevans

Subject: Highlight

Date: 5/22/2008 4:34:29 PM

T REJECT (first noun/subject convention)

it

s/b

the STP initiator port

Author: lsi-gpenokie

Subject: Highlight

Date: 8/27/2008 6:57:46 PM

T ACCEPT - DONE (7/17 accept this one, although it complies with first noun/subject convention)

This << it >> should I think be << the STP initiator port >>

Author: wdc-mevans

Subject: Highlight

Date: 5/22/2008 4:34:55 PM

T REJECT (first noun/subject convention, but added "then")

it

s/b

then the STP initiator port

Author: wdc-mevans

Subject: Highlight

Date: 5/22/2008 4:35:07 PM

T REJECT (first noun/subject convention)

it

s/b

the STP target port

Author: lsi-gpenokie

Subject: Highlight

Date: 8/27/2008 6:58:08 PM

T ACCEPT - DONE (accept this one, although it complies with the first noun/subject convention)

This << it >> should I think be << the STP target port >>

A SAS phy may reject an incoming connection request (i.e., an OPEN address frame) to an STP target port with OPEN_REJECT (RETRY) for any reason, including because the SAS port containing that SAS phy needs an outgoing connection request to be accepted (e.g., to transmit a frame and empty a buffer).

An expander device should not allow its STP ports (e.g., the STP target ports in STP/SATA bridges and any STP initiator ports in the expander device) to attempt to establish more connections to a specific destination port than the destination port width or the width of the narrowest physical link on the pathway to the destination port. This does not apply to connection requests being forwarded by the expander device.

An expander device should not allow its STP ports (e.g., the STP target ports in STP/SATA bridges and any STP initiator ports in the expander device) to attempt to establish more connections than the width of the narrowest common physical link on the pathways to the destination ports of those connections. This does not apply to connection requests being forwarded by the expander device.

Figure 200 shows an example of the simultaneous connection recommendations for an expander device containing STP ports.

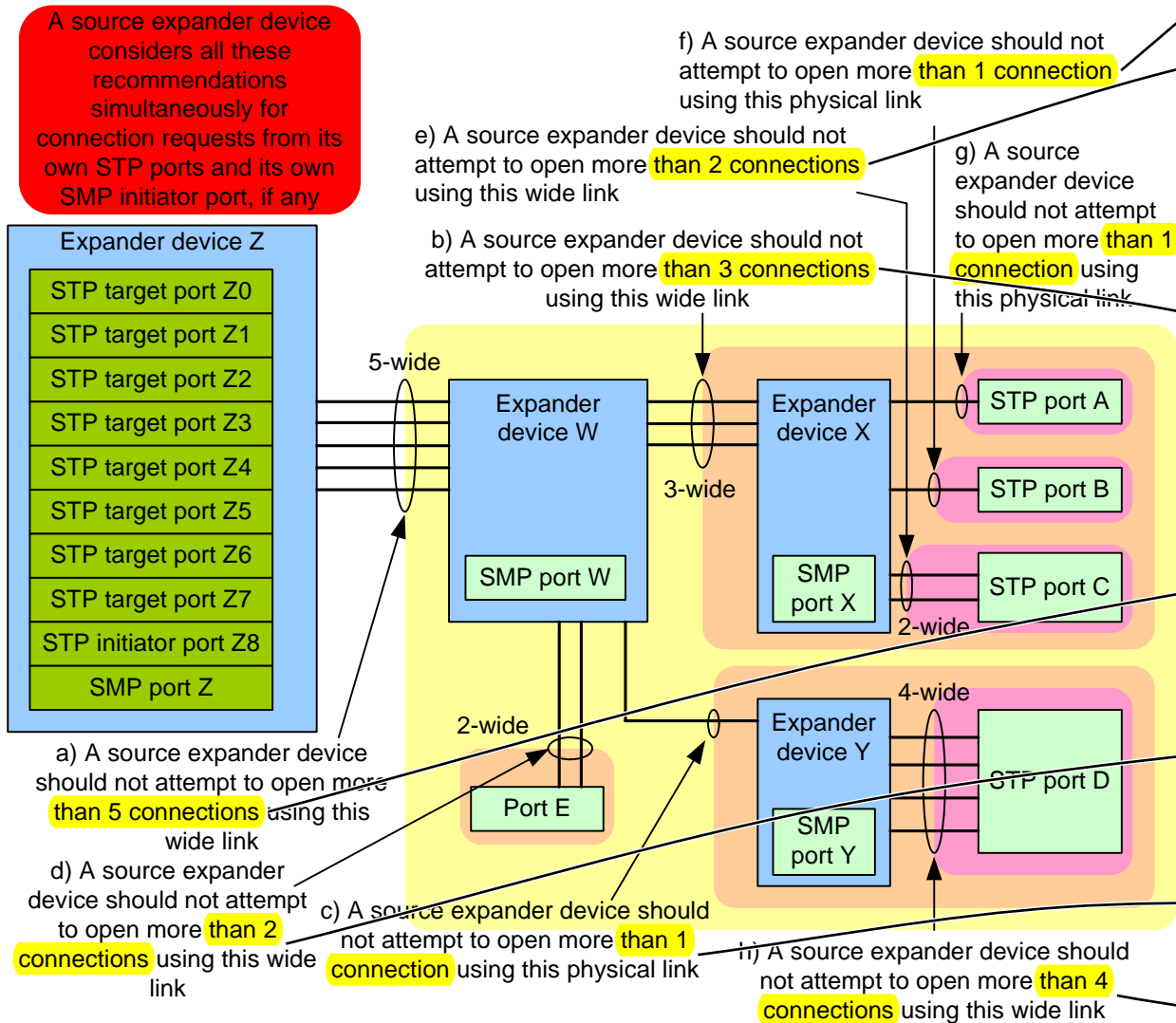

Figure 200 — Example simultaneous connection recommendations for an expander device

In figure 200, some of the recommendations are combined as follows:

- a) recommendations a), b), and e) together mean expander device Z should not attempt to open more than 2 connections to port C;

Page: 409

● Author: lsi-gpenokie
Subject: Highlight
Date: 5/25/2008 9:39:44 PM
T REJECT (nothing wrong with "because")

This << including because the SAS port containing that SAS phy needs an outgoing connection request >> should be << including as a result of the SAS port containing that SAS phy needing an outgoing connection request >>

● Author: lsi-gpenokie
Subject: Highlight
Date: 5/25/2008 9:39:57 PM
T REJECT

This << than 1 connection >> should be << than one connection >>

● Author: lsi-gpenokie
Subject: Highlight
Date: 5/25/2008 9:40:00 PM
T REJECT

This << than 2 connections >> should be << than two connections >>

● Author: lsi-gpenokie
Subject: Highlight
Date: 5/25/2008 9:40:03 PM
T REJECT

This << than 1 connection >> should be << than one connection >>

● Author: lsi-gpenokie
Subject: Highlight
Date: 5/25/2008 9:40:05 PM
T REJECT

This << than 3 connections >> should be << than three connections >>

● Author: lsi-gpenokie
Subject: Highlight
Date: 5/25/2008 9:40:08 PM
T REJECT

This << than 5 connections >> should be << than five connections >>

● Author: lsi-gpenokie
Subject: Highlight
Date: 5/25/2008 9:40:11 PM
T REJECT

This << than 2 connections >> should be << than two connections >>

● Author: lsi-gpenokie
Subject: Highlight
Date: 5/25/2008 9:40:14 PM
T REJECT

This << than 1 connection >> should be << than one connection >>

● Author: lsi-gpenokie
Subject: Highlight
Date: 5/25/2008 9:40:19 PM
T REJECT

Comments from page 409 continued on next page

A SAS phy may reject an incoming connection request (i.e., an OPEN address frame) to an STP target port with OPEN_REJECT (RETRY) for any reason, including because the SAS port containing that SAS phy needs an outgoing connection request to be accepted (e.g., to transmit a frame and empty a buffer).

An expander device should not allow its STP ports (e.g., the STP target ports in STP/SATA bridges and any STP initiator ports in the expander device) to attempt to establish more connections to a specific destination port than the destination port width or the width of the narrowest physical link on the pathway to the destination port. This does not apply to connection requests being forwarded by the expander device.

An expander device should not allow its STP ports (e.g., the STP target ports in STP/SATA bridges and any STP initiator ports in the expander device) to attempt to establish more connections than the width of the narrowest common physical link on the pathways to the destination ports of those connections. This does not apply to connection requests being forwarded by the expander device.

Figure 200 shows an example of the simultaneous connection recommendations for an expander device containing STP ports.

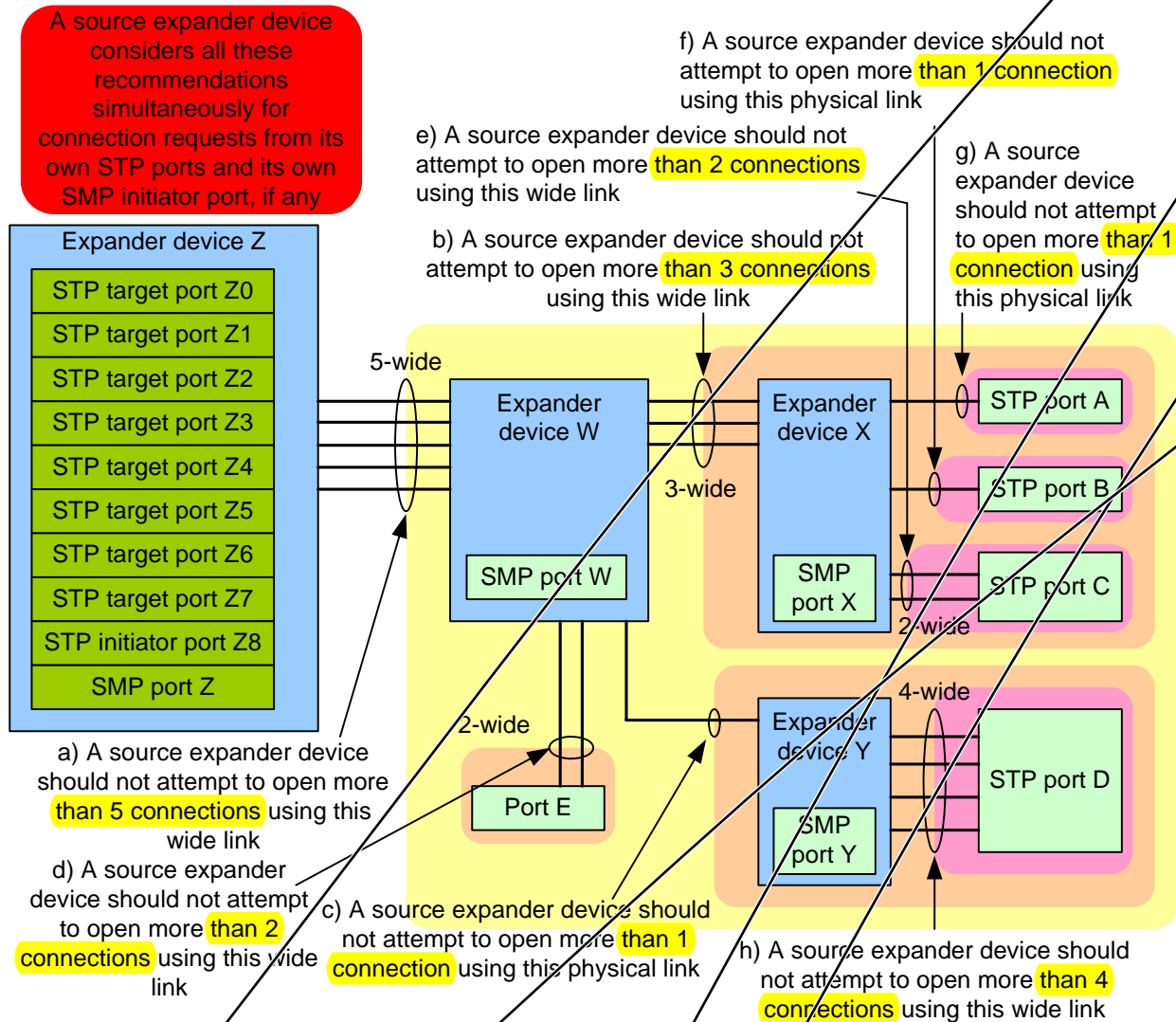

Figure 200 — Example simultaneous connection recommendations for an expander device

In figure 200, some of the recommendations are combined as follows:

- a) recommendations a), b), and e) together mean expander device Z should not attempt to open more than 2 connections to port C;

This << than 4 connections >> should be << than four connections >>

● Author: Isi-bday
Subject: Highlight
Date: 6/30/2008 10:32:09 AM
T ACCEPT - DONE (added "Multiplexing is disabled in this example.")

In figure 200,

Need comment that multiplexing not enabled in this example.

● Author: Isi-gpenokie
Subject: Highlight
Date: 8/27/2008 6:59:32 PM
T ACCEPT - DONE (7/17 go ahead and change to "specify that." Although I try to avoid "specify" except for Mark Evans' favorite usage.)

This << together mean >> should be << together specify >>

● Author: RElliott
Subject: Highlight
Date: 6/30/2008 6:16:52 PM
T ACCEPT - DONE

mean expander
s/b
mean that expander

● Author: Isi-gpenokie
Subject: Highlight
Date: 5/25/2008 9:40:24 PM
T REJECT

This << 2 connections >> should be << two connections >>

- b) recommendations a), b), e), f), and g) together mean that if expander device Z has 2 connections open to ports A, B, and X, it should not attempt to open more than 1 connection to port C. If it has 4 connections open to ports A, B, D, E, W, X, and Y, it should not attempt to open more than 1 connection to port C; and
- c) recommendations a), c), and h) together mean expander device Z should not attempt to open more than 1 connection to port D. If it has a connection open to port Y, it should not attempt to open another connection to port D until the first connection is closed.

The first dword that an STP phy sends inside an STP connection after OPEN_ACCEPT that is not a deletable primitive shall be an STP primitive (e.g., SATA_SYNC).

7.17.6 Closing an STP connection

Either STP port (i.e., either the STP initiator port or the STP target port) may originate closing an STP connection. An STP port shall not originate closing an STP connection after sending a SATA_X_RDY or SATA_R_RDY until after both sending and receiving SATA_SYNC. An STP port shall transmit CLOSE after receiving a CLOSE if it has not already transmitted CLOSE.

If an STP port receives a CLOSE after transmitting a SATA_X_RDY but before receiving a SATA_R_RDY, the STP port shall complete closing the connection (i.e., transmit CLOSE) and retransmit the SATA_X_RDY in a new connection.

When an STP initiator port closes an STP connection, it shall transmit a CLOSE (NORMAL) or CLOSE (CLEAR AFFILIATION). When an STP target port closes an STP connection, it shall transmit a CLOSE (NORMAL).

An STP initiator port may issue CLOSE (CLEAR AFFILIATION) in place of a CLOSE (NORMAL) to cause the STP target port to clear the affiliation (see 7.17.4) along with closing the connection. If an STP target port receives CLOSE (CLEAR AFFILIATION), the STP target port shall clear the affiliation for the STP initiator port that sent the CLOSE (CLEAR AFFILIATION).

See 7.12.7 for additional details on closing connections.

An STP/SATA bridge shall break an STP connection if its SATA host phy loses dword synchronization (see 7.12.8).

7.17.7 STP connection management examples

The STP/SATA bridge adds the outgoing OPEN address frames and CLOSEs so the STP initiator port sees an STP target port. The STP/SATA bridge removes incoming OPEN address frame and CLOSEs so the SATA device port sees only a SATA host port. While the connection is open, the STP/SATA bridge passes through all dwords without modification. Both STP initiator port and STP target port use SATA, with SATA flow control (see 7.17.2), while the connection is open.

Page: 410

● Author: Isi-gpenokie
Subject: Highlight
Date: 5/25/2008 9:40:26 PM
T REJECT

This << 2 connections >> should be << two connections >>

● Author: Isi-gpenokie
Subject: Highlight
Date: 8/27/2008 7:00:13 PM
T ACCEPT - DONE

This << together mean >> should be << together specify >>

● Author: Isi-gpenokie
Subject: Highlight
Date: 5/25/2008 9:40:29 PM
T REJECT

This << 4 connections >> should be << four connections >>

● Author: Isi-gpenokie
Subject: Highlight
Date: 5/25/2008 9:40:32 PM
T REJECT

This << 1 connection >> should be << one connection >>

● Author: RElliott
Subject: Highlight
Date: 6/30/2008 6:16:52 PM
T ACCEPT - DONE

mean expander
s/b
mean that expander

● Author: Isi-gpenokie
Subject: Highlight
Date: 8/27/2008 7:00:26 PM
T ACCEPT - DONE

This << together mean >> should be << together specify >>

● Author: Isi-gpenokie
Subject: Highlight
Date: 5/25/2008 9:40:44 PM
T REJECT

This << 1 connection >> should be << one connection >>

● Author: RElliott
Subject: Highlight
Date: 6/30/2008 6:16:52 PM
T ACCEPT - DONE

the
s/b
then the

- b) recommendations a), b), e), f), and g) together mean that if expander device Z has 2 connections open to ports A, B, and X, it should not attempt to open more than 1 connection to port C. If it has 4 connections open to ports A, B, D, E, W, X, and Y, it should not attempt to open more than 1 connection to port C; and
- c) recommendations a), c), and h) together mean expander device Z should not attempt to open more than 1 connection to port D. If it has a connection open to port Y, it should not attempt to open another connection to port D until the first connection is closed.

The first dword that an STP phy sends inside an STP connection after OPEN_ACCEPT that is not a deletable primitive shall be an STP primitive (e.g., SATA_SYNC).

7.17.6 Closing an STP connection

Either STP port (i.e., either the STP initiator port or the STP target port) may originate closing an STP connection. An STP port shall not originate closing an STP connection after sending a SATA_X_RDY or SATA_R_RDY until after both sending and receiving SATA_SYNC. An STP port shall transmit CLOSE after receiving a CLOSE if it has not already transmitted CLOSE.

If an STP port receives a CLOSE after transmitting a SATA_X_RDY but before receiving a SATA_R_RDY, the STP port shall complete closing the connection (i.e., transmit CLOSE) and retransmit the SATA_X_RDY in a new connection.

When an STP initiator port closes an STP connection, it shall transmit a CLOSE (NORMAL) or CLOSE (CLEAR AFFILIATION). When an STP target port closes an STP connection, it shall transmit a CLOSE (NORMAL).

An STP initiator port may issue CLOSE (CLEAR AFFILIATION) in place of a CLOSE (NORMAL) to cause the STP target port to clear the affiliation (see 7.17.4) along with closing the connection. If an STP target port receives CLOSE (CLEAR AFFILIATION), the STP target port shall clear the affiliation for the STP initiator port that sent the CLOSE (CLEAR AFFILIATION).

See 7.12.7 for additional details on closing connections.

An STP/SATA bridge shall break an STP connection if its SATA host phy loses dword synchronization (see 7.12.8).

7.17.7 STP connection management examples

The STP/SATA bridge adds the outgoing OPEN address frames and CLOSEs so the STP initiator port sees an STP target port. The STP/SATA bridge removes incoming OPEN address frame and CLOSEs so the SATA device port sees only a SATA host port. While the connection is open, the STP/SATA bridge passes through all dwords without modification. Both STP initiator port and STP target port use SATA, with SATA flow control (see 7.17.2), while the connection is open.

● Author: wdc-mevans
Subject: Highlight
Date: 5/25/2008 9:41:16 PM
T REJECT (first noun/subject convention)
it
s/b
the STP initiator port

● Author: wdc-mevans
Subject: Highlight
Date: 5/25/2008 9:41:22 PM
T REJECT (first noun/subject convention)
it
s/b
the STP target port

● Author: RElliott
Subject: Highlight
Date: 6/30/2008 6:16:52 PM
T ACCEPT - DONE
the
s/b
then the

● Author: RElliott
Subject: Highlight
Date: 6/30/2008 6:16:52 PM
T ACCEPT - DONE
that sent
s/b
from which the ... was received

Figure 201 shows an STP initiator port opening a connection, transmitting a single SATA frame, and closing the connection.

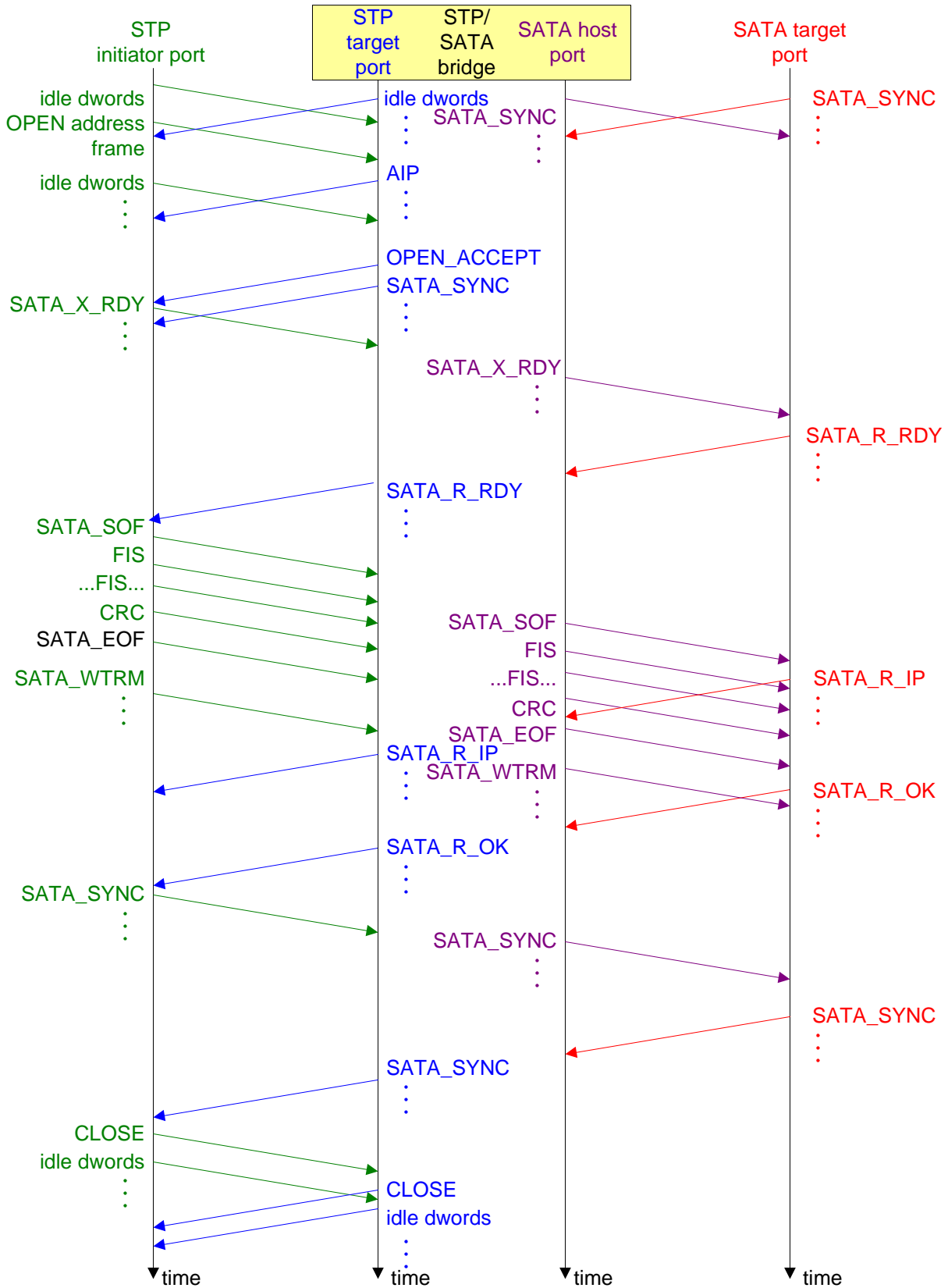

Figure 201 — STP initiator port opening an STP connection

This page contains no comments

Figure 202 shows a SATA device transmitting a SATA frame. In this example, the STP target port in the STP/SATA bridge opens a connection to an STP initiator port to send just one frame, then closes the connection.

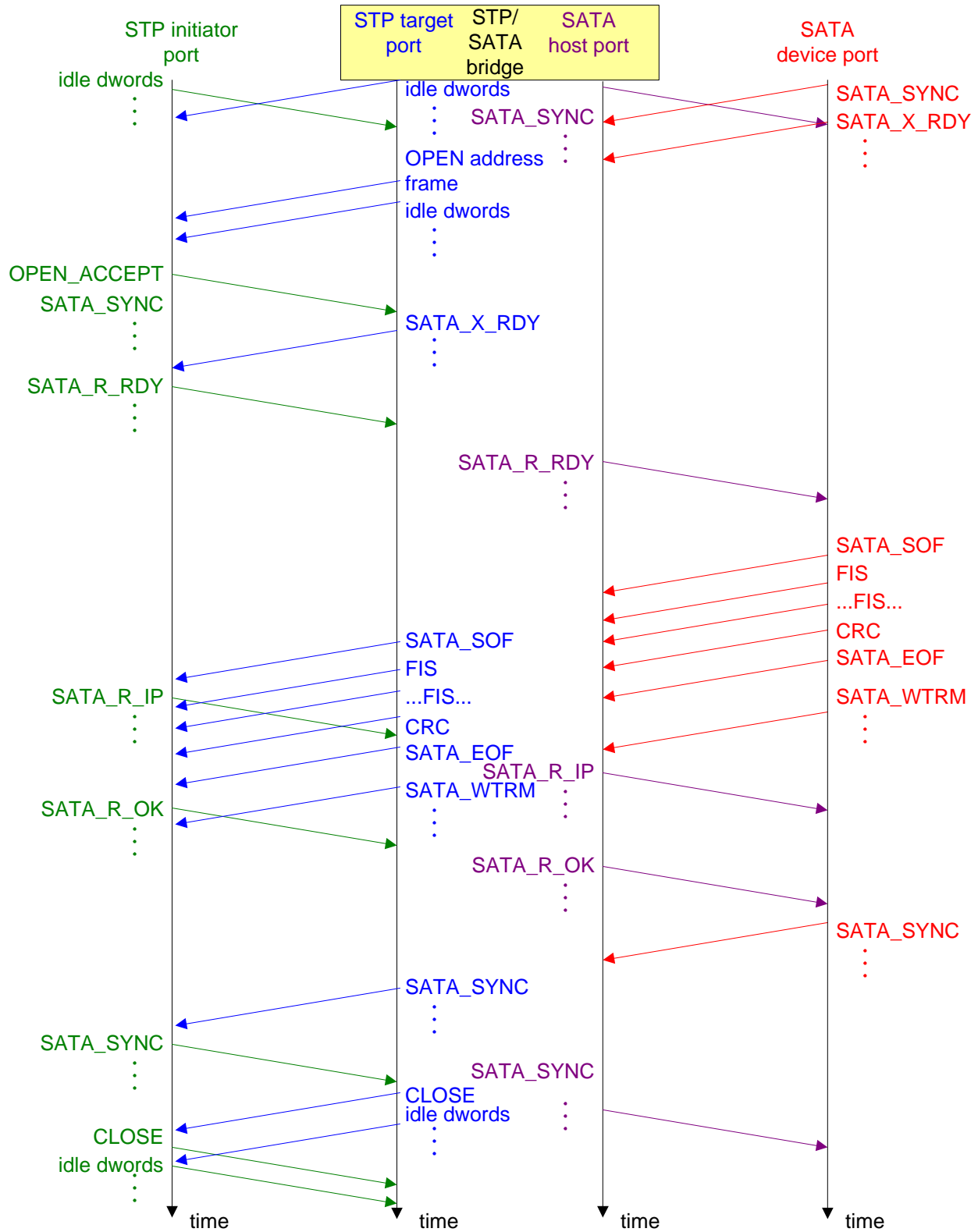

Figure 202 — STP target port opening an STP connection

This page contains no comments

7.17.8 STP (link layer for STP phys) state machines

The STP link layer uses the SATA link layer state machines (see SATA-2), modified to:

- communicate with the port layer rather than directly with the transport layer;
- interface with the SL state machines for connection management (e.g., to select when to open and close STP connections, and to tolerate idle dwords between an OPEN address frame and the first SATA primitive);
- communicate with an STP transmitter and receiver; and
- support an affiliation policy (see 7.17.4).

These modifications are not described in this standard.

The STP transmitter relationship to other transmitters is defined in 4.3.2. The STP receiver relationship to other receivers is defined in 4.3.3.

7.17.9 SMP target port support

A SAS device that contains an STP target port shall also contain an SMP target port.

7.18 SMP link layer

7.18.1 SMP frame transmission and reception

Inside an SMP connection, the SMP initiator phy transmits a single SMP_REQUEST frame within 100 μ s and the SMP target phy responds with a single SMP_RESPONSE frame (see 9.4) within 1 900 μ s.

Frames are surrounded by SOF and EOF as shown in figure 203. See 7.18.5 for error handling details.

NOTE 81 - Unlike SSP, there is no acknowledgement of SMP frames with ACK and NAK and there is no credit exchange with RRDY.

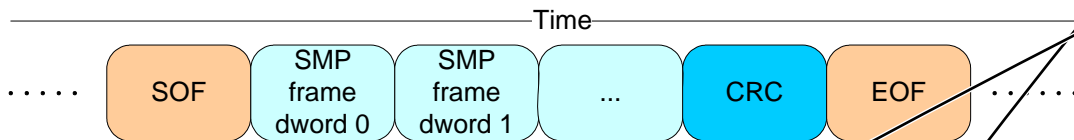

Figure 203 — SMP frame transmission

The last data dword after the SOF prior to the EOF always contains a CRC (see 7.5). The SMP link layer state machine checks that the frame is not too short and that the CRC is valid (see 7.18.5).

7.18.2 SMP flow control

By accepting an SMP connection, the SMP target phy indicates it is ready to receive one SMP_REQUEST frame.

After the SMP initiator phy transmits one SMP_REQUEST frame, it shall be ready to receive one SMP_RESPONSE frame.

7.18.3 Opening an SMP connection

An SMP target port shall not attempt to establish an SMP connection.

AS phy may reject an incoming connection request (i.e., OPEN address frame) to an SMP target port with OPEN_REJECT (RETRY) for any reason, including because the SAS port containing that SAS phy needs an outgoing connection request to be accepted (e.g., to transmit a frame and empty a buffer).

7.18.4 Closing an SMP connection

After receiving the SMP_RESPONSE frame, the SMP initiator phy shall transmit a CLOSE (NORMAL) to close the connection.

Page: 413

● Author: wdc-mevans
Subject: Cross-Out
Date: 5/25/2008 9:41:46 PM
 REJECT (it's pretty important)

directly
[Delete the unnecessary word.]

● Author: lsi-gpenokie
Subject: Highlight
Date: 5/6/2008 4:07:49 PM
 REJECT (this is just informative commentary info)

This note << NOTE 81 - Unlike SSP, there >> should be normative text.

● Author: wdc-mevans
Subject: Highlight
Date: 5/6/2008 4:07:49 PM
 REJECT

it
s/b
the SMP initiator phy

● Author: stx-goulder
Subject: Note
Date: 6/30/2008 10:33:27 AM
 REJECT (there is no such sentence in the "Opening an SSP connection" section; why should one be added here?)

There should be a sentence here that says "An SMP initiator establishes an SMP connection by sending an OPEN address frame to to an SMP target ports"

● Author: lsi-gpenokie
Subject: Highlight
Date: 5/25/2008 9:42:10 PM
 REJECT (nothing wrong with "because")

This << including because the SAS port containing that SAS phy needs an >> should be << including as a resutle of the SAS port containing that SAS phy needing an >>

After transmitting the SMP_RESPONSE frame, the SMP target phy shall reply with a CLOSE (NORMAL). See 7.12.7 for additional details on closing connections.

7.18.5 SMP (link layer for SMP phys) state machines

7.18.5.1 SMP state machines overview

The SMP state machines control the flow of dwords on the physical link during an SMP connection. The SMP state machines are as follows:

- a) SMP_IP (link layer for SMP initiator phys) state machine (see 7.18.5.3); and
- b) SMP_TP (link layer for SMP target phys) state machine (see 7.18.5.4).

7.18.5.2 SMP transmitter and receiver

The SMP transmitter receives the following messages from the SMP state machines specifying dwords and frames to transmit:

- a) Transmit Idle Dword; and
- b) Transmit Frame with an argument containing the frame contents.

In response to the Transmit Frame message, the SMP transmitter transmits:

- 1) SOF;
- 2) the frame contents;
- 3) CRC; and
- 4) EOF.

The SMP transmitter sends the following messages to the SMP state machines based on dwords that have been transmitted:

- a) Frame Transmitted.

When there is no outstanding message specifying a dword to transmit, the SMP transmitter shall transmit idle dwords.

The SMP receiver sends the following messages to the SMP state machines indicating primitive sequences and dwords received from the SP_DWS receiver (see 6.9.2):

- a) SOF Received;
- b) Data Dword Received;
- c) EOF Received;
- d) ERROR Received; and
- e) Invalid Dword Received.

The SMP receiver shall ignore all other dwords.

The SMP transmitter relationship to other transmitters is defined in 4.3.2. The SMP receiver relationship to other receivers is defined in 4.3.3.

7.18.5.3 SMP_IP (link layer for SMP initiator phys) state machine

7.18.5.3.1 SMP_IP state machine overview

The SMP_IP state machine's function is to transmit an SMP request frame and then receive the corresponding response frame. This state machine consists of the following states:

- a) SMP_IP1:Idle (see 7.18.5.3.2)(initial state);
- b) SMP_IP2:Transmit_Frame (see 7.18.5.3.3); and
- c) SMP_IP3:Receive_Frame (see 7.18.5.3.4).

This state machine shall start in the SMP_IP1:Idle state on receipt of an Enable Disable SMP (Enable) message from the SL state machines (see 7.14).

Author: Isi-gpenokie
Subject: Highlight
Date: 5/6/2008 4:07:49 PM
ACCEPT - DONE

This << the following messages to the SMP >> should be << the following message to the SMP >>

The SMP_IP state machine shall terminate after receiving an Enable Disable SMP (Disable) message from the SL state machines.

Figure 204 shows the SMP_IP state machine.

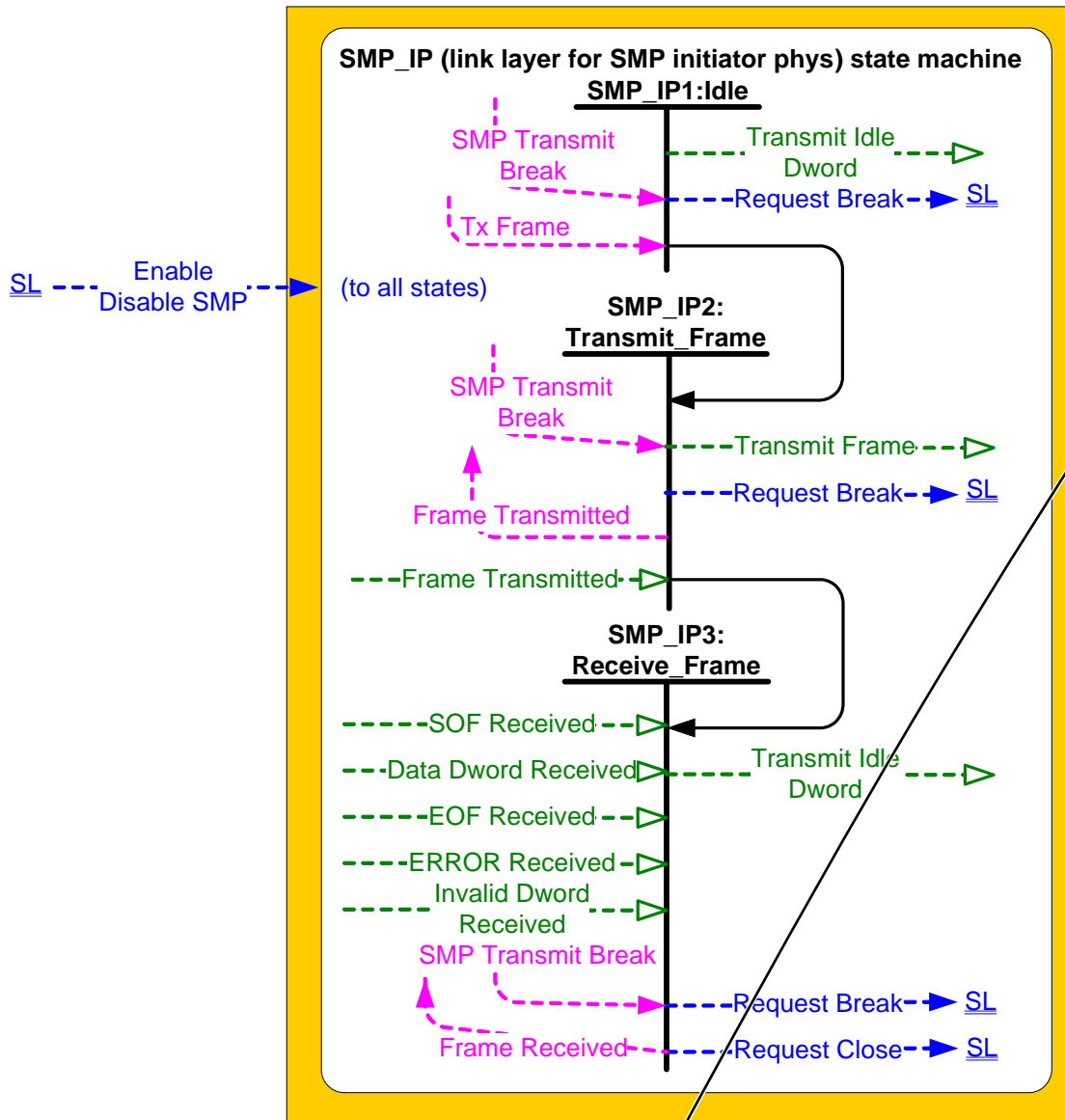

Figure 204 — SMP_IP (link layer for SMP initiator phys) state machine

7.18.5.3.2 SMP_IP1:Idle state

7.18.5.3.2.1 State description

This state is the initial state.

This state shall request idle dwords be transmitted by repeatedly sending Transmit Idle Dword messages to the SMP transmitter.

If an SMP Transmit Break request is received, this state shall send a Request Break message to the SL state machines (see 7.14).

7.18.5.3.2.2 Transition SMP_IP1:Idle to SMP_IP2:Transmit_Frame

This transition shall occur after a Tx Frame request is received.

Author: RElliott
Subject: Highlight
Date: 6/30/2008 6:16:52 PM

T ACCEPT - DONE

this

s/b

then this

7.18.5.3.3 SMP_IP2:Transmit_Frame state

7.18.5.3.3.1 State description

This state shall send a Transmit Frame message to the SMP transmitter with an argument containing the frame contents.

If an SMP Transmit Break request is received, **this** state shall send a Request Break message to the SL state machines (see 7.14) and **terminate**.

After the Frame Transmitted message is received, this state shall send a Frame Transmitted confirmation to the port layer.

7.18.5.3.3.2 Transition SMP_IP2:Transmit_Frame to SMP_IP3:Receive_Frame

This transition shall occur after sending a Frame Transmitted confirmation to the port layer.

7.18.5.3.4 SMP_IP3:Receive_Frame state

This state checks the SMP response frame and determines if the SMP response frame was successfully received (e.g., no CRC error).

If this state receives a subsequent SOF Received message after receiving an SOF Received message but before receiving an EOF Received message (i.e., SOF, data dwords, SOF, data dwords, and EOF instead of SOF, data dwords, EOF, SOF, data dwords, and EOF), then this state **shall discard** the Data Dword Received messages received before the subsequent SOF Received message.

This state shall discard the frame, send a Frame Received (SMP Failure) confirmation to the port layer, send a Request Break message to the SL state machines, and **terminate the state machine**:

- a) this state receives more than **258** Data Dword Received messages after an SOF Received message and before an EOF Received message; or
- b) this state receives fewer than 2 Data Dword Received messages after an SOF Received message and before an EOF Received message.

If this state receives an Invalid Dword Received message or an ERROR Received message after an SOF Received message and before an EOF Received message, then this state machine shall:

- a) ignore the invalid dword or ERROR; **or**
- b) discard the frame, send a Frame Received (SMP Failure) confirmation to the port layer, send a Request Break message to the SL state machines, and **terminate the state machine**.

If the SMP response frame is received with a CRC error, **this** state shall discard the frame, send a Frame Received (SMP Failure) confirmation to the port layer, send a Request Break message to the SL state machines, and **terminate the state machine**.

If the SMP response frame is received with no CRC error and the SMP response frame is valid, **this** state shall:

- a) send a Frame Received confirmation to the port layer; and
- b) send a Request Close message to the SL state machines (see 7.14).

If an SMP Transmit Break request is received, **this** state shall send a Request Break message to the SL state machines and **this state machine shall terminate**.

This state shall request idle dwords be transmitted by repeatedly sending Transmit Idle Dword messages to the SMP transmitter.

Page: 416

Author: RElliott
Subject: Highlight
Date: 6/30/2008 6:16:52 PM

T ACCEPT - DONE
this
s/b
then this

Author: RElliott
Subject: Highlight
Date: 8/30/2008 12:24:24 PM

T ACCEPT - DONE

terminate
s/b
terminate this state machine

per 08-343

Author: RElliott
Subject: Highlight
Date: 8/29/2008 2:47:29 PM

T ACCEPT - DONE

shall discard

add "SOF Received message and"
to match stx-ghoulder comment on page 399

Author: RElliott
Subject: Underline
Date: 9/3/2008 8:02:41 PM

T ACCEPT - DONE

Frame Received (SMP Failure)
s/b
Frame Received (SMP Unsuccessful)

to parallel SSP names

prompted by 08-343

Author: RElliott
Subject: Highlight
Date: 8/30/2008 12:23:56 PM

T ACCEPT - DONE

terminate the state machine

the s/b this
per 08-343

Author: RElliott
Subject: Highlight
Date: 6/30/2008 6:16:52 PM

T ACCEPT - DONE

7.18.5.3.3 SMP_IP2:Transmit_Frame state

7.18.5.3.3.1 State description

This state shall send a Transmit Frame message to the SMP transmitter with an argument containing the frame contents.

If an SMP Transmit Break request is received, **this** state shall send a Request Break message to the SL state machines (see 7.14) and **terminate**.

After the Frame Transmitted message is received, this state shall send a Frame Transmitted confirmation to the port layer.

7.18.5.3.3.2 Transition SMP_IP2:Transmit_Frame to SMP_IP3:Receive_Frame

This transition shall occur after sending a Frame Transmitted confirmation to the port layer.

7.18.5.3.4 SMP_IP3:Receive_Frame state

This state checks the SMP response frame and determines if the SMP response frame was successfully received (e.g., no CRC error).

If this state receives a subsequent SOF Received message after receiving an SOF Received message but before receiving an EOF Received message (i.e., SOF, data dwords, SOF, data dwords, and EOF instead of SOF, data dwords, EOF, SOF, data dwords, and EOF), then this state **shall discard** the Data Dword Received messages received before the subsequent SOF Received message.

This state shall discard the frame, send a Frame Received (SMP Failure) confirmation to the port layer, send a Request Break message to the SL state machines, and **terminate the state machine** if:

- a) this state receives more than **258** Data Dword Received messages after an SOF Received message and before an EOF Received message; or
- b) this state receives fewer than 2 Data Dword Received messages after an SOF Received message and before an EOF Received message.

If this state receives an Invalid Dword Received message or an ERROR Received message after an SOF Received message and before an EOF Received message, then this state machine shall:

- a) ignore the invalid dword or ERROR; **or**
- b) discard the frame, send a Frame Received (SMP Failure) confirmation to the port layer, send a Request Break message to the SL state machines, and **terminate the state machine**.

If the SMP response frame is received with a CRC error, **this** state shall discard the frame, send a Frame Received (SMP Failure) confirmation to the port layer, send a Request Break message to the SL state machines, and **terminate the state machine**.

If the SMP response frame is received with no CRC error and the SMP response frame is valid, **this** state shall:

- a) send a Frame Received confirmation to the port layer; and
- b) send a Request Close message to the SL state machines (see 7.14).

If an SMP Transmit Break request is received, **this** state shall send a Request Break message to the SL state machines and **this state machine shall terminate**.

This state shall request idle dwords be transmitted by repeatedly sending Transmit Idle Dword messages to the SMP transmitter.

258
s/b
257

to restrict SMP frames to 4+1024+4 (see comments in chapter 9 and 10)

● Author: RElliott
Subject: Note
Date: 6/30/2008 6:16:52 PM
 ACCEPT - DONE

Add "(i.e., nnn bytes)" to make these dword counts easier to find

● Author: RElliott
Subject: Note
Date: 6/30/2008 6:16:52 PM
 ACCEPT - DONE

Add:
NOTE: SMP target phys compliant with previous versions of the standard may send vendor-specific SMP frames containing 258 data dwords.

● Author: lsi-gpenokie
Subject: Highlight
Date: 5/6/2008 4:07:49 PM
 ACCEPT - DONE (added "either" - see earlier comment)

It seems like this << or >> should be << and >> but that would be a different requirement in that the state would do both a and b rather than have to pick either a or b. I'm not sure which was intended.

● Author: RElliott
Subject: Underline
Date: 9/3/2008 8:02:52 PM
 ACCEPT - DONE

Frame Received (SMP Failure)
s/b
Frame Received (SMP Unsuccessful)

to parallel SSP names

prompted by 08-343

● Author: RElliott
Subject: Highlight
Date: 8/30/2008 12:23:50 PM
 ACCEPT - DONE

terminate the state machine

the s/b this
per 08-343

● Author: RElliott
Subject: Underline
Date: 9/3/2008 8:03:01 PM
 ACCEPT - DONE

Frame Received (SMP Failure)

Comments from page 416 continued on next page

7.18.5.3.3 SMP_IP2:Transmit_Frame state

7.18.5.3.3.1 State description

This state shall send a Transmit Frame message to the SMP transmitter with an argument containing the frame contents.

If an SMP Transmit Break request is received, **this** state shall send a Request Break message to the SL state machines (see 7.14) and **terminate**.

After the Frame Transmitted message is received, this state shall send a Frame Transmitted confirmation to the port layer.

7.18.5.3.3.2 Transition SMP_IP2:Transmit_Frame to SMP_IP3:Receive_Frame

This transition shall occur after sending a Frame Transmitted confirmation to the port layer.

7.18.5.3.4 SMP_IP3:Receive_Frame state

This state checks the SMP response frame and determines if the SMP response frame was successfully received (e.g., no CRC error).

If this state receives a subsequent SOF Received message after receiving an SOF Received message but before receiving an EOF Received message (i.e., SOF, data dwords, SOF, data dwords, and EOF instead of SOF, data dwords, EOF, SOF, data dwords, and EOF), then this state **shall discard** the Data Dword Received messages received before the subsequent SOF Received message.

This state shall discard the frame, send a Frame Received (SMP Failure) confirmation to the port layer, send a Request Break message to the SL state machines, and **terminate the state machine** if:

- a) this state receives more than **258** Data Dword Received messages after an SOF Received message and before an EOF Received message; or
- b) this state receives fewer than 2 Data Dword Received messages after an SOF Received message and before an EOF Received message.

If this state receives an Invalid Dword Received message or an ERROR Received message after an SOF Received message and before an EOF Received message, then this state machine shall:

- a) ignore the invalid dword or ERROR; **or**
- b) discard the frame, send a Frame Received (SMP Failure) confirmation to the port layer, send a Request Break message to the SL state machines, and **terminate the state machine**.

If the SMP response frame is received with a CRC error, **this** state shall discard the frame, send a Frame Received (SMP Failure) confirmation to the port layer, send a Request Break message to the SL state machines, and **terminate the state machine**.

If the SMP response frame is received with no CRC error and the SMP response frame is valid, **this** state shall:

- a) send a Frame Received confirmation to the port layer; and
- b) send a Request Close message to the SL state machines (see 7.14).

If an SMP Transmit Break request is received, **this** state shall send a Request Break message to the SL state machines and **this state machine shall terminate**.

This state shall request idle dwords be transmitted by repeatedly sending Transmit Idle Dword messages to the SMP transmitter.

s/b
Frame Received (SMP Unsuccessful)

to parallel SSP names

prompted by 08-343

● Author: RElliott
Subject: Highlight
Date: 6/30/2008 6:16:52 PM

T ACCEPT - DONE

this
s/b
then this

● Author: RElliott
Subject: Highlight
Date: 8/30/2008 12:23:43 PM

T ACCEPT - DONE

terminate the state machine

the s/b this
per 08-343

● Author: RElliott
Subject: Highlight
Date: 6/30/2008 6:16:52 PM

T ACCEPT - DONE

this
s/b
then this

● Author: RElliott
Subject: Underline
Date: 9/3/2008 8:05:21 PM

T ACCEPT - DONE

Frame Received
s/b
Frame Received (SMP Successful)

to parallel SSP names

prompted by 08-343

● Author: RElliott
Subject: Highlight
Date: 6/30/2008 6:16:52 PM

T ACCEPT - DONE

this
s/b
then this

● Author: RElliott
Subject: Highlight

Comments from page 416 continued on next page

7.18.5.3.3 SMP_IP2:Transmit_Frame state

7.18.5.3.3.1 State description

This state shall send a Transmit Frame message to the SMP transmitter with an argument containing the frame contents.

If an SMP Transmit Break request is received, **this** state shall send a Request Break message to the SL state machines (see 7.14) and **terminate**.

After the Frame Transmitted message is received, this state shall send a Frame Transmitted confirmation to the port layer.

7.18.5.3.3.2 Transition SMP_IP2:Transmit_Frame to SMP_IP3:Receive_Frame

This transition shall occur after sending a Frame Transmitted confirmation to the port layer.

7.18.5.3.4 SMP_IP3:Receive_Frame state

This state checks the SMP response frame and determines if the SMP response frame was successfully received (e.g., no CRC error).

If this state receives a subsequent SOF Received message after receiving an SOF Received message but before receiving an EOF Received message (i.e., SOF, data dwords, SOF, data dwords, and EOF instead of SOF, data dwords, EOF, SOF, data dwords, and EOF), then this state **shall discard** the Data Dword Received messages received before the subsequent SOF Received message.

This state shall discard the frame, send a Frame Received (SMP Failure) confirmation to the port layer, send a Request Break message to the SL state machines, and **terminate the state machine** if:

- a) this state receives more than **258** Data Dword Received messages after an SOF Received message and before an EOF Received message; or
- b) this state receives fewer than 2 Data Dword Received messages after an SOF Received message and before an EOF Received message.

If this state receives an Invalid Dword Received message or an ERROR Received message after an SOF Received message and before an EOF Received message, then this state machine shall:

- a) ignore the invalid dword or ERROR; **or**
- b) discard the frame, send a Frame Received (SMP Failure) confirmation to the port layer, send a Request Break message to the SL state machines, and **terminate the state machine**.

If the SMP response frame is received with a CRC error, **this** state shall discard the frame, send a Frame Received (SMP Failure) confirmation to the port layer, send a Request Break message to the SL state machines, and **terminate the state machine**.

If the SMP response frame is received with no CRC error and the SMP response frame is valid, **this** state shall:

- a) send a Frame Received confirmation to the port layer; and
- b) send a Request Close message to the SL state machines (see 7.14).

If an SMP Transmit Break request is received, **this** state shall send a Request Break message to the SL state machines and **this state machine shall terminate**.

This state shall request idle dwords be transmitted by repeatedly sending Transmit Idle Dword messages to the SMP transmitter.

Date: 8/30/2008 12:26:44 PM

T ACCEPT - DONE

this state machine shall terminate
s/b
shall terminate this state machine

to match other wording (08-343 requests similar changes in this regard, but not this specific sentence)

7.18.5.4 SMP_TP (link layer for SMP target phys) state machine

7.18.5.4.1 SMP_TP state machine overview

The SMP_TP state machine's function is to receive an SMP request frame and then transmit the corresponding SMP response frame. The SMP_TP state machine consists of the following states:

- a) SMP_TP1:Receive_Frame (see 7.18.5.4.2)(initial state); and
- b) SMP_TP2:Transmit_Frame (see 7.18.5.4.3).

This state machine shall start in the SMP_TP1:Receive_Frame state after receiving an Enable Disable SMP (Enable) message from the SL state machines (see 7.14).

The SMP_TP state machine shall terminate after receiving an Enable Disable SMP (Disable) message from the SL state machines.

Figure 205 shows the SMP_TP state machine.

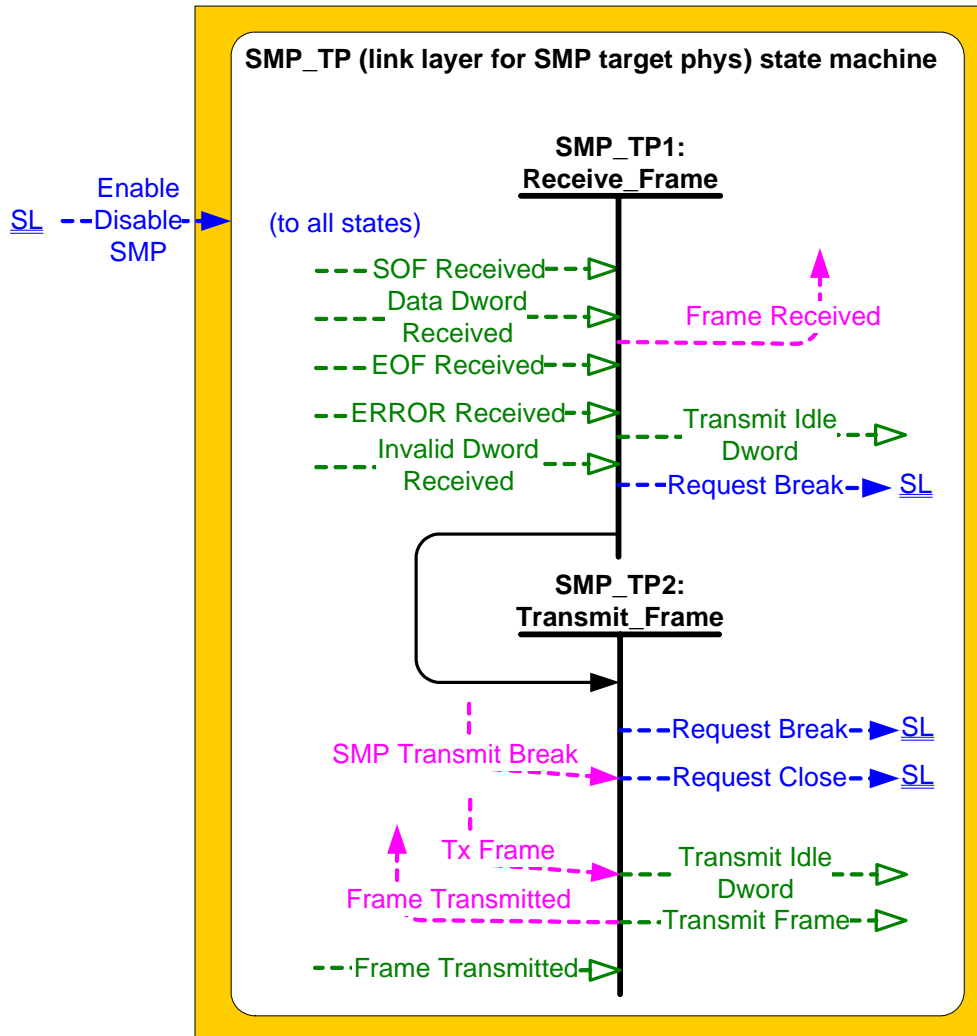

Figure 205 — SMP_TP (link layer for SMP target phys) state machine

7.18.5.4.2 SMP_TP1:Receive_Frame state

7.18.5.4.2.1 State description

This state waits for an SMP frame and determines if the SMP frame was successfully received (e.g., no CRC error).

This page contains no comments

If this state receives a subsequent SOF Received message after receiving an SOF Received message but before receiving an EOF Received message (i.e., SOF, data dwords, SOF, data dwords, and EOF instead of SOF, data dwords, EOF, SOF, data dwords, and EOF), then this state shall discard the Data Dword Received messages received before the subsequent SOF Received message.

This state shall discard the frame, send a Request Break message to the SL state machines (see 7.14) and shall terminate the state machine if:

- a) this state receives more than 258 Data Dword Received messages after an SOF Received message and before an EOF Received message; or
- b) this state receives fewer than 2 Data Dword Received messages after an SOF Received message and before an EOF Received message.

If this state receives an Invalid Dword Received message or an ERROR Received message after an SOF Received message and before an EOF Received message, then this state machine shall:

- a) ignore the invalid dword or ERROR; or
- b) discard the frame, send a Request Break message to the SL state machines (see 7.14) and shall terminate the state machine.

If the SMP request frame is received with a CRC error, this state shall discard the frame, send a Request Break message to the SL state machines (see 7.14) and shall terminate the state machine.

Otherwise, this state shall send a Frame Received confirmation to the port layer.

This state shall request idle dwords be transmitted by repeatedly sending Transmit Idle Dword messages to the SMP transmitter.

7.18.5.4.2.2 Transition SMP_TP1:Receive_Frame to SMP_TP2:Transmit_Frame

This transition shall occur after sending a Frame Received confirmation to the port layer.

7.18.5.4.3 SMP_TP2:Transmit_Frame state

If this state receives an SMP Transmit Break request, this state shall send a Request Break message to the SL state machines and terminate.

If this state receives a Tx Frame request, this state shall send a Transmit Frame message to the SMP transmitter with an argument containing the frame contents, then wait for a Frame Transmitted message. After receiving a Frame Transmitted message, this state shall send a Frame Transmitted confirmation to the port layer, send a Request Close message to the SL state machines (see 7.14) and terminate.

After sending Transmit Frame message to the SMP transmitter, this state shall request idle dwords be transmitted by repeatedly sending Transmit Idle Dword messages to the SMP transmitter.

Page: 418

● Author: RElliott
Subject: Highlight
Date: 8/29/2008 2:47:42 PM
 ACCEPT - DONE

shall discard

add "SOF Received message and"
to match stx-ghoulder comment on page 399

● Author: RElliott
Subject: Highlight
Date: 8/30/2008 12:23:37 PM
 ACCEPT - DONE

terminate the state machine

the s/b this
per 08-343

● Author: RElliott
Subject: Highlight
Date: 6/30/2008 6:16:52 PM
 ACCEPT - DONE

258
s/b
257

to match 4+1024+4 limit being imposed in chapters 9 and 10

● Author: RElliott
Subject: Note
Date: 6/30/2008 6:16:52 PM
 ACCEPT - DONE

Add "(i.e., nnn bytes)" to make these dword counts easier to find

● Author: RElliott
Subject: Note
Date: 6/30/2008 6:16:52 PM
 ACCEPT - DONE

Add:
NOTE: SMP initiator phys compliant with previous versions of the standard may send vendor-specific SMP frames containing 258 data dwords.

● Author: lsi-gpenokie
Subject: Highlight
Date: 5/6/2008 4:07:49 PM
 ACCEPT - DONE (added "either" - see earlier comment)

It seems like this << or >> should be << and >> but that would be a different requirement in that the state would do both a and b rather than have to pick either a or b. I'm not sure which was intended.

● Author: RElliott
Subject: Highlight

Comments from page 418 continued on next page

If this state receives a subsequent SOF Received message after receiving an SOF Received message but before receiving an EOF Received message (i.e., SOF, data dwords, SOF, data dwords, and EOF instead of SOF, data dwords, EOF, SOF, data dwords, and EOF), then this state shall discard the Data Dword Received messages received before the subsequent SOF Received message.

This state shall discard the frame, send a Request Break message to the SL state machines (see 7.14) and shall terminate the state machine if:

- a) this state receives more than 258 Data Dword Received messages after an SOF Received message and before an EOF Received message; or
- b) this state receives fewer than 2 Data Dword Received messages after an SOF Received message and before an EOF Received message.

If this state receives an Invalid Dword Received message or an ERROR Received message after an SOF Received message and before an EOF Received message, then this state machine shall:

- a) ignore the invalid dword or ERROR; or
- b) discard the frame, send a Request Break message to the SL state machines (see 7.14) and shall terminate the state machine.

If the SMP request frame is received with a CRC error, this state shall discard the frame, send a Request Break message to the SL state machines (see 7.14) and shall terminate the state machine.

Otherwise, this state shall send a Frame Received confirmation to the port layer.

This state shall request idle dwords be transmitted by repeatedly sending Transmit Idle Dword messages to the SMP transmitter.

7.18.5.4.2.2 Transition SMP_TP1:Receive_Frame to SMP_TP2:Transmit_Frame

This transition shall occur after sending a Frame Received confirmation to the port layer.

7.18.5.4.3 SMP_TP2:Transmit_Frame state

If this state receives an SMP Transmit Break request, this state shall send a Request Break message to the SL state machines and terminate.

If this state receives a Tx Frame request, this state shall send a Transmit Frame message to the SMP transmitter with an argument containing the frame contents, then wait for a Frame Transmitted message. After receiving a Frame Transmitted message, this state shall send a Frame Transmitted confirmation to the port layer, send a Request Close message to the SL state machines (see 7.14) and terminate.

After sending Transmit Frame message to the SMP transmitter, this state shall request idle dwords be transmitted by repeatedly sending Transmit Idle Dword messages to the SMP transmitter.

Date: 8/30/2008 12:23:31 PM

T ACCEPT - DONE

terminate the state machine

the s/b this
per 08-343

Author: RElliott

Subject: Highlight

Date: 6/30/2008 6:16:52 PM

T ACCEPT - DONE

this
s/b
then this

Author: RElliott

Subject: Highlight

Date: 8/30/2008 12:23:19 PM

T ACCEPT - DONE

terminate the state machine

the s/b this
per 08-343

Author: RElliott

Subject: Highlight

Date: 6/30/2008 6:16:52 PM

T ACCEPT - DONE

this
s/b
then this

Author: RElliott

Subject: Highlight

Date: 8/30/2008 12:24:48 PM

T ACCEPT - DONE

terminate
s/b
terminate this state machine

per 08-343

Author: RElliott

Subject: Highlight

Date: 6/30/2008 6:16:52 PM

T ACCEPT - DONE

this
s/b
then this

Author: RElliott

Subject: Highlight

Date: 8/30/2008 12:25:01 PM

Comments from page 418 continued on next page

If this state receives a subsequent SOF Received message after receiving an SOF Received message but before receiving an EOF Received message (i.e., SOF, data dwords, SOF, data dwords, and EOF instead of SOF, data dwords, EOF, SOF, data dwords, and EOF), then this state shall discard the Data Dword Received messages received before the subsequent SOF Received message.

This state shall discard the frame, send a Request Break message to the SL state machines (see 7.14) and shall terminate the state machine if:

- a) this state receives more than 258 Data Dword Received messages after an SOF Received message and before an EOF Received message; or
- b) this state receives fewer than 2 Data Dword Received messages after an SOF Received message and before an EOF Received message.

If this state receives an Invalid Dword Received message or an ERROR Received message after an SOF Received message and before an EOF Received message, then this state machine shall:

- a) ignore the invalid dword or ERROR; or
- b) discard the frame, send a Request Break message to the SL state machines (see 7.14) and shall terminate the state machine.

If the SMP request frame is received with a CRC error, this state shall discard the frame, send a Request Break message to the SL state machines (see 7.14) and shall terminate the state machine.

Otherwise, this state shall send a Frame Received confirmation to the port layer.

This state shall request idle dwords be transmitted by repeatedly sending Transmit Idle Dword messages to the SMP transmitter.

7.18.5.4.2 Transition SMP_TP1:Receive_Frame to SMP_TP2:Transmit_Frame

This transition shall occur after sending a Frame Received confirmation to the port layer.

7.18.5.4.3 SMP_TP2:Transmit_Frame state

If this state receives an SMP Transmit Break request, this state shall send a Request Break message to the SL state machines and terminate.

If this state receives a Tx Frame request, this state shall send a Transmit Frame message to the SMP transmitter with an argument containing the frame contents, then wait for a Frame Transmitted message. After receiving a Frame Transmitted message, this state shall send a Frame Transmitted confirmation to the port layer, send a Request Close message to the SL state machines (see 7.14) and terminate.

After sending Transmit Frame message to the SMP transmitter, this state shall request idle dwords be transmitted by repeatedly sending Transmit Idle Dword messages to the SMP transmitter.

T ACCEPT - DONE

terminate

s/b

terminate this state machine

per 08-343

8 Port layer

8.1 Port layer overview

The port layer (PL) state machines interface with one or more SAS link layer state machines and one or more SSP, SMP, and STP transport layer state machines to establish port connections and disconnections. The port layer state machines also interpret or pass transmit data, receive data, commands, and confirmations between the link and transport layers.

8.2 PL (port layer) state machines

8.2.1 PL state machines overview

The PL (port layer) consists of state machines that run in parallel and perform the following functions:

- a) receive requests from the SSP, SMP, and STP transport layer state machines for connection management (e.g., requests to open or close connections) and frame transmission;
- b) send requests to the SAS link layer state machines for connection management and frame transmission;
- c) receive confirmation from the SAS link layer state machines; and
- d) send confirmations to the SSP, SMP, and STP transport layer state machines.

The port layer state machines are as follows:

- a) PL_OC (port layer overall control) state machines (see 8.2.2), and
- b) PL_PM (port layer phy manager) state machines (see 8.2.3).

There is one PL_OC state machine per port (see 4.1.4). There is one PL_PM state machine for each phy contained in the port. Phys are assigned to ports by the management application layer. More than one port in a SAS device may have the same SAS address.



● Author: wdc-mevans

Subject: Highlight

Date: 5/6/2008 4:07:49 PM

 REJECT (phy is true, but so is port, and port is the more surprising and the focus of clause 8)

port

s/b

phy

● Author: stx-goulder

Subject: Highlight

Date: 5/25/2008 8:09:16 PM

 ACCEPT - DONE

same SAS address.

add "same SAS address if the ports are in different SAS domains (see 4.2.7)."

● Author: hpq-relliott

Subject: Note

Date: 9/3/2008 4:00:38 PM

 ACCEPT - DONE (

9/3 Hard Reset message from PL_OC to PL_PM replaces HARD_RESET Received processing in PL_PM.

7/14 yes, add the communication from PL_OC to the PL_PM to tell each phy that one of its peers was reset.)

PL_OC should be the sole recipient of HARD_RESET Received confirmations from the link layer. PL_PMs should not look at that confirmation from all the phys in the port (as it is implied they are doing, as written). PL_OC should distribute it as a message to all the PL_PMs in the port.

Figure 206 shows examples of the port layer state machines and their interaction with the transport and link layers.

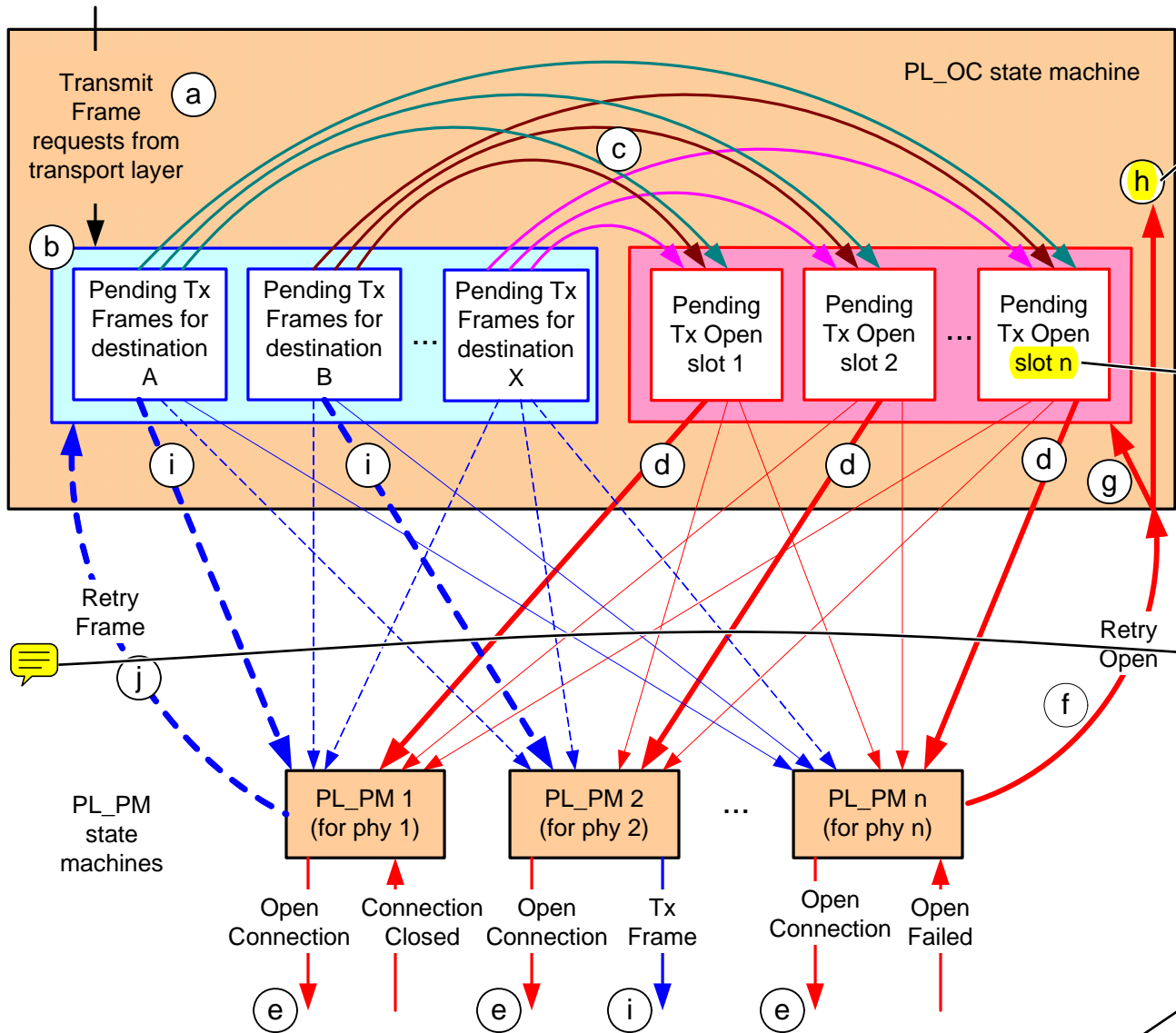



Figure 206 — Port layer examples

The following is a description of the example processes in figure 206. These example processes do not describe all of the possible condition or actions.

- Transmit Frame requests are received by the PL_OC state machine;
- the PL_OC state machine converts Transmit Frame requests into pending Tx Frame messages associated with the destination SAS address;
- the PL_OC state machine generates a pending Tx Open message for a pending Tx Frame message when there is a pending Tx Open slot available (i.e., the number of pending Tx Open messages is less than or equal to the number of phys);
- the PL_OC state machine sends a pending Tx Open message as a Tx Open message to a PL_PM state machine when a PL_PM machine is available; a slot is then available for a new pending Tx Open message;
- when a PL_PM state machine receives a Tx Open message, the PL_PM state machine attempts to establish a connection with the destination SAS address through the link layer;
- if a PL_PM state machine is unable to establish a connection with the destination SAS address, then the PL_PM state **machine sends** a Retry Open message to the PL_OC state machine;

● Author: wdc-mevans
Subject: Highlight
Date: 9/2/2008 7:57:44 PM

 REJECT (7/14 Brian Day's 08-216 resolves the need for this without adding arrows.

5/5 consider cases that result in confirmation to transport layer. An arc from PL_PM labeled Unable to Connect reaching through PL_OC to the transport layer might be best. That covers the remaining case h) that treats Retry Open like Unable to Connect.)

h
s/b
[There are two possibilities here: either the PL_OC state machine may create a new Pending Tx Open for the Pending Tx Frame, or the state machine may send the appropriate Transmission Status confirmation (e.g., No Destination) to the transport layer. I've tried to describe this in the text below, but I'm not sure what to do with the arrows. Possibly there could be an arrow like the one on the right in the figure going the other way (i.e., to the transport layer) including the confirmation. I think this is all correctly defined in detail in 8.2.2.3.4.]

● Author: RElliott
Subject: Highlight
Date: 9/2/2008 7:59:16 PM

 ACCEPT - DONE

Brian Day's 08-216r1 changes
slot n
to
slot z

● Author: RElliott
Subject: Note
Date: 9/3/2008 5:52:49 PM

 REFER PROTOCOL WG

08-216r1 change seems to preclude sending more than one OPEN simultaneously to the same destination (if phys are available), which needs to be allowed.

● Author: wdc-mevans
Subject: Highlight
Date: 5/30/2008 6:46:28 PM

 REJECT (item j) doesn't say that the Tx Frame is discarded.)

machine sends
s/b
machine discards the Tx Open message and sends

- g) after the Reject To Open Limit timer, if any, has expired, and if there is a pending Tx Open slot available, then the PL_OC state machine converts a Retry Open message to a pending Tx Open message with the pathway blocked count and arbitration wait time context from the Retry Open message applied to the pending Tx Open message;
- h) if the PL_OC state machine does not convert a Retry Open to a pending Tx Open frame, then the PL_OC discards the Retry Open message. The PL_OC state machine may create a new Tx Open message for the same pending Tx Frame at a later time. If the PL_OC state machine discards a Retry Open message, then the pathway blocked count and arbitration wait time context from the Retry Open message are also discarded;
- i) after a PL_PM state machine establishes a connection with a destination SAS address, the PL_OC state machine sends pending Tx Frame messages for the destination to the PL_PM state machine as Tx Frame messages;
- j) if a PL_PM state machine is unable to send a Tx Frame message to the link layer as a Tx Frame request (e.g., due to a credit timeout), then the PL_PM state machine sends a Retry Frame message to the PL_OC state machine, and the PL_OC state machine converts the Retry Frame message into a pending Tx Frame message; and
- k) if the PL_PM state machine is able to send a Tx Frame message as a Tx Frame request to the link layer, then the PL_PM state machine sends a Transmission Status confirmation to the transport layer.

The Transmission Status confirmation from either the PL_OC state machine or a PL_PM state machine shall include the following as arguments:

- a) tag;
- b) destination SAS address; and
- c) source SAS address.

8.2.2 PL_OC (port layer overall control) state machine

8.2.2.1 PL_OC state machine overview

A PL_OC state machine:

- a) receives requests from the SSP, SMP, and STP transport layers;
- b) sends messages to the PL_PM state machine;
- c) receives messages from the PL_PM state machine;
- d) selects frames to transmit;
- e) selects phys on which to transmit frames;
- f) receives confirmations from the link layer;
- g) sends confirmations to the transport layer;
- h) has Arbitration Wait Time timers;
- i) has I_T Nexus Loss timers; and
- j) may have Reject To Open Limit timers.

This state machine consists of the following states:

- a) PL_OC1:Idle (see 8.2.2.2) (initial state); and
- b) PL_OC2:Overall_Control (see 8.2.2.3).

After power on this state machine shall start in the PL_OC1:Idle state.

The PL_OC state machine shall maintain:

- a) a pool of pending Tx Frame messages for each destination SAS address; and
- b) as many pending Tx Open message slots as there are phys in the port.

Page: 421

Author: wdc-mevans

Subject: Highlight

Date: 6/26/2008 3:34:50 PM

T REJECT (that would change the meaning. "after" implies waiting for the timer to expire, then doing the comparison. Just saying "if the timer has expired" does not indicate what time to apply this test).

after the Reject To Open Limit timer, if any, has expired, and if there is a pending Tx Open slot available,
s/b
if there is a pending Tx Open slot available, and the Reject To Open Limit timer, if any, has expired,

Author: wdc-mevans

Subject: Highlight

Date: 7/17/2008 6:30:53 PM

T ACCEPT - DONE (7/14 do it, do not add another line in the figure going upstream)

time.
s/b
time or send the appropriate Transmission Status confirmation (e.g., No Destination) to the transport layer.

Author: RElliott

Subject: Highlight

Date: 8/30/2008 4:57:54 PM

T ACCEPT - DONE

A PL_OC state machine
s/b
The PL_OC state machine

Author: RElliott

Subject: Highlight

Date: 8/30/2008 3:28:49 PM

T ACCEPT - DONE

After power on
move to end of sentence

Author: RElliott

Subject: Highlight

Date: 8/30/2008 4:58:16 PM

T ACCEPT - DONE

The PL_OC state machine
s/b
This state machine

Author: wdc-mevans

Subject: Highlight

Date: 6/2/2008 10:31:41 AM

T REJECT (they are also based on Retry Frames from this layer... just keeping the wording generic now seems better)

address; and
s/b
address based on transmit frame requests from the transport layer; and

The PL_OC state machine shall maintain the timers listed in table 159.

Table 159 — PL_OC state machine timers

Timer	Maximum number of timers	Initial value
I_T Nexus Loss timer	One per destination SAS address	Depending on the protocol used by the port: <ul style="list-style-type: none"> a) for SSP target ports, the value in the I_T NEXUS LOSS TIME field in the Protocol-Specific Port mode page (see 10.2.7.4); b) for SSP initiator ports, the value in the I_T NEXUS LOSS TIME field in the Protocol-Specific Port mode page for the SSP target port with that destination SAS address (see 10.2.7.4); c) for STP target ports, the value in the STP SMP I_T NEXUS LOSS TIME field in the SMP CONFIGURE GENERAL function (see 10.4.3.18); d) for STP initiator ports, the value in the STP SMP I_T NEXUS LOSS TIME field in the SMP REPORT GENERAL function (see 10.4.3.4) for the STP target port with that destination SAS address; or e) for SMP initiator ports, the value in the STP SMP I_T NEXUS LOSS TIME field in the SMP REPORT GENERAL function (see 10.4.3.4).
Arbitration Wait Time timer	One per pending Tx Open message	0000h, a vendor-specific value less than 8000h (see 7.12.3), or the value received with a Retry Open message.
Reject To Open Limit timer	One per Retry Open message	Depending on the protocol used by the port: <ul style="list-style-type: none"> a) for SSP target ports, the value in the REJECT TO OPEN LIMIT field in the Protocol-Specific Port mode page (see 10.2.7.4); b) for SSP initiator ports, a vendor specific value; c) for STP target ports, the value in the STP REJECT TO OPEN LIMIT field in the SMP CONFIGURE GENERAL function (see 10.4.3.18); or d) for STP initiator ports, a vendor specific value.

Author: RElliott
Subject: Highlight
Date: 8/30/2008 4:58:21 PM
ACCEPT - DONE



The PL_OC state machine
s/b
This state machine

Figure 207 shows the PL_OC state machine.

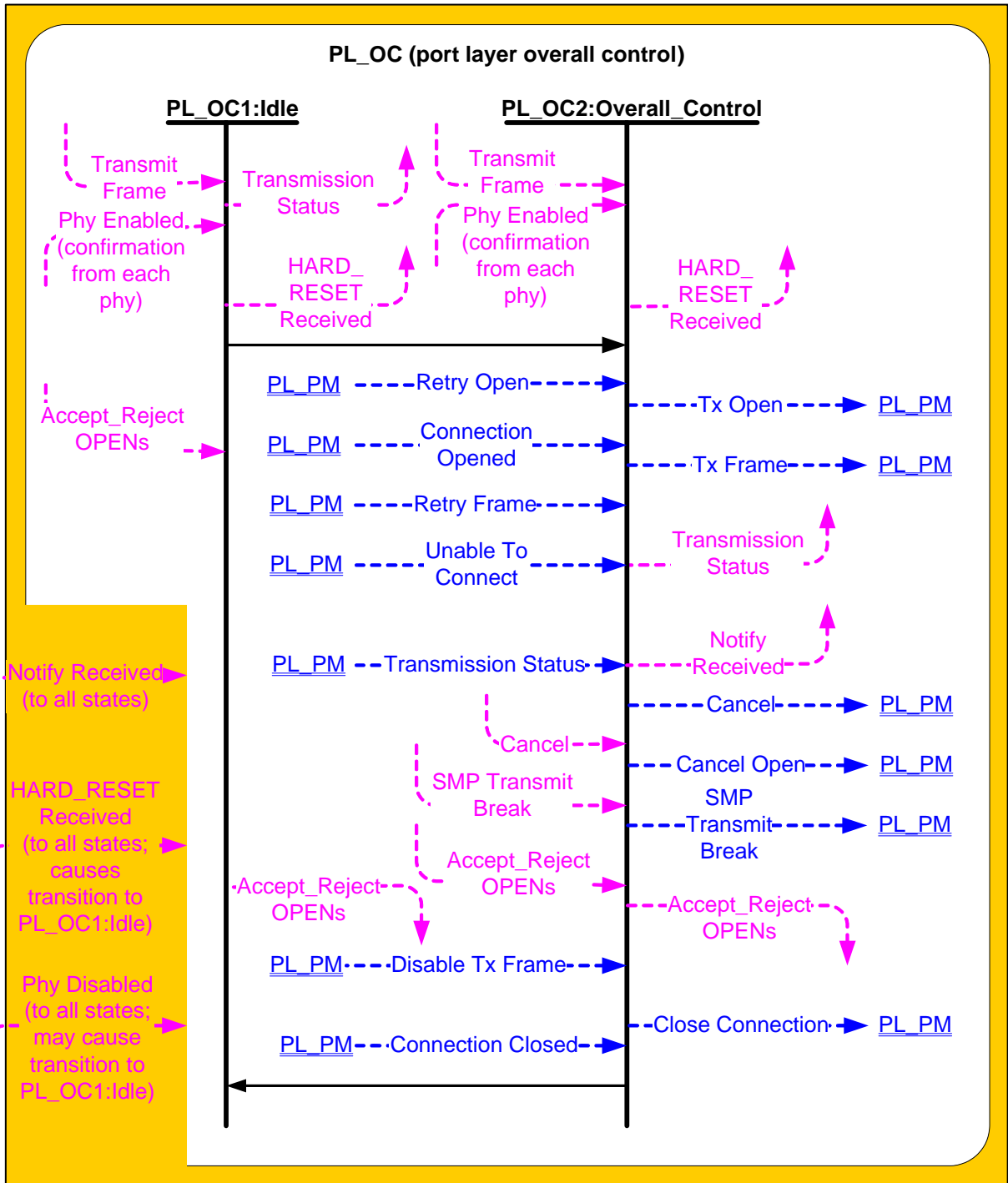

Figure 207 — PL_OC (port layer overall control) state machine

8.2.2.2 PL_OC1:Idle state

8.2.2.2.1 PL_OC1:Idle state description

This state is the initial state of the PL_OC state machine.

If this state receives a HARD_RESET Received confirmation, then this state shall send a HARD_RESET Received confirmation to the transport layer.

This page contains no comments

If this state receives a Notify Received (Power Loss Expected) confirmation, then this state shall send a Notify Received (Power Loss Expected) confirmation to the transport layer.

If this state receives an **Accept_Reject Opens** request, then this state shall send an **Accept_Reject Opens** request to all link layers in the port.

If this state receives a Transmit Frame request, then this state shall send a Transmission Status (No Phys In Port) confirmation to the transport layer.

If an I_T Nexus Loss timer expires for a destination **SAS address, this state shall** perform the following:

- a) delete the I_T Nexus Loss timer for the SAS address;
- b) send a Transmission Status (I_T Nexus Loss) confirmation for each pending Tx Frame message for the SAS address, and
- c) discard each pending Tx Frame message for the SAS address and any corresponding pending Tx Open messages.

If the port is an STP target port or an STP **initiator port, the port shall** handle all pending commands as described in 4.5.

8.2.2.2 Transition PL_OC1:Idle to PL_OC2:Overall_Control

This transition shall occur after a Phy Enabled confirmation is received for at least one phy assigned to the port.

8.2.2.3 PL_OC2:Overall_Control state

8.2.2.3.1 PL_OC2:Overall_Control state overview

This state may receive Transmit Frame requests from the transport layers (i.e., **SSP and SMP**) and Retry frame messages from PL_PM state machines. This state shall create a pending Tx Frame message for each received Transmit Frame request and Retry Frame message. There may be more than one pending Tx Frame message at a time for each SSP transport layer. There shall be only one pending Tx Frame message at a time for each SMP transport layer.

This state selects PL_PM state machines through which connections are established. This state shall only attempt to establish connections through PL_PM state machines whose phys are enabled. **In a vendor-specific manner, this state selects PL_PM state machines on which connections are established to transmit frames.** This state shall receive a response to a message from a PL_PM state machine before sending another message to that PL_PM state machine.

This state also:

- a) receives connection management requests from the transport layers;
- b) sends connection management messages to PL_PM state machines;
- c) receives connection management messages from PL_PM state machines; and
- d) sends connection management confirmations to the transport layers.

After receiving a Transmit Frame request for a destination SAS address for which there is no connection established and for which no I_T Nexus Loss timer has been created, this state shall create an I_T Nexus Loss timer for that SAS address if:

- a) the protocol is SSP, the port is an SSP target port, the Protocol-Specific Port mode page is implemented, and the I_T NEXUS LOSS TIME field in the Protocol-Specific Port mode page (see 10.2.7.4) is not set to 0000h;
- b) the protocol is STP, the port is an STP target port, and the STP SMP I_T NEXUS LOSS TIME field in the SMP CONFIGURE GENERAL function is not set to 0000h; or
- c) the protocol is SMP, the port is an SMP initiator port, and the STP SMP I_T NEXUS LOSS TIME field in the SMP CONFIGURE GENERAL function is not set to 0000h.

This state may create an I_T Nexus Loss timer for that SAS address if:

- a) the protocol is SSP and the port is an SSP initiator port; or;
- b) the protocol is STP and the port is an STP initiator port.

Page: 424

Author: RElliott
Subject: Highlight
Date: 8/30/2008 3:09:01 PM
 ACCEPT - DONE

Accept_Reject Opens
s/b
Accept_Reject OPENS

Author: RElliott
Subject: Highlight
Date: 8/30/2008 3:09:06 PM
 ACCEPT - DONE

Accept_Reject Opens
s/b
Accept_Reject OPENS

Author: RElliott
Subject: Underline
Date: 9/4/2008 9:38:45 AM
 REFER PROTOCOL WG (7/14 George Penokie volunteered to work on this issue)

Transmission Status (No Phys In Port) confirmation

This is not mentioned anywhere else. The fact that Transmission Status is returned might be sufficient, but it should be investigated whether the transport layer is supposed to do something special with that (e.g., treat as an I_T nexus loss).

It needs to be mentioned in both SSP and SMP transport layers.

Author: RElliott
Subject: Note
Date: 7/14/2008 8:22:53 PM
 REFER PROTOCOL WG (7/14 George Penokie volunteered to work on this issue)

6/18 should allow an I_T nexus loss time before giving up on the port, probably for both cases)

(from Bill Martin, Emulex)

In 8.2.2.2.1, the port layer state machine may return Transmission Status (No Phys In Port). In two of the three Link layer states that this could be received in, there is a general statement that covers this; however, in 9.2.6.3.3.3.1 first paragraph on page 489 there is a pointer to table 187 which does not deal with the Transmission Status (No Phys In Port). This Transmission Status is also not covered in table 188.

There are two issues that should be addressed:

- a) 9.2.6.3.3.3.1, first paragraph on page 489 should add an additional reference to table 188
 - b) Table 188 should have a reference to Transmission Status (No Phys In Port)
-

Author: lsi-gpenokie
Subject: Highlight
Date: 5/6/2008 4:07:49 PM
 ACCEPT - DONE

This << SAS address, this state shall >> should be << SAS address, then this state shall >>

Author: lsi-gpenokie
Subject: Highlight

Comments from page 424 continued on next page

If this state receives a Notify Received (Power Loss Expected) confirmation, then this state shall send a Notify Received (Power Loss Expected) confirmation to the transport layer.

If this state receives an **Accept_Reject Opens** request, then this state shall send an **Accept_Reject Opens** request to all link layers in the port.

If this state receives a Transmit Frame request, then this state shall send a Transmission Status (No Phys In Port) confirmation to the transport layer.

If an I_T Nexus Loss timer expires for a destination **SAS address, this state shall** perform the following:

- a) delete the I_T Nexus Loss timer for the SAS address;
- b) send a Transmission Status (I_T Nexus Loss) confirmation for each pending Tx Frame message for the SAS address; and
- c) discard each pending Tx Frame message for the SAS address and any corresponding pending Tx Open messages.

If the port is an STP target port or an STP **initiator port, the port shall** handle all pending commands as described in 4.5.

8.2.2.2 Transition PL_OC1:Idle to PL_OC2:Overall_Control

This transition shall occur after a Phy Enabled confirmation is received for at least one phy assigned to the port.

8.2.2.3 PL_OC2:Overall_Control state

8.2.2.3.1 PL_OC2:Overall_Control state overview

This state may receive Transmit Frame requests from the transport layers (i.e., **SSP and SMP**) and Retry frame messages from PL_PM state machines. This state shall create a pending Tx Frame message for each received Transmit Frame request and Retry Frame message. There may be more than one pending Tx Frame message at a time for each SSP transport layer. There shall be only one pending Tx Frame message at a time for each SMP transport layer.

This state selects PL_PM state machines through which connections are established. This state shall only attempt to establish connections through PL_PM state machines whose phys are enabled. **In a vendor-specific manner, this state selects PL_PM state machines on which connections are established to transmit frames.** This state shall receive a response to a message from a PL_PM state machine before sending another message to that PL_PM state machine.

This state also:

- a) receives connection management requests from the transport layers;
- b) sends connection management messages to PL_PM state machines;
- c) receives connection management messages from PL_PM state machines; and
- d) sends connection management confirmations to the transport layers.

After receiving a Transmit Frame request for a destination SAS address for which there is no connection established and for which no I_T Nexus Loss timer has been created, this state shall create an I_T Nexus Loss timer for that SAS address if:

- a) the protocol is SSP, the port is an SSP target port, the Protocol-Specific Port mode page is implemented, and the I_T NEXUS LOSS TIME field in the Protocol-Specific Port mode page (see 10.2.7.4) is not set to 0000h;
- b) the protocol is STP, the port is an STP target port, and the STP SMP I_T NEXUS LOSS TIME field in the SMP CONFIGURE GENERAL function is not set to 0000h; or
- c) the protocol is SMP, the port is an SMP initiator port, and the STP SMP I_T NEXUS LOSS TIME field in the SMP CONFIGURE GENERAL function is not set to 0000h.

This state may create an I_T Nexus Loss timer for that SAS address if:

- a) the protocol is SSP and the port is an SSP initiator port; or;
- b) the protocol is STP and the port is an STP initiator port.

Date: 5/6/2008 4:07:49 PM

T ACCEPT - DONE

This << initiator port, the port shall >> should be << initiator port, then the port shall >>

Author: stx-goulder

Subject: Highlight

Date: 5/6/2008 4:07:49 PM

T REJECT (No, for STP the port layer just attaches the STP transport layer to the STP link layer and gets out of the way. Both of those layers are defined by SATA, not SAS. They may or may not have a message called Transmit Frame)

SSP and SMP)

Can't STP transport layer also generate Transmit Frame requests?

Author: lsi-gpenokie

Subject: Highlight

Date: 5/6/2008 4:07:49 PM

T REJECT (I think it used to be worded that way, but that leaves what is "vendor-specific" unclear. The selection is supposed to be vendor specific, not transmitting frames.)

This << In a vendor-specific manner, this state selects PL_PM state machines on which connections are established to transmit frames. >> should be << This state selects PL_PM state machines on which connections are established to transmit frames in a vendor-specific manner. >>

When this state creates an I_T Nexus Loss timer it shall:

- 1) initialize the I_T Nexus Loss timer as specified in table 159 (see 8.2.2.1); and
- 2) not start the I_T Nexus Loss timer.

If this state machine is in an SSP initiator port, then this state may create an I_T Nexus Loss timer for the SAS address. If a state machine in an SSP initiator port ~~and creates an I_T Nexus Loss timer~~, then the state machine should use the value in the I_T NEXUS LOSS TIME field in the Protocol-Specific Port mode page for the SSP target port (see 10.2.7.4) as the initial value for its I_T Nexus Loss timer.

If there are no pending Tx Frame messages for a destination SAS address and an I_T Nexus Loss timer has been created for that destination SAS address, then this state shall delete the I_T Nexus Loss timer for that destination SAS address.

If this state receives a HARD_RESET Received confirmation, then this state shall discard all pending Tx Frame messages and delete all I_T Nexus Loss timers and send a HARD_RESET Received confirmation to the transport layer.

If this state receives a Notify Received (Power Loss Expected) confirmation, then this state shall:

- a) discard all pending Tx Frame messages, if any;
- b) delete all I_T Nexus Loss timers, if any;
- c) send a Close Connection message to all the PL_PM state machines;
- d) send a Cancel Open message to all the PL_PM state machines; and
- e) send a Notify Received (Power Loss Expected) confirmation to the transport layer.

8.2.2.3.2 PL_OC2:Overall_Control state establishing connections

This state receives Phy Enabled confirmations indicating when a phy is available.

This state receives Retry Open messages from a PL_PM state machine.

This state creates pending Tx Open messages based on pending Tx Frame messages and Retry Open messages. Pending Tx Open messages are sent to a PL_PM state machine as Tx Open messages.

If this state receives a Retry Open (Retry) message, then this state shall process the Retry Open message.

If this state receives a **Retry Open (No Destination)** or a Retry Open (Open Timeout Occurred) message and an I_T Nexus Loss timer has not been created for the destination SAS address (e.g., an SSP target port does not support the I_T NEXUS LOSS TIME field in the Protocol-Specific Port mode page or the field is set to 0000h), then this state shall process the Retry Open message as either a Retry Open message or an Unable To Connect message. This selection is vendor-specific.

If this state receives a Retry Open (Pathway Blocked) message and an I_T Nexus Loss timer has not been created for the destination SAS address, then this state shall process the Retry Open message.

If this state receives a **Retry Open (No Destination)**, **Retry Open (Open Timeout Occurred)**, or Retry Open (Pathway Blocked) message, and an I_T Nexus Loss timer has been created for the destination SAS address with an initial value of FFFFh, then this state shall process the Retry Open message (i.e., the Retry Open message is never processed as an Unable to Connect message).

If this state receives a **Retry Open (No Destination)** or a Retry Open (Open Timeout Occurred) message, an I_T Nexus Loss timer has been created for the destination SAS address, and there is no connection established with the destination SAS address, then this state shall check the I_T Nexus Loss timer, and:

- a) if the I_T Nexus Loss timer is not running, the I_T nexus loss time is not set to FFFFh, and the CONFIGURING bit is set to zero in the REPORT GENERAL response (see 10.4.3.4) for each expander device between this port and the destination port that is two or more levels away from this port, then this state shall start the timer;
- b) if the I_T Nexus Loss timer is not running and the I_T nexus loss time is not set to FFFFh, then this state shall start the timer;
- c) if the I_T Nexus Loss timer is running, then this state shall not stop the timer; and
- d) if the I_T Nexus Loss timer has expired, then this state shall process the Retry Open message as if it were an Unable To Connect message (see 8.2.2.3.4).



Author: wdc-mevans
Subject: Cross-Out
Date: 5/25/2008 8:10:38 PM
ACCEPT - DONE

and
s/b
[Delete the extraneous word.]

Author: wdc-mevans
Subject: Highlight
Date: 6/26/2008 3:40:43 PM
ACCEPT - DONE (using "all" rather than "any" in a)b)c) and not using "that are present in the state machine")

shall discard all pending Tx Frame messages and delete all I_T Nexus Loss timers and send a HARD_RESET Received confirmation to the transport layer.

s/b

shall:

- a) discard any pending Tx Frame messages;
 - b) discard any pending Tx Open messages;
 - c) delete any timers that are present in the state machine (i.e., I_T Nexus Loss timers, Arbitration Wait Time timers, and Reject To Open Limit timers); and
 - d) send a HARD_RESET Received confirmation to the transport layer.
-

Author: wdc-mevans
Subject: Highlight
Date: 6/26/2008 3:40:50 PM
ACCEPT - DONE (with "all" instead of "any" in a)b)c) and "each" instead of "all" in d)e), and not using "that are present in the state machine")

- a) discard all pending Tx Frame messages, if any;
- b) delete all I_T Nexus Loss timers, if any;
- c) send a Close Connection message to all the PL_PM state machines;
- d) send a Cancel Open message to all the PL_PM state machines; and
- e) send a Notify Received (Power Loss Expected) confirmation to the transport layer.

s/b

shall:

- a) discard any pending Tx Frame messages;
 - b) discard any pending Tx Open messages;
 - c) delete any timers that are present in the state machine (i.e., I_T Nexus Loss timers, Arbitration Wait Time timers, and Reject To Open Limit timers);
 - d) send a Close Connection message to all of the PL_PM state machines;
 - e) send a Cancel Open message to all of the PL_PM state machines; and
 - f) send a Notify Received (Power Loss Expected) confirmation to the transport layer.
-

Author: RElliott
Subject: Highlight
Date: 8/30/2008 12:22:01 PM
ACCEPT - DONE

Retry Open (No Destination)
add
message

per 08-343

Author: RElliott
Subject: Highlight
Date: 8/30/2008 12:22:18 PM
ACCEPT - DONE

When this state creates an I_T Nexus Loss timer it shall:

- 1) initialize the I_T Nexus Loss timer as specified in table 159 (see 8.2.2.1); and
- 2) not start the I_T Nexus Loss timer.

If this state machine is in an SSP initiator port, then this state may create an I_T Nexus Loss timer for the SAS address. If a state machine in an SSP initiator port ~~and~~ creates an I_T Nexus Loss timer, then the state machine should use the value in the I_T NEXUS LOSS TIME field in the Protocol-Specific Port mode page for the SSP target port (see 10.2.7.4) as the initial value for its I_T Nexus Loss timer.

If there are no pending Tx Frame messages for a destination SAS address and an I_T Nexus Loss timer has been created for that destination SAS address, then this state shall delete the I_T Nexus Loss timer for that destination SAS address.

If this state receives a HARD_RESET Received confirmation, then this state shall discard all pending Tx Frame messages and delete all I_T Nexus Loss timers and send a HARD_RESET Received confirmation to the transport layer.

If this state receives a Notify Received (Power Loss Expected) confirmation, then this state shall:

- a) discard all pending Tx Frame messages, if any;
- b) delete all I_T Nexus Loss timers, if any;
- c) send a Close Connection message to all the PL_PM state machines;
- d) send a Cancel Open message to all the PL_PM state machines; and
- e) send a Notify Received (Power Loss Expected) confirmation to the transport layer.

8.2.2.3.2 PL_OC2:Overall_Control state establishing connections

This state receives Phy Enabled confirmations indicating when a phy is available.

This state receives Retry Open messages from a PL_PM state machine.

This state creates pending Tx Open messages based on pending Tx Frame messages and Retry Open messages. Pending Tx Open messages are sent to a PL_PM state machine as Tx Open messages.

If this state receives a Retry Open (Retry) message, then this state shall process the Retry Open message.

If this state receives a **Retry Open (No Destination)** or a Retry Open (Open Timeout Occurred) message and an I_T Nexus Loss timer has not been created for the destination SAS address (e.g., an SSP target port does not support the I_T NEXUS LOSS TIME field in the Protocol-Specific Port mode page or the field is set to 0000h), then this state shall process the Retry Open message as either a Retry Open message or an Unable To Connect message. This selection is vendor-specific.

If this state receives a Retry Open (Pathway Blocked) message and an I_T Nexus Loss timer has not been created for the destination SAS address, then this state shall process the Retry Open message.

If this state receives a **Retry Open (No Destination), Retry Open (Open Timeout Occurred),** or Retry Open (Pathway Blocked) message, and an I_T Nexus Loss timer has been created for the destination SAS address with an initial value of FFFFh, then this state shall process the Retry Open message (i.e., the Retry Open message is never processed as an Unable to Connect message).

If this state receives a **Retry Open (No Destination)** or a Retry Open (Open Timeout Occurred) message, an I_T Nexus Loss timer has been created for the destination SAS address, and there is no connection established with the destination SAS address, then this state shall check the I_T Nexus Loss timer, and:

- a) if the I_T Nexus Loss timer is not running, the I_T nexus loss time is not set to FFFFh, and the CONFIGURING bit is set to zero in the REPORT GENERAL response (see 10.4.3.4) for each expander device between this port and the destination port that is two or more levels away from this port, then this state shall start the timer;
- b) if the I_T Nexus Loss timer is not running and the I_T nexus loss time is not set to FFFFh, then this state shall start the timer;
- c) if the I_T Nexus Loss timer is running, then this state shall not stop the timer; and
- d) if the I_T Nexus Loss timer has expired, then this state shall process the Retry Open message as if it were an Unable To Connect message (see 8.2.2.3.4).

Retry Open (No Destination), Retry Open (Open Timeout Occurred),
add
message

per 08-343

● Author: RElliott
Subject: Highlight
Date: 8/30/2008 12:22:26 PM

 ACCEPT - DONE

Retry Open (No Destination)
add
message

per 08-343

● Author: RElliott
Subject: Note
Date: 6/30/2008 6:16:52 PM

 ACCEPT - DONE

Add:

NOTE: The port layer may require assistance from the management application layer to determine the values of the CONFIGURING bits; this interaction is not specified by this standard. Consequently, the I_T Nexus Loss timer may not start immediately after this state receives a Retry Open (No Destination) or a Retry Open (Open Timeout Occurred) message.

Noticed when splitting the CONFIGURING bit into SELF CONFIGURING and ZONE CONFIGURING per Isi-bbesmer comment on first page

If this state receives a Retry Open (Pathway Blocked) message, an I_T Nexus Loss timer has been created for the destination SAS address, and there is no connection established with the destination SAS address, then this state shall check the I_T Nexus Loss timer, and:

- a) if the I_T Nexus Loss timer is running, then this state shall not stop the timer; and
- b) if the I_T Nexus Loss timer has expired, then this state shall process the Retry Open message as if it were an Unable To Connect message (see 8.2.2.3.4).

If this state receives a **Retry Open (Retry)** and an I_T Nexus Loss timer is running for the destination SAS address, then this state shall:

- a) stop the I_T Nexus Loss timer (if the timer has been running); and
- b) initialize the I_T Nexus Loss timer.

This state shall create a pending Tx Open message if:

- a) this state has a pending Tx Frame message or has received a Retry Open message;
- b) this state has fewer pending Tx Open messages than the number of PL_PM state machines (i.e., the number of phys in the port);
- c) there is no pending Tx Open message for the destination SAS address; and
- d) there is no connection established with the destination SAS address.

This state may create a pending Tx Open message if:

- a) this state has a pending Tx Frame message, or this state has received a Retry Open message and has not processed the message by sending a confirmation; and
- b) this state has fewer pending Tx Open messages than the number of PL_PM state machines.

This state shall have no more pending Tx Open messages than the number of PL_PM state machines.

If this state receives a Retry Open message and there are pending Tx Frame messages for which pending Tx Open messages have not been created, then this state should create a pending Tx Open message from the Retry Open message.

If this state does not create a pending Tx Open message from a Retry Open message (e.g., the current number of pending Tx Open messages equals the number of phys), then this state shall discard the Retry Open message. This state may create a new pending Tx Open message at a later time for the pending Tx Frame message that resulted in the Retry Open message.

If this state receives a Retry Open (Opened By Destination) message and the initiator port bit and protocol arguments match those in the Tx Open messages that resulted in the Retry Open message, then this state may discard the Retry Open message and use the established connection to send pending Tx Frame messages as Tx Frame messages to the destination SAS address. If this state receives a Retry Open (Opened By Destination) **message, then, if this state has a pending Tx Open slot available, this** state may create a pending Tx Open message from the Retry Open message.

NOTE 82 - If a connection is established by another port as indicated by a Retry Open (Opened By Destination) message, credit may not be granted for frame transmission. In this case this state may create a pending Tx Open message from a Retry Open message in order to establish a connection where credit is granted.

This state shall send a pending Tx Open message as a Tx Open message to a PL_PM state machine that has an enabled phy and does not have a connection established. If there is more than one pending Tx Open message, **this** state should send a Tx Open message for the pending Tx Open message that has been pending for the longest time first.

If this state creates a pending Tx Open message from one of the following messages:

- a) Retry Open (Opened By Destination);
- b) Retry Open (Opened By Other);
- c) Retry Open (Collided);
- d) Retry Open (Pathway Blocked); or
- e) if the CONTINUE AWT bit is set to one in the Protocol-specific Port mode page (see 10.2.7.4), Retry Open (Retry),

● Author: stx-goulder
Subject: Highlight
Date: 5/6/2008 4:07:49 PM
T ACCEPT - DONE

Retry Open (Retry)
Add "message" after this phrase.

● Author: RElliott
Subject: Highlight
Date: 6/30/2008 6:16:52 PM
T ACCEPT - DONE

message, then, if this state has a pending Tx Open slot available, this
s/b
messand and this state has a pending Tx Open slot available, then

● Author: Isi-gpenokie
Subject: Highlight
Date: 6/26/2008 3:42:50 PM

T REJECT (this note is essentially an example explaining when the state might choose to do what is discussed in the sentence before the note)

This note << NOTE 82 - If a co >> should be normative text.

● Author: RElliott
Subject: Highlight
Date: 6/30/2008 6:16:52 PM
T ACCEPT - DONE

this
s/b
then this

then this state shall:

- 1) create an Arbitration Wait Time timer for the pending Tx Open message;
- 2) set the Arbitration Wait Time timer for the pending Tx Open message to the arbitration wait time argument from the Retry Open message; and
- 3) start the Arbitration Wait Time timer for the pending Tx Open message.

When a pending Tx Open message is sent to a PL_PM state machine as a Tx Open message, the Tx Open message shall contain the following arguments to be used in an OPEN address frame:

- a) initiator port bit from the Transmit Frame request;
- b) protocol from the Transmit Frame request;
- c) connection rate from the Transmit Frame request;
- d) initiator connection tag from the Transmit Frame request;
- e) destination SAS address from the Transmit Frame request;
- f) source SAS address from the Transmit Frame request;
- g) pathway blocked count; and
- h) arbitration wait time.

If this state creates a pending Tx Open message from one of the following:

- a) a Transmit Frame request;
- b) a Retry Open (No Destination) message;
- c) a Retry Open (Open Timeout Occurred) message; or
- d) if the CONTINUE AWT bit is set to zero in the Protocol-specific Port mode page (see 10.2.7.4), a Retry Open (Retry) message,

then this state shall:

- a) set the pathway blocked count argument in the Tx Open message to zero; and
- b) set the arbitration wait time argument in the Tx Open message to zero or a vendor-specific value less than 8000h (see 7.12.3).

If a pending Tx Open message was created as the result of this state receiving a Retry Open (Retry) message and:

- a) the protocol for the connection is SSP, the Protocol-Specific Port mode page is implemented, and the REJECT TO OPEN LIMIT field in the Protocol-Specific Port mode page (see 10.2.7.4) is not set to zero; or
- b) the protocol for the connection is STP and the STP REJECT TO OPEN LIMIT field is not set to zero in the SMP REPORT GENERAL response (see 10.4.3.4),

then this state shall:

- 1) create a Reject To Open Limit timer associated with the pending Tx Open message that received the Retry Open (Retry) message;
- 2) initialize the Reject To Open Limit timer as specified in table 159 (see 8.2.2.1);
- 3) start the Reject To Open Limit timer; and
- 4) wait at least until the Reject To Open Limit timer expires before sending a Tx Open message.

If a pending Tx Open message was created as the result this state receiving a Retry Open (Pathway Blocked) message, then this state shall set the pathway blocked count argument in the Tx Open message to the value of the pathway blocked count argument received with the message plus one, unless the pathway blocked count received with the argument is FFh.

If a pending Tx Open message was created as the result of this state receiving one of the following:

- a) a Retry Open (Opened By Destination) message;
- b) a Retry Open (Opened By Other) message;
- c) a Retry Open (Collided) message;
- d) a Retry Open (Pathway Blocked) message; or
- e) if the CONTINUE AWT bit is set to one in the Protocol-specific Port mode page (see 10.2.7.4), a Retry Open (Retry) message,

Author: stx-goulder
Subject: Highlight
Date: 6/2/2008 4:06:09 PM

T ACCEPT - DONE (All uses are correct as is. Adding 3 definitions to 3.1.xxx:

3.1.xx initiator connection tag: A value in the OPEN address frame used for SSP and STP connection requests to provide a SAS initiator port an alternative to using the SAS target port's SAS address for context lookup when the SAS target port originates a connection request. See 7.8.3.

3.1.xx initiator port transfer tag: A value that allows an SSP initiator port to establish a context for commands and task management functions. See 9.2.1.

3.1.xx target port transfer tag: An optional value that allows an SSP target port to establish the write data context when receiving a write DATA frame. See 9.2.1.

)

initiator connection tag

This term should be defined in Definitions clause. Should this term be used in place of "tag" in some or all of the other places where the meaning of tag is ambiguous?

Author: lsi-gpenokie
Subject: Highlight
Date: 5/25/2008 8:12:48 PM

T ACCEPT - DONE

This << page (see 10.2.7.4), a Retry >> should be << page (see 10.2.7.4), then a Retry >> so as not to confuse this with the then on the next line.

Author: lsi-bday
Subject: Highlight
Date: 8/27/2008 7:50:08 PM

T ACCEPT - DONE (7/14 Brian's proposal 08-216r0 fixes this.

put into pending Tx Open pool. WG discussion that it should be associated with the pool of Tx Frames for each destination SAS address instead. Brian will update proposal along those lines.)

If a pending...

This whole section adds the Reject To Open Limit timer after the Retry Open has been converted to a pending Tx Open. Since you can't have more Tx Opens than PL_PM state machines, this means you can't do new connections to other devices while this pending Tx Open is timing out. Change to be suggested in separate proposal.

Author: lsi-gpenokie
Subject: Highlight
Date: 6/26/2008 3:47:57 PM

T ACCEPT - DONE (reworded as:

"If a pending Tx Open message was created as the result this state receiving a Retry Open (Pathway Blocked) message, then:

a) if the Retry Open message pathway blocked count argument is FFh, then this state shall set the Tx Open pathway blocked count argument to FFh; or

b) if the Retry Open pathway blocked count argument is less than FFh, then this state shall set the Tx Open pathway blocked count argument to the Retry Open pathway blocked count argument plus 01h.

")

This << count received with the argument is FFh. >> should be << count received with the argument is FFh in which case the pathway blocked count shall not be changed. >>

Author: lsi-gpenokie
Subject: Highlight
Date: 5/25/2008 8:13:28 PM

T ACCEPT - DONE

This << page (see 10.2.7.4), a Retry Open (Retry) message >> should be << page (see 10.2.7.4), then a Retry Open (Retry)

then this state shall:

- 1) create an Arbitration Wait Time timer for the pending Tx Open message;
- 2) set the Arbitration Wait Time timer for the pending Tx Open message to the arbitration wait time argument from the Retry Open message; and
- 3) start the Arbitration Wait Time timer for the pending Tx Open message.

When a pending Tx Open message is sent to a PL_PM state machine as a Tx Open message, the Tx Open message shall contain the following arguments to be used in an OPEN address frame:

- a) initiator port bit from the Transmit Frame request;
- b) protocol from the Transmit Frame request;
- c) connection rate from the Transmit Frame request;
- d) initiator connection tag from the Transmit Frame request;
- e) destination SAS address from the Transmit Frame request;
- f) source SAS address from the Transmit Frame request;
- g) pathway blocked count; and
- h) arbitration wait time.

If this state creates a pending Tx Open message from one of the following:

- a) a Transmit Frame request;
- b) a Retry Open (No Destination) message;
- c) a Retry Open (Open Timeout Occurred) message; or
- d) if the CONTINUE AWT bit is set to zero in the Protocol-specific Port mode page (see 10.2.7.4), a Retry Open (Retry) message,

then this state shall:

- a) set the pathway blocked count argument in the Tx Open message to zero; and
- b) set the arbitration wait time argument in the Tx Open message to zero or a vendor-specific value less than 8000h (see 7.12.3).

If a pending Tx Open message was created as the result of this state receiving a Retry Open (Retry) message and:

- a) the protocol for the connection is SSP, the Protocol-Specific Port mode page is implemented, and the REJECT TO OPEN LIMIT field in the Protocol-Specific Port mode page (see 10.2.7.4) is not set to zero; or
- b) the protocol for the connection is STP and the STP REJECT TO OPEN LIMIT field is not set to zero in the SMP REPORT GENERAL response (see 10.4.3.4),

then this state shall:

- 1) create a Reject To Open Limit timer associated with the pending Tx Open message that received the Retry Open (Retry) message;
- 2) initialize the Reject To Open Limit timer as specified in table 159 (see 8.2.2.1);
- 3) start the Reject To Open Limit timer; and
- 4) wait at least until the Reject To Open Limit timer expires before sending a Tx Open message.

If a pending Tx Open message was created as the result this state receiving a Retry Open (Pathway Blocked) message, then this state shall set the pathway blocked count argument in the Tx Open message to the value of the pathway blocked count argument received with the message plus one, unless the pathway blocked count received with the argument is FFh.

If a pending Tx Open message was created as the result of this state receiving one of the following:

- a) a Retry Open (Opened By Destination) message;
- b) a Retry Open (Opened By Other) message;
- c) a Retry Open (Collided) message;
- d) a Retry Open (Pathway Blocked) message; or
- e) if the CONTINUE AWT bit is set to one in the Protocol-specific Port mode page (see 10.2.7.4), a Retry Open (Retry) message,

message >> so as not to confuse this with the then on the next line.

then this state shall set the arbitration wait time argument in the Tx Open message to be the value from the Arbitration Wait Time timer created as a result of the Retry Open message.

After this state sends a Tx Open message, this state shall discard the pending Tx Open message from which the Tx Open messages was created. After this state discards a pending Tx Open message, this state may create a new pending Tx Open message.

If this state receives a Connection Opened message and the initiator port bit and protocol arguments match those in a pending Tx Open message, then any Reject To Open Limit timer associated with that pending Tx Open message shall be discarded.

If this state receives a Connection Opened message and the initiator port bit and protocol arguments match those in any pending Tx Frame messages, then this state may use the established connection to send pending Tx Frame messages as Tx Frame messages to the destination SAS address.

8.2.2.3.3 PL_OC2:Overall_Control state connection established

If this state receives a Connection Opened message or a Retry Open (Opened By Destination) message for a SAS address, and an I_T Nexus Loss timer has been created for the SAS address, then this state shall:

- a) stop the I_T Nexus Loss timer for the SAS address, if the timer has been running; and
- b) initialize the I_T Nexus Loss timer.

8.2.2.3.4 PL_OC2:Overall_Control state unable to establish a connection

If this state receives a Retry Open (No Destination), Retry Open (Open Timeout Occurred), or Retry Open (Pathway Blocked) message and the I_T Nexus Loss timer for the SAS address has expired, then this state shall perform the following:

- a) delete the I_T Nexus Loss timer for the SAS address;
- b) discard the Retry Open message;
- c) send a Transmission Status (I_T Nexus Loss) confirmation for the pending Tx Frame message from which the Retry Open message resulted;
- d) discard the pending Tx Frame message from which the Retry Open message resulted;
- e) if this state has any pending Tx Frame messages with the same destination SAS address and protocol as the Retry Open message, and this state has not sent a Tx Open message to a PL_PM state machine for the messages, then this state shall send a Transmission Status (I_T Nexus Loss) confirmation for each pending Tx Frame message and discard the pending Tx Frame messages and any corresponding pending Tx Open messages; and
- f) if this state has any pending Tx Frame messages with the same destination SAS address and protocol as the Retry Open message, and this state has sent a Tx Open message to a PL_PM state machine for a message, then this state shall send a Cancel Open message to each PL_PM state machine to which it has sent a Tx Open message. After receiving an Unable To Connect (Cancel Acknowledge) message from a PL_PM state machine in response to the Cancel Open message, then this state shall send a Transmission Status (I_T Nexus Loss) confirmation for each pending Tx Frame message and discard the pending Tx Frame messages and any corresponding pending Tx Open messages.

If this state receives a Retry Open (No Destination), Retry Open (Open Timeout Occurred), or Retry Open (Pathway Blocked) message and processes it as an Unable To Connect message, or this state receives an

Page: 428

● Author: wdc-mevans
Subject: Highlight
Date: 5/6/2008 4:07:49 PM
 ACCEPT - DONE

messages
s/b
message

● Author: hpq-relliott
Subject: Note
Date: 7/17/2008 10:26:49 PM
 REFER PROTOCOL WG

After receiving a Connection Opened message, if credit is granted during the connection, the state may delete a pending Tx Open if it no longer needs to open its own connection. No need for unnecessary connection requests later on.

● Author: Isi-gpenokie
Subject: Highlight
Date: 6/26/2008 3:49:27 PM
 ACCEPT - DONE (as "if the I_T Nexus Loss timer for the SAS address has been running, then stop the timer")

This << stop the I_T Nexus Loss timer for the SAS address, if the timer has been running >> should be << if the I_T Nexus Loss timer has been running, then stop the I_T Nexus Loss timer for the SAS address, >>

● Author: RElliott
Subject: Highlight
Date: 8/30/2008 12:30:26 PM
 ACCEPT - DONE

Retry Open (No Destination), Retry Open (Open Timeout Occurred),

add
message

per 08-343

● Author: RElliott
Subject: Highlight
Date: 8/30/2008 12:30:46 PM
 ACCEPT - DONE

Retry Open (No Destination), Retry Open (Open Timeout Occurred), or

add
message

per 08-343

Unable To Connect message, then this state shall send a Transmission Status confirmation as defined in table 160.

Table 160 — Confirmations from Unable To Connect or Retry Open messages

Message received	Confirmation to be sent to transport layer
Retry Open (No Destination)	Transmission Status (I_T Nexus Loss) if the I_T Nexus Loss timer for the SAS address has expired, or Transmission Status (No Destination) if it has not
Retry Open (Open Timeout Occurred)	Transmission Status (I_T Nexus Loss) if the I_T Nexus Loss timer for the SAS address has expired, or Transmission Status (Open Timeout Occurred) if it has not
Retry Open (Pathway Blocked)	Transmission Status (I_T Nexus Loss) if the I_T Nexus Loss timer for the SAS address has expired
Unable To Connect (Break Received)	Transmission Status (Break Received)
Unable To Connect (Port Layer Request)	Transmission Status (Cancel Acknowledge)
Unable to Connect (Bad Destination)	Transmission Status (Bad Destination)
Unable To Connect (Connection Rate Not Supported)	Transmission Status (Connection Rate Not Supported)
Unable To Connect (Protocol Not Supported)	Transmission Status (Protocol Not Supported)
Unable To Connect (Reserved Abandon 1)	Transmission Status (Reserved Abandon 1)
Unable To Connect (Reserved Abandon 2)	Transmission Status (Reserved Abandon 2)
Unable To Connect (Reserved Abandon 3)	Transmission Status (Reserved Abandon 3)
Unable To Connect (STP Resources Busy)	Transmission Status (STP Resources Busy)
Unable To Connect (Wrong Destination)	Transmission Status (Wrong Destination)
Unable To Connect (Zone Violation)	Transmission Status (Zone Violation)

If this state receives an Unable To Connect (Connection Rate Not Supported), Unable To Connect (Protocol Not Supported), Unable To Connect (Zone Violation), Unable To Connect (Reserved Abandon 1), Unable To Connect (Reserved Abandon 2), Unable To Connect (Reserved Abandon 3), or Unable To Connect (STP Resources Busy) message and an I_T Nexus Loss timer is running for the SAS address, then this state shall:

- a) stop the I_T Nexus Loss timer, if the timer has been running; and
- b) initialize the I_T Nexus Loss timer.

 This state shall discard the pending Tx Frame message for which the Transmission Status confirmation was sent.

8.2.2.3.5 PL_OC2:Overall_Control state connection management

If this state receives an **Accept_Reject Opens** request, then this state shall send an **Accept_Reject Opens** request to all phys in the port.

If this state receives an SMP Transmit Break request, then this state shall send an SMP Transmit Break message to the PL_PM state machine associated with the corresponding SMP transport state machine. If there is no PL_PM state machine associated with the request, **the PM_OC state** shall ignore the request.

Page: 429

Author: RElliott
Subject: Note
Date: 7/17/2008 10:25:05 PM
 REFER PROTOCOL WG (George will write up)

(from lsi-gpenokie)

The last paragraph in section 8.2.2.3.4 PL_OC2:Overall_Control state unable to establish a connection states:
This state shall discard the pending Tx Frame message for which the Transmission Status confirmation was sent.

But it is not clear as to which Transmission Status confirmation causes the pending Tx Frame message to be discarded. I believe a reference to Table 160 — Confirmations from Unable To Connect or Retry Open messages would make it clear. The new paragraph would then be:

This state shall discard the pending Tx Frame message for which the Transmission Status confirmation (see table 160) was sent.

[Perhaps that should be merged into the sentence introducing table 160 instead?](#)

If this state receives a Retry Open (No Destination), Retry Open (Open Timeout Occurred), or Retry Open (Pathway Blocked) message and processes it as an Unable To Connect message, or this state receives an Unable To Connect message, then this state shall send a Transmission Status confirmation as defined in table 160 and discard the corresponding pending Tx Frame message.

Author: RElliott
Subject: Highlight
Date: 8/30/2008 3:08:46 PM
 ACCEPT - DONE

Accept_Reject Opens
s/b
Accept_Reject OPENS

Author: RElliott
Subject: Highlight
Date: 8/30/2008 3:08:51 PM
 ACCEPT - DONE

Accept_Reject Opens
s/b
Accept_Reject OPENS

Author: RElliott
Subject: Highlight
Date: 6/30/2008 6:16:52 PM
 ACCEPT - DONE

the PM_OC state
s/b
then the PL_OC state machine

If this state receives one of the following:

- a) a Connection Closed (Close Timeout) message;
- b) a Connection Closed (Break Requested) message; or
- c) a Connection Closed (Break Received) message,

then this state shall not send a Tx Open or Tx Frame message to the PL_PM state machine that sent the message until this state receives a Connection Closed (Transition to Idle) message from that PL_PM state machine.

If this state receives a Connection Closed (Normal) message or a Connection Closed (Transition to Idle) message indicating that a connection with a destination SAS address is no longer open and this state has pending Tx Open messages, then this state may send a Tx Open message to the PL_PM state machine that sent the Connection Closed message.

If this port is a wide SSP port, then this state shall not reject an incoming connection request on one phy because it has an outgoing connection request on another phy.

If this port is an SSP port, there are no pending Tx Frame messages for a destination SAS address with which a PL_PM state machine has established a connection, and the connection was established by a message from this state, then this state should send a Close Connection message to the PL_PM state machine.

If this port is an SSP port, has no pending Tx Frame messages for a destination SAS address with which a PL_PM state machine has established a connection, and the connection was established by the destination, then this state may wait a vendor-specific time and then shall send a Close Connection message to the PL_PM state machine.

If this state has received a Disable Tx Frame message from a PL_PM state machine, then this state should send a Close Connection message to the PL_PM state machine.

NOTE 83 - The PL_PM state machine sends a Close Connection request to the link layer upon receipt of a Close Connection message or on expiration of the Bus Inactivity Time Limit timer (see 8.2.3.4.1).

8.2.2.3.6 PL_OC2:Overall_Control state frame transmission

In order to prevent livelocks, If this port is a wide SSP port, has multiple connections established, and has a pending Tx Frame message, then this state shall send at least one Tx Frame message to a PL_PM state machine before sending a Close Connection message to the PL_PM state machine.

After this state receives a Connection Opened message from a PL_PM state machine, this state selects pending Tx Frame messages for the destination SAS address with the same initiator port bit and protocol arguments, and, as an option, the same connection rate argument, and sends the messages to the PL_PM state machine as Tx Frame messages.

This state may send a Tx Frame message to any PL_PM state machine that has established a connection with the destination SAS address when the initiator port bit and protocol arguments match those in the Tx Frame message.

After this state sends a Tx Frame message to a PL_PM state machine, it shall not send another Tx Frame message to that PL_PM state machine until it receives a Transmission Status (Frame Transmitted) message.

This state shall not send a Tx Frame message containing a Request Fence argument or Response Fence argument to any PL_PM state machine until this state has received one of the following messages for each Tx Frame message with the same nexus as specified by that Request Fence argument or Response Fence argument:

- a) Transmission Status (ACK Received);
- b) Transmission Status (NAK Received);
- c) Transmission Status (ACK/NAK Timeout); or
- d) Transmission Status (Connection Lost Without ACK/NAK).

● Author: wdc-mevans
Subject: Highlight
Date: 5/25/2008 8:14:18 PM
T REJECT (only 2 things being ANDED)

open and
s/b
open, and

● Author: lsi-gpenokie
Subject: Highlight
Date: 5/6/2008 4:07:49 PM
T REJECT (because is clearer)

This << because it has an outgoing connection request on >> should be << as a result of the port having an outgoing connection request on >>

● Author: lsi-gpenokie
Subject: Highlight
Date: 5/6/2008 4:07:49 PM
T REJECT (this is the PL_OC section, which cannot have rules for PL_PM in it. This is just a note about what the other state machine does.)

This note << NOTE 83 - The PL_PM >> should be normative text.

● Author: wdc-mevans
Subject: Highlight
Date: 5/30/2008 6:47:36 PM
T REJECT (first noun/subject convention)

it
s/b
this state

After this state sends a Tx Frame message containing a Request Fence argument or Response Fence argument, ~~it shall not send another Tx Frame message with the same nexus as specified by that Request Fence argument or Response Fence argument until it has received one of the following messages:~~

- a) Transmission Status (ACK Received);
- b) Transmission Status (NAK Received);
- c) Transmission Status (ACK/NAK Timeout); or
- d) Transmission Status (Connection Lost Without ACK/NAK).

Once this state has sent a Tx Frame message containing a Non-Interlocked argument to a PL_PM state machine, this state shall not send a Tx Frame message containing a Non-Interlocked argument with the same I_T_L_Q nexus to another PL_PM state machine until this state has received one of the following messages for each Tx Frame message containing a Non-Interlocked argument for the same I_T_L_Q nexus:

- a) Transmission Status (ACK Received);
- b) Transmission Status (NAK Received);
- c) Transmission Status (ACK/NAK Timeout); or
- d) Transmission Status (Connection Lost Without ACK/NAK).

Frames with the Non-Interlocked argument for **the same I_T_L_Q nexus** may be transmitted and received simultaneously on the same or different phys.

If this port is an SMP initiator port, then this state shall send the Tx Frame message containing the SMP REQUEST frame to the PL_PM state machine on which the connection was established for the Tx Open message. If this port is an SMP target port, then this state shall send the Tx Frame message containing the SMP RESPONSE frame to the PL_PM state machine on which the connection was established for the Tx Open message. See 7.18 for additional information about SMP connections.

Characteristics of STP connections are defined by SATA (also see 7.17).

The following arguments shall be included with the Tx Frame message:

- a) the frame to be transmitted; and
- b) Balance Required or Balance Not Required.

A Balance Not Required argument shall only be included if:

- a) the request was a Transmit Frame (Non-Interlocked) request (i.e., the request included a DATA frame); and
- b) the last Tx Frame message sent to this PL_PM state machine while this connection has been established was for a DATA frame having the same logical unit number and **tag** ~~value~~ as the DATA frame in this Tx Frame message.

If a Balance Not Required argument is not included in the Tx Frame message, then a Balance Required argument shall be included.

If this state receives a Disable Tx Frames message from a PL_PM state machine, then this state should send no more Tx Frame messages to that state machine until a new connection is established.

8.2.2.3.7 PL_OC2:Overall_Control state frame transmission cancellations

Cancel requests cause this state to cancel previous Transmit Frame requests. A Cancel request includes the following arguments:

- a) destination SAS address; and
- b) tag.

If this state receives a Cancel request and has not already sent a Tx Frame message for the Transmit Frame request to a PL_PM state machine for the Transmit Frame request specified by the Cancel request, then this state shall:

- a) discard all Transmit Frame requests for the specified destination SAS address and tag; and
- b) send a Transmission Status (Cancel Acknowledge) confirmation to the transport layer.

● Author: wdc-mevans

Subject: Highlight

Date: 5/30/2008 6:47:51 PM

T REJECT (first noun/subject convention)

it

s/b

this state

● Author: lsi-bday

Subject: Highlight

Date: 6/28/2008 1:24:42 PM

T ACCEPT - DONE (as:

"For a bidirectional command, frames with the Non-Interlocked argument for an I_T_L_Q nexus may be transmitted on one phy at the same time as frames with the Non-Interlocked argument for the same I_T_L_Q nexus are received on the same phy or on a different phy.")

...the same I_T_L_Q nexus...

suggest

...the same I_T_L_Q nexus for a bidirectional command...

● Author: RElliott

Subject: Cross-Out

Date: 6/30/2008 6:16:52 PM

T ACCEPT - DONE

value

● Author: stx-ghoulder

Subject: Highlight

Date: 5/25/2008 8:15:06 PM

T ACCEPT - DONE (initiator port transfer tag)

tag

This is an ambiguous tag reference.

If this state receives a Cancel request and has already sent a Tx Frame message to a PL_PM state machine for the Transmit Frame request specified by the Cancel request, then this state shall send a Cancel message to the PL_PM state machine to which the Tx Frame message was sent. The Cancel message shall include the tag.

8.2.2.3.8 Transition PL_OC2:Overall_Control to PL_OC1:Idle

This transition shall occur after:

- a) sending a HARD_RESET Received confirmation to the transport layer,
- b) a Phy Disabled confirmation is received from all of the link layers in the port; or
- c) sending a Notify Received (Power Loss Expected) confirmation to the transport layer.

8.2.3 PL_PM (port layer phy manager) state machine

8.2.3.1 PL_PM state machine overview

A PL_PM state machine:

- a) receives messages from the PL_OC state machine;
- b) sends requests to the link layer;
- c) receives confirmations from the link layer;
- d) sends confirmations to the transport layer;
- e) sends messages to PL_OC state machine;
- f) has an Arbitration Wait Time timer;
- g) may have a Bus Inactivity Time Limit timer; and
- h) may have Maximum Connect Time Limit timer.

This state machine consist of the following states:

- a) PL_PM1:Idle (see 8.2.3.2) (initial state);
- b) PL_PM2:Req_Wait (see 8.2.3.3);
- c) PL_PM3:Connected (see 8.2.3.4); and
- d) PL_PM4:Wait_For_Close (see 8.2.3.5).

After power on this state machine shall start in the PL_PM1:Idle state.

The PL_PM state machine shall maintain the timers listed in table 161.

Table 161 — PL_PM state machine timers

Timer	Initial value
Arbitration Wait Time timer	The arbitration wait time argument from a Retry Open message (see 8.2.2.3.1).
Bus Inactivity Time Limit timer	Depending on the protocol used by the port: a) for SSP target ports, the value in the BUS INACTIVITY TIME LIMIT field in the Disconnect-Reconnect mode page (see 10.2.7.2); or b) for STP target ports, the value in the STP BUS INACTIVITY TIME LIMIT field in the SMP REPORT GENERAL response (see 10.4.3.4).
Maximum Connect Time Limit timer	Depending on the protocol used by the port: a) for an SSP target port, the value in the MAXIMUM CONNECT TIME LIMIT field in the Disconnect-Reconnect mode page (see 10.2.7.2); or b) for an STP target port, the value in the STP MAXIMUM CONNECT TIME LIMIT field in the SMP REPORT GENERAL response.

Page: 432

● Author: stx-ghoulder
Subject: Highlight
Date: 5/25/2008 8:15:23 PM
 ACCEPT - DONE (initiator port transfer tag)

tag.
This is an ambiguous tag reference.

● Author: RElliott
Subject: Note
Date: 7/17/2008 8:18:38 PM
 REFER PROTOCOL WG (7/14 George Penokie volunteered to work on this issue)
(from Bill Martin, Emulex)

8.2.2.3.8 specifies a transition from PL_OC2 to PL_OC1 after a Phy Disabled confirmation is received from all of the link layers in the port; however, this event should cause a Transmission Status (No Phys In Port) to be sent to the port layer if there are any pending Transmit Frame requests, and this transition should be done after this Transmission Status is sent to the port layer. This may be as simple as adding a paragraph in 8.2.2.2.1.

● Author: RElliott
Subject: Highlight
Date: 8/30/2008 3:29:05 PM
 ACCEPT - DONE

After power on
move to end of sentence

● Author: RElliott
Subject: Highlight
Date: 8/30/2008 3:29:18 PM
 ACCEPT - DONE

The PL_PM state machine
s/b
This state machine

Figure 208 shows part 1 of the PL_PM state machine.

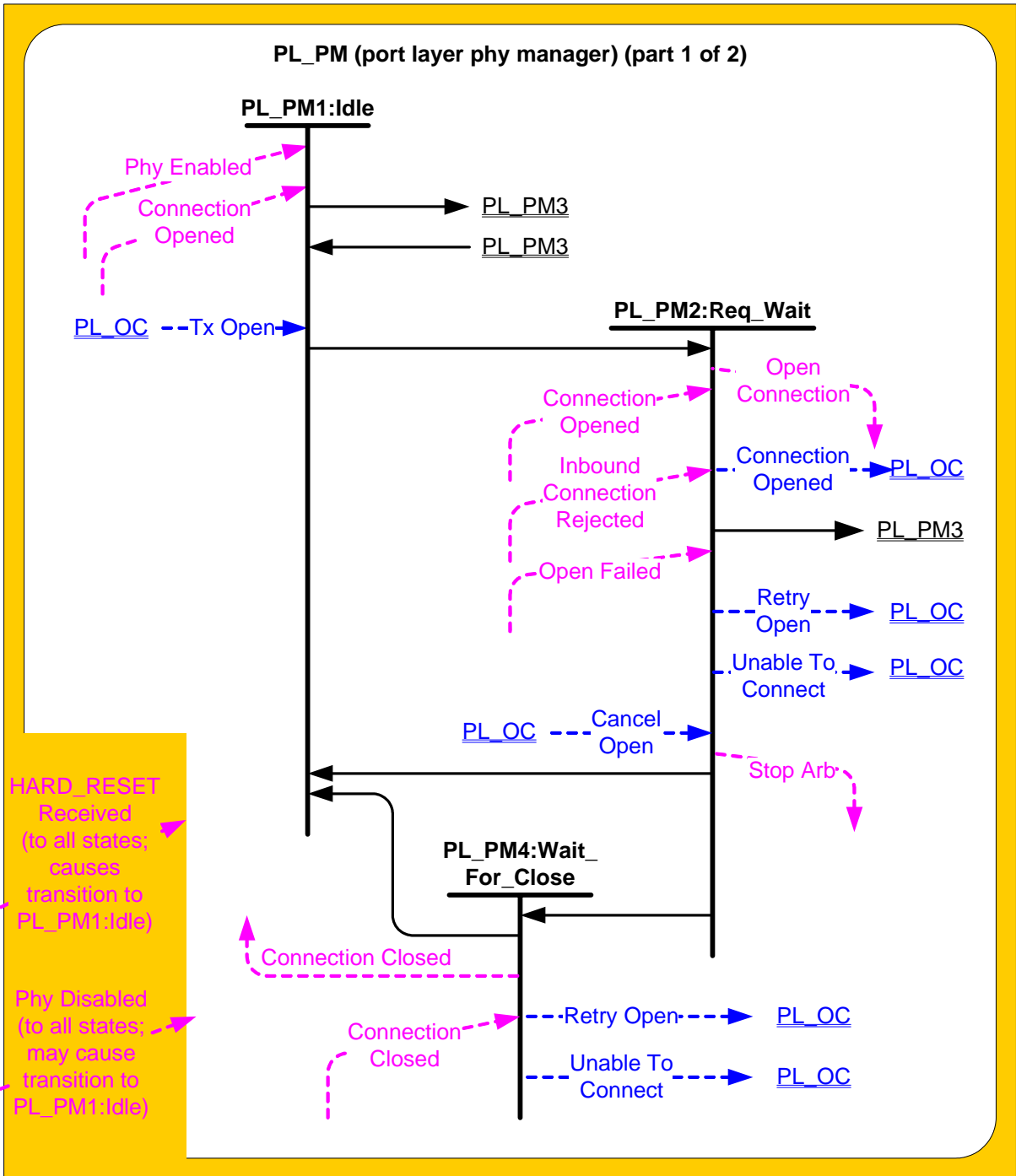

Figure 208 — PL_PM (port layer phy manager) state machine (part 1)

This page contains no comments

Figure 209 shows part 2 of the PL_PM state machine.

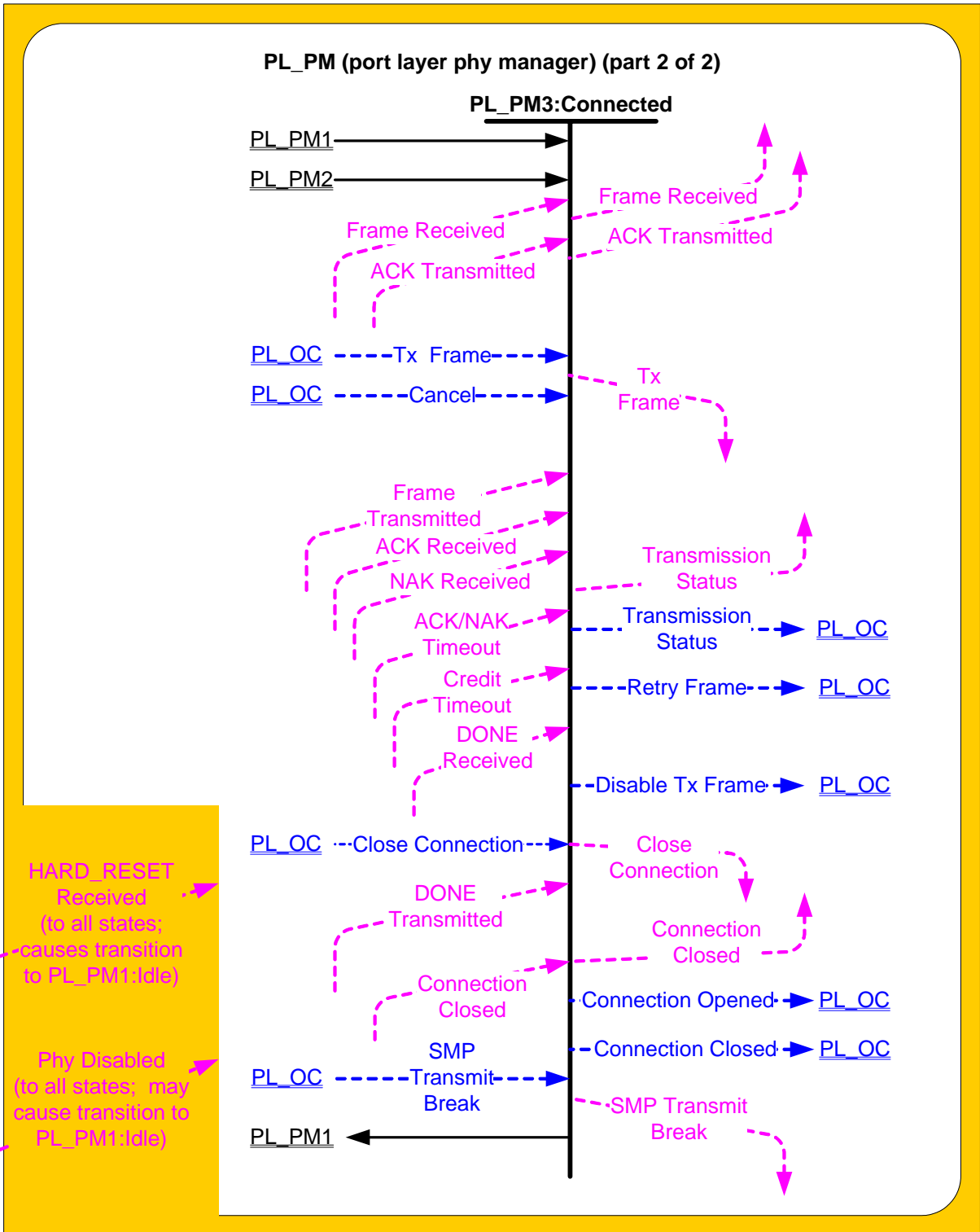

Figure 209 — PL_PM (port layer phy manager) state machine (part 2)

8.2.3.2 PL_PM1:Idle state

8.2.3.2.1 PL_PM1:Idle state description

This is the initial state of the PL_PM state machine.

This page contains no comments

8.2.3.2.2 Transition PL_PM1:Idle to PL_PM2:Req_Wait

This transition shall occur after:

- a) a Phy Enabled confirmation is received; and
- b) a Tx Open message is received.

8.2.3.2.3 Transition PL_PM1:Idle to PL_PM3:Connected

This transition shall occur after a Connection Opened confirmation is received. The transition shall include the received OPEN address frame.

8.2.3.3 PL_PM2:Req_Wait state**8.2.3.3.1 PL_PM2:Req_Wait state overview**

This state sends an Open Connection request to the link layer and waits for a confirmation. This state sends and receives connection management messages to and from the PL_OC state machine.

If this state receives a HARD_RESET Received confirmation, then this state shall terminate all operations.

8.2.3.3.2 PL_PM2:Req_Wait establishing a connection

Upon entry into this state, this state shall:

- 1) create an Arbitration Wait Time timer;
- 2) initialize the Arbitration Wait Time timer to the arbitration wait time argument received with the Tx Open message;
- 3) start the Arbitration Wait Time timer; and
- 4) send an Open Connection request to the link layer.

The Open Connection request shall contain the following arguments from the Tx Open message to be used in an OPEN address frame:

- a) initiator port bit;
- b) protocol;
- c) connection rate;
- d) initiator connection tag;
- e) destination SAS address;
- f) source SAS address;
- g) pathway blocked count; and
- h) arbitration wait time.

8.2.3.3.3 PL_PM2:Req_Wait connection established

If this state receives a Connection Opened confirmation, then this state shall send a Connection Opened message to the PL_OC state machine.

If this state receives a Connection Opened confirmation and the confirmation was not in response to an Open Connection request from this state (i.e., the connection was established in response to an OPEN address frame from another device), then this state shall discard any Open Connection request and send a Retry Open message to the PL_OC state machine. If the Connection Opened confirmation was from the destination of the Open Connection request, then this state shall send a Retry Open (Opened By Destination) message. If the Connection Opened confirmation was from a destination other than the destination of the Open Connection request, then this state shall send a Retry Open (Opened By Other) message.

A Retry Open (Opened By Destination) or Retry Open (Opened By Other) message shall contain the following arguments:

- a) initiator port bit set to the value received with the Tx Open message;
- b) protocol set to the value received with the Tx Open message;
- c) connection rate set to the value received with the Tx Open message;
- d) initiator connection tag set to the value received with the Tx Open message;

This page contains no comments

- e) destination SAS address set to the value received with the Tx Open message;
- f) source SAS address set to the value received with the Tx Open message;
- g) pathway blocked count set to the value received with the Tx Open message; and
- h) arbitration wait time set to the value of the Arbitration Wait Time timer.

8.2.3.3.4 PL_PM2:Req_Wait unable to establish a connection

If this state receives one of the Open Failed confirmations listed in table 162, then this state shall send either a Retry Open message or an Unable To Connect message to the PL_OC state machine.

Table 162 defines the message to be sent for each Open Failed confirmation.

Table 162 — Messages from Open Failed confirmations

Confirmation received	Message to be sent to PL_OC
Open Failed (No Destination)	Retry Open (No Destination)
Open Failed (Pathway Blocked)	Retry Open (Pathway Blocked)
Open Failed (Reserved Continue 0)	Retry Open (Retry)
Open Failed (Reserved Continue 1)	Retry Open (Retry)
Open Failed (Reserved Initialize 0)	Retry Open (No Destination)
Open Failed (Reserved Initialize 1)	Retry Open (No Destination)
Open Failed (Reserved Stop 0)	Retry Open (Pathway Blocked)
Open Failed (Reserved Stop 1)	Retry Open (Pathway Blocked)
Open Failed (Retry)	Retry Open (Retry)
Open Failed (Bad Destination)	Unable To Connect (Bad Destination)
Open Failed (Connection Rate Not Supported)	Unable To Connect (Connection Rate Not Supported)
Open Failed (Protocol Not Supported)	Unable To Connect (Protocol Not Supported)
Open Failed (Reserved Abandon 1)	Unable To Connect (Reserved Abandon 1)
Open Failed (Reserved Abandon 2)	Unable To Connect (Reserved Abandon 2)
Open Failed (Reserved Abandon 3)	Unable To Connect (Reserved Abandon 3)
Open Failed (STP Resources Busy)	Unable To Connect (STP Resources Busy)
Open Failed (Wrong Destination)	Unable To Connect (Wrong Destination)
Open Failed (Zone Violation)	Unable To Connect (Zone Violation)

If this state receives an Inbound Connection Rejected confirmation after sending an Open Connection request, then this state shall discard the Open Connection request and send a Retry Open (Collided) message to the PL_OC state machine.

A Retry Open message shall include the following arguments:

- a) initiator port bit set to the value received with the Tx Open message;
- b) protocol set to the value received with the Tx Open message;
- c) connection rate set to the value received with the Tx Open message;
- d) initiator connection tag set to the value received with the Tx Open message;
- e) destination SAS address set to the value received with the Tx Open message;
- f) source SAS address set to the value received with the Tx Open message;

This page contains no comments

- g) pathway blocked count argument set to the value received with the Tx Open message; and
- h) arbitration wait time set to the value of the Arbitration Wait Time timer.

An Unable To Connect message shall include the following arguments:

- a) initiator connection tag set to the value received with the Tx Open message;
- b) destination SAS address set to the value received with the Tx Open message; and
- c) source SAS address set to the value received with the Tx Open message.

8.2.3.3.5 PL_PM2:Req_Wait connection management

If this state receives a Cancel Open message and a Connection Opened confirmation has not been received, then this state shall send a Stop Arb request to the link layer.

8.2.3.3.6 Transition PL_PM2:Req_Wait to PL_PM1:Idle

This transition shall occur after:

- a) a Retry Open message is sent to the PL_OC state machine;
- b) an Unable To Connect message is sent to the PL_OC state machine;
- c) all operations have been terminated after a HARD_RESET Received confirmation is received; or
- d) a Phy Disabled confirmation is received.

8.2.3.3.7 Transition PL_PM2:Req_Wait to PL_PM3:Connected

This transition shall occur after a Connection Opened confirmation is received.

8.2.3.3.8 Transition PL_PM2:Req_Wait to PL_PM4:Wait_For_Close

This transition shall occur after one of the following confirmations is received:

- a) an Open Failed (Open Timeout Occurred);
- b) an Open Failed (Break Received); or
- c) an Open Failed (Port Layer Request).

8.2.3.4 PL_PM3:Connected state

8.2.3.4.1 PL_PM3:Connected state description

If this state was entered from the PL_PM1:Idle state, then this state shall send a Connection Opened message to the PL_OC state machine that includes as an argument the received OPEN address frame.

If:

- a) the protocol for the connection is SSP, the port is an SSP target port, the Disconnect-Reconnect mode page is implemented, and the MAXIMUM CONNECT TIME LIMIT field in the Disconnect-Reconnect mode page (see 10.2.7.2) is not set to zero;
- b) the protocol for the connection is SMP and the port is an SMP target port; or
- c) the protocol for the connection is STP, the port is an STP target port, and the STP MAXIMUM CONNECT TIME LIMIT field is not set to zero in the SMP REPORT GENERAL response (see 10.4.3.4),

then, upon entry into this state, this state shall:

- 1) create a Maximum Connect Time Limit timer;
- 2) initialize the Maximum Connect Time Limit timer as specified in table 161 (see 8.2.3.1); and
- 3) start the Maximum Connect Time Limit timer.

If:

- a) the protocol for the connection is SSP, the port is an SSP initiator port, and the MAXIMUM CONNECT TIME LIMIT field in the Disconnect-Reconnect mode page (see 10.2.7.2) for the destination SSP target port is not set to zero; or

Author: RElliott
Subject: Highlight
Date: 8/30/2008 12:01:02 PM
ACCEPT - DONE

Open Failed (Port Layer Request)

s/b

Open Failed (Arb Stopped)

per 08-343

- b) the protocol for the connection is STP, the port is an STP initiator port, and the STP MAXIMUM CONNECT TIME LIMIT field is not set to zero in the SMP REPORT GENERAL response (see 10.4.3.4) for the destination STP target port,

then, upon entry into this state, this state may:

- 1) create a Maximum Connect Time Limit timer;
- 2) initialize the Maximum Connect Time Limit timer as specified in table 161 (see 8.2.3.1); and
- 3) start the Maximum Connect Time Limit timer.

If:

- a) the protocol for the connection is SSP, the port is an SSP target port, and the BUS INACTIVITY TIME LIMIT field in the Disconnect-Reconnect mode page (see 10.2.7.2) is set to a non-zero value; or
- b) the protocol for the connection is STP, the port is an STP initiator port, and the STP BUS INACTIVITY TIME LIMIT field is not set to zero in the SMP REPORT GENERAL response for the destination STP target port,

then, upon entry into this state, this state shall:

- 1) create a Bus Inactivity Time Limit timer;
- 2) initialize the Bus Inactivity Time Limit timer as specified in table 161 (see 8.2.3.1); and
- 3) start the Bus Inactivity Time Limit timer.

If a Bus Inactivity Time Limit timer has been created and:

- a) the connection is SSP or SMP and this state receives a Tx Frame message; or
- b) the connection is STP and the phy is not both transmitting and receiving SATA_SYNC,

then this state shall:

- 1) stop the Bus Inactivity Time Limit timer, if it is running;
- 2) initialize the Bus Inactivity Time Limit timer as specified in table 161 (see 8.2.3.1); and
- 3) start the Bus Inactivity Time Limit timer.

If this state receives a Tx Frame message, **this** state shall send a Tx Frame request to the link layer. The following arguments from the Tx Frame message shall be included with the Tx Frame request:

- a) the frame to be transmitted; and
- b) if this port is an SSP port, Balance Required or Balance Not Required.

For STP connections, this state connects the STP transport layer to the STP link layer.

If a Bus Inactivity Time Limit timer expires:

- a) if the connection is SSP and there is no Tx Frame request outstanding (i.e., this state is not waiting for an ACK Received or NAK Received confirmation), then this state shall send a Close Connection request to the link layer;
- b) if the connection is SSP and there is a Tx Frame request outstanding (i.e., this state is waiting for an ACK Received or NAK Received confirmation), then this state shall send a Close Connection request to the link layer after receiving an ACK Received or NAK Received confirmation; **and**
- c) if the connection is STP, then this state shall send a Close Connection request to the link layer.

If a Maximum Connect Time Limit timer expires:

- a) if the connection is SSP and there is no Tx Frame request outstanding (i.e., this state is not waiting for an ACK Received or NAK Received confirmation), then this state shall send a Close Connection request to the link layer;
- b) if the connection is SSP and there is a Tx Frame request outstanding (i.e., this state is waiting for an ACK Received or NAK Received confirmation), then this state shall send a Close Connection request to the link layer after receiving an ACK Received or NAK Received confirmation;
- c) if the connection is SMP, then this state shall send an SMP Transmit Break request to the link layer; **and**
- d) if the connection is STP, then this state shall send a Close Connection request to the link layer after the phy is both transmitting and receiving SATA_SYNC.

● Author: RElliott
Subject: Highlight
Date: 6/30/2008 6:16:52 PM

T ACCEPT - DONE
this
s/b
then this

● Author: lsi-gpenokie
Subject: Highlight
Date: 5/6/2008 4:07:49 PM

T ACCEPT - DONE

This << and >> should be << or >> as only one of the list can occur at a time.

● Author: lsi-gpenokie
Subject: Highlight
Date: 5/6/2008 4:07:49 PM

T ACCEPT - DONE

This << and >> should be << or >> as only one of the list can occur at a time.

If this state receives a Tx Frame message after sending a Close Connection request but before receiving a Connection Closed confirmation, then this state shall send a Retry Frame message to the PL_OC state machine.

If this state receives a Frame Received confirmation, then this state shall send a Frame Received confirmation to the transport layer. The confirmation shall include the arguments received with the confirmation (e.g., the frame).

If this state receives an ACK Transmitted confirmation, then this state shall send an ACK Transmitted confirmation to the transport layer including the tag of the frame that was ACKed.

If this state receives a Frame Transmitted confirmation, then this state shall send:

- a) a Transmission Status (Frame Transmitted) confirmation to the transport layer; and
- b) a Transmission Status (Frame Transmitted) message to the PL_OC state machine.

If this state receives an ACK Received confirmation, then this state shall send:

- a) a Transmission Status (ACK Received) confirmation to the transport layer; and
- b) a Transmission Status (ACK Received) message to the PL_OC state machine.

If this state receives a NAK Received confirmation, then this state shall send:

- a) a Transmission Status (NAK Received) confirmation to the transport layer; and
- b) a Transmission Status (NAK Received) message to the PL_OC state machine.

If this state receives an ACK/NAK Timeout confirmation, then this state shall send:

- a) a Transmission Status (ACK/NAK Timeout) confirmation to the transport layer; and
- b) a Transmission Status (ACK/NAK Timeout) message to the PL_OC state machine.

If this state receives a Cancel message, then this state shall:

- a) discard all Tx Frame requests for the specified tag;
- b) send a Transmission Status (Cancel Acknowledge) confirmation to the transport layer including the destination SAS address and the tag as arguments; and
- c) discard any subsequent confirmations for previous Tx Frame requests sent for the tag.

If this state receives a Close Connection message from the PL_OC state machine, then this state shall send a Close Connection request to the link layer.

If this state receives one of the following:

- a) a Connection Closed (Normal) confirmation;
- b) a Connection Closed (Close Timeout) confirmation;
- c) a Connection Closed (Break Requested) confirmation;
- d) a Connection Closed (Break Received) confirmation; or
- e) a Connection Closed (Transition to Idle) confirmation,

then this state shall send a Connection Closed message to the PL_OC state machine including the argument received with the confirmation.

If this state receives a Connection Closed (Transition to Idle) confirmation after receiving:

- a) a Connection Closed (Break Received) confirmation; or
- b) a Connection Closed (Break Requested) confirmation,

then this state shall send a Transmission Status (Break Received) confirmation to the transport layer.

If this state receives a Connection Closed (Normal) confirmation, a Connection Closed (Transition to Idle) confirmation, or a Phy Disabled confirmation after sending a Transmission Status (Frame Transmitted) confirmation, but before this state receives an ACK Received or NAK Received confirmation, then this state shall send:

- a) a Transmission Status (Connection Lost Without ACK/NAK) confirmation to the transport layer; and
- b) a Transmission Status (Connection Lost Without ACK/NAK) message to the PL_OC state machine.

● Author: stx-ghoulder

Subject: Highlight

Date: 5/25/2008 8:16:10 PM

T ACCEPT - DONE (initiator port transfer tag)

tag

This is an ambiguous tag reference.

● Author: RElliott

Subject: Highlight

Date: 8/30/2008 12:36:34 PM

T ACCEPT - DONE

receiving

s/b

receiving one of the following

If this state receives a Connection Closed (Normal) confirmation, a Connection Closed (Transition to Idle) confirmation, or a Phy Disabled confirmation after sending a Tx Frame request but before receiving a Frame Transmitted confirmation, then this state shall send a Retry Frame message to the PL_OC state machine.

If this state receives a Connection Closed confirmation during an SMP connection, this state shall send a Connection Closed confirmation to the transport layer.

If this state receives a Credit Timeout confirmation, then this state shall send a Retry Frame message to the PL_OC state machine.

A Retry Frame message shall include the following arguments from the Tx Frame message:

- a) initiator port bit;
- b) protocol;
- c) connection rate;
- d) initiator connection tag;
- e) destination SAS address;
- f) source SAS address; and
- g) frame.

After this state receives a DONE Received (Normal) or DONE Received (Credit Blocked) confirmation, if it does not receive a Tx Frame message within 1 ms, then this state shall send a Disable Tx Frames message to the PL_OC state machine.

If this state receives a DONE Received (ACK/NAK Timeout) or DONE Transmitted confirmation, then this state shall send a Disable Tx Frames message to the PL_OC state machine.

If this state receives an SMP Transmit Break message, then this state shall send an SMP Transmit Break request to the link layer.

If this state receives a HARD_RESET Received confirmation, then this state machine shall terminate all operations.

8.2.3.4.2 Transition PL_PM3:Connected to PL_PM1:Idle

This transition shall occur after:

- a) a Connection Closed (Transition to Idle) message is sent to the PL_OC state machine; or
- b) all operations are terminated after a HARD_RESET Received confirmation is received.

8.2.3.5 PL_PM4:Wait_For_Close state

8.2.3.5.1 PL_PM4:Wait_For_Close state description

After receiving a Connection Closed (Transition to Idle) confirmation, if this state was entered as the result of the PL_PM2:Req_Wait state receiving an Open Failed (Open Timeout Occurred) confirmation, then this state shall send a Retry Open (Open Timeout Occurred) message to the PL_OC state machine. The Retry Open message shall include the following arguments:

- a) initiator port bit set to the value received with the Tx Open message;
- b) protocol set to the value received with the Tx Open message;
- c) connection rate set to the value received with the Tx Open message;
- d) initiator connection tag set to the value received with the Tx Open message;
- e) destination SAS address set to the value received with the Tx Open message;
- f) source SAS address set to the value received with the Tx Open message;
- g) pathway blocked count argument set to the value received with the Tx Open message; and
- h) arbitration wait time set to the value of the Arbitration Wait Time timer.

If this state receives a Connection Closed confirmation and the connection request was for an SMP connection, this state shall send a Connection Closed confirmation to the transport layer.

After receiving a Connection Closed (Transition to Idle) confirmation, if this state was entered after the PL_PM2:Req_Wait state received an Open Failed (Port Layer Request) confirmation (i.e., as the result of the

● Author: Isi-gpenokie
Subject: Highlight
Date: 5/6/2008 4:07:49 PM
T ACCEPT - DONE

This << SMP connection, this state >> should be << SMP connection, then this state >>

● Author: wdc-mevans
Subject: Highlight
Date: 5/25/2008 8:16:30 PM
T REJECT (first noun/subject convention)

it
s/b
this state

● Author: RElliott
Subject: Highlight
Date: 6/30/2008 6:16:52 PM
T ACCEPT - DONE

Credit Blocked
s/b
Credit Timeout

from Brian Day, LSI

● Author: Isi-gpenokie
Subject: Highlight
Date: 5/6/2008 4:07:49 PM
T ACCEPT - DONE

This << connection, this state shall >> should be << connection, then this state shall >>

● Author: RElliott
Subject: Highlight
Date: 8/30/2008 12:00:52 PM
T ACCEPT - DONE

Open Failed (Port Layer Request)
s/b
Open Failed (Arb Stopped)

per 08-343

PL_PM2:Req_Wait state sending a Stop Arb request), then this state shall send an Unable to Connect (Port Layer Request) message to the PL_OC state machine.

After receiving a Connection Closed (Transition to Idle) confirmation, if this state was entered as the result of the PL_PM2:Req_Wait state receiving an Open Failed (Break Received) confirmation, then this state shall send an Unable to Connect (Break Received) message to the PL_OC state machine.

The Unable To Connect message shall include the following arguments:

- a) initiator connection tag set to the value received with the Tx Open message;
- b) destination SAS address set to the value received with the Tx Open message; and
- c) source SAS address set to the value received with the Tx Open message.

If this state receives a HARD_RESET Received confirmation, then this state shall terminate all operations.

8.2.3.5.2 Transition PL_PM4:Wait_For_Close to PL_PM1:Idle

This transition shall occur after:

- a) a Retry Open or Unable To Connect message is sent to the PL_OC state machine; or
- b) all operations are terminated after a HARD_RESET Received confirmation is received.

This page contains no comments

9 Transport layer

9.1 Transport layer overview

The transport layer defines frame formats. Transport layer state machines interface to the application layer and port layer and construct and **parses** frame contents. For SSP, the transport layer only receives frames from the port layer for which an ACK is going to be transmitted by the link layer.

● Author: wdc-mevans
Subject: Highlight
Date: 5/6/2008 4:07:49 PM

T ACCEPT - DONE

parse

s/b

parse

9.2 SSP transport layer

9.2.1 SSP frame format

Table 163 defines the SSP frame format.

Table 163 — SSP frame format

Byte\Bit	7	6	5	4	3	2	1	0	
0	FRAME TYPE								
1	(MSB)	HASHED DESTINATION SAS ADDRESS							(LSB)
3								(LSB)	
4	Reserved								
5	(MSB)	HASHED SOURCE SAS ADDRESS							(LSB)
7								(LSB)	
8	Reserved								
9	Reserved								
10	Reserved			TLR CONTROL		RETRY DATA FRAMES	RETRANSMIT	CHANGING DATA POINTER	
11	Reserved						NUMBER OF FILL BYTES		
12	Reserved								
13	Reserved								
15	Reserved								
16	(MSB)	TAG							(LSB)
17								(LSB)	
18	(MSB)	TARGET PORT TRANSFER TAG							(LSB)
19								(LSB)	
20	(MSB)	DATA OFFSET							(LSB)
23								(LSB)	
24	INFORMATION UNIT								
m	(e.g., see table 165, table 167, table 169, table 170, or table 171)								
Fill bytes, if needed									
n - 3	(MSB)	CRC							(LSB)
n								(LSB)	

Table 164 defines the FRAME TYPE field, which defines the format of the INFORMATION UNIT field.

The HASHED DESTINATION SAS ADDRESS field contains the hashed value of the destination SAS address (see 4.2.3). See 9.2.6.2.2 and 9.2.6.3.2 for transport layer requirements on checking this field.

Author: RElliott
Subject: Highlight
Date: 6/30/2008 6:16:52 PM

T ACCEPT - DONE

Global

To resolve a Seagate comment about confusion between this TAG field and the other fields ending in the word TAG, rename this TAG field to INITIATOR PORT TRANSFER TAG.

Table 164 — FRAME TYPE field

Code	Name of frame	Type of information unit	Originator	Information unit size (bytes)	Reference
01h	DATA frame (i.e., write DATA frame or read DATA frame)	Data information unit (i.e., write Data information unit or read Data information unit)	SSP initiator port or SSP target port	1 to 1 024	9.2.2.4
05h	XFER_RDY frame	Transfer Ready information unit	SSP target port	12	9.2.2.3
06h	COMMAND frame	Command information unit	SSP initiator port	28 to 280	9.2.2.1
07h	RESPONSE frame	Response information unit	SSP target port	24 to 1 024	9.2.2.5
16h	TASK frame	Task Management Function information unit	SSP initiator port	28	9.2.2.2
F0h - FFh	Vendor specific				
All others	Reserved				

The HASHED SOURCE SAS ADDRESS field contains the hashed value of the source SAS address (see 4.2.3). See 9.2.6.2.2 and 9.2.6.3.2 for transport layer requirements on checking this field.

If an initiator port supports transport layer retries, it shall set the TLR CONTROL field to 01b in each COMMAND frame it sends unless it has determined that the I_T_L nexus does not support the TLR CONTROL field.

If an initiator port does not support transport layer retries, it shall set the TLR CONTROL field to 10b in each COMMAND frame it sends unless it has determined that the I_T_L nexus does not support the TLR CONTROL field.

An initiator port determines that an I_T_L nexus does not support the TLR CONTROL field if it sends a COMMAND frame with the TLR CONTROL field set to 01b or 10b and receives a RESPONSE frame with the DATAPRES field set to RESPONSE_DATA and the RESPONSE CODE field set to 02h (i.e., INVALID FRAME). After determining that an I_T_L nexus does not support the TLR CONTROL field, an initiator port shall set the TLR CONTROL field to 00b for subsequent COMMAND frames for that I_T_L nexus.

NOTE 84 - Initiator ports compliant with previous versions of this standard always set the TLR CONTROL field to 00b.

NOTE 85 - The TLR CONTROL SUPPORTED field in the Protocol-Specific Logical Unit Information VPD page (see 10.2.11.3) indicates if the target port supports the TLR CONTROL field set to a non-zero value.

A TLR CONTROL field set to 00b or 11b in a COMMAND frame specifies that the SSP target port shall use the TRANSPORT LAYER RETRIES bit in the Protocol-Specific Logical Unit mode page (see 10.2.7.3) to enable or disable transport layer retries for this command:

- a) if the TRANSPORT LAYER RETRIES bit is set to one, the target port shall set the RETRY DATA FRAMES bit to one in any XFER_RDY frames that it transmits for this command; and
- b) if the TRANSPORT LAYER RETRIES bit is set to zero, the target port shall set the RETRY DATA FRAMES bit to zero in any XFER_RDY frames that it transmits for this command.

Page: 444

Author: wdc-mevans
Subject: Highlight
Date: 5/26/2008 11:17:20 AM
T REJECT (first noun subject convention, but added "then")
it
s/b
then the initiator port

Author: RElliott
Subject: Highlight
Date: 6/30/2008 6:16:52 PM
T ACCEPT - DONE
initiator port
s/b
SSP initiator port

Author: RElliott
Subject: Highlight
Date: 6/30/2008 6:16:52 PM
T ACCEPT - DONE
it sends
s/b
that it sends

Author: stx-ghoulder
Subject: Note
Date: 6/17/2008 8:02:30 PM
 ACCEPT - DONE (07-027r0 had a big table, with different meanings for different frame types. 07-027r1 and r2 replaced the table with "simpler" text.

Reverted to a table for COMMAND frames.

5/5 check the original proposal - did it have a table that was removed for good reason? Maybe add one intro sentence about TLR CONTROL before all these paragraphs. Maybe put target rules in a table and put the initiator rules afterwards in text.)

I find the TLR CONTROL field description to be in an unconventional order and hard to follow. It would be better to describe what the 00, 01, 10, and 11 combinations mean before describing rules for when they shall or shall not be set. Currently the text tells the reader rules for when certain combinations are allowed before describing what the combinations mean.

Author: wdc-mevans
Subject: Highlight
Date: 5/26/2008 11:17:25 AM
T REJECT (first noun subject convention, but added "then")
it
s/b
then the initiator port

Author: RElliott
Subject: Highlight
Date: 6/30/2008 6:16:52 PM
T ACCEPT - DONE
initiator port
s/b
SSP initiator port

Comments from page 444 continued on next page

Table 164 — FRAME TYPE field

Code	Name of frame	Type of information unit	Originator	Information unit size (bytes)	Reference
01h	DATA frame (i.e., write DATA frame or read DATA frame)	Data information unit (i.e., write Data information unit or read Data information unit)	SSP initiator port or SSP target port	1 to 1 024	9.2.2.4
05h	XFER_RDY frame	Transfer Ready information unit	SSP target port	12	9.2.2.3
06h	COMMAND frame	Command information unit	SSP initiator port	28 to 280	9.2.2.1
07h	RESPONSE frame	Response information unit	SSP target port	24 to 1 024	9.2.2.5
16h	TASK frame	Task Management Function information unit	SSP initiator port	28	9.2.2.2
F0h - FFh	Vendor specific				
All others	Reserved				

The HASHED SOURCE SAS ADDRESS field contains the hashed value of the source SAS address (see 4.2.3). See 9.2.6.2.2 and 9.2.6.3.2 for transport layer requirements on checking this field.

If an initiator port supports transport layer retries, it shall set the TLR CONTROL field to 01b in each COMMAND frame it sends unless it has determined that the I_T_L nexus does not support the TLR CONTROL field.

If an initiator port does not support transport layer retries, it shall set the TLR CONTROL field to 10b in each COMMAND frame it sends unless it has determined that the I_T_L nexus does not support the TLR CONTROL field.

An initiator port determines that an I_T_L nexus does not support the TLR CONTROL field if it sends a COMMAND frame with the TLR CONTROL field set to 01b or 10b and receives a RESPONSE frame with the DATAPRES field set to RESPONSE_DATA and the RESPONSE CODE field set to 02h (i.e., INVALID FRAME). After determining that an I_T_L nexus does not support the TLR CONTROL field, an initiator port shall set the TLR CONTROL field to 00b for subsequent COMMAND frames for that I_T_L nexus.

NOTE 84 - Initiator ports compliant with previous versions of this standard always set the TLR CONTROL field to 00b.

NOTE 85 - The TLR CONTROL SUPPORTED field in the Protocol-Specific Logical Unit Information VPD page (see 10.2.11.3) indicates if the target port supports the TLR CONTROL field set to a non-zero value.

A TLR CONTROL field set to 00b or 11b in a COMMAND frame specifies that the SSP target port shall use the TRANSPORT LAYER RETRIES bit in the Protocol-Specific Logical Unit mode page (see 10.2.7.3) to enable or disable transport layer retries for this command:

- if the TRANSPORT LAYER RETRIES bit is set to one, the target port shall set the RETRY DATA FRAMES bit to one in any XFER_RDY frames that it transmits for this command; and
- if the TRANSPORT LAYER RETRIES bit is set to zero, the target port shall set the RETRY DATA FRAMES bit to zero in any XFER_RDY frames that it transmits for this command.

Author: RElliott
Subject: Highlight
Date: 6/30/2008 6:16:52 PM

 ACCEPT - DONE

it sends
s/b
that it sends

Author: wdc-mevans
Subject: Highlight
Date: 5/26/2008 11:17:42 AM

 REJECT (first noun subject convention)

it
s/b
the initiator port

Author: ibm-steve-wallace
Subject: Highlight
Date: 5/26/2008 11:17:57 AM

 REJECT (5/5 no change. There is already a NOTE below this pointing to the VPD page.)

This check is not sufficient to determine that the I_T_L nexus does support the TLR CONTROL field. The TLR CONTROL field is replacing part of a reserved field. The definition of reserved states that the recipients are not required to check reserved fields for zero. If the target device does not check this field, then the initiator must use the VPD page to determine if the target supports TLR CONTROL. Otherwise, the initiator may think the TLR CONTROL field is valid when the target is ignoring the field.

Author: RElliott
Subject: Note
Date: 6/30/2008 6:16:52 PM

 ACCEPT - DONE

An initiator port
s/b
An SSP initiator port

and
an initiator port
s/b
the SSP initiator port

Author: Isi-gpenokie
Subject: Highlight
Date: 6/17/2008 7:53:16 PM

 REJECT (this is not important for the rules being conveyed; it's just an aside, mentioning that VPD bit is out there. If this were a model section describing that the application client must read the VPD page to make a decision, then it would not be a NOTE. However, the bit is purely informational, since you cannot fetch the VPD page without already setting TLR CONTROL to something (and possibly having a mismatch with a SAS-1.1 target). The paragraph above the note explains how the initiator must gently probe.)

This note << NOTE 85 - The TLR >> should be normative text.

Author: RElliott
Subject: Highlight
Date: 6/30/2008 6:16:52 PM

 ACCEPT - DONE

target port
s/b
SSP target port

Author: RElliott
Subject: Highlight

Table 164 — FRAME TYPE field

Code	Name of frame	Type of information unit	Originator	Information unit size (bytes)	Reference
01h	DATA frame (i.e., write DATA frame or read DATA frame)	Data information unit (i.e., write Data information unit or read Data information unit)	SSP initiator port or SSP target port	1 to 1 024	9.2.2.4
05h	XFER_RDY frame	Transfer Ready information unit	SSP target port	12	9.2.2.3
06h	COMMAND frame	Command information unit	SSP initiator port	28 to 280	9.2.2.1
07h	RESPONSE frame	Response information unit	SSP target port	24 to 1 024	9.2.2.5
16h	TASK frame	Task Management Function information unit	SSP initiator port	28	9.2.2.2
F0h - FFh	Vendor specific				
All others	Reserved				

The HASHED SOURCE SAS ADDRESS field contains the hashed value of the source SAS address (see 4.2.3). See 9.2.6.2.2 and 9.2.6.3.2 for transport layer requirements on checking this field.

If an initiator port supports transport layer retries, it shall set the TLR CONTROL field to 01b in each COMMAND frame it sends unless it has determined that the I_T_L nexus does not support the TLR CONTROL field.

If an initiator port does not support transport layer retries, it shall set the TLR CONTROL field to 10b in each COMMAND frame it sends unless it has determined that the I_T_L nexus does not support the TLR CONTROL field.

An initiator port determines that an I_T_L nexus does not support the TLR CONTROL field if it sends a COMMAND frame with the TLR CONTROL field set to 01b or 10b and receives a RESPONSE frame with the DATAPRES field set to RESPONSE_DATA and the RESPONSE CODE field set to 02h (i.e., INVALID FRAME). After determining that an I_T_L nexus does not support the TLR CONTROL field, an initiator port shall set the TLR CONTROL field to 00b for subsequent COMMAND frames for that I_T_L nexus.

NOTE 84 - Initiator ports compliant with previous versions of this standard always set the TLR CONTROL field to 00b.

NOTE 85 - The TLR CONTROL SUPPORTED field in the Protocol-Specific Logical Unit Information VPD page (see 10.2.11.3) indicates if the target port supports the TLR CONTROL field set to a non-zero value.

A TLR CONTROL field set to 00b or 11b in a COMMAND frame specifies that the SSP target port shall use the TRANSPORT LAYER RETRIES bit in the Protocol-Specific Logical Unit mode page (see 10.2.7.2) to enable or disable transport layer retries for this command:

- if the TRANSPORT LAYER RETRIES bit is set to one, the target port shall set the RETRY DATA FRAMES bit to one in any XFER_RDY frames that it transmits for this command; and
- if the TRANSPORT LAYER RETRIES bit is set to zero, the target port shall set the RETRY DATA FRAMES bit to zero in any XFER_RDY frames that it transmits for this command.

Date: 6/30/2008 6:16:52 PM

T ACCEPT - DONE

:
s/b
as follows:

● Author: RElliott
Subject: Highlight
Date: 6/30/2008 6:16:52 PM
T ACCEPT - DONE

target port
s/b
SSP target port

● Author: RElliott
Subject: Highlight
Date: 6/30/2008 6:16:52 PM
T ACCEPT - DONE

the
s/b
then the

● Author: Isi-gpenokie
Subject: Highlight
Date: 5/6/2008 4:07:49 PM
T ACCEPT - DONE

This << and >> should be << or >> as it is one or the other not both.

● Author: RElliott
Subject: Highlight
Date: 6/30/2008 6:16:52 PM
T ACCEPT - DONE

it
s/b
the SSP target port

● Author: RElliott
Subject: Highlight
Date: 6/30/2008 6:16:52 PM
T ACCEPT - DONE

target port
s/b
SSP target port

● Author: RElliott
Subject: Highlight
Date: 6/30/2008 6:16:52 PM
T ACCEPT - DONE

the
s/b
then the

● Author: RElliott
Subject: Highlight
Date: 6/30/2008 6:16:52 PM
T ACCEPT - DONE

it

Comments from page 444 continued on next page

Table 164 — FRAME TYPE field

Code	Name of frame	Type of information unit	Originator	Information unit size (bytes)	Reference
01h	DATA frame (i.e., write DATA frame or read DATA frame)	Data information unit (i.e., write Data information unit or read Data information unit)	SSP initiator port or SSP target port	1 to 1 024	9.2.2.4
05h	XFER_RDY frame	Transfer Ready information unit	SSP target port	12	9.2.2.3
06h	COMMAND frame	Command information unit	SSP initiator port	28 to 280	9.2.2.1
07h	RESPONSE frame	Response information unit	SSP target port	24 to 1 024	9.2.2.5
16h	TASK frame	Task Management Function information unit	SSP initiator port	28	9.2.2.2
F0h - FFh	Vendor specific				
All others	Reserved				

The HASHED SOURCE SAS ADDRESS field contains the hashed value of the source SAS address (see 4.2.3). See 9.2.6.2.2 and 9.2.6.3.2 for transport layer requirements on checking this field.

If an initiator port supports transport layer retries, it shall set the TLR CONTROL field to 01b in each COMMAND frame it sends unless it has determined that the I_T_L nexus does not support the TLR CONTROL field.

If an initiator port does not support transport layer retries, it shall set the TLR CONTROL field to 10b in each COMMAND frame it sends unless it has determined that the I_T_L nexus does not support the TLR CONTROL field.

An initiator port determines that an I_T_L nexus does not support the TLR CONTROL field if it sends a COMMAND frame with the TLR CONTROL field set to 01b or 10b and receives a RESPONSE frame with the DATAPRES field set to RESPONSE_DATA and the RESPONSE CODE field set to 02h (i.e., INVALID FRAME). After determining that an I_T_L nexus does not support the TLR CONTROL field, an initiator port shall set the TLR CONTROL field to 00b for subsequent COMMAND frames for that I_T_L nexus.

NOTE 84 - Initiator ports compliant with previous versions of this standard always set the TLR CONTROL field to 00b.

NOTE 85 - The TLR CONTROL SUPPORTED field in the Protocol-Specific Logical Unit Information VPD page (see 10.2.11.3) indicates if the target port supports the TLR CONTROL field set to a non-zero value.

A TLR CONTROL field set to 00b or 11b in a COMMAND frame specifies that the SSP target port shall use the TRANSPORT LAYER RETRIES bit in the Protocol-Specific Logical Unit mode page (see 10.2.7.3) to enable or disable transport layer retries for this command:

- a) if the TRANSPORT LAYER RETRIES bit is set to one, the target port shall set the RETRY DATA FRAMES bit to one in any XFER_RDY frames that it transmits for this command; and
- b) if the TRANSPORT LAYER RETRIES bit is set to zero, the target port shall set the RETRY DATA FRAMES bit to zero in any XFER_RDY frames that it transmits for this command.

s/b
the SSP target port

A TLR CONTROL field set to 01b in a COMMAND frame specifies that the SSP target port may enable transport layer retries for this command and:

- a) if it enables transport layer retries, the target port shall set the RETRY DATA FRAMES bit to one in any XFER_RDY frames that it transmits for this command; and
- b) if it does not enable transport layer retries, the target port shall set the RETRY DATA FRAMES bit to zero in any XFER_RDY frames that it transmits for this command.

A TLR CONTROL field set to 10b in a COMMAND frame specifies that the SSP target port shall:

- a) disable transport layer retries for this command; and
- b) set the RETRY DATA FRAMES bit to zero in any XFER_RDY frames that it transmits for this command.

The TLR CONTROL field is reserved for frames other than COMMAND frames.

A target port sets the RETRY DATA FRAMES bit in an XFER_RDY frame based on the TLR CONTROL field received in the COMMAND frame for the command and the TRANSPORT LAYER RETRIES bit in the Protocol-Specific Logical Unit mode page (see 10.2.7.3).

A RETRY DATA FRAMES bit set to one in an XFER_RDY frame specifies that the SSP initiator port shall enable transport layer retries for write DATA transfers related to this XFER_RDY.

A RETRY DATA FRAMES bit set to zero in an XFER_RDY frame specifies that the SSP initiator port shall disable transport layer retries for write DATA transfers related to this XFER_RDY.

The RETRY DATA FRAMES bit is reserved for frames other than XFER_RDY frames.

A RETRANSMIT bit set to one specifies that the frame is a retransmission after the SSP port failed in its previous attempt to transmit the frame. The RETRANSMIT bit is set to one for TASK frames, RESPONSE frames, and XFER_RDY frames under the conditions defined in 9.2.4 and shall be set to zero for all other frame types.

A CHANGING DATA POINTER bit set to one ~~this bit~~ specifies that the frame is a retransmission after the SSP port failed in its previous attempt to transmit the frame or a subsequent frame and the DATA OFFSET field of the frame may not be sequentially increased from that of the previous frame. The CHANGING DATA POINTER bit is set to one for DATA frames under the conditions defined in 9.2.4 and shall be set to zero for all other frame types.

The NUMBER OF FILL BYTES field specifies the number of fill bytes between the INFORMATION UNIT field and the CRC field. The NUMBER OF FILL BYTES field shall be set to zero for all frame types except DATA frames as specified in 9.2.2.4 and RESPONSE frames as specified in 9.2.2.5 (i.e., all other frame types are already four-byte aligned).

The TAG field contains a value that allows the SSP initiator port to establish a context for commands and task management functions.

For COMMAND frames and TASK frames, the SSP initiator port shall set the TAG field to a value that is unique for the I_T nexus established by the connection (see 7.12). An SSP initiator port shall not reuse the same tag when transmitting COMMAND frames or TASK frames to different LUNs in the same SSP target port. An SSP initiator port may reuse a tag when transmitting frames to different SSP target ports. An SSP initiator port does not reuse a tag until it receives indication from the SSP target port that the tag is no longer in use (see 9.2.4, 9.2.5, and 10.2.2).

The TAG field in a COMMAND frame contains the task tag defined in SAM-4. The TAG field in a TASK frame does not correspond to a SAM-4 task tag, but corresponds to an SAM-4 association (see 10.2.1). The tag space used in the TAG fields is shared across COMMAND frames and TASK frames (e.g., if a tag is used for a COMMAND frame, it is not also used for a concurrent TASK frame).

For DATA, XFER_RDY, and RESPONSE frames, the SSP target port shall set the TAG field to the tag of the command or task management function to which the frame pertains.

The TARGET PORT TRANSFER TAG field provides an optional method for an SSP target port to establish the write data context when receiving a write DATA frame (i.e., determine the command to which the write data corresponds). Unlike the TAG field, which was assigned by the SSP initiator port, the TARGET PORT TRANSFER TAG field in a write DATA frame contains a value assigned by the SSP target port that was delivered to the SSP initiator port in the XFER_RDY frame requesting the write data.

Page: 445

Author: RElliott
Subject: Underline
Date: 6/30/2008 6:16:52 PM
 ACCEPT - DONE

and
s/b
, and

Author: RElliott
Subject: Note
Date: 6/30/2008 6:16:52 PM
 ACCEPT - DONE

To follow the first noun/subject convention for "it", reword as 3 single sentence paragraphs. They're all in a table cell of their own, so it's not important to bunch them into one paragraph.

The SSP target port may enable transport layer retries for this command.

If the SSP target port enables transport layer retries, then it shall set the retry data frames bit to one in any XFER_RDY frames that it transmits for this command.

If the SSP target port does not enable transport layer retries, then it shall set the retry data frames bit to zero in any XFER_RDY frames that it transmits for this command.

Author: wdc-mevans
Subject: Highlight
Date: 6/17/2008 7:55:18 PM
 ACCEPT - DONE (see rewording comment)

it
s/b
the SSP target port

Author: RElliott
Subject: Highlight
Date: 6/30/2008 6:16:52 PM
 ACCEPT - DONE
the
s/b
then the

Author: Isi-gpenokie
Subject: Highlight
Date: 6/17/2008 7:56:51 PM
 REJECT (a)b list changed into standalone sentences instead)

This << and >> should be << or >> as it is one or the other not both.

Author: wdc-mevans
Subject: Highlight
Date: 6/17/2008 7:55:27 PM
 ACCEPT - DONE (see rewording comment)

it
s/b
the SSP target port

Comments from page 445 continued on next page

A TLR CONTROL field set to 01b in a COMMAND frame specifies that the SSP target port may enable transport layer retries for this command and:

- a) if it enables transport layer retries, the target port shall set the RETRY DATA FRAMES bit to one in any XFER_RDY frames that it transmits for this command; and
- b) if it does not enable transport layer retries, the target port shall set the RETRY DATA FRAMES bit to zero in any XFER_RDY frames that it transmits for this command.

A TLR CONTROL field set to 10b in a COMMAND frame specifies that the SSP target port shall:

- a) disable transport layer retries for this command; and
- b) set the RETRY DATA FRAMES bit to zero in any XFER_RDY frames that it transmits for this command.

The TLR CONTROL field is reserved for frames other than COMMAND frames.

A target port sets the RETRY DATA FRAMES bit in an XFER_RDY frame based on the TLR CONTROL field received in the COMMAND frame for the command and the TRANSPORT LAYER RETRIES bit in the Protocol-Specific Logical Unit mode page (see 10.2.7.3).

A RETRY DATA FRAMES bit set to one in an XFER_RDY frame specifies that the SSP initiator port shall enable transport layer retries for write DATA transfers related to this XFER_RDY.

A RETRY DATA FRAMES bit set to zero in an XFER_RDY frame specifies that the SSP initiator port shall disable transport layer retries for write DATA transfers related to this XFER_RDY.

The RETRY DATA FRAMES bit is reserved for frames other than XFER_RDY frames.

A RETRANSMIT bit set to one specifies that the frame is a retransmission after the SSP port failed in its previous attempt to transmit the frame. The RETRANSMIT bit is set to one for TASK frames, RESPONSE frames, and XFER_RDY frames under the conditions defined in 9.2.4 and shall be set to zero for all other frame types.

A CHANGING DATA POINTER bit set to one this bit specifies that the frame is a retransmission after the SSP port failed in its previous attempt to transmit the frame or a subsequent frame and the DATA OFFSET field of the frame may not be sequentially increased from that of the previous frame. The CHANGING DATA POINTER bit is set to one for DATA frames under the conditions defined in 9.2.4 and shall be set to zero for all other frame types.

The NUMBER OF FILL BYTES field specifies the number of fill bytes between the INFORMATION UNIT field and the CRC field. The NUMBER OF FILL BYTES field shall be set to zero for all frame types except DATA frames as specified in 9.2.2.4 and RESPONSE frames as specified in 9.2.2.5 (i.e., all other frame types are already four-byte aligned).

The TAG field contains a value that allows the SSP initiator port to establish a context for commands and task management functions.

For COMMAND frames and TASK frames, the SSP initiator port shall set the TAG field to a value that is unique for the I_T nexus established by the connection (see 7.12). An SSP initiator port shall not reuse the same tag when transmitting COMMAND frames or TASK frames to different LUNs in the same SSP target port. An SSP initiator port may reuse a tag when transmitting frames to different SSP target ports. An SSP initiator port does not reuse a tag until it receives indication from the SSP target port that the tag is no longer in use (see 9.2.4, 9.2.5, and 10.2.2).

The TAG field in a COMMAND frame contains the task tag defined in SAM-4. The TAG field in a TASK frame does not correspond to a SAM-4 task tag, but corresponds to an SAM-4 association (see 10.2.1). The tag space used in the TAG fields is shared across COMMAND frames and TASK frames (e.g., if a tag is used for a COMMAND frame, it is not also used for a concurrent TASK frame).

For DATA, XFER_RDY, and RESPONSE frames, the SSP target port shall set the TAG field to the tag of the command or task management function to which the frame pertains.

The TARGET PORT TRANSFER TAG field provides an optional method for an SSP target port to establish the write data context when receiving a write DATA frame (i.e., determine the command to which the write data corresponds). Unlike the TAG field, which was assigned by the SSP initiator port, the TARGET PORT TRANSFER TAG field in a write DATA frame contains a value assigned by the SSP target port that was delivered to the SSP initiator port in the XFER_RDY frame requesting the write data.

Author: RElliott
Subject: Highlight
Date: 6/30/2008 6:16:52 PM
T ACCEPT - DONE
the
s/b
then the

Author: elx-bmartin
Subject: Highlight
Date: 6/27/2008 9:54:11 AM
T ACCEPT - DONE (added a footnote to the new table defining TLR CONTROL:
"a If the target port does receives a non-zero value in the tlr control field and does not support non-zero values in the tlr control field,
then it shall reply with a RESPONSE frame with the datapres field set to RESPONSE_DATA and the response code field set to 02h
(i.e., INVALID FRAME)."

Added this to the state machine and the transport layer error handling summary sections too as separate comments.
)

the SSP ...
s.b.
if the SSP target port supports the TLR CONTROL field, then the SSP ...

note from previous page - if the target does not support this it sends a response of INVALID FRAME.

Author: RElliott
Subject: Highlight
Date: 6/30/2008 6:16:52 PM
T ACCEPT - DONE
A target port
s/b
An SSP target port

Author: wdc-mevans
Subject: Cross-Out
Date: 5/6/2008 4:07:49 PM
T ACCEPT - DONE
this bit
[Delete the unnecessary words.]

Author: stx-ghoulder
Subject: Highlight
Date: 5/30/2008 6:51:25 PM
T ACCEPT - DONE
in 9.2.4 and
clause reference should be 9.2.4.5.

Author: RElliott
Subject: Highlight
Date: 6/30/2008 6:16:52 PM
T ACCEPT - DONE
zero
s/b
00b

Author: wdc-mevans
Subject: Cross-Out
Date: 5/6/2008 4:07:49 PM
T ACCEPT - DONE
already
s/b

Comments from page 445 continued on next page

A TLR CONTROL field set to 01b in a COMMAND frame specifies that the SSP target port may enable transport layer retries for this command and:

- a) if it enables transport layer retries, the target port shall set the RETRY DATA FRAMES bit to one in any XFER_RDY frames that it transmits for this command; and
- b) if it does not enable transport layer retries, the target port shall set the RETRY DATA FRAMES bit to zero in any XFER_RDY frames that it transmits for this command.

A TLR CONTROL field set to 10b in a COMMAND frame specifies that the SSP target port shall:

- a) disable transport layer retries for this command; and
- b) set the RETRY DATA FRAMES bit to zero in any XFER_RDY frames that it transmits for this command.

The TLR CONTROL field is reserved for frames other than COMMAND frames.

A target port sets the RETRY DATA FRAMES bit in an XFER_RDY frame based on the TLR CONTROL field received in the COMMAND frame for the command and the TRANSPORT LAYER RETRIES bit in the Protocol-Specific Logical Unit mode page (see 10.2.7.3).

A RETRY DATA FRAMES bit set to one in an XFER_RDY frame specifies that the SSP initiator port shall enable transport layer retries for write DATA transfers related to this XFER_RDY.

A RETRY DATA FRAMES bit set to zero in an XFER_RDY frame specifies that the SSP initiator port shall disable transport layer retries for write DATA transfers related to this XFER_RDY.

The RETRY DATA FRAMES bit is reserved for frames other than XFER_RDY frames.

A RETRANSMIT bit set to one specifies that the frame is a retransmission after the SSP port failed in its previous attempt to transmit the frame. The RETRANSMIT bit is set to one for TASK frames, RESPONSE frames, and XFER_RDY frames under the conditions defined in 9.2.4 and shall be set to zero for all other frame types.

A CHANGING DATA POINTER bit set to one ~~this bit~~ specifies that the frame is a retransmission after the SSP port failed in its previous attempt to transmit the frame or a subsequent frame and the DATA OFFSET field of the frame may not be sequentially increased from that of the previous frame. The CHANGING DATA POINTER bit is set to one for DATA frames under the conditions defined in 9.2.4 and shall be set to zero for all other frame types.

The NUMBER OF FILL BYTES field specifies the number of fill bytes between the INFORMATION UNIT field and the CRC field. The NUMBER OF FILL BYTES field shall be set to zero for all frame types except DATA frames as specified in 9.2.2.4 and RESPONSE frames as specified in 9.2.2.5 (i.e., all other frame types are already four-byte aligned).

The TAG field contains a value that allows the SSP initiator port to establish a context for commands and task management functions.

For COMMAND frames and TASK frames, the SSP initiator port shall set the TAG field to a value that is unique for the I_T nexus established by the connection (see 7.12). An SSP initiator port shall not reuse the same tag when transmitting COMMAND frames or TASK frames to different LUNs in the same SSP target port. An SSP initiator port may reuse a tag when transmitting frames to different SSP target ports. An SSP initiator port does not reuse a tag until it receives indication from the SSP target port that the tag is no longer in use (see 9.2.4, 9.2.5, and 10.2.2).

The TAG field in a COMMAND frame contains the task tag defined in SAM-4. The TAG field in a TASK frame does not correspond to a SAM-4 task tag, but corresponds to an SAM-4 association (see 10.2.1). The tag space used in the TAG fields is shared across COMMAND frames and TASK frames (e.g., if a tag is used for a COMMAND frame, it is not also used for a concurrent TASK frame).

For DATA, XFER_RDY, and RESPONSE frames, the SSP target port shall set the TAG field to the tag of the command or task management function to which the frame pertains.

The TARGET PORT TRANSFER TAG field provides an optional method for an SSP target port to establish the write data context when receiving a write DATA frame (i.e., determine the command to which the write data corresponds). Unlike the TAG field, which was assigned by the SSP initiator port, the TARGET PORT TRANSFER TAG field in a write DATA frame contains a value assigned by the SSP target port that was delivered to the SSP initiator port in the XFER_RDY frame requesting the write data.

[Delete the unnecessary word.]

● Author: lsi-gpenokie

Subject: Highlight

Date: 6/27/2008 1:29:23 PM

T REJECT (The 3 referenced sections describe the rules in more detail. This is actually the responsibility of the application layer not the transport layer, so a "shall" is not well positioned here.)

This << initiator port does not reuse a tag until it >> should be << initiator port shall not reuse a tag until it >>

● Author: RElliott

Subject: Highlight

Date: 6/30/2008 6:16:52 PM

T ACCEPT - DONE

it

s/b

then it

NOTE 86 - The TARGET PORT TRANSFER TAG field may be useful when the SSP target port has more than one XFER_RDY frame outstanding (i.e., the SSP target port has transmitted an XFER_RDY frame for each of two or more commands and has not yet received all the write data for them).

SSP target ports may set the TARGET PORT TRANSFER TAG field to any value when transmitting any SSP frame. SSP target ports that use this field should set the TARGET PORT TRANSFER TAG field in every XFER_RDY frame to a value that is unique for the L_Q portion of the I_T_L_Q nexus (i.e., that is unique for every XFER_RDY that is outstanding from the SSP target port).

SSP initiator ports shall set the TARGET PORT TRANSFER TAG field as follows:

- a) For each write DATA frame that is sent in response to an XFER_RDY frame, the SSP initiator port shall set the TARGET PORT TRANSFER TAG field to the value that was in the corresponding XFER_RDY frame;
- b) For each write DATA frame that is sent containing first burst data (see 9.2.2.4), the SSP initiator port shall set the TARGET PORT TRANSFER TAG field to FFFFh; and
- c) For frames other than write DATA frames, the SSP initiator port shall set the TARGET PORT TRANSFER TAG field to FFFFh.

For DATA frames, the DATA OFFSET field is described in 9.2.2.4. For all other frame types, the DATA OFFSET field shall be ignored.

The INFORMATION UNIT field contains the information unit, the format of which is defined by the FRAME TYPE field (see table 164). The maximum size of the INFORMATION UNIT field is 1 024 bytes, making the maximum size of the frame 1 052 bytes (1 024 bytes of data + 24 bytes of header + 4 bytes of CRC).

Fill bytes shall be included after the INFORMATION UNIT field so the CRC field is aligned on a four byte boundary. The number of fill bytes are specified by the NUMBER OF FILL BYTES field. The contents of the fill bytes are vendor specific.

The CRC field contains a CRC value (see 7.5) that is computed over the entire SSP frame prior to the CRC field including the fill bytes (i.e., all data dwords between the SOF and EOF). The CRC field is checked by the link layer (see 7.16), not the transport layer.

9.2.2 Information units

9.2.2.1 COMMAND frame - Command information unit

The COMMAND frame is sent by an SSP initiator port to request that a command be processed by the device server in a logical unit (see 9.2.3.3, 9.2.3.4, 9.2.3.5, and 9.2.3.6).

Page: 446

● Author: RElliott
Subject: Underline
Date: 6/30/2008 6:16:52 PM
T ACCEPT - DONE

For
s/b
for

(part of global change to lowercase a)b)c) entries)

● Author: RElliott
Subject: Underline
Date: 6/30/2008 6:16:52 PM
T ACCEPT - DONE

For
s/b
for

(part of global change to lowercase a)b)c) entries)

● Author: RElliott
Subject: Underline
Date: 6/30/2008 6:16:52 PM
T ACCEPT - DONE

For
s/b
for

(part of global change to lowercase a)b)c) entries)

● Author: RElliott
Subject: Underline
Date: 6/30/2008 6:16:52 PM
T ACCEPT - DONE

move this earlier and add an i.e.,

24 bytes of header +

● Author: stx-goulder
Subject: Highlight
Date: 6/27/2008 4:36:31 PM
T ACCEPT - DONE

EOF
Should be "the first byte of the CRC field".

● Author: stx-goulder
Subject: Highlight
Date: 6/27/2008 4:40:51 PM

T REJECT (this standard is silent on where the CRC is inserted - the transport and link layer are both possible. It is clear that it must be checked by the link layer, though.)

Comments from page 446 continued on next page

NOTE 86 - The TARGET PORT TRANSFER TAG field may be useful when the SSP target port has more than one XFER_RDY frame outstanding (i.e., the SSP target port has transmitted an XFER_RDY frame for each of two or more commands and has not yet received all the write data for them).

SSP target ports may set the TARGET PORT TRANSFER TAG field to any value when transmitting any SSP frame. SSP target ports that use this field should set the TARGET PORT TRANSFER TAG field in every XFER_RDY frame to a value that is unique for the L_Q portion of the I_T_L_Q nexus (i.e., that is unique for every XFER_RDY that is outstanding from the SSP target port).

SSP initiator ports shall set the TARGET PORT TRANSFER TAG field as follows:

- a) For each write DATA frame that is sent in response to an XFER_RDY frame, the SSP initiator port shall set the TARGET PORT TRANSFER TAG field to the value that was in the corresponding XFER_RDY frame;
- b) For each write DATA frame that is sent containing first burst data (see 9.2.2.4), the SSP initiator port shall set the TARGET PORT TRANSFER TAG field to FFFFh; and
- c) For frames other than write DATA frames, the SSP initiator port shall set the TARGET PORT TRANSFER TAG field to FFFFh.

For DATA frames, the DATA OFFSET field is described in 9.2.2.4. For all other frame types, the DATA OFFSET field shall be ignored.

The INFORMATION UNIT field contains the information unit, the format of which is defined by the FRAME TYPE field (see table 164). The maximum size of the INFORMATION UNIT field is 1 024 bytes, making the maximum size of the frame 1 052 bytes (1 024 bytes of data + 24 bytes of header + 4 bytes of CRC).

Fill bytes shall be included after the INFORMATION UNIT field so the CRC field is aligned on a four byte boundary. The number of fill bytes are specified by the NUMBER OF FILL BYTES field. The contents of the fill bytes are vendor specific.

The CRC field contains a CRC value (see 7.5) that is computed over the entire SSP frame prior to the CRC field including the fill bytes (i.e., all data dwords between the SOF and EOF). The CRC field is checked by the link layer (see 7.16), not the transport layer.

9.2.2 Information units

9.2.2.1 COMMAND frame - Command information unit

The COMMAND frame is sent by an SSP initiator port to request that a command be processed by the device server in a logical unit (see 9.2.3.3, 9.2.3.4, 9.2.3.5, and 9.2.3.6).

checked
should be "generated and checked"

Table 165 defines the Command information unit used in the COMMAND frame.

Table 165 — COMMAND frame - Command information unit

Byte\Bit	7	6	5	4	3	2	1	0
0	LOGICAL UNIT NUMBER							
7								
8	Reserved							
9	ENABLE FIRST BURST	TASK PRIORITY				TASK ATTRIBUTE		
10	Reserved							
11	ADDITIONAL CDB LENGTH (n dwords)						Reserved	
12	CDB							
27								
28	ADDITIONAL CDB BYTES							
27+n×4								

The LOGICAL UNIT NUMBER field contains the address of the logical unit. The structure of the LOGICAL UNIT NUMBER field shall be as defined in SAM-4. If the addressed logical unit does not exist, the task manager shall follow the rules for selection of incorrect logical units defined in SAM-4.

An ENABLE FIRST BURST bit set to one specifies that the SSP target port shall expect first burst data for the command as defined by the FIRST BURST SIZE field in the Disconnect-Reconnect mode page (see 10.2.7.2). An ENABLE FIRST BURST bit set to zero specifies that the SSP target port shall not expect first burst data for the command (i.e., that the FIRST BURST SIZE field in the Disconnect-Reconnect mode page shall be ignored). Application clients shall only set the ENABLE FIRST BURST bit to one if:

- a) the FIRST BURST SIZE field in the Disconnect-Reconnect mode page is non-zero or changeable; and
- b) the logical unit and target port comply with this standard (e.g., as reported in the standard INQUIRY data version descriptors (see SPC-4)).

The TASK PRIORITY field specifies the relative scheduling of the task containing this command in relation to other tasks already in the task set, if the tasks have SIMPLE task attributes (see SAM-4).



Page: 447

Author: Isi-gpenokie
Subject: Highlight
Date: 5/6/2008 4:07:49 PM
T ACCEPT - DONE

Global
Change << TASK PRIORITY >> to << command priority >>

Author: wdc-mevans
Subject: Highlight
Date: 5/6/2008 4:07:49 PM
T ACCEPT - DONE (globally; also per Isi-gop comment)

Global
TASK PRIORITY
s/b
COMMAND PRIORITY

Author: wdc-mevans
Subject: Highlight
Date: 6/27/2008 10:05:22 AM
T ACCEPT - DONE (as "specifies the logical unit number of the logical unit to which the task router shall route the command.")

address of the logical unit.
s/b
LUN of the logical unit addressed by the application client for the command.

Author: RElliott
Subject: Highlight
Date: 6/30/2008 6:16:52 PM
T ACCEPT - DONE

task manager
s/b
task router

Although SAM-4 doesn't say which entity in the SCSI target device handles incorrect LUNs for commands, it does have the task router do that job for TMFs. Since the LUN is incorrect, there probably is no task manager to handle a command either, so the task router is the logical choice for commands as well.

Author: RElliott
Subject: Highlight
Date: 6/30/2008 6:16:52 PM
T ACCEPT - DONE

the
s/b
then the

Author: stx-ghoulder
Subject: Highlight
Date: 5/26/2008 11:19:42 AM
T ACCEPT - DONE

or changeable;
Delete this. If the FIRST BURST SIZE is changeable but set to zero the ENABLE FIRST BURST bit should still be set to zero.

Author: RElliott
Subject: Highlight
Date: 6/30/2008 6:16:52 PM

Comments from page 447 continued on next page

Table 165 defines the Command information unit used in the COMMAND frame.

Table 165 — COMMAND frame - Command information unit

Byte\Bit	7	6	5	4	3	2	1	0
0	LOGICAL UNIT NUMBER							
7								
8	Reserved							
9	ENABLE FIRST BURST	TASK PRIORITY				TASK ATTRIBUTE		
10	Reserved							
11	ADDITIONAL CDB LENGTH (n dwords)						Reserved	
12	CDB							
27								
28	ADDITIONAL CDB BYTES							
27+n×4								

The LOGICAL UNIT NUMBER field contains the address of the logical unit. The structure of the LOGICAL UNIT NUMBER field shall be as defined in SAM-4. If the addressed logical unit does not exist, the task manager shall follow the rules for selection of incorrect logical units defined in SAM-4.

An ENABLE FIRST BURST bit set to one specifies that the SSP target port shall expect first burst data for the command as defined by the FIRST BURST SIZE field in the Disconnect-Reconnect mode page (see 10.2.7.2). An ENABLE FIRST BURST bit set to zero specifies that the SSP target port shall not expect first burst data for the command (i.e., that the FIRST BURST SIZE field in the Disconnect-Reconnect mode page shall be ignored). Application clients shall only set the ENABLE FIRST BURST bit to one if:

- a) the FIRST BURST SIZE field in the Disconnect-Reconnect mode page is non-zero or changeable; and
- b) the logical unit and target port comply with this standard (e.g., as reported in the standard INQUIRY data version descriptors (see SPC-4)).

The TASK PRIORITY field specifies the relative scheduling of the task containing this command in relation to other tasks already in the task set, if the tasks have SIMPLE task attributes (see SAM-4).



T ACCEPT - DONE
non-zero
s/b
set to a value other than 0000h

● Author: RElliott
Subject: Highlight
Date: 6/30/2008 6:16:52 PM

T ACCEPT - DONE

target port
s/b
SSP target port

● Author: wdc-mevans
Subject: Highlight
Date: 5/6/2008 4:07:49 PM

T ACCEPT - DONE (as "The command priority field specifies the relative scheduling importance of a command with the task attribute field set to 000b (i.e., SIMPLE) in relation to other commands already in the task set with SIMPLE task attributes (see SAM-4)")

The TASK PRIORITY field specifies the relative scheduling of the task containing this command in relation to other tasks already in the task set, if the tasks have SIMPLE task attributes (see SAM-4).

s/b

If the TASK ATTRIBUTE field is set to SIMPLE (see table 166), then the COMMAND PRIORITY field specifies the relative scheduling importance of this command in relation to other commands having the SIMPLE task attribute that are already in the task set (see SAM-4).

● Author: RElliott
Subject: Note
Date: 6/30/2008 6:16:52 PM

T ACCEPT - DONE

SIMPLE
s/b
small caps
to match SAM-4

The TASK ATTRIBUTE field is defined in table 166.

Table 166 — TASK ATTRIBUTE field

Code	Task attribute	Description
000b	SIMPLE	Specifies that the task be managed according to the rules for a simple task attribute (see SAM-4).
001b	HEAD OF QUEUE	Specifies that the task be managed according to the rules for a head of queue task attribute (see SAM-4).
010b	ORDERED	Specifies that the task be managed according to the rules for an ordered task attribute (see SAM-4).
011b	Reserved	
100b	ACA	Specifies that the task be managed according to the rules for an automatic contingent allegiance task attribute (see SAM-4).
101b-111b	Reserved	

The ADDITIONAL CDB LENGTH field contains the length in dwords (four bytes) of the ADDITIONAL CDB field.

The CDB and ADDITIONAL CDB BYTES fields together contain the CDB to be interpreted by the addressed logical unit. Any bytes between the end of the CDB and the end of the two fields shall be ignored (e.g., a six-byte CDB occupies the first six bytes of the CDB field, the remaining ten bytes of the CDB field are ignored, and the ADDITIONAL CDB BYTES field is not present).

The contents of the CDB are defined in the SCSI command standards (e.g., SPC-4).

9.2.2.2 TASK frame - Task Management Function information unit

The TASK frame is sent by an SSP initiator port to request that a task management function be processed by the task manager in a logical unit (see 9.2.3.2).

Table 167 defines the Task Management Function information unit used in the TASK frame.

Table 167 — TASK frame - Task Management Function information unit

Byte\Bit	7	6	5	4	3	2	1	0
0	LOGICAL UNIT NUMBER							
7								
8	Reserved							
9	Reserved							
10	TASK MANAGEMENT FUNCTION							
11	Reserved							
12	(MSB)	TAG OF TASK TO BE MANAGED						(LSB)
13								
14	Reserved							
27								

Page: 448

Author: RElliott
Subject: Highlight
Date: 6/30/2008 6:16:52 PM
T ACCEPT - DONE

simple
s/b
smallcaps
to match SAM-4

Author: RElliott
Subject: Highlight
Date: 6/30/2008 6:16:52 PM
T ACCEPT - DONE

head of queue
s/b
smallcaps
to match SAM-4

Author: RElliott
Subject: Highlight
Date: 6/30/2008 6:16:52 PM
T ACCEPT - DONE

ordered
s/b
smallcaps
to match SAM-4

Author: RElliott
Subject: Highlight
Date: 6/30/2008 6:16:52 PM
T ACCEPT - DONE

automatic contingent allegiance
s/b
aca
in smallcaps

to match SAM-4

Author: wdc-mevans
Subject: Highlight
Date: 5/22/2008 4:24:37 PM
T ACCEPT - DONE

(four bytes)
s/b
(i.e., four bytes)

Author: stx-ghoulder
Subject: Highlight
Date: 6/27/2008 10:14:39 AM

T REJECT (If the CDB is greater than 16 bytes, then it is the of the ADDITIONAL CDB bytes field that matters. Thus the "end of the two fields" wording.

Will reword as: "Any bytes after the end of the actual CDB within the two fields shall be ignored")

end of the CDB and the end of the two fields shall be ignored
should be "last valid CDB byte and the end of the CDB field shall be ignored".

Author: RElliott
Subject: Highlight

Comments from page 448 continued on next page

The TASK ATTRIBUTE field is defined in table 166.

Table 166 — TASK ATTRIBUTE field

Code	Task attribute	Description
000b	SIMPLE	Specifies that the task be managed according to the rules for a simple task attribute (see SAM-4).
001b	HEAD OF QUEUE	Specifies that the task be managed according to the rules for a head of queue task attribute (see SAM-4).
010b	ORDERED	Specifies that the task be managed according to the rules for an ordered task attribute (see SAM-4).
011b	Reserved	
100b	ACA	Specifies that the task be managed according to the rules for an automatic contingent allegiance task attribute (see SAM-4).
101b-111b	Reserved	

The ADDITIONAL CDB LENGTH field contains the length in dwords (**four bytes**) of the ADDITIONAL CDB field.

The CDB and ADDITIONAL CDB BYTES fields together contain the CDB to be interpreted by the addressed logical unit. Any bytes between the **end of the CDB and the end of the two fields shall be ignored** (e.g., a six-byte CDB occupies the first six bytes of the CDB field, the remaining ten bytes of the CDB field are ignored, and the ADDITIONAL CDB BYTES field is not present).

The contents of the CDB are defined in the SCSI command standards (e.g., SPC-4).

9.2.2.2 TASK frame - Task Management Function information unit

The TASK frame is sent by an SSP initiator port to request that a task management function be processed by the task manager in a logical unit (see 9.2.3.2).

Table 167 defines the Task Management Function information unit used in the TASK frame.

Table 167 — TASK frame - Task Management Function information unit

Byte\Bit	7	6	5	4	3	2	1	0	
0	LOGICAL UNIT NUMBER								
7									
8	Reserved								
9	Reserved								
10	TASK MANAGEMENT FUNCTION								
11	Reserved								
12	(MSB)	TAG OF TASK TO BE MANAGED							
13								(LSB)	
14	Reserved								
27									

Date: 6/30/2008 6:16:52 PM

T ACCEPT - DONE

Global - to match SAM-4 elimination of "task", change this field name. This may make it clearer that TMFs using this field manage commands and not other TMFs, too. Since another comment is expanding "tag" to "initiator port transfer tag", get rid of the "of task" part altogether to keep the field size smaller. Shorten "to be managed" to "to manage" as well.

TAG OF TASK TO BE MANAGED

s/b

INITIATOR PORT TRANSFER TAG TO MANAGE

The LOGICAL UNIT NUMBER field contains the address of the logical unit. The structure of the logical unit number field shall be as defined in SAM-4. If the addressed logical unit does not exist, the task manager shall return a RESPONSE frame with the DATAPRES field set to RESPONSE_DATA and its RESPONSE CODE field set to INCORRECT LOGICAL UNIT NUMBER.

Table 168 defines the TASK MANAGEMENT FUNCTION field.

Table 168 — TASK MANAGEMENT FUNCTION field

Code	Task management function	Uses LOGICAL UNIT NUMBER field	Uses TAG OF TASK TO BE MANAGED field	Description
01h	ABORT TASK	yes	yes	The task manager shall perform the ABORT TASK task management function with L set to the value of the LOGICAL UNIT NUMBER field and Q set to the value of the TAG OF TASK TO BE MANAGED field (see SAM-4). ^a
02h	ABORT TASK SET	yes	no	The task manager shall perform the ABORT TASK SET task management function with L set to the value of the LOGICAL UNIT NUMBER field (see SAM-4). ^a
04h	CLEAR TASK SET	yes	no	The task manager shall perform the CLEAR TASK SET task management function with L set to the value of the LOGICAL UNIT NUMBER field (see SAM-4). ^a
08h	LOGICAL UNIT RESET	yes	no	The task manager shall perform the LOGICAL UNIT RESET task management function with L set to the value of the LOGICAL UNIT NUMBER field (see SAM-4). ^a
10h	I_T NEXUS RESET	no	no	The task manager shall perform the I_T NEXUS RESET task management function (see SAM-4). ^a
20h	Reserved			
40h	CLEAR ACA	yes	no	The task manager shall perform the CLEAR ACA task management function with L set to the value of the LOGICAL UNIT NUMBER field (see SAM-4). ^a
80h	QUERY TASK	yes	yes	The task manager shall perform the QUERY TASK task management function with L set to the value of the LOGICAL UNIT NUMBER field and Q set to the value of the TAG OF TASK TO BE MANAGED field (see SAM-4). ^a
81h	QUERY TASK SET	yes	no	The task manager shall perform the QUERY TASK SET task management function with L set to the value of the LOGICAL UNIT NUMBER field (see SAM-4). ^a
82h	QUERY UNIT ATTENTION	yes	no	The task manager shall perform the QUERY UNIT ATTENTION task management function with L set to the value of the LOGICAL UNIT NUMBER field (see SAM-4). ^a
All others	Reserved			

^a The task manager shall perform the specified task management function with the I and T arguments set to the initiator port and target port involved in the connection used to deliver the TASK frame.

Page: 449

Author: wdc-mevans

Subject: Highlight

Date: 6/27/2008 10:07:12 AM

T ACCEPT - DONE (as "specifies the logical unit number of the logical unit, if any, to which the task router shall route the task management function". Some TMFs don't specify LUNs)

address of the logical unit.

s/b

LUN of the logical unit addressed by the application client for the task management function.

Author: RElliott

Subject: Highlight

Date: 6/30/2008 6:16:52 PM

T ACCEPT - DONE

logical unit number field

s/b

smallcaps

Author: RElliott

Subject: Highlight

Date: 6/30/2008 6:16:52 PM

T ACCEPT - DONE

task manager

s/b

task router

SAM-4 section 7.12 has the task router do this, not a task manager. For TMFs with I_T Nexus scope, there is no particular task manager involved.

Author: RElliott

Subject: Highlight

Date: 6/30/2008 6:16:52 PM

T ACCEPT - DONE

the

s/b

then the

Author: RElliott

Subject: Highlight

Date: 6/30/2008 6:16:52 PM

T ACCEPT - DONE

Description

Left-justify

Author: RElliott

Subject: Note

Date: 6/30/2008 6:16:52 PM

 ACCEPT - DONE

To go with stx-goulder comment on pg 508, add a Support column indicating that all TMFs are mandatory except for CLEAR ACA, which is dicated by SAM-4 (if ACA is supported, it's mandatory.)

M = implementation is mandatory, X = implementation requirements are specified by SAM-4.

Comments from page 449 continued on next page

The LOGICAL UNIT NUMBER field contains the address of the logical unit. The structure of the logical unit number field shall be as defined in SAM-4. If the addressed logical unit does not exist, the task manager shall return a RESPONSE frame with the DATAPRES field set to RESPONSE_DATA and its RESPONSE CODE field set to INCORRECT LOGICAL UNIT NUMBER.

Table 168 defines the TASK MANAGEMENT FUNCTION field.

Table 168 — TASK MANAGEMENT FUNCTION field

Code	Task management function	Uses LOGICAL UNIT NUMBER field	Uses TAG OF TASK TO BE MANAGED field	Description
01h	ABORT TASK	yes	yes	The task manager shall perform the ABORT TASK task management function with L set to the value of the LOGICAL UNIT NUMBER field and Q set to the value of the TAG OF TASK TO BE MANAGED field (see SAM-4). ^a
02h	ABORT TASK SET	yes	no	The task manager shall perform the ABORT TASK SET task management function with L set to the value of the LOGICAL UNIT NUMBER field (see SAM-4). ^a
04h	CLEAR TASK SET	yes	no	The task manager shall perform the CLEAR TASK SET task management function with L set to the value of the LOGICAL UNIT NUMBER field (see SAM-4). ^a
08h	LOGICAL UNIT RESET	yes	no	The task manager shall perform the LOGICAL UNIT RESET task management function with L set to the value of the LOGICAL UNIT NUMBER field (see SAM-4). ^a
10h	I_T NEXUS RESET	no	no	The task manager shall perform the I_T NEXUS RESET task management function (see SAM-4). ^a
20h	Reserved			
40h	CLEAR ACA	yes	no	The task manager shall perform the CLEAR ACA task management function with L set to the value of the LOGICAL UNIT NUMBER field (see SAM-4). ^a
80h	QUERY TASK	yes	yes	The task manager shall perform the QUERY TASK task management function with L set to the value of the LOGICAL UNIT NUMBER field and Q set to the value of the TAG OF TASK TO BE MANAGED field (see SAM-4). ^a
81h	QUERY TASK SET	yes	no	The task manager shall perform the QUERY TASK SET task management function with L set to the value of the LOGICAL UNIT NUMBER field (see SAM-4). ^a
82h	QUERY UNIT ATTENTION	yes	no	The task manager shall perform the QUERY UNIT ATTENTION task management function with L set to the value of the LOGICAL UNIT NUMBER field (see SAM-4). ^a
All others	Reserved			

^a The task manager shall perform the specified task management function with the I and T arguments set to the initiator port and target port involved in the connection used to deliver the TASK frame.



● Author: RElliott
Subject: Highlight
Date: 6/30/2008 6:16:52 PM
T ACCEPT - DONE

Since footnote a is referenced by every entry, move it to the column header

● Author: RElliott
Subject: Highlight
Date: 6/30/2008 6:16:52 PM
T ACCEPT - DONE

QUERY UNIT ATTENTION
s/b
QUERY ASYNCHRONOUS EVENT

to match sam4r14h

● Author: RElliott
Subject: Highlight
Date: 6/30/2008 6:16:52 PM
T ACCEPT - DONE

QUERY UNIT ATTENTION
s/b
QUERY ASYNCHRONOUS EVENT

to match sam4r14h

● Author: RElliott
Subject: Highlight
Date: 6/30/2008 6:16:52 PM
T ACCEPT - DONE

initiator port and target port
s/b
SSP initiator port and SSP target port

If the TASK MANAGEMENT FUNCTION field contains a reserved or unsupported value, the task manager shall return a RESPONSE frame with the DATAPRES field set to RESPONSE_DATA and its RESPONSE CODE field set to TASK MANAGEMENT FUNCTION NOT SUPPORTED.

If the TASK MANAGEMENT FUNCTION field is set to ABORT TASK or QUERY TASK, the TAG OF TASK TO BE MANAGED field specifies the TAG value from the COMMAND frame that contained the task to be aborted or checked. For all other task management functions, the TAG OF TASK TO BE MANAGED field shall be ignored.

9.2.2.3 XFER_RDY frame - Transfer Ready information unit

The XFER_RDY frame is sent by an SSP target port to request write data from the SSP initiator port during a write command or a bidirectional command (see 9.2.3.4 and 9.2.3.6).

Table 169 defines the Transfer Ready information unit used in the XFER_RDY frame.

Table 169 — XFER_RDY frame - Transfer Ready information unit

Byte/Bit	7	6	5	4	3	2	1	0
0	(MSB)							
3	REQUESTED OFFSET							
	(LSB)							
4	(MSB)							
7	WRITE DATA LENGTH							
	(LSB)							
8	Reserved							
11								

The REQUESTED OFFSET field contains the application client buffer offset of the segment of write data in the data-out buffer that the SSP initiator port may transmit to the logical unit using write DATA frames. The requested offset shall be a multiple of four (i.e., each write DATA frame shall begin transferring data on a dword boundary).

The REQUESTED OFFSET field shall be zero for the first XFER_RDY frame of a command unless:

- a) the ENABLE FIRST BURST field in the COMMAND frame (see 9.2.2.1) was set to one; and
- b) the FIRST BURST SIZE field in the Disconnect-Reconnect mode page (see 10.2.7.2.5) is not set to zero.

If the ENABLE FIRST BURST field in the COMMAND frame (see 9.2.2.1) was set to one, then in the initial XFER_RDY frame for the command, the SSP target port shall set the REQUESTED OFFSET field to the application client buffer offset of the segment of write data following the first burst data defined by the FIRST BURST SIZE field in the Disconnect-Reconnect mode page (see 10.2.7.2.5).

If any additional XFER_RDY frames are required for the command and transport-layer retries are not being used, the REQUESTED OFFSET field shall be set to the sum of the requested offset and write data length of the previous XFER_RDY frame.

The WRITE DATA LENGTH field contains the number of bytes of write data the SSP initiator port may transmit to the logical unit using write DATA frames from the application client data-out buffer starting at the requested offset. The SSP target port shall set the WRITE DATA LENGTH field to a value greater than or equal to 00000001h. If the value in the MAXIMUM BURST SIZE field in the Disconnect-Reconnect mode page is not zero, the SSP target port shall set the WRITE DATA LENGTH field to a value less than or equal to the value in the MAXIMUM BURST SIZE field (see 10.2.7.2.4).

If an SSP target port transmits an XFER_RDY frame containing a WRITE DATA LENGTH field that is not divisible by four, the SSP target port shall not transmit any subsequent XFER_RDY frames for that command (i.e., only the last XFER_RDY for a command may request a non-dword multiple write data length).

Page: 450

● Author: RElliott
Subject: Highlight
Date: 6/30/2008 6:16:52 PM
 ACCEPT - DONE

the
s/b
then the

● Author: RElliott
Subject: Highlight
Date: 6/30/2008 6:16:52 PM
 ACCEPT - DONE

the
s/b
then the

● Author: stx-goulder
Subject: Note
Date: 5/6/2008 4:07:50 PM
 REJECT (the last paragraph is the one defining that field. Its sentences are each prefaced by If statements, which makes it less obvious.)

Insert a paragraph:
The TAG OF TASK TO BE MANAGED field indicates the TAG field value of the task that is to be managed. This field is only used for cases indicated in table 168; otherwise, it is ignored.

● Author: RElliott
Subject: Highlight
Date: 6/30/2008 6:16:52 PM
 ACCEPT - DONE

zero
s/b
set to 00000000h

● Author: RElliott
Subject: Highlight
Date: 6/30/2008 6:16:52 PM
 ACCEPT - DONE
ENABLE FIRST BURST field
s/b
ENABLE FIRST BURST bit

● Author: RElliott
Subject: Highlight
Date: 6/30/2008 6:16:52 PM
 ACCEPT - DONE

not set to zero
s/b
set to a value other than 0000h

● Author: RElliott
Subject: Highlight
Date: 6/30/2008 6:16:52 PM
 ACCEPT - DONE
ENABLE FIRST BURST field

Comments from page 450 continued on next page

If the TASK MANAGEMENT FUNCTION field contains a reserved or unsupported value, the task manager shall return a RESPONSE frame with the DATAPRES field set to RESPONSE_DATA and its RESPONSE CODE field set to TASK MANAGEMENT FUNCTION NOT SUPPORTED.

If the TASK MANAGEMENT FUNCTION field is set to ABORT TASK or QUERY TASK, the TAG OF TASK TO BE MANAGED field specifies the TAG value from the COMMAND frame that contained the task to be aborted or checked. For all other task management functions, the TAG OF TASK TO BE MANAGED field shall be ignored.



9.2.2.3 XFER_RDY frame - Transfer Ready information unit

The XFER_RDY frame is sent by an SSP target port to request write data from the SSP initiator port during a write command or a bidirectional command (see 9.2.3.4 and 9.2.3.6).

Table 169 defines the Transfer Ready information unit used in the XFER_RDY frame.

Table 169 — XFER_RDY frame - Transfer Ready information unit

Byte\Bit	7	6	5	4	3	2	1	0	
0	(MSB)								
	REQUESTED OFFSET								
3								(LSB)	
4	(MSB)								
	WRITE DATA LENGTH								
7								(LSB)	
8	Reserved								
11									

The REQUESTED OFFSET field contains the application client buffer offset of the segment of write data in the data-out buffer that the SSP initiator port may transmit to the logical unit using write DATA frames. The requested offset shall be a multiple of four (i.e., each write DATA frame shall begin transferring data on a dword boundary).

The REQUESTED OFFSET field shall be zero for the first XFER_RDY frame of a command unless:

- a) the ENABLE FIRST BURST field in the COMMAND frame (see 9.2.2.1) was set to one; and
- b) the FIRST BURST SIZE field in the Disconnect-Reconnect mode page (see 10.2.7.2.5) is not set to zero.

If the ENABLE FIRST BURST field in the COMMAND frame (see 9.2.2.1) was set to one, then in the initial XFER_RDY frame for the command, the SSP target port shall set the REQUESTED OFFSET field to the application client buffer offset of the segment of write data following the first burst data defined by the FIRST BURST SIZE field in the Disconnect-Reconnect mode page (see 10.2.7.2.5).

If any additional XFER_RDY frames are required for the command and transport-layer retries are not being used, the REQUESTED OFFSET field shall be set to the sum of the requested offset and write data length of the previous XFER_RDY frame.

The WRITE DATA LENGTH field contains the number of bytes of write data the SSP initiator port may transmit to the logical unit using write DATA frames from the application client data-out buffer starting at the requested offset. The SSP target port shall set the WRITE DATA LENGTH field to a value greater than or equal to 00000001h. If the value in the MAXIMUM BURST SIZE field in the Disconnect-Reconnect mode page is not zero, the SSP target port shall set the WRITE DATA LENGTH field to a value less than or equal to the value in the MAXIMUM BURST SIZE field (see 10.2.7.2.4).

If an SSP target port transmits an XFER_RDY frame containing a WRITE DATA LENGTH field that is not divisible by four, the SSP target port shall not transmit any subsequent XFER_RDY frames for that command (i.e., only the last XFER_RDY for a command may request a non-dword multiple write data length).



s/b
ENABLE FIRST BURST bit

● Author: RElliott
Subject: Highlight
Date: 6/30/2008 6:16:52 PM
T ACCEPT - DONE
the
s/b
then the

● Author: RElliott
Subject: Highlight
Date: 6/30/2008 6:16:52 PM
T ACCEPT - DONE
transport-layer retries
s/b
transport layer retries
(to match lsi-gop comments)

● Author: wdc-mevans
Subject: Highlight
Date: 5/6/2008 4:07:50 PM
T REJECT (only two items here)

command and
s/b
command, and

● Author: wdc-mevans
Subject: Highlight
Date: 5/23/2008 2:14:54 PM
T ACCEPT - DONE

the
s/b
then the

● Author: RElliott
Subject: Highlight
Date: 6/30/2008 6:16:52 PM
T ACCEPT - DONE

zero
s/b
0000h

● Author: wdc-mevans
Subject: Highlight
Date: 6/27/2008 10:27:49 AM
T ACCEPT - DONE (as "the number of bytes specified by the maximum burst size field")

the value in the MAXIMUM BURST SIZE field (see 10.2.7.2.4).
s/b
the value in the MAXIMUM BURST SIZE field times 512 (see 10.2.7.2.4).

● Author: RElliott
Subject: Highlight
Date: 6/30/2008 6:16:52 PM
T ACCEPT - DONE
the
s/b
then the

If the TASK MANAGEMENT FUNCTION field contains a reserved or unsupported value, the task manager shall return a RESPONSE frame with the DATAPRES field set to RESPONSE_DATA and its RESPONSE CODE field set to TASK MANAGEMENT FUNCTION NOT SUPPORTED.

If the TASK MANAGEMENT FUNCTION field is set to ABORT TASK or QUERY TASK, the TAG OF TASK TO BE MANAGED field specifies the TAG value from the COMMAND frame that contained the task to be aborted or checked. For all other task management functions, the TAG OF TASK TO BE MANAGED field shall be ignored.



9.2.2.3 XFER_RDY frame - Transfer Ready information unit

The XFER_RDY frame is sent by an SSP target port to request write data from the SSP initiator port during a write command or a bidirectional command (see 9.2.3.4 and 9.2.3.6).

Table 169 defines the Transfer Ready information unit used in the XFER_RDY frame.

Table 169 — XFER_RDY frame - Transfer Ready information unit

Byte\Bit	7	6	5	4	3	2	1	0	
0	(MSB)							REQUESTED OFFSET	
3									
4	(MSB)							WRITE DATA LENGTH	
7									
8								Reserved	
11									

The REQUESTED OFFSET field contains the application client buffer offset of the segment of write data in the data-out buffer that the SSP initiator port may transmit to the logical unit using write DATA frames. The requested offset shall be a multiple of four (i.e., each write DATA frame shall begin transferring data on a dword boundary).

The REQUESTED OFFSET field shall be zero for the first XFER_RDY frame of a command unless:

- a) the ENABLE FIRST BURST field in the COMMAND frame (see 9.2.2.1) was set to one; and
- b) the FIRST BURST SIZE field in the Disconnect-Reconnect mode page (see 10.2.7.2.5) is not set to zero.

If the ENABLE FIRST BURST field in the COMMAND frame (see 9.2.2.1) was set to one, then in the initial XFER_RDY frame for the command, the SSP target port shall set the REQUESTED OFFSET field to the application client buffer offset of the segment of write data following the first burst data defined by the FIRST BURST SIZE field in the Disconnect-Reconnect mode page (see 10.2.7.2.5).

If any additional XFER_RDY frames are required for the command and transport-layer retries are not being used, the REQUESTED OFFSET field shall be set to the sum of the requested offset and write data length of the previous XFER_RDY frame.

The WRITE DATA LENGTH field contains the number of bytes of write data the SSP initiator port may transmit to the logical unit using write DATA frames from the application client data-out buffer starting at the requested offset. The SSP target port shall set the WRITE DATA LENGTH field to a value greater than or equal to 00000001h. If the value in the MAXIMUM BURST SIZE field in the Disconnect-Reconnect mode page is not zero, the SSP target port shall set the WRITE DATA LENGTH field to a value less than or equal to the value in the MAXIMUM BURST SIZE field (see 10.2.7.2.4).

If an SSP target port transmits an XFER_RDY frame containing a WRITE DATA LENGTH field that is not divisible by four, the SSP target port shall not transmit any subsequent XFER_RDY frames for that command (i.e., only the last XFER_RDY for a command may request a non-dword multiple write data length).



● Author: RElliott
Subject: Highlight
Date: 6/30/2008 6:16:52 PM
T ACCEPT - DONE
the
s/b
then the

● Author: wdc-mevans
Subject: Highlight
Date: 6/27/2008 10:28:55 AM
T ACCEPT - DONE (as "WRITE DATA LENGTH field set to a value that...")
a WRITE
s/b
a value in the WRITE

● Author: RElliott
Subject: Highlight
Date: 6/30/2008 6:16:52 PM
T ACCEPT - DONE
the
s/b
then the

● Author: RElliott
Subject: Note
Date: 6/30/2008 6:16:52 PM
ACCEPT - DONE

Per 6/11 LB call, add:

The value in the requested offset field plus the value of the write data length field shall not be greater than 1_00000000h (i.e., a SCSI command shall not transfer more than 2^{32} bytes of write data).

See related comments in Data IU section and chapter 10 on page 509.

9.2.2.4 DATA frame - Data information unit

During a write command or a bidirectional command (see 9.2.3.4 and 9.2.3.6), one or more write DATA frames are sent by an SSP initiator port to deliver write data.

During a read command or a bidirectional command (see 9.2.3.5 and 9.2.3.6), one or more read DATA frames are sent by an SSP target port to deliver read data.

Table 170 defines the Data information unit used in the DATA frame.

Table 170 — DATA frame - Data information unit

Byte\Bit	7	6	5	4	3	2	1	0
0	DATA							
n								

The DATA field contains the read data (i.e., data to the application client's data-in buffer) or write data (i.e., data from the application client's data-out buffer). The size of the DATA field (i.e., the data length) is determined by the NUMBER OF FILL BYTES field in the frame header (see 9.2.1) and the link layer reception of EOF (see 7.16.3).

The maximum size of the Data information unit (i.e., the DATA field) is the maximum size of any information unit in an SSP frame (see 9.2.1). The minimum size of the Data information unit is one byte.

An SSP initiator port shall only transmit a write DATA frame:

- a) in response to an XFER_RDY frame; or
- b) after transmitting a COMMAND frame if the ENABLE FIRST BURST field in the COMMAND frame was set to one (see 9.2.2.1) and the FIRST BURST SIZE field in the Disconnect-Reconnect mode page is not zero (see 10.2.7.2.5).

If the value in the MAXIMUM BURST SIZE field on the Disconnect-Reconnect mode page is not zero, the maximum amount of data that is transferred at one time by an SSP target port per I_T_L_Q nexus is limited by the value in the MAXIMUM BURST SIZE field (see 10.2.7.2.4).

A write DATA frame shall only contain write data for a single XFER_RDY frame.

An SSP initiator port shall set the NUMBER OF FILL BYTES field to zero in the frame header (see 9.2.1) in all write DATA frames that it transmits in response to an XFER_RDY frame except the last write DATA frame for that XFER_RDY frame. An SSP initiator port may set the NUMBER OF FILL BYTES field to a non-zero value in the last DATA frame that it transmits in response to an XFER_RDY.

NOTE 87 - Combined with the restrictions on WRITE DATA LENGTH in the XFER_RDY frame (see 9.2.2.3), this ensures that only the last write DATA frame for a command may have data with a length that is not a multiple of four).

An SSP target port shall set the NUMBER OF FILL BYTES field to zero in the frame header (see 9.2.1) in all read DATA frames for a command except the last read DATA frame for that command. The SSP target port may set the NUMBER OF FILL BYTES field to a non-zero value in the last read DATA frame for a command (i.e., only the last read DATA frame for a command may contain data with a length that is not a multiple of four).

An SSP initiator port shall not transmit a write DATA frame for a given I_T_L_Q nexus after it has sent a TASK frame that terminates that task (e.g., an ABORT TASK).

The DATA OFFSET field in the frame header (see 9.2.1) contains the application client buffer offset as described by SAM-4. For read DATA frames, this is the offset into the application client's data-in buffer; for write DATA frames, this is the offset into the application client's data-out buffer. The data offset shall be a multiple of four (i.e., each DATA frame shall transfer data beginning on a dword boundary).

The DATA OFFSET field shall be set to zero in the initial read DATA frame for a command. If any additional read DATA frames are required for the command and transport-layer retries are not being used, the DATA OFFSET field shall be set to the sum of the data offset and data length of the previous read DATA frame.

Page: 451

Author: stx-goulder
Subject: Highlight
Date: 6/27/2008 10:41:38 AM

ACCEPT - DONE (as:

The size of the data field (i.e., the data length) is determined by subtracting the following values from the DATA frame size (i.e., the number of bytes between SOF and EOF (see 7.16.3)):

- a) the number of bytes in frame header (i.e., 28);
- b) the number of bytes in the crc field (i.e., 4); and
- c) the number of fill bytes, specified by the number of fill bytes field in the frame header (see 9.2.1).

)

The size of the DATA field (i.e., the data length) is determined by the NUMBER OF FILL BYTES field in the frame header (see 9.2.1) and the link layer reception of EOF (see 7.16.3).

This description is insufficient. I suggest: "The size of the DATA field (i.e., the data length) is determined by counting the number of data dwords between SOF and EOF and subtracting 28 (to account for the 24 byte header information and the 4 byte CRC information). The number of valid data bytes is determined by ignoring the last NUMBER OF FILL BYTES bytes of the DATA field."

Author: stx-goulder
Subject: Highlight
Date: 5/30/2008 6:53:53 PM

REJECT (9.2.1 includes the frame layout and table 164 showing information unit sizes. Since the cross reference follows "an SSP frame" it's a better match.)

(see 9.2.1).
replace with "(see table 164)".

Author: RElliott
Subject: Highlight
Date: 6/30/2008 6:16:52 PM

ACCEPT - DONE
ENABLE FIRST BURST field
s/b
ENABLE FIRST BURST bit

Author: RElliott
Subject: Highlight
Date: 6/30/2008 6:16:52 PM

ACCEPT - DONE
is not zero
s/b
set to a value other than 0000h

Author: RElliott
Subject: Highlight
Date: 6/30/2008 6:16:52 PM

ACCEPT - DONE
the
s/b
then the

Author: RElliott
Subject: Highlight
Date: 7/17/2008 5:56:39 PM

ACCEPT - DONE (fix this)
WRITE DATA LENGTH in

Comments from page 451 continued on next page

9.2.2.4 DATA frame - Data information unit

During a write command or a bidirectional command (see 9.2.3.4 and 9.2.3.6), one or more write DATA frames are sent by an SSP initiator port to deliver write data.

During a read command or a bidirectional command (see 9.2.3.5 and 9.2.3.6), one or more read DATA frames are sent by an SSP target port to deliver read data.

Table 170 defines the Data information unit used in the DATA frame.

Table 170 — DATA frame - Data information unit

Byte\Bit	7	6	5	4	3	2	1	0
0	DATA							
n								

The DATA field contains the read data (i.e., data to the application client’s data-in buffer) or write data (i.e., data from the application client’s data-out buffer). The size of the DATA field (i.e., the data length) is determined by the NUMBER OF FILL BYTES field in the frame header (see 9.2.1) and the link layer reception of EOF (see 7.16.3).

The maximum size of the Data information unit (i.e., the DATA field) is the maximum size of any information unit in an SSP frame (see 9.2.1). The minimum size of the Data information unit is one byte.

An SSP initiator port shall only transmit a write DATA frame:

- a) in response to an XFER_RDY frame; or
- b) after transmitting a COMMAND frame if the ENABLE FIRST BURST field in the COMMAND frame was set to one (see 9.2.2.1) and the FIRST BURST SIZE field in the Disconnect-Reconnect mode page is not zero (see 10.2.7.2.5).

If the value in the MAXIMUM BURST SIZE field on the Disconnect-Reconnect mode page is not zero, the maximum amount of data that is transferred at one time by an SSP target port per I_T_L_Q nexus is limited by the value in the MAXIMUM BURST SIZE field (see 10.2.7.2.4).

A write DATA frame shall only contain write data for a single XFER_RDY frame.

An SSP initiator port shall set the NUMBER OF FILL BYTES field to zero in the frame header (see 9.2.1) in all write DATA frames that it transmits in response to an XFER_RDY frame except the last write DATA frame for that XFER_RDY frame. An SSP initiator port may set the NUMBER OF FILL BYTES field to a non-zero value in the last DATA frame that it transmits in response to an XFER_RDY.

NOTE 87 - Combined with the restrictions on WRITE DATA LENGTH in the XFER_RDY frame (see 9.2.2.3), this ensures that only the last write DATA frame for a command may have data with a length that is not a multiple of four).

An SSP target port shall set the NUMBER OF FILL BYTES field to zero in the frame header (see 9.2.1) in all read DATA frames for a command except the last read DATA frame for that command. The SSP target port may set the NUMBER OF FILL BYTES field to a non-zero value in the last read DATA frame for a command (i.e., only the last read DATA frame for a command may contain data with a length that is not a multiple of four).

An SSP initiator port shall not transmit a write DATA frame for a given I_T_L_Q nexus after it has sent a TASK frame that terminates that task (e.g., an ABORT TASK).

The DATA OFFSET field in the frame header (see 9.2.1) contains the application client buffer offset as described by SAM-4. For read DATA frames, this is the offset into the application client’s data-in buffer; for write DATA frames, this is the offset into the application client’s data-out buffer. The data offset shall be a multiple of four (i.e., each DATA frame shall transfer data beginning on a dword boundary).

The DATA OFFSET field shall be set to zero in the initial read DATA frame for a command. If any additional read DATA frames are required for the command and transport-layer retries are not being used, the DATA OFFSET field shall be set to the sum of the data offset and data length of the previous read DATA frame.

● Author: RElliott
Subject: Highlight
Date: 6/30/2008 6:16:52 PM
T ACCEPT - DONE

zero
s/b
00000000h

● Author: RElliott
Subject: Highlight
Date: 6/30/2008 6:16:52 PM
T ACCEPT - DONE

the
s/b
then the

● Author: RElliott
Subject: Highlight
Date: 6/30/2008 6:16:52 PM
T ACCEPT - DONE

the
s/b
then the

● Author: Isi-gpenokie
Subject: Highlight
Date: 5/6/2008 4:07:50 PM
T ACCEPT - DONE

This << transport-layer retries >> should be << transport layer retries >> to be consistent with the other 99.9% time this term is used.

The DATA OFFSET field shall be set to zero in the initial write DATA frame for a command. If any additional write DATA frames are required for the command and transport-layer retries are not being used, the DATA OFFSET field shall be set to the sum of the data offset and data length of the previous write DATA frame.

9.2.2.5 RESPONSE frame - Response information unit

9.2.2.5.1 RESPONSE frame - Response information unit overview

The RESPONSE frame is sent by an SSP target port to deliver:

- a) service response, SCSI status (e.g. GOOD or CHECK CONDITION) and sense data, if any, for a command (see 9.2.3.3, 9.2.3.4, 9.2.3.5, and 9.2.3.6);
- b) service response for a task management function (see 9.2.3.2); or
- c) SSP-specific response (e.g., illegal frame format).

Table 171 defines the Response information unit used in the RESPONSE frame.

Table 171 — RESPONSE frame - Response information unit

Byte\Bit	7	6	5	4	3	2	1	0	
0	Reserved								
7	Reserved								
8	(MSB)	RETRY DELAY TIMER						(LSB)	
9	Reserved								
10	Reserved						DATAPRES		
11	STATUS								
12	Reserved								
15	Reserved								
16	(MSB)	SENSE DATA LENGTH (n bytes)						(LSB)	
19	Reserved								
20	(MSB)	RESPONSE DATA LENGTH (m bytes)						(LSB)	
23	Reserved								
24	RESPONSE DATA (see table 173 in 9.2.2.5.3)(if any)								
23+m	RESPONSE DATA (see table 173 in 9.2.2.5.3)(if any)								
24+m	RESPONSE DATA (see table 173 in 9.2.2.5.3)(if any)								
23+m+n	SENSE DATA (if any)								

The RETRY DELAY TIMER field contains the retry delay timer code (see SAM-4).

Page: 452

● Author: RElliott
Subject: Highlight
Date: 6/30/2008 6:16:52 PM
 ACCEPT - DONE

zero
s/b
00000000h

● Author: lsi-gpenokie
Subject: Highlight
Date: 5/6/2008 4:07:50 PM
 ACCEPT - DONE

This << transport-layer retries >> should be << transport layer retries >> to be consistent with the other 99.9% time this term is used.

● Author: RElliott
Subject: Highlight
Date: 6/30/2008 6:16:52 PM
 ACCEPT - DONE

the
s/b
then the

● Author: RElliott
Subject: Note
Date: 6/30/2008 6:16:52 PM
 ACCEPT - DONE

Per 6/11 LB call, add:

The value in the data offset field plus the size of the data field shall not be greater than 1_00000000h (i.e., a SCSI command shall not transfer more than 2^{32} bytes of write data and/or more than 2^{32} bytes of read data).

and see associated comment in XFER_RDY IU and in chapter 10 on pg 509

● Author: wdc-mevans
Subject: Highlight
Date: 5/22/2008 10:13:44 AM
 ACCEPT - DONE

CONDITION) and
s/b
CONDITION), and

● Author: wdc-mevans
Subject: Highlight
Date: 5/22/2008 10:12:28 AM
 ACCEPT - DONE (as "a service")

service
s/b
the service

● Author: wdc-mevans
Subject: Highlight
Date: 5/22/2008 10:12:35 AM
 ACCEPT - DONE (as "a service")

service

Comments from page 452 continued on next page

The DATA OFFSET field shall be set to **zero** in the initial write DATA frame for a command. If any additional write DATA frames are required for the command and **transport-layer retries** are not being used, **the** DATA OFFSET field shall be set to the sum of the data offset and data length of the previous write DATA frame.



9.2.2.5 RESPONSE frame - Response information unit

9.2.2.5.1 RESPONSE frame - Response information unit overview

The RESPONSE frame is sent by an SSP target port to deliver:

- a) **service** response, SCSI status (e.g., GOOD or CHECK **CONDITION**) and sense data, if any, for a command (see 9.2.3.3, 9.2.3.4, 9.2.3.5, and 9.2.3.6);
- b) **service** response for a task management function (see 9.2.3.2); or
- c) **SSP-specific** response (e.g., illegal frame format).

Table 171 defines the Response information unit used in the RESPONSE frame.

Table 171 — RESPONSE frame - Response information unit

Byte\Bit	7	6	5	4	3	2	1	0	
0	Reserved								
7	Reserved								
8	(MSB)	RETRY DELAY TIMER							
9								(LSB)	
10	Reserved						DATAPRES		
11	STATUS								
12	Reserved								
15	Reserved								
16	(MSB)	SENSE DATA LENGTH (n bytes)							
19								(LSB)	
20	(MSB)	RESPONSE DATA LENGTH (m bytes)							
23								(LSB)	
24	RESPONSE DATA (see table 173 in 9.2.2.5.3)(if any)								
23+m									
24+m									
23+m+n	SENSE DATA (if any)								

The **RETRY DELAY TIMER** field contains the retry delay timer code (see SAM-4).

s/b
the service

● Author: wdc-mevans
Subject: Highlight
Date: 5/22/2008 10:12:42 AM
T ACCEPT - DONE

SSP
s/b
an SSP

● Author: stx-ghoulder
Subject: Highlight
Date: 5/6/2008 4:07:50 PM
T ACCEPT - DONE (affects several areas of the standard. Moved this description into the per-DATAPRES sections so it always sits alongside the STATUS field description. Describe that it is 0000h for task management function responses.)

RETRY DELAY TIMER field contains the retry delay timer code
SAM-4 has renamed this field the STATUS QUALIFIER CODE field. SAS-2 needs to rename this accordingly.

Table 172 defines the DATAPRES field, which specifies the format and content of the STATUS field, SENSE DATA LENGTH field, RESPONSE DATA LENGTH field, RESPONSE DATA field, and SENSE DATA field.

Table 172 — DATAPRES field

Code	Name	Description	Reference
00b	NO_DATA	No response data or sense data present	9.2.2.5.2
01b	RESPONSE_DATA	Response data present	9.2.2.5.3
10b	SENSE_DATA	Sense data present	9.2.2.5.4
11b	Reserved		

The SSP target port shall return a RESPONSE frame with the DATAPRES field set to NO_DATA if a command completes without response data or sense data to return.

The SSP target port shall return a RESPONSE frame with the DATAPRES field set to RESPONSE_DATA in response to every TASK frame and in response to errors that occur while the transport layer is processing a COMMAND frame (see 9.2.5.3).

The SSP target port shall return a RESPONSE frame with the DATAPRES field set to SENSE_DATA if a command completes with sense data to return (e.g., CHECK CONDITION status).

If the DATAPRES field is set to a reserved value, then the SSP initiator port shall discard the RESPONSE frame.

9.2.2.5.2 Response information unit - NO_DATA format

If the DATAPRES field is set to NO_DATA, then:

- a) the SSP target port shall set the STATUS field to the status code for a **command that has ended** (see SAM-4 for a list of status codes);
- b) the SSP target port shall set the SENSE DATA LENGTH field to zero and the RESPONSE DATA LENGTH field to zero;
- c) the SSP initiator port shall ignore the SENSE DATA LENGTH field and the RESPONSE DATA LENGTH field; and
- d) the SSP target port shall not include the SENSE DATA field and the RESPONSE DATA field.



9.2.2.5.3 Response information unit - RESPONSE_DATA format

If the DATAPRES field is set to RESPONSE_DATA, then:

- a) the SSP target port shall set the STATUS field to zero and the SENSE DATA LENGTH field to zero;
- b) the SSP initiator port shall ignore the STATUS field and the SENSE DATA LENGTH field;
- c) the SSP target port shall not include the SENSE DATA field;
- d) the SSP target port shall set the RESPONSE DATA LENGTH field to 00000004h; and
- e) the SSP target port shall include the RESPONSE DATA field.

Table 173 defines the RESPONSE DATA field. The RESPONSE DATA field shall be present if the SSP target port detects any of the conditions described by a non-zero value in the RESPONSE CODE field and shall be present for a RESPONSE frame sent in response to a TASK frame.

Table 173 — RESPONSE DATA field

Byte\Bit	7	6	5	4	3	2	1	0
0	ADDITIONAL RESPONSE INFORMATION							
2	ADDITIONAL RESPONSE INFORMATION							
3	RESPONSE CODE							

● Author: RElliott
Subject: Highlight
Date: 6/30/2008 6:16:52 PM
 ACCEPT - DONE

command that has ended
s/b
completed command
to match sam4r14

● Author: RElliott
Subject: Note
Date: 6/30/2008 6:16:52 PM
 ACCEPT - DONE

Global: wording about setting sense data length and response data length to "zero" s/b "00000000h"

The ADDITIONAL RESPONSE INFORMATION field contains additional response information for certain task management functions (e.g., **QUERY UNIT ATTENTION**) as defined in SAM-4. If the task management function does not define additional response information or the logical unit does not support additional response information, the SSP target port shall set the ADDITIONAL RESPONSE INFORMATION field to 000000h.

Table 174 defines the RESPONSE CODE field, which specifies the error condition or the completion status of a task management function. See 10.2.1.5 and 10.2.1.15 for the mapping of these response codes to SCSI service responses.

Table 174 — RESPONSE CODE field

Code	Description
00h	TASK MANAGEMENT FUNCTION COMPLETE ^a
02h	INVALID FRAME
04h	TASK MANAGEMENT FUNCTION NOT SUPPORTED ^a
05h	TASK MANAGEMENT FUNCTION FAILED ^a
08h	TASK MANAGEMENT FUNCTION SUCCEEDED ^a
09h	INCORRECT LOGICAL UNIT NUMBER ^a
0Ah	OVERLAPPED TAG ATTEMPTED ^b
All others	Reserved
^a Only valid when responding to a TASK frame ^b Returned in case of command/task management function or task management function/task management function tag conflicts.	

9.2.2.5.4 Response information unit - SENSE_DATA format

If the DATAPRES field is set to SENSE_DATA, then:

- the SSP target port shall set the STATUS field to the status code for a **command that has ended** (see SAM-4 for a list of status codes);
- the SSP target port shall set the RESPONSE DATA LENGTH field to zero;
- the SSP initiator port shall ignore the RESPONSE DATA LENGTH field;
- the SSP target port shall not include the RESPONSE DATA field;
- the SSP target port shall set the SENSE DATA LENGTH field to a non-zero value indicating the number of bytes in the SENSE DATA field. The value in the SENSE DATA LENGTH field shall not be greater than 1 000 (see table 164 in 9.2.1); and
- the SSP target port shall set the SENSE DATA field to the sense data (see SAM-4).

The value in the SENSE DATA LENGTH field is not required to be a multiple of four. **If it is not, the** value in the NUMBER OF FILL BYTES field in the SSP frame header is non-zero and fill bytes are present.

Author: RElliott
Subject: Highlight
Date: 6/30/2008 6:16:52 PM
T ACCEPT - DONE

QUERY UNIT ATTENTION
s/b
QUERY ASYNCHRONOUS EVENT

to match sam4r14h

Author: wdc-mevans
Subject: Highlight
Date: 5/26/2008 11:23:27 AM
T REJECT (2 things being ANDED)

information or
s/b
information, or

Author: wdc-mevans
Subject: Highlight
Date: 5/23/2008 2:17:53 PM
T ACCEPT - DONE

the
s/b
then the

Author: RElliott
Subject: Highlight
Date: 6/30/2008 6:16:52 PM
T ACCEPT - DONE

frame
s/b
frame.

Author: RElliott
Subject: Highlight
Date: 6/30/2008 6:16:52 PM
T ACCEPT - DONE

command that has ended
s/b
completed command
to match sam4r14

Author: wdc-mevans
Subject: Highlight
Date: 5/23/2008 2:18:31 PM
T ACCEPT - DONE

If it is not, the
s/b
If the value is not a multiple of four, then the

9.2.3 Sequences of SSP frames

9.2.3.1 Sequences of SSP frames overview

Table 175 lists the sequences of SSP frames supporting the SCSI transport protocol services described in 10.2.1.

Table 175 — Sequences of SSP frames

Sequence	Reference
Task management function	9.2.3.2
Non-data command	9.2.3.3
Write command	9.2.3.4
Read command	9.2.3.5
Bidirectional command	9.2.3.6

When multiple commands and/or task management functions are outstanding, frames from each of the individual sequences may be interleaved in any order. RESPONSE frames may be returned in any order (i.e., the order in which TASK frames and COMMAND frames are sent has no effect on the order that RESPONSE frames are returned).

Frames in a sequence may be transmitted during one or more connections (see 7.12)(e.g., for a write command using a single XFER_RDY frame, the COMMAND frame could be transmitted in a connection originated by the SSP initiator port, the XFER_RDY frame in a connection originated by the SSP target port, the DATA frames in one or more connections originated by the SSP initiator port, and the RESPONSE frame in a connection originated by the SSP target port. Or, they could all be transmitted in one connection.).

9.2.3.2 Task management function sequence of SSP frames

Figure 210 shows the sequence of SSP frames for a task management function (e.g., ABORT TASK (see SAM-4)), including the transport protocol services (see 10.2.1) invoked by the SCSI application layer.

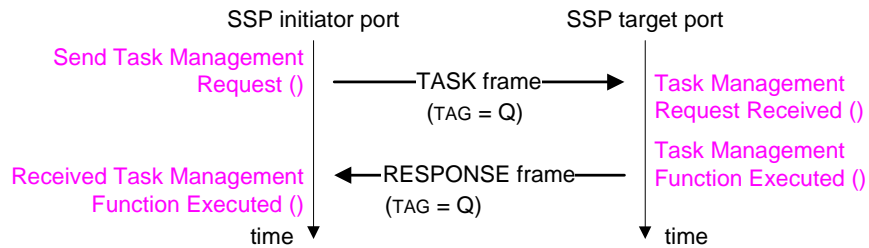

Figure 210 — Task management function sequence of SSP frames

9.2.3.3 Non-data command sequence of SSP frames

Figure 211 shows the sequence of SSP frames for a non-data command (e.g., TEST UNIT READY (see SPC-4)), including the transport protocol services (see 10.2.1) invoked by the SCSI application layer.

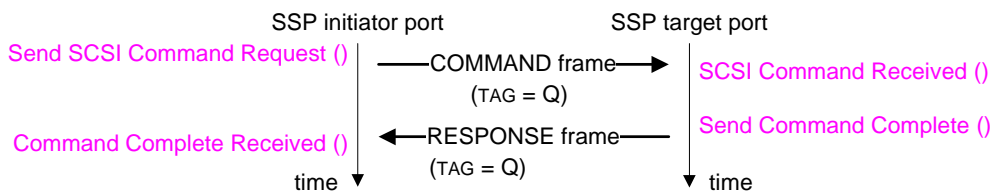

Figure 211 — Non-data command sequence of SSP frames

Author: wdc-mevans

Subject: Highlight

Date: 6/27/2008 10:43:29 AM

T ACCEPT - DONE (changed to "may" since this is an e.g. for a "may" sentence)

the COMMAND frame could

s/b

it is permissible for the COMMAND frame to

Author: RElliott

Subject: Highlight

Date: 6/30/2008 6:16:52 PM

T ACCEPT - DONE

.)

s/b

).

Although the inner words are a sentence, .). doesn't look right

Author: wdc-mevans

Subject: Highlight

Date: 6/27/2008 10:44:29 AM

T ACCEPT - DONE (changed to "Alternatively, all the frames...". Don't want to join the sentences, since the first sentence is already 4 lines long. This gets rid of the vague "they" and provides a stronger break than "Or". Also, changed to "may" since this is an e.g. for a "may" sentence.)

port. Or, they could all

s/b

port, or, all frames for the transaction may

9.2.3.4 Write command sequence of SSP frames

Figure 212 shows the sequence of SSP frames for a write command (e.g., MODE SELECT (see SPC-4)), including the transport protocol services (see 10.2.1) invoked by the SCSI application layer.

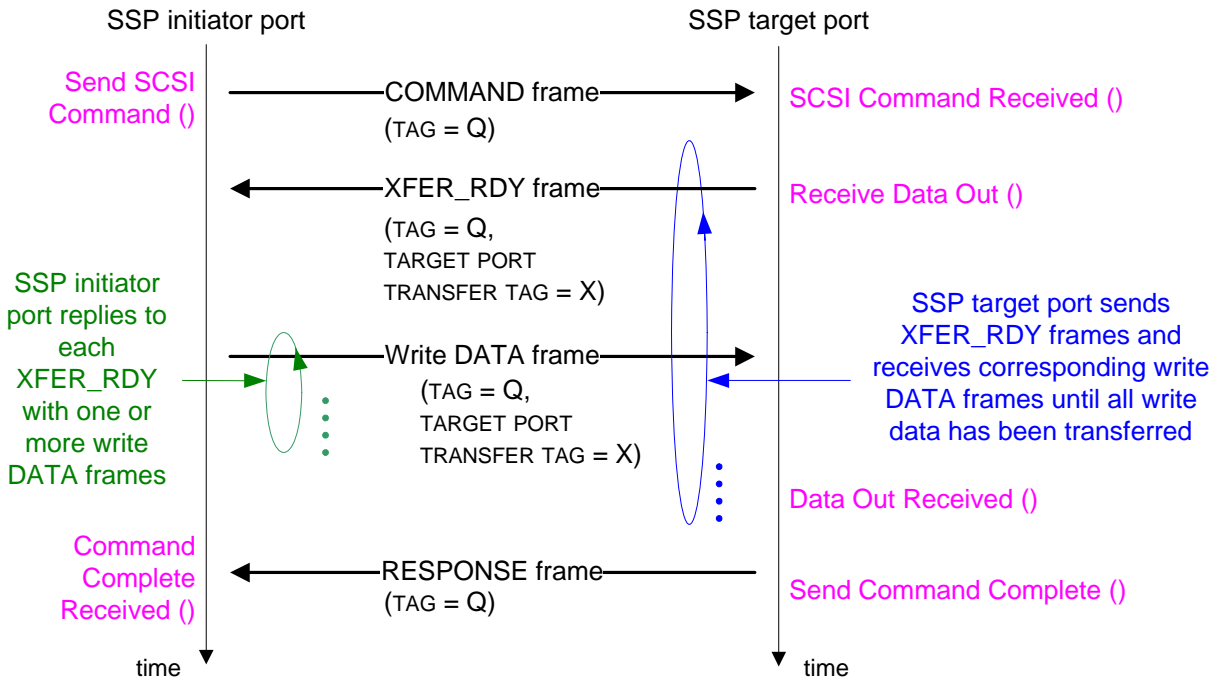

Figure 212 — Write command sequence of SSP frames

9.2.3.5 Read command sequence of SSP frames

Figure 213 shows the sequence of SSP frames for a read command (e.g., INQUIRY, REPORT LUNS, or MODE SENSE (see SPC-4)), including the transport protocol services (see 10.2.1) invoked by the SCSI application layer.

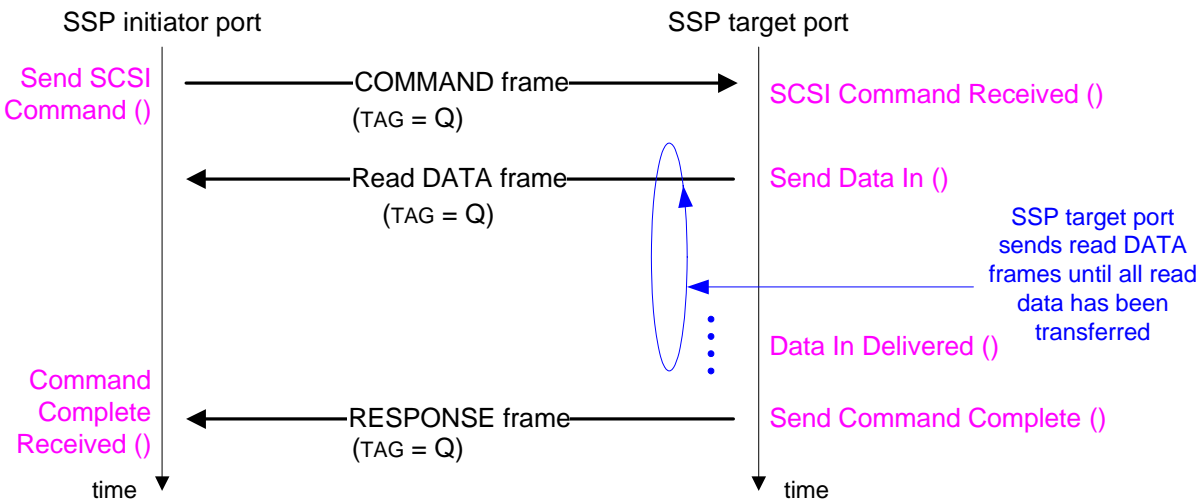

Figure 213 — Read command sequence of SSP frames

This page contains no comments

9.2.3.6 Bidirectional command sequence of SSP frames

Figure 214 shows the sequence of SSP frames for a bidirectional command (e.g., XDWRITEREAD (see SBC-3)), including the transport protocol services (see 10.2.1) invoked by the SCSI application layer.

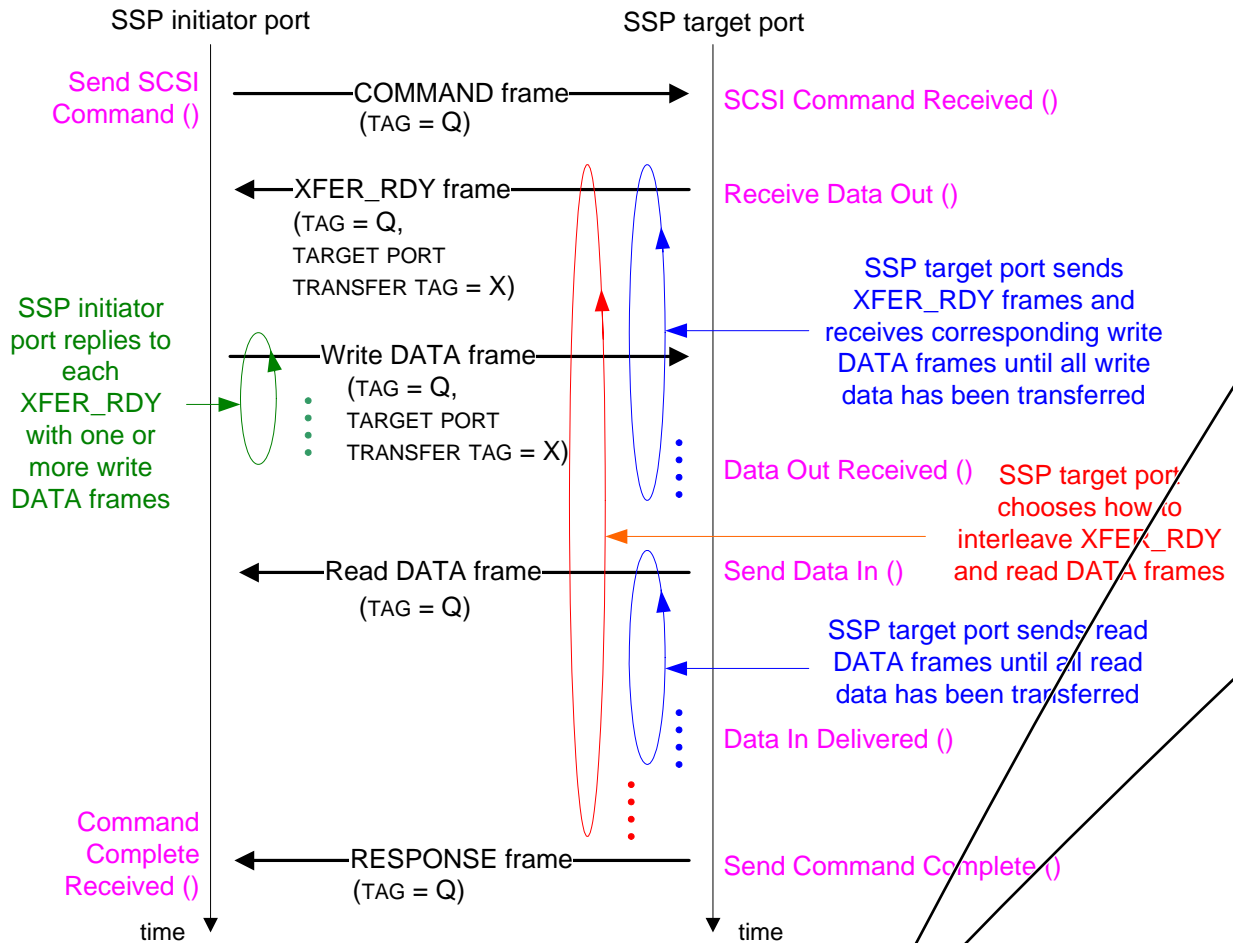

Figure 214 — Bidirectional command sequence of SSP frames

The SSP target port may transmit read DATA frames for a bidirectional command at the same time it is receiving write DATA frames for the same bidirectional command.

9.2.4 SSP transport layer handling of link layer errors

9.2.4.1 SSP transport layer handling of link layer errors overview

The transport layer, sometimes assisted by the application layer, handles some link layer errors (e.g., NAKs and ACK/NAK timeouts). See 9.2.5 for transport layer handling of transport layer errors (e.g., invalid frame contents).

Link layer errors that occur when transmitting XFER_RDY and DATA frames are handled differently based on the TLR CONTROL field in the COMMAND frame header (see 9.2.1) and the TRANSPORT LAYER RETRIES bit in the Protocol-Specific Logical Unit mode page (see 10.2.7.3) of the logical unit that is the source of the frame.

If transport layer retries are disabled, the logical unit:

- a) sets the RETRY DATA FRAMES bit to zero in each XFER_RDY frame;
- b) may or may not select a different value for the TARGET PORT TRANSFER TAG field in each XFER_RDY frame than that used in the previous XFER_RDY frame for that I_T_L_Q nexus;
- c) processes XFER_RDY frame link layer errors as described in 9.2.4.4.3; and
- d) processes DATA frame link layer errors as described in 9.2.4.5.3.

● Author: stx-goulder
Subject: Highlight
Date: 5/26/2008 11:24:34 AM
T ACCEPT - DONE

application layer,
Should be "SCSI application layer".

● Author: wdc-mevans
Subject: Highlight
Date: 5/22/2008 5:22:32 PM
T REJECT (the section title uses "handling" and there's nothing wrong with adverbs)

handled differently based on
s/b
processed in a different manner based on the setting of

● Author: RElliott
Subject: Highlight
Date: 6/30/2008 6:16:52 PM
T ACCEPT - DONE

the
s/b
then the

If transport layer retries are enabled, the logical unit:

- a) supports the QUERY TASK task management function (see SAM-4);
- b) sets the RETRY DATA FRAMES bit to one in each XFER_RDY frame;
- c) selects a different value for the TARGET PORT TRANSFER TAG field in each XFER_RDY frame than that used in the previous XFER_RDY frame for that I_T_L_Q nexus;
- d) processes XFER_RDY frame link layer errors as described in 9.2.4.4.2; and
- e) processes DATA frame link layer errors as described in 9.2.4.5.2.

9.2.4.2 COMMAND frame - handling of link layer errors

If an SSP initiator port transmits a COMMAND frame and receives a NAK for that frame, then the COMMAND frame was not received. The SSP initiator port should retransmit, in the same or in a new connection, the COMMAND frame at least one time (see 9.2.6.2.3.3). The SSP initiator port may reuse the tag.

If an SSP initiator port transmits a COMMAND frame and does not receive an ACK or NAK for that frame (e.g., times out, or the connection is broken):

- 1) the SSP_TF state machine closes the connection with DONE (ACK/NAK TIMEOUT) (see 7.16.8.6.5);
- 2) to determine whether the command was received, the application client calls Send Task Management Function Request () (see 10.2.2) with:
 - A) Nexus set to the I_T_L_Q nexus of the COMMAND frame; and
 - B) Function Identifier set to QUERY TASK;
 and
- 3) the SSP initiator port transmits the TASK frame in a new connection to the SSP target port.

If the SSP initiator port receives an XFER_RDY frame for the I_T_L_Q nexus of the command before the RESPONSE frame for the QUERY TASK, then the COMMAND frame was received and is being processed by the target port, and the XFER_RDY frame is valid.

If the SSP initiator port receives a read DATA frame for the I_T_L_Q nexus of the command before the RESPONSE frame for the QUERY TASK, then the COMMAND frame was received and is being processed by the target port, and the read DATA frame is valid.

If the SSP initiator port receives a RESPONSE frame for the I_T_L_Q nexus of the command before the RESPONSE frame for the QUERY TASK, then the COMMAND frame was received by the target port, the RESPONSE frame is valid, and the command processing is complete. The SSP initiator port may reuse the tag of the COMMAND frame.

If the SSP initiator port receives a RESPONSE frame for the QUERY TASK with a response code of TASK MANAGEMENT FUNCTION SUCCEEDED, then the COMMAND frame was received by the SSP target port (i.e., ACKed) and the command is being processed.

If the SSP initiator port receives a RESPONSE frame for the QUERY TASK with a response code of TASK MANAGEMENT FUNCTION COMPLETE, then the COMMAND frame is not being processed. If neither an XFER_RDY frame, a read DATA frame, nor a RESPONSE frame has been received for the I_T_L_Q nexus of the command, then the COMMAND frame was not received. The SSP initiator port should retransmit the COMMAND frame at least one time. The SSP initiator port may reuse the tag of the COMMAND frame.

9.2.4.3 TASK frame - handling of link layer errors

If an SSP initiator port transmits a TASK frame and receives a NAK for that frame, then the TASK frame was not received. The SSP initiator port should retransmit, in the same or in a new connection, the TASK frame at least one time with the RETRANSMIT bit set to one (see 9.2.6.2.2.2). The SSP initiator port may reuse the tag.

If an SSP initiator port transmits a TASK frame and does not receive an ACK or NAK for that frame (e.g., times out, or the connection is broken):

- 1) the SSP_TF state machine closes the connection with DONE (ACK/NAK TIMEOUT) (see 7.16.8.6.5); and
- 2) the application client calls Send Task Management Request () using the same tag (see 10.2.2);

Page: 458

● Author: RElliott
Subject: Highlight
Date: 6/30/2008 6:16:52 PM

T ACCEPT - DONE
the
s/b
then the

● Author: stx-goulder
Subject: Highlight
Date: 6/27/2008 10:56:40 AM

T ACCEPT - DONE (5/5 yes mandate it, and the new TMFs too. This item can then be deleted.)

supports the QUERY TASK

This implies Query Task is optional (ie only required if transport layer retries are enabled) but command frame error recovery in next clause seems to require Query Task regardless. Which statement is correct?

● Author: stx-goulder
Subject: Highlight
Date: 5/6/2008 4:07:50 PM

T ACCEPT - DONE (renamed everywhere to "initiator port transfer tag", for both this and the TASK frame)

tag

ambiguous meaning of tag. Later in this clause the term "tag of the COMMAND frame" is used, that would be better here. Perhaps we should define a term "command tag" that means the value of the TAG field in the command frame. This term could be used in a lot of places to clear up ambiguous use of "tag".

● Author: RElliott
Subject: Highlight
Date: 6/30/2008 6:16:52 PM

T ACCEPT - DONE

:
s/b
, then:

● Author: stx-goulder
Subject: Highlight
Date: 6/27/2008 11:03:55 AM

T REJECT (actually it's always been mandatory, used by an initiator port to determine if its COMMAND frame made it to the target port if an ACK or NAK doesn't appear. That's not a transport layer retry feature.)

QUERY TASK;

Query Task support is supposed to be optional (i.e., only needed if transport layer retries are supported) but this wording seems to require Query Task support regardless. If Query Task is optional then an alternate recovery method is needed here.

● Author: wdc-mevans
Subject: Highlight
Date: 6/27/2008 5:00:52 PM

T ACCEPT - DONE (as "If the command is a write command or a bidirectional command and ")

the SSP
s/b
the command specified a data-out operation and the SSP

● Author: RElliott
Subject: Highlight
Date: 6/30/2008 6:16:52 PM

T ACCEPT - DONE

target port

Comments from page 458 continued on next page

If transport layer retries are enabled, the logical unit:

- a) supports the QUERY TASK task management function (see SAM-4);
- b) sets the RETRY DATA FRAMES bit to one in each XFER_RDY frame;
- c) selects a different value for the TARGET PORT TRANSFER TAG field in each XFER_RDY frame than that used in the previous XFER_RDY frame for that I_T_L_Q nexus;
- d) processes XFER_RDY frame link layer errors as described in 9.2.4.4.2; and
- e) processes DATA frame link layer errors as described in 9.2.4.5.2.

9.2.4.2 COMMAND frame - handling of link layer errors

If an SSP initiator port transmits a COMMAND frame and receives a NAK for that frame, then the COMMAND frame was not received. The SSP initiator port should retransmit, in the same or in a new connection, the COMMAND frame at least one time (see 9.2.6.2.3.3). The SSP initiator port may reuse the tag.

If an SSP initiator port transmits a COMMAND frame and does not receive an ACK or NAK for that frame (e.g., times out, or the connection is broken):

- 1) the SSP_TF state machine closes the connection with DONE (ACK/NAK TIMEOUT) (see 7.16.8.6.5);
- 2) to determine whether the command was received, the application client calls Send Task Management Function Request () (see 10.2.2) with:
 - A) Nexus set to the I_T_L_Q nexus of the COMMAND frame; and
 - B) Function Identifier set to QUERY TASK;
 and
- 3) the SSP initiator port transmits the TASK frame in a new connection to the SSP target port.

If the SSP initiator port receives an XFER_RDY frame for the I_T_L_Q nexus of the command before the RESPONSE frame for the QUERY TASK, then the COMMAND frame was received and is being processed by the target port, and the XFER_RDY frame is valid.

If the SSP initiator port receives a read DATA frame for the I_T_L_Q nexus of the command before the RESPONSE frame for the QUERY TASK, then the COMMAND frame was received and is being processed by the target port, and the read DATA frame is valid.

If the SSP initiator port receives a RESPONSE frame for the I_T_L_Q nexus of the command before the RESPONSE frame for the QUERY TASK, then the COMMAND frame was received by the target port, the RESPONSE frame is valid, and the command processing is complete. The SSP initiator port may reuse the tag of the COMMAND frame.

If the SSP initiator port receives a RESPONSE frame for the QUERY TASK with a response code of TASK MANAGEMENT FUNCTION SUCCEEDED, then the COMMAND frame was received by the SSP target port (i.e., ACKed) and the command is being processed.

If the SSP initiator port receives a RESPONSE frame for the QUERY TASK with a response code of TASK MANAGEMENT FUNCTION COMPLETE, then the COMMAND frame is not being processed. If neither an XFER_RDY frame, a read DATA frame, nor a RESPONSE frame has been received for the I_T_L_Q nexus of the command, then the COMMAND frame was not received. The SSP initiator port should retransmit the COMMAND frame at least one time. The SSP initiator port may reuse the tag of the COMMAND frame.

9.2.4.3 TASK frame - handling of link layer errors

If an SSP initiator port transmits a TASK frame and receives a NAK for that frame, then the TASK frame was not received. The SSP initiator port should retransmit, in the same or in a new connection, the TASK frame at least one time with the RETRANSMIT bit set to one (see 9.2.6.2.2.2). The SSP initiator port may reuse the tag.

If an SSP initiator port transmits a TASK frame and does not receive an ACK or NAK for that frame (e.g., times out, or the connection is broken):

- 1) the SSP_TF state machine closes the connection with DONE (ACK/NAK TIMEOUT) (see 7.16.8.6.5); and
- 2) the application client calls Send Task Management Request () using the same tag (see 10.2.2);

s/b
SSP target port

(global)

● Author: wdc-mevans
Subject: Highlight
Date: 6/27/2008 5:01:07 PM
T ACCEPT - DONE (as "If the command is a read command or a bidirectional command and ")

the SSP
s/b
the command specified a data-in operation and the SSP

● Author: RElliott
Subject: Highlight
Date: 6/30/2008 6:16:52 PM
T ACCEPT - DONE

target port
s/b
SSP target port

● Author: RElliott
Subject: Highlight
Date: 6/30/2008 6:16:52 PM
T ACCEPT - DONE

target port
s/b
SSP target port

● Author: stx-ghoulder
Subject: Highlight
Date: 7/14/2008 8:34:21 PM
T REJECT (7/14 no desire to enhance this for SAS-2 or SAM-4.

6/18 I_T nexus loss might be appropriate; it would wipe out all other commands (which are probably having problems as well). 5/5 this gets into SAM and above territory; SAS doesn't really care what happens.)

retransmit the COMMAND frame at least one time
Need to add description of action if all retries are unsuccessful as well.

● Author: RElliott
Subject: Underline
Date: 6/30/2008 6:16:52 PM
T ACCEPT - DONE

broken):
s/b
broken), then:

● Author: elx-bmartin
Subject: Highlight
Date: 5/26/2008 11:53:15 AM
T REJECT (like everything else in 9.2.4, these are statements of fact describing what the state machines do. No "shalls" appear here, but they do appear in the state machines)

is the following list part of the above should, or is this a shall, or is this an example of a possible situation?

● Author: Isi-gpenokie
Subject: Cross-Out
Date: 5/6/2008 4:07:50 PM
T ACCEPT - DONE

Comments from page 458 continued on next page

If transport layer retries are enabled, the logical unit:

- a) supports the QUERY TASK task management function (see SAM-4);
- b) sets the RETRY DATA FRAMES bit to one in each XFER_RDY frame;
- c) selects a different value for the TARGET PORT TRANSFER TAG field in each XFER_RDY frame than that used in the previous XFER_RDY frame for that I_T_L_Q nexus;
- d) processes XFER_RDY frame link layer errors as described in 9.2.4.4.2; and
- e) processes DATA frame link layer errors as described in 9.2.4.5.2.

9.2.4.2 COMMAND frame - handling of link layer errors

If an SSP initiator port transmits a COMMAND frame and receives a NAK for that frame, then the COMMAND frame was not received. The SSP initiator port should retransmit, in the same or in a new connection, the COMMAND frame at least one time (see 9.2.6.2.3.3). The SSP initiator port may reuse the tag.

If an SSP initiator port transmits a COMMAND frame and does not receive an ACK or NAK for that frame (e.g., times out, or the connection is broken):

- 1) the SSP_TF state machine closes the connection with DONE (ACK/NAK TIMEOUT) (see 7.16.8.6.5);
- 2) to determine whether the command was received, the application client calls Send Task Management Function Request () (see 10.2.2) with:
 - A) Nexus set to the I_T_L_Q nexus of the COMMAND frame; and
 - B) Function Identifier set to QUERY TASK;
 and
- 3) the SSP initiator port transmits the TASK frame in a new connection to the SSP target port.

If the SSP initiator port receives an XFER_RDY frame for the I_T_L_Q nexus of the command before the RESPONSE frame for the QUERY TASK, then the COMMAND frame was received and is being processed by the target port, and the XFER_RDY frame is valid.

If the SSP initiator port receives a read DATA frame for the I_T_L_Q nexus of the command before the RESPONSE frame for the QUERY TASK, then the COMMAND frame was received and is being processed by the target port, and the read DATA frame is valid.

If the SSP initiator port receives a RESPONSE frame for the I_T_L_Q nexus of the command before the RESPONSE frame for the QUERY TASK, then the COMMAND frame was received by the target port, the RESPONSE frame is valid, and the command processing is complete. The SSP initiator port may reuse the tag of the COMMAND frame.

If the SSP initiator port receives a RESPONSE frame for the QUERY TASK with a response code of TASK MANAGEMENT FUNCTION SUCCEEDED, then the COMMAND frame was received by the SSP target port (i.e., ACKed) and the command is being processed.

If the SSP initiator port receives a RESPONSE frame for the QUERY TASK with a response code of TASK MANAGEMENT FUNCTION COMPLETE, then the COMMAND frame is not being processed. If neither an XFER_RDY frame, a read DATA frame, nor a RESPONSE frame has been received for the I_T_L_Q nexus of the command, then the COMMAND frame was not received. The SSP initiator port should retransmit the COMMAND frame at least one time. The SSP initiator port may reuse the tag of the COMMAND frame.

9.2.4.3 TASK frame - handling of link layer errors

If an SSP initiator port transmits a TASK frame and receives a NAK for that frame, then the TASK frame was not received. The SSP initiator port should retransmit, in the same or in a new connection, the TASK frame at least one time with the RETRANSMIT bit set to one (see 9.2.6.2.2.2). The SSP initiator port may reuse the tag.

If an SSP initiator port transmits a TASK frame and does not receive an ACK or NAK for that frame (e.g., times out, or the connection is broken):

- 1) the SSP_TF state machine closes the connection with DONE (ACK/NAK TIMEOUT) (see 7.16.8.6.5); and
- 2) the application client calls Send Task Management Request () using the same tag (see 10.2.2);

This is on the wrong item

● Author: elx-bmartin
Subject: Highlight
Date: 5/6/2008 4:07:50 PM
T ACCEPT - DONE

and

This and is in the wrong place since there are three items in the list.

● Author: Isi-gpenokie
Subject: Highlight
Date: 5/6/2008 4:07:50 PM
T ACCEPT - DONE

This << same tag (see 10.2.2); >> should be << same tag (see 10.2.2); and >>

- 3) the SSP initiator port transmits the TASK frame with the RETRANSMIT bit set to one in a new connection to the SSP target port (see 9.2.6.2.2).

If the SSP initiator port receives a RESPONSE frame for the TASK frame that arrives before the ACK or NAK for the TASK frame, then the TASK frame was received by the SSP target port (i.e., ACKed), the RESPONSE frame is valid, and the task management function is complete (see 9.2.6.2.3). The initiator port may reuse the tag of the TASK frame. 

9.2.4.4 XFER_RDY frame - handling of link layer errors

9.2.4.4.1 XFER_RDY frame overview

If transport layer retries are enabled, then the SSP target port processes link layer errors that occur while transmitting XFER_RDY frames as described in 9.2.4.4.2.

If transport layer retries are disabled, then the SSP target port processes link layer errors that occur while transmitting XFER_RDY frames as described in 9.2.4.4.3.

9.2.4.4.2 XFER_RDY frame with transport layer retries enabled

If an SSP target port transmits an XFER_RDY frame and receives a NAK for that frame, the SSP target port retransmits, in the same or a new connection, the XFER_RDY frame with a different value in the TARGET PORT TRANSFER TAG field, with the RETRANSMIT bit set to one, and with the other fields set to the same values as in the original XFER_RDY frame (see 9.2.6.3.3).

If an SSP target port transmits an XFER_RDY frame and does not receive an ACK or NAK for that frame (e.g., times out, or the connection is broken):

- 1) the SSP_TF state machine closes the connection with DONE (ACK/NAK TIMEOUT) (see 7.16.8.6.5); and
- 2) the SSP target port retransmits, in a new connection, the XFER_RDY frame with:
 - A) the TARGET PORT TRANSFER TAG field set to a different value than in the original XFER_RDY frame;
 - B) the RETRANSMIT bit set to one; and
 - C) the other fields set to the same values as in the original XFER_RDY frame (see 9.2.6.3.3.3).

If an SSP initiator port receives a new XFER_RDY frame with the RETRANSMIT bit set to one while processing the previous XFER_RDY frame for that I_T_L_Q nexus, the ST_ITS state machine stops processing the previous XFER_RDY frame (i.e., stops transmitting write DATA frames) and starts servicing the new XFER_RDY frame (see 9.2.6.2.3). The ST_ITS state machine does not transmit any write DATA frames for the previous XFER_RDY frame after transmitting a write DATA frame for the new XFER_RDY frame.

The SSP target port may reuse the value in the TARGET PORT TRANSFER TAG field from the previous XFER_RDY frame after it receives a write DATA frame for the new XFER_RDY frame.

An SSP target port retransmits each XFER_RDY frame that does not receive an ACK at least one time.

9.2.4.4.3 XFER_RDY frame with transport layer retries disabled

If an SSP target port transmits an XFER_RDY frame and receives a NAK for that frame:

- 1) the device server calls Send Command Complete () to return CHECK CONDITION status for that command with the sense key set to ABORTED COMMAND and the additional sense code set to NAK RECEIVED (see 10.2.3); and
- 2) the SSP target port transmits the RESPONSE frame in the same or a new connection.

If an SSP target port transmits an XFER_RDY frame and does not receive an ACK or NAK for that frame (e.g., times out, or the connection is broken):

- 1) the SSP_TF state machine closes the connection with DONE (ACK/NAK TIMEOUT) (see 7.16.8.6.5);
- 2) the device server calls Send Command Complete () to return CHECK CONDITION status for that command with the sense key set to ABORTED COMMAND and the additional sense code set to ACK/NAK TIMEOUT (see 10.2.3); and
- 3) the SSP target port transmits the RESPONSE frame in a new connection.

Page: 459

Author: stx-ghoulder
Subject: Highlight
Date: 7/14/2008 8:34:41 PM
T REJECT (7/14 no desire to enhance this for SAS-2 or SAM-4.

6/18 I_T nexus loss might be appropriate; it would wipe out all other commands (which are probably having problems as well). 5/5 this gets into SAM and above territory; SAS doesn't really care what happens.)

transmits the TASK frame
Need to add description of action after retries are exhausted and transfer is still unsuccessful.

Author: elx-nayalasonmayajula
Subject: Note
Date: 5/26/2008 11:26:21 AM
REJECT (9.2.6.3.3.2 discusses the checking (or not) that the target performs. If the task management function is finished - "already responded to" - it doesn't care about the RETRANSMIT bit.)

What does the SSP target do if it receives a TASK frame with RETRANSMIT BIT set for a tag that it had already responded to?

Author: RElliott
Subject: Highlight
Date: 6/30/2008 6:16:52 PM
T ACCEPT - DONE
the
s/b
then the

Author: RElliott
Subject: Underline
Date: 6/30/2008 6:16:52 PM
T ACCEPT - DONE
After:
"the XFER_RDY frame"
add:
"at least one time"

to match the other text like this

Author: RElliott
Subject: Highlight
Date: 6/30/2008 6:16:52 PM
T ACCEPT - DONE
with
s/b
with:
a) ...
b) ...; and
c)

Author: RElliott
Subject: Underline
Date: 6/30/2008 6:16:52 PM
T ACCEPT - DONE
:
s/b
, then:

Author: RElliott
Subject: Highlight

Comments from page 459 continued on next page

- 3) the SSP initiator port transmits the TASK frame with the RETRANSMIT bit set to one in a new connection to the SSP target port (see 9.2.6.2.2.2).

If the SSP initiator port receives a RESPONSE frame for the TASK frame that arrives before the ACK or NAK for the TASK frame, then the TASK frame was received by the SSP target port (i.e., ACKed), the RESPONSE frame is valid, and the task management function is complete (see 9.2.6.2.2.3). The initiator port may reuse the tag of the TASK frame. 

9.2.4.4 XFER_RDY frame - handling of link layer errors

9.2.4.4.1 XFER_RDY frame overview

If transport layer retries are enabled, then the SSP target port processes link layer errors that occur while transmitting XFER_RDY frames as described in 9.2.4.4.2.

If transport layer retries are disabled, then the SSP target port processes link layer errors that occur while transmitting XFER_RDY frames as described in 9.2.4.4.3.

9.2.4.4.2 XFER_RDY frame with transport layer retries enabled

If an SSP target port transmits an XFER_RDY frame and receives a NAK for that frame, the SSP target port retransmits, in the same or a new connection, the XFER_RDY frame with a different value in the TARGET PORT TRANSFER TAG field, with the RETRANSMIT bit set to one, and with the other fields set to the same values as in the original XFER_RDY frame (see 9.2.6.3.3.3).

If an SSP target port transmits an XFER_RDY frame and does not receive an ACK or NAK for that frame (e.g., times out, or the connection is broken):

- 1) the SSP_TF state machine closes the connection with DONE (ACK/NAK TIMEOUT) (see 7.16.8.6.5); and
- 2) the SSP target port retransmits, in a new connection, the XFER_RDY frame with:
 - A) the TARGET PORT TRANSFER TAG field set to a different value than in the original XFER_RDY frame;
 - B) the RETRANSMIT bit set to one; and
 - C) the other fields set to the same values as in the original XFER_RDY frame (see 9.2.6.3.3.3).

If an SSP initiator port receives a new XFER_RDY frame with the RETRANSMIT bit set to one while processing the previous XFER_RDY frame for that I_T_L_Q nexus, the ST_ITS state machine stops processing the previous XFER_RDY frame (i.e., stops transmitting write DATA frames) and starts servicing the new XFER_RDY frame (see 9.2.6.2.3). The ST_ITS state machine does not transmit any write DATA frames for the previous XFER_RDY frame after transmitting a write DATA frame for the new XFER_RDY frame.

The SSP target port may reuse the value in the TARGET PORT TRANSFER TAG field from the previous XFER_RDY frame after it receives a write DATA frame for the new XFER_RDY frame.

An SSP target port retransmits each XFER_RDY frame that does not receive an ACK at least one time.

9.2.4.4.3 XFER_RDY frame with transport layer retries disabled

If an SSP target port transmits an XFER_RDY frame and receives a NAK for that frame:

- 1) the device server calls Send Command Complete () to return CHECK CONDITION status for that command with the sense key set to ABORTED COMMAND and the additional sense code set to NAK RECEIVED (see 10.2.3); and
- 2) the SSP target port transmits the RESPONSE frame in the same or a new connection.

If an SSP target port transmits an XFER_RDY frame and does not receive an ACK or NAK for that frame (e.g., times out, or the connection is broken):

- 1) the SSP_TF state machine closes the connection with DONE (ACK/NAK TIMEOUT) (see 7.16.8.6.5);
- 2) the device server calls Send Command Complete () to return CHECK CONDITION status for that command with the sense key set to ABORTED COMMAND and the additional sense code set to ACK/NAK TIMEOUT (see 10.2.3); and
- 3) the SSP target port transmits the RESPONSE frame in a new connection.

Date: 6/30/2008 6:16:52 PM

T ACCEPT - DONE

the
s/b
then the

● Author: stx-goulder

Subject: Highlight

Date: 6/20/2008 8:31:23 PM

T ACCEPT - DONE (Added:

"The number of times an SSP target port retransmits each XFER_RDY frame is vendor-specific. When it reaches its vendor-specific limit, it follows the procedure for transport layer retries disabled described in 9.2.4.4.3."

6/18 for XFER_RDY, describe the CHECK CONDITION)

at least one time.

There should be discussion of action to take when retries are exhausted and transfer is still unsuccessful.

● Author: RElliott

Subject: Highlight

Date: 6/30/2008 6:16:52 PM

T ACCEPT - DONE

ACK
s/b
ACK or NAK

● Author: RElliott

Subject: Highlight

Date: 6/30/2008 6:16:52 PM

T ACCEPT - DONE

:
s/b
, then:

● Author: RElliott

Subject: Highlight

Date: 6/30/2008 6:16:52 PM

T ACCEPT - DONE

:
s/b
, then:

9.2.4.5 DATA frame handling of link layer errors

9.2.4.5.1 DATA frame overview

If an SSP target port transmits a read DATA frame for a command with transport layer retries enabled, then the SSP target port processes link layer errors that occur while transmitting read DATA frames as described in 9.2.4.5.2.

If an SSP target port transmits a read DATA frame for a command with transport layer retries disabled, then the SSP target port processes link layer errors that occur while transmitting read DATA frames as described in 9.2.4.5.3.

An SSP initiator port processes link layer errors that occur while transmitting write DATA frames transmitted in response to an XFER_RDY frame that has its RETRY DATA FRAMES bit set to one as described in 9.2.4.5.2.

An SSP initiator port processes link layer errors that occur while transmitting write DATA frames in response to an XFER_RDY frame that has its RETRY DATA FRAMES bit set to zero as described in 9.2.4.5.3.

9.2.4.5.2 DATA frame with transport layer retries enabled

If an SSP target port transmits a read DATA frame and receives a NAK for that frame, then the read DATA frame was not received. The SSP target port retransmits, in the same or in a new connection, all the read DATA frames since a previous time when ACK/NAK balance occurred (see 9.2.6.3.3.4).

If an SSP target port transmits a read DATA frame and does not receive an ACK or NAK for that frame (e.g., times out, or the connection is broken):

- 1) the SSP_TF state machine closes the connection with DONE (ACK/NAK TIMEOUT) (see 7.16.8.6.5); and
- 2) the ST_TTS state machine retransmits, in a new connection, all the read DATA frames since a previous time when ACK/NAK balance occurred (see 9.2.6.3.3.4).

If an SSP initiator port transmits a write DATA frame and receives a NAK for that frame, then the write DATA frame was not received. The SSP_ITS state machine retransmits, in the same or in a new connection, all the write DATA frames for the previous XFER_RDY frame (see 9.2.6.2.3.3.2).

If an SSP initiator port transmits a write DATA frame and does not receive an ACK or NAK for that frame (e.g., times out, or the connection is broken):

- 1) the SSP_TF state machine closes the connection with DONE (ACK/NAK TIMEOUT) (see 7.16.8.6.5); and
- 2) the ST_ITS state machine retransmits, in a new connection, all the write DATA frames for the previous XFER_RDY frame (see 9.2.6.2.3.3.2).

If that SSP initiator port receives a new XFER_RDY frame or a RESPONSE frame for the command while retransmitting or preparing to retransmit the write DATA frames, the ST_IFR state machine and ST_ITS state machine process the XFER_RDY frame or RESPONSE frame and stop retransmitting the write DATA frames (see 9.2.6.2.2 and 9.2.6.2.3). The ST_ITS state machine does not transmit a write DATA frame for the previous XFER_RDY frame after transmitting a write DATA frame in response to the new XFER_RDY frame.

For both reads and writes, the CHANGING DATA POINTER bit is set to one in the first retransmitted DATA frame and the CHANGING DATA POINTER bit is set to zero in subsequent DATA frames.

The ST_ITS state machine and ST_TTS state machine retransmit each DATA frame that does not receive an ACK at least one time (see 9.2.6.2.3 and 9.2.6.3.3). The number of times they retransmit each DATA frame is vendor-specific.

9.2.4.5.3 DATA frame with transport layer retries disabled

If an SSP target port transmits a read DATA frame and receives a NAK for that frame:

- 1) the device server calls Send Command Complete () to return CHECK CONDITION status for that command with the sense key set to ABORTED COMMAND and the additional sense code set to NAK RECEIVED (see 10.2.3); and

Page: 460

● Author: RElliott
Subject: Note
Date: 6/30/2008 6:16:52 PM
 ACCEPT - DONE

Split 9.2.4.5 DATA frame - handling of link layers

into two sections:
9.2.4.5 Read DATA frame
9.2.4.6 Write DATA frame

This isolates the target port and initiator port rules

● Author: wdc-mevans
Subject: Highlight
Date: 6/27/2008 5:05:56 PM
 ACCEPT - DONE

frames since
s/b
frames for that I_T_L_Q nexus since

● Author: RElliott
Subject: Highlight
Date: 6/30/2008 6:16:52 PM
 ACCEPT - DONE

:
s/b
, then:

● Author: wdc-mevans
Subject: Highlight
Date: 6/27/2008 5:06:19 PM
 ACCEPT - DONE

frames since
s/b
frames for that I_T_L_Q nexus since

● Author: stx-ghoulder
Subject: Highlight
Date: 6/20/2008 8:34:53 PM
 ACCEPT - DONE (Added "at least one time" and added at the end of the section:
"When they reach their vendor-specific limit, they follow the procedure for transport layer retries disabled described in 9.2.4.5.3.")

retransmits, in a new connection, all the read DATA frames
This description doesn't indicate what should happen when it does give up on retries.

● Author: RElliott
Subject: Highlight
Date: 6/30/2008 6:16:52 PM
 ACCEPT - DONE

:
s/b
, then:



9.2.4.5 DATA frame - handling of link layer errors

9.2.4.5.1 DATA frame overview

If an SSP target port transmits a read DATA frame for a command with transport layer retries enabled, then the SSP target port processes link layer errors that occur while transmitting read DATA frames as described in 9.2.4.5.2.

If an SSP target port transmits a read DATA frame for a command with transport layer retries disabled, then the SSP target port processes link layer errors that occur while transmitting read DATA frames as described in 9.2.4.5.3.

An SSP initiator port processes link layer errors that occur while transmitting write DATA frames transmitted in response to an XFER_RDY frame that has its RETRY DATA FRAMES bit set to one as described in 9.2.4.5.2.

An SSP initiator port processes link layer errors that occur while transmitting write DATA frames in response to an XFER_RDY frame that has its RETRY DATA FRAMES bit set to zero as described in 9.2.4.5.3.

9.2.4.5.2 DATA frame with transport layer retries enabled

If an SSP target port transmits a read DATA frame and receives a NAK for that frame, then the read DATA frame was not received. The SSP target port retransmits, in the same or in a new connection, all the read DATA frames since a previous time when ACK/NAK balance occurred (see 9.2.6.3.3.4).

If an SSP target port transmits a read DATA frame and does not receive an ACK or NAK for that frame (e.g., times out, or the connection is broken):

- 1) the SSP_TF state machine closes the connection with DONE (ACK/NAK TIMEOUT) (see 7.16.8/6.5); and
- 2) the ST_TTS state machine retransmits, in a new connection, all the read DATA frames since a previous time when ACK/NAK balance occurred (see 9.2.6.3.3.4).

If an SSP initiator port transmits a write DATA frame and receives a NAK for that frame, then the write DATA frame was not received. The SSP_ITS state machine retransmits, in the same or in a new connection, all the write DATA frames for the previous XFER_RDY frame (see 9.2.6.2.3.3.2).

If an SSP initiator port transmits a write DATA frame and does not receive an ACK or NAK for that frame (e.g., times out, or the connection is broken):

- 1) the SSP_TF state machine closes the connection with DONE (ACK/NAK TIMEOUT) (see 7.16.8/6.5); and
- 2) the ST_ITS state machine retransmits, in a new connection, all the write DATA frames for the previous XFER_RDY frame (see 9.2.6.2.3.3.2).

If that SSP initiator port receives a new XFER_RDY frame or a RESPONSE frame for the command while retransmitting or preparing to retransmit the write DATA frames, the ST_IFR state machine and ST_ITS state machine process the XFER_RDY frame or RESPONSE frame and stop retransmitting the write DATA frames (see 9.2.6.2.2 and 9.2.6.2.3). The ST_ITS state machine does not transmit a write DATA frame for the previous XFER_RDY frame after transmitting a write DATA frame in response to the new XFER_RDY frame.

For both reads and writes, the CHANGING DATA POINTER bit is set to one in the first retransmitted DATA frame and the CHANGING DATA POINTER bit is set to zero in subsequent DATA frames.

The ST_ITS state machine and ST_TTS state machine retransmit each DATA frame that does not receive an ACK at least one time (see 9.2.6.2.3 and 9.2.6.3.3). The number of times they retransmit each DATA frame is vendor-specific.

9.2.4.5.3 DATA frame with transport layer retries disabled

If an SSP target port transmits a read DATA frame and receives a NAK for that frame:

- 1) the device server calls Send Command Complete () to return CHECK CONDITION status for that command with the sense key set to ABORTED COMMAND and the additional sense code set to NAK RECEIVED (see 10.2.3); and

● Author: stx-goulder

Subject: Highlight

Date: 6/20/2008 8:35:13 PM

T ACCEPT - DONE (Added "at least one time" and added text at the end of the section - see earlier comment)

retransmits, in a new connection, all the write DATA frames

This case also doesn't indicate action when all retries are exhausted.

● Author: lsi-gpenokie

Subject: Highlight

Date: 5/23/2008 2:21:59 PM

T ACCEPT - DONE (but did not add an extra space before write)

This

<< write DATA frames, the ST_IFR state >> should be

<< write DATA frames, then the ST_IFR state >>

● Author: RElliott

Subject: Highlight

Date: 6/30/2008 6:16:52 PM

T ACCEPT - DONE

:

s/b

, then:

- 2) the SSP target port transmits the RESPONSE frame in the same or a new connection.

If an SSP target port transmits a read DATA frame and does not receive an ACK or NAK for that frame (e.g., times out, or the connection is broken):

- 1) the SSP_TF state machine closes the connection with DONE (ACK/NAK TIMEOUT) (see 7.16.8.6.5);
- 2) the device server calls Send Command Complete () to return CHECK CONDITION status for that command with the sense key set to ABORTED COMMAND and the additional sense code set to ACK/NAK TIMEOUT (see 10.2.3); and
- 3) the SSP target port transmits the RESPONSE frame in a new connection.

If an SSP initiator port transmits a write DATA frame and does not receive an ACK or NAK for that frame (e.g., times out, or the connection is broken):

- 1) the SSP_TF state machine closes the connection with DONE (ACK/NAK TIMEOUT) (see 7.16.8.6.5); and
- 2) the application client aborts the command (see 10.2.2).

If an SSP initiator port transmits a write DATA frame and receives a NAK for that frame, the application client aborts the command (see 10.2.2).

9.2.4.6 RESPONSE frame - handling of link layer errors

If an SSP target port transmits a RESPONSE frame and receives a NAK for that frame, the SSP target port retransmits, in the same or a new connection, the RESPONSE frame at least one time with the RETRANSMIT bit set to one and with the other fields set to the same values as in the original RESPONSE frame (see 9.2.6.3.3.3).

If an SSP target port transmits a RESPONSE frame and does not receive an ACK or NAK for that frame (e.g., times out, or the connection is broken):

- 1) the SSP_TF state machine closes the connection with DONE (ACK/NAK TIMEOUT) (see 7.16.8.6.5); and
- 2) the SSP target port retransmits, in a new connection, the RESPONSE frame with:
 - A) the RETRANSMIT bit set to one; and
 - B) the other fields set to the same values as in the original RESPONSE frame (see 9.2.6.3.3.3).

The ST_TTS state machine retransmits each RESPONSE frame that does not receive an ACK at least one time (see 9.2.6.3.3). The number of times it retransmits each RESPONSE frame is vendor-specific.

If an SSP initiator port receives a RESPONSE frame with a RETRANSMIT bit set to one, and it has previously received a RESPONSE frame for the same I_T_L_Q nexus, the ST_IFR state machine discards the extra RESPONSE frame (see 9.2.6.3.2). If the ST_IFR state machine has not previously received a RESPONSE frame for the I_T_L_Q nexus, then it considers the RESPONSE frame to be the valid RESPONSE frame.

9.2.5 SSP transport layer error handling summary

9.2.5.1 SSP transport layer error handling summary introduction

This subclause contains a summary of how SSP ports process transport layer errors. This summary does not include every error case. See 9.2.4 for transport layer handling of link layer errors (e.g., using transport layer retries).

9.2.5.2 SSP initiator port transport layer error handling summary

If an SSP initiator port receives a COMMAND or TASK frame or an unsupported frame type, the ST_IFR state machine discards the frame (see 9.2.6.2.2.3).

If an SSP initiator port receives an XFER_RDY, read DATA, or RESPONSE frame with an unknown TAG field value, the ST_IFR state machine discards the frame (see 9.2.6.2.2.3). The application client may then abort the command with that tag.

If an SSP initiator port receives an XFER_RDY frame that is not 12 bytes long, the ST_IFR state machine discards the frame (see 9.2.6.2.2.3). The application client may then abort the command.



● Author: RElliott
Subject: Highlight
Date: 6/30/2008 6:16:52 PM
T ACCEPT - DONE

:
s/b
, then:

● Author: RElliott
Subject: Highlight
Date: 6/30/2008 6:16:52 PM
T ACCEPT - DONE

:
s/b
, then:

● Author: RElliott
Subject: Highlight
Date: 6/30/2008 6:16:52 PM
T ACCEPT - DONE
the
s/b
then the

● Author: RElliott
Subject: Highlight
Date: 6/30/2008 6:16:52 PM
T ACCEPT - DONE
the
s/b
then the

● Author: RElliott
Subject: Highlight
Date: 6/30/2008 6:16:52 PM
T ACCEPT - DONE
:
s/b
, then:

● Author: wdc-mevans
Subject: Highlight
Date: 6/27/2008 5:07:40 PM
T ACCEPT - DONE (as "an SSP target port" which matches all the other similar sentences)
it
s/b
state machine

● Author: stx-ghoulder
Subject: Highlight
Date: 7/14/2008 5:47:59 PM
T REJECT (7/14 don't change anything now. Maybe SAS-2.1 and SAM-5.

6/18 04-072 proposed creating a unit attention condition and logging the lost status in a log page, but that did not get a good

- 2) the SSP target port transmits the RESPONSE frame in the same or a new connection.

If an SSP target port transmits a read DATA frame and does not receive an ACK or NAK for that frame (e.g., times out, or the connection is broken):

- 1) the SSP_TF state machine closes the connection with DONE (ACK/NAK TIMEOUT) (see 7.16.8.6.5);
- 2) the device server calls Send Command Complete () to return CHECK CONDITION status for that command with the sense key set to ABORTED COMMAND and the additional sense code set to ACK/NAK TIMEOUT (see 10.2.3); and
- 3) the SSP target port transmits the RESPONSE frame in a new connection.

If an SSP initiator port transmits a write DATA frame and does not receive an ACK or NAK for that frame (e.g., times out, or the connection is broken):

- 1) the SSP_TF state machine closes the connection with DONE (ACK/NAK TIMEOUT) (see 7.16.8.6.5); and
- 2) the application client aborts the command (see 10.2.2).

If an SSP initiator port transmits a write DATA frame and receives a NAK for that frame, the application client aborts the command (see 10.2.2).

9.2.4.6 RESPONSE frame - handling of link layer errors

If an SSP target port transmits a RESPONSE frame and receives a NAK for that frame, the SSP target port retransmits, in the same or a new connection, the RESPONSE frame at least one time with the RETRANSMIT bit set to one and with the other fields set to the same values as in the original RESPONSE frame (see 9.2.6.3.3.3).

If an SSP target port transmits a RESPONSE frame and does not receive an ACK or NAK for that frame (e.g., times out, or the connection is broken):

- 1) the SSP_TF state machine closes the connection with DONE (ACK/NAK TIMEOUT) (see 7.16.8.6.5); and
- 2) the SSP target port retransmits, in a new connection, the RESPONSE frame with:
 - A) the RETRANSMIT bit set to one; and
 - B) the other fields set to the same values as in the original RESPONSE frame (see 9.2.6.3.3.3).

The ST_TTS state machine retransmits each RESPONSE frame that does not receive an ACK at least one time (see 9.2.6.3.3). The number of times it retransmits each RESPONSE frame is vendor-specific.

If an SSP initiator port receives a RESPONSE frame with a RETRANSMIT bit set to one, and it has previously received a RESPONSE frame for the same I_T_L_Q nexus, the ST_IFR state machine discards the extra RESPONSE frame (see 9.2.6.3.2). If the ST_IFR state machine has not previously received a RESPONSE frame for the I_T_L_Q nexus, then it considers the RESPONSE frame to be the valid RESPONSE frame.

9.2.5 SSP transport layer error handling summary

9.2.5.1 SSP transport layer error handling summary introduction

This subclause contains a summary of how SSP ports process transport layer errors. This summary does not include every error case. See 9.2.4 for transport layer handling of link layer errors (e.g., using transport layer retries).

9.2.5.2 SSP initiator port transport layer error handling summary

If an SSP initiator port receives a COMMAND or TASK frame or an unsupported frame type, the ST_IFR state machine discards the frame (see 9.2.6.2.2.3).

If an SSP initiator port receives an XFER_RDY, read DATA, or RESPONSE frame with an unknown TAG field value, the ST_IFR state machine discards the frame (see 9.2.6.2.2.3). The application client may then abort the command with that tag.

If an SSP initiator port receives an XFER_RDY frame that is not 12 bytes long, the ST_IFR state machine discards the frame (see 9.2.6.2.2.3). The application client may then abort the command.



reception at the time. I_T nexus loss might be appropriate; it would wipe out all other commands (which are probably having problems as well). This is a SAM level issue, not just a SAS issue.)

The number of times it retransmits each RESPONSE frame is vendor-specific.

There should be discussion of what the target does if all retransmissions also fail (i.e., NAK or ACK/NAK TIMEOUT occurs).

● Author: wdc-mevans
Subject: Highlight
Date: 5/26/2008 11:27:35 AM
 REJECT (first noun/subject convention)

it
s/b
the initiator port

● Author: wdc-mevans
Subject: Highlight
Date: 5/23/2008 2:23:34 PM
 ACCEPT - DONE

nexus, the
s/b
nexus, then the

● Author: wdc-mevans
Subject: Highlight
Date: 6/20/2008 9:01:59 PM
 ACCEPT - DONE (but kept the "it")

it considers the RESPONSE frame to be the valid RESPONSE frame.
s/b
the state machine processes the RESPONSE frame.

● Author: RElliott
Subject: Highlight
Date: 8/31/2008 5:00:52 PM
 ACCEPT - DONE

XFER_RDY frame that is not 12 bytes long
s/b
XFER_RDY frame _with a Transfer Ready information unit_ that is not 12 bytes long

The frame header is 24 bytes alone.

● Author: Isi-gpenokie
Subject: Sticky Note
Date: 5/23/2008 2:25:52 PM
 ACCEPT - DONE

Put << then >> in all the if statement in 9.2.5.2. SSP initiator port transport layer error handling summary and 9.2.5.3 SSP target port transport layer error handling summary

If an SSP initiator port receives an XFER_RDY frame in response to a command with no write data, the ST_IFR state machine discards the frame (see 9.2.6.2.2.3) and the application client aborts the command (see 10.2.2).

If an SSP initiator port receives an XFER_RDY frame requesting more write data than expected, the ST_ITS state machine discards the frame (see 9.2.6.2.3.3) and the application client aborts the command (see 10.2.2).

If an SSP initiator port receives an XFER_RDY frame requesting zero bytes, the ST_ITS state machine discards the frame (see 9.2.6.2.3.3) and the application client aborts the command (see 10.2.2).

If transport layer retries are disabled and an SSP initiator port receives an XFER_RDY frame with a requested offset that was not expected, the ST_ITS state machine discards the frame (see 9.2.6.2.3.3) and the application client aborts the command (see 10.2.2).

If an SSP initiator port receives a read DATA frame in response to a command with no read data, the ST_IFR state machine discards the frame (see 9.2.6.2.2.3) and the application client aborts the command (see 10.2.2).

If an SSP initiator port receives a read DATA frame with more read data than expected, the ST_ITS state machine discards the frame (see 9.2.6.2.3.3) and the application client aborts the command (see 10.2.2). The SSP initiator port may receive a RESPONSE for the command before being able to abort the command.

If an SSP initiator port receives a read DATA frame with zero bytes, the ST_ITS state machine discards the frame (see 9.2.6.2.3.3) and the application client aborts the command (see 10.2.2). The SSP initiator port may receive a RESPONSE for the command before being able to abort the command.

If transport layer retries are disabled and an SSP initiator port receives a read DATA frame with a data offset that was not expected, the ST_ITS state machine discards that frame and any subsequent read DATA frames received for that command (see 9.2.6.2.3.7) and the application client aborts the command (see 10.2.2). The SSP initiator port may receive a RESPONSE for the command before being able to abort the command.

If an SSP initiator port receives a RESPONSE frame that is not the correct length, the ST_IFR state machine considers the command or task management function completed with an error and discards the frame (see 9.2.6.2.2.3).

9.2.5.3 SSP target port transport layer error handling summary

If an SSP target port receives an XFER_RDY or RESPONSE frame or another unsupported frame type, the ST_TFR state machine discards the frame (see 9.2.6.3.2.2).

If an SSP target port receives a COMMAND frame and:

- a) the frame is too short to contain a LOGICAL UNIT NUMBER field;
- b) the frame is too short to contain a CDB; or
- c) the ADDITIONAL CDB LENGTH field specifies that the frame should be a different length,

then the ST_TTS state machine returns a RESPONSE frame with the DATAPRES field set to RESPONSE_DATA and the RESPONSE CODE field set to INVALID FRAME (see 9.2.6.3.2.2).

If an SSP target port receives a TASK frame that is too short, the ST_TTS state machine returns a RESPONSE frame with the DATAPRES field set to RESPONSE_DATA and the RESPONSE CODE field set to INVALID FRAME (see 9.2.6.3.2.2).

If an SSP target port receives a COMMAND frame with a tag that is already in use for another command, the device server may return CHECK CONDITION status with the sense key set to ABORTED COMMAND and the additional sense code set to OVERLAPPED COMMANDS ATTEMPTED (see 10.2.3).

If an SSP target port receives:

- a) a COMMAND frame with a tag that is already in use for a task management function; or
- b) a TASK frame with a tag that is already in use for a command or another task management function,

then the task router and task manager(s) return a RESPONSE frame with the RESPONSE CODE field set to OVERLAPPED TAG ATTEMPTED (see 10.2.4).

Page: 462

Author: RElliott
Subject: Highlight
Date: 6/30/2008 6:16:52 PM
T ACCEPT - DONE

and
s/b
, and

to match wdc-mevans comment on next paragraph

Author: wdc-mevans
Subject: Highlight
Date: 5/23/2008 2:26:06 PM
T REJECT (2 things ANDED)

disabled and
s/b
disabled, and

Author: wdc-mevans
Subject: Highlight
Date: 5/26/2008 11:28:41 AM
T ACCEPT - DONE

9.2.6.2.3.3) and
s/b
9.2.6.2.3.3), and

Author: wdc-mevans
Subject: Highlight
Date: 5/23/2008 2:26:15 PM
T ACCEPT - DONE

expected, the
s/b
expected, then the

Author: wdc-mevans
Subject: Highlight
Date: 5/26/2008 11:29:43 AM
T ACCEPT - DONE

(see 9.2.6.2.2.3) and
s/b
(see 9.2.6.2.2.3), and

Author: wdc-mevans
Subject: Highlight
Date: 5/26/2008 11:29:49 AM
T ACCEPT - DONE

(see 9.2.6.2.2.3) and
s/b
(see 9.2.6.2.2.3), and

Author: wdc-mevans
Subject: Highlight
Date: 5/26/2008 11:29:56 AM
T ACCEPT - DONE

(see 9.2.6.2.2.3) and
s/b

Comments from page 462 continued on next page

If an SSP initiator port receives an XFER_RDY frame in response to a command with no write data, the ST_IFR state machine discards the frame (see 9.2.6.2.2.3) and the application client aborts the command (see 10.2.2).

If an SSP initiator port receives an XFER_RDY frame requesting more write data than expected, the ST_ITS state machine discards the frame (see 9.2.6.2.3.3) and the application client aborts the command (see 10.2.2).

If an SSP initiator port receives an XFER_RDY frame requesting zero bytes, the ST_ITS state machine discards the frame (see 9.2.6.2.3.3) and the application client aborts the command (see 10.2.2).

If transport layer retries are disabled and an SSP initiator port receives an XFER_RDY frame with a requested offset that was not expected, the ST_ITS state machine discards the frame (see 9.2.6.2.3.3) and the application client aborts the command (see 10.2.2).

If an SSP initiator port receives a read DATA frame in response to a command with no read data, the ST_IFR state machine discards the frame (see 9.2.6.2.2.3) and the application client aborts the command (see 10.2.2).

If an SSP initiator port receives a read DATA frame with more read data than expected, the ST_ITS state machine discards the frame (see 9.2.6.2.3.3) and the application client aborts the command (see 10.2.2). The SSP initiator port may receive a RESPONSE for the command before being able to abort the command.

If an SSP initiator port receives a read DATA frame with zero bytes, the ST_ITS state machine discards the frame (see 9.2.6.2.3.3) and the application client aborts the command (see 10.2.2). The SSP initiator port may receive a RESPONSE for the command before being able to abort the command.

If transport layer retries are disabled and an SSP initiator port receives a read DATA frame with a data offset that was not expected, the ST_ITS state machine discards that frame and any subsequent read DATA frames received for that command (see 9.2.6.2.3.7) and the application client aborts the command (see 10.2.2). The SSP initiator port may receive a RESPONSE for the command before being able to abort the command.

If an SSP initiator port receives a RESPONSE frame that is not the correct length, the ST_IFR state machine considers the command or task management function completed with an error and discards the frame (see 9.2.6.2.2.3).

9.2.5.3 SSP target port transport layer error handling summary

If an SSP target port receives an XFER_RDY or RESPONSE frame or another unsupported frame type, the ST_TFR state machine discards the frame (see 9.2.6.3.2.2).

If an SSP target port receives a COMMAND frame and:

- a) the frame is too short to contain a LOGICAL UNIT NUMBER field;
- b) the frame is too short to contain a CDB; or
- c) the ADDITIONAL CDB LENGTH field specifies that the frame should be a different length,

then the ST_TTS state machine returns a RESPONSE frame with the DATAPRES field set to RESPONSE_DATA and the RESPONSE CODE field set to INVALID FRAME (see 9.2.6.3.2.2).

If an SSP target port receives a TASK frame that is too short, the ST_TTS state machine returns a RESPONSE frame with the DATAPRES field set to RESPONSE_DATA and the RESPONSE CODE field set to INVALID FRAME (see 9.2.6.3.2.2).

If an SSP target port receives a COMMAND frame with a tag that is already in use for another command, the device server may return CHECK CONDITION status with the sense key set to ABORTED COMMAND and the additional sense code set to OVERLAPPED COMMANDS ATTEMPTED (see 10.2.3).

If an SSP target port receives:

- a) a COMMAND frame with a tag that is already in use for a task management function; or
- b) a TASK frame with a tag that is already in use for a command or another task management function,

then the task router and task manager(s) return a RESPONSE frame with the RESPONSE CODE field set to OVERLAPPED TAG ATTEMPTED (see 10.2.4).

(see 9.2.6.2.2.3), and

● Author: wdc-mevans
Subject: Highlight
Date: 5/26/2008 11:30:15 AM
 REJECT (2 things being ANDed)

disabled and
s/b
disabled, and

● Author: wdc-mevans
Subject: Highlight
Date: 5/26/2008 11:30:37 AM
 ACCEPT - DONE

expected, the
s/b
expected, then the

● Author: wdc-mevans
Subject: Highlight
Date: 5/26/2008 11:30:03 AM
 ACCEPT - DONE

(see 9.2.6.2.3.7) and
s/b
(see 9.2.6.2.3.7), and

● Author: RElliott
Subject: Note
Date: 6/30/2008 6:16:52 PM
 ACCEPT - DONE

Add:
d) the tlr control field is set to a non-zero value and non-zero values are not supported,

to match response to elx-bmartin comment in the COMMAND frame section TLR CONTROL field paragraphs

● Author: RElliott
Subject: Highlight
Date: 6/30/2008 6:16:52 PM
 ACCEPT - DONE

device server
s/b
task router or task manager

In SAM-4, the task router/task manager do this, not a device server

● Author: wdc-mevans
Subject: Highlight
Date: 6/27/2008 5:25:15 PM
 REJECT (This is the wording used in 10.2.4. Although "or" is more correct for describing who returns CHECK CONDITION status, "and" wording used in that section is more correct for who must abort commands and TMFs.)

task router and task manager(s)
s/b
task router or one of the task managers

If an SSP target port receives a write DATA frame with an unknown tag, the ST_TFR state machine discards the frame (see 9.2.6.3.2).

If an SSP target port receives a write DATA frame **that does not contain first burst data** and for which there is no XFER_RDY frame outstanding (i.e., it has received all requested write data), the ST_TFR state machine discards the frame (see 9.2.6.3.2.2).

If an SSP target port receives a TASK frame with an unknown logical unit number, the ST_TFR state machine returns a RESPONSE frame with the DATAPRES field set to RESPONSE_DATA and the RESPONSE CODE field set to INCORRECT LOGICAL UNIT NUMBER (see 9.2.6.3.2.2).

If an SSP target port **receives** a COMMAND frame or TASK frame with a TARGET PORT TRANSFER TAG field set to a value other than FFFFh, the ST_TFR state machine **may return** a RESPONSE frame with the DATAPRES field set to RESPONSE_DATA and the RESPONSE CODE field set to INVALID FRAME (see 9.2.6.3.2.2).

If an SSP target port is using target port transfer tags and receives a write DATA frame with an unknown target port transfer tag, the ST_TFR state machine discards the frame (see 9.2.6.3.3).

If transport layer retries are **disabled and** an SSP target port receives a write DATA frame with a data offset that was not **expected, the** ST_TTS state machine discards the frame **(see 9.2.6.3.3.6.1)** and the device server terminates the command with CHECK CONDITION status with the sense key set to ABORTED COMMAND and the additional sense code set to DATA OFFSET ERROR (see 10.2.3).

If an SSP target port receives a write DATA frame with more write data than expected (i.e., the write DATA frame contains data in excess of that requested by an XFER_RDY frame or, for first burst data, indicated by the FIRST BURST LENGTH field in the Disconnect-Reconnect mode page), the **ST_TTS state machine discards the frame (see 9.2.6.3.3.6.1)** and the device server terminates the command with CHECK CONDITION status with the sense key set to ABORTED COMMAND and the additional sense code set to TOO MUCH WRITE DATA (see 10.2.3).

If an SSP target port receives a write DATA frame with zero bytes, the ST_TTS state machine discards the frame **(see 9.2.6.3.3.6.1)** and the device server terminates the command with CHECK CONDITION status with the sense key set to ABORTED COMMAND and the additional sense code set to INFORMATION UNIT TOO SHORT (see 10.2.3).

9.2.6 ST (transport layer for SSP ports) state machines

9.2.6.1 ST state machines overview

The ST state machines perform the following functions:

- a) receive and process transport protocol service requests and transport protocol service responses from the SCSI application layer;
- b) receive and process other SAS connection management requests from the **application layer**;
- c) send transport protocol service indications and transport protocol service confirmations to the SCSI application layer;
- d) send requests to the port layer to transmit frames and manage SAS connections; and
- e) receive confirmations from the port layer.

The following confirmations between the ST state machines and the port layer:

- a) Transmission Status; and
- b) Frame Received;

include the following as arguments:

- a) **tag**;
- b) destination SAS address; and
- c) source SAS address;

and are used to route the confirmations to the correct ST state machines.

NOTE 88 - Although allowed by this standard, the ST state machines do not handle bidirectional commands that result in concurrent write DATA frames and read DATA frames.

Page: 463

Author: stx-goulder

Subject: Highlight

Date: 6/20/2008 9:12:24 PM

TREJECT ("when" is used to describe a point in time. First burst data is not "not permitted" at any particular point in time. It might be considered to start being "not permitted" after all the first burst data has been received. The suggested "e.g." has the wrong scope - this paragraph covers both the case of first burst disabled and the case of first burst data having already been received. The current wording is correct.)

that does not contain first burst data

replace with: "when first burst data is not permitted (e.g., ENABLE FIRST BURST is set to zero in the command frame)"

Author: stx-goulder

Subject: Highlight

Date: 6/20/2008 9:13:45 PM

TREJECT ("requested write data" is only requested by an XFER_RDY frame. If any has not arrived, that XFER_RDY is still considered outstanding.)

(i.e.

should be "e.g.". Another case is the target may not have received all the requested data but doesn't have and XFER_RDY frame outstanding.

Author: stx-goulder

Subject: Highlight

Date: 6/27/2008 5:26:56 PM

TREJECT (The Target Port Transfer Tag field is never valid in a COMMAND or TASK frame. Whether or not the target uses target port transfer tags is irrelevant.)

receives

replace with: "is not using target port transfer tags and receives".

Author: stx-goulder

Subject: Highlight

Date: 6/27/2008 5:28:58 PM

TREJECT (no, the state machine clearly makes this a "may." For COMMAND and TASK frames, it's like a reserved field, and reserved field checking is optional.)

may return

should be "returns".

Author: wdc-mevans

Subject: Highlight

Date: 5/23/2008 2:26:48 PM

TREJECT (2 things ANDED)
disabled and

s/b

disabled, and

Author: wdc-mevans

Subject: Highlight

Date: 5/26/2008 11:32:14 AM

TACCEPT - DONE

(see 9.2.6.3.3.6.1) and

s/b

(see 9.2.6.3.3.6.1), and

Author: wdc-mevans

Subject: Highlight

Date: 5/27/2008 9:07:48 PM

TACCEPT - DONE

Comments from page 463 continued on next page

If an SSP target port receives a write DATA frame with an unknown tag, the ST_TFR state machine discards the frame (see 9.2.6.3.2).

If an SSP target port receives a write DATA frame **that does not contain first burst data** and for which there is no XFER_RDY frame outstanding (*i.e.*, it has received all requested write data), the ST_TFR state machine discards the frame (see 9.2.6.3.2.2).

If an SSP target port receives a TASK frame with an unknown logical unit number, the ST_TFR state machine returns a RESPONSE frame with the DATAPRES field set to RESPONSE_DATA and the RESPONSE CODE field set to INCORRECT LOGICAL UNIT NUMBER (see 9.2.6.3.2.2).

If an SSP target port **receives** a COMMAND frame or TASK frame with a TARGET PORT TRANSFER TAG field set to a value other than FFFFh, the ST_TFR state machine **may return** a RESPONSE frame with the DATAPRES field set to RESPONSE_DATA and the RESPONSE CODE field set to INVALID FRAME (see 9.2.6.3.2.2).

If an SSP target port is using target port transfer tags and receives a write DATA frame with an unknown target port transfer tag, the ST_TFR state machine discards the frame (see 9.2.6.3.3).

If transport layer retries are **disabled and** an SSP target port receives a write DATA frame with a data offset that was not **expected, the** ST_TTS state machine discards the frame (**see 9.2.6.3.3.6.1**) and the device server terminates the command with CHECK CONDITION status with the sense key set to ABORTED COMMAND and the additional sense code set to DATA OFFSET ERROR (see 10.2.3).

If an SSP target port receives a write DATA frame with more write data than expected (*i.e.*, the write DATA frame contains data in excess of that requested by an XFER_RDY frame or, for first burst data, indicated by the FIRST BURST LENGTH field in the Disconnect-Reconnect mode page), the **ST_TTS state machine discards the frame** (**see 9.2.6.3.3.6.1**) and the device server terminates the command with CHECK CONDITION status with the sense key set to ABORTED COMMAND and the additional sense code set to TOO MUCH WRITE DATA (see 10.2.3).

If an SSP target port receives a write DATA frame with zero bytes, the ST_TTS state machine discards the frame (**see 9.2.6.3.3.6.1**) and the device server terminates the command with CHECK CONDITION status with the sense key set to ABORTED COMMAND and the additional sense code set to INFORMATION UNIT TOO SHORT (see 10.2.3).

9.2.6 ST (transport layer for SSP ports) state machines

9.2.6.1 ST state machines overview

The ST state machines perform the following functions:

- a) receive and process transport protocol service requests and transport protocol service responses from the SCSI application layer;
- b) receive and process other SAS connection management requests from the **application layer**;
- c) send transport protocol service indications and transport protocol service confirmations to the SCSI application layer;
- d) send requests to the port layer to transmit frames and manage SAS connections; and
- e) receive confirmations from the port layer.

The following confirmations between the ST state machines and the port layer:

- a) Transmission Status; and
- b) Frame Received;

include the following as arguments:

- a) **tag**;
- b) destination SAS address; and
- c) source SAS address;

and are used to route the confirmations to the correct ST state machines.

NOTE 88 - Although allowed by this standard, the ST state machines do not handle bidirectional commands that result in concurrent write DATA frames and read DATA frames.

expected, the
s/b
expected, then the

● Author: stx-goulder
Subject: Highlight
Date: 7/14/2008 8:50:16 PM

T REJECT (7/14 these are slightly different cases. If the target has not sent an XFER_RDY, the ST_TTS state machine is idle and only the ST_TFR can do anything. If first burst didn't exist to complicate things, could change "frame with more" to "frame for which there is an XFER_RDY frame outstanding with more". Defer to SAS-2.1 or later.)

ST_TTS state machine discards the frame
The ST_TFR state machine also discards frames with this type of error (see 5 paragraphs earlier). Is this an unneeded overlap in responsibility or must both machines act together to make the discard happen?

● Author: wdc-mevans
Subject: Highlight
Date: 5/26/2008 11:32:21 AM

T ACCEPT - DONE

(see 9.2.6.3.3.6.1) and
s/b
(see 9.2.6.3.3.6.1), and

● Author: wdc-mevans
Subject: Highlight
Date: 5/26/2008 11:32:27 AM

T ACCEPT - DONE

(see 9.2.6.3.3.6.1) and
s/b
(see 9.2.6.3.3.6.1), and

● Author: stx-goulder
Subject: Highlight
Date: 5/26/2008 11:32:42 AM

T ACCEPT - DONE

application layer
Should be "SCSI application layer" like items a) and c), else there is more explaining to do.

● Author: stx-goulder
Subject: Highlight
Date: 5/23/2008 2:28:33 PM

T ACCEPT - DONE (yes. changed to "initiator port transfer tag")

tag
Is this the command tag?

● Author: stx-goulder
Subject: Highlight
Date: 7/14/2008 8:52:56 PM

T REJECT (7/14 no, it just means that the committee is too lazy or lacks the ability to define state machines correctly)

NOTE 88 - Although allowed by this standard, the ST state machines do not handle bidirectional commands that result in concurrent write DATA frames and read DATA frames.
This seems like a requirement that should NOT be hidden away in a note. The statement also seems wrong -- if the ST state machines in this standard don't allow this feature, then "this standard" doesn't allow it. Is it trying to say that the feature is allowed by SAM but not by this standard?

9.2.6.2 ST_I (transport layer for SSP initiator ports) state machines

9.2.6.2.1 ST_I state machines overview

The ST_I state machines are as follows:

- a) ST_IFR (initiator frame router) state machine (see 9.2.6.2.2); and
- b) ST_ITS (initiator transport server) state machine (see 9.2.6.2.3).

The SAS initiator port includes:

- a) one ST_IFR state machine; and
- b) one ST_ITS state machine for each possible task and task management function (i.e., for each tag).

● Author: wdc-mevans
Subject: Highlight
Date: 6/27/2008 5:30:06 PM
T ACCEPT - DONE

The
s/b
Each

This page contains no comments

9.2.6.2.2 ST_IFR (initiator frame router) state machine

9.2.6.2.2.1 ST_IFR state machine overview

The ST_IFR state machine performs the following functions:

- a) receives Send SCSI Command and Send Task Management transport protocol service requests from the SCSI application layer;
- b) sends messages to the ST_ITS state machine;
- c) receives messages from the ST_ITS state machine;
- d) receives confirmations from the port layer;
- e) sends transport protocol service confirmations to the SCSI application layer;
- f) receives vendor-specific requests from the SCSI application layer;
- g) sends vendor-specific confirmations to the SCSI application layer;
- h) receives Accept_Reject OPENs requests from the SCSI application layer;
- i) sends Accept_Reject OPENs requests to the port layer;
- j) sends L_T Nexus Loss event notifications to the SCSI application layer; and
- k) sends Transport Reset event notifications to the SCSI application layer.

This state machine consists of one state.

This state machine shall be started after power on.

9.2.6.2.2.2 Processing transport protocol service requests

If this state machine receives a Send SCSI Command transport protocol service request then this state machine shall send a Request (Send Command) message with Command arguments and Application Client Buffer arguments to the ST_ITS state machine for the specified tag.

The following is the list of Command arguments:

- a) connection rate;
- b) initiator connection tag;
- c) destination SAS address;
- d) source SAS address set to the SAS address of the SSP initiator port;
- e) tag;
- f) logical unit number;
- g) task priority;
- h) task attribute;
- i) additional CDB length;
- j) CDB;
- k) additional CDB bytes, if any;
- l) first burst enabled; and
- m) request fence.

The following is the list of Application Client Buffer arguments:

- a) data-in buffer size;
- b) data-out buffer; and
- c) data-out buffer size.

If the command is performing a write operations and the Send SCSI Command transport service request contains a First Burst Enabled argument, then the Request (Send Command) message shall also include the Enable First Burst argument and the number of bytes for the First Burst Size argument.

If this state machine receives a Send Task Management Request transport protocol service request, then this state machine shall send a Request (Send Task) message with the Task arguments to the ST_ITS state machine for the specified tag.

The following is the list of Task arguments:

- a) connection rate;
- b) initiator connection tag;

Page: 466

Author: stx-goulder

Subject: Highlight

Date: 6/27/2008 5:34:51 PM

T REJECT (these are the arguments defined in SAM-4, which purposely avoids a concrete description of such things. If SAM-5 adds more, then SAS-2.1 can add them too.)

data-out buffer;

Does this mean data-out buffer address, or data-out buffer contents? Why shouldn't there also be a data-in buffer argument?

Author: wdc-mevans

Subject: Highlight

Date: 6/27/2008 5:32:28 PM

T REJECT (why saddle the basic list of arguments with that? It's not an example of anything being described in this section.)

data-out buffer size.

s/b

data-out buffer size (e.g., this value takes into account the value set in the MAXIMUM BURST SIZE field in the Disconnect-Reconnect mode page).

Author: stx-goulder

Subject: Highlight

Date: 5/26/2008 11:34:04 AM

T ACCEPT - DONE

operations

should be singular, not plural.

Author: wdc-mevans

Subject: Highlight

Date: 5/26/2008 11:33:55 AM

T ACCEPT - DONE (fixed plural, but did not add comma because 2 things are being ANDed)

operations and

s/b

operation, and

- c) source SAS address set to the SAS address of the SSP initiator port;
- d) destination SAS address;
- e) retransmit bit;
- f) tag;
- g) logical unit number;
- h) task management function;
- i) tag of task to be managed; and
- j) request fence.

If the ST_ITS state machine for the tag specified in the Send Task Management Request is currently in use, then this state machine shall set the retransmit bit argument to one. If the ST_ITS state machine for the tag specified in the Send Task Management Request is not currently in use, then this state machine shall set the retransmit bit argument to zero.

9.2.6.2.2.3 Processing Frame Received confirmations

If this state machine receives a Frame Received (ACK/NAK Balanced) confirmation or Frame Received (ACK/NAK Not Balanced) confirmation, then this state machine shall compare the frame type of the frame received with the received confirmation (see table 164 in 9.2.1). If the confirmation was Frame Received (ACK/NAK Balanced) and the frame type is not XFER_RDY, RESPONSE, or DATA, then this state machine shall discard the frame. If the confirmation was Frame Received (ACK/NAK Not Balanced) and the frame type is not DATA, then this state machine shall discard the frame.

If the frame type is correct relative to the Frame Received confirmation, then this state machine may check that the hashed source SAS address matches the SAS address of the SAS port that transmitted the frame and that the hashed destination SAS address matches the SAS address of the SAS port that received the frame based on the connection information. If this state machine checks these SAS addresses, and they do not match, then this state machine:

- a) shall discard the frame; and
- b) may send a vendor-specific confirmation to the SCSI application layer to cause the command using that tag to be aborted.

If the frame type is XFER_RDY then this state machine shall check the length of the information unit. If the length of the information unit is not correct, then this state machine:

- a) shall discard the frame; and
- b) may send a vendor-specific confirmation to the SCSI application layer to cause the command using that tag to be aborted.

If the frame type is XFER_RDY and the tag is for a task with no write data, then this state machine shall:

- a) discard the frame;
- b) send a Command Complete Received transport protocol service confirmation with the Delivery Result argument set to Service Delivery or Target Failure - DATA Not Expected to the SCSI application layer; and
- c) if there is an ST_ITS state machine for the tag, send a Return To Start message to that state machine.

If the frame type is DATA and the tag is for a task with no read data, then this state machine shall:

- a) discard the frame;
- b) send a Command Complete Received transport protocol service confirmation with the Delivery Result argument set to Service Delivery or Target Failure - DATA Not Expected to the SCSI application layer; and
- c) if there is an ST_ITS state machine for the tag, send a Return To Start message to that state machine.

If the frame type is RESPONSE then this state machine shall check the length of the information unit. If the length of the information unit is not correct and the RESPONSE frame was for a command, then this state shall discard the frame and send a Command Complete Received confirmation to the SCSI application layer with the Service Response argument set to Service Delivery or Target Failure. If the length of the information unit is not correct and the RESPONSE frame was for a task management function, then this state shall

Page: 467

Author: stx-ghoulder

Subject: Highlight

Date: 6/27/2008 5:37:13 PM

T REJECT (the basic check is optional - that results in discarding the frame. Aborting the tag in question is also optional. If hash values are wrong, something major is broken.)

may send a vendor-specific confirmation

This is optional? If some do it and others don't, wouldn't this cause interoperability problems?

Author: wdc-mevans

Subject: Highlight

Date: 5/26/2008 11:34:43 AM

T ACCEPT - DONE

XFER_RDY then

s/b

XFER_RDY, then

Author: RElliott

Subject: Highlight

Date: 8/30/2008 1:16:15 PM

T ACCEPT - DONE

Service Delivery or Target Failure - DATA Not Expected

DATA s/b XFER_RDY

since this is receiving an XFER_RDY frame, not a DATA frame. The application layer includes XFER_RDY Not Expected in its list, but there is no source of it.

(noticed by 08-343, but different solution than it requests)

Author: RElliott

Subject: Highlight

Date: 6/30/2008 6:16:52 PM

T ACCEPT - DONE

send

s/b

then send

Author: wdc-mevans

Subject: Highlight

Date: 5/26/2008 11:34:55 AM

T REJECT (2 things ANDED)

DATA and

s/b

DATA, and

Author: RElliott

Subject: Highlight

Date: 6/30/2008 6:16:52 PM

T ACCEPT - DONE

send

s/b

then send

Comments from page 467 continued on next page

- c) source SAS address set to the SAS address of the SSP initiator port;
- d) destination SAS address;
- e) retransmit bit;
- f) tag;
- g) logical unit number;
- h) task management function;
- i) tag of task to be managed; and
- j) request fence.

If the ST_ITS state machine for the tag specified in the Send Task Management Request is currently in use, then this state machine shall set the retransmit bit argument to one. If the ST_ITS state machine for the tag specified in the Send Task Management Request is not currently in use, then this state machine shall set the retransmit bit argument to zero.

9.2.6.2.2.3 Processing Frame Received confirmations

If this state machine receives a Frame Received (ACK/NAK Balanced) confirmation or Frame Received (ACK/NAK Not Balanced) confirmation, then this state machine shall compare the frame type of the frame received with the received confirmation (see table 164 in 9.2.1). If the confirmation was Frame Received (ACK/NAK Balanced) and the frame type is not XFER_RDY, RESPONSE, or DATA, then this state machine shall discard the frame. If the confirmation was Frame Received (ACK/NAK Not Balanced) and the frame type is not DATA, then this state machine shall discard the frame.

If the frame type is correct relative to the Frame Received confirmation, then this state machine may check that the hashed source SAS address matches the SAS address of the SAS port that transmitted the frame and that the hashed destination SAS address matches the SAS address of the SAS port that received the frame based on the connection information. If this state machine checks these SAS addresses, and they do not match, then this state machine:

- a) shall discard the frame; and
- b) may send a vendor-specific confirmation to the SCSI application layer to cause the command using that tag to be aborted.

If the frame type is XFER_RDY then this state machine shall check the length of the information unit. If the length of the information unit is not correct, then this state machine:

- a) shall discard the frame; and
- b) may send a vendor-specific confirmation to the SCSI application layer to cause the command using that tag to be aborted.

If the frame type is XFER_RDY and the tag is for a task with no write data, then this state machine shall:

- a) discard the frame;
- b) send a Command Complete Received transport protocol service confirmation with the Delivery Result argument set to Service Delivery or Target Failure - DATA Not Expected to the SCSI application layer; and
- c) if there is an ST_ITS state machine for the tag, send a Return To Start message to that state machine.

If the frame type is DATA and the tag is for a task with no read data, then this state machine shall:

- a) discard the frame;
- b) send a Command Complete Received transport protocol service confirmation with the Delivery Result argument set to Service Delivery or Target Failure - DATA Not Expected to the SCSI application layer; and
- c) if there is an ST_ITS state machine for the tag, send a Return To Start message to that state machine.

If the frame type is RESPONSE then this state machine shall check the length of the information unit. If the length of the information unit is not correct and the RESPONSE frame was for a command, then this state machine shall discard the frame and send a Command Complete Received confirmation to the SCSI application layer with the Service Response argument set to Service Delivery or Target Failure. If the length of the information unit is not correct and the RESPONSE frame was for a task management function, then this state shall

Author: wdc-mevans
Subject: Highlight
Date: 5/26/2008 11:35:14 AM
T ACCEPT - DONE

RESPONSE then
s/b
RESPONSE, then

Author: wdc-mevans
Subject: Highlight
Date: 5/23/2008 2:09:46 PM
T REJECT (2 things ANDED)

correct and
s/b
correct, and

Author: wdc-mevans
Subject: Highlight
Date: 5/23/2008 2:11:51 PM
T ACCEPT - DONE

state
s/b
state machine

Author: wdc-mevans
Subject: Highlight
Date: 5/23/2008 2:12:12 PM
T REJECT (2 things ANDED together)

correct and
s/b
correct, and

discard the frame and send a Received Task Management Function – Executed confirmation to the SCSI application layer with the Service Response argument set to Service Delivery or Target Failure.

If the frame type is correct relative to the Frame Received confirmation, then this state machine shall check the tag. If the tag does not specify a valid ST_ITS state machine, then this state machine shall discard the frame and may send a vendor-specific confirmation to the SCSI application layer to cause the command using that tag to be aborted.

If the frame type is **RESPONSE**, and ~~this state machine has received~~ a RESPONSE frame for the I_T_L_Q nexus, then this state machine shall discard the frame.

If the frame type is RESPONSE, the fields checked in the frame are correct, and this state machine **has not received** a RESPONSE frame for this I_T_L_Q nexus, then this state machine shall send a Return To Start message to the ST_ITS state machine for the specified tag and:

- a) if the RESPONSE frame was for a command, then this state machine shall send a Command Complete Received protocol service confirmation to the SCSI application layer with the arguments set as specified in table 200 (see 10.2.1.5); or
- b) if the RESPONSE frame was for a task management request, then this state machine shall send a Received Task Management Function Executed protocol service confirmation to the SCSI application layer with the arguments set as specified in table 200 (see 10.2.1.5).

If the frame type is XFER_RDY and the fields checked in the frame are correct, then this state machine shall wait to receive an ACK Transmitted confirmation.

If this state machine receives an ACK Transmitted confirmation for an XFER_RDY frame, then **this state machine** shall send an XFER_RDY Arrived message **to ST_ITS** state machine specified by the tag. The message shall include the following Xfer_Rdy arguments:

- a) retry data frames;
- b) retransmit bit;
- c) target port transfer tag;
- d) requested offset; and
- e) write data length.

If the frame type is DATA and the fields checked in the frame are correct, then this state machine shall send a Data-In Arrived message to the ST_ITS state machine specified by the tag. The message shall include the following Read Data arguments:

- a) changing data pointer;
- b) number of fill bytes;
- c) data offset; and
- d) data.

9.2.6.2.2.4 Processing Transmission Complete and Reception Complete messages

If this **state** receives a **Transmission Complete (I_T Nexus Loss)**, then **this state machine** shall send a Nexus Loss event notification to the SCSI application layer.

Page: 468

● Author: Isi-bday
Subject: Highlight
Date: 5/26/2008 11:35:36 AM
T ACCEPT - DONE

has received
suggest
has previously received

● Author: RElliott
Subject: Highlight
Date: 6/30/2008 6:16:52 PM

T ACCEPT - DONE
RESPONSE, and
s/b
RESPONSE and

● Author: Isi-bday
Subject: Highlight
Date: 5/26/2008 11:35:46 AM

T ACCEPT - DONE
has not received
suggest
has not previously received

● Author: RElliott
Subject: Highlight
Date: 6/30/2008 6:16:52 PM

T ACCEPT - DONE
this state machine
s/b
it

● Author: wdc-mevans
Subject: Highlight
Date: 5/6/2008 4:07:50 PM

T ACCEPT - DONE
to ST_ITS
s/b
to the ST_ITS

● Author: RElliott
Subject: Highlight
Date: 6/30/2008 6:16:52 PM

T ACCEPT - DONE
this state machine
s/b
it

● Author: RElliott
Subject: Highlight
Date: 8/30/2008 12:33:10 PM

T ACCEPT - DONE
Transmission Complete (I_T Nexus Loss)
add

Comments from page 468 continued on next page

discard the frame and send a Received Task Management Function – Executed confirmation to the SCSI application layer with the Service Response argument set to Service Delivery or Target Failure.

If the frame type is correct relative to the Frame Received confirmation, then this state machine shall check the tag. If the tag does not specify a valid ST_ITS state machine, then this state machine shall discard the frame and may send a vendor-specific confirmation to the SCSI application layer to cause the command using that tag to be aborted.

If the frame type is **RESPONSE**, and this state machine **has received** a RESPONSE frame for the I_T_L_Q nexus, then this state machine shall discard the frame.

If the frame type is RESPONSE, the fields checked in the frame are correct, and this state machine **has not received** a RESPONSE frame for this I_T_L_Q nexus, then this state machine shall send a Return To Start message to the ST_ITS state machine for the specified tag and:

- a) if the RESPONSE frame was for a command, then this state machine shall send a Command Complete Received protocol service confirmation to the SCSI application layer with the arguments set as specified in table 200 (see 10.2.1.5); or
- b) if the RESPONSE frame was for a task management request, then this state machine shall send a Received Task Management Function Executed protocol service confirmation to the SCSI application layer with the arguments set as specified in table 200 (see 10.2.1.5).

If the frame type is XFER_RDY and the fields checked in the frame are correct, then this state machine shall wait to receive an ACK Transmitted confirmation.

If this state machine receives an ACK Transmitted confirmation for an XFER_RDY frame, then **this state machine** shall send an XFER_RDY Arrived message to **ST_ITS** state machine specified by the tag. The message shall include the following Xfer_Rdy arguments:

- a) retry data frames;
- b) retransmit bit;
- c) target port transfer tag;
- d) requested offset; and
- e) write data length.

If the frame type is DATA and the fields checked in the frame are correct, then this state machine shall send a Data-In Arrived message to the ST_ITS state machine specified by the tag. The message shall include the following Read Data arguments:

- a) changing data pointer;
- b) number of fill bytes;
- c) data offset; and
- d) data.

9.2.6.2.2.4 Processing Transmission Complete and Reception Complete messages

If this **state** receives a **Transmission Complete (I_T Nexus Loss)**, then **this state machine** shall send a Nexus Loss event notification to the SCSI application layer.

message
per 08-343

Author: wdc-mevans
Subject: Highlight
Date: 5/23/2008 2:12:36 PM
T ACCEPT - DONE

state
s/b
state machine

Table 176 defines the transport protocol service confirmation and its argument generated as a result of receiving a Transmission Complete message or a Reception Complete message that indicate an error occurred during the transmission or reception of a frame.

Table 176 — Confirmations sent to the SCSI application layer if a frame transmission or reception error occurs

Message received from ST_ITS state machine	Protocol service confirmation and Delivery Result argument sent to the SCSI application layer
Transmission Complete (Command Failed, ACK/NAK Timeout)	Command Complete Received (Service Delivery or Target Failure - ACK/NAK Timeout)
Transmission Complete (Command Failed, NAK Received)	Command Complete Received (Service Delivery or Target Failure - NAK Received)
Transmission Complete (Command Failed, Connection Failed)	Command Complete Received (Service Delivery or Target Failure - Connection Failed)
Transmission Complete (Task Failed, ACK/NAK Timeout)	Received Task Management Function - Executed (Service Delivery or Target Failure - ACK/NAK Timeout)
Transmission Complete (Task Failed, NAK Received)	Received Task Management Function - Executed (Service Delivery or Target Failure - NAK Received)
Transmission Complete (Task Failed, Connection Failed)	Received Task Management Function - Executed (Service Delivery or Target Failure - Connection Failed)
Transmission Complete (XFER_RDY Incorrect Write Data Length)	Command Complete Received (Service Delivery or Target Failure - XFER_RDY Incorrect Write Data Length)
Transmission Complete (XFER_RDY Requested Offset Error)	Command Complete Received (Service Delivery or Target Failure - XFER_RDY Requested Offset Error)
Transmission Complete (Cancel Acknowledged)	Command Complete Received (Service Delivery or Target Failure - Cancel Acknowledged)
Reception Complete (Data Offset Error)	Command Complete Received (Service Delivery or Target Failure - DATA Offset Error)
Reception Complete (Too Much Read Data)	Command Complete Received (Service Delivery or Target Failure - DATA Too Much Read Data)
Reception Complete (Information Unit Too Short)	Command Complete Received (Service Delivery or Target Failure - DATA Information Unit Too Short)
Reception Complete (Command Failed, ACK/NAK Timeout)	Command Complete Received (Service Delivery or Target Failure - ACK/NAK Timeout)
Reception Complete (Cancel Acknowledged)	Command Complete Received (Service Delivery or Target Failure - Cancel Acknowledged)

The protocol service confirmation shall include the tag as an argument.

9.2.6.2.2.5 Processing miscellaneous requests

If this state machine receives an Accept_Reject OPENs (Accept SSP) or Accept_Reject OPENs (Reject SSP) request, then this state machine shall send a corresponding Accept_Reject OPENs request to the port layer.

If this state machine receives a HARD_RESET Received confirmation, then this state machine shall send a Transport Reset event notification to the SCSI application layer.

Page: 469

Author: RElliott
Subject: Highlight
Date: 6/30/2008 6:16:52 PM
T ACCEPT - DONE

its argument
s/b
Delivery Result argument

Author: wdc-mevans
Subject: Highlight
Date: 6/27/2008 5:39:36 PM
T REJECT (the grammar is OK; read the whole sentence)

defines the
s/b
defines each

Author: wdc-mevans
Subject: Highlight
Date: 6/27/2008 5:37:48 PM
T REJECT (see other comments on "receiving")

of receiving
s/b
of this state machine receiving

Author: wdc-mevans
Subject: Highlight
Date: 6/27/2008 5:38:21 PM
T ACCEPT - DONE

that indicate
s/b
indicating that

Author: RElliott
Subject: Highlight
Date: 8/30/2008 1:24:09 PM
T ACCEPT - DONE

Command Complete Received (Service Delivery or Target Failure - DATA Offset Error)
s/b
DATA Data Offset Error

to match app client list, and have consistent <frame type> <error name> wording

(noticed by 08-343, different solution)

Author: RElliott
Subject: Highlight
Date: 8/27/2008 7:51:50 PM
T ACCEPT - DONE

Information Unit Too Short
s/b
Incorrect Data Length

to match what ST_ITS really sends

Comments from page 469 continued on next page

Table 176 defines the transport protocol service confirmation and its argument generated as a result of receiving a Transmission Complete message or a Reception Complete message that indicate an error occurred during the transmission or reception of a frame.

Table 176 — Confirmations sent to the SCSI application layer if a frame transmission or reception error occurs

Message received from ST_ITS state machine	Protocol service confirmation and Delivery Result argument sent to the SCSI application layer
Transmission Complete (Command Failed, ACK/NAK Timeout)	Command Complete Received (Service Delivery or Target Failure - ACK/NAK Timeout)
Transmission Complete (Command Failed, NAK Received)	Command Complete Received (Service Delivery or Target Failure - NAK Received)
Transmission Complete (Command Failed, Connection Failed)	Command Complete Received (Service Delivery or Target Failure - Connection Failed)
Transmission Complete (Task Failed, ACK/NAK Timeout)	Received Task Management Function - Executed (Service Delivery or Target Failure - ACK/NAK Timeout)
Transmission Complete (Task Failed, NAK Received)	Received Task Management Function - Executed (Service Delivery or Target Failure - NAK Received)
Transmission Complete (Task Failed, Connection Failed)	Received Task Management Function - Executed (Service Delivery or Target Failure - Connection Failed)
Transmission Complete (XFER_RDY Incorrect Write Data Length)	Command Complete Received (Service Delivery or Target Failure - XFER_RDY Incorrect Write Data Length)
Transmission Complete (XFER_RDY Requested Offset Error)	Command Complete Received (Service Delivery or Target Failure - XFER_RDY Requested Offset Error)
Transmission Complete (Cancel Acknowledged)	Command Complete Received (Service Delivery or Target Failure - Cancel Acknowledged)
Reception Complete (Data Offset Error)	Command Complete Received (Service Delivery or Target Failure - DATA Offset Error)
Reception Complete (Too Much Read Data)	Command Complete Received (Service Delivery or Target Failure - DATA Too Much Read Data)
Reception Complete (Information Unit Too Short)	Command Complete Received (Service Delivery or Target Failure - DATA Information Unit Too Short)
Reception Complete (Command Failed, ACK/NAK Timeout)	Command Complete Received (Service Delivery or Target Failure - ACK/NAK Timeout)
Reception Complete (Cancel Acknowledged)	Command Complete Received (Service Delivery or Target Failure - Cancel Acknowledged)

The protocol service confirmation shall include the tag as an argument.

9.2.6.2.2.5 Processing miscellaneous requests

If this state machine receives an Accept_Reject OPENs (Accept SSP) or Accept_Reject OPENs (Reject SSP) request, then this state machine shall send a corresponding Accept_Reject OPENs request to the port layer.

If this state machine receives a HARD_RESET Received confirmation, then this state machine shall send a Transport Reset event notification to the SCSI application layer.

Author: RElliott
Subject: Highlight
Date: 8/27/2008 7:51:55 PM

T ACCEPT - DONE

Information Unit Too Short
s/b
Incorrect Data Length

to match what ST_ITS really sends

Author: RElliott
Subject: Highlight
Date: 8/30/2008 3:12:42 PM

T ACCEPT - DONE

Accept_Reject OPENS (Accept SSP) or

add request in the spirit of 08-343

This state machine may receive vendor-specific requests from the SCSI application layer that cause this state machine to send a Cancel message to an ST_ITS state machine.

9.2.6.2.3 ST_ITS (initiator transport server) state machine

9.2.6.2.3.1 ST_ITS state machine overview

The ST_ITS state machine performs the following functions:

- a) receives and processes messages from the ST_IFR state machine;
- b) sends messages to the ST_IFR state machine;
- c) sends request to the port layer regarding frame transmission;
- d) receives confirmations from the port layer regarding frame transmission; and
- e) receives HARD_RESET Received confirmations from the port layer.

This state machine consists of the following states:

- a) ST_ITS1:Initiator_Start state (see 9.2.6.2.3.2) (initial state);
- b) ST_ITS2:Initiator_Send_Frame state (see 9.2.6.2.3.3);
- c) ST_ITS3:Prepare_Command state (see 9.2.6.2.3.4);
- d) ST_ITS4:Prepare_Task state (see 9.2.6.2.3.5);
- e) ST_ITS5:Prepare_Data_Out state (see 9.2.6.2.3.6); and
- f) ST_ITS6:Receive_Data_In state (see 9.2.6.2.3.7).

This state machine shall start in the ST_ITS1:Initiator_Start state after power on.

If this state machine receives a HARD_RESET Received confirmation, then this state machine shall transition to the ST_ITS1:Initiator_Start state.

This state machine shall maintain the state machine variables defined in table 177.

Table 177 — ST_ITS state machine variables

State machine variable	Description
Data-In Buffer Offset	Current offset in the application client's data-in buffer (i.e., the application client buffer for read data)
Data-Out Buffer Offset	Current offset in the application client's data-out buffer (i.e., the application client buffer for write data)
Previous Requested Offset	Offset in the application client's data-out buffer (i.e., the application client buffer for write data) from the last XFER_RDY frame received
Previous Write Data Length	Write data length from the last XFER_RDY frame received

This page contains no comments

This state machine shall maintain the state machine arguments defined in table 178.

Table 178 — ST_ITS state machine arguments

State machine argument	Description
Command	Consists of the Command arguments received in the Request (Send Command) message
Task	Consists of the arguments received in the Request (Send Task) message
Xfer_Rdy	Consists of the arguments received in the XFER_RDY Arrived message
Data-Out Buffer	The location of the application client's data-out buffer (i.e., the application client buffer for write data)
Data-Out Buffer Size	The size in bytes of the application client's data-out buffer (i.e., the application client buffer for write data)
Data-In Buffer Size	The size in bytes of the application client's data-in buffer (i.e., the application client buffer for read data)

9.2.6.2.3.2 ST_ITS1:Initiator_Start state

9.2.6.2.3.2.1 State description

This state is the initial state of the ST_ITS state machine.

Upon entry into this state, this state shall set the Data-In Buffer Offset state machine variable to zero.

Upon entry into this state, this state shall set the Data-Out Buffer Offset state machine variable to zero.

9.2.6.2.3.2.2 Transition ST_ITS1:Initiator_Start to ST_ITS3:Prepare_Command

This transition shall occur **after this state receives** a Request (Send Command) message.

9.2.6.2.3.2.3 Transition ST_ITS1:Initiator_Start to ST_ITS4:Prepare_Task

This transition shall occur **after this state receives** a Request (Send Task) message.

9.2.6.2.3.3 ST_ITS2:Initiator_Send_Frame state

If this state is entered from the ST_ITS3:Prepare_Command state for transmission of a COMMAND frame, then this state shall send a Transmit Frame (Interlocked) request to the port layer.

If this state is entered from the ST_ITS6:Receive_Data_In state, and the vendor-specific number of retries has not been reached for the COMMAND frame requesting a read operation, then this state shall send a Transmit Frame (Interlocked) request to the port layer.

If this state is entered from the ST_ITS4:Prepare_Task state for transmission of an TASK frame, then this state shall send a Transmit Frame (Interlocked) request to the port layer.

If this state is entered from the ST_ITS5:Prepare_Data_Out state for transmission of a write DATA frame, then this state shall send a Transmit Frame (Non-Interlocked) request to the port layer after this state has received an XFER_RDY Arrived message.

If this state is entered from the ST_ITS5:Prepare_Data_Out state for transmission of a write DATA frame and **first bust** is enabled, then this state shall send a Transmit Frame (Non-Interlocked) request to the port layer after this state has received a Transmission Status (Frame Transmitted) confirmation and a Transmission Status (ACK Received) confirmation for the COMMAND frame.

A Transmit Frame request shall include the COMMAND frame from the ST_ITS3:Prepare_Command state or from the ST_ITS6:Receive_Data_In state, the TASK frame from the ST_ITS4:Prepare_Task state, or the write

● Author: RElliott
Subject: Highlight
Date: 6/30/2008 6:16:52 PM
T ACCEPT - DONE

after this state receives
s/b
after receiving

● Author: RElliott
Subject: Highlight
Date: 6/30/2008 6:16:52 PM
T ACCEPT - DONE

after this state receives
s/b
after receiving

● Author: wdc-mevans
Subject: Highlight
Date: 5/22/2008 4:35:33 PM
T ACCEPT - DONE (although first burst is a bust)

first bust
s/b
first burst

DATA frame from the ST_ITS5:Prepare_Data_Out state and the following arguments to be used for any OPEN address frame:

- a) initiator port bit set to one;
- b) protocol set to SSP;
- c) Connection Rate argument;
- d) Initiator Connection Tag argument;
- e) Destination SAS Address argument; and
- f) Source SAS Address argument.

After sending a Transmit Frame request this state shall wait to receive a Transmission Status confirmation.

If the confirmation is Transmission Status (I_T Nexus Loss), then this state shall send a Transmission Complete (I_T Nexus Loss) message to the ST_IFR state machine. This Transmission Complete message shall include the tag as an argument.

If the confirmation is not Transmission Status (Frame Transmitted) or Transmission Status (I_T Nexus Loss) (see table 160 in 8.2.2.3.4), and the Transmit Frame request was for a COMMAND frame or a DATA frame, then this state shall send a Transmission Complete (Command Failed, Connection Failed) message to the ST_IFR state machine. The message shall include the tag.

If the confirmation is not Transmission Status (Frame Transmitted) or Transmission Status (I_T Nexus Loss) (see table 160 in 8.2.2.3.4), and the Transmit Frame request was for a TASK frame, then this state shall send a Transmission Complete (Task Failed, Connection Failed) message to the ST_IFR state machine. The message shall include the tag.

If the confirmation is Transmission Status (Frame Transmitted), and the Transmit Frame request was for a COMMAND frame not requesting a read operation, a COMMAND frame not requesting a write operation, a TASK frame, or a write DATA frame where the number of data bytes that have been transmitted equal the Data-Out Buffer Size state machine argument, then this state shall wait to receive one of the following confirmations:

- a) Transmission Status (ACK Received);
- b) Transmission Status (NAK Received);
- c) Transmission Status (ACK/NAK Timeout); or
- d) Transmission Status (Connection Lost Without ACK/NAK).

If the confirmation is Transmission Status (Frame Transmitted), and the Transmit Frame request was for a COMMAND frame requesting a write operation, or a write DATA frame where the number of data bytes that have been transmitted is less than the Data-Out Buffer Size state machine argument and the write data length from the previous XFER_RDY frame, then this state shall wait to receive one of the following confirmations:

- a) Transmission Status (ACK Received);
- b) Transmission Status (NAK Received);
- c) Transmission Status (ACK/NAK Timeout);
- d) Transmission Status (Connection Lost Without ACK/NAK); or
- e) XFER_RDY Arrived message.

If a XFER_RDY Arrived message is received, then the ST_ITS shall respond to the XFER_RDY frame as if a Transmission Status (ACK Received) was received.

NOTE 89 - If the number of data bytes requested to be transmitted for the Send SCSI Command protocol service request are fewer than the number of bytes in the service request, then this state may send additional Transmit Frame requests for write DATA frames for the protocol service request before receiving a Transmission Status (ACK Received), Transmission Status (NAK Received), Transmission Status (ACK/NAK Timeout), or Transmission Status (Connection Lost Without ACK/NAK) confirmation for Transmit Frame requests for previous write DATA frames sent for the I_T_L_Q nexus.

After a Transmission Status (Frame Transmitted) is received, if a confirmation of Transmission Status (NAK Received) is received, the Transmit Frame request was for a COMMAND frame, and the vendor-specific number of retries has not been reached, then this state shall send a Transmit Frame (interlocked) request to the port layer (i.e., the last COMMAND frame is retransmitted).

Author: wdc-mevans

Subject: Highlight

Date: 6/27/2008 5:40:48 PM

T REJECT (no, it must be less than the buffer size, and must be less than the write data length. They're not added together, which would allow a buffer overflow.)

and
s/b
plus

Author: RElliott

Subject: Highlight

Date: 8/30/2008 12:39:13 PM

T ACCEPT - DONE

move confirmations
into a)b)c)d) since it doesn't apply to e)

per 08-343

Author: RElliott

Subject: Highlight

Date: 8/30/2008 12:39:30 PM

T ACCEPT - DONE

Transmission Status (ACK Received)

add
confirmation
per 08-343

Author: lsi-gpenokie

Subject: Highlight

Date: 6/27/2008 5:41:50 PM

T REJECT (this is summarizing the effects of other rules in this section. Making it normative would introduce duplicate requirements.)

This note << NOTE 89 - If the number of d >> should be normative.

Author: RElliott

Subject: Highlight

Date: 8/30/2008 12:39:41 PM

T ACCEPT - DONE

Transmission Status (Frame Transmitted)

add
confirmation
per 08-343

Author: RElliott

Subject: Highlight

Date: 8/30/2008 12:41:05 PM

T ACCEPT - DONE

confirmation of Transmission Status (NAK Received)

s/b
Transmission Status (NAK Received) confirmation

Author: RElliott

Subject: Highlight

Date: 8/30/2008 12:43:16 PM

T ACCEPT - DONE

DATA frame from the ST_ITS5:Prepare_Data_Out state and the following arguments to be used for any OPEN address frame:

- a) initiator port bit set to one;
- b) protocol set to SSP;
- c) Connection Rate argument;
- d) Initiator Connection Tag argument;
- e) Destination SAS Address argument; and
- f) Source SAS Address argument.

After sending a Transmit Frame request this state shall wait to receive a Transmission Status confirmation.

If the confirmation is Transmission Status (I_T Nexus Loss), then this state shall send a Transmission Complete (I_T Nexus Loss) message to the ST_IFR state machine. This Transmission Complete message shall include the tag as an argument.

If the confirmation is not Transmission Status (Frame Transmitted) or Transmission Status (I_T Nexus Loss) (see table 160 in 8.2.2.3.4), and the Transmit Frame request was for a COMMAND frame or a DATA frame, then this state shall send a Transmission Complete (Command Failed, Connection Failed) message to the ST_IFR state machine. The message shall include the tag.

If the confirmation is not Transmission Status (Frame Transmitted) or Transmission Status (I_T Nexus Loss) (see table 160 in 8.2.2.3.4), and the Transmit Frame request was for a TASK frame, then this state shall send a Transmission Complete (Task Failed, Connection Failed) message to the ST_IFR state machine. The message shall include the tag.

If the confirmation is Transmission Status (Frame Transmitted), and the Transmit Frame request was for a COMMAND frame not requesting a read operation, a COMMAND frame not requesting a write operation, a TASK frame, or a write DATA frame where the number of data bytes that have been transmitted equal the Data-Out Buffer Size state machine argument, then this state shall wait to receive one of the following confirmations:

- a) Transmission Status (ACK Received);
- b) Transmission Status (NAK Received);
- c) Transmission Status (ACK/NAK Timeout); or
- d) Transmission Status (Connection Lost Without ACK/NAK).

If the confirmation is Transmission Status (Frame Transmitted), and the Transmit Frame request was for a COMMAND frame requesting a write operation, or a write DATA frame where the number of data bytes that have been transmitted is less than the Data-Out Buffer Size state machine argument and the write data length from the previous XFER_RDY frame, then this state shall wait to receive one of the following confirmations:

- a) Transmission Status (ACK Received);
- b) Transmission Status (NAK Received);
- c) Transmission Status (ACK/NAK Timeout);
- d) Transmission Status (Connection Lost Without ACK/NAK); or
- e) XFER_RDY Arrived message.

If a XFER_RDY Arrived message is received, then the ST_ITS shall respond to the XFER_RDY frame as if a Transmission Status (ACK Received) was received.

NOTE 89 - If the number of data bytes requested to be transmitted for the Send SCSI Command protocol service request are fewer than the number of bytes in the service request, then this state may send additional Transmit Frame requests for write DATA frames for the protocol service request before receiving a Transmission Status (ACK Received), Transmission Status (NAK Received), Transmission Status (ACK/NAK Timeout), or Transmission Status (Connection Lost Without ACK/NAK) confirmation for Transmit Frame requests for previous write DATA frames sent for the I_T_L_Q nexus.

After a Transmission Status (Frame Transmitted) is received, if a confirmation of Transmission Status (NAK Received) is received, the Transmit Frame request was for a COMMAND frame, and the vendor-specific number of retries has not been reached, then this state shall send a Transmit Frame (interlocked) request to the port layer (i.e., the last COMMAND frame is retransmitted).

interlocked
s/b
Interlocked

After a **Transmission Status (Frame Transmitted)** is received, if a **confirmation of Transmission Status (NAK Received)** is received, the Transmit Frame request was for a TASK frame, and the vendor-specific number of retries has not been reached, then this state shall send a Transmit Frame (**interlocked**) request to the port layer (i.e., the last TASK frame is retransmitted).

Table 179 defines the messages that this state shall send to the ST_IFR state machine upon receipt of the listed confirmations, based on the conditions under which each confirmation was received.

Table 179 — Messages sent to the ST_IFR state machine

Confirmation received from the port layer	Conditions under which confirmation was received	Message sent to ST_IFR state machine
Transmission Status (ACK/NAK Timeout) or Transmission Status (Connection Lost Without ACK/NAK)	The Transmit Frame request was for a COMMAND frame.	Transmission Complete (Command Failed, ACK/NAK Timeout)
	The Transmit Frame request was for a TASK frame.	Transmission Complete (Task Failed, ACK/NAK Timeout)
Transmission Status (NAK Received)	The Transmit Frame request was for a COMMAND frame and the vendor-specific number of retries has been reached.	Transmission Complete (Command Failed, NAK Received)
	The Transmit Frame request was for a TASK frame and the vendor-specific number of retries has been reached.	Transmission Complete (Task Failed, NAK Received)
Transmission Status (NAK Received)	The Transmit Frame request was for a write DATA frame and: a) the RETRY DATA FRAMES bit was set to zero in the XFER_RDY frame requesting the data; or b) the RETRY DATA FRAMES bit was set to one in the XFER_RDY frame requesting the data, and the vendor-specific number of retries has been reached.	Transmission Complete (Data-Out Failed, NAK Received)
Transmission Status (ACK/NAK Timeout) or Transmission Status (Connection Lost Without ACK/NAK)		Transmission Complete (Data-Out Failed, ACK/NAK Timeout)

After this state sends a **Transmission Complete (Command Failed, ACK/NAK Timeout)** this state shall continue processing messages and confirmations.

NOTE 90 - The application client may determine the command was received and is being processed by the device server and allow the command to complete. The application client may accomplish this by **the use of** the QUERY TASK task management request.

If this state receives a Return to Start message or a Return to Start argument, and this state has not received confirmations for all Transmit Frame requests sent to the port layer, then this state shall send a Cancel request to the port layer. This state may also send a Cancel request to the port layer to cancel a previous Transmit Frame request.

If this state receives a Cancel message or a Cancel argument, and this state has received confirmations for all Transmit Frame requests sent to the port layer, then this state shall send a Transmission Complete (Cancel Acknowledged) message to the ST_IFR state machine.

If this state receives a Cancel message or a Cancel argument, and this state has not received confirmations for all Transmit Frame requests sent to the port layer, then this state shall send a Cancel request to the port layer. This state may also send a Cancel request to the port layer to cancel a previous Transmit Frame request. The Cancel request shall include the following arguments:

- a) destination SAS address; and

● Author: RElliott
Subject: Highlight
Date: 8/30/2008 12:39:54 PM
T ACCEPT - DONE

Transmission Status (Frame Transmitted)
add
confirmation
per 08-343

● Author: RElliott
Subject: Highlight
Date: 8/30/2008 12:40:37 PM
T ACCEPT - DONE

confirmation of Transmission Status (NAK Received)
s/b
Transmission Status (NAK Received) confirmation

● Author: RElliott
Subject: Highlight
Date: 8/30/2008 12:42:54 PM
T ACCEPT - DONE

interlocked
s/b
Interlocked

● Author: RElliott
Subject: Highlight
Date: 8/30/2008 12:44:23 PM
T ACCEPT - DONE

Transmission Complete (Command Failed, ACK/NAK Timeout)
add
message
per 08-343

● Author: RElliott
Subject: Highlight
Date: 6/30/2008 6:16:52 PM
T ACCEPT - DONE

the use of
s/b
using

b) tag.

NOTE 91 - The Cancel message results from a vendor-specific request from the SCSI application layer after the SCSI application layer has used a task management function to determine that the SAS target port did not receive the COMMAND frame.

If this state receives a Transmission Status (Cancel Acknowledged) confirmation, then this state shall send a Transmission Complete (Cancel Acknowledged) message to the ST_IFR state machine.

If this state receives an XFER_RDY Arrived message, then this state shall verify the Xfer_Rdy state machine argument as specified in table 180. If the verification fails, then this state sends the Transmission Complete message specified in table 180 to the ST_IFR state machine.

Table 180 — Transmission Complete messages for XFER_RDY frame verification failures

Message sent to ST_IFR ^a	Condition
Transmission Complete (XFER_RDY Incorrect Write Data Length)	The Write Data Length Xfer_Rdy state machine argument is zero.
	The Requested Offset Xfer_Rdy state machine argument plus the Write Data Length Xfer_Rdy state machine argument is greater than the Data-Out Buffer Size state machine argument.
Transmission Complete (XFER_RDY Requested Offset Error)	First burst is disabled, this is the first XFER_RDY frame for a command, and the value in the Requested Offset Xfer_Rdy state machine argument is not set to zero.
	First burst is enabled, this is the first XFER_RDY frame for a command, and the value in the Requested Offset Xfer_Rdy state machine argument is not equal to the value indicated by the FIRST BURST SIZE field in the Disconnect-Reconnect mode page (see 10.2.7.2.5).
	Transport layer retries are disabled and the Requested Offset Xfer_Rdy state machine argument is not equal to the Previous Requested Offset state machine variable plus the Previous Write Data Length Field state machine variable.
	Transport layer retries are enabled, the Retransmit Bit Xfer_Rdy state machine argument is set to zero, and the Requested Offset Xfer_Rdy state machine argument is not equal to the Previous Requested Offset state machine variable plus the Previous Write Data Length state machine variable.
	Transport layer retries are enabled, this is not the first XFER_RDY frame for the command, the Retransmit Bit Xfer_Rdy state machine argument is set to one, and the Requested Offset Xfer_Rdy state machine argument is not equal to the Previous Requested Offset state machine variable.
^a If more than one condition is true, then this state shall send the Transmission Complete (XFER_RDY Incorrect Write Data Length) message to the ST_IFR state machine.	

After this state verifies an XFER_RDY frame, it shall:

- a) set the Data-Out Buffer Offset state machine variable to the Requested Offset Xfer_Rdy state machine argument;
- b) set the Previous Requested Offset state machine variable to the Requested Offset Xfer_Rdy state machine argument; and
- c) set the Previous Write Data Length state machine variable to the Write Data Length Xfer_Rdy state machine argument.

● Author: RElliott
Subject: Highlight
Date: 6/30/2008 6:16:52 PM
T ACCEPT - DONE

SAS target port
s/b
SSP target port

● Author: wdc-mevans
Subject: Highlight
Date: 5/22/2008 10:16:47 AM
T ACCEPT - DONE

sends
s/b
shall send

9.2.6.2.3.3.1 Transition ST_ITS2:Initiator_Send_Frame to ST_ITS1:Initiator_Start

This transition shall occur after:

- a) this state has sent one of the following to the ST_IFR state machine:
 - A) a Transmission Complete (Command Failed, NAK Received) message;
 - B) a Transmission Complete (Task Failed, ACK/NAK Timeout) message;
 - C) a Transmission Complete (Task Failed, NAK Received) message;
 - D) a Transmission Complete (Command Failed, ACK/NAK Timeout) message and the command was for a non-data operation;
 - E) a Transmission Complete (Data-Out Failed, NAK Received) message;
 - F) a Transmission Complete (Data-Out Failed, ACK/NAK Timeout) message;
 - G) a Transmission Complete (XFER_RDY Incorrect Write Data Length) message;
 - H) a Transmission Complete (XFER_RDY Requested Offset Error) message; or
 - I) a Transmission Complete (Cancel Acknowledged) message;
- or
- b) this state has received a Return To Start message or Return To Start argument, and has received:
 - A) confirmations for all Transmit Frame requests sent to the port layer; or
 - B) a Transmission Status (Cancel Acknowledged) confirmation.

9.2.6.2.3.3.2 Transition ST_ITS2:Initiator_Send_Frame to ST_ITS5:Prepare_Data_Out

If first burst is enabled, **this** transition shall occur and include the First Burst argument **after this state receives:**

- a) a Transmission Status (Frame Transmitted) confirmation followed by a **Transmission Status (ACK Received)** for a COMMAND frame requesting a write operation; or
- b) a Transmission Status (Frame Transmitted) confirmation for a Transmit Frame (Non-interlocked) request if the Data-Out Buffer Offset state machine variable is less than the first burst size.

This transition shall occur **after this state receives:**

- a) an XFER_RDY Arrived message; or
- b) a Transmission Status (Frame Transmitted) confirmation for a Transmit Frame (Non-interlocked) request if the Data-Out Buffer Offset state machine variable is less than the Requested Offset Xfer_Rdy state machine argument plus the Write Data Length Xfer_Rdy state machine argument.

NOTE 92 - This transition occurs even if this state has not received a **Transmission Status (ACK Received)** for the write DATA frame.

This transition shall include a Retry argument and occur after:

- a) this state receives one of the following confirmations or arguments for a write DATA frame:
 - A) Transmission Status (NAK Received);
 - B) Transmission Status (ACK/NAK Timeout); or
 - C) Transmission Status (Connection Lost without ACK/NAK);
- b) the RETRY DATA FRAMES bit is set to one in the XFER_RDY frame for the write operation;
- c) the Data-Out Buffer Offset state machine variable is set to the Requested Offset Xfer_Rdy state machine argument;
- d) all write DATA frames that have received a Transmission Status (Frame Transmitted) confirmation have received a Transmission Status confirmation; and
- e) the vendor-specific number of retries, if any, for the write DATA frame has not been reached.

9.2.6.2.3.3.3 Transition ST_ITS2:Initiator_Send_Frame to ST_ITS6:Process_Data_In

This transition shall occur **after this state receives** a Transmission Status (Frame Transmitted) confirmation for a COMMAND frame for a command requesting a read operation.

NOTE 93 - This transition occurs even if this state has not received a Transmission Status (ACK Received) for the COMMAND frame.

● Author: RElliott
Subject: Highlight
Date: 6/30/2008 6:16:52 PM
T ACCEPT - DONE

after this state receives
s/b
after receiving

● Author: RElliott
Subject: Highlight
Date: 6/30/2008 6:16:52 PM
T ACCEPT - DONE

this
s/b
then this

● Author: RElliott
Subject: Highlight
Date: 8/30/2008 1:00:30 PM
T ACCEPT - DONE
Transmission Status (ACK Received)
add
confirmation
per 08-343

● Author: RElliott
Subject: Highlight
Date: 6/30/2008 6:16:52 PM
T ACCEPT - DONE
after this state receives
s/b
after receiving

● Author: RElliott
Subject: Highlight
Date: 8/30/2008 1:00:48 PM
T ACCEPT - DONE
Transmission Status (ACK Received)
add
confirmation
in the spirit of 08-343

● Author: RElliott
Subject: Highlight
Date: 6/30/2008 6:16:52 PM
T ACCEPT - DONE
after this state receives
s/b
after receiving

9.2.6.2.3.4 ST_ITS3:Prepare_Command state

9.2.6.2.3.4.1 State description

This state shall construct a COMMAND frame using the Command arguments:

- a) FRAME TYPE field set to 06h (i.e., COMMAND frame);
- b) HASHED DESTINATION SAS ADDRESS field set to the hashed value of the Destination SAS Address Commands argument;
- c) HASHED SOURCE SAS ADDRESS field set to the hashed value of the SSP initiator port's SAS address;
- d) RETRY DATA FRAMES bit set to zero;
- e) RETRANSMIT bit set to zero;
- f) CHANGING DATA POINTER bit set to zero;
- g) NUMBER OF FILL BYTES field set zero;
- h) TAG field set to the Tag Command argument;
- i) TARGET PORT TRANSFER TAG field set to FFFFh;
- j) DATA OFFSET field set to zero;
- k) in the information unit, LOGICAL UNIT NUMBER field set to the Logical Unit Number Command argument;
- l) in the information unit, ENABLE FIRST BURST bit set to the Enable First Burst Command argument;
- m) in the information unit, TASK PRIORITY field set to the Task Priority Command argument;
- n) in the information unit, TASK ATTRIBUTE field set to the Task Attribute Command argument;
- o) in the information unit, ADDITIONAL CDB LENGTH field set to the Additional CDB Length Command argument;
- p) in the information unit, CDB field set to the CDB Command argument;
- q) in the information unit, ADDITIONAL CDB BYTES field set to the Additional CDB Bytes Command argument, if any; and
- r) no fill bytes.

9.2.6.2.3.4.2 Transition ST_ITS3:Prepare_Command to ST_ITS2:Initiator_Send_Frame

This transition shall occur after this state:

- a) constructs a COMMAND frame;
- b) receives a Cancel message; or
- c) receives a Return To Start message.

This transition shall include the:

- a) COMMAND frame as an argument;
- b) if a Cancel message was received, then a Cancel argument; or
- c) if a Return To Start message was received, then a Return To Start argument.

9.2.6.2.3.5 ST_ITS4:Prepare_Task state

9.2.6.2.3.5.1 State description

This state shall construct a TASK frame using the Task arguments:

- a) FRAME TYPE field set to 16h (i.e., TASK frame);
- b) HASHED DESTINATION SAS ADDRESS field set to the hashed value of the Destination SAS Address Task argument;
- c) HASHED SOURCE SAS ADDRESS field set to the hashed value of the SSP initiator port's SAS address;
- d) RETRY DATA FRAMES bit set to zero;
- e) RETRANSMIT bit set to the Retransmit Bit Task argument;
- f) CHANGING DATA POINTER bit set to zero;
- g) NUMBER OF FILL BYTES field set zero;
- h) TAG field set to the Tag Task argument;
- i) TARGET PORT TRANSFER TAG field set to FFFFh;
- j) DATA OFFSET field set to zero;
- k) in the information unit, LOGICAL UNIT NUMBER field set to the Logical Unit Number Task argument;

● Author: RElliott
Subject: Highlight
Date: 6/30/2008 6:16:52 PM
T ACCEPT - DONE

set zero.
s/b
set to 00b;

● Author: RElliott
Subject: Highlight
Date: 6/30/2008 6:16:52 PM
T ACCEPT - DONE

zero
s/b
00000000h

● Author: RElliott
Subject: Highlight
Date: 6/30/2008 6:16:52 PM
T ACCEPT - DONE

move "the" into a)

● Author: RElliott
Subject: Underline
Date: 6/30/2008 6:16:52 PM
T ACCEPT - DONE

COMMAND frame
s/b
if neither a Cancel message nor a Return to Start message was received, then the COMMAND frame

● Author: lsi-gpenokie
Subject: Highlight
Date: 6/27/2008 6:22:47 PM
T REJECT (no, only one is included. See added comment)

This << or >> should be a << and >>.

● Author: RElliott
Subject: Highlight
Date: 6/30/2008 6:16:52 PM
T ACCEPT - DONE

set zero.
s/b
set to 00b;

● Author: RElliott
Subject: Highlight
Date: 6/30/2008 6:16:52 PM
T ACCEPT - DONE

zero
s/b
00000000h

9.2.6.2.3.4 ST_ITS3:Prepare_Command state

9.2.6.2.3.4.1 State description

This state shall construct a COMMAND frame using the Command arguments:

- a) FRAME TYPE field set to 06h (i.e., COMMAND frame);
- b) HASHED DESTINATION SAS ADDRESS field set to the hashed value of the Destination SAS Address Commands argument;
- c) HASHED SOURCE SAS ADDRESS field set to the hashed value of the SSP initiator port's SAS address;
- d) RETRY DATA FRAMES bit set to zero;
- e) RETRANSMIT bit set to zero;
- f) CHANGING DATA POINTER bit set to zero;
- g) NUMBER OF FILL BYTES field set zero.
- h) TAG field set to the Tag Command argument;
- i) TARGET PORT TRANSFER TAG field set to FFFFh;
- j) DATA OFFSET field set to zero;
- k) in the information unit, LOGICAL UNIT NUMBER field set to the Logical Unit Number Command argument;
- l) in the information unit, ENABLE FIRST BURST bit set to the Enable First Burst Command argument;
- m) in the information unit, TASK PRIORITY field set to the Task Priority Command argument;
- n) in the information unit, TASK ATTRIBUTE field set to the Task Attribute Command argument;
- o) in the information unit, ADDITIONAL CDB LENGTH field set to the Additional CDB Length Command argument;
- p) in the information unit, CDB field set to the CDB Command argument;
- q) in the information unit, ADDITIONAL CDB BYTES field set to the Additional CDB Bytes Command argument, if any; and
- r) no fill bytes.

9.2.6.2.3.4.2 Transition ST_ITS3:Prepare_Command to ST_ITS2:Initiator_Send_Frame

This transition shall occur after this state:

- a) constructs a COMMAND frame;
- b) receives a Cancel message; or
- c) receives a Return To Start message.

This transition shall include the:

- a) COMMAND frame as an argument;
- b) if a Cancel message was received, then a Cancel argument; or
- c) if a Return To Start message was received, then a Return To Start argument.

9.2.6.2.3.5 ST_ITS4:Prepare_Task state

9.2.6.2.3.5.1 State description

This state shall construct a TASK frame using the Task arguments:

- a) FRAME TYPE field set to 16h (i.e., TASK frame);
- b) HASHED DESTINATION SAS ADDRESS field set to the hashed value of the Destination SAS Address Task argument;
- c) HASHED SOURCE SAS ADDRESS field set to the hashed value of the SSP initiator port's SAS address;
- d) RETRY DATA FRAMES bit set to zero;
- e) RETRANSMIT bit set to the Retransmit Bit Task argument;
- f) CHANGING DATA POINTER bit set to zero;
- g) NUMBER OF FILL BYTES field set zero.
- h) TAG field set to the Tag Task argument;
- i) TARGET PORT TRANSFER TAG field set to FFFFh;
- j) DATA OFFSET field set to zero;
- k) in the information unit, LOGICAL UNIT NUMBER field set to the Logical Unit Number Task argument;

- l) in the information unit, TASK MANAGEMENT FUNCTION field set to the Task Management Function Task argument;
- m) in the information unit, TAG OF TASK TO BE MANAGED field set to the Tag Task argument of **task to be managed and**
- n) no fill bytes.

9.2.6.2.3.5.2 Transition ST_ITS4:Prepare_Task to ST_ITS2:Initiator_Send_Frame

This transition shall occur after this state:

- a) constructs a TASK frame;
- b) receives a Cancel message; or
- c) receives a Return To Start message.

This transition shall include **the:**

- a) TASK frame as an argument;
- b) if a Cancel message was received, then a Cancel argument; **or**
- c) if a Return To Start message was received, then a Return To Start argument.

9.2.6.2.3.6 ST_ITS5:Prepare_Data_Out state

9.2.6.2.3.6.1 State description

This state shall construct a write DATA frame using the following Xfer_Rdy state machine arguments and Command state machine arguments:

- a) FRAME TYPE field set to 01h (i.e., DATA frame);
- b) HASHED DESTINATION SAS ADDRESS field set to the hashed value of the Destination SAS Address Command argument;
- c) HASHED SOURCE SAS ADDRESS field set to the hashed value of the SSP initiator port's SAS address;
- d) RETRY DATA FRAMES bit set to zero;
- e) RETRANSMIT bit set to zero;
- f) CHANGING DATA POINTER bit set as specified in this subclause;
- g) NUMBER OF FILL BYTES field set to the number of fill bytes, based on the length of the specified data;
- h) TAG field set to the Tag Command argument;
- i) TARGET PORT TRANSFER TAG field set to FFFFh if this state received a First Burst argument or the Target Port Transfer Tag Xfer_Rdy argument if this state did not receive a First Burst argument;
- j) DATA OFFSET field set to the Data-Out Buffer Offset state machine variable;
- k) in the information unit, DATA field set to the information that starts at the location in the Data-Out Buffer state machine argument pointed to by the Data-Out Buffer Offset state machine variable. **If the number of bytes remaining to be transferred as defined by the following calculation:**

bytes remaining to be transferred = Write Data Length Xfer_Rdy state machine argument - (Data-Out Buffer Offset state machine argument - Requested Offset Xfer_Rdy state machine argument)

is equal to the maximum size of the write Data information unit, then the amount of data shall be the maximum size of the write Data information unit. Otherwise, the amount of data shall be the lesser of:

- A) the bytes remaining to be transferred; and**
- B) the maximum size of the Write information unit;**

and

- l) fill bytes, if any.

If this state is entered without a Retry argument, then this state shall set the CHANGING DATA POINTER bit to zero.

If this state is entered with a Retry argument, then this state shall set the CHANGING DATA POINTER bit to one.

After constructing the write DATA frame, this state shall set the Data-Out Buffer Offset state machine variable to the value of the DATA OFFSET field plus the number of bytes in the DATA field in the write Data information unit.

Page: 477

Author: RElliott
Subject: Highlight
Date: 6/30/2008 6:16:52 PM
T ACCEPT - DONE

task
s/b
the command

Author: RElliott
Subject: Highlight
Date: 6/30/2008 6:16:52 PM
T ACCEPT - DONE

managed and
s/b
managed; and

Author: RElliott
Subject: Highlight
Date: 6/30/2008 6:16:52 PM
T ACCEPT - DONE

move "the" into a)

Author: RElliott
Subject: Underline
Date: 6/30/2008 6:16:52 PM
T ACCEPT - DONE

TASK frame
s/b
if neither a Cancel message nor a Return to Start message was received,
then the TASK frame

Author: lsi-gpenokie
Subject: Highlight
Date: 6/27/2008 6:22:56 PM
T REJECT (no, only one of them is included. See added comment)

This << or >> should be a << and >>.

Author: wdc-mevans
Subject: Highlight
Date: 6/27/2008 6:30:42 PM
T REJECT (this is the state machine, so referring to the state machine variables concretely in terms is preferable.)

If the number of bytes remaining to be transferred as defined by the following calculation:

bytes remaining to be transferred = Write Data Length Xfer_Rdy state machine argument - (Data-Out Buffer Offset state machine argument - Requested Offset Xfer_Rdy state machine argument)

is equal to the maximum size of the write Data information unit, then the amount of data shall be the maximum size of the write Data information unit. Otherwise, the amount of data shall be the lesser of:

- A) the bytes remaining to be transferred; and
- B) the maximum size of the Write information unit;

s/b

Comments from page 477 continued on next page

- l) in the information unit, TASK MANAGEMENT FUNCTION field set to the Task Management Function Task argument;
- m) in the information unit, TAG OF TASK TO BE MANAGED field set to the Tag Task argument of **task** to be **managed and**
- n) no fill bytes.

9.2.6.2.3.5.2 Transition ST_ITS4:Prepare_Task to ST_ITS2:Initiator_Send_Frame

This transition shall occur after this state:

- a) constructs a TASK frame;
- b) receives a Cancel message; or
- c) receives a Return To Start message.

This transition shall include **the:**

- a) TASK frame as an argument;
- b) if a Cancel message was received, then a Cancel argument; **or**
- c) if a Return To Start message was received, then a Return To Start argument.

9.2.6.2.3.6 ST_ITS5:Prepare_Data_Out state

9.2.6.2.3.6.1 State description

This state shall construct a write DATA frame using the following Xfer_Rdy state machine arguments and Command state machine arguments:

- a) FRAME TYPE field set to 01h (i.e., DATA frame);
- b) HASHED DESTINATION SAS ADDRESS field set to the hashed value of the Destination SAS Address Command argument;
- c) HASHED SOURCE SAS ADDRESS field set to the hashed value of the SSP initiator port's SAS address;
- d) RETRY DATA FRAMES bit set to zero;
- e) RETRANSMIT bit set to zero;
- f) CHANGING DATA POINTER bit set as specified in this subclause;
- g) NUMBER OF FILL BYTES field set to the number of fill bytes, based on the length of the specified data;
- h) TAG field set to the Tag Command argument;
- i) TARGET PORT TRANSFER TAG field set to FFFFh if this state received a First Burst argument or the Target Port Transfer Tag Xfer_Rdy argument if this state did not receive a First Burst argument;
- j) DATA OFFSET field set to the Data-Out Buffer Offset state machine variable;
- k) in the information unit, DATA field set to the information that starts at the location in the Data-Out Buffer state machine argument pointed to by the Data-Out Buffer Offset state machine variable. **If the number of bytes remaining to be transferred as defined by the following calculation:**

bytes remaining to be transferred = Write Data Length Xfer_Rdy state machine argument - (Data-Out Buffer Offset state machine argument - Requested Offset Xfer_Rdy state machine argument)

is equal to the maximum size of the write Data information unit, then the amount of data shall be the maximum size of the write Data information unit. Otherwise, the amount of data shall be the lesser of:

- A) the bytes remaining to be transferred; and**
- B) the maximum size of the Write information unit;**

and

- l) fill bytes, if any.

If this state is entered without a Retry argument, then this state shall set the CHANGING DATA POINTER bit to zero.

If this state is entered with a Retry argument, then this state shall set the CHANGING DATA POINTER bit to one.

After constructing the write DATA frame, this state shall set the Data-Out Buffer Offset state machine variable to the value of the DATA OFFSET field plus the number of bytes in the DATA field in the write Data information unit.

The number of bytes in the DATA field shall be less than or equal to the maximum number of bytes of the field. If the DATA frame does not contain the last data for the transfer, then the number of bytes contained in the DATA field shall be a multiple of four. If the DATA frame contains the last data for the transfer, then the number of bytes contained in the DATA field may not be a multiple of four.

9.2.6.2.3.6.2 Transition ST_ITS5:Prepare_Data_Out to ST_ITS2:Initiator_Send_Frame

This transition shall occur after this state:

- a) constructs a write DATA frame;
- b) receives a Cancel message; or
- c) receives a Return To Start message.

This transition shall include the received Transmission Status, if any, as an argument and **the:**

- a) write DATA frame as an argument,
- b) if a Cancel message was received, then a Cancel argument; **or**
- c) if a Return To Start message was received, then a Return To Start argument.

9.2.6.2.3.7 ST_ITS6:Receive_Data_In state

9.2.6.2.3.7.1 State description

If this state receives a Data-In Arrived message, then this state shall verify the values in the read DATA frame received with the message as defined in table 181.

If the verification fails, then this state sends the Reception Complete message specified in table 181 to the ST_IFR state machine.

Table 181 — Reception Complete messages for read DATA frame verification failures

Message sent to ST_IFR ^a	Condition
Reception Complete (Data Offset Error)	Transport layer retries are disabled, and the DATA OFFSET field in the read DATA frame is not equal to the Data-In Buffer Offset state machine variable.
	The DATA OFFSET field in the read DATA frame is greater than the Data-In Buffer Size state machine argument.
Reception Complete (Too Much Read Data)	The number of bytes in the DATA field in the read Data information unit plus the Data-In Buffer Offset state machine variable is greater than the Data-In Buffer Size state machine argument.
Reception Complete (Incorrect Data Length)	The number of bytes in the DATA field in the read Data information unit is zero.
^a If more than one condition is true, then this state shall select which message to send to the ST_IFR state machine using the following order: <ol style="list-style-type: none"> 1) Reception Complete (Data Offset Error); 2) Reception Complete (Too Much Read Data); or 3) Reception Complete (Incorrect Data Length). 	

If:

- a) transport layer retries are enabled;
- b) **the CHANGING DATA POINTER bit is set to zero;**
- c) the DATA OFFSET field is not set to the Data-In Buffer Offset state machine variable;
- d) the DATA OFFSET field is less than the Data-In Buffer Size state machine argument; and
- e) the DATA OFFSET field plus the number of bytes in the DATA field in the read Data information unit is less than or equal to the Data-In Buffer Size state machine argument,

then this state should discard all Data-In Arrived messages until a read DATA frame is received in which the CHANGING DATA POINTER bit is set to one. This state shall resume processing additional Data-In Arrived messages when it receives a Data-In Arrived message with the CHANGING DATA POINTER bit set to one.

If the read DATA frame verification is successful or after this state resumes processing Data-In Arrived messages, then this state shall process the data received in the read DATA frame and set the Data-In Buffer

Page: 478

Author: RElliott
Subject: Highlight
Date: 6/30/2008 6:16:52 PM
 ACCEPT - DONE

move "the" into a)

Author: RElliott
Subject: Underline
Date: 6/30/2008 6:16:52 PM
 ACCEPT - DONE

write DATA frame
s/b
if neither a Cancel message nor a Return to Start message was received,
then the write DATA frame

Author: Isi-gpenokie
Subject: Highlight
Date: 6/27/2008 6:23:18 PM
 REJECT (no, only one of them is sent. See added comment)

This << or >> should be a << and >>.

Author: wdc-mevans
Subject: Highlight
Date: 8/27/2008 7:56:18 PM
 ACCEPT - DONE (7/17 agree, lumping in with Incorrect Data Length looks best.

see associated comment in target reception of write data and Information Unit Too Short)

The number of bytes in the DATA field in the read Data information unit is zero.

s/b

a) The number of bytes in the DATA field in the read Data information unit is zero; or

b) This is not the last DATA frame for the transfer and the NUMBER OF FILL BYTES field in the frame is not set to zero.

Author: RElliott
Subject: Highlight
Date: 8/28/2008 3:59:05 PM
 ACCEPT - DONE

Incorrect Data Length
s/b
Information Unit Too Short

to match what the ST_IFR is looking for. This is simpler than adding a new message throughout all the layers, or renaming it everywhere.

Author: hpq-relliott
Subject: Note
Date: 7/17/2008 9:19:51 PM
 REJECT

this wording should parallel ST_TTS5:Receive_Data_Out. Items d) and e) in particular are different.

Offset state machine variable to the DATA OFFSET field plus the number of bytes in the DATA field in the read Data information unit.

If data received in the read DATA frame overlaps data previously received and verified successfully, this state may either discard the overlapping data, or replace the previously received data with the new data.

If this state receives **Transmission Status (ACK/NAK Timeout)** or **Transmission Status (Connection Lost Without ACK/NAK)**, then this state shall send a **Reception Complete (Command Failed, Connection Failed)** to the ST_IFR state machine.

After this state sends a Reception Complete (Command Failed, Connection Failed) message, this state shall continue processing messages and confirmations.

NOTE 94 - The application client may determine the command was received and is being processed by the device server and allow the command to complete.

If this state receives a Cancel message, then this state shall send a Reception Complete (Cancel Acknowledged) message to the ST_IFR state machine. The Reception Complete message shall include the tag as an argument.

NOTE 95 - The Cancel message results from a vendor-specific request from the SCSI application layer after the SCSI application layer has used a task management function to determine that the **SAS target port** did not receive the COMMAND frame.

9.2.6.2.3.7.2 Transition ST_ITS6:Receive_Data_In to ST_ITS1:Initiator_Start

This transition shall occur after this state:

- a) sends one of the following to the ST_IFR state machine:
 - A) a Reception Complete (Data Offset Error) message;
 - B) a Reception Complete (Too Much Read Data) message;
 - C) a Reception Complete (Incorrect Data Length) message; or
 - D) a Reception Complete (Cancel Acknowledged) message;
- or
- b) receives a Return To Start message.

9.2.6.2.3.7.3 Transition ST_ITS6:Receve_Data_In to ST_ITS2:Initiator_Send_Frame

This transition shall occur **after this state receives** a ~~Transmission Status (NAK Received)~~ confirmation for a COMMAND frame for a command requesting a read operation.

9.2.6.3 ST_T (transport layer for SSP target ports) state machines

9.2.6.3.1 ST_T state machines overview

The ST_T state machines are as follows:

- a) ST_TFR (target frame router) state machine (see 9.2.6.3.2); and
- b) ST_TTS (target transport server) state machine (see 9.2.6.3.3).

The SAS target port includes:

- a) one ST_TFR state machine; and
- b) one ST_TTS state machine for each possible task and task management function (i.e., for each tag).

● Author: RElliott
Subject: Highlight
Date: 6/30/2008 6:16:52 PM

T ACCEPT - DONE
this
s/b
then this

● Author: RElliott
Subject: Highlight
Date: 8/30/2008 1:03:14 PM

T ACCEPT - DONE

Transmission Status (ACK/NAK Timeout) or Transmission Status (Connection Lost Without ACK/NAK)
add
confirmation
per 08-343

● Author: RElliott
Subject: Highlight
Date: 8/30/2008 1:03:28 PM

T ACCEPT - DONE

Reception Complete (Command Failed, Connection Failed)
add
message
per 08-343

● Author: RElliott
Subject: Highlight
Date: 6/30/2008 6:16:52 PM

T ACCEPT - DONE

SAS target port
s/b
SSP target port

● Author: RElliott
Subject: Highlight
Date: 6/30/2008 6:16:52 PM

T ACCEPT - DONE

after this state receives
s/b
after receiving

The ST_TTS state machine may maintain the timers listed in table 182.

Table 182 — ST_T state machine timers

Timer	Initial value
Initiator Response Timeout	The value in the INITIATOR RESPONSE TIMEOUT field in the Protocol-Specific Port mode page (see 10.2.7.4).

Author: RElliott
Subject: Highlight
Date: 8/30/2008 5:00:08 PM
ACCEPT - DONE



The ST_TTS state machine

s/b

This state machine

(should be ST_T not ST_TTS in any case)

Figure 216 shows the ST_T state machines.

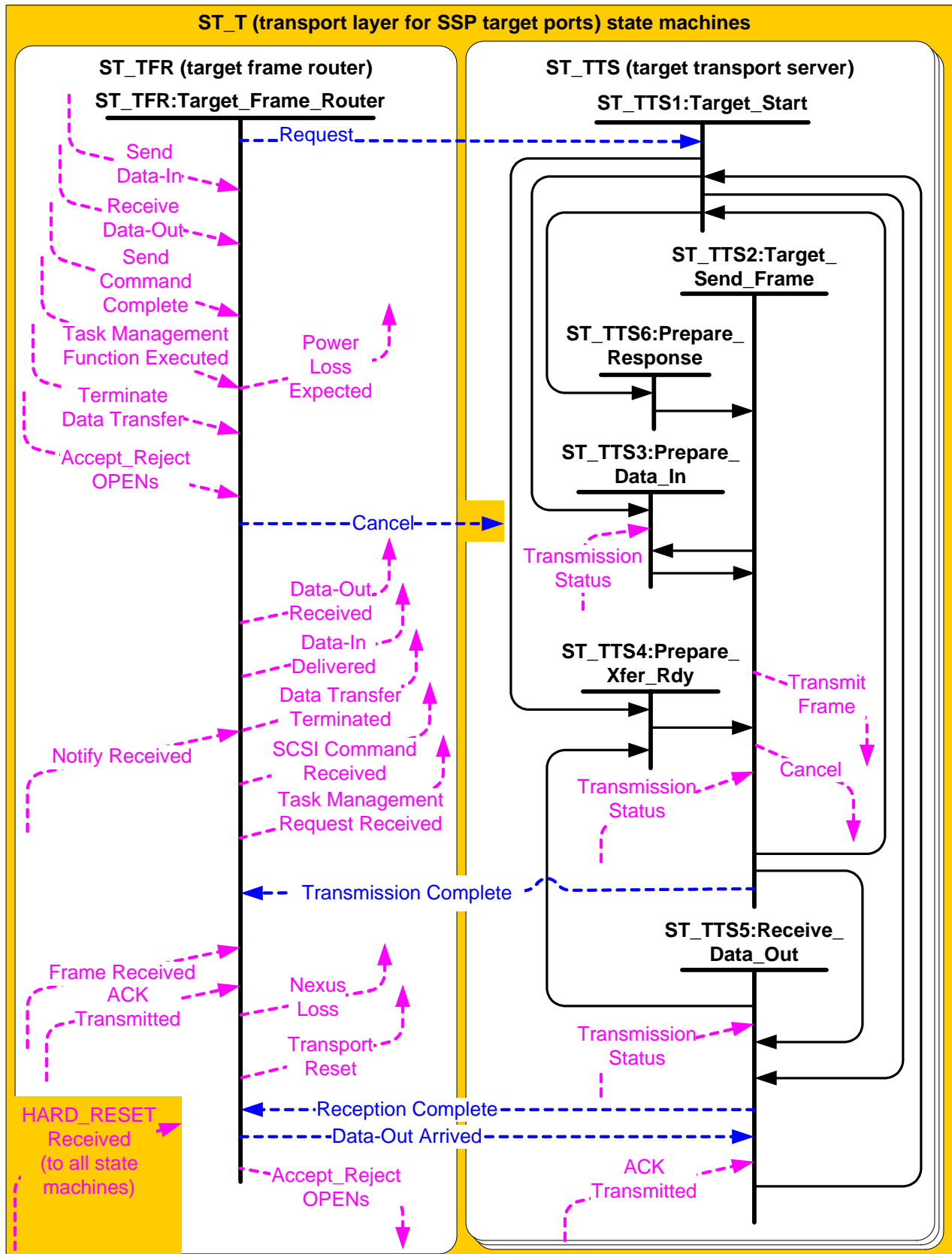

Figure 216 — ST_T (transport layer for SSP target ports) state machines

This page contains no comments

9.2.6.3.2 ST_TFR (target frame router) state machine

9.2.6.3.2.1 ST_TFR state machine overview

The ST_TFR state machine performs the following functions:

- a) receives confirmations from the port layer;
- b) receives transport protocol service requests from the SCSI application layer;
- c) sends transport protocol service indications to the SCSI application layer;
- d) sends messages to the ST_TTS state machine;
- e) receives messages from the ST_TTS state machine;
- f) receives Accept_Reject OPENs requests from the SCSI application layer;
- g) sends Accept_Reject OPENs requests to the port layer;
- h) sends Nexus Loss event notifications to the SCSI application layer;
- i) sends Transport Reset event notifications to the SCSI application layer; and
- j) sends Power Loss Expected event notifications to the SCSI application layer.

This state machine consists of one state.

This state machine shall be started after power on.

If this state receives a Notify Received (Power Loss Expected) confirmation, then this state shall:

- a) send a Cancel message to all the ST_TTS state machines; and
- b) send a Power Loss Expected confirmation to the SCSI application layer.

9.2.6.3.2.2 Processing Frame Received confirmations

If this state machine receives a Frame Received (ACK/NAK Balanced) or Frame Received (ACK/NAK Not Balanced) confirmation, then this state machine shall check the frame type in the received frame (see table 164 in 9.2.1). If the frame type is not COMMAND, TASK, or DATA, then this state machine shall discard the frame. If the confirmation was Frame Received (ACK/NAK Not Balanced) and the frame type is not DATA, then this state machine shall discard the frame.

This state machine may check that reserved fields in the received frame are zero. If reserved fields are checked and they are not set to zero, then this state machine shall send the following to an ST_TTS state machine that does not have an active task and discard the frame:

- a) a Request (Send Transport Response) message with the Transport Response arguments;
- b) the destination SAS address argument set to the SAS address from which the invalid frame was received; and
- c) the service response argument set to Invalid Frame.

The check of reserved fields within the frame shall not apply to the reserved fields within the CDB in a COMMAND frame. Checking of reserved fields in a CDB is described in SPC-4.

The following is the list of Transport Response arguments:

- a) connection rate;
- b) initiator connection tag;
- c) destination SAS address (i.e., the SAS address to which the RESPONSE frame is to be transmitted);
- d) source SAS address set to the SAS address of the SAS port containing the state machine;
- e) tag; and
- f) service response.

The response fence argument is not included in the Transport Response arguments.

If the frame type is correct relative to the Frame Received confirmation, then this state machine may check that the hashed source SAS address matches the SAS address of the SAS port that transmitted the frame and that the hashed destination SAS address matches the SAS address of the SAS port that received the frame based on the connection information. If this state machine checks these SAS addresses, and they do not match, then this state machine shall discard the frame.

Author: RElliott
Subject: Note
Date: 6/30/2008 6:16:52 PM
 ACCEPT - DONE

Add:

If non-zero values are not supported in the tlr control field in a COMMAND frame, then the tlr control field shall be treated as a reserved field.

to match an elx-bmartin comment in the COMMAND frame section TLR CONTROL field paragraphs

If the frame type is COMMAND or TASK then this state machine shall check the length of the information unit. If the length of the information unit is not correct, then this state machine shall send the following to an ST_TTS state machine that does not have an active task and discard the frame:

- a) a Request (Send Transport Response) message with the Transport Response arguments;
- b) the destination SAS address argument set to the SAS address from which the invalid frame was received; and
- c) the service response argument set to Invalid Frame.

If the frame type is TASK, this state machine checks tags, the RETRANSMIT bit in the new TASK frame is set to one, and the tag for the new TASK frame is the same as the tag for a previous TASK frame where the task management function for the previous TASK frame is not complete, then this state machine shall discard the new TASK frame and not send a Task Management Request Received confirmation to the SCSI application layer.

If the frame type is TASK and this state machine does not check tags, then this state machine shall ignore the RETRANSMIT bit.

If the frame type is COMMAND or TASK, then this state machine may check the target port transfer tag. If this state checks the target port transfer tag and the tag is set to a value other than FFFFh, then this state machine shall send the following to an ST_TTS state machine that does not have an active task and discard the frame:

- a) a Request (Send Transport Response) message with the Transport Response arguments;
- b) the destination SAS address argument set to the SAS address from which the invalid frame was received; and
- c) the service response argument set to Invalid Frame.

If the frame type is TASK, then this state machine shall check the logical unit number. If the logical unit number is unknown, then this state machine shall send the following to an ST_TTS state machine that does not have an active task and discard the frame:

- a) a Request (Send Transport Response) message with the Transport Response arguments;
- b) the destination SAS address argument set to the SAS address from which the invalid frame was received; and
- c) the service response argument set to Incorrect Logical Unit Number.

If the frame type is DATA and this frame is for first burst data or this state machine did not assign a target port transfer tag for the data transfer, then this state machine may check the target port transfer tag. If target port transfer tag is set to a value other than FFFFh, then this state machine shall send the following to an ST_TTS state machine that does not have an active task and discard the frame:

- a) a Request (Send Transport Response) message with the Transport Response arguments;
- b) the destination SAS address argument set to the SAS address from which the invalid frame was received; and
- c) the service response argument set to Invalid Frame.

If the frame type is COMMAND or TASK and the fields checked in the frame are correct, then this state machine shall wait to receive an ACK Transmitted confirmation.

If the frame type is COMMAND, the fields checked in the frame are correct, and this state machine receives an ACK Transmitted confirmation, then this state machine shall send a SCSI Command Received transport protocol service indication with the following arguments to the SCSI application layer:

- a) source SAS address (i.e., the SAS address that transmitted the COMMAND frame);
- b) tag;
- c) logical unit number;
- d) task attribute;
- e) task priority;
- f) CDB; and
- g) additional CDB bytes, if any.

● Author: RElliott
Subject: Highlight
Date: 6/30/2008 6:16:52 PM
T ACCEPT - DONE

the tag
s/b
it
to avoid confusing with the real "tag"

● Author: RElliott
Subject: Highlight
Date: 6/30/2008 6:16:52 PM
T ACCEPT - DONE

If target
s/b
If the target

If the frame type is TASK, the fields checked in the frame are correct, and this state machine receives an ACK Transmitted confirmation, then this state machine shall send a Task Management Request Received transport protocol service indication with the following arguments to the SCSI application layer:

- a) source SAS address (i.e., the SAS address that transmitted the TASK frame);
- b) tag;
- c) logical unit number;
- d) task management function; and
- e) tag of the task to be managed.

If the frame type is DATA, and the tag does not match a tag for an outstanding command performing write operations, then this state machine shall discard the frame.

If the frame type is DATA, and the tag matches a tag for an outstanding command performing write operations when first burst is disabled or for which no Transmission Complete (Xfer_Rdy Delivered) message has been received from an ST_TTS state machine, then this state machine shall discard the frame.

If the frame type is DATA and a target port transfer tag was received in a Transmission Complete (Xfer_Rdy Delivered) message, then this state machine shall check the target port transfer tag. If the target port transfer tag received in the DATA frame does not match the **Target Transport Tag** argument in the Transmission Complete (Xfer_Rdy Delivered) message, then this state machine shall discard the frame.

If the frame type is DATA and the fields checked in the frame are correct, and first burst is enabled or this state machine has received a Transmission Complete (Xfer_Rdy Delivered) from the ST_TTS state machine for the request, then this state machine shall send a Data-Out Arrived message to the ST_TTS state machine specified by the tag in the frame. The message shall include the content of the write DATA frame.

9.2.6.3.2.3 Processing transport protocol service requests and responses

If this state machine receives a Send Data-In transport protocol service request from the SCSI application layer, then this state machine shall send a Request (Send Data-In) message to an ST_TTS state machine that does not have an active task. The message shall include the following Data-In arguments:

- a) connection rate;
- b) initiator connection tag;
- c) destination SAS address (i.e., the SAS address to which the read DATA frame is to be transmitted);
- d) source SAS address set to the SAS address of the SSP target port;
- e) tag;
- f) device server buffer;
- g) request byte count; and
- h) application client buffer offset.

If this state machine receives a Receive Data-Out transport protocol service request from the SCSI application layer, then this state machine shall send a Request (Receive Data-Out) message to an ST_TTS state machine that does not have an active task. The message shall include the following Data-Out state machine arguments:

- a) connection rate;
- b) initiator connection tag;
- c) destination SAS address (i.e., the SAS address to which the XFER_RDY frame is to be transmitted);
- d) source SAS address set to the SAS address of the SSP target port;
- e) tag;
- f) device server buffer;
- g) **request byte count;**
- h) application client buffer offset; and
- i) target port transfer tag.

If first burst is enabled, then the Request (Receive Data_Out) message shall also include the Enable First Burst argument and First Burst Size argument. The First Burst Size argument shall be set to the first burst size from the Disconnect-Reconnect mode page (see 10.2.7.2.5).

● Author: RElliott
Subject: Highlight
Date: 6/30/2008 6:16:52 PM
T ACCEPT - DONE

Target Transport Tag
s/b
Target Port Transfer Tag

● Author: wdc-mevans
Subject: Highlight
Date: 6/27/2008 6:38:05 PM
T REJECT (why include all that in the simple list of arguments? It's not an example of anything being discussed here.)

request byte count;
s/b
request byte count (e.g., this value takes into account the value set in the MAXIMUM BURST SIZE field in the Disconnect-
Reconnect mode page).

If this state machine receives a Send Command Complete transport protocol service response from the SCSI application layer with the Service Response argument set to TASK COMPLETE, then this state machine shall send a Request (Send Application Response) message to the ST_TTS state machine specified by the tag. The message shall include the following Application Response arguments:

- a) connection rate;
- b) initiator connection tag;
- c) destination SAS address (i.e., the SAS address to which the RESPONSE frame is to be transmitted);
- d) source SAS address set to the SAS address of the SSP target port;
- e) tag;
- f) status;
- g) sense data, if any; and
- h) response fence.

If this state machine receives a Task Management Function Executed transport protocol service response from the SCSI application layer, then this state machine shall send the following to the ST_TTS state machine specified by the tag:

- a) a Request (Send Transport Response) message with the Transport Response arguments;
- b) the service response argument set as specified in table 183; and
- c) the response fence argument set to the Task Management Function Executed protocol service response Response Fence argument.

Table 183 specifies which argument to send with **Request (Send Transport Response)** based on the Service Response argument that was received.

Table 183 — Task Management Function Executed Service Response argument mapping to Request (Send Transport Response) service response argument

Task Management Function Executed protocol service response Service Response argument received	Request (Send Transport Response) message service response argument
FUNCTION COMPLETE	Task Management Function Complete
FUNCTION SUCCEEDED	Task Management Function Succeeded
FUNCTION REJECTED	Task Management Function Not Supported
INCORRECT LOGICAL UNIT NUMBER	Incorrect Logical Unit Number
SERVICE DELIVERY OR TARGET FAILURE - Overlapped Tag Attempted	Overlapped Tag Attempted

If this state machine receives a Terminate Data Transfer protocol service request from the SCSI application layer and this state machine has not sent a Request message to a ST_TTS state machine for the Send Data-In or Receive Data-Out protocol service request to which the Terminate Data Transfer request applies, then this state machine shall:

- 1) discard the Terminate Data Transfer request and any corresponding Send Data-In or Receive Data-Out request; and
- 2) send a Data Transfer Terminated protocol service confirmation to the SCSI application layer.

If this state machine receives a Terminate Data Transfer protocol service request from the SCSI application layer and this state machine has sent a Request message to a ST_TTS state machine for the Send Data-In protocol service request to which the Terminate Data Transfer request applies, then this state machine shall send a Cancel message to the ST_TTS state machine specified by the tag and the Send Data-In protocol service request.

If this state machine receives a Terminate Data Transfer protocol service request from the SCSI application layer and this state machine has sent a Request message to a ST_TTS state machine for the Receive Data-Out protocol service request to which the Terminate Data Transfer request applies, then this state

Author: RElliott
Subject: Highlight
Date: 8/30/2008 1:04:24 PM
ACCEPT - DONE



Request (Send Transport Response)
add
the and message
per 08-343

machine shall send a Cancel message to the ST_TTS state machine specified by the tag and the Receive Data-Out protocol service request.

This state machine receives Transmission Complete and Reception Complete messages that may result in this state machine sending a Nexus Loss event notification or a protocol service confirmation to the SCSI application layer. If this state machine receives a Transmission Complete (I_T Nexus Loss) message, then this state machine shall send a Nexus Loss event notification to the SCSI application layer. Table 184 defines messages received from ST_TTS state machines and the corresponding service confirmations, if any, that shall be sent upon receipt of the message.

Table 184 — Confirmations sent to the SCSI application layer (part 1 of 2)

Message received from ST_TTS state machine	Protocol service confirmation sent to SCSI application layer
Transmission Complete (Xfer_Rdy Delivered)	None
Transmission Complete (Response Delivered)	None
Transmission Complete (Response Failed) ^a	None
Transmission Complete (Data Transfer Terminated)	Data Transfer Terminated
Transmission Complete (Data-In Delivered)	Data-In Delivered with the Delivery Result argument set to DELIVERY SUCCESSFUL
Transmission Complete (Xfer_Rdy Failed, NAK Received)	Data-Out Received with the Delivery Result argument set to DELIVERY FAILURE - NAK RECEIVED
Transmission Complete (Xfer_Rdy Failed, ACK/NAK Timeout)	Data-Out Received with the Delivery Result argument set to DELIVERY FAILURE - CONNECTION FAILED
Transmission Complete (Xfer_Rdy Failed, Connection Failed)	Data-Out Received with the Delivery Result argument set to DELIVERY FAILURE - CONNECTION FAILED
Transmission Complete (Data-In Failed, NAK Received)	Data-In Delivered with the Delivery Result argument set to DELIVERY FAILURE - NAK RECEIVED
Transmission Complete (Data-In Failed, ACK/NAK Timeout)	Data-In Delivered with the Delivery Result argument set to DELIVERY FAILURE - CONNECTION FAILED
Transmission Complete (Data-In Failed, Connection Failed)	Data-In Delivered with the Delivery Result argument set to DELIVERY FAILURE - CONNECTION FAILED
Reception Complete (Data-Out Received)	Data-Out Received with the Delivery Result argument set to DELIVERY SUCCESSFUL
Reception Complete (Data Offset Error)	Data-Out Received with the Delivery Result argument set to DELIVERY FAILURE - DATA OFFSET ERROR
^a SAM-4 does not define a mechanism for the device server to determine the result of its Send Command Complete and Task Management Function Executed transport protocol service response calls.	

Author: RElliott

Subject: Note

Date: 7/17/2008 8:36:36 PM

 REFER PROTOCOL WG (7/17 George will write up)

(from George Penokie, LSI)

It looks like the Transmission Complete (Connection Failed) from ST_TTS disappeared (Table 188 — Additional messages sent to the ST_TFR state machine message). It should be in Table 184 — Confirmations sent to the SCSI application layer but are not.

Table 184 — Confirmations sent to the SCSI application layer (part 2 of 2)

Message received from ST_TTS state machine	Protocol service confirmation sent to SCSI application layer
Reception Complete (Too Much Write Data)	Data-Out Received with the Delivery Result argument set to DELIVERY FAILURE - TOO MUCH WRITE DATA
Reception Complete (Information Unit Too Short)	Data-Out Received with the Delivery Result argument set to DELIVERY FAILURE - INFORMATION UNIT TOO SHORT
Reception Complete (Initiator Response Timeout)	Data-Out Received with the Delivery Result argument set to DELIVERY FAILURE - INITIATOR RESPONSE TIMEOUT
Reception Complete (Data Transfer Terminated)	Data Transfer Terminated
^a SAM-4 does not define a mechanism for the device server to determine the result of its Send Command Complete and Task Management Function Executed transport protocol service response calls.	

Each protocol service confirmation shall include the tag as an argument.

9.2.6.3.2.4 Processing miscellaneous requests and confirmations

If this state machine receives an **Accept_Reject OPENs (Accept SSP) or** Accept_Reject OPENs (Reject SSP) request, then this state machine shall send a corresponding Accept_Reject OPENs request to the port layer.

If this state machine receives a HARD_RESET Received confirmation, then this state shall send a Transport Reset event notification to the SCSI application layer.

9.2.6.3.3 ST_TTS (target transport server) state machine

9.2.6.3.3.1 ST_TTS state machine overview

The ST_TTS state machine performs the following functions:

- a) receives and processes messages from the ST_TFR state machine;
- b) sends messages to the ST_TFR state machine;
- c) communicates with the port layer using requests and confirmations regarding frame transmission; and
- d) receives HARD_RESET Received confirmations from the port layer.

This state machine consists of the following states:

- a) ST_TTS1:Target_Start (see 9.2.6.3.3.2) (initial state);
- b) ST_TTS2:Target_Send_Frame (see 9.2.6.3.3.3);
- c) ST_TTS3:Prepare_Data_In (see 9.2.6.3.3.4);
- d) ST_TTS4:Prepare_Xfer_Rdy (see 9.2.6.3.3.5);
- e) ST_TTS5:Receive_Data_Out (see 9.2.6.3.3.6); and
- f) ST_TTS6:Prepare_Response (see 9.2.6.3.3.7).

This state machine shall start in the ST_TTS1:Target_Start state after power on.

If this state machine receives a HARD_RESET Received confirmation, then this state machine shall transition to the ST_TTS1:Target_Start state.

Author: RElliott
Subject: Highlight
Date: 8/30/2008 3:13:39 PM
ACCEPT - DONE

Accept_Reject OPENs (Accept SSP) or

add request in the spirit of 08-343

The state machine shall maintain the state machine variables defined in table 185.

Table 185 — ST_TTS state machine variables

State machine variable	Description
Read Data Offset	Offset into the application client's data-in buffer (i.e., the application client buffer for read data)
Balance Point Read Data Offset	Offset into the application client's data-in buffer (i.e., the application client buffer for read data) of last point at which the number of Transmission Status (ACK Received) confirmations or arguments was equal to the number of transmitted read DATA frames
Read Data Frames Transmitted	The number of Transmission Status (Frame Transmitted) confirmations received for read DATA frames
Read Data Frames ACKed	The number of Transmission Status (ACK Received) confirmations received for read DATA frames
Read Data Buffer End	One greater than the offset into the application client's data-in buffer (i.e., the application client buffer for read data) of the last location into which read data is to be placed.
Requested Write Data Offset	Device server requested offset in the application client buffer for write data
Requested Write Data Length	Amount of write data requested by the device server from the application client buffer
Write Data Offset	Offset into the application client's data-out buffer (i.e., the application client buffer containing write data)

This state machine shall maintain the state machine arguments defined in table 186.

Table 186 — ST_TTS state machine arguments

State machine argument	Description
Data-In	The Data-In arguments received in the Request (Send Data-In) message (see 9.2.6.3.2.3)
Data-Out	The Data-Out arguments received in the Request (Receive Data-Out) message (see 9.2.6.3.2.3)

9.2.6.3.3.2 ST_TTS1:Target_Start state

9.2.6.3.3.2.1 State description

This state is the initial state of the ST_TTS state machine.

Upon entry into this state, this state shall:

- a) set the Read Data Offset state machine variable to the Application Client Buffer Offset Data-In state machine argument;
- b) set the Balance Point Read Data Offset state machine variable to the Application Client Buffer Offset Data-In state machine argument;
- c) set the Read Data Frames Transmitted state machine variable to zero;
- d) set the Read Data Frames ACKed state machine variable to zero;
- e) set the Read Data Buffer End state machine variable to the Application Client Buffer Offset Data-In state machine argument plus the Request Byte Count Data-In state machine argument; and

● Author: Isi-gpenokie
Subject: Sticky Note
Date: 6/30/2008 5:56:47 PM



REJECT (the convention is: Use all sentences or all partial sentences on one table, try not to mix. If there is more than one sentence in any table entry, then they all get periods. If each of them is less than one sentence, then they forgo periods. This is easily broken when descriptors are reworded; ending each with a period would make it consistent, but that's bad grammar for partial sentences. This table, for example, does not have full sentences (just subjects), so periods don't belong.)

Global

The descriptions in the tables are all over the place when it comes to if there is a period or not after the description. I suggest if the description is a complete sentence then it should have a period at the end. There are many cases where that is not the case and many cases where it is. This, at least, should be consistent.

- f) set the Requested Write Data Offset state machine variable to the Application Client Buffer Offset Data-Out state machine argument.

If this state was entered without an Enable First Burst Data-Out state machine argument, then the Requested Write Data Length state machine variable shall be set to the Request Byte Count Data-Out state machine argument.

If this state was entered with an Enable First Burst Data-Out state machine argument, then the Requested Write Data Length state machine variable shall be set to the First Burst Size Data-Out state machine argument.

9.2.6.3.3.2.2 Transition ST_TTS1:Target_Start to ST_TTS2:Prepare_Data_In

This transition shall occur **after this state receives** a Request (Send Data-In) message.

9.2.6.3.3.2.3 Transition ST_TTS1:Target_Start to ST_TTS4:Prepare_Xfer_Rdy

If this state was entered without an Enable First Burst Data-Out state machine argument, then this transition shall occur after a Request (Receive Data-Out) message is received.

9.2.6.3.3.2.4 Transition ST_TTS1:Target_Start to ST_TTS5:Receive_Data_Out

If this state was entered with an Enable First Burst Data-Out state machine argument, then this transition shall occur after a Request (Receive Data-Out) message is received.

9.2.6.3.3.2.5 Transition ST_TTS1:Target_Start to ST_TTS7:Prepare_Response

This transition shall occur **after this state receives** a Request (Send Transport Response) message.

The transition shall include the Transport Response arguments.

9.2.6.3.3.3 ST_TTS2:Target_Send_Frame state

9.2.6.3.3.3.1 State description

If this state is entered from the ST_TTS3:Prepare_Data_In state for transmission of a read DATA frame, then this state shall send a Transmit Frame (Non-Interlocked) request to the port layer.

If this state is entered from the ST_TTS4:Prepare_Xfer_Rdy state for transmission of an XFER_RDY frame, then this state shall send a Transmit Frame (Interlocked) request to the port layer.

If this state is entered from the ST_TTS6:Prepare_Response state for transmission of a RESPONSE frame, then this state shall send a Transmit Frame (Interlocked) request to the port layer.

All Transmit Frame requests from this state shall include the read DATA frame from the ST_TTS3:Prepare_Data_In state, the XFER_RDY frame from the ST_TTS4:Prepare_Xfer_Rdy state, or the RESPONSE frame from the ST_TTS6:Prepare_Response state and the following arguments to be used for any OPEN address frame:

- a) initiator port bit set to zero;
- b) protocol set to SSP;
- c) Connection Rate argument;
- d) Initiator Connection Tag argument;
- e) Destination SAS Address argument; and
- f) Source SAS Address argument.

After sending a Transmit Frame request this state shall wait to receive a Transmission Status confirmation.

If the confirmation or argument is Transmission Status (I_T Nexus Loss), then this state shall send a Transmission Complete (I_T Nexus Loss) message to the ST_TFR state machine. The Transmission Complete message shall include the tag as an argument.

● Author: RElliott
Subject: Highlight
Date: 6/30/2008 6:16:52 PM
T ACCEPT - DONE

after this state receives
s/b
after receiving

● Author: RElliott
Subject: Highlight
Date: 6/30/2008 6:16:52 PM
T ACCEPT - DONE

after this state receives
s/b
after receiving

If the confirmation or argument is not Transmission Status (Frame Transmitted) or Transmission Status (I_T Nexus Loss), then this state shall send the Transmission Complete message defined in table 187 to the ST_TFR state machine. The message shall include the following arguments:

- a) tag; and
- b) arguments received with the Transmission Status confirmation.

If the confirmation is Transmission Status (Frame Transmitted) and the Transmit Frame request was for:

- a) an XFER_RDY frame; or
- b) a RESPONSE frame,

then this state shall wait to receive one of the following confirmations:

- a) Transmission Status (ACK Received);
- b) Transmission Status (NAK Received);
- c) Transmission Status (ACK/NAK Timeout); or
- d) Transmission Status (Connection Lost Without ACK/NAK).

If the confirmation is Transmission Status (Frame Transmitted) and the Transmit Frame request was for a read DATA frame, then this state shall:

- a) increment the Read Data Frames Transmitted state machine variable by one; and
- b) set the Read Data Offset state machine variable to the current Read Data Offset state machine variable plus the number of read data bytes transmitted in the DATA frame associated with the Transmission Status (Frame Transmitted) confirmation.

If the confirmation is Transmission Status (ACK Received) and the Transmit Frame request was for a read DATA frame, then this state shall increment the Read Data Frames ACKed state machine variable by one.

If the confirmation is Transmission Status (Frame Transmitted), the Transmit Frame request was for a read DATA frame, and the Read Data Offset state machine variable is equal to the Read Data Buffer End state machine variable, then this state shall wait to receive:

- a) Transmission Status (ACK Received) confirmations or arguments for each outstanding read DATA frame (i.e., Read Data Frames Transmitted state machine variable equals the Read Data Frames ACKed state machine variable); or
- b) one of **the following**:
 - A) Transmission Status (NAK Received);
 - B) Transmission Status (ACK/NAK Timeout); or
 - C) Transmission Status (Connection Lost Without ACK/NAK).

NOTE 96 - If the number of data bytes that have been transmitted for a Request (Send Data-In) message are fewer than the Request Byte Count Data-In state machine argument, then this state transitions to the ST_TTS3:Prepare_Data_In state to construct the additional read DATA frames for the request before receiving a Transmission Status (ACK Received), Transmission Status (NAK Received), Transmission Status (ACK/NAK Timeout), or Transmission Status (Connection Lost Without ACK/NAK) confirmation.

When the Read Data Frames Transmitted state machine variable equals the Read Data Frames ACKed state machine variable and the Transmit Frame request was for a read DATA frame, this state shall:

- a) not modify the Balance Point Read Data Offset state machine variable (i.e., the balance point remains at the last point at which balance occurred); or
- b) set the Balance Point Read Data Offset state machine variable to the current Read Data Offset state machine variable.

If the Transmit Frame request was for a RESPONSE frame, the vendor-specific number of retries has not been reached, and this state receives one of the following confirmations:

- a) Transmission Status (NAK Received);
- b) Transmission Status (ACK/NAK Timeout); or
- c) Transmission Status (Connection Lost Without ACK/NAK),

Author: RElliott
Subject: Highlight
Date: 8/30/2008 1:05:16 PM
ACCEPT - DONE

the following
s/b
the following confirmations

per 08-343

then this state shall:

- a) set the RETRANSMIT bit to one;
- b) set the other fields to the same values as contained in the failed RESPONSE frame; and
- c) resend a Transmit Frame (Interlocked) request to the port layer for the failed RESPONSE frame.

If transport layer retries are enabled, the Transmit Frame request was for a XFER_RDY frame, the vendor-specific number of retries has not been reached, and this state receives one of the following confirmations:

- a) Transmission Status (NAK Received);
- b) Transmission Status (ACK/NAK Timeout); or
- c) Transmission Status (Connection Lost Without ACK/NAK),

then this state shall:

- a) set the RETRANSMIT bit to one;
- b) set the TARGET PORT TRANSFER TAG field to a value that is different than the target port transfer tag in the previous XFER_RDY frame associated with the Data-Out state machine arguments and is different than any other target port transfer tag currently in use. If write data is received for a subsequent XFER_RDY frame for a command, then all target port transfer tags used for previous XFER_RDY frames for the command are no longer in use;
- c) set the other fields to the same values contained in the failed XFER_RDY frame; and
- d) resend a Transmit Frame (Interlocked) request to the port layer for the failed XFER_RDY frame.

This page contains no comments

Table 187 defines messages that this state shall send to the ST_TFR state machine upon receipt of the listed confirmations and arguments, based on the conditions under which each confirmation or argument was received.

Table 187 — Messages sent to the ST_TFR state machine

Confirmation received from the port layer or argument received from ST_TTS3:Prepare_Data_In	Conditions under which confirmation was received	Message sent to the ST_TFR state machine
Transmission Status (ACK Received)	The Transmit Frame request was for an XFER_RDY frame.	Transmission Complete (Xfer_Rdy Delivered) with a Target Port Transfer Tag argument
	Transmit Frame request was for a RESPONSE frame	Transmission Complete (Response Delivered)
	The Transmit Frame request was for a read DATA frame and: <ul style="list-style-type: none"> a) the Read Data Offset state machine variable is equal to the Read Data Buffer End state machine variable; and b) the Read Data Offset state machine variable is equal to the Balance Point Read Data Offset state machine variable. 	Transmission Complete (Data-In Delivered)
Transmission Status (NAK Received), Transmission Status (ACK/NAK Timeout), or Transmission Status (Connection Lost Without ACK/NAK)	The Transmit Frame request was for a RESPONSE frame and the vendor-specific number of retries has been reached.	Transmission Complete (Response Failed)
Transmission Status (NAK Received)	The Transmit Frame request was for an XFER_RDY frame and: <ul style="list-style-type: none"> a) if transport layer retries are disabled; or b) if transport layer retries are enabled and the vendor-specific number of retries has been reached. 	Transmission Complete (Xfer_Rdy Failed, NAK Received)
Transmission Status (ACK/NAK Timeout) or Transmission Status (Connection Lost Without ACK/NAK)		Transmission Complete (Xfer_Rdy Failed, Connection Failed)
Transmission Status (NAK Received)	The Transmit Frame request was for a read DATA frame and: <ul style="list-style-type: none"> a) if transport layer retries are disabled; or b) if transport layer retries are enabled and the vendor-specific number of retries has been reached. 	Transmission Complete (Data-In Failed, NAK Received)
Transmission Status (ACK/NAK Timeout) or Transmission Status (Connection Lost Without ACK/NAK)		Transmission Complete (Data-In Failed, Connection Failed)

Author: Isi-gpenokie
Subject: Highlight
Date: 5/6/2008 4:07:50 PM

T ACCEPT - DONE (also added "The" at the beginning)

Change << RESPONSE frame >> to << RESPONSE frame. >>. Period added.

Table 188 defines messages that this state shall send to the ST_TFR state machine upon receipt of the listed confirmations and arguments.

Table 188 — Additional messages sent to the ST_TFR state machine

Confirmation received from the port layer or argument received from ST_TTS3:Prepare_Data_In	Message sent to the ST_TFR state machine
Transmission Status (Bad Destination)	Transmission Complete (Connection Failed)
Transmission Status (Connection Rate Not Supported)	Transmission Complete (Connection Failed)
Transmission Status (Protocol Not Supported)	Transmission Complete (Connection Failed)
Transmission Status (Reserved Abandon 1)	Transmission Complete (Connection Failed)
Transmission Status (Reserved Abandon 2)	Transmission Complete (Connection Failed)
Transmission Status (Reserved Abandon 3)	Transmission Complete (Connection Failed)
Transmission Status (STP Resources Busy)	Transmission Complete (Connection Failed)
Transmission Status (Wrong Destination)	Transmission Complete (Connection Failed)
Transmission Status (Zone Violation)	Transmission Complete (Connection Failed)
Transmission Status (Break Received)	Transmission Complete (Data Transfer Terminated)

If this state receives a Cancel message or a Cancel argument and this state has received confirmations for all Transmit Frame requests sent to the port layer, then this state shall send a Transmission Complete (Data Transfer Terminated) message to the ST_TFR state machine.

If this state receives a Cancel message or a Cancel argument and this state has not received confirmations for all Transmit Frame requests sent to the port layer, then this state shall send a Cancel request to the port layer to cancel previous Transmit Frame requests. The Cancel request shall include the following arguments:

- a) destination SAS address; and
- b) tag.

Upon receipt of a Transmission Status (Cancel Acknowledged) confirmation or argument this state shall send a Transmission Complete (Data Transfer Terminated) message to the ST_TFR state machine.

A Transmission Complete message to the ST_TFR state machine shall include the following arguments:

- a) destination SAS address; and
- b) tag.

9.2.6.3.3.2 Transition ST_TTS2:Target_Send_Frame to ST_TTS1:Target_Start

This transition shall occur **after this state sends** a Transmission Complete message other than **Transmission Complete (Xfer_Rdy Delivered)** to the ST_TFR state machine.

9.2.6.3.3.3 Transition ST_TTS2:Target_Send_Frame to ST_TTS3:Prepare_Data_In

This transition shall occur **after this state receives** a Transmission Status (Frame Transmitted) confirmation for a read DATA frame if the Read Data Offset state machine variable is less than the Read Data Buffer End state machine variable (i.e., there is more read data to transfer).

If transport layer retries are enabled and the vendor-specific number of retries, if any, for the read DATA frame has not been reached, **this** transition shall occur and include a Retry argument **after this state receives** one of the following confirmations for a read DATA frame:

- a) Transmission Status (NAK Received);
- b) Transmission Status (ACK/NAK Timeout); or

● Author: RElliott
Subject: Highlight
Date: 6/30/2008 6:16:52 PM
T ACCEPT - DONE

after this state sends
s/b
after sending

● Author: RElliott
Subject: Highlight
Date: 8/30/2008 1:07:07 PM
T ACCEPT - DONE

Transmission Complete (Xfer_Rdy Delivered)
add the and message
per 08-343

● Author: RElliott
Subject: Highlight
Date: 6/30/2008 6:16:52 PM
T ACCEPT - DONE

after this state receives
s/b
after receiving

● Author: RElliott
Subject: Highlight
Date: 6/30/2008 6:16:52 PM
T ACCEPT - DONE

after this state receives
s/b
after receiving

● Author: RElliott
Subject: Highlight
Date: 6/30/2008 6:16:52 PM
T ACCEPT - DONE

this
s/b
then this

- c) Transmission Status (Connection Lost Without ACK/NAK).

9.2.6.3.3.3.4 Transition ST_TTS2:Target_Send_Frame to ST_TTS5:Receive_Data_Out

This transition shall occur **after this state sends** a Transmission Complete (Xfer_Rdy Delivered) message to the ST_TFR state machine.

9.2.6.3.3.4 ST_TTS3:Prepare_Data_In state

9.2.6.3.3.4.1 State description

This state retrieves the data from the Device Server Buffer Data-In state machine argument and constructs a read DATA frame.

This state shall construct a read DATA frame using the Data-In state machine arguments as follows:

- a) FRAME TYPE field set to 01h (i.e., DATA frame);
- b) HASHED DESTINATION SAS ADDRESS field set to the hashed value of the Destination SAS Address Data-In state machine argument;
- c) HASHED SOURCE SAS ADDRESS field set to the hashed value of the SSP target port's SAS address;
- d) RETRY DATA FRAMES bit set to zero;
- e) RETRANSMIT bit set to zero;
- f) CHANGING DATA POINTER set as specified in this subclause;
- g) NUMBER OF FILL BYTES field set to the number of fill bytes needed for the specified read data;
- h) TAG field set to the Tag Data-In state machine argument;
- i) TARGET PORT TRANSFER TAG field set to a vendor-specific value;
- j) DATA OFFSET field set as specified in this subclause;
- k) in the information unit, DATA field set as specified in this subclause; and
- l) fill bytes, if required.

If this state is entered without a Retry argument then this state shall:

- a) set the CHANGING DATA POINTER bit set to zero;
- b) set the DATA OFFSET field to the Read Data Offset state machine variable; and
- c) in the information unit, set the DATA field to the information in the Device Server Buffer argument that corresponds to the read data to be transferred. **If the Read Data Buffer End state machine variable minus the Read Data Offset state machine variable is equal to the maximum size of the read Data information unit, the amount of data shall be the maximum size of the read Data information unit. Otherwise, the amount of data shall be the lesser of:**
 - A) the Read Data Buffer End state machine variable minus the Read Data Offset state machine variable; and**
 - B) the maximum size of the read Data information unit for this Data-In request.**

If this state is entered with a Retry argument then this state shall either: 

- a) set the CHANGING DATA POINTER bit in the frame to one;
- b) set the DATA OFFSET field to the Balance Point Read Data Offset state machine variable;
- c) set the Read Data Offset state machine variable to the Balance Point Read Data Offset state machine variable;
- d) set the Read Data Frames Transmitted state machine variable to zero;
- e) set the Read Data Frames ACKed state machine variable to zero; and
- f) in the information unit, set the DATA field to the information in the Device Server Buffer argument that corresponds to the read data to be transferred. **If the Read Data Buffer End state machine variable minus the Read Data Offset state machine variable is equal to the maximum size of the read Data information unit, the amount of data shall be the maximum size of the read Data information unit. Otherwise, the amount of data shall be the lesser of:**
 - A) the Read Data Buffer End state machine variable minus the Balance Point Read Data Offset state machine variable; and**
 - B) the maximum size of the read Data information unit for this Data-In request;**

or:

- a) set the CHANGING DATA POINTER bit in the frame to one; 

Author: RElliott
Subject: Highlight
Date: 6/30/2008 6:16:52 PM
 ACCEPT - DONE

after this state sends
s/b
after sending

Author: wdc-mevans
Subject: Highlight
Date: 6/27/2008 6:40:28 PM

 REJECT (this is the state machine, so referring to the state machine variables is appropriate)

If the Read Data Buffer End state machine variable minus the Read Data Offset state machine variable is equal to the maximum size of the read Data information unit, the amount of data shall be the maximum size of the read Data information unit. Otherwise, the amount of data shall be the lesser of:

A) the Read Data Buffer End state machine variable minus the Read Data Offset state machine variable; and

B) the maximum size of the read Data information unit for this Data-In request.

s/b

The number of bytes in the DATA field shall be less than or equal to the maximum number of bytes of the field. If the DATA frame does not contain the last data for the transfer, then the number of bytes contained in the DATA field shall be a multiple of four. If the DATA frame contains the last data for the transfer, then the number of bytes contained in the DATA field may not be a multiple of four.

Author: RElliott
Subject: Note
Date: 8/30/2008 1:07:59 PM

 ACCEPT - DONE

Data-In request
s/b
Send Data-In request
per 08-343

Author: wdc-mevans
Subject: Highlight
Date: 6/27/2008 6:40:33 PM

 REJECT (this is the state machine, so referring to the state machine variables is appropriate)

If the Read Data Buffer End state machine variable minus the Read Data Offset state machine variable is equal to the maximum size of the read Data information unit, the amount of data shall be the maximum size of the read Data information unit. Otherwise, the amount of data shall be the lesser of:

A) the Read Data Buffer End state machine variable minus the Balance Point Read Data Offset state machine variable; and

B) the maximum size of the read Data information unit for this Data-In request

s/b

The number of bytes in the DATA field shall be less than or equal to the maximum number of bytes of the field. If the DATA frame does not contain the last data for the transfer, then the number of bytes contained in the DATA field shall be a multiple of four. If the DATA frame contains the last data for the transfer, then the number of bytes contained in the DATA field may not be a multiple of four.

Author: RElliott
Subject: Note
Date: 8/30/2008 1:08:07 PM

 ACCEPT - DONE

- c) Transmission Status (Connection Lost Without ACK/NAK).

9.2.6.3.3.3.4 Transition ST_TTS2:Target_Send_Frame to ST_TTS5:Receive_Data_Out

This transition shall occur **after this state sends** a Transmission Complete (Xfer_Rdy Delivered) message to the ST_TFR state machine.

9.2.6.3.3.4 ST_TTS3:Prepare_Data_In state

9.2.6.3.3.4.1 State description

This state retrieves the data from the Device Server Buffer Data-In state machine argument and constructs a read DATA frame.

This state shall construct a read DATA frame using the Data-In state machine arguments as follows:

- a) FRAME TYPE field set to 01h (i.e., DATA frame);
- b) HASHED DESTINATION SAS ADDRESS field set to the hashed value of the Destination SAS Address Data-In state machine argument;
- c) HASHED SOURCE SAS ADDRESS field set to the hashed value of the SSP target port's SAS address;
- d) RETRY DATA FRAMES bit set to zero;
- e) RETRANSMIT bit set to zero;
- f) CHANGING DATA POINTER set as specified in this subclause;
- g) NUMBER OF FILL BYTES field set to the number of fill bytes needed for the specified read data;
- h) TAG field set to the Tag Data-In state machine argument;
- i) TARGET PORT TRANSFER TAG field set to a vendor-specific value;
- j) DATA OFFSET field set as specified in this subclause;
- k) in the information unit, DATA field set as specified in this subclause; and
- l) fill bytes, if required.

If this state is entered without a Retry argument then this state shall:

- a) set the CHANGING DATA POINTER bit set to zero;
- b) set the DATA OFFSET field to the Read Data Offset state machine variable; and
- c) in the information unit, set the DATA field to the information in the Device Server Buffer argument that corresponds to the read data to be transferred. **If the Read Data Buffer End state machine variable minus the Read Data Offset state machine variable is equal to the maximum size of the read Data information unit, the amount of data shall be the maximum size of the read Data information unit. Otherwise, the amount of data shall be the lesser of:**
 - A) **the Read Data Buffer End state machine variable minus the Read Data Offset state machine variable; and**
 - B) **the maximum size of the read Data information unit for this Data-In request.**

If this state is entered with a Retry argument then this state shall either: 

- a) set the CHANGING DATA POINTER bit in the frame to one;
- b) set the DATA OFFSET field to the Balance Point Read Data Offset state machine variable;
- c) set the Read Data Offset state machine variable to the Balance Point Read Data Offset state machine variable;
- d) set the Read Data Frames Transmitted state machine variable to zero;
- e) set the Read Data Frames ACKed state machine variable to zero; and
- f) in the information unit, set the DATA field to the information in the Device Server Buffer argument that corresponds to the read data to be transferred. **If the Read Data Buffer End state machine variable minus the Read Data Offset state machine variable is equal to the maximum size of the read Data information unit, the amount of data shall be the maximum size of the read Data information unit. Otherwise, the amount of data shall be the lesser of:**
 - A) **the Read Data Buffer End state machine variable minus the Balance Point Read Data Offset state machine variable; and**
 - B) **the maximum size of the read Data information unit for this Data-In request;**

or:

- a) set the CHANGING DATA POINTER bit in the frame to one; 

Data-In request
s/b
Send Data-In request
per 08-343

- b) set the DATA OFFSET field to the Application Client Buffer Offset Data-In state machine argument;
- c) set the Read Data Offset state machine variable to the Application Client Buffer Offset Data-In state machine argument;
- d) set the Read Data Frames Transmitted state machine variable to zero;
- e) set the Read Data Frames ACKed state machine variable to zero; and
- f) in the information unit, set the DATA field to the information in the Device Server Buffer argument that corresponds to the read data to be transferred. If the Request Byte Count Data-In state machine argument is equal to the maximum size of the read Data information unit, the amount of data shall be the maximum size of the read Data information unit. Otherwise, the amount of data shall be the lesser of:
 - A) the Request Byte Count Data-In state machine argument; and
 - B) the maximum size of the read Data information unit for this Data-In request.

9.2.6.3.3.4.2 Transition ST_TTS3:Prepare_Data_In to ST_TTS2:Target_Send_Frame

This transition shall occur after this state:

- a) constructs a read DATA frame; or
- b) receives a Cancel message.

This transition shall include the received Transmission Status, if any, as an argument and the:

- a) read DATA frame as an argument; or
- b) if a Cancel message was received, then a Cancel argument.

9.2.6.3.3.5 ST_TTS4:Prepare_Xfer_Rdy state

9.2.6.3.3.5.1 State description

This state shall construct an XFER_RDY frame using the Data-Out state machine arguments:

- a) FRAME TYPE field set to 05h (i.e., XFER_RDY frame);
- b) HASHED DESTINATION SAS ADDRESS field set to the hashed value of the Destination SAS Address Data-Out state machine argument;
- c) HASHED SOURCE SAS ADDRESS field set to the hashed value of the SSP target port's SAS address;
- d) RETRY DATA FRAMES bit set to one if transport layer retries are enabled and zero if transport layer retries are disabled;
- e) RETRANSMIT bit set to zero;
- f) CHANGING DATA POINTER bit set to zero;
- g) NUMBER OF FILL BYTES field set to zero;
- h) TAG field set to the Tag Data-Out state machine argument;
- i) if transport layer retries are disabled, TARGET PORT TRANSFER TAG field set to a vendor-specific value;
- j) if transport layer retries are enabled, TARGET PORT TRANSFER TAG field set to a vendor-specific value that is different from:
 - A) the target port transfer tag in the previous XFER_RDY frame associated with the Data-Out state machine arguments; and
 - B) any other target port transfer tag currently in use.

If write data is received for a subsequent XFER_RDY frame for a command, then all target port transfer tags used for previous XFER_RDY frames for the command are no longer in use;

- k) DATA OFFSET field set to zero; and
- l) in the information unit, REQUESTED OFFSET field set to the Requested Write Data Offset state machine variable;
- m) in the information unit, WRITE DATA LENGTH field set as specified in this subclause; and
- n) no fill bytes.

If the SSP target port has the resources available to receive all of the write data as indicated by the Requested Write Data Length state machine variable, then this state shall set the WRITE DATA LENGTH field in the XFER_RDY information unit to the Requested Write Data Length state machine variable.

Page: 495

Author: wdc-mevans
Subject: Highlight
Date: 6/27/2008 6:39:57 PM

 REJECT (this is a state machine, so referring to the state machine variables is appropriate)

If the Request Byte Count Data-In state machine argument is equal to the maximum size of the read Data information unit, the amount of data shall be the maximum size of the read Data information unit. Otherwise, the amount of data shall be the lesser of:

- A) the Request Byte Count Data-In state machine argument; and
- B) the maximum size of the read Data information unit for this Data-In request.

s/b

The number of bytes in the DATA field shall be less than or equal to the maximum number of bytes of the field. If the DATA frame does not contain the last data for the transfer, then the number of bytes contained in the DATA field shall be a multiple of four. If the DATA frame contains the last data for the transfer, then the number of bytes contained in the DATA field may not be a multiple of four.

Author: RElliott
Subject: Note
Date: 8/30/2008 1:08:15 PM

 ACCEPT - DONE

Data-In request

s/b

Send Data-In request
per 08-343

Author: RElliott
Subject: Underline
Date: 6/30/2008 6:16:52 PM

 ACCEPT - DONE

read DATA frame

s/b

if a Cancel message was not received, then the read DATA frame

Author: lsi-gpenokie
Subject: Highlight
Date: 6/27/2008 6:25:11 PM

 REJECT (no, only one is included. The "and" before the list is purposely different. See added comment.)

This << or >> should be a << and >>.

Author: RElliott
Subject: Underline
Date: 6/30/2008 6:16:52 PM

 ACCEPT - DONE

zero

s/b

00b

Author: lsi-gpenokie
Subject: Cross-Out
Date: 5/6/2008 4:07:50 PM

 ACCEPT - DONE

Delete extra << and >>

Author: RElliott
Subject: Highlight

Comments from page 495 continued on next page

- b) set the DATA OFFSET field to the Application Client Buffer Offset Data-In state machine argument;
- c) set the Read Data Offset state machine variable to the Application Client Buffer Offset Data-In state machine argument;
- d) set the Read Data Frames Transmitted state machine variable to zero;
- e) set the Read Data Frames ACKed state machine variable to zero; and
- f) in the information unit, set the DATA field to the information in the Device Server Buffer argument that corresponds to the read data to be transferred. If the Request Byte Count Data-In state machine argument is equal to the maximum size of the read Data information unit, the amount of data shall be the maximum size of the read Data information unit. Otherwise, the amount of data shall be the lesser of:
 - A) the Request Byte Count Data-In state machine argument; and
 - B) the maximum size of the read Data information unit for this Data-In request.

9.2.6.3.3.4.2 Transition ST_TTS3:Prepare_Data_In to ST_TTS2:Target_Send_Frame

This transition shall occur after this state:

- a) constructs a read DATA frame; or
- b) receives a Cancel message.

This transition shall include the received Transmission Status, if any, as an argument and the:

- a) read DATA frame as an argument; or
- b) if a Cancel message was received, then a Cancel argument.

9.2.6.3.3.5 ST_TTS4:Prepare_Xfer_Rdy state

9.2.6.3.3.5.1 State description

This state shall construct an XFER_RDY frame using the Data-Out state machine arguments:

- a) FRAME TYPE field set to 05h (i.e., XFER_RDY frame);
- b) HASHED DESTINATION SAS ADDRESS field set to the hashed value of the Destination SAS Address Data-Out state machine argument;
- c) HASHED SOURCE SAS ADDRESS field set to the hashed value of the SSP target port's SAS address;
- d) RETRY DATA FRAMES bit set to one if transport layer retries are enabled and zero if transport layer retries are disabled;
- e) RETRANSMIT bit set to zero;
- f) CHANGING DATA POINTER bit set to zero;
- g) NUMBER OF FILL BYTES field set to zero;
- h) TAG field set to the Tag Data-Out state machine argument;
- i) if transport layer retries are disabled, TARGET PORT TRANSFER TAG field set to a vendor-specific value;
- j) if transport layer retries are enabled, TARGET PORT TRANSFER TAG field set to a vendor-specific value that is different from:
 - A) the target port transfer tag in the previous XFER_RDY frame associated with the Data-Out state machine arguments; and
 - B) any other target port transfer tag currently in use.

If write data is received for a subsequent XFER_RDY frame for a command, then all target port transfer tags used for previous XFER_RDY frames for the command are no longer in use;

- k) DATA OFFSET field set to zero; and
- l) in the information unit, REQUESTED OFFSET field set to the Requested Write Data Offset state machine variable;
- m) in the information unit, WRITE DATA LENGTH field set as specified in this subclause; and
- n) no fill bytes.

If the SSP target port has the resources available to receive all of the write data as indicated by the Requested Write Data Length state machine variable, then this state shall set the WRITE DATA LENGTH field in the XFER_RDY information unit to the Requested Write Data Length state machine variable.

Date: 6/30/2008 6:16:52 PM

 ACCEPT - DONE

zero

s/b

00000000h

If the SSP target port does not have the resources available to receive all of the write data as indicated by the Requested Write Data Length state machine variable (e.g., the SSP target port has a **vendor specific limit** as to how much write data may be received during one operation), then this state shall set the WRITE DATA LENGTH field in the XFER_RDY information unit and the Requested Write Data Length state machine variable to a value representing the amount of write data for which the SSP target port has available resources to receive.

9.2.6.3.3.5.2 Transition ST_TTS4:Prepare_Xfer_Rdy to ST_TTS2:Target_Send_Frame

This transition shall occur after this state:

- a) constructs an XFER_RDY frame; or
- b) receives a Cancel message.

This transition shall include **the**:



- a) if a Cancel message was received, then a Cancel argument; **or**
- b) XFER_RDY frame as an argument.

9.2.6.3.3.6 ST_TTS5:Receive_Data_Out state

9.2.6.3.3.6.1 State description

Upon entry into this state, the Write Data Offset state machine variable is set to the Requested Write Data Offset state machine variable.

If this state receives a Data-Out Arrived message, then this state shall verify the write DATA frame received with the Data-Out Arrived values as specified in table 189. If the verification test fails, then this state sends the message specified in table 189 to the ST_TFR state machine.

Table 189 — Reception Complete message for write DATA frame verification failures

Message sent to ST_TFR ^a	Condition
Reception Complete (Data Offset Error)	Transport layer retries are disabled, and the DATA OFFSET field is not equal to the Write Data Offset state machine variable.
	The DATA OFFSET field is: a) less than the Requested Write Data Offset state machine variable; or b) greater than or equal to the Requested Write Data Offset state machine variable plus the Requested Write Data Length state machine variable.
Reception Complete (Too Much Write Data)	The number of bytes in the DATA field in the write Data information unit plus the Write Data Offset state machine variable is greater than the Request Byte Count Data-Out state machine argument.
Reception Complete (Information Unit Too Short)	The number of bytes in the DATA field is zero.
^a If more than one condition is true, then this state shall select which message to send to the ST_TFR state machine using the following order: 1) Reception Complete (Data Offset Error); 2) Reception Complete (Too Much Write Data); or 3) Reception Complete (Information Unit Too Short).	

If:

- a) transport layer retries are enabled;
- b) the CHANGING DATA POINTER bit is set to zero; and
- c) the value in the DATA OFFSET field is not equal to the Write Data Offset state machine variable,

Page: 496

● Author: hpq-relliott
Subject: Highlight
Date: 5/6/2008 4:07:50 PM
T ACCEPT - DONE

vender
s/b
vendor

● Author: RElliott
Subject: Highlight
Date: 6/30/2008 6:16:52 PM
T ACCEPT - DONE

move "the" into b)

● Author: lsi-gpenokie
Subject: Highlight
Date: 6/27/2008 6:25:57 PM
T REJECT (no, only one is included. See added comment)

This << or >> should be a << and >>.

● Author: RElliott
Subject: Note
Date: 6/30/2008 6:16:52 PM
ACCEPT - DONE

reorder a) and b) to match other sections

● Author: RElliott
Subject: Underline
Date: 6/30/2008 6:16:52 PM
T ACCEPT - DONE

XFER_RDY frame
s/b
if a Cancel message was not received, then the XFER_RDY frame

● Author: wdc-mevans
Subject: Highlight
Date: 8/27/2008 7:59:38 PM
T ACCEPT - DONE (7/17 TFR normally handles Invalid Frame on its own; TTS is not suited to do that. Incorporate as Mark suggests, but changing "read" to "write")

7/14 make this return Invalid Frame, not Information Unit Too Short)

The number of bytes in the DATA field is zero.

s/b

a) The number of bytes in the DATA field in the read Data information unit is zero; or

b) This is not the last DATA frame for the transfer and the NUMBER OF FILL BYTES field in the frame is not set to zero.

then this state should discard all Data-Out Arrived messages until the CHANGING DATA POINTER bit is set to one. This state shall resume processing additional Data-Out Arrived messages when it receives a Data-Out Arrived message with the CHANGING DATA POINTER bit set to one.

If the WRITE data frame verification is successful and the Data-Out Arrived message is not discarded, then this state shall:

- a) process the write data as indicated in the Data-Out state machine arguments using the Device Server Buffer (e.g., logical block address) to which the write data is to be transferred; and
- b) set the Write Data Offset state machine variable to the current Write Data Offset state machine variable plus the number of bytes received in the DATA field of the write Data information unit.

If the WRITE data frame verification is successful and the CHANGING DATA POINTER bit set to one, then this state shall:

- a) set the Write Data Offset state machine variable to the Requested Write Data Offset state machine variable plus the number of bytes received in the DATA field of the write Data information unit; and
- b) process the write data as indicated in the Data-Out state machine arguments using the Device Server Buffer (e.g., logical block address) to which the write data is to be transferred.

If data received in the write DATA frame overlaps data previously received and verified successfully, this state may either discard the overlapping data, or replace the previously received data with the new data.

If the Initiator Response Timeout timer is implemented, then this state shall initialize and start the Initiator Response Timeout timer:

- a) upon entry into this state; and
- b) when this state receives and verifies the write DATA frame received with the Data-Out Arrived values (i.e., Data-Out data was received and processed).

If the Initiator Response Timeout timer is running, then this state shall stop the timer before transitioning from this state.

If the Initiator Response Timeout timer expires, then this state shall send a Reception Complete (Initiator Response Timeout) message to the ST_TFR state machine.

If the Write Data Offset state machine variable equals the Request Byte Count Data-Out state machine argument plus the Application Client Buffer Offset Data-Out state machine argument, then this state shall send a Reception Complete (Data-Out Received) message to the ST_TFR state machine after a Reception Complete (ACK Transmitted) confirmation is received for each write DATA frame previously received.

If this state receives a Cancel message, then this state shall send a Reception Complete (Data Transfer Terminated) message to the ST_TFR state machine.

If this state receives Transmission Status (Break Received) confirmation, then this state shall send a Reception Complete (Data Transfer Terminated) to the ST_TFR state machine.

The Reception Complete message, if any, shall include the tag as an argument.

9.2.6.3.3.6.2 Transition ST_TTS5:Receive_Data_Out to ST_TTS1:Target_Start

This transition shall occur after this state sends a Reception Complete message to the ST_TFR state machine.

9.2.6.3.3.6.3 Transition ST_TTS5:Receive_Data_Out to ST_TTS4:Prepare_Xfer_Rdy

This transition shall occur:

- 1) if the Write Data Offset state machine variable is less than Request Byte Count Data-Out state machine argument plus the Application Client Buffer Offset Data-Out state machine argument and equal to the Requested Write Data Offset state machine variable plus the Requested Write Data Length state machine variable;
- 2) after a Reception Complete (ACK Transmitted) confirmation is received for each write DATA frame previously received;

● Author: RElliott
Subject: Highlight
Date: 8/30/2008 1:11:26 PM

T ACCEPT - DONE

a Reception Complete (ACK Transmitted) confirmation
s/b
an ACK Transmitted confirmation
per 08-343

● Author: RElliott
Subject: Highlight
Date: 6/30/2008 6:16:52 PM

T ACCEPT - DONE

after this state sends
s/b
after sending

● Author: RElliott
Subject: Highlight
Date: 8/30/2008 1:11:35 PM

T ACCEPT - DONE

a Reception Complete (ACK Transmitted) confirmation
s/b
an ACK Transmitted confirmation
per 08-343

- 3) after determining the amount of write data already transferred by subtracting the Application Client Buffer Offset Data-Out state machine argument from the Write Data Offset state machine variable;
- 4) after setting the Requested Write Data Length state machine variable to the Request Byte Count Data-Out state machine argument minus the amount of write data already transferred; and
- 5) after setting the Requested Write Data Offset state machine variable to the Write Data Offset state machine variable.

9.2.6.3.3.7 ST_TTS6:Prepare_Response state

9.2.6.3.3.7.1 State description

This state shall construct a RESPONSE frame using the received Application Response arguments or the received Transport Response arguments as follows:

- a) FRAME TYPE field set to 07h (i.e., RESPONSE frame);
- b) HASHED DESTINATION SAS ADDRESS field set to the hashed value of the Application Response or Transport Response destination SAS address argument;
- c) HASHED SOURCE SAS ADDRESS field set to the hashed value of the SSP target port's SAS address;
- d) RETRY DATA FRAMES bit set to zero;
- e) RETRANSMIT bit set to zero;
- f) CHANGING DATA POINTER bit set to zero;
- g) TAG field set to the Tag Application Response argument or the Tag Transport Response argument;
- h) TARGET PORT TRANSFER TAG field set to a vendor-specific value;
- i) DATA OFFSET field set to zero;
- j) information unit set as specified in this subclause; and
- k) fill bytes, if needed as specified in this subclause.

If this state was entered with the Transport Response arguments, then this state shall set the fields as follows:

- a) NUMBER OF FILL BYTES field set to the number of fill bytes, based on the length of the response data, if any;
- b) in the information unit, set the DATAPRES field to RESPONSE DATA;
- c) in the information unit, set the STATUS field to zero;
- d) in the information unit, set the SENSE DATA LENGTH field to zero;
- e) in the information unit, set the RESPONSE DATA LENGTH field to 00000004h;
- f) in the information unit, set the RESPONSE DATA field as specified in table 190;
- g) in the information unit, do not include the SENSE DATA field; and
- h) ~~NUMBER OF FILL BYTES field set to the number of fill bytes, based on the length of the response data, if needed.~~

Table 190 defines how the RESPONSE DATA field shall be set based on the arguments received with the Request (Send Transport Response) message.

Table 190 — Request argument to RESPONSE frame response data field mapping

Request argument	RESPONSE frame response data field
Invalid Frame	INVALID FRAME
Function Complete	TASK MANAGEMENT FUNCTION COMPLETE
Function Succeeded	TASK MANAGEMENT FUNCTION SUCCEEDED
Function Not Supported	TASK MANAGEMENT FUNCTION NOT SUPPORTED
Function Failed	TASK MANAGEMENT FUNCTION FAILED
Incorrect Logical Unit Number	INCORRECT LOGICAL UNIT NUMBER
Overlapped Tag Attempted	OVERLAPPED TAG ATTEMPTED

● Author: RElliott
Subject: Highlight
Date: 6/30/2008 6:16:52 PM
T ACCEPT - DONE

zero
s/b
00000000h

● Author: RElliott
Subject: Cross-Out
Date: 8/27/2008 7:57:10 PM
~~T~~ ACCEPT - DONE

Delete
h) NUMBER OF FILL BYTES field set to the number of fill bytes, based on the length of the response data, if needed.

which duplicates a)

If this state was entered with the Application Response arguments, then this state shall set the fields as follows:

- a) in the information unit, set the DATAPRES field to SENSE_DATA if sense data is to be included in the information unit or NO_DATA if sense data is not to be included in the information unit;
- b) in the information unit, set the STATUS field to the status;
- c) in the information unit, set the SENSE DATA LENGTH field to the length of the sense data, if any;
- d) in the information unit, set the RESPONSE DATA LENGTH field to zero;
- e) in the information unit, do not include the RESPONSE DATA field;
- f) in the information unit, set the SENSE DATA field to the sense data, if any; and
- g) NUMBER OF FILL BYTES field set to the number of fill bytes, based on the length of the sense data, if needed.

9.2.6.3.3.7.2 Transition ST_TTS6:Prepare_Response to ST_TTS2:Target_Send_Frame

This transition shall occur after this state constructs a RESPONSE frame.

This transition shall include:

- a) the RESPONSE frame; or
- b) if a Cancel message was received, then a Cancel argument.

9.3 STP transport layer

9.3.1 Initial FIS

A SATA device phy transmits a Register - Device to Host FIS after completing the link reset sequence (see G.5 for exceptions to this). The expander device shall update a set of shadow registers with the contents of this FIS and shall not deliver it to any STP initiator port. SMP initiator ports may read the shadow register contents using the SMP REPORT PHY SATA function (see 10.4.3.i2). The expander device originates a Broadcast (Change) after receiving the Register - Device to Host FIS (see 7.11).

9.3.2 BIST Activate FIS

STP initiator ports and STP target ports shall not generate BIST Activate FISes and shall process any BIST Activate FISes received as frames having invalid FIS types (i.e., have the link layer generate SATA_R_ERR in response).

9.3.3 TT (transport layer for STP ports) state machines

The STP transport layer uses the transport layer state machines defined in SATA, modified to communicate with the port layer rather than directly with the link layer. These modifications are not described in this standard.

● Author: RElliott
Subject: Underline
Date: 6/30/2008 6:16:52 PM
T ACCEPT - DONE

the RESPONSE frame
s/b
if a Cancel message was not received, then the RESPONSE frame

● Author: lsi-gpenokie
Subject: Highlight
Date: 6/27/2008 6:26:49 PM
T REJECT (no, only one is included. See added comment)

This << or >> should be a << and >>.

● Author: RElliott
Subject: Highlight
Date: 6/30/2008 6:16:52 PM
T ACCEPT - DONE

frame
s/b
frame as an argument

● Author: lsi-gpenokie
Subject: Highlight
Date: 5/6/2008 4:07:50 PM
T ACCEPT - DONE ("except for the cases described in G.5")

This << link reset sequence (see G.5 for exceptions to this). >> should be << link reset sequence except as defined in G.5. >>

● Author: wdc-mevans
Subject: Highlight
Date: 5/6/2008 4:07:50 PM
T ACCEPT - DONE (this FIS)

it
s/b
the FIS

9.4 SMP transport layer

9.4.1 SMP transport layer overview

Table 191 defines the SMP frame format.

Table 191 — SMP frame format

Byte/Bit	7	6	5	4	3	2	1	0	
0	SMP FRAME TYPE								
1	Frame-type dependent bytes								
	Fill bytes, if needed								
n - 3	(MSB)	CRC							
n								(LSB)	

Table 192 defines the SMP FRAME TYPE field, which defines the format of the frame-type dependent bytes.

Table 192 — SMP FRAME TYPE field

Code	Name	Frame type	Originator	Reference
40h	SMP_REQUEST	SMP function request	SMP initiator port	9.4.2
41h	SMP_RESPONSE	SMP function response	SMP target port	9.4.3
All others	Reserved.			

The SMP target port in an expander device shall support the SMP_REQUEST and SMP_RESPONSE frames. Other SMP target ports may support these frames.

Fill bytes shall be included after the frame-type dependent bytes so the CRC field is aligned on a four byte boundary. The contents of the fill bytes are vendor specific.

The CRC field contains a CRC value (see 7.5) that is computed over the entire SMP frame prior to the CRC field, and shall begin on a four-byte boundary. The CRC field is checked by the SMP link layer (see 7.18).

Page: 500

● Author: RElliott
Subject: Note
Date: 6/30/2008 6:16:52 PM
 ACCEPT - DONE

Delete "fill bytes" concept for SMP. SMP. Replace with:
"The number of frame-type dependent bytes shall be either:
a) three bytes; or
b) three bytes plus an integer multiple of four bytes,
so the crc field is aligned on a four byte boundary."

● Author: lsi-bday
Subject: Cross-Out
Date: 5/26/2008 11:40:46 AM
 ACCEPT - DONE (just deleted the whole paragraph, which should solve the problem.)

in an expander device

● Author: lsi-bday
Subject: Highlight
Date: 5/26/2008 11:40:54 AM
 ACCEPT - DONE (just deleted the whole paragraph, which should solve the problem.)

The SMP target port
suggest
SMP ports

These frames are required by all SMP ports, regardless of initiator / target, and regardless of expander / end device.

● Author: lsi-bday
Subject: Cross-Out
Date: 5/26/2008 11:40:41 AM
 ACCEPT - DONE (just deleted the whole paragraph, which should solve the problem.)

Other SMP target ports may support these frames.

● Author: wdc-mevans
Subject: Highlight
Date: 5/27/2008 5:02:42 PM
 REJECT (deleting all references to fill bytes instead)

Fill bytes
s/b
If required, fill bytes

9.4.2 SMP_REQUEST frame

The SMP_REQUEST frame is sent by an SMP initiator port to request an SMP function be performed by a management device server. Table 193 defines the SMP_REQUEST frame format.

Table 193 — SMP_REQUEST frame format

Byte/Bit	7	6	5	4	3	2	1	0	
0	SMP FRAME TYPE (40h)								
1	REQUEST BYTES								
	Fill bytes, if needed								
n - 3	(MSB)	CRC							
n								(LSB)	

The SMP FRAME TYPE field shall be set to 40h indicating this is an SMP_REQUEST frame.

The REQUEST BYTES field definition and length is based on the SMP function (see 10.4.3.2). The maximum size of the REQUEST BYTES field is 1 024 bytes, making the maximum size of the frame 1 032 bytes (i.e., 1 024 bytes of data + 4 bytes of header + 4 bytes of CRC).

Fill bytes shall be included after the ADDITIONAL REQUEST BYTES field so the CRC field is aligned on a four byte boundary. The contents of the fill bytes are vendor specific.

The CRC field is defined in 9.4.1.

9.4.3 SMP_RESPONSE frame

The SMP_RESPONSE frame is sent by an SMP target port in response to an SMP_REQUEST frame. Table 194 defines the SMP_RESPONSE frame format.

Table 194 — SMP_RESPONSE frame format

Byte/Bit	7	6	5	4	3	2	1	0	
0	SMP FRAME TYPE (41h)								
1	RESPONSE BYTES								
	Fill bytes, if needed								
n - 3	(MSB)	CRC							
n								(LSB)	

The SMP FRAME TYPE field shall be set to 41h indicating this is an SMP_RESPONSE frame.

The RESPONSE BYTES field definition and length is based on the SMP function (see 10.4.3.3). The maximum size of the RESPONSE BYTES field is 1 024 bytes, making the maximum size of the frame 1 032 bytes (i.e., 1 024 bytes of data + 4 bytes of header + 4 bytes of CRC).

Fill bytes shall be included after the ADDITIONAL RESPONSE BYTES field so the CRC field is aligned on a four byte boundary. The contents of the fill bytes are vendor specific.

Page: 501

● Author: RElliott
Subject: Cross-Out
Date: 6/30/2008 6:16:52 PM
 ACCEPT - DONE
indicating this is an SMP_REQUEST frame.

● Author: wdc-mevans
Subject: Highlight
Date: 5/6/2008 4:07:50 PM
 REJECT (deleted phrase instead)

indicating
s/b
specifying

● Author: RElliott
Subject: Highlight
Date: 6/30/2008 6:16:52 PM
 ACCEPT - DONE
40h
s/b
the value defined in table 193

● Author: RElliott
Subject: Note
Date: 6/30/2008 6:16:52 PM
 ACCEPT - DONE

Change to:
The format and length of the request bytes is defined by the SMP function description (see 10.4.3.2).
The number of request bytes are either:
a) three bytes; or
b) three bytes plus an integer multiple of four bytes,
so the crc field is aligned on a four byte boundary.
The maximum number of request bytes is 1 023, making the maximum size of the frame 1 028 bytes (i.e., 1 byte header + 1 023 request bytes + 4 bytes of CRC).
NOTE: Management application clients compliant with previous versions of this standard may send a vendor-specific SMP request frame containing 1 027 request bytes. The SMP_TP state machine discards SMP request frames that exceed 1 023 request bytes (see 7.18.5.4.2.2).
SMP request frames defined in those versions of this standard did not have more than 39 request bytes.

● Author: lsi-bbesmer
Subject: Highlight
Date: 5/27/2008 5:39:57 PM
 ACCEPT - DONE (backed down to 1024)

Not possible to describe. See comment in 10.4.3.2.5.

● Author: wdc-mevans
Subject: Highlight
Date: 5/27/2008 5:40:28 PM
 REJECT (eliminated fill byte concept for SMP instead)

Fill bytes
s/b
If required, fill bytes

● Author: lsi-bday
Subject: Cross-Out
Date: 5/27/2008 5:40:43 PM

Comments from page 501 continued on next page

9.4.2 SMP_REQUEST frame

The SMP_REQUEST frame is sent by an SMP initiator port to request an SMP function be performed by a management device server. Table 193 defines the SMP_REQUEST frame format.

Table 193 — SMP_REQUEST frame format

Byte\Bit	7	6	5	4	3	2	1	0	
0	SMP FRAME TYPE (40h)								
1	REQUEST BYTES								
	Fill bytes, if needed								
n - 3	(MSB)	CRC							
n								(LSB)	

The SMP FRAME TYPE field shall be set to 40h indicating this is an SMP_REQUEST frame.



The REQUEST BYTES field definition and length is based on the SMP function (see 10.4.3.2). The maximum size of the REQUEST BYTES field is 1 024 bytes, making the maximum size of the frame 1 032 bytes (i.e., 1 024 bytes of data + 4 bytes of header + 4 bytes of CRC).

Fill bytes shall be included after the ADDITIONAL REQUEST BYTES field so the CRC field is aligned on a four byte boundary. The contents of the fill bytes are vendor specific.

The CRC field is defined in 9.4.1.

9.4.3 SMP_RESPONSE frame

The SMP_RESPONSE frame is sent by an SMP target port in response to an SMP_REQUEST frame. Table 194 defines the SMP_RESPONSE frame format.

Table 194 — SMP_RESPONSE frame format

Byte\Bit	7	6	5	4	3	2	1	0	
0	SMP FRAME TYPE (41h)								
1	RESPONSE BYTES								
	Fill bytes, if needed								
n - 3	(MSB)	CRC							
n								(LSB)	

The SMP FRAME TYPE field shall be set to 41h indicating this is an SMP_RESPONSE frame.



The RESPONSE BYTES field definition and length is based on the SMP function (see 10.4.3.3). The maximum size of the RESPONSE BYTES field is 1 024 bytes, making the maximum size of the frame 1 032 bytes (i.e., 1 024 bytes of data + 4 bytes of header + 4 bytes of CRC).

Fill bytes shall be included after the ADDITIONAL RESPONSE BYTES field so the CRC field is aligned on a four byte boundary. The contents of the fill bytes are vendor specific.

 ACCEPT - DONE (but moot as this sentence was deleted)

ADDITIONAL

● Author: RElliott
Subject: Cross-Out
Date: 6/30/2008 6:16:52 PM

 ACCEPT - DONE
indicating this is an SMP_RESPONSE frame.

● Author: RElliott
Subject: Highlight
Date: 6/30/2008 6:16:52 PM

 ACCEPT - DONE
41h
s/b
the value defined in table 194

● Author: RElliott
Subject: Note
Date: 6/30/2008 6:16:52 PM

 ACCEPT - DONE

Change to:

The format and length of the request bytes is defined by the SMP function description (see 10.4.3.3).

The number of response bytes are either:

- a) three bytes; or
- b) three bytes plus an integer multiple of four bytes,
so the crc field is aligned on a four byte boundary.

The maximum number of response bytes is 1 023, making the maximum size of the frame 1 028 bytes (i.e., 1 byte header + 1 023 request bytes + 4 bytes of CRC).

NOTE: Management device servers compliant with previous versions of this standard may send a vendor-specific SMP response frame containing 1 027 response bytes. The SMP_IP state machine discards SMP response frames that exceed 1 023 request bytes (see 7.18.5.3.4).

SMP response frames defined in those versions of this standard did not have more than 59 request bytes.

● Author: Isi-bbesmer
Subject: Highlight
Date: 5/27/2008 5:40:03 PM

 ACCEPT - DONE (backed down to 1024)

Not possible to describe. See comment in 10.4.3.2.4.

● Author: wdc-mevans
Subject: Highlight
Date: 5/27/2008 5:40:24 PM

 REJECT (eliminated fill byte concept for SMP instead)

Fill bytes

s/b

If required, fill bytes

● Author: Isi-bday
Subject: Cross-Out
Date: 5/27/2008 5:40:47 PM

 ACCEPT - DONE (but moot as this sentence was deleted)

ADDITIONAL

The CRC field is defined in 9.4.1.

9.4.4 Sequence of SMP frames

Inside an SMP connection, the source phy transmits a single SMP_REQUEST frame and the destination phy replies with a single SMP_RESPONSE frame.

Figure 217 shows the sequence of SMP frames.

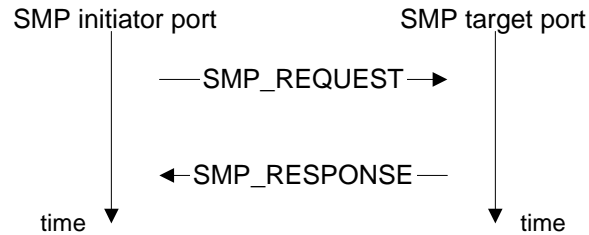

Figure 217 — Sequence of SMP frames

9.4.5 MT (transport layer for SMP ports) state machines

9.4.5.1 SMP transport layer state machines overview

The SMP transport layer contains state machines that process requests from the management application layer and returns confirmations to the management application layer. The SMP transport state machines are as follows:

- MT_IP (transport layer for SMP initiator ports) state machine (see 9.4.5.2); and
- MT_TP (transport layer for SMP target ports) state machine (see 9.4.5.3).

9.4.5.2 MT_IP (transport layer for SMP initiator ports) state machine

9.4.5.2.1 MT_IP state machine overview

The MT_IP state machine processes requests from the management application layer. These management requests are sent to the port layer and the resulting SMP frame or error condition is sent to the management application layer as a confirmation.

This state machine consists of the following states:

- MT_IP1:Idle (see 9.4.5.2.2)(initial state);
- MT_IP2:Send (see 9.4.5.2.3); and
- MT_IP3:Receive (see 9.4.5.2.4).

This state machine shall start in the MT_IP1:Idle state.

● Author: lsi-bday
Subject: Highlight
Date: 5/26/2008 11:42:44 AM
T ACCEPT - DONE

destination phy
suggest
SMP target port

● Author: lsi-bday
Subject: Highlight
Date: 5/26/2008 11:42:40 AM
T ACCEPT - DONE

source phy
suggest
SMP initiator port

● Author: wdc-mevans
Subject: Highlight
Date: 5/26/2008 11:42:55 AM
T ACCEPT - DONE

returns
s/b
return

● Author: wdc-mevans
Subject: Highlight
Date: 5/26/2008 11:43:21 AM
T ACCEPT - DONE

layer and
s/b
layer, and

Figure 218 describes the MT_IP state machine.

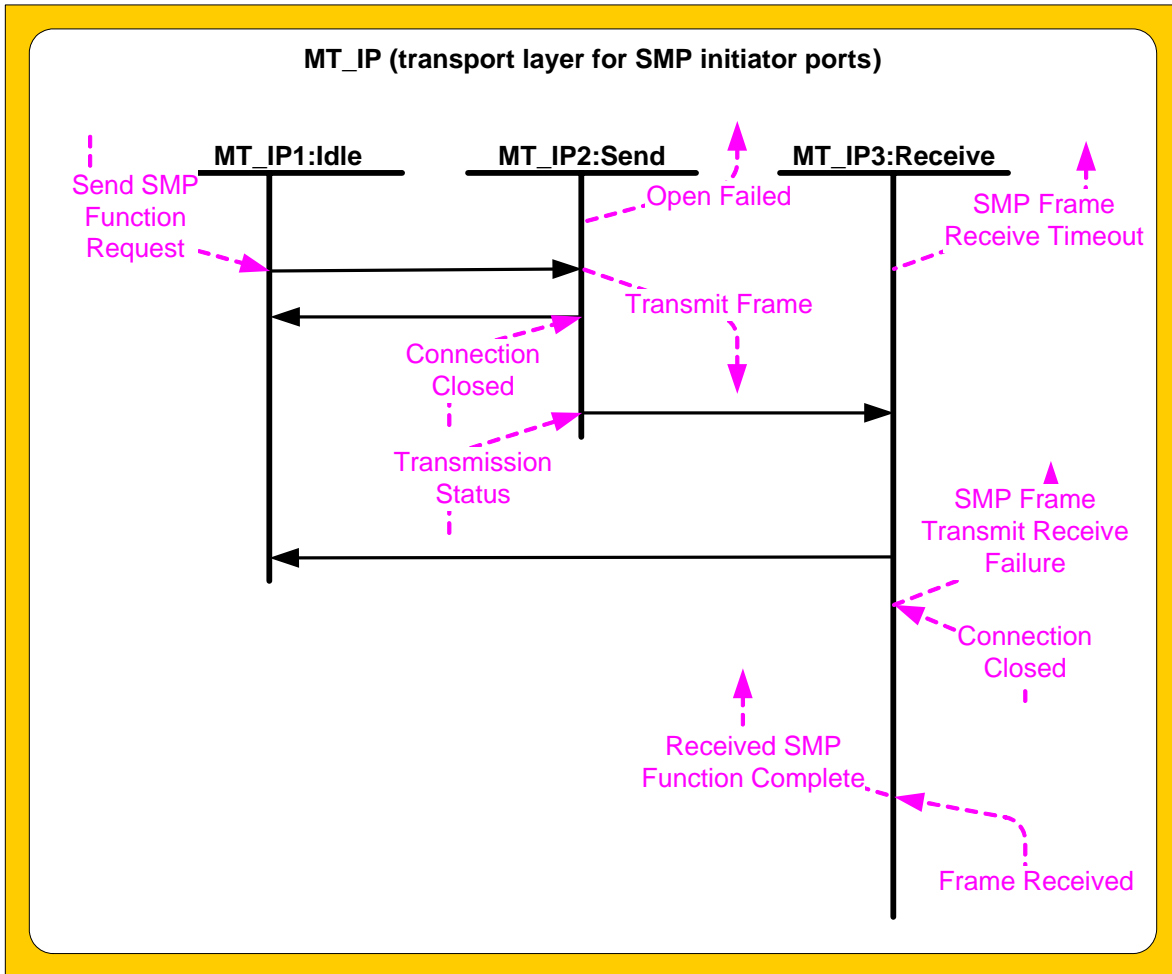

Figure 218 — MT_IP (transport layer for SMP initiator ports) state machine

9.4.5.2.2 MT_IP1:Idle state

9.4.5.2.2.1 State description

This state is the initial state of the MT_IP state machine.

This state waits for a Send SMP Function Request request, which includes the following arguments:

- a) connection rate;
- b) destination SAS address; and
- c) request bytes.

9.4.5.2.2.2 Transition MT_IP1:Idle to MT_IP2:Send

This transition shall occur after a Send SMP Function Request request is received. This transition shall include the following arguments:

- a) connection rate;
- b) destination SAS address; and
- c) request bytes.

This page contains no comments

9.4.5.2.3 MT_IP2:Send state

9.4.5.2.3.1 State description

This state constructs an SMP_REQUEST frame using the following arguments received in the transition into this state:

- a) request bytes;

and sends a Transmit Frame request to the port layer with the following arguments:

- a) initiator port bit set to one;
- b) protocol set to SMP;
- c) connection rate;
- d) initiator connection tag set to FFFFh;
- e) destination SAS address;
- f) source SAS address set to the SAS address of the SMP initiator port; and
- g) request bytes.

9.4.5.2.3.2 Transition MT_IP2:Send to MT_IP1:Idle

This transition shall occur after receiving either a Connection Closed confirmation or a Transmission Status confirmation other than a Transmission Status (Frame Transmitted) confirmation, and after sending an Open Failed confirmation to the management application layer.

9.4.5.2.3.3 Transition MT_IP2:Send to MT_IP3:Receive

This transition shall occur after receiving a Transmission Status (Frame Transmitted) confirmation.

9.4.5.2.4 MT_IP3:Receive state

9.4.5.2.4.1 State description

This state waits for a confirmation from the port layer that either an SMP frame has been received or a failure occurred.

If a Frame Received confirmation is received and the SMP frame type is equal to 41h, **this** state shall send a Received SMP Function Complete confirmation to the management application layer.

If a Frame Received confirmation is received and the SMP frame type is not equal to 41h, **this** state shall send **a SMP** Frame Transmit Receive Failure confirmation to the management application layer.

If a Connection Closed or Frame Received (SMP Failure) confirmation is received, **this** state shall send an SMP Frame Transmit Receive Failure confirmation to the management application layer.

9.4.5.2.4.2 Transition MT_IP3:Receive to MT_IP1:Idle

This transition shall occur after one of the following:

- a) sending a Received SMP Function Complete confirmation; or
- b) sending an SMP Frame Transmit Receive Failure confirmation.

9.4.5.3 MT_TP (transport layer for SMP target ports) state machine

9.4.5.3.1 MT_TP state machine overview

The MT_TP state machine informs the management application layer of the receipt of an SMP frame. Confirmation of the receipt of an SMP frame is sent to the management application layer. The management application layer creates the corresponding SMP_RESPONSE frame and this state sends it to the port layer.

This state machine consists of the following states:

- a) MT_TP1:Idle (see 9.4.5.3.2)(initial state); and
- b) MT_TP2:Respond (see 9.4.5.3.3).

Page: 504

● Author: RElliott
Subject: Underline
Date: 9/3/2008 8:04:12 PM
T ACCEPT - DONE

Frame Received
s/b
Frame Received (SMP Successful)

to parallel SSP names

prompted by 08-343

● Author: RElliott
Subject: Highlight
Date: 6/30/2008 6:16:52 PM
T ACCEPT - DONE

this
s/b
then this

● Author: RElliott
Subject: Underline
Date: 9/3/2008 8:04:18 PM
T ACCEPT - DONE

Frame Received
s/b
Frame Received (SMP Successful)

to parallel SSP names

prompted by 08-343

● Author: RElliott
Subject: Highlight
Date: 6/30/2008 6:16:52 PM
T ACCEPT - DONE

this
s/b
then this

● Author: wdc-mevans
Subject: Highlight
Date: 5/26/2008 11:43:38 AM
T ACCEPT - DONE

a SMP
s/b
an SMP

Comments from page 504 continued on next page

9.4.5.2.3 MT_IP2:Send state

9.4.5.2.3.1 State description

This state constructs an SMP_REQUEST frame using the following arguments received in the transition into this state:

- a) request bytes;

and sends a Transmit Frame request to the port layer with the following arguments:

- a) initiator port bit set to one;
- b) protocol set to SMP;
- c) connection rate;
- d) initiator connection tag set to FFFFh;
- e) destination SAS address;
- f) source SAS address set to the SAS address of the SMP initiator port; and
- g) request bytes.

9.4.5.2.3.2 Transition MT_IP2:Send to MT_IP1:Idle

This transition shall occur after receiving either a Connection Closed confirmation or a Transmission Status confirmation other than a Transmission Status (Frame Transmitted) confirmation, and after sending an Open Failed confirmation to the management application layer.

9.4.5.2.3.3 Transition MT_IP2:Send to MT_IP3:Receive

This transition shall occur after receiving a Transmission Status (Frame Transmitted) confirmation.

9.4.5.2.4 MT_IP3:Receive state

9.4.5.2.4.1 State description

This state waits for a confirmation from the port layer that either an SMP frame has been received or a failure occurred.

If a Frame Received confirmation is received and the SMP frame type is equal to 41h, **this** state shall send a Received SMP Function Complete confirmation to the management application layer.

If a Frame Received confirmation is received and the SMP frame type is not equal to 41h, **this** state shall send **a SMP** Frame Transmit Receive Failure confirmation to the management application layer.

If a Connection Closed or Frame Received (SMP Failure) confirmation is received, **this** state shall send an SMP Frame Transmit Receive Failure confirmation to the management application layer.

9.4.5.2.4.2 Transition MT_IP3:Receive to MT_IP1:Idle

This transition shall occur after one of the following:

- a) sending a Received SMP Function Complete confirmation; or
- b) sending an SMP Frame Transmit Receive Failure confirmation.

9.4.5.3 MT_TP (transport layer for SMP target ports) state machine

9.4.5.3.1 MT_TP state machine overview

The MT_TP state machine informs the management application layer of the receipt of an SMP frame. Confirmation of the receipt of an SMP frame is sent to the management application layer. The management application layer creates the corresponding SMP_RESPONSE frame and this state sends it to the port layer.

This state machine consists of the following states:

- a) MT_TP1:Idle (see 9.4.5.3.2)(initial state); and
- b) MT_TP2:Respond (see 9.4.5.3.3).

Author: RElliott
Subject: Underline
Date: 9/3/2008 8:03:11 PM
T ACCEPT - DONE

Frame Received (SMP Failure)
s/b
Frame Received (SMP Unsuccessful)

to parallel SSP names

prompted by 08-343

Author: RElliott
Subject: Highlight
Date: 6/30/2008 6:16:52 PM
T ACCEPT - DONE

this
s/b
then this

Author: RElliott
Subject: Underline
Date: 6/30/2008 6:16:52 PM
T ACCEPT - DONE

The MT_TP state machine informs the management application layer of the receipt of an SMP frame. Confirmation of the receipt of an SMP frame is sent to the management application layer. The management application layer creates the corresponding SMP_RESPONSE frame and this state sends it to the port layer.

s/b

The MT_TP state machine informs the management application layer of the receipt of an SMP frame, and sends the resulting SMP frame to the port layer.

to parallel wording in MT_IP

Author: wdc-mevans
Subject: Highlight
Date: 5/23/2008 1:31:08 PM

T REJECT (but changed the whole paragraph to parallel the MT_IP paragraph; see other comment)

it
s/b
the frame

This state machine shall start in the MT_TP1:Idle state.

Figure 219 describes the MT_TP state machine.

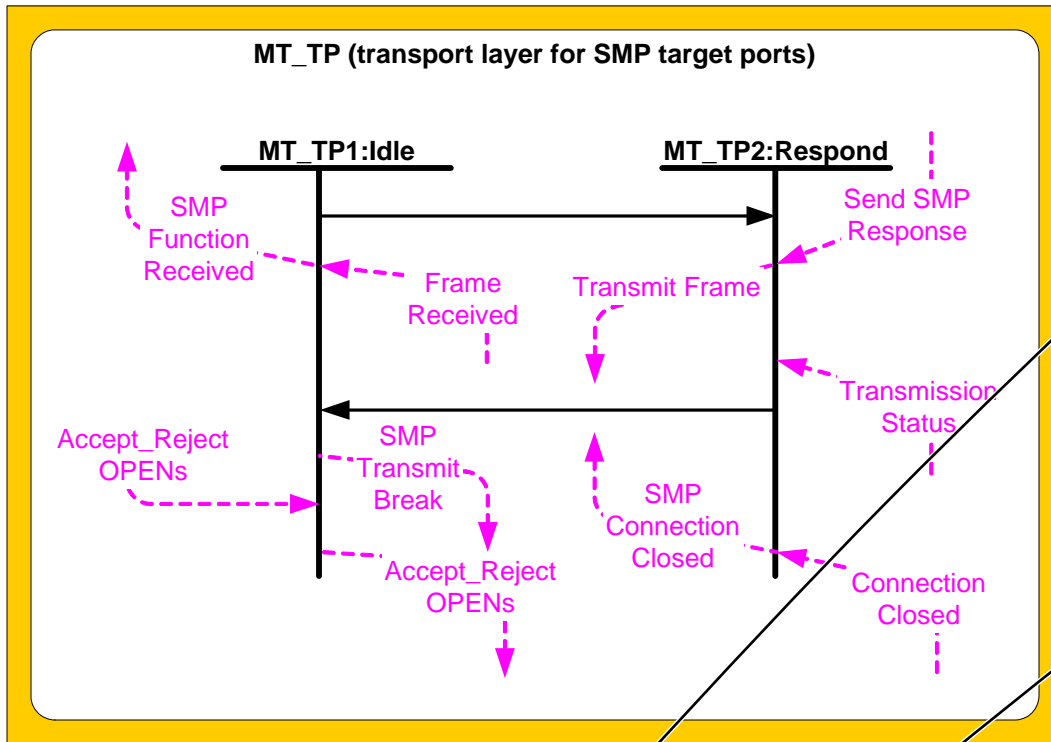

Figure 219 — MT_TP (transport layer for SMP target ports) state machine

The MT_TP state machine shall comply with the time limits listed in table 195.

Table 195 — MT_TP time limits

Time limit	Value	Description
SMP Response time limit	1 900 μs	Maximum time from receiving an SMP_REQUEST frame to transmitting an SMP_RESPONSE frame

9.4.5.3.2 MT_TP1:Idle state

9.4.5.3.2.1 State description

This state is the initial state of the MT_TP state machine.

This state waits for a Frame Received confirmation. If the SMP frame type is not equal to 40h, this state shall discard the frame and send a SMP Transmit Break request to the port layer. Otherwise, this state shall send an SMP Function Received confirmation to the management application layer.

If an Accept_Reject OPENS (Accept SMP) or Accept_Reject OPENS (Reject SMP) request is received, this state shall send an Accept_Reject OPENS request with the same arguments to the port layer.

9.4.5.3.2.2 Transition MT_TP1:Idle to MT_TP2:Respond

This transition shall occur after sending an SMP Function Received confirmation.

Page: 505

● Author: Isi-bday
Subject: Highlight
Date: 7/14/2008 6:42:12 PM

T REJECT (7/14 The original proposal's initiator timeouts were erased due to SAS-1.1 compatibility concerns, but this number still allows a 2 ms timeout to be used if SAS-1.1 compatibility is not an issue. Leave as is.

5/5 I think the original proposal had a 2 ms initiator time; that may have been discarded)

1 900 us

I don't think there is reason anymore to not just change this to 2ms, since it's not enforced on the SMP Initiator side.

● Author: RElliott
Subject: Underline
Date: 9/3/2008 8:04:33 PM

T ACCEPT - DONE

Frame Received

s/b

Frame Received (SMP Successful)

to parallel SSP names

prompted by 08-343

● Author: RElliott
Subject: Highlight
Date: 6/30/2008 6:16:52 PM

T ACCEPT - DONE

this

s/b

then this

● Author: wdc-mevans
Subject: Highlight
Date: 5/26/2008 11:44:08 AM

T ACCEPT - DONE

a SMP

s/b

an SMP

● Author: RElliott
Subject: Highlight
Date: 6/30/2008 6:16:52 PM

T ACCEPT - DONE

this

s/b

then this

● Author: RElliott

Comments from page 505 continued on next page

This state machine shall start in the MT_TP1:Idle state.

Figure 219 describes the MT_TP state machine.

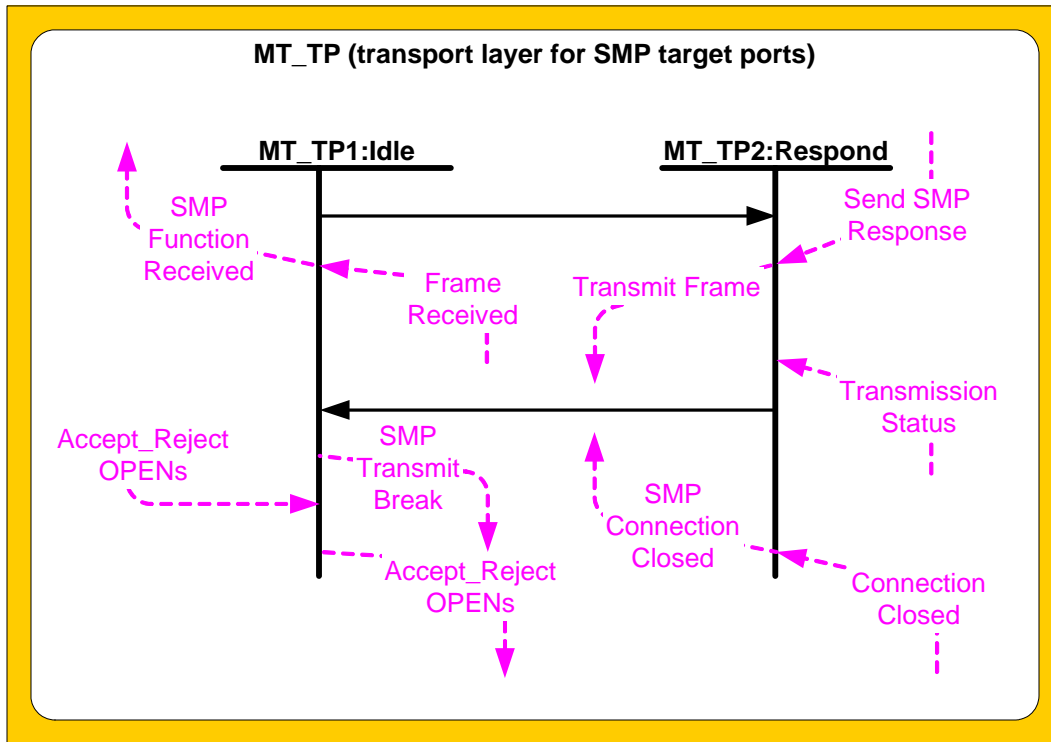

Figure 219 — MT_TP (transport layer for SMP target ports) state machine

The MT_TP state machine shall comply with the time limits listed in table 195.

Table 195 — MT_TP time limits

Time limit	Value	Description
SMP Response time limit	1 900 μs	Maximum time from receiving an SMP_REQUEST frame to transmitting an SMP_RESPONSE frame

9.4.5.3.2 MT_TP1:Idle state

9.4.5.3.2.1 State description

This state is the initial state of the MT_TP state machine.

This state waits for a **Frame Received** confirmation. If the SMP frame type is not equal to 40h, this state shall discard the frame and send a **SMP Transmit Break** request to the port layer. Otherwise, this state shall send an **SMP Function Received** confirmation to the management application layer.

If an **Accept_Reject OPENS (Accept SMP) or Accept_Reject OPENS (Reject SMP)** request is received, this state shall send an **Accept_Reject OPENS** request with the same arguments to the port layer.

9.4.5.3.2.2 Transition MT_TP1:Idle to MT_TP2:Respond

This transition shall occur after sending an **SMP Function Received** confirmation.

Subject: Highlight
Date: 8/30/2008 3:14:33 PM

T ACCEPT - DONE

Accept_Reject OPENs (Accept SMP) or

add request in the spirit of 08-343

9.4.5.3.3 MT_TP2:Respond state

9.4.5.3.3.1 State description

This state waits for a Send SMP Response request, which includes the following arguments:

- a) response bytes.

After receiving a Send SMP Response request, this state shall construct an SMP_RESPONSE frame using the arguments from the Send SMP Response request and send a Transmit Frame request to the port layer within the SMP Response time limit specified in table 195 (see 9.4.5.3.1).

If this state receives a Connection Closed confirmation, this state shall send an SMP Connection Closed confirmation to the management application layer.

9.4.5.3.3.2 Transition MT_TP2:Respond to MT_TP1:Idle

This transition shall occur after one of the following:

- a) receiving a Transmission Status (Frame Transmitted) confirmation; or
- b) sending an SMP Connection Closed confirmation.

● Author: Isi-gpenokie
Subject: Highlight
Date: 5/6/2008 4:07:50 PM
T ACCEPT - DONE

This << the following arguments >> should be << the following argument >>

● Author: RElliott
Subject: Highlight
Date: 6/30/2008 6:16:52 PM
T ACCEPT - DONE

this state
s/b
then this state

10 Application layer

10.1 Application layer overview

The application layer defines SCSI, ATA, and management specific features.

10.2 SCSI application layer

10.2.1 SCSI transport protocol services

10.2.1.1 SCSI transport protocol services overview

An application client requests the processing of a SCSI command by invoking SCSI transport protocol services, the collective operation of which is conceptually modeled in the following ~~remote~~ procedure call (see SAM-4):

Service response = **Execute Command** (IN (I_T_L_Q Nexus, CDB, Task Attribute, [Data-In Buffer Size], [Data-Out Buffer], [Data-Out Buffer Size], [Task Priority]), OUT ([Data-In Buffer], [Sense Data], [Sense Data Length], **Status**))

An application client requests the processing of a SCSI task management function by invoking SCSI transport protocol services, the collective operation of which is conceptually modeled in the following ~~remote~~ procedure calls (see SAM-4):

- a) Service Response = ABORT TASK (IN (Nexus));
- b) Service Response = ABORT TASK SET (IN (Nexus));
- c) Service Response = CLEAR ACA (IN (Nexus));
- d) Service Response = CLEAR TASK SET (IN (Nexus));
- e) Service Response = I_T NEXUS RESET (IN (Nexus));
- f) Service Response = LOGICAL UNIT RESET (IN (Nexus));
- g) Service Response = QUERY TASK (IN (Nexus));
- h) Service Response = QUERY TASK SET (IN (Nexus)); and
- i) Service Response = **QUERY UNIT ATTENTION** (IN (Nexus), OUT([Additional Response Information])).

SSP defines the transport protocol services required by SAM-4 in support of these ~~remote~~ procedure calls.

Page: 507

Author: ibm-ted-vojnovich

Subject: Note

Date: 5/26/2008 11:44:39 AM

 REJECT (5/5 that's probably just an implementation issue. Specific proposals for text are welcome, but the WG doesn't want to invent something right now.)

Section 10: This might be more an implementation point but from what I have seen (and in no way have I seen alot), the queuing approach for a SAS 4X link seems to have HOL blocking issues. I believe the following has been done and illustrates the problem. Assume 5 IOs outbound from initiator and initiator has a SAS 4X link. IO1 to link 1, IO2 to link 2, etc

Now IO5 appears, in some implementation pinned to link 1. However, if IO 1 is moving 1KB and IO 2,IO3,IO4 are moving 100 bytes, link 2, 3, 4 are freed up quickly. However since IO 5 is pinned to link 1, it needs to wait for link 1 to finish transmitting IO 1 even though links 2,3,4 are freed up way earlier. This becomes an even bigger issue when the target is a RAID controller with lots of disk behind (ie it could potentially receive that much more traffic and better utilize the 4X link). Obviously, 4 SAS 1X links tied to a common target need to be treated as separate links and, thus, this optimization would not apply. Perhaps some discussion on the queuing model that should be used with any nX SAS ports might be in order.

Author: RElliott

Subject: Cross-Out

Date: 6/30/2008 6:16:52 PM

 ACCEPT - DONE

Delete
remote

as it was stricken from SAM-4

Author: wdc-mevans

Subject: Highlight

Date: 5/6/2008 4:07:50 PM

 REJECT (they are lined up after the parenthesis, which looks better)

= Execute Command
s/b

Move all of the text after the equal sign to have the same indentation.

Author: wdc-mevans

Subject: Highlight

Date: 5/6/2008 4:07:50 PM

 ACCEPT - DONE

Status)
s/b

Add [Status Qualifier] as an argument to the Execute Command "OUT" portion.

Author: RElliott

Subject: Cross-Out

Date: 6/30/2008 6:16:52 PM

 ACCEPT - DONE

Delete remote

as it was removed from SAM-4

Author: RElliott

Subject: Highlight

Date: 6/30/2008 6:16:52 PM

 ACCEPT - DONE

QUERY UNIT ATTENTION

s/b

Comments from page 507 continued on next page

10 Application layer

10.1 Application layer overview

The application layer defines SCSI, ATA, and management specific features.

10.2 SCSI application layer

10.2.1 SCSI transport protocol services

10.2.1.1 SCSI transport protocol services overview

An application client requests the processing of a SCSI command by invoking SCSI transport protocol services, the collective operation of which is conceptually modeled in the following ~~remote~~ procedure call (see SAM-4):

Service response = **Execute Command** (IN (I_T_L_Q Nexus, CDB, Task Attribute, [Data-In Buffer Size], [Data-Out Buffer], [Data-Out Buffer Size], [Task Priority]), OUT ([Data-In Buffer], [Sense Data], [Sense Data Length], **Status**))

An application client requests the processing of a SCSI task management function by invoking SCSI transport protocol services, the collective operation of which is conceptually modeled in the following ~~remote~~ procedure calls (see SAM-4):

- a) Service Response = ABORT TASK (IN (Nexus));
- b) Service Response = ABORT TASK SET (IN (Nexus));
- c) Service Response = CLEAR ACA (IN (Nexus));
- d) Service Response = CLEAR TASK SET (IN (Nexus));
- e) Service Response = I_T NEXUS RESET (IN (Nexus));
- f) Service Response = LOGICAL UNIT RESET (IN (Nexus));
- g) Service Response = QUERY TASK (IN (Nexus));
- h) Service Response = QUERY TASK SET (IN (Nexus)); and
- i) Service Response = **QUERY UNIT ATTENTION** (IN (Nexus), OUT([Additional Response Information])).

SSP defines the transport protocol services required by SAM-4 in support of these ~~remote~~ procedure calls.

QUERY ASYNCHRONOUS EVENT

to match sam4r14h

● Author: RElliott
Subject: Cross-Out
Date: 6/30/2008 6:16:52 PM

 ACCEPT - DONE

Delete remote
as it was removed from SAM-4

● Author: RElliott
Subject: Highlight
Date: 6/30/2008 6:16:52 PM

 ACCEPT - DONE

SSP defines
s/b
This standard defines

Table 196 describes the mapping of the ~~remote~~ procedure calls to transport protocol services and the SSP implementation of each transport protocol service.

Table 196 — SCSI architecture mapping

Remote procedure call	Type of transport protocol service	Transport protocol service interaction	Transport protocol service	I/T^a	SSP implementation
Execute Command	Request/Confirmation	Request	Send SCSI Command	I	COMMAND frame
		Indication	SCSI Command Received	T	Receipt of the COMMAND frame
		Response	Send Command Complete	T	RESPONSE frame
		Confirmation	Command Complete Received	I	Receipt of the RESPONSE frame or problem transmitting the COMMAND frame
	Data-In Transfer ^b	Request	Send Data-In	T	Read DATA frames
		Confirmation	Data-In Delivered	T	Receipt of ACKs for the read DATA frames
	Data-Out Transfer ^b	Request	Receive Data-Out	T	XFER_RDY frame
		Confirmation	Data-Out Received	T	Receipt of write DATA frames
	Terminate Data Transfer ^b	Request	Terminate Data Transfer	T	
		Confirmation	Data Transfer Terminated	T	
ABORT TASK, ABORT TASK SET, CLEAR ACA, CLEAR TASK SET, I_T NEXUS RESET, LOGICAL UNIT RESET, QUERY TASK, QUERY TASK SET, and QUERY UNIT ATTENTION	Request/Confirmation	Request	Send Task Management Request	I	TASK frame
		Indication	Task Management Request Received	T	Receipt of the TASK frame
		Response	Task Management Function Executed	T	RESPONSE frame
		Confirmation	Received Task Management Function Executed	I	Receipt of the RESPONSE frame or problem transmitting the TASK frame
^a I/T indicates whether the SSP initiator port (I) or the SSP target port (T) implements the transport protocol service. ^b Data transfer transport protocol services for SCSI initiator ports are not specified by SAM-4.					

These protocol services are used as the requests and confirmations to the SSP transport layer state machines (see 9.2.6) from the SCSI application layer.

Page: 508

● Author: RElliott
Subject: Cross-Out
Date: 6/30/2008 6:16:52 PM
 ACCEPT - DONE
Delete remote
as it was removed from SAM-4

● Author: RElliott
Subject: Highlight
Date: 6/30/2008 6:16:52 PM
 ACCEPT - DONE
architecture mapping
s/b
procedure call mapping

● Author: RElliott
Subject: Note
Date: 6/30/2008 6:16:52 PM
 ACCEPT - DONE
Renaming QUERY UNIT ATTENTION to QUERY ASYNCHRONOUS EVENT makes this table too large for one page.

Split into two tables, one for Execute Command and one for the TMFs.
Move the second column into shaded rows. Merge the third and fourth columns.
Add a Reference column (which has long been needed but didn't fit).

● Author: RElliott
Subject: Cross-Out
Date: 6/30/2008 6:16:52 PM
 ACCEPT - DONE
Delete Remote
as it was removed from SAM-4

● Author: RElliott
Subject: Highlight
Date: 6/30/2008 6:16:52 PM
 ACCEPT - DONE
QUERY UNIT ATTENTION
s/b
QUERY ASYNCHRONOUS EVENT

to match sam4r14h

● Author: RElliott
Subject: Highlight
Date: 6/30/2008 6:16:52 PM
 ACCEPT - DONE
These protocol services
s/b
Transport protocol services

10.2.1.2 Send SCSI Command transport protocol service

An application client uses the Send SCSI Command transport protocol service request to request that an SSP initiator port transmit a COMMAND frame.

Send SCSI Command (IN (I_T_L_Q Nexus, CDB, Task Attribute, [Data-In Buffer Size], [Data-Out Buffer], [Data-Out Buffer Size], [Task Priority], **Command Reference Number**, [First Burst Enabled], [Request Fence]))

Table 197 shows how the arguments to the Send SCSI Command transport protocol service are used.

Table 197 — Send SCSI Command transport protocol service arguments

Argument	SAS SSP implementation
I_T_L_Q nexus	I_T_L_Q nexus, where: a) I specifies the initiator port to send the COMMAND frame; b) T specifies the target port to which the COMMAND frame is to be sent ; c) L specifies the LOGICAL UNIT NUMBER field in the COMMAND frame header; and d) Q specifies the TAG field in the COMMAND frame header.
CDB	Specifies the CDB field in the COMMAND frame.
Task Attribute	Specifies the TASK ATTRIBUTE field in the COMMAND frame.
[Data-In Buffer Size]	Maximum of 2³²
[Data-Out Buffer]	Internal to the SSP initiator port.
[Data-Out Buffer Size]	Maximum of 2 ³²
[Task Priority]	Specifies the TASK PRIORITY field in the COMMAND frame.
[First Burst Enabled]	Specifies the ENABLE FIRST BURST field in the COMMAND frame and to cause the SSP initiator port to transmit the number of bytes indicated by the FIRST BURST SIZE field in the Disconnect-Reconnect mode page (see 10.2.7.2.5) for the SCSI target port without waiting for an XFER_RDY frame.
[Request Fence]	If included, specifies an I_T nexus, I_T_L nexus, or I_T_L_Q nexus for which the COMMAND frame is fenced.

The application client shall set the Request Fence argument to the nexus containing any commands or task management functions that the command affects (e.g., for a PERSISTENT RESERVE OUT command PREEMPT AND ABORT service action, set the Response Fence argument to the I_T_L nexus) or upon which the command depends (e.g., when the Task Attribute argument is set to ORDERED, set the Response Fence argument to the I_T_L_Q nexus of the previous command). If the application client is not able to determine the nexus affected by the command or upon which the command depends, then it should set the Request Fence argument to the I_T nexus.

10.2.1.3 SCSI Command Received transport protocol service

An **SSP target port** uses the SCSI Command Received transport protocol service indication to notify a **device server** that it has received a COMMAND frame.

SCSI Command Received (IN (I_T_L_Q Nexus, CDB, Task Attribute, [Task Priority], [Command Reference Number], [First Burst Enabled]))

Page: 509

Author: RElliott
Subject: Highlight
Date: 6/30/2008 6:16:52 PM
ACCEPT - DONE

Command Reference Number
s/b
CRN
to match sam4r14

Author: wdc-mevans
Subject: Highlight
Date: 5/6/2008 4:07:50 PM

REJECT (The application client is much more likely to use an internal identifier to select the initiator port it wants to send the command; it's unlikely to use the "initiator port identifier" visible on the SAS wire. It's typically an internal relative port number 0..n. Also, "sending" is the wrong word; this service is made to request that the frame be sent; the sending action has not yet begun)

Global
initiator port to send
s/b
initiator port identifier (see table 9) of the SAS initiator port sending

Author: wdc-mevans
Subject: Highlight
Date: 5/6/2008 4:07:50 PM

REJECT (see comment about I and initiator)

Global
target port to which the COMMAND frame is to be sent;
s/b
target port identifier (see table 9) of the SAS target port to which the frame is sent

Author: stx-ghoulder
Subject: Highlight
Date: 6/20/2008 11:00:29 AM

REJECT (The Data Offset field in the SSP frame header is only 4 bytes long and expresses a byte offset value, so the maximum byte that could be accessed is FFFFFFFCh (the maximum Data Offset allowed) + 400h (the maximum frame size of 1024 bytes) = 1_0000_03FCh.

Rules will be added to the DATA and XFER_RDY IU descriptions to restrict transfers to not go past offset FFFFFFFh (i.e., the Data Offset + the number of bytes transferred must not exceed 1_00000000h). Exceeding the 32-bit boundary could break hardware implementations using 32-bit registers for data pointers. After discussion, the limit is being kept at 2^{32} rather than reduced to $(2^{32})-1$

As you note, there are numerous commands whose CDBs can request larger transfer sizes than that - OSD in particular has 8-byte Length fields. However, no SCSI transport protocol to date supports more than 2^{32} bytes per command, as they all have 32-bit fields like Data Offset.

The SCSI Initiator Port and Target Port attributes annex recently added to SAM-4 highlights this fact (listing the maximum Buffer Sizes per transport protocol). Application clients are expected to understand the restrictions placed by the transport protocol and only send CDBs that are possible to service - don't send a block command or OSD command asking for more than 2^{32} bytes on these transport protocols.)

Maximum of 2^{32}
Why this maximum? The maximum length specifiable in SCSI SDB is 2^{32} blocks (not bytes), so can be larger than this.

Author: wdc-mevans
Subject: Highlight
Date: 6/20/2008 11:31:31 AM

Comments from page 509 continued on next page

10.2.1.2 Send SCSI Command transport protocol service

An application client uses the Send SCSI Command transport protocol service request to request that an SSP initiator port transmit a COMMAND frame.

Send SCSI Command (IN (I_T_L_Q Nexus, CDB, Task Attribute, [Data-In Buffer Size], [Data-Out Buffer], [Data-Out Buffer Size], [Task Priority], [Command Reference Number], [First Burst Enabled], [Request Fence]))

Table 197 shows how the arguments to the Send SCSI Command transport protocol service are used.

Table 197 — Send SCSI Command transport protocol service arguments

Argument	SAS SSP implementation
I_T_L_Q nexus	I_T_L_Q nexus, where: a) I specifies the initiator port to send the COMMAND frame; b) T specifies the target port to which the COMMAND frame is to be sent; c) L specifies the LOGICAL UNIT NUMBER field in the COMMAND frame header; and d) Q specifies the TAG field in the COMMAND frame header.
CDB	Specifies the CDB field in the COMMAND frame.
Task Attribute	Specifies the TASK ATTRIBUTE field in the COMMAND frame.
[Data-In Buffer Size]	Maximum of 2 ³²
[Data-Out Buffer]	Internal to the SSP initiator port.
[Data-Out Buffer Size]	Maximum of 2 ³²
[Task Priority]	Specifies the TASK PRIORITY field in the COMMAND frame.
[First Burst Enabled]	Specifies the ENABLE FIRST BURST field in the COMMAND frame and to cause the SSP initiator port to transmit the number of bytes indicated by the FIRST BURST SIZE field in the Disconnect-Reconnect mode page (see 10.2.7.2.5) for the SCSI target port without waiting for an XFER_RDY frame.
[Request Fence]	If included, specifies an I_T nexus, I_T_L nexus, or I_T_L_Q nexus for which the COMMAND frame is fenced.

The application client shall set the Request Fence argument to the nexus containing any commands or task management functions that the command affects (e.g., for a PERSISTENT RESERVE OUT command PREEMPT AND ABORT service action, set the Response Fence argument to the I_T_L nexus) or upon which the command depends (e.g., when the Task Attribute argument is set to ORDERED, set the Response Fence argument to the I_T_L_Q nexus of the previous command). If the application client is not able to determine the nexus affected by the command or upon which the command depends, then it should set the Request Fence argument to the I_T nexus.

10.2.1.3 SCSI Command Received transport protocol service

An SSP target port uses the SCSI Command Received transport protocol service indication to notify a device server that it has received a COMMAND frame.

SCSI Command Received (IN (I_T_L_Q Nexus, CDB, Task Attribute, [Task Priority], [Command Reference Number], [First Burst Enabled]))

T ACCEPT - DONE

Global
Maximum of 2³²
s/b
Maximum of 2³² bytes

Author: RElliott
Subject: Note
Date: 6/30/2008 6:16:52 PM
 REJECT (After further discussion with hardware designers, 2³² is a more logical boundary)

5/7 Change SAS limit to 2³² - 1 (i.e., FFFFFFFh)

This matches what was put into the SAM-4 annex.

Author: RElliott
Subject: Note
Date: 6/30/2008 6:16:52 PM
 ACCEPT - DONE

Add this footnote on the "maximum of 2³²" entries:

See the restrictions on the requested offset field and the write data length field in the SSP XFER_RDY frame (see 9.2.2.3) and the data offset field an SSP DATA frame (see 9.2.2.4).

to go along with wording being added to those sections

Author: lsi-gpenokie
Subject: Highlight
Date: 5/6/2008 4:07:50 PM
T ACCEPT - DONE (globally)

Global
Change << task priority >> to << command priority >>

Author: RElliott
Subject: Note
Date: 6/30/2008 6:16:52 PM
 ACCEPT - DONE

Add:
[CRN] Ignored

to match sam4r14

Author: RElliott
Subject: Highlight
Date: 6/30/2008 6:16:52 PM
T ACCEPT - DONE

and to cause
s/b
and causes

Author: RElliott
Subject: Highlight
Date: 6/30/2008 6:16:52 PM
T ACCEPT - DONE

ENABLE FIRST BURST field
s/b
ENABLE FIRST BURST bit

Author: RElliott
Subject: Highlight

10.2.1.2 Send SCSI Command transport protocol service

An application client uses the Send SCSI Command transport protocol service request to request that an SSP initiator port transmit a COMMAND frame.

Send SCSI Command (IN (I_T_L_Q Nexus, CDB, Task Attribute, [Data-In Buffer Size], [Data-Out Buffer], [Data-Out Buffer Size], [Task Priority], [Command Reference Number], [First Burst Enabled], [Request Fence]))

Table 197 shows how the arguments to the Send SCSI Command transport protocol service are used.

Table 197 — Send SCSI Command transport protocol service arguments

Argument	SAS SSP implementation
I_T_L_Q nexus	I_T_L_Q nexus, where: a) I specifies the initiator port to send the COMMAND frame; b) T specifies the target port to which the COMMAND frame is to be sent; c) L specifies the LOGICAL UNIT NUMBER field in the COMMAND frame header; and d) Q specifies the TAG field in the COMMAND frame header.
CDB	Specifies the CDB field in the COMMAND frame.
Task Attribute	Specifies the TASK ATTRIBUTE field in the COMMAND frame.
[Data-In Buffer Size]	Maximum of 2 ³²
[Data-Out Buffer]	Internal to the SSP initiator port.
[Data-Out Buffer Size]	Maximum of 2 ³²
[Task Priority]	Specifies the TASK PRIORITY field in the COMMAND frame.
[First Burst Enabled]	Specifies the ENABLE FIRST BURST field in the COMMAND frame and to cause the SSP initiator port to transmit the number of bytes indicated by the FIRST BURST SIZE field in the Disconnect-Reconnect mode page (see 10.2.7.2.5) for the SCSI target port without waiting for an XFER_RDY frame.
[Request Fence]	If included, specifies an I_T nexus, I_T_L nexus, or I_T_L_Q nexus for which the COMMAND frame is fenced.

The application client shall set the Request Fence argument to the nexus containing any commands or task management functions that the command affects (e.g., for a PERSISTENT RESERVE OUT command PREEMPT AND ABORT service action, set the Response Fence argument to the I_T_L nexus) or upon which the command depends (e.g., when the Task Attribute argument is set to ORDERED, set the Response Fence argument to the I_T_L_Q nexus of the previous command). If the application client is not able to determine the nexus affected by the command or upon which the command depends, then it should set the Request Fence argument to the I_T nexus.

10.2.1.3 SCSI Command Received transport protocol service

An SSP target port uses the SCSI Command Received transport protocol service indication to notify a device server that it has received a COMMAND frame.

SCSI Command Received (IN (I_T_L_Q Nexus, CDB, Task Attribute, [Task Priority], [Command Reference Number], [First Burst Enabled]))

Date: 6/30/2008 6:16:52 PM

T ACCEPT - DONE

The
s/b
An

Author: RElliott

Subject: Highlight

Date: 7/14/2008 6:49:46 PM

T REJECT ("SSP target port" includes a task router since it equates to a SCSI target port that according to SAM-4 includes a task router. Leave this wording as is; no need to mention the specific object inside the SSP target port that uses this transport protocol service.)

SSP target port
s/b
task router

In SAM-4, the task router does this, not the SCSI target port. Perhaps SSP target port = SCSI target port + task router? Otherwise, chapter 9 is also affected.

Author: RElliott

Subject: Highlight

Date: 8/27/2008 8:00:28 PM

T ACCEPT - DONE (7/14 do it)

device server
s/b
task manager

In SAM-4, the task manager is now the one that puts the command into the task set; the device server takes it out.

Table 198 shows how the arguments to the SCSI Command Received transport protocol service are determined.

Table 198 — SCSI Command Received transport protocol service arguments

Argument	SAS SSP implementation
I_T_L_Q nexus	I_T_L_Q nexus, where: a) I indicates the initiator port that sent the COMMAND frame; b) T indicates the target port that received the COMMAND frame; c) L indicates the value of the LOGICAL UNIT NUMBER field in the COMMAND frame header; and d) Q indicates the value of the TAG field in the COMMAND frame header.
CDB	Indicates the value of the CDB field in the COMMAND frame.
Task Attribute	Indicates the value of the TASK ATTRIBUTE field in the COMMAND frame.
[Task Priority]	Indicates the value of the TASK PRIORITY field in the COMMAND frame.
[Command Reference Number]	Ignored
[First Burst Enabled]	Indicates that first burst data is being delivered based on the ENABLE FIRST BURST field in the COMMAND frame and the FIRST BURST SIZE field in the Disconnect-Reconnect mode page (see 10.2.7.2.5).

10.2.1.4 Send Command Complete transport protocol service

A device server uses the Send Command Complete transport protocol service response to request that an SSP target port transmit a RESPONSE frame.



Send Command Complete (IN (I_T_L_Q Nexus, [Sense Data], [Sense Data Length], Status, Service Response, [Response Fence]))

A device server shall only call Send Command Complete () after receiving SCSI Command Received ().

A device server shall not call Send Command Complete () for a given I_T_L_Q nexus until all its outstanding Receive Data-Out () calls have been responded to with Data-Out Received () and all its outstanding Send Data-In () calls have been responded to with Data-In Delivered ().

● Author: RElliott
Subject: Highlight
Date: 6/30/2008 6:16:52 PM
 ACCEPT - DONE

Command Reference Number
s/b
CRN
to match sam4r14

● Author: RElliott
Subject: Highlight
Date: 6/30/2008 6:16:52 PM
 ACCEPT - DONE

ENABLE FIRST BURST field
s/b
ENABLE FIRST BURST bit

● Author: RElliott
Subject: Note
Date: 6/30/2008 6:16:52 PM
 ACCEPT - DONE

Add [Status Qualifier]

● Author: wdc-mevans
Subject: Highlight
Date: 5/6/2008 4:07:50 PM

 REJECT (other device servers might be making calls as well; without the word "its" you might think you need to wait on those to complete as well. I will add "for that I_T_L_Q nexus" which, although a bit repetitive, should make it clearer.)

its outstanding Receive Data-Out () calls
s/b
all outstanding Receive Data-Out () calls for the nexus

● Author: wdc-mevans
Subject: Highlight
Date: 5/6/2008 4:07:50 PM

 REJECT ("its" is crucial and must remain. Adding "for that I_T_L_Q nexus, though. Changing to an a)b) list too.)

its outstanding Send Data-In () calls have been responded to with Data-In Delivered ()
s/b
outstanding Send Data-In () calls have been responded to with Data-In Delivered () calls for the nexus

Table 199 shows how the arguments to the Send Command Complete transport protocol service are used.

Table 199 — Send Command Complete transport protocol service arguments

Argument	SAS SSP implementation
I_T_L_Q nexus	I_T_L_Q nexus, where: a) I specifies the initiator port to which the RESPONSE frame is to be sent; b) T specifies the target port to send the RESPONSE frame; c) L specifies the LOGICAL UNIT NUMBER field in the RESPONSE frame header; and d) Q specifies the TAG field in the RESPONSE frame header.
[Sense Data]	Specifies the SENSE DATA field in the RESPONSE frame.
[Sense Data Length]	Specifies the SENSE DATA LENGTH field in the RESPONSE frame.
Status	Specifies the STATUS field in the RESPONSE frame.
Service Response	Specifies the DATAPRES field and STATUS field in the RESPONSE frame: a) TASK COMPLETE : The DATAPRES field is set to NO_DATA or SENSE_DATA; or b) SERVICE DELIVERY OR TARGET FAILURE: The DATAPRES field is set to RESPONSE_DATA and the RESPONSE CODE field is set to INVALID FRAME or OVERLAPPED TAG ATTEMPTED.
[Response Fence]	If included, specifies an I_T nexus, I_T_L nexus, or I_T_L_Q nexus for which the RESPONSE frame is fenced.

The device server shall set the Response Fence argument to the nexus containing any commands or task management functions that the command affects (e.g., for a PERSISTENT RESERVE OUT command PREEMPT AND ABORT service action, set the Response Fence argument to the I_T_L nexus) or upon which the command completion depends (e.g., when returning a unit attention condition with an additional sense code set to COMMANDS CLEARED BY ANOTHER INITIATOR, set the Response Fence argument to the I_T_L nexus). If the device server is not able to determine the nexus affected by the command or upon which the command depends, then it should set the Response Fence argument to the I_T nexus.

10.2.1.5 Command Complete Received transport protocol service

An SSP initiator port uses the Command Complete Received transport protocol service confirmation to notify an application client that it has received a response for its COMMAND frame (e.g., a RESPONSE frame or a NAK) or terminated a command because of an error.

 Command Complete Received (IN (I_T_L_Q Nexus, [Data-In Buffer], [Sense Data], Status, Service Response))



● Author: RElliott
Subject: Highlight
Date: 6/30/2008 6:16:52 PM
 ACCEPT - DONE

TASK COMPLETE
s/b
COMMAND COMPLETE

to match sam4r14g

● Author: RElliott
Subject: Highlight
Date: 6/30/2008 6:16:52 PM
 ACCEPT - DONE

The
s/b
A

● Author: RElliott
Subject: Note
Date: 6/30/2008 6:16:52 PM
 ACCEPT - DONE

Add [Status Qualifier]

● Author: RElliott
Subject: Note
Date: 6/30/2008 6:16:52 PM
 ACCEPT - DONE

Add "[Sense Data Length]"
to match table 200 and sam4r14

Table 200 shows how the arguments to the Command Complete Received transport protocol service are determined.

Table 200 — Command Complete Received transport protocol service arguments

Argument	SAS SSP implementation
I_T_L_Q nexus	I_T_L_Q nexus, where: a) I indicates the initiator port that received the RESPONSE frame; b) T indicates the target port that sent the RESPONSE frame; c) L indicates the value of the LOGICAL UNIT NUMBER field in the RESPONSE frame header or COMMAND frame header; and d) Q indicates the value of the TAG field in the RESPONSE frame header or COMMAND frame header.
[Data-In Buffer]	Internal to the SSP initiator port.
[Sense Data]	Indicates the value of the SENSE DATA field in the RESPONSE frame.
[Sense Data Length]	The smaller of the value of the SENSE DATA LENGTH field in the RESPONSE frame and the actual number of sense data bytes received by the SSP initiator port.
Status	Indicates the value of the STATUS field in the RESPONSE frame.
Service Response	From the DATAPRES field and STATUS field in the RESPONSE frame, or from a NAK on the COMMAND frame, or from the ST_IFR state machine detecting an error: a) TASK COMPLETE: The RESPONSE frame contains a DATAPRES field set to NO_DATA or SENSE_DATA; or b) SERVICE DELIVERY OR TARGET FAILURE: The RESPONSE frame contains a DATAPRES field set to RESPONSE_DATA and a RESPONSE CODE field set to INVALID FRAME or OVERLAPPED TAG ATTEMPTED, or a NAK was received for the COMMAND frame, or the length of the RESPONSE frame is incorrect, or the ST_IFR state machine detects an error as described in 9.2.6.2.2.3 and 9.2.6.2.2.4.

10.2.1.6 Send Data-In transport protocol service

A device server uses the Send Data-In transport protocol service request to request that an SSP target port transmit a read DATA frame.

Send Data-In (IN (I_T_L_Q Nexus, Device Server Buffer, Application Client Buffer Offset, Request Byte Count))

A device server shall only call Send Data-In () during a read or bidirectional command.

A device server shall not call Send Data-In () for a given I_T_L_Q nexus after it has called Send Command Complete () for that I_T_L_Q nexus (e.g., a RESPONSE frame with for that I_T_L_Q nexus) or called Task Management Function Executed for a task management function that terminates that task (e.g., an ABORT TASK).

● Author: Isi-gpenokie
Subject: Cross-Out
Date: 5/6/2008 4:07:50 PM

 ACCEPT - DONE

There is no need to this extra << or >>

● Author: RElliott
Subject: Highlight
Date: 9/3/2008 4:13:21 PM

 ACCEPT - DONE

From the DATAPRES field and STATUS field in the RESPONSE frame, or from a NAK on the COMMAND frame, or from the ST_IFR state machine detecting an error

s/b
Either

No need for the details, which are repeated in the a)b) list. STATUS is not pertinent, either.

● Author: RElliott
Subject: Highlight
Date: 6/30/2008 6:16:52 PM

 ACCEPT - DONE

TASK COMPLETE

s/b

COMMAND COMPLETE

to match sam4r13g

● Author: Isi-gpenokie
Subject: Cross-Out
Date: 5/6/2008 4:07:50 PM

 ACCEPT - DONE (restructured this whole b) entry as an A)B)C)D) list)

There is no need to this extra << or >>

● Author: hpq-relliott
Subject: Highlight
Date: 9/3/2008 4:13:58 PM

 ACCEPT - DONE (7/14 point to the state machines for normative text, include some of the important reasons as an e.g. list. note the wording above the list too)

Consider deleting "NAK was received" since it's covered by the ST_IFR reference.

● Author: RElliott
Subject: Note
Date: 9/3/2008 4:09:44 PM

 ACCEPT - DONE (7/17 change b) to include an A)B) list and have the NAK received, etc. in front rather than at the end)

● Author: wdc-mevans
Subject: Highlight
Date: 5/6/2008 4:07:50 PM

 REJECT

it
s/b
device server

Table 201 shows how the arguments to the Send Data-In transport protocol service are used.

Table 201 — Send Data-In transport protocol service arguments

Argument	SAS SSP implementation
I_T_L_Q nexus	I_T_L_Q nexus, where: a) I specifies the initiator port to which the read DATA frame is to be sent; b) T specifies the target port to send the read DATA frame; c) L specifies the LOGICAL UNIT NUMBER field in the read DATA frame header; and d) Q specifies the TAG field in the read DATA frame header.
Device Server Buffer	Internal to the device server.
Application Client Buffer Offset	Specifies the DATA OFFSET field in the read DATA frame.
Request Byte Count	Specifies the size of the read DATA frame.

10.2.1.7 Data-In Delivered transport protocol service

An SSP target port uses the Data-In Delivered transport protocol service indication to notify a device server of the results of transmitting a read DATA frame.

Data-In Delivered (IN (I_T_L_Q Nexus, Delivery Result))

Table 202 shows how the arguments to the Data-In Delivered transport protocol service are determined.

Table 202 — Data-In Delivered transport protocol service arguments

Argument	SAS SSP implementation
I_T_L_Q nexus	I_T_L_Q nexus, where: a) I indicates the initiator port that sent the read DATA frame; b) T indicates the target port that received the read DATA frame; c) L indicates the value of the LOGICAL UNIT NUMBER field in the read DATA frame header; and d) Q indicates the value of the TAG field in the read DATA frame header.
Delivery Result	From the response to the outgoing read DATA frame: a) DELIVERY SUCCESSFUL: The read DATA frame received an ACK; or b) DELIVERY FAILURE: The read DATA frame received a NAK or no response.

10.2.1.8 Receive Data-Out transport protocol service

A device server uses the Receive Data-Out transport protocol service request to request that an SSP target port transmit an XFER_RDY frame.

Receive Data-Out (IN (I_T_L_Q Nexus, Application Client Buffer Offset, Request Byte Count, Device Server Buffer))

A device server shall only call Receive Data-Out () during a write or bidirectional command.

A device server shall not call Receive Data-Out () for a given I_T_L_Q nexus until Data-Out Received () has completed successfully for the previous Receive Data-Out () call (i.e., no XFER_RDY frame until all write DATA frames for the previous XFER_RDY frame, if any, and has provided link layer acknowledgement for all of the previous write DATA frames for that I_T_L_Q nexus).

A device server shall not call Receive Data-Out () for a given I_T_L_Q nexus after a Send Command Complete () has been called for that I_T_L_Q nexus or after a Task Management Function Executed () has been called for a task management function that terminates that task (e.g., an ABORT TASK).

Author: RElliott
Subject: Highlight
Date: 6/30/2008 6:16:52 PM

T ACCEPT - DONE

call

s/b

call for that I_T_L_Q nexus

(to mesh with a Mark Evans comment in 10.2.1.4)

Table 203 shows how the arguments to the Receive Data-Out transport protocol service are used.

Table 203 — Receive Data-Out transport protocol service arguments

Argument	SAS SSP implementation
I_T_L_Q nexus	I_T_L_Q nexus, where: a) I specifies the initiator port to which the XFER_RDY frame is to be sent; b) T specifies the target port to send the XFER_RDY frame; c) L specifies the LOGICAL UNIT NUMBER field in the XFER_RDY frame header; and d) Q specifies the TAG field in the XFER_RDY frame header.
Application Client Buffer Offset	Specifies the REQUESTED OFFSET field in the XFER_RDY frame.
Request Byte Count	Specifies WRITE DATA LENGTH field in the XFER_RDY frame.
Device Server Buffer	Internal to the device server.

10.2.1.9 Data-Out Received transport protocol service

An SSP target port uses the Data-Out Received transport protocol service indication to notify a device server of the result of transmitting an XFER_RDY frame (e.g., receiving write DATA frames in response).

Data-Out Received (IN (I_T_L_Q Nexus, Delivery Result))

Table 204 shows how the arguments to the Data-Out Received transport protocol service are determined.

Table 204 — Data-Out Received transport protocol service arguments

Argument	SAS SSP implementation
I_T_L_Q nexus	I_T_L_Q nexus, where: a) I indicates the initiator port to which the XFER_RDY frame was sent; b) T indicates the target port that sent the XFER_RDY frame; c) L indicates the value of the LOGICAL UNIT NUMBER field in the XFER_RDY frame header; and d) Q indicates the value of the TAG field in the XFER_RDY frame header.
Delivery Result	From the response to the XFER_RDY: a) DELIVERY SUCCESSFUL: The XFER_RDY frame was successfully transmitted and all the write DATA frames for the requested write data were received; or b) DELIVERY FAILURE: The XFER_RDY frame received a NAK or no response.

10.2.1.10 Terminate Data Transfer transport protocol service

A device server uses the Terminate Data Transfer transport protocol service request to request that an SSP target port terminate any Send Data-In () or Receive Data-Out () transport protocol services, if any, being processed using the specified nexus.

Terminate Data Transfer (IN (Nexus))

Table 205 shows how the arguments to the Terminate Data Transfer transport protocol service are used.

Table 205 — Terminate Data Transfer transport protocol service arguments

Argument	SAS SSP implementation
Nexus	I_T nexus, I_T_L nexus, or I_T_L_Q nexus, specifying the scope of the data transfer(s) to terminate.

This page contains no comments

10.2.1.11 Data Transfer Terminated transport protocol service

An SSP target port uses the Data Transfer Terminated transport protocol service indication to notify a device server that all data transfers for the indicated nexus have been terminated.

Data Transfer Terminated (IN (Nexus))

Table 206 shows how the arguments to the Data Transfer Terminated transport protocol service are determined.

Table 206 — Data Transfer Terminated transport protocol service arguments

Argument	SAS SSP implementation
Nexus	I_T nexus, I_T_L nexus, or I_T_L_Q nexus indicated by the preceding Terminate Data Transfer () call.

10.2.1.12 Send Task Management Request transport protocol service

An application client uses the Send Task Management Request transport protocol service request to request that an SSP initiator port transmit a TASK frame.

Send Task Management Request (IN (Nexus, Function Identifier, [Association], [Request Fence]))

Table 207 shows how the arguments to the Send Task Management Request transport protocol service are used.

Table 207 — Send Task Management Request transport protocol service arguments

Argument	SAS SSP implementation
Nexus	I_T_L nexus or I_T_L_Q nexus (depending on the Function Identifier), where: a) I specifies the initiator port to send the TASK frame; b) T specifies the target port to which the TASK frame is sent; c) L specifies the LOGICAL UNIT NUMBER field in the TASK frame header; and d) Q (for an I_T_L_Q nexus) specifies the TAG OF TASK TO BE MANAGED field in the TASK frame header.
Function Identifier	Specifies the TASK MANAGEMENT FUNCTION field in the TASK frame. Only these task management functions are supported: a) ABORT TASK (Nexus argument specifies an I_T_L_Q Nexus); b) ABORT TASK SET (Nexus argument specifies an I_T_L Nexus); c) CLEAR ACA (Nexus argument specifies an I_T_L Nexus); d) CLEAR TASK SET (Nexus argument specifies an I_T_L Nexus); e) I_T NEXUS RESET (Nexus argument specifies an I_T Nexus); f) LOGICAL UNIT RESET (Nexus argument specifies an I_T_L Nexus); g) QUERY TASK (Nexus argument specifies an I_T_L_Q Nexus); h) QUERY TASK SET (Nexus argument specifies an I_T_L Nexus); and i) QUERY UNIT ATTENTION (Nexus argument specifies an I_T_L Nexus).
[Association]	Specifies the TAG field in the TASK frame header.
[Request Fence]	If included, specifies an I_T nexus, I_T_L nexus, or I_T_L_Q nexus for which the TASK frame is fenced.

The application client shall set the Request Fence argument to the Nexus argument.

10.2.1.13 Task Management Request Received transport protocol service

An SSP target port uses the Task Management Request Received transport protocol service indication to notify a task manager that it has received a TASK frame.

Task Management Request Received (IN (Nexus, Function Identifier, [Association]))

Author: RElliott
Subject: Highlight
Date: 6/30/2008 6:16:52 PM
T ACCEPT - DONE

Global:
[Association]
s/b
Association

Since SAS-2 requires that each TMF have an Initiator Port Transfer Tag of its own, this is not an optional argument for the application client/task manager to provide. If SAM-nn ever includes the argument, it might be labeled optional there because it will be protocol-specific. For now, it is a SAS-specific argument that is always used by SAS.

Author: RElliott
Subject: Highlight
Date: 6/30/2008 6:16:52 PM
T ACCEPT - DONE

Before:
I_T_L nexus or I_T_L_Q nexus
add:
I_T nexus

since the I_T NEXUS RESET function is I_T based

Author: RElliott
Subject: Highlight
Date: 6/30/2008 6:16:52 PM
T ACCEPT - DONE

After:
L
add:
(for an I_T_L nexus or an I_T_L_Q nexus)

since I_T NEXUS RESET is I_T based, the L is not always present

Author: RElliott
Subject: Highlight
Date: 6/30/2008 6:16:52 PM
T ACCEPT - DONE

QUERY UNIT ATTENTION
s/b
QUERY ASYNCHRONOUS EVENT

to match sam4r13h

Author: RElliott
Subject: Highlight
Date: 6/30/2008 6:16:52 PM
T ACCEPT - DONE

The
s/b
An

10.2.1.11 Data Transfer Terminated transport protocol service

An SSP target port uses the Data Transfer Terminated transport protocol service indication to notify a device server that all data transfers for the indicated nexus have been terminated.

Data Transfer Terminated (IN (Nexus))

Table 206 shows how the arguments to the Data Transfer Terminated transport protocol service are determined.

Table 206 — Data Transfer Terminated transport protocol service arguments

Argument	SAS SSP implementation
Nexus	I_T nexus, I_T_L nexus, or I_T_L_Q nexus indicated by the preceding Terminate Data Transfer () call.

10.2.1.12 Send Task Management Request transport protocol service

An application client uses the Send Task Management Request transport protocol service request to request that an SSP initiator port transmit a TASK frame.

Send Task Management Request (IN (Nexus, Function Identifier, [Association], [Request Fence]))

Table 207 shows how the arguments to the Send Task Management Request transport protocol service are used.

Table 207 — Send Task Management Request transport protocol service arguments

Argument	SAS SSP implementation
Nexus	I_T_L nexus or I_T_L_Q nexus (depending on the Function Identifier), where: a) I specifies the initiator port to send the TASK frame; b) T specifies the target port to which the TASK frame is sent; c) L specifies the LOGICAL UNIT NUMBER field in the TASK frame header; and d) Q (for an I_T_L_Q nexus) specifies the TAG OF TASK TO BE MANAGED field in the TASK frame header.
Function Identifier	Specifies the TASK MANAGEMENT FUNCTION field in the TASK frame. Only these task management functions are supported: a) ABORT TASK (Nexus argument specifies an I_T_L_Q Nexus); b) ABORT TASK SET (Nexus argument specifies an I_T_L Nexus); c) CLEAR ACA (Nexus argument specifies an I_T_L Nexus); d) CLEAR TASK SET (Nexus argument specifies an I_T_L Nexus); e) I_T NEXUS RESET (Nexus argument specifies an I_T Nexus); f) LOGICAL UNIT RESET (Nexus argument specifies an I_T_L Nexus); g) QUERY TASK (Nexus argument specifies an I_T_L_Q Nexus); h) QUERY TASK SET (Nexus argument specifies an I_T_L Nexus); and i) QUERY UNIT ATTENTION (Nexus argument specifies an I_T_L Nexus).
[Association]	Specifies the TAG field in the TASK frame header.
[Request Fence]	If included, specifies an I_T nexus, I_T_L nexus, or I_T_L_Q nexus for which the TASK frame is fenced.

The application client shall set the Request Fence argument to the Nexus argument.

10.2.1.13 Task Management Request Received transport protocol service

An SSP target port uses the Task Management Request Received transport protocol service indication to notify a task manager that it has received a TASK frame.

Task Management Request Received (IN (Nexus, Function Identifier, [Association]))

Author: RElliott

Subject: Highlight

Date: 7/14/2008 6:50:16 PM

T REJECT (see SCSI Command Received comment)

SSP target port

s/b

task router

In SAM-4, the task router does this, not the SCSI target port. Perhaps SSP target port = SCSI target port + task router? Otherwise, chapter 9 is also affected.

Table 208 shows how the arguments to the Task Management Request Received transport protocol service are determined.

Table 208 — Task Management Request Received transport protocol service arguments

Argument	SAS SSP implementation
Nexus	I_T_L nexus or I_T_L_Q nexus (depending on the Function Identifier), where: <ol style="list-style-type: none"> I indicates the initiator port that sent the TASK frame; T indicates the target port that received the TASK frame; L indicated by the LOGICAL UNIT NUMBER field in the TASK frame header; and Q (for an I_T_L_Q nexus) indicated by the TAG OF TASK TO BE MANAGED field in the TASK frame header
Function Identifier	Indicates the TASK MANAGEMENT FUNCTION field in the TASK frame. Only these task management functions are supported: <ol style="list-style-type: none"> ABORT TASK (Nexus argument indicates an I_T_L_Q Nexus); ABORT TASK SET (Nexus argument indicates an I_T_L Nexus); CLEAR ACA (Nexus argument indicates an I_T_L Nexus); CLEAR TASK SET (Nexus argument indicates an I_T_L Nexus); I_T NEXUS RESET (Nexus argument indicates an I_T Nexus); LOGICAL UNIT RESET (Nexus argument indicates an I_T_L Nexus); QUERY TASK (Nexus argument indicates an I_T_L_Q Nexus); QUERY TASK SET (Nexus argument indicates an I_T_L Nexus); and QUERY UNIT ATTENTION (Nexus argument indicates an I_T_L Nexus).
[Association]	Indicates the TAG field in the TASK frame header.

10.2.1.14 Task Management Function Executed transport protocol service

A task manager uses the Task Management Function Executed transport protocol service response to request that an SSP target port transmit a RESPONSE frame.

Task Management Function Executed (IN (Nexus, Service Response, [Additional Response Information], [Association], [Response Fence]))

A task manager shall only call Task Management Function Executed () after receiving Task Management Request Received ().

Author: RElliott
Subject: Highlight
Date: 6/30/2008 6:16:52 PM
T ACCEPT - DONE

Before:
I_T_L nexus or I_T_L_Q nexus
add:
I_T nexus

since the I_T NEXUS RESET function is I_T based

Author: RElliott
Subject: Highlight
Date: 6/30/2008 6:16:52 PM
T ACCEPT - DONE

indicated by
s/b
indicates

Author: RElliott
Subject: Highlight
Date: 6/30/2008 6:16:52 PM
T ACCEPT - DONE

After:
L
add:
(for an I_T_L nexus or an I_T_L_Q nexus)

since I_T NEXUS RESET is I_T based, the L is not always present

Author: RElliott
Subject: Highlight
Date: 6/30/2008 6:16:52 PM
T ACCEPT - DONE

indicated by
s/b
indicates

Author: RElliott
Subject: Highlight
Date: 6/30/2008 6:16:52 PM
T ACCEPT - DONE

QUERY UNIT ATTENTION
s/b
QUERY ASYNCHRONOUS EVENT

to match sam4r13h

Table 209 shows how the arguments to the Task Management Function Executed transport protocol service are used.

Table 209 — Task Management Function Executed transport protocol service arguments

Argument	SAS SSP implementation
Nexus	<p>I_T_L nexus or I_T_L_Q nexus (depending on the function), where:</p> <ul style="list-style-type: none"> a) I specifies the initiator port to which the RESPONSE frame is sent; b) T specifies the target port to send the RESPONSE frame; c) L specifies the LOGICAL UNIT NUMBER field in the RESPONSE frame header; and d) Q (for an I_T_L_Q nexus) indirectly specifies the TAG field in the RESPONSE frame header.
Service Response	<p>Specifies the DATAPRES field and RESPONSE CODE field in the RESPONSE frame:</p> <ul style="list-style-type: none"> a) FUNCTION COMPLETE: The RESPONSE frame DATAPRES field is set to RESPONSE_DATA and the RESPONSE CODE field is set to TASK MANAGEMENT FUNCTION COMPLETE; b) FUNCTION SUCCEEDED: The RESPONSE frame DATAPRES field is set to RESPONSE_DATA and the RESPONSE CODE field is set to TASK MANAGEMENT FUNCTION SUCCEEDED; c) FUNCTION REJECTED: The DATAPRES field is set to RESPONSE_DATA and the RESPONSE CODE field is set to TASK MANAGEMENT FUNCTION NOT SUPPORTED; d) INCORRECT LOGICAL UNIT NUMBER: The DATAPRES field is set to RESPONSE_DATA and the RESPONSE CODE field is set to INCORRECT LOGICAL UNIT NUMBER; or e) SERVICE DELIVERY OR TARGET FAILURE: The RESPONSE frame DATAPRES field is set to RESPONSE_DATA and the RESPONSE CODE field is set to: <ul style="list-style-type: none"> A) INVALID FRAME; B) TASK MANAGEMENT FUNCTION FAILED; or C) OVERLAPPED TAG ATTEMPTED.
[Additional Response Information]	Specifies the ADDITIONAL RESPONSE INFORMATION field in the RESPONSE frame.
[Association]	Specifies the TAG field in the RESPONSE frame header.
[Response Fence]	If included, specifies an I_T nexus, I_T_L nexus, or I_T_L_Q nexus for which the RESPONSE frame is fenced.

The device server shall set the Response Fence argument to the Nexus argument.

10.2.1.15 Received Task Management Function Executed transport protocol service

An SSP initiator port uses the Received Task Management Function Executed transport protocol service confirmation to notify an application client that it has received a response to a TASK frame (e.g., received a RESPONSE frame or a NAK).

Received Task Management Function Executed (IN (Nexus, Service Response, [Association]))



Page: 517

Author: RElliott
Subject: Highlight
Date: 6/30/2008 6:16:52 PM
 ACCEPT - DONE

Before:
I_T_L nexus or I_T_L_Q nexus
add:
I_T nexus

since the I_T NEXUS RESET function is I_T based

Author: RElliott
Subject: Highlight
Date: 6/30/2008 6:16:52 PM
 ACCEPT - DONE

"the LOGICAL UNIT NUMBER field in the RESPONSE frame header;"
is wrong; there is no such field.
Change to:
"specifies the logical unit that is sending the response frame"

Author: RElliott
Subject: Highlight
Date: 6/30/2008 6:16:52 PM
 ACCEPT - DONE

After:
L
add:
(for an I_T_L nexus or an I_T_L_Q nexus)

since I_T NEXUS RESET is I_T based, the L is not always present

Author: wdc-mevans
Subject: Highlight
Date: 5/29/2008 10:52:26 AM

 ACCEPT - DONE (for this one, simplifying Q to:
"specifies the command that was managed by the task management function". Comments added to L above, and L and Q in table 210)

Global
indirectly specifies the TAG field in the RESPONSE frame header.
s/b
I'm not sure what this means. Doesn't the Q "directly" specify something?

Author: RElliott
Subject: Highlight
Date: 6/30/2008 6:16:52 PM
 ACCEPT - DONE

The
s/b
A

Author: RElliott
Subject: Note
Date: 6/30/2008 6:16:52 PM
 ACCEPT - DONE

Comments from page 517 continued on next page

Table 209 shows how the arguments to the Task Management Function Executed transport protocol service are used.

Table 209 — Task Management Function Executed transport protocol service arguments

Argument	SAS SSP implementation
Nexus	I_T_L nexus or I_T_L_Q nexus (depending on the function), where: a) I specifies the initiator port to which the RESPONSE frame is sent; b) T specifies the target port to send the RESPONSE frame; c) L specifies the LOGICAL UNIT NUMBER field in the RESPONSE frame header; and d) Q (for an I_T_L_Q nexus) indirectly specifies the TAG field in the RESPONSE frame header.
Service Response	Specifies the DATAPRES field and RESPONSE CODE field in the RESPONSE frame: a) FUNCTION COMPLETE: The RESPONSE frame DATAPRES field is set to RESPONSE_DATA and the RESPONSE CODE field is set to TASK MANAGEMENT FUNCTION COMPLETE; b) FUNCTION SUCCEEDED: The RESPONSE frame DATAPRES field is set to RESPONSE_DATA and the RESPONSE CODE field is set to TASK MANAGEMENT FUNCTION SUCCEEDED; c) FUNCTION REJECTED: The DATAPRES field is set to RESPONSE_DATA and the RESPONSE CODE field is set to TASK MANAGEMENT FUNCTION NOT SUPPORTED; d) INCORRECT LOGICAL UNIT NUMBER: The DATAPRES field is set to RESPONSE_DATA and the RESPONSE CODE field is set to INCORRECT LOGICAL UNIT NUMBER; or e) SERVICE DELIVERY OR TARGET FAILURE: The RESPONSE frame DATAPRES field is set to RESPONSE_DATA and the RESPONSE CODE field is set to: A) INVALID FRAME; B) TASK MANAGEMENT FUNCTION FAILED; or C) OVERLAPPED TAG ATTEMPTED.
[Additional Response Information]	Specifies the ADDITIONAL RESPONSE INFORMATION field in the RESPONSE frame.
[Association]	Specifies the TAG field in the RESPONSE frame header.
[Response Fence]	If included, specifies an I_T nexus, I_T_L nexus, or I_T_L_Q nexus for which the RESPONSE frame is fenced.

The device server shall set the Response Fence argument to the Nexus argument.

10.2.1.15 Received Task Management Function Executed transport protocol service

An SSP initiator port uses the Received Task Management Function Executed transport protocol service confirmation to notify an application client that it has received a response to a TASK frame (e.g., received a RESPONSE frame or a NAK).

Received Task Management Function Executed (IN (Nexus, Service Response, [Association]))



Add:
[Additional Response Information]

to match table 210 and sam4r14

Table 210 shows how the arguments to the Received Task Management Function Executed transport protocol service are determined.

Table 210 — Received Task Management Function Executed transport protocol service arguments

Argument	SAS SSP implementation
Nexus	I_T_L nexus or I_T_L_Q nexus (depending on the function), where: <ol style="list-style-type: none"> I indicates the initiator port that received the RESPONSE frame; T indicates the target port that sent the RESPONSE frame; L indicates the LOGICAL UNIT NUMBER field in the RESPONSE frame header or TASK frame header; and Q (for an I_T_L_Q nexus) indirectly indicates the TAG field in the RESPONSE frame header, or indicates the TAG OF TASK TO BE MANAGED field TASK frame header.
Service Response	Indicates the response to the TASK frame: <ol style="list-style-type: none"> FUNCTION COMPLETE: The RESPONSE frame contains a DATAPRES field set to RESPONSE_DATA and a RESPONSE CODE field set to TASK MANAGEMENT FUNCTION COMPLETE; FUNCTION SUCCEEDED: The RESPONSE frame contains a DATAPRES field set to RESPONSE_DATA and a RESPONSE CODE field set to TASK MANAGEMENT FUNCTION SUCCEEDED; FUNCTION REJECTED: The RESPONSE frame contains a DATAPRES field set to RESPONSE_DATA and a RESPONSE CODE field set to TASK MANAGEMENT FUNCTION NOT SUPPORTED; INCORRECT LOGICAL UNIT NUMBER: The RESPONSE frame contains a DATAPRES field set to RESPONSE_DATA and a RESPONSE CODE field set to INCORRECT LOGICAL UNIT NUMBER; or SERVICE DELIVERY OR TARGET FAILURE: The RESPONSE frame contains a DATAPRES field set to RESPONSE_DATA and a RESPONSE CODE field set to: <ol style="list-style-type: none"> INVALID FRAME; TASK MANAGEMENT FUNCTION FAILED; or OVERLAPPED TAG ATTEMPTED, or a NAK was received for the TASK frame, or the length of the RESPONSE frame is incorrect.
[Additional Response Information]	Indicates the ADDITIONAL RESPONSE INFORMATION field in the RESPONSE frame.
[Association]	Indicates the TAG field in the RESPONSE frame header or the TASK frame header.

10.2.2 Application client error handling

If an SSP initiator port calls Command Complete Received () with a Service Response of:

- Service Delivery or Target Failure - XFER_RDY Information Unit Too Short;
- Service Delivery or Target Failure - XFER_RDY Information Unit Too Long;
- Service Delivery or Target Failure - XFER_RDY Incorrect Write Data Length;
- Service Delivery or Target Failure - XFER_RDY Requested Offset Error;
- Service Delivery or Target Failure - XFER_RDY Not Expected;
- Service Delivery or Target Failure - DATA Information Unit Too Short;
- Service Delivery or Target Failure - DATA Too Much Read Data;
- Service Delivery or Target Failure - DATA Data Offset Error;
- Service Delivery or Target Failure - DATA Not Expected; or
- Service Delivery or Target Failure - NAK Received,

then the application client shall abort the command (e.g., by sending an ABORT TASK task management function).

Author: RElliott
Subject: Highlight
Date: 6/30/2008 6:16:52 PM

T ACCEPT - DONE
"indicates the LOGICAL UNIT NUMBER field in the RESPONSE frame header or TASK frame header;"
is wrong, as there is no such field in the RESPONSE frame header.

Change to:

"indicates the logical unit that sent the response frame, and is indicated by the logical unit number field of the TASK frame with an initiator port transfer tag field equal to the initiator port transfer tag field in the RESPONSE frame header"

Author: RElliott
Subject: Underline
Date: 6/30/2008 6:16:52 PM

T ACCEPT - DONE
"indirectly indicates the TAG field in the RESPONSE frame header, or indicates the TAG OF TASK TO BE MANAGED field TASK frame header "

Per wdc-mevans comment on table 209, expand what "indirectly" means.

Change to:

indicates the command that was managed by the task management function, and is indicated by the initiator port transfer tag field of the COMMAND frame with an initiator port transfer tag field equal to the initiator port transfer tag to manage field in the TASK frame with an initiator port transfer tag field equal to the initiator port transfer tag field in the RESPONSE frame header

Author: RElliott
Subject: Highlight
Date: 6/30/2008 6:16:52 PM

T ACCEPT - DONE
field TASK frame
s/b
field in the TASK frame

Author: Isi-gpenokie
Subject: Highlight
Date: 9/3/2008 4:07:06 PM

T ACCEPT - DONE (7/17 move the extra items before the A)B)C) list to avoid any confusion.
this text is inside item e), not outside)

This statement << or a NAK was received for the TASK frame, or the length of the RESPONSE frame is incorrect. >> should be before the list and stated as << Indicates the response to the TASK frame, a NAK was received for the TASK frame, or the length of the RESPONSE frame is incorrect:. >>

Author: RElliott
Subject: Highlight
Date: 8/29/2008 7:00:07 PM

T ACCEPT - DONE (changed to Incorrect Data Length)
Service Delivery or Target Failure - DATA Information Unit Too Short;

when ST_IFS receives a data offset of 0 (or number of fill bytes non-zero too early), it returns DATA Incorrect Data Length.) Either that name needs to change, or another set of names needs to be added.

After an application client calls Send SCSI Command (), if Command Complete Received () returns a Service Response of Service Delivery or Target Failure - ACK/NAK Timeout, the application client shall send a QUERY TASK task management function with Send Task Management Request () to determine whether the command was received successfully. If Received Task Management Function Executed () returns a Service Response of FUNCTION SUCCEEDED, the application client shall assume the command was delivered successfully. If Received Task Management Function Executed () returns a Service Response of FUNCTION COMPLETE, and Command Complete Received () has not yet been invoked a second time for the command in question (e.g., indicating a RESPONSE frame arrived for the command before the QUERY TASK was processed), the application client shall assume the command was not delivered successfully and may reuse the tag. The application client should call Send SCSI Command () again with identical arguments.

After a Received Task Management Function Executed () call with a Service Response of Service Delivery or Target Failure - ACK/NAK Timeout, an application client should call Send Task Management Request () with identical arguments, including the same tag.

After a Command Complete Received () or Received Task Management Function Executed () call returns a Service Response other than Service Delivery or Target Failure - ACK/NAK Timeout, an application client shall not reuse the tag until it determines the tag is no longer in use by the logical unit (e.g., the ACK for the RESPONSE frame was seen by the SSP target port). Examples of ways the application client may determine that a tag may be used are:

- a) receiving another frame in the same connection;
- b) receiving a DONE (NORMAL) or DONE (CREDIT TIMEOUT) in the same connection; or
- c) receiving a DONE (ACK/NAK TIMEOUT) in the same connection, then running a QUERY TASK task management function to confirm that the tag is no longer active in the logical unit.

10.2.3 Device server error handling

If the SCSI target device performs tag checking and an SSP target port calls SCSI Command Received () with a tag already in use by another SCSI command (i.e., an overlapped command) in any logical unit, the task router and device server(s) shall abort all task management functions received on that L_T nexus and shall respond to the overlapped command as defined in SAM-4.

If an SSP target port calls Data-Out Received () with a Delivery Result set to a value in table 211, the device server shall terminate the command with CHECK CONDITION status with the sense key set to ABORTED COMMAND and the additional sense code set as indicated in table 211.

Table 211 — Delivery Result to additional sense code mapping

Delivery Result	Additional sense code
DELIVERY FAILURE - DATA OFFSET ERROR	DATA OFFSET ERROR
DELIVERY FAILURE - TOO MUCH WRITE DATA	TOO MUCH WRITE DATA
DELIVERY FAILURE - INFORMATION UNIT TOO SHORT	INFORMATION UNIT TOO SHORT
DELIVERY FAILURE - ACK/NAK TIMEOUT	ACK/NAK TIMEOUT
DELIVERY FAILURE - NAK RECEIVED	NAK RECEIVED
DELIVERY FAILURE - INITIATOR RESPONSE TIMEOUT	INITIATOR RESPONSE TIMEOUT

10.2.4 Task router and task manager error handling

If the SCSI target device performs tag checking and:

- a) an SSP target port calls SCSI Command Received () with a tag already in use by a SCSI task management function in any logical unit; or
- b) an SSP target port calls Task Management Request Received () with a tag already in use by a SCSI command or SCSI task management function in any logical unit,

Page: 519

● Author: Isi-gpenokie
Subject: Highlight
Date: 5/6/2008 4:07:50 PM

 ACCEPT - DONE

This << Timeout, the application client >> should be << Timeout, then the application client

● Author: Isi-gpenokie
Subject: Highlight
Date: 5/6/2008 4:07:50 PM

 ACCEPT - DONE

This << SUCCEEDED, the application >> should be << SUCCEEDED, then the application >>

● Author: Isi-gpenokie
Subject: Highlight
Date: 5/6/2008 4:07:50 PM

 ACCEPT - DONE

This << processed), the application >> should be << processed), then the application >>

● Author: RElliott
Subject: Highlight
Date: 6/30/2008 6:16:52 PM

 ACCEPT - DONE

the
s/b
a

● Author: RElliott
Subject: Note
Date: 6/30/2008 6:16:52 PM

 ACCEPT - DONE

In SAM-4, the task router/task manager are now the ones that do overlapped command checking. The task manager puts the command into the task set; the device server takes it out.

Move this paragraph into 10.2.4, and change "device server" to "task router and task manager(s)"

● Author: Isi-gpenokie
Subject: Highlight
Date: 5/6/2008 4:07:50 PM

 ACCEPT - DONE

This << in any logical unit, the task >> should be << in any logical unit, then the task >>

● Author: RElliott
Subject: Highlight
Date: 6/30/2008 6:16:52 PM

 ACCEPT - DONE

SCSI command
s/b
command

Other uses in this section don't include "SCSI"

● Author: RElliott
Subject: Underline
Date: 6/30/2008 6:16:52 PM

 ACCEPT - DONE

Convert the second part of this sentence into an a)b) list.

Comments from page 519 continued on next page

After an application client calls Send SCSI Command (), if Command Complete Received () returns a Service Response of Service Delivery or Target Failure - ACK/NAK Timeout, the application client shall send a QUERY TASK task management function with Send Task Management Request () to determine whether the command was received successfully. If Received Task Management Function Executed () returns a Service Response of FUNCTION SUCCEEDED, the application client shall assume the command was delivered successfully. If Received Task Management Function Executed () returns a Service Response of FUNCTION COMPLETE, and Command Complete Received () has not yet been invoked a second time for the command in question (e.g., indicating a RESPONSE frame arrived for the command before the QUERY TASK was processed), the application client shall assume the command was not delivered successfully and may reuse the tag. The application client should call Send SCSI Command () again with identical arguments.

After a Received Task Management Function Executed () call with a Service Response of Service Delivery or Target Failure - ACK/NAK Timeout, an application client should call Send Task Management Request () with identical arguments, including the same tag.

After a Command Complete Received () or Received Task Management Function Executed () call returns a Service Response other than Service Delivery or Target Failure - ACK/NAK Timeout, an application client shall not reuse the tag until it determines the tag is no longer in use by the logical unit (e.g., the ACK for the RESPONSE frame was seen by the SSP target port). Examples of ways the application client may determine that a tag may be used are:

- a) receiving another frame in the same connection;
- b) receiving a DONE (NORMAL) or DONE (CREDIT TIMEOUT) in the same connection; or
- c) receiving a DONE (ACK/NAK TIMEOUT) in the same connection, then running a QUERY TASK task management function to confirm that the tag is no longer active in the logical unit.

10.2.3 Device server error handling

If the SCSI target device performs tag checking and an SSP target port calls SCSI Command Received () with a tag already in use by another SCSI command (i.e., an overlapped command) in any logical unit, the task router and device server(s) shall abort all task management functions received on that L_T nexus and shall respond to the overlapped command as defined in SAM-4.

If an SSP target port calls Data-Out Received () with a Delivery Result set to a value in table 211, the device server shall terminate the command with CHECK CONDITION status with the sense key set to ABORTED COMMAND and the additional sense code set as indicated in table 211.

Table 211 — Delivery Result to additional sense code mapping

Delivery Result	Additional sense code
DELIVERY FAILURE - DATA OFFSET ERROR	DATA OFFSET ERROR
DELIVERY FAILURE - TOO MUCH WRITE DATA	TOO MUCH WRITE DATA
DELIVERY FAILURE - INFORMATION UNIT TOO SHORT	INFORMATION UNIT TOO SHORT
DELIVERY FAILURE - ACK/NAK TIMEOUT	ACK/NAK TIMEOUT
DELIVERY FAILURE - NAK RECEIVED	NAK RECEIVED
DELIVERY FAILURE - INITIATOR RESPONSE TIMEOUT	INITIATOR RESPONSE TIMEOUT

10.2.4 Task router and task manager error handling

If the SCSI target device performs tag checking and:

- a) an SSP target port calls SCSI Command Received () with a tag already in use by a SCSI task management function in any logical unit; or
- b) an SSP target port calls Task Management Request Received () with a tag already in use by a SCSI command or SCSI task management function in any logical unit,

● Author: stx-goulder
Subject: Highlight
Date: 6/27/2008 9:36:47 AM

T REJECT (SAM-4 covers the rules for commands, so they are covered by "and respond to the overlapped command as defined in SAM-4". SAM-4 does not cover the rules for TMFs, since it doesn't recognize that they might share tags with commands, so only TMFs rules are directly mentioned here.)

abort all task management functions received on that I_T nexus

Overlapped commands should result in both commands (or maybe all commands) being aborted, not task management functions aborted. If a Task management function overlaps a command some different rules might apply.

● Author: Isi-gpenokie
Subject: Highlight
Date: 5/6/2008 4:07:50 PM

T ACCEPT - DONE
This << in table 211, the device >> should be << in table 211, then the device >>

● Author: RElliott
Subject: Highlight
Date: 6/30/2008 6:16:52 PM

T ACCEPT - DONE

the
s/b
a

● Author: RElliott
Subject: Highlight
Date: 6/30/2008 6:16:52 PM

T ACCEPT - DONE

SCSI task management function
s/b
task management function

Other uses in this section don't use "SCSI"

● Author: RElliott
Subject: Highlight
Date: 6/30/2008 6:16:52 PM

T ACCEPT - DONE

SCSI command or SCSI task management function
s/b
command or task management function

Most other uses do not include "SCSI" in this section

then the task router and task manager(s) shall:

- a) abort all commands received on that I_T nexus;
- b) abort all task management functions received on that I_T nexus; and
- c) call Task Management Function Executed () with the Service Response set to FUNCTION REJECTED - Overlapped Tag Attempted (i.e., requesting that the target port set the DATAPRES field to RESPONSE_DATA and the RESPONSE CODE field set to OVERLAPPED TAG ATTEMPTED).

10.2.5 SCSI transport protocol event notifications

Table 212 lists the SCSI transport protocol event notifications supported by this standard.

Table 212 — SCSI transport protocol events

Event notification	SAS SSP implementation
Transport Reset	Receipt of a hard reset sequence (see 4.4.2)
Nexus Loss	Receipt of specific OPEN_REJECTs for a specific time period (see 4.5).
Power Loss Expected	Receipt of a NOTIFY (POWER LOSS EXPECTED)(see 7.2.5.3.3)



10.2.6 SCSI commands

10.2.6.1 INQUIRY command

The vital product data returned by the INQUIRY command (see SPC-4) that shall be returned by a logical unit in a SAS device is described in 10.2.11.

10.2.6.2 MODE SELECT and MODE SENSE commands

SAS-specific mode pages accessed with the MODE SELECT and MODE SENSE commands (see SPC-4) are described in 10.2.7.

10.2.6.3 LOG SELECT and LOG SENSE commands

SAS-specific log pages accessed with the LOG SELECT and LOG SENSE commands (see SPC-4) are described in 10.2.8.

10.2.6.4 SEND DIAGNOSTIC and RECEIVE DIAGNOSTIC RESULTS commands

SAS-specific diagnostic pages accessed with the SEND DIAGNOSTIC and RECEIVE DIAGNOSTIC RESULTS commands (see SPC-4) are described in 10.2.9.

Zoning (see 4.9) is applied to SES-2 diagnostic pages as described in 10.2.9.

10.2.6.5 START STOP UNIT command

The power condition states controlled by the START STOP UNIT command (see SBC-3) for a SAS device are described in 10.2.10.

● Author: stx-goulder

Subject: Highlight

Date: 5/6/2008 4:07:50 PM

T REJECT (SAM-4 only covers what happens when a command is received that overlaps another command. SAS has to define what happens when a command is received that overlaps a TMF, or when a TMF is received that overlaps a command or a TMF.)

task router and task manager(s) shall:

The previous clause says this error shall be handled as defined in SAM-4, but this clause specifies a particular handling that could be different than what SAM-4 says. Need to resolve this contradiction.

● Author: RElliott

Subject: Note

Date: 6/30/2008 6:16:52 PM

 ACCEPT - DONE

make left column of table 212 wider to avoid wrapping

● Author: lsi-gpenokie

Subject: Highlight

Date: 5/6/2008 4:07:50 PM

T ACCEPT - DONE (as "The vital product data that shall be returned by a logical unit in a SAS device by the INQUIRY command")

This

<< The vital product data returned by the INQUIRY command (see SPC-4) that shall be returned by a logical unit in a SAS device is described in 10.2.11. >> should be

<< The vital product data that shall be returned as a result of an INQUIRY command (see SPC-4) to a logical unit in a SAS device is described in 10.2.11. >>

10.2.7 SCSI mode parameters

10.2.7.1 SCSI mode parameters overview

Table 213 defines mode pages supported by logical units in SCSI target devices in SAS domains (i.e., with SSP target ports) that support the MODE SELECT or MODE SENSE commands.

Table 213 — SSP target port mode pages

Mode page code	Subpage code	Description	Reference
02h	00h	Disconnect-Reconnect mode page	10.2.7.2
18h	00h	Protocol-Specific Logical Unit mode page	10.2.7.3
	01h - DFh	Reserved	
	E0h - FEh	Vendor specific	
	FFh	Return all subpages for this mode page code	SPC-4
19h	00h	Protocol-Specific Port mode page	10.2.7.4
	01h	Phy Control And Discover mode page	10.2.7.5
	02h	Shared Port Control mode page	10.2.7.6
	03h	SAS-2 Phy mode page	10.2.7.7
	04h - DFh	Reserved	
	E0h - FEh	Vendor specific	
	FFh	Return all subpages for this mode page code	SPC-4

If any field in an implemented mode page is not implemented, the value assumed for the functionality of the field shall be zero (i.e., as if the field is set to zero) (see SPC-4).

If a mode page defined by this standard is not implemented, the value assumed for the functionality of each field in that mode page that is:

- a) ~~allowed by this standard to be changeable; and~~
- b) ~~is not used solely to define the mode page structure (e.g., the NUMBER OF PHYS field in the Phy Control And Discover mode page) or coordinate access to the mode page (e.g., the GENERATION CODE field in the Phy Control And Discover mode page), shall be zero (i.e., as if the mode page is implemented and the field is set to zero).~~

10.2.7.2 Disconnect-Reconnect mode page

10.2.7.2.1 Disconnect-Reconnect mode page overview

The Disconnect-Reconnect mode page (see SPC-4) provides the application client the means to tune the performance of a service delivery subsystem. Table 214 defines the parameters which are applicable to SSP.

The application client sends the values in the fields to be used by the device server to control the SSP connections by means of a MODE SELECT command. The device server shall then communicate the field values to the SSP target port. The field values are communicated from the device server to the SSP target port in a vendor-specific manner.

Page: 521

Author: lsi-gpenokie
Subject: Highlight
Date: 6/2/2008 9:41:11 AM
T ACCEPT - DONE (adding "then" too)

This << not implemented, the value assumed for the functionality of the field shall be zero (i.e., as if the field is set to zero) >> should be << not implemented, the value of the field shall be assumed to be zero (i.e., as if the field is set to zero) >>

Author: wdc-mevans
Subject: Cross-Out
Date: 6/2/2008 9:40:48 AM
T REJECT (This standard defines fields as not changeable or may be changeable. It does not mandate that any fields be changeable, though. So, we must say "allowed by this standard to be changeable." In a), added "(e.g., not defined as a read only field)".

For b), there are already e.g.'s showing that fields like NUMBER OF PHYS fields are the ones being referred to. Those are not assumed to be zero by this rule; they're irrelevant.)

If a mode page defined by this standard is not implemented, the value assumed for the functionality of each field in that mode page that is:

- a) allowed by this standard to be changeable; and
- b) is not used solely to define the mode page structure (e.g., the NUMBER OF PHYS field in the Phy Control And Discover mode page) or coordinate access to the mode page (e.g., the GENERATION CODE field in the Phy Control And Discover mode page), shall be zero (i.e., as if the mode page is implemented and the field is set to zero).

[I recommend deleting this because I don't understand it at all. How can a field in a mode page that isn't implemented be changeable? How does a field define the mode page structure or coordinate access to the page? And, ultimately, though the conjunction has been omitted, the field shall be set to zero.]

Author: stx-goulder
Subject: Highlight
Date: 6/2/2008 9:41:26 AM
T REJECT (see replies to wdc-mevans)

not implemented,
Rules a) and b) below make no sense to me for an unimplemented mode page. How can an unimplemented value be changeable? how can a mode page structure exist if it isn't implemented?

Author: lsi-gpenokie
Subject: Highlight
Date: 6/2/2008 9:36:42 AM
T ACCEPT - DONE (although the grammar is spread out before/after the a)b) list, so not exactly as suggested)

This << not implemented, the value assumed for the functionality of each field in that mode page that is: >> should be << not implemented, the value for each field in that mode page shall be assumed to be: >>

Author: lsi-gpenokie
Subject: Cross-Out
Date: 5/6/2008 4:07:50 PM
T ACCEPT - DONE
T This << is >> seems to be an extra word.

Author: ibm-steve-wallace
Subject: Highlight
Date: 5/6/2008 4:07:50 PM
T ACCEPT - DONE
T This text should probably be on the next line (not part of item b).

SAS devices shall only use the parameter fields defined below in this subclause. If any other fields within the Disconnect-Reconnect mode page of the MODE SELECT command contain a non-zero value, the device server shall terminate the MODE SELECT command with CHECK CONDITION status with the sense key set to ILLEGAL REQUEST and the additional sense code set to INVALID FIELD IN PARAMETER LIST.

Table 214 — Disconnect-Reconnect mode page for SSP

Byte/Bit	7	6	5	4	3	2	1	0
0	PS	SPF (0b)	PAGE CODE (02h)					
1	PAGE LENGTH (0Eh)							
2	Reserved							
3	Reserved							
4	(MSB)	BUS INACTIVITY TIME LIMIT						(LSB)
5								
6	Reserved							
7								
8	(MSB)	MAXIMUM CONNECT TIME LIMIT						(LSB)
9								
10	(MSB)	MAXIMUM BURST SIZE						(LSB)
11								
12	Reserved							
13								
14	(MSB)	FIRST BURST SIZE						(LSB)
15								

The PARAMETERS SAVEABLE (PS) bit is defined in SPC-4.

The SUBPAGE FORMAT (SPF) bit is defined in SPC-4 and shall be set to the value defined in table 214.

The PAGE CODE (PS) field is defined in SPC-4 and shall be set to the value defined in table 214.

The PAGE LENGTH field is defined in SPC-4 and shall be set to the value defined in table 214.

The BUS INACTIVITY TIME LIMIT field is defined in SPC-4 and 10.2.7.2.2.

The MAXIMUM CONNECT TIME LIMIT field is defined in SPC-4 and 10.2.7.2.3.

The MAXIMUM BURST SIZE field is defined in SPC-4 and 10.2.7.2.4.

The FIRST BURST SIZE field is defined in SPC-4 and 10.2.7.2.5.

10.2.7.2.2 BUS INACTIVITY TIME LIMIT field

The value in the BUS INACTIVITY TIME LIMIT field contains the maximum time in 100 μs increments that an SSP target port is permitted to maintain a connection (see 4.1.12) without transferring a frame to the SSP initiator port. When this time is exceeded, the SSP target port shall prepare to close the connection (i.e., by requesting to have the link layer transmit DONE). This value may be rounded as defined in SPC-4. A value of 0000h in

● Author: Isi-gpenokie
Subject: Highlight
Date: 5/6/2008 4:07:50 PM
T ACCEPT - DONE

This << shall only use the parameter fields defined below in this subclause. If a >> should be << shall only the parameter fields defined in table 214. If a >>

● Author: Isi-gpenokie
Subject: Highlight
Date: 5/6/2008 4:07:50 PM
T ACCEPT - DONE

This << non-zero value, the device >> should be << non-zero value, then the device >>

● Author: stx-goulder
Subject: Highlight
Date: 5/6/2008 4:07:50 PM

T REJECT (that is what defines that this bit is set to 0 rather than 1 in this page. This is the convention recently adopted in SBC-3 and SES-2 for describing fields like this.)

and shall be set to the value defined in table 214.
This phrase in this sentence and the next 2 sentences can be deleted.

● Author: RElliott
Subject: Cross-Out
Date: 6/30/2008 6:16:52 PM
T ACCEPT - DONE

(PS)

this field specifies that there is no bus inactivity time limit. The bus inactivity time limit is enforced by the port layer (see 8.2.3).

10.2.7.2.3 MAXIMUM CONNECT TIME LIMIT field

The value in the MAXIMUM CONNECT TIME LIMIT field contains the maximum duration of a connection (see 4.1.12) in 100 μ s increments (e.g., a value of 0001h in this field means that the time is less than or equal to 100 μ s and a value of 0002h in this field means that the time is less than or equal to 200 μ s). When this time is exceeded, the SSP target port shall prepare to close the connection. If an SSP target port is transferring a frame when the maximum connection time limit is exceeded, the SSP target port shall complete transfer of the frame before preparing to close the connection. This value may be rounded as defined in SPC-4. A value of 0000h in this field specifies that there is no maximum connection time limit. The maximum connection time limit is enforced by the port layer (see 8.2.3).

10.2.7.2.4 MAXIMUM BURST SIZE field

For read data, the value in the MAXIMUM BURST SIZE field contains the maximum amount of data that is transferred during a connection by an SSP target port per I_T_L_Q nexus without transferring at least one frame for a different I_T_L_Q nexus. If the SSP target port:

- a) has read data to transfer for only one I_T_L_Q nexus, and
- b) has no requests to transfer write data for any I_T_L_Q nexus,

then the SSP target port shall prepare to close the connection after the amount of data specified by the MAXIMUM BURST SIZE field is transferred to the SSP initiator port.

For write data, the value shall specify the maximum amount of data that an SSP target port requests via a single XFER_RDY frame (see 9.2.2.3).

This value shall be specified in 512-byte increments (e.g., a value of one in this field means that the number of bytes transferred to the SSP initiator port for the nexus is less than or equal to 512 and a value of two in this field means that the number of bytes transferred to the SSP initiator port for the nexus is less than or equal to 1 024). A value of zero in this field shall specify that there is no maximum burst size.

In terms of the SCSI transport protocol services (see 10.2.1), the device server shall limit the Request Byte Count argument to the Receive Data-Out () protocol service and the Send Data-In () protocol service to the amount specified in this field.

10.2.7.2.5 FIRST BURST SIZE field

If the ENABLE FIRST BURST field in the COMMAND frame is set to zero, the FIRST BURST SIZE field is ignored.

If the ENABLE FIRST BURST field in the COMMAND frame is set to one, the value in the FIRST BURST SIZE field contains the maximum amount of write data in 512-byte increments that may be sent by the SSP initiator port to the SSP target port without having to receive an XFER_RDY frame (see 9.2.2.3) from the SSP target port (e.g., a value of one in this field means that the number of bytes transferred by the SSP initiator port is less than or equal to 512 and a value of two in this field means that the number of bytes transferred by the SSP initiator port is less than or equal to 1 024).

Specifying a non-zero value in the FIRST BURST SIZE field is equivalent to an implicit XFER_RDY frame for each command requiring write data where the WRITE DATA LENGTH field of the XFER_RDY frame is set to 512 times the value of the FIRST BURST SIZE field.

The rules for data transferred using the value in the FIRST BURST SIZE field are the same as those used for data transferred for an XFER_RDY frame (i.e., the number of bytes transferred using the value in the FIRST BURST SIZE field is as if that number of bytes was requested by an XFER_RDY frame).

If the amount of data to be transferred for the command is less than the amount of data specified by the FIRST BURST SIZE field, the SSP target port shall not transmit an XFER_RDY frame for the command. If the amount of data to be transferred for the command is greater than the amount of data specified by the FIRST BURST SIZE field, the SSP target port shall transmit an XFER_RDY frame after it has received all of the data specified by the FIRST BURST SIZE field from the SSP initiator port. All data for the command is not required to be transferred during the same connection in which the command is transferred.

Author: RElliott
Subject: Highlight
Date: 6/30/2008 6:16:52 PM
T ACCEPT - DONE
the
s/b
then the

Author: RElliott
Subject: Highlight
Date: 6/30/2008 6:16:52 PM
T ACCEPT - DONE
data
s/b
data in 512-byte increments

Author: RElliott
Subject: Highlight
Date: 6/30/2008 6:16:52 PM
T ACCEPT - DONE
nexus. If

Paragraph break in between

Author: RElliott
Subject: Highlight
Date: 6/30/2008 6:16:52 PM
T ACCEPT - DONE
one
s/b
0001h

Author: RElliott
Subject: Highlight
Date: 6/30/2008 6:16:52 PM
T ACCEPT - DONE
shall be
s/b
is

This is a statement of fact. There is no possibility of any other interpretation (there's no "units" field that is required to be set to "512")

Author: RElliott
Subject: Highlight
Date: 6/30/2008 6:16:52 PM
T ACCEPT - DONE
two
s/b
0002h

Author: RElliott
Subject: Highlight
Date: 6/30/2008 6:16:52 PM

this field specifies that there is no bus inactivity time limit. The bus inactivity time limit is enforced by the port layer (see 8.2.3).

10.2.7.2.3 MAXIMUM CONNECT TIME LIMIT field

The value in the MAXIMUM CONNECT TIME LIMIT field contains the maximum duration of a connection (see 4.1.12) in 100 μ s increments (e.g., a value of 0001h in this field means that the time is less than or equal to 100 μ s and a value of 0002h in this field means that the time is less than or equal to 200 μ s). When this time is exceeded, the SSP target port shall prepare to close the connection. If an SSP target port is transferring a frame when the maximum connection time limit is exceeded, the SSP target port shall complete transfer of the frame before preparing to close the connection. This value may be rounded as defined in SPC-4. A value of 0000h in this field specifies that there is no maximum connection time limit. The maximum connection time limit is enforced by the port layer (see 8.2.3).

10.2.7.2.4 MAXIMUM BURST SIZE field

For read data, the value in the MAXIMUM BURST SIZE field contains the maximum amount of data that is transferred during a connection by an SSP target port per I_T_L_Q nexus without transferring at least one frame for a different I_T_L_Q nexus. If the SSP target port:

- a) has read data to transfer for only one I_T_L_Q nexus, and
- b) has no requests to transfer write data for any I_T_L_Q nexus,

then the SSP target port shall prepare to close the connection after the amount of data specified by the MAXIMUM BURST SIZE field is transferred to the SSP initiator port.

For write data, the value shall specify the maximum amount of data that an SSP target port requests via a single XFER_RDY frame (see 9.2.2.3).

This value shall be specified in 512-byte increments (e.g., a value of one in this field means that the number of bytes transferred to the SSP initiator port for the nexus is less than or equal to 512 and a value of two in this field means that the number of bytes transferred to the SSP initiator port for the nexus is less than or equal to 1 024). A value of zero in this field shall specify that there is no maximum burst size.

In terms of the SCSI transport protocol services (see 10.2.1), the device server shall limit the Request Byte Count argument to the Receive Data-Out () protocol service and the Send Data-In () protocol service to the amount specified in this field.

10.2.7.2.5 FIRST BURST SIZE field

If the ENABLE FIRST BURST field in the COMMAND frame is set to zero, the FIRST BURST SIZE field is ignored.

If the ENABLE FIRST BURST field in the COMMAND frame is set to one, the value in the FIRST BURST SIZE field contains the maximum amount of write data in 512-byte increments that may be sent by the SSP initiator port to the SSP target port without having to receive an XFER_RDY frame (see 9.2.2.3) from the SSP target port (e.g., a value of one in this field means that the number of bytes transferred by the SSP initiator port is less than or equal to 512 and a value of two in this field means that the number of bytes transferred by the SSP initiator port is less than or equal to 1 024).

Specifying a non-zero value in the FIRST BURST SIZE field is equivalent to an implicit XFER_RDY frame for each command requiring write data where the WRITE DATA LENGTH field of the XFER_RDY frame is set to 512 times the value of the FIRST BURST SIZE field.

The rules for data transferred using the value in the FIRST BURST SIZE field are the same as those used for data transferred for an XFER_RDY frame (i.e., the number of bytes transferred using the value in the FIRST BURST SIZE field is as if that number of bytes was requested by an XFER_RDY frame).

If the amount of data to be transferred for the command is less than the amount of data specified by the FIRST BURST SIZE field, the SSP target port shall not transmit an XFER_RDY frame for the command. If the amount of data to be transferred for the command is greater than the amount of data specified by the FIRST BURST SIZE field, the SSP target port shall transmit an XFER_RDY frame after it has received all of the data specified by the FIRST BURST SIZE field from the SSP initiator port. All data for the command is not required to be transferred during the same connection in which the command is transferred.

T ACCEPT - DONE

512 and
s/b
512, and

Author: RElliott
Subject: Highlight
Date: 6/30/2008 6:16:52 PM

T ACCEPT - DONE

shall specify
s/b
specifies

This is a statement of fact, not a requirement on any entity

Author: RElliott
Subject: Highlight
Date: 6/30/2008 6:16:52 PM

T ACCEPT - DONE

zero
s/b
0000h

Author: RElliott
Subject: Highlight
Date: 6/30/2008 6:16:52 PM

T ACCEPT - DONE

the
s/b
then the

Author: RElliott
Subject: Highlight
Date: 6/30/2008 6:16:52 PM

T ACCEPT - DONE
ENABLE FIRST BURST field

s/b
ENABLE FIRST BURST bit

Author: RElliott
Subject: Highlight
Date: 6/30/2008 6:16:52 PM

T ACCEPT - DONE

the
s/b
then the

Author: RElliott
Subject: Highlight
Date: 6/30/2008 6:16:52 PM

T ACCEPT - DONE
ENABLE FIRST BURST field

s/b
ENABLE FIRST BURST bit

Author: RElliott
Subject: Highlight
Date: 6/30/2008 6:16:52 PM

this field specifies that there is no bus inactivity time limit. The bus inactivity time limit is enforced by the port layer (see 8.2.3).

10.2.7.2.3 MAXIMUM CONNECT TIME LIMIT field

The value in the MAXIMUM CONNECT TIME LIMIT field contains the maximum duration of a connection (see 4.1.12) in 100 μ s increments (e.g., a value of 0001h in this field means that the time is less than or equal to 100 μ s and a value of 0002h in this field means that the time is less than or equal to 200 μ s). When this time is exceeded, the SSP target port shall prepare to close the connection. If an SSP target port is transferring a frame when the maximum connection time limit is exceeded, the SSP target port shall complete transfer of the frame before preparing to close the connection. This value may be rounded as defined in SPC-4. A value of 0000h in this field specifies that there is no maximum connection time limit. The maximum connection time limit is enforced by the port layer (see 8.2.3).

10.2.7.2.4 MAXIMUM BURST SIZE field

For read data, the value in the MAXIMUM BURST SIZE field contains the maximum amount of data that is transferred during a connection by an SSP target port per I_T_L_Q nexus without transferring at least one frame for a different I_T_L_Q nexus. If the SSP target port:

- a) has read data to transfer for only one I_T_L_Q nexus, and
- b) has no requests to transfer write data for any I_T_L_Q nexus,

then the SSP target port shall prepare to close the connection after the amount of data specified by the MAXIMUM BURST SIZE field is transferred to the SSP initiator port.

For write data, the value shall specify the maximum amount of data that an SSP target port requests via a single XFER_RDY frame (see 9.2.2.3).

This value shall be specified in 512-byte increments (e.g., a value of one in this field means that the number of bytes transferred to the SSP initiator port for the nexus is less than or equal to 512 and a value of two in this field means that the number of bytes transferred to the SSP initiator port for the nexus is less than or equal to 1 024). A value of zero in this field shall specify that there is no maximum burst size.

In terms of the SCSI transport protocol services (see 10.2.1), the device server shall limit the Request Byte Count argument to the Receive Data-Out () protocol service and the Send Data-In () protocol service to the amount specified in this field.

10.2.7.2.5 FIRST BURST SIZE field

If the ENABLE FIRST BURST field in the COMMAND frame is set to zero, the FIRST BURST SIZE field is ignored.

If the ENABLE FIRST BURST field in the COMMAND frame is set to one, the value in the FIRST BURST SIZE field contains the maximum amount of write data in 512-byte increments that may be sent by the SSP initiator port to the SSP target port without having to receive an XFER_RDY frame (see 9.2.2.3) from the SSP target port (e.g., a value of one in this field means that the number of bytes transferred by the SSP initiator port is less than or equal to 512 and a value of two in this field means that the number of bytes transferred by the SSP initiator port is less than or equal to 1 024).

Specifying a non-zero value in the FIRST BURST SIZE field is equivalent to an implicit XFER_RDY frame for each command requiring write data where the WRITE DATA LENGTH field of the XFER_RDY frame is set to 512 times the value of the FIRST BURST SIZE field.

The rules for data transferred using the value in the FIRST BURST SIZE field are the same as those used for data transferred for an XFER_RDY frame (i.e., the number of bytes transferred using the value in the FIRST BURST SIZE field is as if that number of bytes was requested by an XFER_RDY frame).

If the amount of data to be transferred for the command is less than the amount of data specified by the FIRST BURST SIZE field, the SSP target port shall not transmit an XFER_RDY frame for the command. If the amount of data to be transferred for the command is greater than the amount of data specified by the FIRST BURST SIZE field, the SSP target port shall transmit an XFER_RDY frame after it has received all of the data specified by the FIRST BURST SIZE field from the SSP initiator port. All data for the command is not required to be transferred during the same connection in which the command is transferred.

T ACCEPT - DONE

one
s/b
0001h

● Author: RElliott
Subject: Highlight
Date: 6/30/2008 6:16:52 PM

T ACCEPT - DONE

two
s/b
0002h

● Author: RElliott
Subject: Highlight
Date: 6/30/2008 6:16:52 PM

T ACCEPT - DONE

the
s/b
then the

● Author: RElliott
Subject: Highlight
Date: 6/30/2008 6:16:52 PM

T ACCEPT - DONE

the
s/b
then the

A value of zero in this field shall specify that there is no first burst size (i.e., an SSP initiator port shall transmit no write DATA frames to the SSP target port before receiving an XFER_RDY frame).

The first burst size is handled by the SCSI transport protocol services (see 10.2.1) and the SSP transport layer (see 9.2.6).

10.2.7.3 Protocol-Specific Logical Unit mode page

The Protocol-Specific Logical Unit mode page (see SPC-4) contains parameters that affect SSP target port operation on behalf of the logical unit.

The mode page policy (see SPC-4) for this mode page shall be either shared or per target port. If the SAS target device has multiple SSP target ports, the mode page policy should be per target port.

Parameters in this mode page:

- a) shall affect all phys in the SSP target port if the mode page policy is per target port; or
- b) shall affect all SSP target ports in the SAS target device if the mode page policy is shared.

Table 215 defines the format of the page for SAS SSP.

Table 215 — Protocol-Specific Logical Unit mode page for SAS SSP

Byte/Bit	7	6	5	4	3	2	1	0
0	PS	SPF (0b)	PAGE CODE (18h)					
1	PAGE LENGTH (06h)							
2	Reserved			TRANSPORT LAYER RETRIES	PROTOCOL IDENTIFIER (6h)			
3	Reserved							
7	Reserved							

The PARAMETERS SAVEABLE (PS) bit is defined in SPC-4.

The SUBPAGE FORMAT (SPF) bit is defined in SPC-4 and shall be set to the value defined in table 215.

The PAGE CODE field is defined in SPC-4 and shall be set to the value defined in table 215.

The PAGE LENGTH field is defined in SPC-4 and shall be set to the value defined in table 215.

A TRANSPORT LAYER RETRIES bit set to one specifies that, for commands received in COMMAND frames with the TLR CONTROL field set to 00b or 11b (see 9.2.1), the target port shall support transport layer retries for XFER_RDY and DATA frames for the logical unit as described in 9.2.4 (i.e., transport layer retries are enabled). A TRANSPORT LAYER RETRIES bit set to zero specifies that, for commands received in COMMAND frames with the TLR CONTROL field set to 00b or 11b (see 9.2.1), transport layer retries shall not be used (i.e., transport layer retries are disabled).

NOTE 97 - The TRANSPORT LAYER RETRIES bit may become obsolete in a future version of this standard.

The PROTOCOL IDENTIFIER field is defined in SPC-4 and shall be set to the value defined in table 215 indicating that this is a SAS SSP specific mode page.

10.2.7.4 Protocol-Specific Port mode page

The Protocol-Specific Port mode page (see SPC-4) contains parameters that affect SSP target port operation. If the mode page is implemented by one logical unit in a SCSI target device, it shall be implemented by all logical units in the SCSI target device that support the MODE SELECT or MODE SENSE commands.

● Author: RElliott
Subject: Highlight
Date: 6/30/2008 6:16:52 PM
T ACCEPT - DONE

shall transmit
s/b
transmits

● Author: RElliott
Subject: Highlight
Date: 6/30/2008 6:16:52 PM
T ACCEPT - DONE

shall specify that
s/b
specifies that

● Author: RElliott
Subject: Highlight
Date: 6/30/2008 6:16:52 PM
T ACCEPT - DONE

zero
s/b
0000h

● Author: RElliott
Subject: Highlight
Date: 6/30/2008 6:16:52 PM
T ACCEPT - DONE

the
s/b
then the

● Author: stx-ghoulder
Subject: Highlight
Date: 5/6/2008 4:07:50 PM
T REJECT

and shall be set to the value defined in table 215.
This phrase in this sentence and the next 2 sentences should be deleted. SPC-4 correctly and fully defines these fields and SAS should usurp those definitions.

● Author: RElliott
Subject: Highlight
Date: 6/30/2008 6:16:52 PM
T ACCEPT - DONE

it
s/b
then it

The mode page policy (see SPC-4) for this mode page shall be either shared or per target port. If a SAS target device has multiple SSP target ports, **the mode page policy should be per target port.**

Parameters in this mode page:

- a) shall affect all phys in the SSP target port if the mode page policy is per target port; or
- b) shall affect all SSP target ports in the SAS target device if the mode page policy is shared.

Table 216 defines the format of the page for SAS SSP.

Table 216 — Protocol-Specific Port mode page for SAS SSP

Byte\Bit	7	6	5	4	3	2	1	0
0	PS	SPF (0b)	PAGE CODE (19h)					
1	PAGE LENGTH (0Dh)							
2	Reserved	CONTINUE AWT	BROADCAST ASYNCHRONOUS EVENT	READY LED MEANING	PROTOCOL IDENTIFIER (6h)			
3	Reserved							
4	(MSB)	I_T NEXUS LOSS TIME						(LSB)
5								
6	(MSB)	INITIATOR RESPONSE TIMEOUT						(LSB)
7								
8	(MSB)	REJECT TO OPEN LIMIT						(LSB)
9								
10	Reserved							
15								

The PARAMETERS SAVEABLE (PS) bit is defined in SPC-4.

The SUBPAGE FORMAT (SPF) bit is defined in SPC-4 **and shall be set to the value defined in table 216.**

The PAGE CODE field is defined in SPC-4 and shall be set to the value defined in table 216.

The PAGE LENGTH field is defined in SPC-4 and shall be set to the value defined in table 216.

A CONTINUE AWT bit set to one specifies that the SAS port shall not stop the Arbitration Wait Time timer **and set the Arbitration Wait Time timer to zero** when the SAS port receives an OPEN_REJECT (RETRY). A CONTINUE AWT bit set to zero specifies that the SAS port shall stop the Arbitration Wait Time timer and set the Arbitration Wait Time timer to zero when **it** receives an OPEN_REJECT (RETRY).

A BROADCAST ASYNCHRONOUS EVENT bit set to one specifies that the device server shall enable origination of Broadcast (Asynchronous Event) (see 4.1.13). A BROADCAST ASYNCHRONOUS EVENT bit set to zero specifies that the device server shall disable origination of Broadcast (Asynchronous Event).

The READY LED MEANING bit specifies the READY LED signal behavior (see 10.4.1). Regardless of the mode page policy (see SPC-4) for this mode page, the shared mode page policy shall be applied to the READY LED MEANING bit.

The PROTOCOL IDENTIFIER field is defined in SPC-4 and shall be set to the value defined in table 216 indicating that this is a SAS SSP specific mode page.

● Author: RElliott
Subject: Highlight
Date: 6/30/2008 6:16:52 PM
T ACCEPT - DONE
the
s/b
then the

● Author: wdc-mevans
Subject: Highlight
Date: 5/6/2008 4:07:50 PM
T ACCEPT - DONE
0Dh
s/b
0Eh

● Author: hpq-relliott
Subject: Highlight
Date: 5/6/2008 4:07:50 PM
T ACCEPT - DONE
PAGE LENGTH (0Dh) [13]
s/b
PAGE LENGTH (0Eh) [14]

● Author: stx-ghoulder
Subject: Highlight
Date: 5/6/2008 4:07:50 PM
T REJECT
and shall be set to the value defined in table 216.
Same comment as in earlier mode pages.

● Author: wdc-mevans
Subject: Highlight
Date: 5/6/2008 4:07:50 PM
T ACCEPT - DONE (the current wording means "shall not (A and B)". Agree the new wording is clearer ("shall not A and shall not B")
though.)

and set the Arbitration Wait Time timer to zero
s/b
and shall not set the Arbitration Wait Time timer to zero

● Author: wdc-mevans
Subject: Highlight
Date: 5/6/2008 4:07:50 PM
T REJECT
it
s/b
the SAS port

The I_T NEXUS LOSS TIME field contains the minimum time that the SSP target port shall retry connection requests to an SSP initiator port that are rejected with certain responses indicating that the SSP initiator port may no longer be present (see 8.2.2) before recognizing an I_T nexus loss (see 4.5). Table 217 defines the values of the I_T NEXUS LOSS TIME field. This value is enforced by the port layer (see 8.2.2).

Table 217 — I_T NEXUS LOSS TIME field

Code	Description
0000h	Vendor-specific amount of time.
0001h to FFFEh	Time in milliseconds.
FFFFh	The SSP target port shall never recognize an I_T nexus loss (i.e., it shall retry the connection requests forever).

NOTE 98 - If this mode page is implemented, the default value of the I_T NEXUS LOSS TIME field should be non-zero. It is recommended that this value be 2 000 ms.

NOTE 99 - An SSP initiator port should retry connection requests for at least the time indicated by the I_T NEXUS LOSS TIME field in the Protocol-Specific Port mode page for the SSP target port to which it is trying to establish a connection (see 4.5).

The INITIATOR RESPONSE TIMEOUT field contains the minimum time in milliseconds that the SSP target port shall wait for the receipt of a frame (e.g., a write DATA frame) before aborting the command associated with that frame. An INITIATOR RESPONSE TIMEOUT field set to 0000h indicates that the SSP target port shall disable the initiator response timeout timer. This value is enforced by the transport layer (see 9.2.6.3).

The REJECT TO OPEN LIMIT field contains the minimum time in 10 μ s increments that the target port shall wait to establish a connection request with an initiator port on an I_T nexus after receiving an OPEN_REJECT (RETRY), OPEN_REJECT (CONTINUE 0), or OPEN_REJECT (CONTINUE 1). This value may be rounded as defined in SPC-4. A REJECT TO OPEN LIMIT field set to 0000h indicates that the minimum time is vendor specific. This minimum time is enforced by the port layer (see 8.2.3).

10.2.7.5 Phy Control And Discover mode page

The Phy Control And Discover mode page contains parameters that affect SSP target phy operation. If the mode page is implemented by one logical unit in a SCSI target device, it shall be implemented by all logical units in the SCSI target device that support the MODE SELECT or MODE SENSE commands.

The mode page policy (see SPC-4) for this mode page shall be shared. Parameters in this mode page shall affect only the referenced phy.

● Author: wdc-mevans
Subject: Highlight
Date: 5/29/2008 11:02:38 AM
T REJECT

that
s/b
when connection requests from the SSP target port

● Author: wdc-mevans
Subject: Highlight
Date: 5/29/2008 11:02:06 AM

T REJECT ("recognizing" also used in table 217. This is not something that is "processed". The application layer might "process" the Nexus Loss event notification, but want to stick with using the term "I_T nexus loss" here rather than Nexus Loss.)

recognizing
s/b
the SSP target port processes

● Author: RElliott
Subject: Highlight
Date: 6/30/2008 6:16:52 PM

T ACCEPT - DONE
the
s/b
then the

● Author: RElliott
Subject: Highlight
Date: 6/30/2008 6:16:52 PM

T ACCEPT - DONE
it
s/b
then it

Table 218 defines the format of this mode page.

Table 218 — Phy Control And Discover mode page

Byte\Bit	7	6	5	4	3	2	1	0
0	PS	SPF (1b)	PAGE CODE (19h)					
1	SUBPAGE CODE (01h)							
2	(MSB)	PAGE LENGTH (n - 3)						(LSB)
3								
4	Reserved							
5	Reserved				PROTOCOL IDENTIFIER (6h)			
6	GENERATION CODE							
7	NUMBER OF PHYS							
SAS phy mode descriptor list								
8	SAS phy mode descriptor (first)(see table 219)							
55								
...	...							
n - 47	SAS phy mode descriptor (last)(see table 219)							
n								

The PARAMETERS SAVEABLE (PS) bit is defined in SPC-4.

The SUBPAGE FORMAT (SPF) bit is defined in SPC-4 and shall be set to the value defined in table 218.

The PAGE CODE field is defined in SPC-4 and shall be set to the value defined in table 218.

The SUBPAGE CODE field is defined in SPC-4 and shall be set to the value defined in table 218.

The PAGE LENGTH field is defined in SPC-4 and shall be set to the value defined in table 218 (i.e., 4 + (the value of the NUMBER OF PHYS field) × (the length in bytes of the SAS phy mode descriptor)).

The PROTOCOL IDENTIFIER field is defined in SPC-4 and shall be set to the value defined in table 218 indicating that this is a SAS SSP specific mode page.

The GENERATION CODE field is a one-byte counter that shall be incremented by one by the device server every time the values in this mode page or the SAS-2 Phy mode page (see 10.2.7.7) field values are changed. A GENERATION CODE field set to 00h indicates the generation code is unknown. The device server shall wrap this field to 01h as the next increment after reaching its maximum value (i.e., FFh). The GENERATION CODE field is also contained in the Protocol-Specific Port log page and may be used to correlate phy settings across mode page and log page accesses.

NOTE 100 - Device servers compliant with previous versions of this standard set the GENERATION CODE field to 00h.

The NUMBER OF PHYS field contains the number of phys in the SAS target device and indicates the number of SAS phy mode descriptors that follow. This field shall not be changeable with the MODE SELECT command.

The SAS phy mode descriptor list contains a SAS phy mode descriptor for each phy in the SAS target device, not just the SAS target port, starting with the lowest numbered phy and ending with the highest numbered phy.

Author: Isi-gpenokie

Subject: Highlight

Date: 5/6/2008 4:07:50 PM

 ACCEPT - DONE (per 4th grade math, it doesn't NEED any more parenthesis)

This << (i.e., 4 + (the value of the NUMBER OF PHYS field) × (the length in bytes of the SAS phy mode descriptor)). >> needs another set of () so it is clear whether the + operation or the x operation is done first.

Author: wdc-mevans

Subject: Cross-Out

Date: 5/6/2008 4:07:50 PM

 ACCEPT - DONE

 field values

[Delete the redundant words.]

Author: wdc-mevans

Subject: Highlight

Date: 5/29/2008 11:04:21 AM

 ACCEPT - DONE

the

s/b

the SAS-2 Phy mode page and the

Author: RElliott

Subject: Cross-Out

Date: 6/30/2008 6:16:52 PM

 ACCEPT - DONE

that follow.

(matching Isi-gpenokie comment elsewhere)

Table 219 defines the SAS phy mode descriptor.

Table 219 — SAS phy mode descriptor

Byte\Bit	7	6	5	4	3	2	1	0
0	Reserved							
1	PHY IDENTIFIER							
2	Reserved							
3	Reserved							
4	Reserved	ATTACHED DEVICE TYPE			ATTACHED REASON			
5	REASON				NEGOTIATED LOGICAL LINK RATE			
6	Reserved				ATTACHED SSP INITIATOR PORT	ATTACHED STP INITIATOR PORT	ATTACHED SMP INITIATOR PORT	Reserved
7	Reserved				ATTACHED SSP TARGET PORT	ATTACHED STP TARGET PORT	ATTACHED SMP TARGET PORT	Reserved
8	SAS ADDRESS							
15	SAS ADDRESS							
16	ATTACHED SAS ADDRESS							
23	ATTACHED SAS ADDRESS							
24	ATTACHED PHY IDENTIFIER							
25	Reserved							
31	Reserved							
32	PROGRAMMED MINIMUM PHYSICAL LINK RATE				HARDWARE MINIMUM PHYSICAL LINK RATE			
33	PROGRAMMED MAXIMUM PHYSICAL LINK RATE				HARDWARE MAXIMUM PHYSICAL LINK RATE			
34	Reserved							
41	Reserved							
42	Vendor specific							
43	Vendor specific							
44	Reserved							
47	Reserved							

The PROGRAMMED MINIMUM PHYSICAL LINK RATE field and PROGRAMMED MAXIMUM PHYSICAL LINK RATE field are defined in the SMP PHY CONTROL function (see 10.4.3.28) for accesses with MODE SELECT commands and in the SMP DISCOVER function (see 10.4.3.10) for accesses with MODE SENSE commands.

This page contains no comments

The fields in the SAS phy mode descriptor not defined in this subclause are defined in the SMP DISCOVER response (see 10.4.3.10). These fields shall not be changeable with the MODE SELECT command.

10.2.7.6 Shared Port Control mode page

The Shared Port Control mode page contains parameters that affect SSP target port operation. If the mode page is implemented by one logical unit in a **SCSI target device, it shall be implemented** by all logical units in the SCSI target device that support the MODE SELECT or MODE SENSE commands.

The mode page policy (see SPC-4) for this mode page shall be shared.

Table 220 defines the format of this mode page.

Table 220 — Shared Port Control mode page

Byte\Bit	7	6	5	4	3	2	1	0
0	PS	SPF (1b)	PAGE CODE (19h)					
1	SUBPAGE CODE (02h)							
2	(MSB)	PAGE LENGTH (000Ch)						(LSB)
3	Reserved							
4	Reserved				PROTOCOL IDENTIFIER (6h)			
5	(MSB)	POWER LOSS TIMEOUT						(LSB)
6	Reserved							
7	Reserved							
8	Reserved							
15	Reserved							

The PARAMETERS SAVEABLE (PS) bit is defined in SPC-4.

The SUBPAGE FORMAT (SPF) bit is defined in SPC-4 and shall be set to the value defined in table 220.

The PAGE CODE field is defined in SPC-4 and shall be set to the value defined in table 220.

The SUBPAGE CODE field is defined in SPC-4 and shall be set to the value defined in table 220.

The PAGE LENGTH field is defined in SPC-4 and shall be set to the value defined in table 220.

The PROTOCOL IDENTIFIER field is defined in SPC-4 and shall be set to the value defined in table 220 indicating that this is a SAS SSP specific mode page.

The POWER LOSS TIMEOUT field contains the maximum time, in one millisecond increments, that a target port shall respond to connection requests with OPEN_REJECT (RETRY) after receiving NOTIFY (POWER LOSS EXPECTED) (see 7.2.5.3.3). A POWER LOSS TIMEOUT field set to 0000h specifies that the maximum time is vendor-specific. The power loss timeout shall be restarted on each NOTIFY (POWER LOSS EXPECTED) that is received.

10.2.7.7 SAS-2 Phy mode page

The SAS-2 Phy mode page contains parameters that affect SSP target phy operation ~~that were first defined in SAS-2~~. If the mode page is implemented by one logical unit in a SCSI target device, **it** shall be implemented by all logical units in the SCSI target device that support the MODE SELECT or MODE SENSE commands.

The mode page policy (see SPC-4) for this mode page shall be shared. Parameters in this mode page shall affect only the referenced **phy**.

Page: 529

● Author: Isi-gpenokie
Subject: Highlight
Date: 5/6/2008 4:07:50 PM
T ACCEPT - DONE

This << SCSI target device, it shall be implemented >> should be << SCSI target device, then it shall be implemented >>

● Author: RElliott
Subject: Highlight
Date: 8/27/2008 8:05:17 PM
T ACCEPT - DONE (rename this globally. Also affects the mode descriptor name.)

SAS-2 Phy mode page
s/b
Enhanced Phy Control mode page

● Author: Isi-gpenokie
Subject: Cross-Out
Date: 8/27/2008 8:05:42 PM
T ACCEPT - DONE (with the name change)

This << that were first defined in SAS-2 >> is not a relevant statement and should be deleted. If you insist that it be in the standard it would have to be a note.

● Author: RElliott
Subject: Highlight
Date: 6/30/2008 6:16:52 PM
T ACCEPT - DONE

it
s/b
then it

● Author: stx-ghoulder
Subject: Highlight
Date: 5/29/2008 11:05:08 AM
T ACCEPT - DONE (deleted the sentence)

phy
In general, this should be plural. Also the sentence should be obvious since each phy has its own descriptor. The sentence should be deleted.

Table 221 defines the format of this mode page.

Table 221 — SAS-2 Phy mode page

Byte\Bit	7	6	5	4	3	2	1	0
0	PS	SPF (1b)	PAGE CODE (19h)					
1	SUBPAGE CODE (03h)							
2	(MSB)	PAGE LENGTH (n - 3)						(LSB)
3								
4	Reserved							
5	Reserved				PROTOCOL IDENTIFIER (6h)			
6	GENERATION CODE							
7	NUMBER OF PHYS							
SAS-2 phy mode descriptor list								
8	SAS-2 phy mode descriptor (first)(see table 222)							
27								
...	...							
n - 19	SAS-2 phy mode descriptor (last)(see table 222)							
n								

The PARAMETERS SAVEABLE (PS) bit is defined in SPC-4.

The SUBPAGE FORMAT (SPF) bit is defined in SPC-4 and shall be set to the value defined in table 221.

The PAGE CODE field is defined in SPC-4 and shall be set to the value defined in table 221.

The SUBPAGE CODE field is defined in SPC-4 and shall be set to the value defined in table 221.

The PAGE LENGTH field is defined in SPC-4 and shall be set to the value defined in table 221 (i.e., 4 + (the value of the NUMBER OF PHYS field) × (the length in bytes of the SAS phy mode descriptor)).

The PROTOCOL IDENTIFIER field is defined in SPC-4 and shall be set to the value defined in table 221 indicating that this is a SAS SSP specific mode page.

The GENERATION CODE field is defined in the Phy Control and Discover mode page (see 10.2.7.5).

The NUMBER OF PHYS field contains the number of phys in the SAS target device and indicates the number of SAS-2 phy mode descriptors that follow. This field shall not be changeable with the MODE SELECT command.

The SAS-2 phy mode descriptor list contains a SAS-2 phy mode descriptor for each phy in the SAS target device, not just the SAS target port, starting with the lowest numbered phy and ending with the highest numbered phy.

Author: RElliott
Subject: Cross-Out
Date: 6/30/2008 6:16:52 PM
 ACCEPT - DONE

that follow.

(matching Isi-gpenokie comment elsewhere)

Table 222 defines the SAS-2 phy mode descriptor.

Table 222 — SAS-2 phy mode descriptor

Byte\Bit	7	6	5	4	3	2	1	0	
0	Reserved								
1	PHY IDENTIFIER								
2	(MSB)	DESCRIPTOR LENGTH (0010h)						(LSB)	
3									
4	PROGRAMMED PHY CAPABILITIES								
7									
8	CURRENT PHY CAPABILITIES								
11									
12	ATTACHED PHY CAPABILITIES								
15									
16	Reserved								
17									
18	Reserved			NEGOTIATED SSC	NEGOTIATED PHYSICAL LINK RATE				
19	Reserved							HARDWARE MUXING SUPPORTED	

The DESCRIPTOR LENGTH field contains the length in bytes that follow in the descriptor and shall be set to 10h.

The fields in the SAS-2 phy mode descriptor not defined in this subclause are defined in the SMP DISCOVER response (see 10.4.3.10). These fields shall not be changeable with the MODE SELECT command.

Author: RElliott
Subject: Underline
Date: 6/30/2008 6:16:52 PM
T ACCEPT - DONE

shall be set to 10h.

s/b

shall be set to the value defined in table 222.

10.2.8 SCSI log parameters

10.2.8.1 Protocol-Specific Port log page

The Protocol-Specific Port log page for SAS SSP defined in table 223 is used to return information about phy events concerning the SAS target device's phy(s).

Table 223 — Protocol-Specific Port log page for SAS SSP

Byte\Bit	7	6	5	4	3	2	1	0
0	DS	SPF (0b)	PAGE CODE (18h)					
1	SUBPAGE CODE (00h)							
2	(MSB)	PAGE LENGTH (n - 3)						(LSB)
3								
Protocol-specific port log parameter list								
4	Protocol-specific port log parameter (first)(see table 224)							
...	...							
n	Protocol-specific port log parameter (last)(see table 224)							

The DISABLE SAVE (DS) bit is defined in SPC-4.

The SUBPAGE FORMAT (SPF) bit is defined in SPC-4 and shall be set to the value defined in table 223.

The PAGE CODE field is defined in SPC-4 and shall be set to the value defined in table 223.

The SUBPAGE CODE field is defined in SPC-4 and shall be set to the value defined in table 223.

The PAGE LENGTH field is defined in SPC-4 and shall be set to the value defined in table 223.

The protocol-specific port log parameter list contains a protocol-specific port log parameter for each SCSI port in the SAS target device.

Author: stx-ghoulder
Subject: Highlight
Date: 5/6/2008 4:07:50 PM

 ACCEPT - DONE

SPC-4and

Add a space before "and".

Table 224 defines the format for the Protocol-Specific Port log parameter for SAS. The SAS log parameter is a list parameter (i.e., not a data counter) and only has cumulative (i.e., not threshold) values (see SPC-4).

Table 224 — Protocol-Specific Port log parameter for SAS

Byte\Bit	7	6	5	4	3	2	1	0
0	(MSB) _____							
1	PARAMETER CODE (relative target port identifier)						_____ (LSB)	
2	Parameter control byte							
	DU	Obsolete	TSD	ETC	TMC		FORMAT AND LINKING	
3	PARAMETER LENGTH (y - 3)							
4	Reserved				PROTOCOL IDENTIFIER (6h)			
5	Reserved							
6	GENERATION CODE							
7	NUMBER OF PHYS							
SAS phy log descriptor list								
8	_____							
8 + m	SAS phy log descriptor (first)(see table 226)						_____	
...	...							
y - m	SAS phy log descriptor (last)(see table 226)						_____	
y	_____							

The PARAMETER CODE field is defined in SPC-4 and contains the relative target port identifier (see SPC-4) of the SSP target port that the log parameter describes.

This page contains no comments

Table 225 defines the values of the fields in the parameter control byte for the log parameter.

Table 225 — Parameter control byte in the Protocol-Specific Port log parameter for SAS

Field	Value for LOG SENSE	Value for LOG SELECT	Description
DU	0	0 or 1	The DU bit is not defined for list parameters, so shall be set to zero when read with the LOG SENSE command and shall be ignored when written with the LOG SELECT command.
TSD	0	0 or 1	The device server shall support implicitly saving the log parameter at vendor specific intervals.
ETC	0	0 or 1	The ETC bit is not defined for list parameters, so shall be set to zero when read with the LOG SENSE command and shall be ignored when written with the LOG SELECT command.
TMC	00b	any	The TMC field is not defined for list parameters, so shall be set to 00b when read with the LOG SENSE command and shall be ignored when written with the LOG SELECT command.
FORMAT AND LINKING	11b	11b	The log parameter is a binary format list parameter.

The PARAMETER LENGTH field is defined in SPC-4 and shall be set to the value defined in table 224.

The PROTOCOL IDENTIFIER field is defined in SPC-4 and shall be set to the value defined in table 224.

The GENERATION CODE field is defined in the Phy Control and Discover mode page (see 10.2.7.5).

The NUMBER OF PHYS field contains the number of phys in the SAS target port (not in the entire SAS target device) and indicates the number of SAS phy log descriptors ~~that follow.~~

The SAS phy log descriptor list contains SAS phy log descriptors.

Table 226 defines the SAS phy log descriptor.

Table 226 — SAS phy log descriptor (part 1 of 2)

Byte/Bit	7	6	5	4	3	2	1	0	
0	Reserved								
1	PHY IDENTIFIER								
2	Reserved								
3	SAS PHY LOG DESCRIPTOR LENGTH (m - 3)								
4	Reserved	ATTACHED DEVICE TYPE			ATTACHED REASON				
5	REASON				NEGOTIATED LOGICAL LINK RATE				
6	Reserved				ATTACHED SSP INITIATOR PORT	ATTACHED STP INITIATOR PORT	ATTACHED SMP INITIATOR PORT	Reserved	

Page: 534

● Author: stx-goulder

Subject: Highlight

Date: 5/26/2008 12:06:14 PM

T REJECT (seems clear enough as is. SBC-3 added "(i.e., ignored)" to similar tables, but that requires making the column wider and results in a longer table)

0 or 1

Replacing this with "any" would reinforce the idea that the value will be ignored.

● Author: stx-goulder

Subject: Highlight

Date: 5/26/2008 12:06:35 PM

T REJECT (see response two rows above)

0 or 1

Replacing this with "any" would reinforce the idea that the value will be ignored.

● Author: RElliott

Subject: Cross-Out

Date: 6/30/2008 6:16:52 PM

T ACCEPT - DONE

that follow.

(matching Isi-gpenokie comment elsewhere)

Table 226 — SAS phy log descriptor (part 2 of 2)

Byte/Bit	7	6	5	4	3	2	1	0
7	Reserved				ATTACHED SSP TARGET PORT	ATTACHED STP TARGET PORT	ATTACHED SMP TARGET PORT	Reserved
8	SAS ADDRESS							
15	SAS ADDRESS							
16	ATTACHED SAS ADDRESS							
23	ATTACHED SAS ADDRESS							
24	ATTACHED PHY IDENTIFIER							
25	Reserved							
31	Reserved							
32	(MSB)	INVALID DWORD COUNT						(LSB)
35	INVALID DWORD COUNT							
36	(MSB)	RUNNING DISPARITY ERROR COUNT						(LSB)
39	RUNNING DISPARITY ERROR COUNT							
40	(MSB)	LOSS OF DWORD SYNCHRONIZATION						(LSB)
43	LOSS OF DWORD SYNCHRONIZATION							
44	(MSB)	PHY RESET PROBLEM						(LSB)
47	PHY RESET PROBLEM							
48	Reserved							
50	Reserved							
51	NUMBER OF PHY EVENT DESCRIPTORS							
Phy event descriptor list								
52	Phy event descriptor (first)(see table 288 in 10.4.3.14.4)							
63	Phy event descriptor (first)(see table 288 in 10.4.3.14.4)							
...	...							
m - 11	Phy event descriptor (last)(see table 288 in 10.4.3.14.4)							
m	Phy event descriptor (last)(see table 288 in 10.4.3.14.4)							

The SAS PHY LOG DESCRIPTOR LENGTH field indicates the number of bytes that follow in the SAS phy log descriptor. A SAS PHY LOG DESCRIPTOR LENGTH field set to zero indicates that there are 44 additional bytes.

NOTE 101 - Logical units compliant with SAS and SAS-1.1 only support a 48 byte SAS phy log descriptor.

● Author: RElliott
Subject: Note
Date: 6/30/2008 6:16:52 PM
 ACCEPT - DONE

Per 6/11 LB call, change byte 50 to a Phy Event Descriptor Length field. (this matches a change being made in SMP, which is also gaining a Length field outside the descriptor)

"The phy event descriptor length field indicates the number of bytes in the phy event descriptor (see 10.4.3.14.4)."

The units are in bytes rather than dwords to match the other length fields in log pages. (this differs from the length fields in SMP frames)

● Author: RElliott
Subject: Highlight
Date: 6/30/2008 6:16:52 PM
 ACCEPT - DONE

After:
"indicates the number of bytes that follow in the SAS phy log descriptor"

add:
"and shall be set to the value defined in table 226"

● Author: RElliott
Subject: Highlight
Date: 6/30/2008 6:16:52 PM
 ACCEPT - DONE

zero
s/b
00h

The INVALID DWORD COUNT field, RUNNING DISPARITY ERROR COUNT field, LOSS OF DWORD SYNCHRONIZATION field, and PHY RESET PROBLEM COUNT field are each defined in the SMP REPORT PHY ERROR LOG response (see 10.4.3.11).

For the INVALID DWORD COUNT field, RUNNING DISPARITY ERROR COUNT field, LOSS OF DWORD SYNCHRONIZATION COUNT field, and PHY RESET PROBLEM COUNT field, the phy may maintain any size counter but should maintain a 32-bit counter. If it reaches its maximum value, the counter shall stop and the device server shall set the field to FFFFFFFFh in the SAS phy log descriptor.

The NUMBER OF PHY EVENT DESCRIPTORS field indicates how many phy event descriptors follow.

Each phy event descriptor follows the format defined for the SMP REPORT PHY EVENT function in table 288 (see 10.4.3.14.4).

The fields in the SAS phy log descriptor not defined in this subclause are defined in the SMP DISCOVER response (see 10.4.3.10). These fields shall not be changeable with the LOG SELECT command.

10.2.9 SCSI diagnostic parameters

10.2.9.1 SCSI diagnostic parameters overview

Table 227 defines diagnostic pages supported by logical units in SCSI target devices in SAS domains (i.e., with SSP target ports) that support the SEND DIAGNOSTIC or RECEIVE DIAGNOSTIC RESULTS commands.

Table 227 — SSP target port diagnostic pages

Diagnostic page code	Description	Reference
3Fh	Protocol-Specific diagnostic page	10.2.9.2

An enclosure services process (see SES-2) describing elements in a SAS domain that are attached to a zoning expander device with zoning enabled (see 4.9) shall apply the zone permission table when providing access to those elements. Element types that may be subject to zoning include:

- a) Device element;
- b) Array Device element;
- c) Enclosure Services Controller Electronics element;
- d) SCC Controller Electronics element;
- e) SCSI Port/Transceiver element;
- f) SCSI Target Port element;
- g) SCSI Initiator Port element;
- h) SAS Expander element; and
- i) SAS Connector element.

Table 228 defines SCSI enclosure services diagnostic pages supported by logical units in SCSI target devices in SAS domains (e.g., with SSP target ports) that are affected by zoning.

Table 228 — Diagnostic pages affected by zoning

Diagnostic page code	Description	Reference
02h	Enclosure Control diagnostic page	SES-2 and 10.2.9.3
	Enclosure Status diagnostic page	SES-2 and 10.2.9.4
0Ah	Additional Element Status diagnostic page	SES-2 and 10.2.9.5

10.2.9.2 Protocol-Specific diagnostic page

The Protocol-Specific diagnostic page for SAS SSP provides a method for an application client to enable and disable phy test functions (see 4.10) for selected phys. The diagnostic page format is specified in SPC-4.

Page: 536

● Author: Isi-gpenokie
Subject: Cross-Out
Date: 5/6/2008 4:07:50 PM
T ACCEPT - DONE

This tern << each >> adds nothing and should be deleted.

● Author: RElliott
Subject: Highlight
Date: 6/30/2008 6:16:52 PM
T ACCEPT - DONE
the
s/b
then the

● Author: RElliott
Subject: Underline
Date: 6/30/2008 6:16:52 PM
T ACCEPT - DONE

how many phy event descriptors follow
s/b
the number of phy event descriptors in the phy event descriptor list.

● Author: RElliott
Subject: Highlight
Date: 6/30/2008 6:16:52 PM
T ACCEPT - DONE

Device element
s/b
Device Slot element

to match SES-2 revision 20

● Author: RElliott
Subject: Highlight
Date: 6/30/2008 6:16:52 PM
T ACCEPT - DONE

Array Device element
s/b
Array Device Slot element

to match SES-2 revision 20

The Protocol-Specific diagnostic page is transmitted using the SEND DIAGNOSTIC command. If the device server receives a RECEIVE DIAGNOSTIC RESULTS command with the PAGE CODE field set to 3Fh, it shall terminate the command with CHECK CONDITION status with the sense key set to ILLEGAL REQUEST and the additional sense code set to INVALID FIELD IN CDB Table 229 defines the Protocol-Specific diagnostic page for SAS SSP.

Table 229 — Protocol-Specific diagnostic page for SAS SSP

Byte/Bit	7	6	5	4	3	2	1	0
0	PAGE CODE (3Fh)							
1	Reserved				PROTOCOL IDENTIFIER (6h)			
2	(MSB) PAGE LENGTH (001Ch) (LSB)							
3								
4	PHY IDENTIFIER							
5	PHY TEST FUNCTION							
6	PHY TEST PATTERN							
7	Reserved	PHY TEST PATTERN SATA	PHY TEST PATTERN SSC	PHY TEST PATTERN PHYSICAL LINK RATE				
8	Reserved							
10								
11	PHY TEST PATTERN DWORDS CONTROL							
12								
19	PHY TEST PATTERN DWORDS							
20								
31	Reserved							

The PAGE CODE field is defined in SPC-4 and shall be set to the value defined in table 229.

The PROTOCOL IDENTIFIER field shall be set to the value defined in table 229 indicating this is a SAS SSP specific diagnostic page.

Editor's Note 6: That field should be defined in SPC-4 for all protocols. Once done, add "is defined in SPC-4 and"

The PAGE LENGTH field is defined in SPC-4 and shall be set to the value defined in table 229.

The PHY IDENTIFIER field specifies the phy identifier (see 4.2.8) of the phy that is to perform or to stop performing a phy test function (i.e., the selected phy). If the PHY IDENTIFIER field specifies a phy that does not exist, then the device server shall terminate the SEND DIAGNOSTIC command with CHECK CONDITION status with the sense key set to ILLEGAL REQUEST and the additional sense code set to INVALID FIELD IN PARAMETER LIST.

Author: RElliott
Subject: Highlight
Date: 6/30/2008 6:16:52 PM
ACCEPT - DONE

it
s/b
then it

Author: hpq-relliott
Subject: Highlight
Date: 5/6/2008 4:07:50 PM
ACCEPT - DONE

global
change
PHY TEST PATTERN PHYSICAL LINK RATE to PHY TEST FUNCTION PHYSICAL LINK RATE,
PHY TEST PATTERN SATA to PHY TEST FUNCTION SATA, and
PHY TEST PATTERN TX SSC to PHY TEST FUNCTION TX SSC

Other phy test functions in the future may also use these fields.

Author: stx-ghoulder
Subject: Highlight
Date: 5/29/2008 1:49:22 PM

ACCEPT - DONE (5/7 SAS LB meeting agrees we should do this. T10 proposal 08-254r0 SPC-4 Protocol Specific diagnostic page posted.)

Editor's Note 6: That field should be defined in SPC-4 for all protocols. Once done, add "is defined in SPC-4 and"

This note must be resolved and deleted.

The PHY TEST FUNCTION field specifies the phy test function to be performed and is defined in table 230. If the PHY TEST FUNCTION field specifies a phy test function that is not supported, then the device server shall terminate the SEND DIAGNOSTIC command with CHECK CONDITION status with the sense key set to ILLEGAL REQUEST and the additional sense code set to INVALID FIELD IN PARAMETER LIST.

Table 230 — PHY TEST FUNCTION field

Code	Name	Description
00h	STOP	<p>If the selected phy is performing a phy test function, then the selected phy shall stop performing the phy test function and originate a link reset sequence.</p> <p>If the selected phy is not performing a phy test function, then this function has no effect on the selected phy. ^a</p>
01h	TRANSMIT PATTERN	<p>If the selected phy is not performing a phy test function, the selected phy shall be set to transmit the phy test pattern specified by the PHY TEST PATTERN field at the physical link rate specified by the PHY TEST PATTERN PHYSICAL LINK RATE field and set to ignore its receiver. If the selected phy receives data while transmitting the pattern, then the selected phy shall ignore the received data.</p> <p>If the selected phy is performing a phy test function, the device server shall terminate the SEND DIAGNOSTIC command with CHECK CONDITION status with the sense key set to ILLEGAL REQUEST and the additional sense code set to PHY TEST FUNCTION IN PROGRESS. ^a</p>
02h - EFh	Reserved	
F0h - FFh	Vendor specific	
<p>^a If there is no SSP target port available to receive a SEND DIAGNOSTIC command to stop a phy from performing a phy test function, then a power on may be required to cause the phy to stop performing the function and originate a phy reset sequence.</p>		

If the PHY TEST FUNCTION field is set to 01h (i.e., TRANSMIT_PATTERN), then the PHY TEST PATTERN field specifies the phy test pattern to be transmitted as defined by table 231. If the PHY TEST PATTERN field specifies a phy test pattern that is not supported by the specified SAS phy, then the device server shall terminate the

● Author: RElliott
Subject: Highlight
Date: 6/30/2008 6:16:52 PM

T ACCEPT - DONE
the
s/b
then the

● Author: hpq-relliott
Subject: Highlight
Date: 5/26/2008 12:07:17 PM

T ACCEPT - DONE

be set to transmit the
s/b
perform the transmit pattern phy test function (see 4.10.2) using the

[after adding section 4.10.2 per other comment]

● Author: hpq-relliott
Subject: Cross-Out
Date: 5/26/2008 12:07:27 PM

~~**T**~~ ACCEPT - DONE

Delete:
and set to ignore its receiver. If the selected phy
receives data while transmitting the pattern, then the selected phy shall
ignore the received data.

after adding section 4.10.2, which will contain that rule (in more detail).

● Author: RElliott
Subject: Highlight
Date: 6/30/2008 6:16:52 PM

T ACCEPT - DONE
the
s/b
then the

SEND DIAGNOSTIC command with CHECK CONDITION status with the sense key set to ILLEGAL REQUEST and the additional sense code set to INVALID FIELD IN PARAMETER LIST.

Table 231 — PHY TEST PATTERN field

Code	Name	Description
00h	Reserved	
01h	JTPAT	The selected phy shall continuously transmit the JTPAT for RD+ and RD- (see A.1).
02h	CJTPAT	The selected phy shall continuously transmit the CJTPAT (see A.2).
03h - 0Fh	Reserved	
10h	TRAIN	The selected phy shall continuously transmit the TRAIN pattern (see 6.7.4.2.3.4).
11h	TRAIN_DONE	The selected phy shall continuously transmit the TRAIN_DONE pattern (see 6.7.4.2.3.4).
12h	IDLE	The selected phy shall continuously transmit idle dwords (see 7.4).
13h - 3Fh	Reserved	
40h	TWO_DWORDS	The selected phy shall continuously transmit the dwords specified by the PHY TEST PATTERN DWORDS CONTROL field and the PHY TEST PATTERN DWORDS field without scrambling. This pattern is only for use for characterization of the transmitter device and the passive interconnect. Phys are not required to support all patterns that may be specified.
41h - EFh	Reserved	
F0h - FFh	Vendor specific	

A PHY TEST PATTERN SATA bit set to one specifies that the phy shall transmit the phy test pattern as a SATA phy. A PHY TEST PATTERN SATA bit set to zero specifies that the phy shall transmit the phy test pattern as a SAS phy. If the PHY TEST PATTERN SATA bit is set to one and the phy does not support SATA, then the device server shall terminate the SEND DIAGNOSTIC command with CHECK CONDITION status with the sense key set to ILLEGAL REQUEST and the additional sense code set to INVALID FIELD IN PARAMETER LIST.

The PHY TEST PATTERN SSC field specifies the SSC modulation type (see 5.3.8.1) with which the phy test pattern shall be transmitted and is defined in table 232. If the SSC modulation type specified by the PHY TEST PATTERN SSC field is not supported (e.g., if the phy is a SAS phy, then it only supports no SSC and down-spreading SSC), then the device server shall terminate the SEND DIAGNOSTIC command with

Author: RElliott
Subject: Highlight
Date: 6/30/2008 6:16:52 PM

T ACCEPT - DONE
shall transmit the phy test pattern

Replace these 2 sentences with:

A phy test function sata bit set to one specifies that the phy shall transmit as a SATA phy during the phy test function. A phy test function sata bit set to zero specifies that the phy shall transmit as a SAS phy during the phy test function.

Author: RElliott
Subject: Highlight
Date: 6/30/2008 6:16:52 PM

T ACCEPT - DONE
with which the phy test
pattern shall be transmitted
s/b
that the phy shall use during transmission during the phy test function

Author: RElliott
Subject: Underline
Date: 6/30/2008 6:16:52 PM

T ACCEPT - DONE
no SSC
s/n
no-spreading

Author: lsi-gpenokie
Subject: Highlight
Date: 5/6/2008 4:07:50 PM

T REJECT (suggested change doesn't make sense - this is not a list of 3 things ANDed together)

This << a SAS phy, then it only supports no SSC and >> should be << a SAS phy, only supports no SSC, and>>

CHECK CONDITION status with the sense key set to ILLEGAL REQUEST and the additional sense code set to INVALID FIELD IN PARAMETER LIST.

Table 232 — PHY TEST PATTERN SSC field

Code	Description
00b	No SSC
01b	Center-spreading SSC ^a
10b	Down-spreading SSC
11b	Reserved
^a If the PHY TEST PATTERN SATA bit is set to one (i.e., a SATA phy is requested to transmit center-spreading), the device server shall terminate the SEND DIAGNOSTIC command with CHECK CONDITION status with the sense key set to ILLEGAL REQUEST and the additional sense code set to INVALID FIELD IN PARAMETER LIST.	

The PHY TEST PATTERN PHYSICAL LINK RATE field specifies the physical link rate at which the phy test pattern shall be transmitted and is defined in table 233. If the physical link rate specified by the PHY TEST PATTERN PHYSICAL LINK RATE field is less than the hardware minimum physical link rate or greater than the hardware maximum physical link rate, then the device server shall terminate the SEND DIAGNOSTIC command with CHECK CONDITION status with the sense key set to ILLEGAL REQUEST and the additional sense code set to INVALID FIELD IN PARAMETER LIST.

Table 233 — PHY TEST PATTERN PHYSICAL LINK RATE field

Code	Description
0h - 7h	Reserved
8h	1.5 Gbps
9h	3 Gbps
Ah	6 Gbps
Bh - Fh	Reserved for future physical link rates

The PHY TEST PATTERN DWORDS CONTROL field and PHY TEST PATTERN DWORDS field are only used if the PHY TEST PATTERN field is set to 40h (i.e., TWO_DWORDS) (see table 231).

● Author: RElliott
Subject: Highlight
Date: 6/30/2008 6:16:52 PM
T ACCEPT - DONE

No SSC
s/n
No-spreading

● Author: RElliott
Subject: Highlight
Date: 6/30/2008 6:16:52 PM
T ACCEPT - DONE

the
s/b
then the

The PHY TEST PATTERN DWORDS CONTROL field defined in table 234 controls whether the bytes in the PHY TEST PATTERN DWORDS field are sent as control characters or data characters.

Table 234 — PHY TEST PATTERN DWORDS CONTROL field

Code	Description
00h	Each byte in the PHY TEST PATTERN DWORDS field shall be sent as a data character (i.e., Dxx.y)(see 6.3.3) without scrambling.
08h	The fifth byte in the PHY TEST PATTERN DWORDS field shall be sent as a control character (i.e., Kxx.y)(see 6.3.3); each other byte shall be sent as a data character without scrambling.
80h	The first byte in the PHY TEST PATTERN DWORDS field shall be sent as a control character; each other byte shall be sent as a data character without scrambling.
88h	The first and fifth bytes in the PHY TEST PATTERN DWORDS field shall each be sent as a control character; each other byte shall be sent as a data character without scrambling.
All others	Reserved

The PHY TEST PATTERN DWORDS field contains the two dwords that are sent during a TWO_DWORDS test pattern. Whether each byte in the dwords is sent as a control character or a data character is specified by the PHY TEST PATTERN DWORDS CONTROL field. A byte specifying a control character shall only specify a control character which is used in this standard (see table 85 in 6.3) and is supported by the phy (i.e., all phys support K28.5 (i.e., BCh), but only phys supporting STP support K28.3 (i.e., 7Ch) or K28.6 (i.e., DCh)).

The device server shall terminate a SEND DIAGNOSTIC command specifying any unsupported combination with CHECK CONDITION status with the sense key set to ILLEGAL REQUEST and the additional sense code set to INVALID FIELD IN PARAMETER LIST.

● Author: RElliott
Subject: Underline
Date: 6/30/2008 6:16:52 PM
T ACCEPT - DONE

see 6.3.3)

point to new section for data characters

● Author: RElliott
Subject: Underline
Date: 6/30/2008 6:16:52 PM
T ACCEPT - DONE

see 6.3.3)

point to new section for data characters

● Author: Isi-gpenokie
Subject: Highlight
Date: 5/29/2008 1:50:48 PM
T ACCEPT - DONE (as two sentences, still using "each" so not create a plural/singular mismatch)

This << Kxx.y)(see 6.3.3); each other byte shall be sent >> should be << Kxx.y)(see 6.3.3) and all other bytes shall be sent >>

● Author: Isi-gpenokie
Subject: Highlight
Date: 5/29/2008 1:50:53 PM
T ACCEPT - DONE (as two sentences, still using "each" so not create a plural/singular mismatch)

This << character; each other byte shall be >> should be << character and all other bytes shall be >>

● Author: Isi-gpenokie
Subject: Highlight
Date: 5/29/2008 1:50:58 PM
T ACCEPT - DONE (as two sentences, still using "each" so not create a plural/singular mismatch)

This << character; each other byte shall be >> should be << character and all other bytes shall be >>

● Author: RElliott
Subject: Underline
Date: 6/30/2008 6:16:52 PM
T ACCEPT - DONE

6.3)

point to new section on control characters

Table 235 lists some examples of TWO_DWORDS phy test patterns.

Table 235 — TWO_DWORDS phy test pattern examples

PHY TEST PATTERN DWORDS CONTROL field	PHY TEST PATTERN DWORDS field	Description
00h	4A4A4A4A 4A4A4A4Ah	D10.2 characters (see table 83 in 6.3.3). This high-frequency pattern contains 01b repeating and has the highest possible frequency. This pattern may be used for measuring skew and rise/fall times (see table 58 in 5.3.6.2, table 59 in 5.3.6.3, and table 68 in 5.3.7.3).
00h	B5B5B5B5 B5B5B5B5h	D21.5 characters (see table 83 in 6.3.3). This high-frequency pattern contains 10b repeating and has the highest possible frequency. This pattern may be used for measuring skew and rise/fall times (see table 58 in 5.3.6.2, table 59 in 5.3.6.3, and table 68 in 5.3.7.3).
00h	78787878 78787878h	D24.3 characters (see table 83 in 6.3.3). This mid-frequency pattern contains 0011b or 1100b repeating (depending on starting disparity) and has half the highest possible frequency.
00h	D926D926 D926D926h	Pairs of D25.6 and D6.1 characters (see table 83 in 6.3.3). This mid-frequency pattern contains 1001b repeating and has half the highest possible frequency.
00h	7E7E7E7E 7E7E7E7Eh	D30.3 characters (see table 83 in 6.3.3). This low-frequency pattern contains four bits of one polarity, three bits of the other polarity, and three bits of the first polarity (e.g., 1111000111b), followed by the inverse (e.g., 0000111000b).
00h	EBF4EBF4 EBF4EBF4h	Pairs of these D11.7 and D20.7 characters (see table 83 in 6.3.3). This lone-bit pattern contains a single bit of one polarity after five bits of the other polarity (i.e., 0000010b and 1111101b).
88h	BC4A4A7B BC4A4A7Bh	ALIGN (0) primitives (see table 112 in 7.2.3). This pattern appears during OOB bursts (see 6.6), the SATA speed negotiation sequence (see 6.7.2.2), and the SAS speed negotiation sequence (see 6.7.4.2).
88h	BC070707 BC070707h	ALIGN (1) primitives (see table 112 in 7.2.3). This pattern appears during the SAS speed negotiation sequences (see 6.7.4.2).
80h	BC4A4A7B 4A787E7Eh	Pairs of an ALIGN (0) primitive (see table 112 in 7.2.3) and a dword containing D10.2, D24.3, D30.3, and D30.3 characters (see table 83 in 6.3.3).

Editor's Note 7: there are several more tables using D10.2 now... should they all be listed?

10.2.9.3 Enclosure Control diagnostic page

If the SELECT bit is set to one for any element that represents a device attached to an expander phy for which the SAS initiator port performing the SEND DIAGNOSTIC command does not have access according to the zone permission table, the enclosure services process shall terminate the SEND DIAGNOSTIC command with CHECK CONDITION status with the sense key set to ILLEGAL REQUEST and the additional sense code set to INVALID FIELD IN PARAMETER LIST.

Page: 542

● Author: RElliott
Subject: Note
Date: 6/30/2008 6:16:52 PM
 ACCEPT - DONE

throughout this table, update 6.3.3 to the new section for data characters

● Author: stx-ghoulder
Subject: Highlight
Date: 9/2/2008 8:09:01 PM
 ACCEPT - DONE (5/7 replace the specific references to a more global reference to 5.3 - or 5.2 and 5.3)

Editor's Note 7: there are several more tables using D10.2 now... should they all be listed?
Remove editors note.

● Author: RElliott
Subject: Highlight
Date: 6/30/2008 6:16:52 PM
 ACCEPT - DONE

the
s/b
then the

10.2.9.4 Enclosure Status diagnostic page

The enclosure services process shall set the ELEMENT STATUS CODE field to 8h (i.e., No Access Allowed) for each element that represents a device attached to an expander phy for which the SAS initiator port performing the RECEIVE DIAGNOSTIC RESULTS command does not have access according to the zone permission table.

10.2.9.5 Additional Element Status diagnostic page

The enclosure services process shall set the INVALID bit to one in the Additional Element Status descriptor (see SES-2) for each element that represents a device attached to an expander phy for which the SAS initiator port performing the RECEIVE DIAGNOSTIC RESULTS command does not have access according to the zone permission table.

10.2.10 SCSI power conditions

10.2.10.1 SCSI power conditions overview

The logical unit power condition states from the Power Condition mode page (see SPC-4) and START STOP UNIT command (see SBC-3), if implemented, shall interact with the NOTIFY (ENABLE SPINUP) primitive (see 7.2.5.3) to control temporary consumption of additional power (e.g., spin-up of rotating media) as described in this subclause.

The logical unit uses NOTIFY (ENABLE SPINUP) to:

- a) initiate spin-up after power on; and
- b) delay spin-ups requested by START STOP UNIT commands.

10.2.10.2 SA_PC (SCSI application layer power condition) state machine

10.2.10.2.1 SA_PC state machine overview

The SA_PC (SCSI application layer power condition) state machine describes how the SAS target device processes logical unit power condition state change requests and NOTIFY (ENABLE SPINUP) if it is a SCSI target device.

NOTE 102 - This state machine is an enhanced version of the logical unit power condition state machines described in SPC-4 and SBC-3.

This state machine consists of the following states:

- a) SA_PC_0:Powered_On (see 10.2.10.2.2)(initial state);
- b) SA_PC_1:Active (see 10.2.10.2.3);
- c) SA_PC_2:Idle (see 10.2.10.2.4);
- d) SA_PC_3:Standby (see 10.2.10.2.5);
- e) SA_PC_4:Stopped (see 10.2.10.2.6)(specific to SBC-3 logical units);
- f) SA_PC_5:Active_Wait (see 10.2.10.2.7)(specific to SAS devices); and
- g) SA_PC_6:Idle_Wait (see 10.2.10.2.8)(specific to SAS devices).

This state machine shall start in the SA_PC_0:Powered_On state after power on.

If the device server processes a START STOP UNIT command (see SBC-3) with the IMMED bit set to one, it may complete the command before completing the transition, if any, specified by the POWER CONDITION field and the START bit.

Page: 543

Author: stx-goulder

Subject: Highlight

Date: 5/26/2008 12:09:31 PM

 REJECT (SAS builds on SBC, adding Active_Wait and Idle_Wait. SBC builds on SPC, adding Stopped. SPC defines Powered_On, Active, Idle, and Standby. Fibre Channel, USB, SRP, and iSCSI-based SBC readers wouldn't appreciate SAS material included in that standard.)

10.2.10 SCSI power conditions

This entire clause seems to be written so that it is intended to be located in SBC (there are references to "SAS specific" and "SBC specific" states). If it were located in SBC and merged with requirements there, we would only have to manage two versions of power management instead of three versions like today.

Author: RElliott

Subject: Highlight

Date: 6/30/2008 6:16:52 PM

 ACCEPT - DONE

spin-up of rotating media

s/b

to spin up rotating media

Author: RElliott

Subject: Highlight

Date: 6/30/2008 6:16:52 PM

 ACCEPT - DONE

initiate spin-up

s/b

allow initial temporary consumption of additional power

Author: stx-goulder

Subject: Highlight

Date: 5/30/2008 3:42:57 PM

 ACCEPT - DONE (as "delay temporary consumption of additional power after the Power Condition mode standby condition timer expires.")

b) delay spin-ups requested by START STOP UNIT commands.

Add bullet "c) delay spinups requested for recovery from Standby power state."

Author: RElliott

Subject: Note

Date: 6/30/2008 6:16:52 PM

 ACCEPT - DONE

spin-ups

s/b

temporary consumption of additional power

Author: RElliott

Subject: Note

Date: 6/30/2008 6:16:52 PM

 ACCEPT - DONE

Global in 10.2.10.2: change "SAS device" to "SAS target device"

Author: wdc-mevans

Subject: Highlight

Date: 5/23/2008 1:22:49 PM

Comments from page 543 continued on next page

10.2.9.4 Enclosure Status diagnostic page

The enclosure services process shall set the ELEMENT STATUS CODE field to 8h (i.e., No Access Allowed) for each element that represents a device attached to an expander phy for which the SAS initiator port performing the RECEIVE DIAGNOSTIC RESULTS command does not have access according to the zone permission table.

10.2.9.5 Additional Element Status diagnostic page

The enclosure services process shall set the INVALID bit to one in the Additional Element Status descriptor (see SES-2) for each element that represents a device attached to an expander phy for which the SAS initiator port performing the RECEIVE DIAGNOSTIC RESULTS command does not have access according to the zone permission table.

10.2.10 SCSI power conditions

10.2.10.1 SCSI power conditions overview

The logical unit power condition states from the Power Condition mode page (see SPC-4) and START STOP UNIT command (see SBC-3), if implemented, shall interact with the NOTIFY (ENABLE SPINUP) primitive (see 7.2.5.3) to control temporary consumption of additional power (e.g., spin-up of rotating media) as described in this subclause.

The logical unit uses NOTIFY (ENABLE SPINUP) to:

- a) initiate spin-up after power on; and
- b) delay spin-ups requested by START STOP UNIT commands.



10.2.10.2 SA_PC (SCSI application layer power condition) state machine

10.2.10.2.1 SA_PC state machine overview



The SA_PC (SCSI application layer power condition) state machine describes how the SAS target device processes logical unit power condition state change requests and NOTIFY (ENABLE SPINUP) if it is a SCSI target device.

NOTE 102 - This state machine is an enhanced version of the logical unit power condition state machines described in SPC-4 and SBC-3.

This state machine consists of the following states:

- a) SA_PC_0:Powered_On (see 10.2.10.2.2)(initial state);
- b) SA_PC_1:Active (see 10.2.10.2.3);
- c) SA_PC_2:Idle (see 10.2.10.2.4);
- d) SA_PC_3:Standby (see 10.2.10.2.5);
- e) SA_PC_4:Stopped (see 10.2.10.2.6)(specific to SBC-3 logical units);
- f) SA_PC_5:Active_Wait (see 10.2.10.2.7)(specific to SAS devices); and
- g) SA_PC_6:Idle_Wait (see 10.2.10.2.8)(specific to SAS devices).

This state machine shall start in the SA_PC_0:Powered_On state after power on.

If the device server processes a START STOP UNIT command (see SBC-3) with the IMMED bit set to one, it may complete the command before completing the transition, if any, specified by the POWER CONDITION field and the START bit.

TREJECT (first noun/subject convention, but added then)

it
s/b
then the device server

Figure 220 describes the SA_PC state machine.

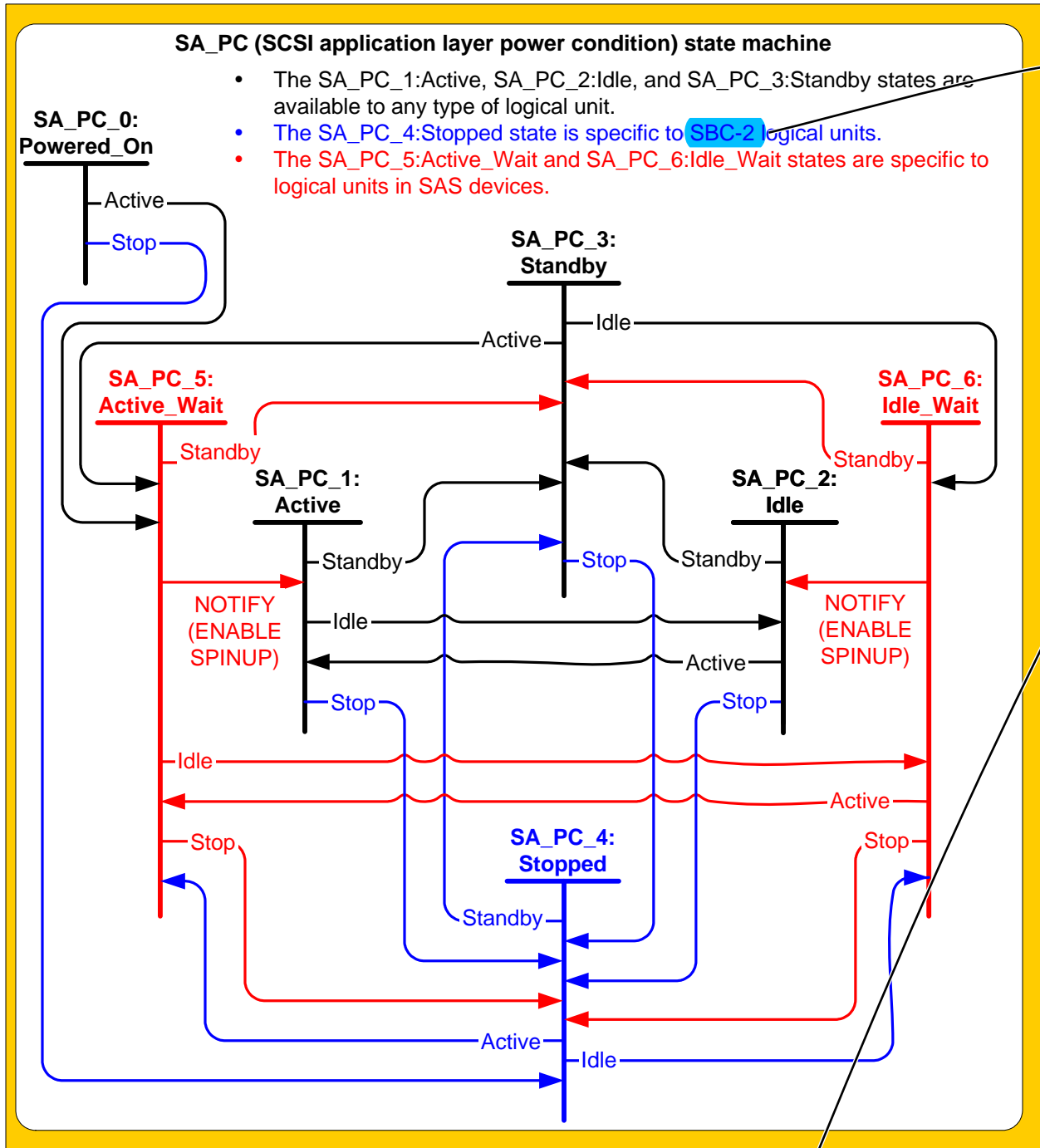

Figure 220 — SA_PC (SCSI application layer power condition) state machine for SAS

10.2.10.2.2 SA_PC_0:Powered_On state

10.2.10.2.2.1 State description

This state shall be entered upon power on. This state consumes zero time.

10.2.10.2.2.2 Transition SA_PC_0:Powered_On to SA_PC_4:Stopped

This transition shall occur if the SAS device has been configured to start in the SA_PC_4:Stopped state.

● Author: stx-goulder

Subject: Highlight

Date: 5/26/2008 12:09:58 PM

T ACCEPT - DONE (changed to "logical units that are direct-access block devices" which avoids the standards name altogether.)

SBC-2

s/b SBC-3

● Author: stx-goulder

Subject: Highlight

Date: 5/29/2008 1:56:51 PM

T ACCEPT - DONE (5/7 add a sentence stating "The SA_PC state machine shall be configured to transition to either the SA_PC_4: Stopped state or the SA_PC_5:Active_Wait state after power on by a mechanism outside the scope of this standard." to the SA_PC state machine overview.

Changed "start in" to "transition to ... after power on" in this sentence and in the Active_Wait sentence.)

configured to start

There is no mention in SAS-2 of a method to do this configuration. Shouldn't this be described?

10.2.10.2.2.3 Transition SA_PC_0:Powered_On to SA_PC_5:Active_Wait

This transition shall occur if the SAS device has been configured to start in the SA_PC_5:Active_Wait state.

10.2.10.2.3 SA_PC_1:Active state

10.2.10.2.3.1 State description

While in this state, rotating media in block devices shall be active (i.e., rotating or spinning).

See [SPC-4](#) for more details about this state.

10.2.10.2.3.2 Transition SA_PC_1:Active to SA_PC_2:Idle

This transition shall occur if:

- a) a START STOP UNIT command with the POWER CONDITION field set to IDLE is processed;
- b) a START STOP UNIT command with the POWER CONDITION field set to FORCE_IDLE_0 is processed;
- or
- c) the Power Condition mode page idle condition timer [expires](#).

10.2.10.2.3.3 Transition SA_PC_1:Active to SA_PC_3:Standby

This transition shall occur if:

- a) a START STOP UNIT command with the POWER CONDITION field set to STANDBY is processed;
- b) a START STOP UNIT command with the POWER CONDITION field set to FORCE_STANDBY_0 is processed; or
- c) the Power Condition mode page standby condition timer [expires](#).

10.2.10.2.3.4 Transition SA_PC_1:Active to SA_PC_4:Stopped

This transition shall occur if:

- a) a START STOP UNIT command with the START bit set to zero is processed.

10.2.10.2.4 SA_PC_2:Idle state

10.2.10.2.4.1 State description

While in this state, rotating media in block devices shall be active (i.e., rotating or spinning).

See [SPC-4](#) for more details about this state.

10.2.10.2.4.2 Transition SA_PC_2:Idle to SA_PC_1:Active

This transition shall occur if:

- a) a START STOP UNIT command with the START bit set to one is processed;
- b) a START STOP UNIT command with the POWER CONDITION field set to ACTIVE is processed; or
- c) a command that requires the active power condition is processed.

10.2.10.2.4.3 Transition SA_PC_2:Idle to SA_PC_3:Standby

This transition shall occur if:

- a) a START STOP UNIT command with the POWER CONDITION field set to STANDBY is processed;
- b) a START STOP UNIT command with the POWER CONDITION field set to FORCE_STANDBY_0 is processed; or
- c) the Power Condition mode page standby condition timer [expires](#).

● Author: stx-goulder

Subject: Highlight

Date: 5/26/2008 12:10:51 PM

T REJECT (that would only be a valid pointer for direct-access block devices. A tape drive wouldn't want to reference SBC-3.)

SPC-4

Use SBC-3 as reference instead, since it includes START-STOP UNIT command details that SPC doesn't.

● Author: stx-goulder

Subject: Highlight

Date: 5/26/2008 12:10:22 PM

T REJECT ("expire" is used about 122 times; this is no different)

expires

s/b "is enabled and is zero".

● Author: stx-goulder

Subject: Highlight

Date: 5/26/2008 12:10:31 PM

T REJECT ("expire" is used about 122 times; this is no different)

expires

s/b "is enabled and is zero".

● Author: stx-goulder

Subject: Highlight

Date: 5/26/2008 12:10:44 PM

T REJECT (that would only be a valid pointer for direct-access block devices. A tape drive wouldn't want to reference SBC-3.)

SPC-4

Use SBC-3 as reference instead, since it includes START-STOP UNIT command details that SPC doesn't.

● Author: stx-goulder

Subject: Highlight

Date: 5/26/2008 12:11:09 PM

T REJECT ("expire" is used about 122 times; this is no different)

expires

s/b "is enabled and is zero".

10.2.10.2.4.4 Transition SA_PC_2:Idle to SA_PC_4:Stopped

This transition shall occur if:

- a) a START STOP UNIT command with the START bit set to zero is processed.

10.2.10.2.5 SA_PC_3:Standby state**10.2.10.2.5.1 State description**

While in this state, rotating media in block devices shall be stopped.

See SPC-4 for more details about this state.

10.2.10.2.5.2 Transition SA_PC_3:Standby to SA_PC_4:Stopped

This transition shall occur if:

- a) a START STOP UNIT command with the START bit set to zero is processed.

10.2.10.2.5.3 Transition SA_PC_3:Standby to SA_PC_5:Active_Wait

This transition shall occur if:

- a) a START STOP UNIT command with the START bit set to one is processed;
- b) a START STOP UNIT command with the POWER CONDITION field set to ACTIVE is processed; or
- c) a command that requires the active power condition is processed.

If the transition is based on a START STOP UNIT command with the IMMED bit set to zero, the device server shall not complete the command until this state machine reaches the SA_PC_1:Active state.

10.2.10.2.5.4 Transition SA_PC_3:Standby to SA_PC_6:Idle_Wait

This transition shall occur if:

- a) a START STOP UNIT command with the POWER CONDITION field set to IDLE is processed;
- b) a START STOP UNIT command with the POWER CONDITION field set to FORCE_IDLE_0 is processed; or
- c) a command that requires the idle power condition is processed.

If the transition is based on a START STOP UNIT command with the IMMED bit set to zero, the device server shall not complete the command until this state machine reaches the SA_PC_2:Idle state.

10.2.10.2.6 SA_PC_4:Stopped state**10.2.10.2.6.1 State description**

This state is only implemented in block devices.

While in this state, rotating media shall be stopped.

See SBC-3 for more details about this state.

10.2.10.2.6.2 Transition SA_PC_4:Stopped to SA_PC_3:Standby

This transition shall occur if:

- a) a START STOP UNIT command with the POWER CONDITION field set to STANDBY is processed; or
- b) a START STOP UNIT command with the POWER CONDITION field set to FORCE_STANDBY_0 is processed.

10.2.10.2.6.3 Transition SA_PC_4:Stopped to SA_PC_5:Active_Wait

This transition shall occur if:

- a) a START STOP UNIT command with the START bit set to one is processed; or

● Author: stx-goulder

Subject: Highlight

Date: 5/26/2008 12:11:29 PM

T REJECT (that would only be a valid pointer for direct-access block devices. A tape drive wouldn't want to reference SBC-3.)

SPC-4

Use SBC-3 as reference instead, since it includes START-STOP UNIT command details that SPC doesn't.

● Author: RElliott

Subject: Highlight

Date: 6/30/2008 6:16:52 PM

T ACCEPT - DONE

the

s/b

then the

● Author: RElliott

Subject: Highlight

Date: 6/30/2008 6:16:52 PM

T ACCEPT - DONE

the

s/b

then the

● Author: RElliott

Subject: Highlight

Date: 6/30/2008 6:16:52 PM

T ACCEPT - DONE

block devices.

s/b

logical units that are direct-access block devices.

to match response to stx-goulder comment on the figure above

- b) a START STOP UNIT command with the POWER CONDITION field set to ACTIVE is processed.

If the transition is based on a START STOP UNIT command with the IMMED bit set to zero, the device server shall not complete the command until this state machine reaches the SA_PC_1:Active state.

10.2.10.2.6.4 Transition SA_PC_4:Stopped to SA_PC_6:Idle_Wait

This transition shall occur if:

- a) a START STOP UNIT command with the POWER CONDITION field set to IDLE is processed; or
- b) a START STOP UNIT command with the POWER CONDITION field set to FORCE_IDLE_0 is processed.

If the transition is based on a START STOP UNIT command with the IMMED bit set to zero, the device server shall not complete the command until this state machine reaches the SA_PC_2:Idle state.

10.2.10.2.7 SA_PC_5:Active_Wait state

10.2.10.2.7.1 State description

This state shall only be implemented in SAS devices.

While in this state, rotating media in block devices shall be stopped. The device server shall be capable of processing commands and shall terminate each media access command or TEST UNIT READY command with CHECK CONDITION status with the sense key set to NOT READY and the additional sense code set to LOGICAL UNIT NOT READY, NOTIFY (ENABLE SPINUP) REQUIRED.

In response to a REQUEST SENSE command processed in this state, the device server shall return parameter data containing sense data with the sense key set to NOT READY and the additional sense code set to LOGICAL UNIT NOT READY, NOTIFY (ENABLE SPINUP) REQUIRED and return GOOD status for the command.

10.2.10.2.7.2 Transition SA_PC_5:Active_Wait to SA_PC_1:Active

This transition shall occur if:

- a) a NOTIFY (ENABLE SPINUP) is detected; or
- b) the SAS device does not consume additional power as a result of the transition to SA_PC_1:Active.

10.2.10.2.7.3 Transition SA_PC_5:Active_Wait to SA_PC_3:Standby

This transition shall occur if:

- a) a START STOP UNIT command with the POWER CONDITION field set to STANDBY is processed;
- b) a START STOP UNIT command with the POWER CONDITION field set to FORCE_STANDBY_0 is processed; or
- c) the Power Condition mode page standby condition timer expires.

10.2.10.2.7.4 Transition SA_PC_5:Active_Wait to SA_PC_4:Stopped

This transition shall occur if:

- a) a START STOP UNIT command with the START bit set to zero is processed.

10.2.10.2.7.5 Transition SA_PC_5:Active_Wait to SA_PC_6:Idle_Wait

This transition shall occur if:

- a) a START STOP UNIT command with the POWER CONDITION field set to IDLE is processed;
- b) a START STOP UNIT command with the POWER CONDITION field set to FORCE_IDLE_0 is processed; or
- c) the Power Condition mode page idle condition timer expires.

If the transition is based on a START STOP UNIT command with the IMMED bit set to zero, the device server shall not complete the command until this state machine reaches the SA_PC_2:Idle state.

● Author: RElliott
Subject: Highlight
Date: 6/30/2008 6:16:52 PM

T ACCEPT - DONE
the
s/b
then the

● Author: RElliott
Subject: Highlight
Date: 6/30/2008 6:16:52 PM

T ACCEPT - DONE
the
s/b
then the

● Author: stx-goulder
Subject: Highlight
Date: 5/8/2008 7:41:17 PM

T REJECT ("expire" is used about 122 times; this is no different. The standby timer could indeed kick in while the logical unit is sitting in Active_Wait - e.g. after power on, NOTIFY (ENABLE SPINUP) might not showing up in a long time. If a media access command had caused the transition to Active_Wait, but the command is aborted before the NOTIFY (ENABLE SPINUP), then the timer can start again too.)

expires

s/b "is enabled and is zero". Actually, I don't think it is possible to be in Active_Wait state unless the standby timer is either disabled (due to START STOP command entrance) or already zero.

● Author: stx-goulder
Subject: Highlight
Date: 5/8/2008 7:39:20 PM

T REJECT (see previous response on this page)

expires

s/b "is enabled and is zero". Actually, I don't think it is possible to be in Active_Wait state unless the standby timer is either disabled (due to START STOP command entrance) or already zero.

● Author: RElliott
Subject: Highlight
Date: 6/30/2008 6:16:52 PM

T ACCEPT - DONE
the
s/b
then the

10.2.10.2.8 SA_PC_6:Idle_Wait state

10.2.10.2.8.1 State description

This state shall only be implemented in SAS devices.

While in this state, rotating media in block devices shall be stopped. The device server shall be capable of processing commands and shall terminate each media access command or TEST UNIT READY command with CHECK CONDITION status with the sense key set to NOT READY and the additional sense code set to LOGICAL UNIT NOT READY, NOTIFY (ENABLE SPINUP) REQUIRED.

In response to a REQUEST SENSE command processed in this state, the device server shall return parameter data containing sense data with the sense key set to NOT READY and the additional sense code set to LOGICAL UNIT NOT READY, NOTIFY (ENABLE SPINUP) REQUIRED and return GOOD status for the command.

10.2.10.2.8.2 Transition SA_PC_6:Idle_Wait to SA_PC_2:Idle

This transition shall occur if:

- a) a NOTIFY (ENABLE SPINUP) is detected; or
- b) the SAS device does not consume additional power as a result of the transition to SA_PC_2:Idle.

10.2.10.2.8.3 Transition SA_PC_6:Idle_Wait to SA_PC_3:Standby

This transition shall occur if:

- a) a START STOP UNIT command with the POWER CONDITION field set to STANDBY is processed;
- b) a START STOP UNIT command with the POWER CONDITION field set to FORCE_STANDBY_0 is processed; or
- c) the Power Condition mode page standby condition timer expires.

10.2.10.2.8.4 Transition SA_PC_6:Idle_Wait to SA_PC_4:Stopped

This transition shall occur if:

- a) a START STOP UNIT command with the START bit set to zero is processed.

10.2.10.2.8.5 Transition SA_PC_6:Idle_Wait to SA_PC_5:Active_Wait

This transition shall occur if:

- a) a START STOP UNIT command with the POWER CONDITION field set to ACTIVE is processed; or
- b) a command that requires the active power condition is processed.

If the transition is based on a START STOP UNIT command with the IMMED bit set to zero, the device server shall not complete the command until this state machine reaches the SA_PC_1:Active state.

Author: stx-goulder

Subject: Highlight

Date: 5/8/2008 7:40:38 PM

T REJECT (see previous responses)

expires

s/b "is enabled and is zero". Actually, I don't think it is possible to be in Idle_Wait state unless the standby timer is either disabled (due to START STOP command entrance) or already zero.

Author: RElliott

Subject: Highlight

Date: 6/30/2008 6:16:52 PM

T ACCEPT - DONE

the

s/b

then the

10.2.11 SCSI vital product data (VPD)

10.2.11.1 SCSI vital product data (VPD) overview

Table 236 lists VPD pages for which this standard defines special requirements.

Table 236 — VPD pages with special requirements for SAS SSP

Page code	VPD Page Name	Reference	Support Requirements
83h	Device Identification VPD page	10.2.11.2 and SPC-4	Mandatory
90h	Protocol-Specific Logical Unit Information VPD page	10.2.11.3 and SPC-4	See ^a
^a Mandatory if the target port and logical unit support the TLR CONTROL field set to a non-zero value in the SSP frame header, otherwise optional.			

10.2.11.2 Device Identification VPD page

In the Device Identification VPD page (83h) returned by the INQUIRY command (see SPC-4), each logical unit in a SAS target device shall include the designation descriptors for the target port identifier (see 4.2.7) and the relative target port identifier (see SAM-4 and SPC-4) listed in table 237.

Table 237 — Device Identification VPD page designation descriptors for the S/S target port

Field in designation descriptor	Designation descriptor	
	Target port identifier	Relative target port identifier
DESIGNATOR TYPE	3h (i.e., NAA)	4h (i.e., relative target port identifier)
ASSOCIATION	01b (i.e., SCSI target port)	01b (i.e., SCSI target port)
CODE SET	1h (i.e., binary)	1h (i.e., binary)
DESIGNATOR LENGTH	8	4
PIV (protocol identifier valid)	1	1
PROTOCOL IDENTIFIER	6h (i.e., SAS)	6h (i.e., SAS)
DESIGNATOR	SAS address ^a in NAA IEEE Registered format (see 4.2.2)	Relative port identifier ^b as described in SAM-4 and SPC-4
^a The DESIGNATOR field contains the SAS address of the SSP target port through which the INQUIRY command was received. ^b The DESIGNATOR field contains the relative port identifier of the SSP target port through which the INQUIRY command was received.		

In the Device Identification VPD page (83h) returned by the INQUIRY command (see SPC-4), each logical unit in a SAS target device shall include a designation descriptor for the SAS target device name (see 4.2.4)

Author: RElliott
Subject: Cross-Out
Date: 6/30/2008 6:16:52 PM
 ACCEPT - DONE

Delete

in NAA IEEE Registered format (see 4.2.2)
to all NAA Locally Administered as well.

The rest of this column should be enough hint that the binary NAA format is required, and this is not a SCSI name string format.

using NAA format and may include a designation descriptor for the SAS target device name using the SCSI name string format as listed in table 238.

Table 238 — Device Identification VPD page designation descriptors for the SAS target device

Field in designation descriptor	Designation descriptor for SAS target device	
	NAA format (required)	SCSI name string format (optional)
DESIGNATOR TYPE	3h (i.e., NAA)	8h (i.e., SCSI name string)
ASSOCIATION	10b (i.e., SCSI target device)	10b (i.e., SCSI target device)
CODE SET	1h (i.e., binary)	3h (i.e., UTF-8)
DESIGNATOR LENGTH	8	24
PIV (protocol identifier valid)	1	0
PROTOCOL IDENTIFIER	6h (i.e., SAS)	0h ^a
DESIGNATOR	Device name of the SAS target device in NAA IEEE Registered format (see 4.2.2)	Device name of the SAS target device in SCSI name string format (e.g., "naa." followed by 16 hexadecimal digits followed by 4 ASCII null characters)

^a The PROTOCOL IDENTIFIER field is reserved when the PIV bit is set to zero.

Logical units may include designation descriptors in addition to those required by this standard (e.g., SCSI target devices with SCSI target ports using other SCSI transport protocols may return additional SCSI target device names for those other SCSI transport protocols).

10.2.11.3 Protocol-Specific Logical Unit Information VPD page

The Protocol-Specific Logical Unit Information VPD page (see SPC-4) contains parameters for the logical unit that are protocol-specific based on the I_T nexus being used to access the logical unit.

Author: RElliott
Subject: Highlight
Date: 6/30/2008 6:16:52 PM
ACCEPT - DONE

NAA IEEE Registered format (see 4.2.2)
s/b
SAS address format (see new section)

Table 239 defines the Protocol-Specific Logical Unit Information VPD page for logical units with SAS target ports.

Table 239 — Protocol-Specific Logical Unit Information VPD page for SAS SSP

Byte\Bit	7	6	5	4	3	2	1	0
0	PERIPHERAL QUALIFIER			PERIPHERAL DEVICE TYPE				
1	PAGE CODE (90h)							
2	(MSB)	PAGE LENGTH (n - 3)						(LSB)
3								
Logical unit information descriptor list								
4	Logical unit information descriptor (first)(see table 240)							
...	...							
n	Logical unit information descriptor (last)(see table 240)							

The PERIPHERAL QUALIFIER field and the PERIPHERAL DEVICE TYPE field are defined in SPC-4.

The PAGE CODE field is defined in SPC-4 and shall be set to the value defined in table 239.

The PAGE LENGTH field is defined in SPC-4 and shall be set to the value defined in table 239.

The logical unit information descriptor list contains logical unit information descriptors.

Author: stx-ghoulder

Subject: Highlight

Date: 5/29/2008 2:48:06 PM

TREJECT (There is actually an entry per target port, not per logical unit; this VPD page is being provided by a particular logical unit.

Reworded as "The logical unit information descriptor list is defined in SPC-4 and shall contain a logical unit information descriptor for each SAS target port known to the device server." to clarify that.)

information descriptors.

Add this additional sentence: "A logical unit information descriptor should be included for each logical unit accessible to this target port."

Table 240 defines the logical unit information descriptor for logical units with SAS target ports.

Table 240 — Logical unit information descriptor for SAS SSP

Byte/Bit	7	6	5	4	3	2	1	0
0	(MSB) RELATIVE PORT IDENTIFIER (LSB)							
1								
2	Reserved				PROTOCOL IDENTIFIER (6h)			
3	Reserved							
5								
6	(MSB) DESCRIPTOR LENGTH (0004h) (LSB)							
7								
Per logical unit SCSI transport specific data								
8	Reserved							TLR CONTROL SUPPORTED
9	Reserved							
11								

The RELATIVE PORT IDENTIFIER field is defined in SPC-4.

The PROTOCOL IDENTIFIER field is defined in SPC-4 and shall be set to the value defined in table 240 indicating that this is a SAS SSP specific descriptor.

The DESCRIPTOR LENGTH field is defined in SPC-4 and shall be set to the value defined in table 240.

A TLR CONTROL SUPPORTED bit set to one indicates that the combination of the SCSI target port and logical unit support the TLR CONTROL field in the SSP frame header (see 9.1). A TLR CONTROL SUPPORTED bit set to zero indicates that the combination of the SCSI target port and logical unit do not support the TLR CONTROL field in the SSP frame header.

10.3 ATA application layer

No SAS-specific ATA features are defined.

10.4 Management application layer

10.4.1 READY LED signal behavior

A SAS target device uses the READY LED signal to activate an externally visible LED that indicates the state of readiness and activity of the SAS target device. The READY LED signal electrical characteristics are described in 5.4. All SAS target devices using the SAS Drive plug connector (see 5.2.3.2.1.1) shall support the READY LED signal.

The system is not required to generate any visual output when the READY LED signal is asserted. Additional vendor-specific flashing patterns may be used to signal vendor-specific conditions.

SAS target devices without SSP target ports may transmit the READY LED signal using vendor-specific patterns.

Author: Isi-gpenokie
Subject: Highlight
Date: 5/6/2008 4:07:50 PM

T ACCEPT - DONE

This << features are defined. >> should be << features are defined by this standard. >>

SAS target devices with SSP target ports shall follow the READY LED MEANING bit in the Protocol-Specific Port mode page (see 10.2.7.4) as described in table 241.

Table 241 — READY LED signal behavior

Power condition ^a (see 10.2.10) or activity	READY LED MEANING bit set to zero ^b	READY LED MEANING bit set to one
Active or Idle power condition	<p>The SAS target device shall:</p> <p>a) when not processing a command, assert the READY LED signal continuously; or</p> <p>b) when processing a command, toggle the READY LED signal between the asserted and negated states in a vendor-specified manner.</p> <p>(i.e., The LED is usually on, but flashes on and off when commands are processed.)</p>	<p>The SAS target device shall:</p> <p>a) when not processing a command, negate the READY LED signal continuously; or</p> <p>b) when processing a command, toggle the READY LED signal between the asserted and negated states in a vendor-specified manner.</p> <p>(i.e., The LED is usually off, but flashes on and off when commands are processed.)</p>
Standby or Stopped power condition	<p>The SAS target device shall:</p> <p>a) when not processing a command, negate the READY LED signal continuously; or</p> <p>b) when processing a command, toggle the READY LED signal between the asserted and negated states in a vendor-specified manner.</p> <p>(i.e., The LED is usually off, but flashes on and off when commands are processed.)</p> <p>After a vendor-specific amount of time in this state, SAS target devices with rotating media may be removed with minimum risk of mechanical or electrical damage.</p>	<p>The SAS target device shall:</p> <p>a) when not processing a command, negate the READY LED signal continuously; or</p> <p>b) when processing a command, toggle the READY LED signal between the asserted and negated states in a vendor-specified manner.</p> <p>(i.e., The LED is usually off, but flashes on and off when commands are processed.)</p>
Spinup/spindown	<p>If the SAS target device has rotating media and is in the process of performing a spin-up or spin-down, then the SAS target device shall toggle the READY LED signal between the asserted and negated states with a 1 s ± 0.1 s cycle using a 50 % ± 10 % duty cycle (e.g., the LED is on for 0.5 s and off for 0.5 s).</p>	
Formatting media	<p>If the SAS target device is in the process of formatting media, then the SAS target device shall toggle the READY LED signal between the asserted and negated states in a vendor-specified manner (e.g., with each cylinder change on a disk drive).</p>	
<p>^a If the SAS target device has more than one logical unit and any logical unit is active or idle, its power condition should be used to control the READY LED signal.</p> <p>^b If the target device has rotating media, a READY LED MEANING bit set to zero results in a READY LED signal behavior that provides an indication of the target device's readiness for removal. A target device with rotating media that is not in a state for safe removal shall either toggle the READY LED signal at a significant rate during spin-up, during spin-down, and while formatting media, or assert the READY LED signal continuously. When removal is safe from a mechanical standpoint, the READY LED signal shall be deasserted.</p>		

● Author: RElliott
Subject: Highlight
Date: 6/30/2008 6:16:52 PM

T ACCEPT - DONE
The
s/b
the
and delete the period at the end

● Author: RElliott
Subject: Highlight
Date: 6/30/2008 6:16:52 PM

T ACCEPT - DONE
The
s/b
the
and delete the period at the end

● Author: RElliott
Subject: Highlight
Date: 6/30/2008 6:16:52 PM

T ACCEPT - DONE
The
s/b
the
and delete the period at the end

● Author: RElliott
Subject: Highlight
Date: 6/30/2008 6:16:52 PM

T ACCEPT - DONE
spin-up or spin-down
s/b
spinup or spindown

● Author: RElliott
Subject: Highlight
Date: 6/30/2008 6:16:52 PM

T ACCEPT - DONE
spin-down
s/b
spindown

● Author: RElliott
Subject: Highlight
Date: 6/30/2008 6:16:52 PM

T ACCEPT - DONE
spin-up
s/b
spinup

10.4.2 Management protocol services

The management application client and management device server use a four-step process to perform management functions:

- 1) The management application client invokes Send SMP Function;
- 2) The SMP target port invokes SMP Function Received;
- 3) The management device server invokes Send SMP Function Response; and
- 4) The SMP initiator port invokes Received SMP Function Complete.

10.4.3 SMP functions

10.4.3.1 SMP functions overview

Table 242 defines the SMP functions.

Table 242 — SMP functions (FUNCTION field) (part 1 of 2)

Function code	SMP function	Description	Reference
SMP input functions (00h - 7Fh)			
General SMP input functions (00h - 0Fh)			
00h	REPORT GENERAL	Return general information about the device	10.4.3.4
01h	REPORT MANUFACTURER INFORMATION	Return vendor and product identification	10.4.3.5
02h	READ GPIO REGISTER	See SFF-8485	
03h	REPORT SELF-CONFIGURATION STATUS	Return status of the discover process in a self-configuring expander device	10.4.3.6
04h	REPORT ZONE PERMISSION TABLE	Return zone permission table values	10.4.3.7
05h	REPORT ZONE MANAGER PASSWORD	Return the zone manager password	10.4.3.8
06h	REPORT BROADCAST	Return information about Broadcast counters	10.4.3.9
07h - 0Fh	Reserved for general SMP input functions		
Phy-based SMP input functions (10h - 1Fh)			
10h	DISCOVER	Return information about the specified phy	10.4.3.10
11h	REPORT PHY ERROR LOG	Return error logging information about the specified phy	10.4.3.11
12h	REPORT PHY SATA	Return information about a phy currently attached to a SATA phy	10.4.3.12
13h	REPORT ROUTE INFORMATION	Return phy-based expander route table information	10.4.3.13
14h	REPORT PHY EVENT	Return phy events for the specified phy	10.4.3.14
15h - 1Fh	Reserved for phy-based SMP input functions		
Descriptor list-based SMP input functions (20h - 2Fh)			
20h	DISCOVER LIST	Return information about the specified phys	10.4.3.15
21h	REPORT PHY EVENT LIST	Return phy events	10.4.3.16

Author: lsi-bbesmer

Subject: Note

Date: 6/26/2008 8:15:51 PM

 ACCEPT - DONE (Additional comments added by the specific changes.)

1. Add DESCRIPTOR LENGTH fields to the three response frames that have room? 6/11: yes
2. Add 4 bytes to the REPORT EXPANDER ROUTE TABLE LIST <no, REPORT BROADCAST> response and include a DESCRIPTOR LENGTH field? 6/11: yes
3. Reduce the NUMBER OF field in REPORT EXPANDER ROUTE TABLE LIST to one byte to match the others? The descriptor is 16 bytes long, so one frame can only hold 61 of them. A one byte field is plenty. 6/11: yes
4. Move the NUMBER OF field in REPORT EXPANDER ROUTE TABLE LIST to byte 31? 6/11: no
5. Move the NUMBER OF field in DISCOVER LIST to byte 47? 6/11: no

6a. Add a rule that the management application client should ignore fields in a response frame that are beyond the response frame length it understands?

or 6b. Add a rule that the management application client should consider it an error if it detects fields in a response frame that are beyond the request length it understands?

6/11: yes option a

7a. Add a rule that the management application client should ignore fields in a response descriptor that are beyond the descriptor length it understands?

or 7b. Add a rule that the management application client should consider it an error if it detects fields in a response descriptor that are beyond the descriptor length it understands?

6/11: yes option a

8. Add DESCRIPTOR LENGTH fields to CONFIGURE ZONE PERMISSION TABLE and CONFIGURE PHY EVENT? 6/11: yes

9. Add 4 bytes to CONFIGURE ZONE PHY INFORMATION request and include a DESCRIPTOR LENGTH field?

6/11: use 6 reserved bits as a 6-bit LENGTH field to avoid this. LSI and PMC both prefer.

10. Move the NUMBER OF field in CONFIGURE ZONE PERMISSION TABLE to byte 15? 6/11: no

11a. Add a rule that the management device server shall ignore fields in a request frame that are beyond the request frame length it understands?

or 11b. Add a rule that the management device server shall report an error if it detects fields in a request frame that are beyond the request frame length it understands?

6/11: yes option b

12a. Add a rule that the management device server shall ignore fields in a request descriptor that are beyond the descriptor length it understands?

or 12b. Add a rule that the management device server shall report an error if it detects fields in a request descriptor that are beyond the descriptor length it understands?

6/11: yes option b

)

We should consider adding the size of the all descriptors to the "header" of each SMP response that contains descriptors (similar to REPORT SELF-CONFIGURATION STATUS), if they do not already have such a field.

Author: RElliott

Subject: Note

Date: 6/30/2008 6:16:52 PM

 REJECT (when there are large fields like descriptors that contain other fields, subsections are used so the field name references are not confused between the outer and inner structures. When there is just one level of fields, they are all described in one section.)

1. In section 10.4.3, there is not a consistent format for the SMP function subsections. Some functions such as REPORT GENERAL, REPORT MANUFACTURER INFORMATION, and REPORT ZONE MANAGER PASSWORD use a single block style, where others such as REPORT SELF-CONFIGURATION STATUS,

10.4.2 Management protocol services

The management application client and management device server use a four-step process to perform management functions:

- 1) The management application client invokes Send SMP Function;
- 2) The SMP target port invokes SMP Function Received;
- 3) The management device server invokes Send SMP Function Response; and
- 4) The SMP initiator port invokes Received SMP Function Complete.

10.4.3 SMP functions

10.4.3.1 SMP functions overview

Table 242 defines the SMP functions.

Table 242 — SMP functions (FUNCTION field) (part 1 of 2)

Function code	SMP function	Description	Reference
SMP input functions (00h - 7Fh)			
General SMP input functions (00h - 0Fh)			
00h	REPORT GENERAL	Return general information about the device	10.4.3.4
01h	REPORT MANUFACTURER INFORMATION	Return vendor and product identification	10.4.3.5
02h	READ GPIO REGISTER	See SFF-8485	
03h	REPORT SELF-CONFIGURATION STATUS	Return status of the discover process in a self-configuring expander device	10.4.3.6
04h	REPORT ZONE PERMISSION TABLE	Return zone permission table values	10.4.3.7
05h	REPORT ZONE MANAGER PASSWORD	Return the zone manager password	10.4.3.8
06h	REPORT BROADCAST	Return information about Broadcast counters	10.4.3.9
07h - 0Fh	Reserved for general SMP input functions		
Phy-based SMP input functions (10h - 1Fh)			
10h	DISCOVER	Return information about the specified phy	10.4.3.10
11h	REPORT PHY ERROR LOG	Return error logging information about the specified phy	10.4.3.11
12h	REPORT PHY SATA	Return information about a phy currently attached to a SATA phy	10.4.3.12
13h	REPORT ROUTE INFORMATION	Return phy-based expander route table information	10.4.3.13
14h	REPORT PHY EVENT	Return phy events for the specified phy	10.4.3.14
15h - 1Fh	Reserved for phy-based SMP input functions		
Descriptor list-based SMP input functions (20h - 2Fh)			
20h	DISCOVER LIST	Return information about the specified phys	10.4.3.15
21h	REPORT PHY EVENT LIST	Return phy events	10.4.3.16

REPORT_ZONE_PERMISSION_TABLE and REPORT_BROADCAST break the section into an overview, request, response and additional table subsections.

(from Tim McLeod, Data Domain; T10 reflector 5/9/2008)

Author: RElliott

Subject: Note

Date: 8/28/2008 3:52:50 PM

 ACCEPT - DONE (7/14 obsolete codes 02h and 82h. Assign new codes for new modern versions added to SFF-8485 revision 0.8)

7/9 yes change them. SFF-8485 is open for changes now...)

SFF-8485's READ_GPIO_REGISTER (02h) and WRITE_GPIO_REGISTER (82h) functions do not have room for the ALLOCATED_REQUEST_LENGTH and ALLOCATE_RESPONSE_LENGTH fields.

Define new versions of them following the SAS-2 format, and obsolete these function codes.

Table 242 — SMP functions (FUNCTION field) (part 2 of 2)

Function code	SMP function	Description	Reference
22h	REPORT EXPANDER ROUTE TABLE LIST	Return contents of the expander-based expander route table	10.4.3.17
23h - 2Fh	Reserved for descriptor list-based SMP input functions		
Other			
30h - 3Fh	Reserved for SMP input functions		
40h - 7Fh	Vendor specific		
SMP output functions (80h - FFh)			
General SMP output functions (80h - 8Fh)			
80h	CONFIGURE GENERAL	Configure the device	10.4.3.18
81h	ENABLE DISABLE ZONING	Enable or disable zoning	10.4.3.19
82h	WRITE GPIO REGISTER	See SFF-8485	
83h - 84h	Reserved for general SMP output functions		
85h	ZONED BROADCAST	Transmit the specified Broadcast on the expander ports in the specified zone group(s)	10.4.3.20
86h	ZONE LOCK	Lock a zoning expander device	10.4.3.21
87h	ZONE ACTIVATE	Set the zoning expander active values equal to the zoning expander shadow values	10.4.3.22
88h	ZONE UNLOCK	Unlock a zoning expander device	10.4.3.23
89h	CONFIGURE ZONE MANAGER PASSWORD	Configure the zone manager password	10.4.3.24
8Ah	CONFIGURE ZONE PHY INFORMATION	Configure zone phy information	10.4.3.25
8Bh	CONFIGURE ZONE PERMISSION TABLE	Configure the zone permission table	10.4.3.26
8Ch - 8Fh	Reserved for general SMP output functions		
Phy-based SMP output functions (90h - 9Fh)			
90h	CONFIGURE ROUTE INFORMATION	Change phy-based expander route table information	10.4.3.27
91h	PHY CONTROL	Request actions by the specified phy	10.4.3.28
92h	PHY TEST FUNCTION	Request a test function by the specified phy	10.4.3.29
93h	CONFIGURE PHY EVENT	Configure phy events for the specified phy	10.4.3.30
94h - 9Fh	Reserved for phy-based SMP output functions		
Other			
A0h - BFh	Reserved for SMP output functions		
C0h - FFh	Vendor specific		

This page contains no comments

10.4.3.2 SMP function request frame format

10.4.3.2.1 SMP function request frame format overview

An SMP request frame is sent by a management application client via an SMP initiator port to request an SMP function be performed by a management device server. Table 243 defines the SMP request frame format.

Table 243 — SMP request frame format

Byte ^a \ Bit	7	6	5	4	3	2	1	0	
0	SMP FRAME TYPE (40h)								
1	FUNCTION								
2	ALLOCATED RESPONSE LENGTH								
3	REQUEST LENGTH ((00h or ((n - 7) / 4))								
4	Additional request bytes								
m									
	Fill bytes, if needed								
n - 3	(MSB)	CRC							
n								(LSB)	

^a Shaded byte numbers (e.g., bytes 0 through 3 and (n - 3) through n) show the bytes that are included in the request frame when the REQUEST LENGTH field is set to 00h. Functions defined in previous versions of this standard may be defined as containing more than eight bytes when the REQUEST LENGTH field is set to 00h.

10.4.3.2.2 SMP FRAME TYPE field

The SMP FRAME TYPE field is defined by the SMP transport layer (see 9.4.1) and parsed by the SMP transport layer state machines (see 9.4.5). The SMP FRAME TYPE field is set to the value defined in table 242 (see 10.4.3.2.1).

10.4.3.2.3 FUNCTION field

The FUNCTION field specifies which SMP function is being requested and is defined in table 242 (see 10.4.3.1). If the value in the FUNCTION field is not supported by the management device server, it shall return a function result of UNKNOWN SMP FUNCTION as described in table 245 (see 10.4.3.3.4).

10.4.3.2.4 ALLOCATED RESPONSE LENGTH field

The ALLOCATED RESPONSE LENGTH field specifies the maximum number of dwords that the management application client has allocated in the data-in buffer for the additional response bytes in the response frame (see 10.4.3.3).

For compatibility with previous versions of this standard, an ALLOCATED RESPONSE LENGTH field set to 00h specifies that a specific number of dwords are to be transferred as defined in the SMP function description. This condition shall not be considered as an error.

If the LONG RESPONSE bit is set to one in the REPORT GENERAL response (see 10.4.3.4), then the management application client may set the ALLOCATED RESPONSE LENGTH field to a non-zero value in all SMP request frames. If the LONG RESPONSE bit is set to zero in the REPORT GENERAL response, then the

Page: 556

Author: hpq-relliott

Subject: Note

Date: 5/27/2008 7:09:13 PM

ACCEPT - DONE (5/7 on requests, we do need to define that an error be detected if too many bytes are sent. The link layer already checks for and discards a frame that is too long (258 dwords), so just reduced that by 1 dword.)

The fields Allocated Response Length, Request Length, and Response Length all have maximum values of FFh=255, meaning $255*4=1020$ bytes, not 1024. So, the statements in the SMP transport layer that the maximum SMP request bytes size (excluding the CRC field) is 1024 bytes is untrue.

Since the size including CRC is indeed 1024, it's still a convenient number.

Change the SMP transport layer section to match this limit. Add a NOTE that in SAS-1.1, a vendor-specific frame might have been defined that had 1024 bytes of data.

Author: RElliott

Subject: Note

Date: 6/30/2008 6:16:52 PM

ACCEPT - DONE

get rid of fill bytes

Author: wdc-mevans

Subject: Highlight

Date: 5/26/2008 12:14:06 PM

T REJECT (but reworded sentence so first noun/subject convention holds, and added "then": "If the management device server does not support the value in the function field, then it shall return...")

it
s/b
then the management device server

Author: Isi-bbesmer

Subject: Note

Date: 5/27/2008 7:05:15 PM

ACCEPT - DONE

A non-zero value in ALLOCATED RESPONSE LENGTH limits additional response frame to be 1020 bytes. Including the SMP header, this leads to the entire SMP Frame Length maximum to be 1024 (not including CRC):

$(255 * 4) + 4$ bytes header = 1024.

Author: RElliott

Subject: Note

Date: 6/30/2008 6:16:52 PM

ACCEPT - DONE (added one sentence in the first paragraph:

"If the SMP function description does not specify a specific number of dwords, then the number of dwords to be transferred is zero."
)

(from Bill Martin, Emulex)

In 10.4.3.2.4 there are the following two statements:

For compatibility with previous versions of this standard, an ALLOCATED RESPONSE LENGTH field set to 00h specifies that a specific number of dwords are to be transferred as defined in the SMP function description. This condition shall not be considered as an error.

.....

If the ALLOCATED RESPONSE LENGTH field is set to a non-zero value, then the management device server shall truncate the additional response bytes to the number of dwords specified by the ALLOCATED RESPONSE LENGTH field.

This is correct for SMP functions that were previously defined; however new SAS-2 SMP functions do not define a fixed length

Comments from page 556 continued on next page

10.4.3.2 SMP function request frame format

10.4.3.2.1 SMP function request frame format overview

An SMP request frame is sent by a management application client via an SMP initiator port to request an SMP function be performed by a management device server. Table 243 defines the SMP request frame format.

Table 243 — SMP request frame format

Byte ^a \ Bit	7	6	5	4	3	2	1	0	
0	SMP FRAME TYPE (40h)								
1	FUNCTION								
2	ALLOCATED RESPONSE LENGTH								
3	REQUEST LENGTH ((00h or ((n - 7) / 4))								
4	Additional request bytes								
m									
	Fill bytes, if needed								
n - 3	(MSB)	CRC							
n								(LSB)	

^a Shaded byte numbers (e.g., bytes 0 through 3 and (n - 3) through n) show the bytes that are included in the request frame when the REQUEST LENGTH field is set to 00h. Functions defined in previous versions of this standard may be defined as containing more than eight bytes when the REQUEST LENGTH field is set to 00h.

10.4.3.2.2 SMP FRAME TYPE field

The SMP FRAME TYPE field is defined by the SMP transport layer (see 9.4.1) and parsed by the SMP transport layer state machines (see 9.4.5). The SMP FRAME TYPE field is set to the value defined in table 243 (see 10.4.3.2.1).

10.4.3.2.3 FUNCTION field

The FUNCTION field specifies which SMP function is being requested and is defined in table 242 (see 10.4.3.1). If the value in the FUNCTION field is not supported by the management device server, it shall return a function result of UNKNOWN SMP FUNCTION as described in table 245 (see 10.4.3.3.4).

10.4.3.2.4 ALLOCATED RESPONSE LENGTH field

The ALLOCATED RESPONSE LENGTH field specifies the maximum number of dwords that the management application client has allocated in the data-in buffer for the additional response bytes in the response frame (see 10.4.3.3).

For compatibility with previous versions of this standard, an ALLOCATED RESPONSE LENGTH field set to 00h specifies that a specific number of dwords are to be transferred as defined in the SMP function description. This condition shall not be considered as an error.

If the LONG RESPONSE bit is set to one in the REPORT GENERAL response (see 10.4.3.4), then the management application client may set the ALLOCATED RESPONSE LENGTH field to a non-zero value in all SMP request frames. If the LONG RESPONSE bit is set to zero in the REPORT GENERAL response, then the

response if the ALLOCATED RESPONSE LENGTH field is set to 00h (e.g., DISCOVER LIST). I would propose the following change to the wording:

For compatibility with previous versions of this standard, an ALLOCATED RESPONSE LENGTH field set to 00h specifies that a specific number of dwords are to be transferred as defined in the SMP function description. If the SMP function defines the number of dwords to be transferred when the ALLOCATED RESPONSE LENGTH field is set to 00h, the value 00h shall not be considered as an error.

.....

If an SMP function specifies a number of dwords to be transferred when the ALLOCATED RESPONSE LENGTH field is set to 00h and the ALLOCATED RESPONSE LENGTH field is set to a non-zero value, then the management device server shall truncate the additional response bytes to the number of dwords specified by the ALLOCATED RESPONSE LENGTH field.

management application client shall set the ALLOCATED RESPONSE LENGTH field to 00h in all SMP request frames.

If the ALLOCATED RESPONSE LENGTH field is set to a non-zero value, then the management device server shall truncate the additional response bytes to the number of dwords specified by the ALLOCATED RESPONSE LENGTH field.

If the ALLOCATED RESPONSE LENGTH field is set to 00h, then the management device server shall truncate the additional response bytes to the number of dwords specified by the SMP function.

The allocated response length is used to limit the maximum amount of variable length data returned to the management application client. Fields in the additional response bytes (e.g., fields containing counts of the number of dwords in some or all of the data) shall not be altered to reflect the truncation, if any, that results from an insufficient allocated response length value.

10.4.3.2.5 REQUEST LENGTH field

A REQUEST LENGTH field set to 00h specifies that either:

- a) no dwords follow the REQUEST LENGTH field before the CRC field; or
- b) a non-zero number of dwords follow the REQUEST LENGTH field before the CRC field. This is for compatibility with previous versions of this standard.

The function description defines the interpretation of a REQUEST LENGTH field set to 00h.

A REQUEST LENGTH field set to a non-zero value (i.e., the non-zero value defined in table 243 (see 10.4.3.2.1)) specifies the number of dwords that follow the REQUEST LENGTH field before the CRC field (i.e., the length of the entire request frame minus eight).

If the LONG RESPONSE bit is set to one in the REPORT GENERAL response (see 10.4.3.4), then the management application client may set the REQUEST LENGTH field to a non-zero value in the SMP request frame for any SMP function. If the LONG RESPONSE bit is set to zero in the REPORT GENERAL response, then the management application client shall set the REQUEST LENGTH field to 00h in the SMP request frame for every SMP function.

If the request frame size including the CRC field is less than 8 bytes, or the REQUEST LENGTH field does not match the request frame size, the management device server shall return a function result of INVALID REQUEST FRAME LENGTH.

The management device server shall consider any fields not included in the request frame to be set to zero.

10.4.3.2.6 Additional request bytes

The additional request bytes definition and length are based on the SMP function. The maximum size of the additional request bytes is 1 024 bytes, making the maximum size of the frame 1 032 bytes (i.e., 1 024 bytes of data + 4 bytes of header + 4 bytes of CRC).

~~10.4.3.2.7 Fill bytes~~

Fill bytes shall be included after the additional request bytes so the CRC field is aligned on a four byte boundary. The contents of the fill bytes are vendor specific.

10.4.3.2.8 CRC field

The CRC field is defined by the SMP transport layer (see 9.4.1) and parsed by the SMP link layer state machines (see 7.18.5).

Author: RElliott
Subject: Highlight
Date: 6/30/2008 6:16:52 PM
 ACCEPT - DONE

SMP function
s/b
SMP function description

Author: RElliott
Subject: Cross-Out
Date: 6/30/2008 6:16:52 PM
 ACCEPT - DONE

value

Author: Isi-bbesmer
Subject: Highlight
Date: 5/27/2008 8:32:46 PM
 REJECT (this is referring to the length itself, not the field specifying the length. Deleting "value", which is unnecessary)

allocated response length

small caps?

Author: Isi-gpenokie
Subject: Highlight
Date: 5/27/2008 5:38:14 PM
 REJECT (prefer to see the "non-zero number..." at the front of the list.)

This << a non-zero number of dwords follow the REQUEST LENGTH field before the CRC field. This is for compatibility with previous versions of this standard >> should be << for compatibility with previous versions of this standard, a non-zero number of dwords follow the REQUEST LENGTH field before the CRC field. >>

Author: Isi-bbesmer
Subject: Note
Date: 5/27/2008 5:35:44 PM
 ACCEPT - DONE (backed down to 1020)

A REQUEST LENGTH maximum value of 255, leads to maximum additional request bytes value of $(255 * 4) = 1020$.

Section 9.4.2 says:

The REQUEST BYTES field definition and length is based on the SMP function (see 10.4.3.2). The maximum size of the REQUEST BYTES field is 1 024 bytes, making the maximum size of the frame 1 032 bytes (i.e., 1 024 bytes of data + 4 bytes of header + 4 bytes of CRC).

1020 <> 1024

Potential solutions:

- 1) Reduce maximum additional_request_length to 1020 (currently 1024)
 - 2) additional_request_length = (REQUEST_LENGTH+1) * 4...this would be problem for a 4-byte request however.
-

Author: RElliott
Subject: Highlight
Date: 6/30/2008 6:16:52 PM
 ACCEPT - DONE

eight
s/b

management application client shall set the ALLOCATED RESPONSE LENGTH field to 00h in all SMP request frames.

If the ALLOCATED RESPONSE LENGTH field is set to a non-zero value, then the management device server shall truncate the additional response bytes to the number of dwords specified by the ALLOCATED RESPONSE LENGTH field.

If the ALLOCATED RESPONSE LENGTH field is set to 00h, then the management device server shall truncate the additional response bytes to the number of dwords specified by the **SMP function**.

The allocated response length is used to limit the maximum amount of variable length data returned to the management application client. Fields in the additional response bytes (e.g., fields containing counts of the number of dwords in some or all of the data) shall not be altered to reflect the truncation, if any, that results from an insufficient **allocated response length value**.

10.4.3.2.5 REQUEST LENGTH field

A REQUEST LENGTH field set to 00h specifies that either:

- a) no dwords follow the REQUEST LENGTH field before the CRC field; or
- b) **a non-zero number of dwords follow the REQUEST LENGTH field before the CRC field. This is for compatibility with previous versions of this standard.**

The function description defines the interpretation of a REQUEST LENGTH field set to 00h.

A REQUEST LENGTH field set to a non-zero value (i.e., the non-zero value defined in table 243 (see 10.4.3.2.1)) specifies the number of dwords that follow the REQUEST LENGTH field before the CRC field (i.e., the length of the entire request frame minus **eight**).

If the LONG RESPONSE bit is set to one in the REPORT GENERAL response (see 10.4.3.4), then the management application client may set the REQUEST LENGTH field to a non-zero value in the SMP request frame for any SMP function. If the LONG RESPONSE bit is set to zero in the REPORT GENERAL response, then the management application client shall set the REQUEST LENGTH field to 00h in the SMP request frame for every SMP function.

If the request frame size including the CRC field is less than 8 bytes, or the REQUEST LENGTH field does not match the request frame size, **the** management device server shall return a function result of INVALID REQUEST FRAME LENGTH.

The management device server shall consider any fields not included in the request frame to be set to zero.

10.4.3.2.6 Additional request bytes

The **additional request bytes definition and length are based on the SMP function. The maximum size of the additional request bytes is 1 024 bytes, making the maximum size of the frame 1 032 bytes (i.e., 1 024 bytes of data + 4 bytes of header + 4 bytes of CRC).**

10.4.3.2.7 Fill bytes

Fill bytes shall be included after the additional request bytes so the CRC field is aligned on a four byte boundary. The contents of the fill bytes are vendor specific.

10.4.3.2.8 CRC field

The CRC field is defined by the SMP transport layer (see 9.4.1) and parsed by the SMP link layer state machines (see 7.18.5).

two
since the units are dwords, not bytes

(as noted by Isi-bbesmer for the RESPONSE FRAME field)

● Author: RElliott
Subject: Highlight
Date: 6/30/2008 6:16:52 PM

 ACCEPT - DONE

the
s/b
then the

● Author: RElliott
Subject: Note
Date: 6/30/2008 6:16:52 PM

 ACCEPT - DONE (specific comments added in SMP request and SMP response sections. SPC-4 proposal 08-261r0 proposes general rule for all parameter lists/parameter data in SCSI, so SAS need not create similar rules for mode pages, log pages, diagnostic pages, etc.)

Should the device server ignore fields it doesn't understand (requests that are too long)? This rule only discusses request frames that are too short. Without an easy way to detect the version of the device server, the initiator would have to try multiple times to get a frame through.

● Author: Isi-bbesmer
Subject: Highlight
Date: 5/27/2008 5:33:18 PM

 ACCEPT - DONE (backed down to 1028)

Not possible to describe. See comment in 10.4.3.2.5

● Author: Isi-gpenokie
Subject: Highlight
Date: 5/27/2008 5:33:31 PM

 ACCEPT - DONE (backed down to 1020)

How can this be 1024? The math does not seem to work. The largest value for the length field is FFh (255). $255 \times 4 = 1020$. So how can you get to 1024?

● Author: RElliott
Subject: Note
Date: 6/30/2008 6:16:52 PM

 ACCEPT - DONE

Change to:

The additional request bytes definition and length are based on the SMP function.

The number of additional request bytes are an integer multiple of four, so the crc field is aligned on a four byte boundary.

The maximum number additional request bytes is 1 020, making the maximum size of the frame 1 028 bytes (i.e., 1 020 bytes of data + 4 bytes of header + 4 bytes of CRC).

NOTE: Management application clients compliant with previous versions of this standard may send a vendor-specific SMP request frame containing 1 024 additional request bytes. The SMP_TP state machine discards SMP request frames that exceed 1 023 request bytes (see 7.18.5.4.2.2). SMP request frames defined in those versions of this standard did not have more than 36 additional request bytes.

● Author: RElliott
Subject: Note
Date: 6/30/2008 6:16:52 PM

Comments from page 557 continued on next page

management application client shall set the ALLOCATED RESPONSE LENGTH field to 00h in all SMP request frames.

If the ALLOCATED RESPONSE LENGTH field is set to a non-zero value, then the management device server shall truncate the additional response bytes to the number of dwords specified by the ALLOCATED RESPONSE LENGTH field.

If the ALLOCATED RESPONSE LENGTH field is set to 00h, then the management device server shall truncate the additional response bytes to the number of dwords specified by the SMP function.

The allocated response length is used to limit the maximum amount of variable length data returned to the management application client. Fields in the additional response bytes (e.g., fields containing counts of the number of dwords in some or all of the data) shall not be altered to reflect the truncation, if any, that results from an insufficient allocated response length value.

10.4.3.2.5 REQUEST LENGTH field

A REQUEST LENGTH field set to 00h specifies that either:

- a) no dwords follow the REQUEST LENGTH field before the CRC field; or
- b) a non-zero number of dwords follow the REQUEST LENGTH field before the CRC field. This is for compatibility with previous versions of this standard.

The function description defines the interpretation of a REQUEST LENGTH field set to 00h.

A REQUEST LENGTH field set to a non-zero value (i.e., the non-zero value defined in table 243 (see 10.4.3.2.1)) specifies the number of dwords that follow the REQUEST LENGTH field before the CRC field (i.e., the length of the entire request frame minus eight).

If the LONG RESPONSE bit is set to one in the REPORT GENERAL response (see 10.4.3.4), then the management application client may set the REQUEST LENGTH field to a non-zero value in the SMP request frame for any SMP function. If the LONG RESPONSE bit is set to zero in the REPORT GENERAL response, then the management application client shall set the REQUEST LENGTH field to 00h in the SMP request frame for every SMP function.

If the request frame size including the CRC field is less than 8 bytes, or the REQUEST LENGTH field does not match the request frame size, the management device server shall return a function result of INVALID REQUEST FRAME LENGTH.

The management device server shall consider any fields not included in the request frame to be set to zero.

10.4.3.2.6 Additional request bytes

The additional request bytes definition and length are based on the SMP function. The maximum size of the additional request bytes is 1 024 bytes, making the maximum size of the frame 1 032 bytes (i.e., 1 024 bytes of data + 4 bytes of header + 4 bytes of CRC).

10.4.3.2.7 Fill bytes

Fill bytes shall be included after the additional request bytes so the CRC field is aligned on a four byte boundary. The contents of the fill bytes are vendor specific.

10.4.3.2.8 CRC field

The CRC field is defined by the SMP transport layer (see 9.4.1) and parsed by the SMP link layer state machines (see 7.18.5).

 ACCEPT - DONE (see other comments for details on specific additions)

Add text with these rules:

1. Device servers shall report an error if they receive extra bytes in request frames
2. Application clients should ignore any extra bytes in response frames

The application client can figure out the version of the device server, reformat its request frame, and try again. The device server, on the other hand, is not obligated to figure out the version of the application client - it cannot "try again".

● Author: RElliott
Subject: Cross-Out
Date: 6/30/2008 6:16:52 PM

 ACCEPT - DONE

10.4.3.2.7 Fill bytes

● Author: RElliott
Subject: Note
Date: 6/30/2008 6:16:52 PM

 ACCEPT - DONE

Per 6/11 LB call discussion, add this rule:

If the management device server receives more additional request bytes than it expects (e.g., the management device server complies with a version of this standard defining 24 additional request bytes, but receives a request frame containing 36 additional request bytes), then it shall return a function result of INVALID REQUEST FRAME LENGTH.

● Author: wdc-mevans
Subject: Highlight
Date: 5/27/2008 7:04:09 PM

 REJECT (deleting the concept of SMP fill bytes instead)

Fill bytes

s/b

If the number additional request bytes is not a multiple of four, then fill bytes

● Author: RElliott
Subject: Note
Date: 6/30/2008 6:16:52 PM

 ACCEPT - DONE

Per the 6/11 LB call, add:

For additional request bytes containing a descriptor length field and a descriptor list, if the management application client receives more bytes in each descriptor than it expects (e.g., the management application client complies with a version of this standard defining that a descriptor is 12 bytes, but receives a request frame containing a descriptor list with 16 byte descriptors), then it shall return a function result of INVALID REQUEST FRAME LENGTH.

10.4.3.3 SMP function response frame format

10.4.3.3.1 SMP function response frame format overview

An SMP response frame is sent by a management device server via an SMP target port in response to an SMP request frame. Table 244 defines the SMP response frame format.

Table 244 — SMP response frame format

Byte ^a \Bit	7	6	5	4	3	2	1	0	
0	SMP FRAME TYPE (41h)								
1	FUNCTION								
2	FUNCTION RESULT								
3	RESPONSE LENGTH (00h or ((n - 7) / 4))								
4	Additional response bytes								
m									
	Fill bytes, if needed								
n - 3	(MSB)	CRC							
n								(LSB)	

^a Shaded byte numbers (e.g., bytes 0 through 3 and (n - 3) through n) show the bytes that are included in the response frame when the ALLOCATED RESPONSE LENGTH field is set to 00h in the request frame. Functions defined in previous versions of this standard may be defined as returning more than eight bytes when the ALLOCATED RESPONSE LENGTH field is set to 00h.

10.4.3.3.2 SMP FRAME TYPE field

The SMP FRAME TYPE field is defined by the SMP transport layer (see 9.4.1) and parsed by the MT state machines (see 9.4.5). The SMP FRAME TYPE field is set to the value defined in table 244 (see 10.4.3.3.1).

10.4.3.3.3 FUNCTION field

The FUNCTION field indicates the SMP function to which this frame is a response, and is defined in table 242 (see 10.4.3.1).

10.4.3.3.4 FUNCTION RESULT field

The FUNCTION RESULT field is defined in table 245.

Table 245 — FUNCTION RESULT field (part 1 of 5)

Code	Name	SMP function(s)	Description
00h	SMP FUNCTION ACCEPTED	All	The management device server supports the SMP function.
01h	UNKNOWN SMP FUNCTION	Unknown	The management device server does not support the requested SMP function.
02h	SMP FUNCTION FAILED	All	The requested SMP function failed.

Author: stx-goulder

Subject: Highlight

Date: 5/29/2008 2:50:30 PM

T ACCEPT - DONE (added " and processed the SMP request". I am hesitant to say it completed successfully, since some of the functions like PHY CONTROL schedule operations that take time, like HARD RESET. The SMP function is responded to immediately - it doesn't wait for the actions to complete.)

The management device server supports the SMP function.

Does this also mean the function completed successfully? A sentence should be added to clarify this.

Table 245 — FUNCTION RESULT field (part 2 of 5)

Code	Name	SMP function(s)	Description
03h	INVALID REQUEST FRAME LENGTH	All	The SMP request frame length was invalid (see 10.4.3.2).
04h	INVALID EXPANDER CHANGE COUNT	CONFIGURE GENERAL, ENABLE DISABLE ZONING, ZONE LOCK, ZONE ACTIVATE, CONFIGURE ZONE MANAGER PASSWORD, CONFIGURE ZONE PHY INFORMATION, CONFIGURE ZONE PERMISSION TABLE, CONFIGURE ROUTE INFORMATION, PHY CONTROL, PHY TEST FUNCTION, CONFIGURE PHY EVENT	The management device server supports the SMP function, but the EXPECTED EXPANDER CHANGE COUNT field does not match the current expander change count.
05h	BUSY	ZONE UNLOCK, ENABLE DISABLE ZONING, CONFIGURE ZONE MANAGER PASSWORD, CONFIGURE ZONE PHY INFORMATION, CONFIGURE ZONE PERMISSION TABLE	For ZONE UNLOCK, the locked zoning expander device is processing the activate step. For the other functions, the management device server is currently saving zoning values.
06h	INCOMPLETE DESCRIPTOR LIST	ZONED BROADCAST, CONFIGURE ZONE PHY INFORMATION, CONFIGURE ZONE PERMISSION TABLE, CONFIGURE PHY EVENT INFORMATION	The request frame length results in the truncation of a multi-byte field or descriptor list (e.g., in the ZONED BROADCAST request, the request frame is not large enough to contain the number of broadcast source zone groups specified by the NUMBER OF BROADCAST SOURCE ZONE GROUPS field).

Author: Isi-gpenokie

Subject: Highlight

Date: 5/27/2008 8:41:29 PM

TREJECT (There are two independent clauses here; they need to be joined by a a coordinating conjunction (e.g., and. but, for, not, or, yet, while). "However" is a conjunctive adverb, not a coordinating conjunction)

This << function, but the >> should be << function, however the >>

Table 245 — FUNCTION RESULT field (part 3 of 5)

Code	Name	SMP function(s)	Description
10h	PHY DOES NOT EXIST	DISCOVER, REPORT PHY ERROR LOG, REPORT PHY SATA, REPORT ROUTE INFORMATION, REPORT PHY EVENT, DISCOVER LIST, CONFIGURE ZONE PHY INFORMATION, CONFIGURE ROUTE INFORMATION, PHY CONTROL, PHY TEST FUNCTION, CONFIGURE PHY EVENT	The phy specified by the PHY IDENTIFIER field or the STARTING PHY IDENTIFIER field in the SMP request frame does not exist (e.g., the value is not within the range of zero to the value of the NUMBER OF PHYS field reported in the SMP REPORT GENERAL response).
11h	INDEX DOES NOT EXIST	REPORT ROUTE INFORMATION, CONFIGURE ROUTE INFORMATION	The phy specified by the PHY IDENTIFIER field in the SMP request frame does not have the table routing attribute (see 4.6.7.1), or the expander route index specified by the EXPANDER ROUTE INDEX field does not exist (i.e., the value is not in the range of 0000h to the value of the EXPANDER ROUTE INDEXES field in the SMP REPORT GENERAL response). The ADDITIONAL RESPONSE BYTES field may be present but shall be ignored.
12h	PHY DOES NOT SUPPORT SATA	REPORT PHY SATA, PHY CONTROL	See 10.4.3.12 and 10.4.3.28
13h	UNKNOWN PHY OPERATION	PHY CONTROL	See 10.4.3.28
14h	UNKNOWN PHY TEST FUNCTION	PHY TEST FUNCTION	See 10.4.3.29
15h	PHY TEST FUNCTION IN PROGRESS	PHY TEST FUNCTION	See 10.4.3.29
16h	PHY VACANT	DISCOVER, REPORT PHY ERROR LOG, REPORT PHY SATA, REPORT ROUTE INFORMATION, REPORT PHY EVENT, CONFIGURE ZONE PHY INFORMATION, CONFIGURE ROUTE INFORMATION, PHY CONTROL, PHY TEST FUNCTION, CONFIGURE PHY EVENT	The management device server processing the SMP request frame does not have access to a specified phy (e.g., because of zoning or vendor-specific reasons), although the value is within the range of zero to the value of the NUMBER OF PHYS field reported in the SMP REPORT GENERAL response.

● Author: lsi-bbesmer

Subject: Highlight

Date: 5/27/2008 8:47:34 PM

T ACCEPT - DONE (as "the value is less than the value indicated in the NUMBER OF PHYS field in the REPORT GENERAL response")

NUMBER OF PHYS

s/b

(NUMBER OF PHYS - 1)

● Author: lsi-gpenokie

Subject: Highlight

Date: 5/26/2008 12:15:18 PM

T REJECT (nothing wrong with "because")

This<< (e.g., because of zoning or >> should be << (e.g., as a result of zoning or for>>

● Author: RElliott

Subject: Highlight

Date: 6/30/2008 6:16:52 PM

T ACCEPT - DONE

within the range of zero to the value of the NUMBER OF PHYS field reported in the SMP REPORT GENERAL response.

s/b

the value is less than the value indicated in the NUMBER OF PHYS field in the REPORT GENERAL response

Table 245 — FUNCTION RESULT field (part 4 of 5)

Code	Name	SMP function(s)	Description
17h	UNKNOWN PHY EVENT SOURCE	CONFIGURE PHY EVENT	See 10.4.3.30.3
18h	UNKNOWN DESCRIPTOR TYPE	DISCOVER LIST	The descriptor type specified by the DESCRIPTOR TYPE field is not supported.
19h	UNKNOWN PHY FILTER	DISCOVER LIST	The phy filter specified by the PHY FILTER field is not supported.
1Ah	AFFILIATION VIOLATION	PHY CONTROL	The specified phy operation is not allowed due to the current state of affiliations.
20h	SMP ZONE VIOLATION	CONFIGURE GENERAL, ZONED BROADCAST, PHY CONTROL, PHY TEST FUNCTION, CONFIGURE PHY EVENT	Zoning is enabled and the SMP initiator port does not have access to a necessary zone group according to the zone permission table (see 4.9.3.2).
21h	NO MANAGEMENT ACCESS RIGHTS	REPORT ZONE MANAGER PASSWORD, ZONE LOCK, CONFIGURE ZONE MANAGER PASSWORD	<p>For ZONE LOCK, any of the following are true:</p> <ul style="list-style-type: none"> a) zoning is enabled, the ZONE LOCK bit is set to zero, the PHYSICAL PRESENCE bit is set to zero, the ZONE MANAGER PASSWORD field is not set to the current zone manager password, and the zone manager does not have access to zone group 2; b) zoning is enabled, the ZONE LOCK bit is set to one, and the request did not originate from the active zone manager; or c) zoning is disabled, the PHYSICAL PRESENCE bit is set to zero, the ZONE MANAGER PASSWORD field is not set to the current zone manager password. <p>For REPORT ZONE MANAGER PASSWORD, see 10.4.3.8. For CONFIGURE ZONE MANAGER PASSWORD, see 10.4.3.24.</p>
22h	UNKNOWN ENABLE DISABLE ZONING VALUE	ENABLE DISABLE ZONING	See 10.4.3.19

Author: RElliott
Subject: Highlight
Date: 6/30/2008 6:16:52 PM
ACCEPT - DONE

T

the
s/b
and the

Table 245 — FUNCTION RESULT field (part 5 of 5)

Code	Name	SMP function(s)	Description
23h	ZONE LOCK VIOLATION	ENABLE DISABLE ZONING, ZONE LOCK, ZONE ACTIVATE, ZONE UNLOCK, CONFIGURE ZONE PHY INFORMATION, CONFIGURE ZONE PERMISSION TABLE	Zoning is enabled and: a) an unlocked zoning expander device receives an SMP zone configuration function request, a ZONE ACTIVATE request, or a ZONE UNLOCK request from an SMP initiator port that is not the active zone manager ; or b) a locked zoning expander device receives an SMP ZONE LOCK request, an SMP zone configuration function request, a ZONE ACTIVATE request, or a ZONE UNLOCK request from an SMP initiator port that is not the active zone manager.
24h	NOT ACTIVATED	ZONE UNLOCK	The ACTIVATE REQUIRED bit in the request is set to one but the locked zoning expander device has not processed the activate step.
25h	ZONE GROUP OUT OF RANGE	CONFIGURE ZONE PHY INFORMATION, CONFIGURE ZONE PERMISSION TABLE	The ZONE GROUP field or NUMBER OF ZONE GROUPS field contains a value that is not supported.
26h	NO PHYSICAL PRESENCE	CONFIGURE ZONE MANAGER PASSWORD	The new ZONE MANAGER PASSWORD field is set to DISABLED (see table 26 in 4.9.1) but physical presence is not asserted.
27h	SAVING NOT SUPPORTED	ENABLE DISABLE ZONING, CONFIGURE ZONE MANAGER PASSWORD, CONFIGURE ZONE PHY INFORMATION, CONFIGURE ZONE PERMISSION TABLE	The SAVE field is set to 01b or 11b and the management device server does not support saved values for the specified information.
28h	SOURCE ZONE GROUP DOES NOT EXIST	REPORT ZONE PERMISSION TABLE	See 10.4.3.7
All others	Reserved		

Table 246 defines the priority of the SMP function results defined in table 245.

Table 246 — Function result priority (part 1 of 5)

SMP function	SMP function result priority
REPORT GENERAL (see 10.4.3.4)	1) INVALID REQUEST FRAME LENGTH; 2) SMP FUNCTION FAILED; and 3) SMP FUNCTION ACCEPTED
REPORT MANUFACTURER INFORMATION (see 10.4.3.5)	1) INVALID REQUEST FRAME LENGTH; 2) SMP FUNCTION FAILED; and 3) SMP FUNCTION ACCEPTED

Author: RElliott
Subject: Cross-Out
Date: 8/28/2008 9:25:38 AM

TACCEPT - DONE

Delete:

from an SMP initiator port
that is not the active zone manager

(from Bill Martin, Emulex)

On page 562 (SAS2r14), Table 245 part 5 of 5, code 23h, under description item a should be independent of where the request comes from. I believe that the words "from an SMP initiator port that is not the active zone manager" should be removed from the end of item a.

Author: wdc-mevans
Subject: Highlight
Date: 5/27/2008 8:43:01 PM

TREJECT (but changed to an a)b) list)

one but

s/b

one, but

Author: RElliott
Subject: Highlight
Date: 6/30/2008 6:16:52 PM

TACCEPT - DONE

new ZONE MANAGER PASSWORD

s/b

all small caps (it's the field name)

Author: wdc-mevans
Subject: Highlight
Date: 5/22/2008 5:20:24 PM

TREJECT (but changed to an a)b) list)

4.9.1) but

s/b

4.9.1), but

Author: wdc-mevans
Subject: Highlight
Date: 5/22/2008 5:19:45 PM

TREJECT (but changed to an a)b) list)

11b and

s/b

11b, and

Table 246 — Function result priority (part 2 of 5)

SMP function	SMP function result priority
READ GPIO REGISTER (see SFF-8485)	1) INVALID REQUEST FRAME LENGTH; 2) SMP FUNCTION FAILED; and 3) SMP FUNCTION ACCEPTED
REPORT SELF-CONFIGURATION STATUS (see 10.4.3.6)	1) INVALID REQUEST FRAME LENGTH; 2) SMP FUNCTION FAILED; and 3) SMP FUNCTION ACCEPTED
REPORT ZONE PERMISSION TABLE (see 10.4.3.7)	1) INVALID REQUEST FRAME LENGTH; 2) SOURCE ZONE GROUP DOES NOT EXIST; 3) SMP FUNCTION FAILED; and 4) SMP FUNCTION ACCEPTED
REPORT ZONE MANAGER PASSWORD (see 10.4.3.8)	1) INVALID REQUEST FRAME LENGTH; 2) NO MANAGEMENT ACCESS RIGHTS; 3) SMP FUNCTION FAILED; and 4) SMP FUNCTION ACCEPTED
REPORT BROADCAST (see 10.4.3.9)	1) INVALID REQUEST FRAME LENGTH; 2) SMP FUNCTION FAILED; and 3) SMP FUNCTION ACCEPTED
DISCOVER (see 10.4.3.10)	1) INVALID REQUEST FRAME LENGTH; 2) PHY DOES NOT EXIST; 3) PHY VACANT; 4) SMP FUNCTION FAILED; and 5) SMP FUNCTION ACCEPTED
REPORT PHY ERROR LOG (see 10.4.3.11)	1) INVALID REQUEST FRAME LENGTH; 2) PHY DOES NOT EXIST; 3) PHY VACANT; 4) SMP FUNCTION FAILED; and 5) SMP FUNCTION ACCEPTED
REPORT PHY SATA (see 10.4.3.12)	1) INVALID REQUEST FRAME LENGTH; 2) PHY DOES NOT EXIST; 3) PHY VACANT; 4) PHY DOES NOT SUPPORT SATA; 5) SMP FUNCTION FAILED; and 6) SMP FUNCTION ACCEPTED
REPORT ROUTE INFORMATION (see 10.4.3.13)	1) INVALID REQUEST FRAME LENGTH; 2) PHY DOES NOT EXIST; 3) PHY VACANT; 4) INDEX DOES NOT EXIST; 5) SMP FUNCTION FAILED; and 6) SMP FUNCTION ACCEPTED
REPORT PHY EVENT (see 10.4.3.14)	1) INVALID REQUEST FRAME LENGTH; 2) PHY DOES NOT EXIST; 3) PHY VACANT; 4) SMP FUNCTION FAILED; and 5) SMP FUNCTION ACCEPTED

This page contains no comments

Table 246 — Function result priority (part 3 of 5)

SMP function	SMP function result priority
DISCOVER LIST (see 10.4.3.15)	1) INVALID REQUEST FRAME LENGTH; 2) PHY DOES NOT EXIST; 3) UNKNOWN DESCRIPTOR TYPE; 4) UNKNOWN PHY FILTER; 5) SMP FUNCTION FAILED; and 6) SMP FUNCTION ACCEPTED
REPORT PHY EVENT LIST (see 10.4.3.16)	1) INVALID REQUEST FRAME LENGTH; 2) SMP FUNCTION FAILED; and 3) SMP FUNCTION ACCEPTED
REPORT EXPANDER ROUTE TABLE LIST (see 10.4.3.17)	1) INVALID REQUEST FRAME LENGTH; 2) SMP FUNCTION FAILED; and 3) SMP FUNCTION ACCEPTED
CONFIGURE GENERAL (see 10.4.3.18)	1) INVALID REQUEST FRAME LENGTH; 2) SMP ZONE VIOLATION; 3) INVALID EXPANDER CHANGE COUNT; 4) SMP FUNCTION FAILED; and 5) SMP FUNCTION ACCEPTED
WRITE GPIO REGISTER (see SFF-8485)	1) INVALID REQUEST FRAME LENGTH; 2) SMP FUNCTION FAILED; and 3) SMP FUNCTION ACCEPTED
ENABLE DISABLE ZONING (see 10.4.3.19)	1) INVALID REQUEST FRAME LENGTH; 2) ZONE LOCK VIOLATION; 3) UNKNOWN ENABLE DISABLE ZONING VALUE; 4) INVALID EXPANDER CHANGE COUNT; 5) SAVING NOT SUPPORTED; 6) SMP FUNCTION FAILED; and 7) SMP FUNCTION ACCEPTED
ZONED BROADCAST (see 10.4.3.20)	1) INVALID REQUEST FRAME LENGTH; 2) INCOMPLETE DESCRIPTOR LIST; 3) SMP ZONE VIOLATION; 4) SMP FUNCTION FAILED; and 5) SMP FUNCTION ACCEPTED
ZONE LOCK (see 10.4.3.21)	1) INVALID REQUEST FRAME LENGTH; 2) ZONE LOCK VIOLATION; 3) NO MANAGEMENT ACCESS RIGHTS; 4) INVALID EXPANDER CHANGE COUNT; 5) SMP FUNCTION FAILED; and 6) SMP FUNCTION ACCEPTED
ZONE ACTIVATE (see 10.4.3.22)	1) INVALID REQUEST FRAME LENGTH; 2) ZONE LOCK VIOLATION; 3) INVALID EXPANDER CHANGE COUNT; 4) SMP FUNCTION FAILED; and 5) SMP FUNCTION ACCEPTED

This page contains no comments

Table 246 — Function result priority (part 4 of 5)

SMP function	SMP function result priority
ZONE UNLOCK (see 10.4.3.23)	1) INVALID REQUEST FRAME LENGTH; 2) ZONE LOCK VIOLATION; 3) NOT ACTIVATED; 4) BUSY; 5) SMP FUNCTION FAILED; and 6) SMP FUNCTION ACCEPTED
CONFIGURE ZONE MANAGER PASSWORD (see 10.4.3.24)	1) INVALID REQUEST FRAME LENGTH; 2) INVALID EXPANDER CHANGE COUNT; 3) NO MANAGEMENT ACCESS RIGHTS; 4) NO PHYSICAL PRESENCE; 5) SAVING NOT SUPPORTED; 6) SMP FUNCTION FAILED; and 7) SMP FUNCTION ACCEPTED
CONFIGURE ZONE PHY INFORMATION (see 10.4.3.25)	1) INVALID REQUEST FRAME LENGTH; 2) INCOMPLETE DESCRIPTOR LIST; 3) PHY DOES NOT EXIST; 4) PHY VACANT; 5) ZONE LOCK VIOLATION; 6) INVALID EXPANDER CHANGE COUNT; 7) SAVING NOT SUPPORTED; 8) ZONE GROUP OUT OF RANGE; 9) SMP FUNCTION FAILED; and 10) SMP FUNCTION ACCEPTED
CONFIGURE ZONE PERMISSION TABLE (see 10.4.3.26)	1) INVALID REQUEST FRAME LENGTH; 2) INCOMPLETE DESCRIPTOR LIST; 3) ZONE LOCK VIOLATION; 4) INVALID EXPANDER CHANGE COUNT; 5) SAVING NOT SUPPORTED; 6) ZONE GROUP OUT OF RANGE; 7) SMP FUNCTION FAILED; and 8) SMP FUNCTION ACCEPTED
CONFIGURE ROUTE INFORMATION (see 10.4.3.27)	1) INVALID REQUEST FRAME LENGTH; 2) PHY DOES NOT EXIST; 3) PHY VACANT; 4) INVALID EXPANDER CHANGE COUNT; 5) INDEX DOES NOT EXIST; 6) SMP FUNCTION FAILED; and 7) SMP FUNCTION ACCEPTED
PHY CONTROL (see 10.4.3.28)	1) INVALID REQUEST FRAME LENGTH; 2) PHY DOES NOT EXIST; 3) PHY VACANT; 4) SMP ZONE VIOLATION; 5) INVALID EXPANDER CHANGE COUNT; 6) UNKNOWN PHY OPERATION; 7) PHY DOES NOT SUPPORT SATA; 8) AFFILIATION VIOLATION; 9) SMP FUNCTION FAILED; and 10) SMP FUNCTION ACCEPTED

This page contains no comments

Table 246 — Function result priority (part 5 of 5)

SMP function	SMP function result priority
PHY TEST FUNCTION (see 10.4.3.29)	1) INVALID REQUEST FRAME LENGTH; 2) PHY DOES NOT EXIST; 3) PHY VACANT; 4) SMP ZONE VIOLATION; 5) INVALID EXPANDER CHANGE COUNT; 6) UNKNOWN PHY TEST FUNCTION; 7) PHY TEST FUNCTION IN PROGRESS; 8) SMP FUNCTION FAILED; and 9) SMP FUNCTION ACCEPTED
CONFIGURE PHY EVENT (see 10.4.3.30)	1) INVALID REQUEST FRAME LENGTH; 2) INCOMPLETE DESCRIPTOR LIST; 3) PHY DOES NOT EXIST; 4) PHY VACANT; 5) SMP ZONE VIOLATION; 6) INVALID EXPANDER CHANGE COUNT; 7) UNKNOWN PHY EVENT SOURCE; 8) SMP FUNCTION FAILED; and 9) SMP FUNCTION ACCEPTED

10.4.3.3.5 RESPONSE LENGTH field

A RESPONSE LENGTH field set to 00h indicates that either:

- a) no dwords follow the RESPONSE LENGTH field before the CRC field; or
- b) a non-zero number of dwords follow the RESPONSE LENGTH field before the CRC field. This is for compatibility with previous versions of this standard.

The function description defines the interpretation of a RESPONSE LENGTH field set to 00h.

A RESPONSE LENGTH field set to a non-zero value (i.e., the non-zero value defined in table 244 (see 10.4.3.3.1)) indicates the number of dwords that follow the RESPONSE LENGTH field before the CRC field (i.e., the length of the entire response frame minus eight).

10.4.3.3.6 Additional response bytes

If the FUNCTION RESULT field is set to 00h, then the additional response bytes definition depends on the SMP function requested. If the FUNCTION RESULT field is set to a value other than 00h, then the additional response bytes may be present but shall be ignored. The maximum size of the additional response bytes is 1 024 bytes, making the maximum size of the frame 1 032 bytes (i.e., 1 024 bytes of data + 4 bytes of header + 4 bytes of CRC).

10.4.3.3.7 Fill bytes

Fill bytes shall be included after the ADDITIONAL RESPONSE BYTES field so the CRC field is aligned on a four byte boundary. The contents of the fill bytes are vendor specific.

10.4.3.3.8 CRC field

The CRC field is defined by the SMP transport layer (see 9.4.1) and parsed by the SMP link layer state machines (see 7.18.5).

10.4.3.4 REPORT GENERAL function

The REPORT GENERAL function returns general information about the SAS device (e.g., a SAS device contained in an expander device). This SMP function shall be implemented by all management device servers.

Author: lsi-gpenokie
Subject: Highlight
Date: 5/27/2008 5:38:49 PM
 REJECT (prefer to have "non-zero number" at the beginning)

This << a non-zero number of dwords follow the RESPONSE LENGTH field before the CRC field. This is for compatibility with previous versions of this standard >> should be << for compatibility with previous versions of this standard, a non-zero number of dwords follow the RESPONSE LENGTH field before the CRC field.>>

Author: lsi-bbesmer
Subject: Highlight
Date: 5/27/2008 8:43:57 PM
 ACCEPT - DONE

eight
s/b
two

units are in number of dwords, not number of bytes.

Author: RElliott
Subject: Note
Date: 6/30/2008 6:16:52 PM
 ACCEPT - DONE

Change to:

If the function result field is set to 00h, then the additional response bytes definition depends on the SMP function requested. If the function result field is set to a value other than 00h, then the additional response bytes may be present but shall be ignored.

The number of additional response bytes are an integer multiple of four, so the crc field is aligned on a four byte boundary.

The maximum number of additional response bytes is 1 020, making the maximum size of the frame 1 028 bytes (i.e., 1 020 bytes of data + 4 bytes of header + 4 bytes of CRC).

NOTE: Management device servers compliant with previous versions of this standard may send a vendor-specific SMP response frame containing 1 024 additional response bytes. The SMP_IP state machine discards SMP response frames that exceed 1 023 request bytes (see 7.18.5.3.4). SMP response frames defined in those versions of this standard did not have more than 56 additional response bytes.

Author: lsi-bbesmer
Subject: Highlight
Date: 5/27/2008 5:35:12 PM
 ACCEPT - DONE (backed down to 1028)

Not possible to describe. See comment in 10.4.3.2.4.

Author: RElliott
Subject: Note
Date: 6/30/2008 6:16:52 PM
 ACCEPT - DONE

Per 6/11 LB call discussion, add this rule:

The management application client should ignore any additional response bytes beyond those that it expects (e.g., if the management application client complies with a version of this standard defining 24 additional response bytes, but receives a response frame containing 36 additional response bytes, then it should ignore the last 12 additional response bytes).

A related rule will be added for device servers handling additional request bytes in 10.4.3.2.6.

Table 246 — Function result priority (part 5 of 5)

SMP function	SMP function result priority
PHY TEST FUNCTION (see 10.4.3.29)	1) INVALID REQUEST FRAME LENGTH; 2) PHY DOES NOT EXIST; 3) PHY VACANT; 4) SMP ZONE VIOLATION; 5) INVALID EXPANDER CHANGE COUNT; 6) UNKNOWN PHY TEST FUNCTION; 7) PHY TEST FUNCTION IN PROGRESS; 8) SMP FUNCTION FAILED; and 9) SMP FUNCTION ACCEPTED
CONFIGURE PHY EVENT (see 10.4.3.30)	1) INVALID REQUEST FRAME LENGTH; 2) INCOMPLETE DESCRIPTOR LIST; 3) PHY DOES NOT EXIST; 4) PHY VACANT; 5) SMP ZONE VIOLATION; 6) INVALID EXPANDER CHANGE COUNT; 7) UNKNOWN PHY EVENT SOURCE; 8) SMP FUNCTION FAILED; and 9) SMP FUNCTION ACCEPTED

10.4.3.3.5 RESPONSE LENGTH field

A RESPONSE LENGTH field set to 00h indicates that either:

- a) no dwords follow the RESPONSE LENGTH field before the CRC field; or
- b) a non-zero number of dwords follow the RESPONSE LENGTH field before the CRC field. This is for compatibility with previous versions of this standard.

The function description defines the interpretation of a RESPONSE LENGTH field set to 00h.

A RESPONSE LENGTH field set to a non-zero value (i.e., the non-zero value defined in table 244 (see 10.4.3.3.1)) indicates the number of dwords that follow the RESPONSE LENGTH field before the CRC field (i.e., the length of the entire response frame minus eight).

10.4.3.3.6 Additional response bytes

If the FUNCTION RESULT field is set to 00h, then the additional response bytes definition depends on the SMP function requested. If the FUNCTION RESULT field is set to a value other than 00h, then the additional response bytes may be present but shall be ignored. The maximum size of the additional response bytes is 1 024 bytes, making the maximum size of the frame 1 032 bytes (i.e., 1 024 bytes of data + 4 bytes of header + 4 bytes of CRC).

10.4.3.3.7 Fill bytes

Fill bytes shall be included after the ADDITIONAL RESPONSE BYTES field so the CRC field is aligned on a four byte boundary. The contents of the fill bytes are vendor specific.

10.4.3.3.8 CRC field

The CRC field is defined by the SMP transport layer (see 9.4.1) and parsed by the SMP link layer state machines (see 7.18.5).

10.4.3.4 REPORT GENERAL function

The REPORT GENERAL function returns general information about the SAS device (e.g., a SAS device contained in an expander device). This SMP function shall be implemented by all management device servers.

Author: RElliott
Subject: Note
Date: 6/30/2008 6:16:52 PM
 ACCEPT - DONE

Per 6/11 LB call, add:

For additional response bytes containing a descriptor length field and a descriptor list, the management application client should ignore any bytes in each descriptor beyond those that it expects (e.g., if the management application client complies with a version of this standard defining that a descriptor has 24 bytes, but receives a response frame containing a descriptor list with 36 byte descriptors, then it should ignore the last 12 bytes of each descriptor).

A related rule will be added for device servers in 10.4.3.2.6.

Author: RElliott
Subject: Cross-Out
Date: 6/30/2008 6:16:52 PM
 ACCEPT - DONE

10.4.3.3.7 Fill bytes

Author: wdc-mevans
Subject: Highlight
Date: 5/27/2008 5:34:13 PM
 REJECT (fill bytes concept deleted for SMP instead)

Fill bytes

s/b

If the number additional request bytes is not a multiple of four, then fill bytes

Table 247 defines the request format.

Table 247 — REPORT GENERAL request

Byte\Bit	7	6	5	4	3	2	1	0
0	SMP FRAME TYPE (40h)							
1	FUNCTION (00h)							
2	ALLOCATED RESPONSE LENGTH							
3	REQUEST LENGTH (00h)							
4	(MSB)	CRC						(LSB)
7								

The SMP FRAME TYPE field is defined in 10.4.3.2.2 and shall be set to the value defined in table 247.

The FUNCTION field is defined in 10.4.3.2.3 and shall be set to the value defined in table 247.

The ALLOCATED RESPONSE LENGTH field is defined in 10.4.3.2.4.

If the ALLOCATED RESPONSE LENGTH field is set to 00h, then the management device server shall:

- a) set the RESPONSE LENGTH field to 00h in the response frame; and
- b) return the first 28 bytes defined in table 248 plus the CRC field as the response frame.

If the ALLOCATED RESPONSE LENGTH field is not set to 00h, then the management device server shall:

- a) set the RESPONSE LENGTH field in the response frame to the non-zero value defined in table 248; and
- b) return the response frame as specified by the ALLOCATED RESPONSE LENGTH field.

The REQUEST LENGTH field is defined in 10.4.3.2.5 and shall be set to the value defined in table 247.

The CRC field is defined in 10.4.3.2.8.

Table 248 defines the response format.

Table 248 — REPORT GENERAL response (part 1 of 3)

Byte\Bit	7	6	5	4	3	2	1	0
0	SMP FRAME TYPE (41h)							
1	FUNCTION (00h)							
2	FUNCTION RESULT							
3	RESPONSE LENGTH (00h or 11h)							
4	(MSB)	EXPANDER CHANGE COUNT						(LSB)
5								
6	(MSB)	EXPANDER ROUTE INDEXES						(LSB)
7								
8	LONG RESPONSE	Reserved						
9	NUMBER OF PHYS							

Author: Isi-bbesmer

Subject: Note

Date: 6/2/2008 9:43:30 AM

 ACCEPT - DONE ("return the response frame as defined in 10.4.3.2.4" for all instances of this wording)

(global)

this is recursive. perhaps add reference to ARL clause?

b) return the response frame as specified by the ALLOCATED RESPONSE LENGTH field (see 10.4.3.2.4).

Table 248 — REPORT GENERAL response (part 2 of 3)

Byte/Bit	7	6	5	4	3	2	1	0
10	TABLE TO TABLE SUPPORTED	Reserved		STP CONTINUE AWT	OPEN REJECT RETRY SUPPORTED	CONFIGURES OTHERS	CONFIGURING	EXTERNALLY CONFIGURABLE ROUTE TABLE
11	Reserved							
12	ENCLOSURE LOGICAL IDENTIFIER							
19								
20	Reserved							
27								
28	Reserved							
29								
30	(MSB)	STP BUS INACTIVITY TIME LIMIT						(LSB)
31								
32	(MSB)	STP MAXIMUM CONNECT TIME LIMIT						(LSB)
33								
34	(MSB)	STP SMP I_T NEXUS LOSS TIME						(LSB)
35								
36	NUMBER OF ZONE GROUPS	Reserved	ZONE LOCKED	PHYSICAL PRESENCE SUPPORTED	PHYSICAL PRESENCE ASSERTED	ZONING SUPPORTED	ZONING ENABLED	
37	Reserved		SAVING	SAVING ZONE MANAGER PASSWORD SUPPORTED	SAVING ZONE PHY INFORMATION SUPPORTED	SAVING ZONE PERMISSION TABLE SUPPORTED	SAVING ZONING ENABLED SUPPORTED	
38	(MSB)	MAXIMUM NUMBER OF ROUTED SAS ADDRESSES						(LSB)
39								
40	ACTIVE ZONE MANAGER SAS ADDRESS							
47								
48	(MSB)	ZONE LOCK INACTIVITY TIME LIMIT						(LSB)
49								
50	Reserved							
51								
52	Reserved							
53	FIRST ENCLOSURE CONNECTOR ELEMENT INDEX							

● Author: RElliott
Subject: Note
Date: 6/30/2008 6:16:52 PM
 ACCEPT - DONE

Augment the CONFIGURING bit with 2 new bits (per lsi-bbesmer comment on first page), with definitions below (see comment on page 570)

Table 248 — REPORT GENERAL response (part 3 of 3)

Byte/Bit	7	6	5	4	3	2	1	0
54	NUMBER OF ENCLOSURE CONNECTOR ELEMENT INDEXES							
55	Reserved							
56	REDUCED FUNCTIONALITY	Reserved						
57	TIME TO REDUCED FUNCTIONALITY							
58	INITIAL TIME TO REDUCED FUNCTIONALITY							
59	MAXIMUM REDUCED FUNCTIONALITY TIME							
60	(MSB)	LAST SELF-CONFIGURATION STATUS DESCRIPTOR INDEX						(LSB)
61								
62	(MSB)	MAXIMUM NUMBER OF STORED SELF-CONFIGURATION STATUS DESCRIPTORS						(LSB)
63								
64	(MSB)	LAST PHY EVENT LIST DESCRIPTOR INDEX						(LSB)
65								
66	(MSB)	MAXIMUM NUMBER OF STORED PHY EVENT LIST DESCRIPTORS						(LSB)
67								
68	(MSB)	STP REJECT TO OPEN LIMIT						(LSB)
69								
70	Reserved							
71								
72	(MSB)	CFC						(LSB)
75								

The SMP FRAME TYPE field is defined in 10.4.3.3.2 and shall be set to the value defined in table 248.

The FUNCTION field is defined in 10.4.3.3.3 and shall be set to the value defined in table 248.

The FUNCTION RESULT field is defined in 10.4.3.3.4.

The RESPONSE LENGTH field is defined in 10.4.3.3.5 and shall be set to one of the values defined in table 248 based on the ALLOCATED RESPONSE LENGTH field in the request frame.

The EXPANDER CHANGE COUNT field counts the number of Broadcast (Change)s originated by an expander device (see 7.11). Management device servers in expander devices shall support this field. Management device servers in other device types (e.g., end devices) shall set this field to 0000h. This field shall be set to at least 0001h at power on. If the expander device has originated Broadcast (Change) for any reason prescribed in 7.11 since transmitting any SMP response frame containing an EXPANDER CHANGE COUNT field, it shall increment this field at least once from the value in the previous REPORT GENERAL response. It shall not increment this field when forwarding a Broadcast (Change). This field shall wrap to at least 0001h after the maximum value (i.e., FFFFh) has been reached.

● Author: wdc-mevans
Subject: Highlight
Date: 5/23/2008 2:31:26 PM
T ACCEPT - DONE (as "indicates")

counts
s/b
contains

● Author: wdc-mevans
Subject: Highlight
Date: 5/26/2008 12:16:55 PM
T REJECT (first noun/subject convention, but added "then")

it
s/b
then the management device server

● Author: wdc-mevans
Subject: Highlight
Date: 5/26/2008 12:17:13 PM
T REJECT (subject of previous sentence)

It
s/b
The management device server

NOTE 103 - Application clients that use the EXPANDER CHANGE COUNT field should read it often enough to ensure that it does not increment a multiple of 65 535 times between reading the field in an expander device compliant with this standard or a multiple of 65 536 times between reading the field in an expander device compliant with previous versions of this standard.

NOTE 104 - Management device servers in expander devices compliant with previous versions of this standard may return an EXPANDER CHANGE COUNT field set to 0000h.

NOTE 105 - The originated Broadcast (Change) count is also reported in the REPORT BROADCAST response (see 10.4.3.9).

The EXPANDER ROUTE INDEXES field indicates the maximum number of expander route indexes per phy for the expander device (see 4.6.7.3). Management device servers in externally configurable expander devices containing phy-based expander route tables shall support this field. Management device servers in other device types (e.g., end devices, externally configurable expander devices with expander-based expander route tables, and self-configuring expander devices) shall set the EXPANDER ROUTE INDEXES field to zero. Not all phys in an externally configurable expander device are required to support the maximum number indicated by this field.

A LONG RESPONSE bit set to one indicates that the management device server supports returning non-zero values in the RESPONSE LENGTH field of the response frame for any SMP function when the ALLOCATED RESPONSE LENGTH field in the request frame for that SMP function is set to a non-zero value. The LONG RESPONSE bit shall be set to one.

NOTE 106 - Devices compliant with previous versions of this standard set the LONG RESPONSE bit to zero in the REPORT GENERAL response and set the RESPONSE LENGTH field to 00h in all SMP response frames.

The NUMBER OF PHYS field indicates the number of phys in the device, including any virtual phys and any vacant phys.

A TABLE TO TABLE SUPPORTED bit set to one indicates that the expander device is a self-configuring expander device that supports its table routing phys being attached to table routing phys in other expander devices. The TABLE TO TABLE SUPPORTED bit shall only be set to one if the EXTERNALLY CONFIGURABLE ROUTE TABLE bit is set to zero. A TABLE TO TABLE SUPPORTED bit set to zero indicates that the expander device is not a self-configuring expander device that supports its table routing phys being attached to table routing phys in other expander devices.

An STP CONTINUE AWT bit set to one specifies that the STP port shall not stop the Arbitration Wait Time timer and set the Arbitration Wait Time timer to zero when the STP port receives an OPEN_REJECT (RETRY). An STP CONTINUE AWT bit set to zero specifies that the STP port shall stop the Arbitration Wait Time timer and set the Arbitration Wait Time timer to zero when the STP port receives an OPEN_REJECT (RETRY).

An OPEN REJECT RETRY SUPPORTED bit set to one indicates that the expander device returns OPEN_REJECT (RETRY) for any connection requests that would otherwise have resulted in OPEN_REJECT (NO DESTINATION) while the CONFIGURING bit is set to one (see 4.7.2). An OPEN REJECT RETRY SUPPORTED set to zero indicates that the expander device complies with previous versions of this standard (i.e. returns OPEN_REJECT (NO DESTINATION)). Self-configuring expander devices compliant with this standard shall set the OPEN REJECT RETRY SUPPORTED bit to one.

A CONFIGURES OTHERS bit set to one indicates that the expander device is a self-configuring expander device that performs the configuration subprocess defined in 4.8. A CONFIGURES OTHERS bit set to zero indicates that the expander device may or may not perform the configuration subprocess. Self-configuring expander devices compliant with this standard shall set the CONFIGURES OTHERS bit to one.

NOTE 107 - If the CONFIGURES OTHERS bit is set to zero, the expander device may configure all externally configurable expander devices in the SAS domain.

Page: 570

Author: RElliott
Subject: Highlight
Date: 6/30/2008 6:16:52 PM
T ACCEPT - DONE

zero
s/b
0000h

Author: Isi-bbesmer
Subject: Highlight
Date: 6/9/2008 4:40:30 PM
T ACCEPT - DONE (Added rules to 4.6.7.1; see comments added there 5/7 agree need to introduce this concept in the model section)

This seems to be the only place this rule is specified, namely that Table to Table is ONLY allowed on Self-configuring expanders.

Author: RElliott
Subject: Underline
Date: 6/30/2008 6:16:52 PM
T ACCEPT - DONE

expander devices
s/b
expander devices (i.e., table-to-table attachment)

so searches for table-to-table (with the dashes) will find this field.

Author: RElliott
Subject: Highlight
Date: 6/30/2008 6:16:52 PM
T ACCEPT - DONE

while the CONFIGURING bit is set to one (see 4.7.2).
s/b
while the self configuring bit is set to one (see 4.7.2) or the zone configuring bit is set to one (see 4.9.6.3).

to match Isi-bbesmer comment on first page

Author: wdc-mevans
Subject: Highlight
Date: 5/6/2008 4:07:50 PM
T ACCEPT - DONE (but with a dreaded "it")

(i.e. returns OPEN_REJECT (NO DESTINATION))
s/b
(i.e., the expander device returns OPEN_REJECT (NO DESTINATION) while the CONFIGURING bit is set to one)

Author: Isi-gpenokie
Subject: Highlight
Date: 5/26/2008 12:18:06 PM
T REJECT(expander devices compliant with this standard must have the bit set to one. This note is describing the behavior of expander devices not compliant with this standard (e.g., compliant with SAS-1.1))

This note << NOTE 107 - If the CONFIGURES >> should be normative.

Author: RElliott
Subject: Highlight
Date: 6/30/2008 6:16:52 PM

Comments from page 570 continued on next page

NOTE 103 - Application clients that use the EXPANDER CHANGE COUNT field should read it often enough to ensure that it does not increment a multiple of 65 535 times between reading the field in an expander device compliant with this standard or a multiple of 65 536 times between reading the field in an expander device compliant with previous versions of this standard.

NOTE 104 - Management device servers in expander devices compliant with previous versions of this standard may return an EXPANDER CHANGE COUNT field set to 0000h.

NOTE 105 - The originated Broadcast (Change) count is also reported in the REPORT BROADCAST response (see 10.4.3.9).

The EXPANDER ROUTE INDEXES field indicates the maximum number of expander route indexes per phy for the expander device (see 4.6.7.3). Management device servers in externally configurable expander devices containing phy-based expander route tables shall support this field. Management device servers in other device types (e.g., end devices, externally configurable expander devices with expander-based expander route tables, and self-configuring expander devices) shall set the EXPANDER ROUTE INDEXES field to zero. Not all phys in an externally configurable expander device are required to support the maximum number indicated by this field.

A LONG RESPONSE bit set to one indicates that the management device server supports returning non-zero values in the RESPONSE LENGTH field of the response frame for any SMP function when the ALLOCATED RESPONSE LENGTH field in the request frame for that SMP function is set to a non-zero value. The LONG RESPONSE bit shall be set to one.

NOTE 106 - Devices compliant with previous versions of this standard set the LONG RESPONSE bit to zero in the REPORT GENERAL response and set the RESPONSE LENGTH field to 00h in all SMP response frames.

The NUMBER OF PHYS field indicates the number of phys in the device, including any virtual phys and any vacant phys.

A TABLE TO TABLE SUPPORTED bit set to one indicates that the expander device is a self-configuring expander device that supports its table routing phys being attached to table routing phys in other expander devices. The TABLE TO TABLE SUPPORTED bit shall only be set to one if the EXTERNALLY CONFIGURABLE ROUTE TABLE bit is set to zero. A TABLE TO TABLE SUPPORTED bit set to zero indicates that the expander device is not a self-configuring expander device that supports its table routing phys being attached to table routing phys in other expander devices.

An STP CONTINUE AWT bit set to one specifies that the STP port shall not stop the Arbitration Wait Time timer and set the Arbitration Wait Time timer to zero when the STP port receives an OPEN_REJECT (RETRY). An STP CONTINUE AWT bit set to zero specifies that the STP port shall stop the Arbitration Wait Time timer and set the Arbitration Wait Time timer to zero when the STP port receives an OPEN_REJECT (RETRY).

An OPEN REJECT RETRY SUPPORTED bit set to one indicates that the expander device returns OPEN_REJECT (RETRY) for any connection requests that would otherwise have resulted in OPEN_REJECT (NO DESTINATION) while the CONFIGURING bit is set to one (see 4.7.2). An OPEN REJECT RETRY SUPPORTED set to zero indicates that the expander device complies with previous versions of this standard (i.e. returns OPEN_REJECT (NO DESTINATION)). Self-configuring expander devices compliant with this standard shall set the OPEN REJECT RETRY SUPPORTED bit to one.

A CONFIGURES OTHERS bit set to one indicates that the expander device is a self-configuring expander device that performs the configuration subprocess defined in 4.8. A CONFIGURES OTHERS bit set to zero indicates that the expander device may or may not perform the configuration subprocess. Self-configuring expander devices compliant with this standard shall set the CONFIGURES OTHERS bit to one.

NOTE 107 - If the CONFIGURES OTHERS bit is set to zero, the expander device may configure all externally configurable expander devices in the SAS domain.

T ACCEPT - DONE

the
s/b
then the

Author: RElliott
Subject: Highlight
Date: 6/30/2008 6:16:52 PM

T ACCEPT - DONE

the
s/b
then the

A CONFIGURING bit set to one indicates that either:

- a) the management device server is in a self-configuring expander device, the self-configuring expander device's management application client is currently performing the discover process (see 4.7), and it has identified at least one change to its expander routing table; or
- b) the zoning expander device is locked and the zoning expander shadow values differ from the zoning expander active values.

A CONFIGURING bit set to zero indicates that the management device server is not in a self-configuring expander device currently performing the discover process and changing its expander routing table. Changes in this bit from one to zero result in a Broadcast (Change) being originated (see 7.11). Management device servers in self-configuring expander devices shall support this bit. Management device servers in externally configurable expander devices and in other device types shall set the CONFIGURING bit to zero.

An EXTERNALLY CONFIGURABLE ROUTE TABLE bit set to one indicates that the management device server is in an externally configurable expander device that has a phy-based expander route table that is required to be configured with the SMP CONFIGURE ROUTE INFORMATION function (see 4.6.7.3). An EXTERNALLY CONFIGURABLE ROUTE TABLE bit set to zero indicates that the management device server is not in an externally configurable expander device (e.g., it is in an end device, in a self-configuring expander device, or in an expander device with no phys with table routing attributes).

The ENCLOSURE LOGICAL IDENTIFIER field identifies the enclosure, if any, in which the device is located, and is defined in SES-2. The ENCLOSURE LOGICAL IDENTIFIER field shall be set to the same value reported by the enclosure services process, if any, for the enclosure. An ENCLOSURE LOGICAL IDENTIFIER field set to zero indicates no enclosure information is available.

The STP BUS INACTIVITY TIME LIMIT field indicates the bus inactivity time limit for STP connections, which is set by the CONFIGURE GENERAL function (see 10.4.3.18).

The STP MAXIMUM CONNECT TIME LIMIT field indicates the maximum connect time limit for STP connections, which is set by the CONFIGURE GENERAL function (see 10.4.3.18).

The STP SMP I_T NEXUS LOSS TIME field indicates the minimum time that an STP target port and an SMP initiator port retry certain connection requests which is set by the CONFIGURE GENERAL function (see 10.4.3.18).

The number of zone groups field indicates the number of zone groups (e.g., the number of entries in the zone group permission table) supported by the expander device and is defined in table 249.

Table 249 — NUMBER OF ZONE GROUPS field

Code	Description
00b	128 zone groups
01b	256 zone groups
All others	Reserved

A ZONE LOCKED bit set to one indicates that the zoning expander device is locked (see 4.9.6.2). A ZONE LOCKED bit set to zero indicates that the zoning expander device is not locked.

A PHYSICAL PRESENCE SUPPORTED bit set to one indicates that the expander device supports physical presence as a mechanism for allowing locking from phys in zone groups without access to zone group 2. A PHYSICAL PRESENCE SUPPORTED bit set to zero indicates that the expander device does not support physical presence as a mechanism for allowing locking.

A PHYSICAL PRESENCE ASSERTED bit set to one indicates that the expander device is currently detecting physical presence. A PHYSICAL PRESENCE ASSERTED bit set to zero indicates that the expander device is not currently detecting physical presence. The PHYSICAL PRESENCE ASSERTED bit shall be set to zero if the PHYSICAL PRESENCE SUPPORTED bit is set to zero.

Page: 571

Author: wdc-mevans
Subject: Highlight
Date: 5/29/2008 2:55:27 PM
 ACCEPT - DONE ("that management application client")

it
s/b
the management application client

Author: RElliott
Subject: Note
Date: 6/30/2008 6:16:52 PM
 ACCEPT - DONE

Augment the CONFIGURING bit with 2 new bits (per lsi-bbesmer comment on first page), with these definitions:

A zone configuring bit set to one indicates that the zoning expander device is locked and the zoning expander shadow values differ from the zoning expander current values. A zone configuring bit set to zero indicates that is not true. Management device servers in zoning expander devices shall support this bit. Management device servers in non-zoning expander devices and in other device types shall set this bit to zero.

A self configuring bit set to one indicates that the management device server is in a self-configuring expander device, the self-configuring expander device's management application client is currently performing the discover process (see 4.7), and that management application client has identified at least one change to its expander routing table. Management device servers in self-configuring expander devices shall support this bit. Management device servers in externally configurable expander devices and in other device types shall set this bit to zero.

The configuring bit indicates the logical OR of the zone configuring bit and the self configuring bit. Changes in this bit from one to zero result in a Broadcast (Change) being originated (see 7.11). Management device servers that support the zone configuring bit or the self configuring bit shall support this bit.

Author: wdc-mevans
Subject: Highlight
Date: 5/29/2008 2:56:52 PM
 ACCEPT - DONE

it
s/b
the management device server

Author: wdc-mevans
Subject: Highlight
Date: 5/29/2008 2:56:22 PM
 REJECT (yes, a reserved device type)

e.g.
s/b
i.e. [are there any other cases not listed?]

Author: RElliott
Subject: Highlight
Date: 6/30/2008 6:16:52 PM
 ACCEPT - DONE

phys with table routing attributes
s/b
table routing phys

Author: RElliott

Comments from page 571 continued on next page



A CONFIGURING bit set to one indicates that either:

- a) the management device server is in a self-configuring expander device, the self-configuring expander device's management application client is currently performing the discover process (see 4.7), and it has identified at least one change to its expander routing table; or
- b) the zoning expander device is locked and the zoning expander shadow values differ from the zoning expander active values.

A CONFIGURING bit set to zero indicates that the management device server is not in a self-configuring expander device currently performing the discover process and changing its expander routing table. Changes in this bit from one to zero result in a Broadcast (Change) being originated (see 7.11). Management device servers in self-configuring expander devices shall support this bit. Management device servers in externally configurable expander devices and in other device types shall set the CONFIGURING bit to zero.

An EXTERNALLY CONFIGURABLE ROUTE TABLE bit set to one indicates that the management device server is in an externally configurable expander device that has a phy-based expander route table that is required to be configured with the SMP CONFIGURE ROUTE INFORMATION function (see 4.6.7.3). An EXTERNALLY CONFIGURABLE ROUTE TABLE bit set to zero indicates that the management device server is not in an externally configurable expander device (e.g., it is in an end device, in a self-configuring expander device, or in an expander device with no phys with table routing attributes).

The ENCLOSURE LOGICAL IDENTIFIER field identifies the enclosure, if any, in which the device is located, and is defined in SES-2. The ENCLOSURE LOGICAL IDENTIFIER field shall be set to the same value reported by the enclosure services process, if any, for the enclosure. An ENCLOSURE LOGICAL IDENTIFIER field set to zero indicates no enclosure information is available.

The STP BUS INACTIVITY TIME LIMIT field indicates the bus inactivity time limit for STP connections, which is set by the CONFIGURE GENERAL function (see 10.4.3.18).

The STP MAXIMUM CONNECT TIME LIMIT field indicates the maximum connect time limit for STP connections, which is set by the CONFIGURE GENERAL function (see 10.4.3.18).

The STP SMP I_T NEXUS LOSS TIME field indicates the minimum time that an STP target port and an SMP initiator port retry certain connection requests which is set by the CONFIGURE GENERAL function (see 10.4.3.18).

The number of zone groups field indicates the number of zone groups (e.g., the number of entries in the zone group permission table) supported by the expander device and is defined in table 249.

Table 249 — NUMBER OF ZONE GROUPS field

Code	Description
00b	128 zone groups
01b	256 zone groups
All others	Reserved

A ZONE LOCKED bit set to one indicates that the zoning expander device is locked (see 4.9.6.2). A ZONE LOCKED bit set to zero indicates that the zoning expander device is not locked.

A PHYSICAL PRESENCE SUPPORTED bit set to one indicates that the expander device supports physical presence as a mechanism for allowing locking from phys in zone groups without access to zone group 2. A PHYSICAL PRESENCE SUPPORTED bit set to zero indicates that the expander device does not support physical presence as a mechanism for allowing locking.

A PHYSICAL PRESENCE ASSERTED bit set to one indicates that the expander device is currently detecting physical presence. A PHYSICAL PRESENCE ASSERTED bit set to zero indicates that the expander device is not currently detecting physical presence. The PHYSICAL PRESENCE ASSERTED bit shall be set to zero if the PHYSICAL PRESENCE SUPPORTED bit is set to zero.

Subject: Highlight
Date: 6/30/2008 6:16:52 PM
T ACCEPT - DONE

zero
s/b
00000000 00000000h

Author: Isi-bbesmer
Subject: Highlight
Date: 5/26/2008 12:19:02 PM
T ACCEPT - DONE

number of zone groups

small-caps

Author: wdc-mevans
Subject: Highlight
Date: 5/6/2008 4:07:50 PM
T ACCEPT - DONE
number of zone groups
s/b
small caps

A ZONING SUPPORTED bit set to one indicates that zoning is supported by the expander device (i.e., it is a zoning expander device). A ZONING SUPPORTED bit set to zero indicates that zoning is not supported by the expander device.

A ZONING ENABLED bit set to one indicates that zoning is enabled in the expander device. A ZONING ENABLED bit set to zero indicates that zoning is disabled in the expander device. The ZONING ENABLED bit shall be set to zero if the ZONING SUPPORTED bit is set to zero.

A SAVING bit set to one indicates that the management device server is currently saving zoning values to non-volatile storage and may return a function result of BUSY for zone management functions that access saved zoning values. A SAVING bit set to zero indicates that the management device server is not currently saving zoning values to non-volatile storage.

A SAVING ZONE MANAGER PASSWORD SUPPORTED bit set to one indicates that saving the zone manager password is supported. A SAVING ZONE MANAGER PASSWORD SUPPORTED bit set to zero indicates that saving the zone manager password is not supported.

A SAVING ZONE PHY INFORMATION SUPPORTED bit set to one indicates that saving the zone phy information is supported. A SAVING ZONE PHY INFORMATION SUPPORTED bit set to zero indicates that saving the zone phy information is not supported.

A SAVING ZONE PERMISSION TABLE SUPPORTED bit set to one indicates that saving the zone permission table is supported. A SAVING ZONE PERMISSION TABLE SUPPORTED bit set to zero indicates that saving the zone permission table is not supported.

A SAVING ZONING ENABLE SUPPORTED bit set to one indicates that saving the ZONING ENABLED bit is supported. A SAVING ZONING ENABLE SUPPORTED bit set to zero indicates that saving the ZONING ENABLED bit is not supported.

The MAXIMUM NUMBER OF ROUTED SAS ADDRESSES field indicates the number of routed SAS addresses in an expander-based expander route table (see 4.6.7.3 and 4.9.3.4). Management device servers in expander devices containing expander-based expander route tables shall support this field. Management device servers in other device types (e.g., end devices and expander devices with phy-based expander route tables) shall set this field to 0000h.

The ACTIVE ZONE MANAGER SAS ADDRESS field indicates the SAS address of the zone manager that last locked the zoning expander device. If the zoning expander device is currently being configured by a vendor-specific sideband method then the ACTIVE ZONE MANAGER SAS ADDRESS field shall be set to 00000000 00000000h. This field shall be set to 00000000 00000000h at power on.

The ZONE LOCK INACTIVITY TIME LIMIT field indicates the minimum time between any SMP ZONE LOCK requests, SMP Zone configuration function requests, or SMP ZONE ACTIVATE requests from the active zone manager that the locked expander device allows and is set in the SMP ZONE LOCK request (see 10.4.3.21).

The FIRST ENCLOSURE CONNECTOR ELEMENT INDEX field indicates the lowest CONNECTOR ELEMENT INDEX field of all the expander phys in all the expander devices in the enclosure that have CONNECTOR TYPE fields set to 20h through 2Fh (i.e., an internal connector to an end device) in their SMP DISCOVER responses.

The NUMBER OF ENCLOSURE CONNECTOR ELEMENT INDEXES field indicates the number of expander phys in all the expander devices in the enclosure that have CONNECTOR TYPE fields set to 20h through 2Fh (i.e., an internal connector to an end device) in their SMP DISCOVER responses.

NOTE 108 - The NUMBER OF ENCLOSURE CONNECTOR ELEMENT INDEXES field assumes that all internal connectors to end devices are assigned to a contiguous range of CONNECTOR ELEMENT INDEX field values.

A REDUCED FUNCTIONALITY bit set to one indicates that:

- a) the expander device is scheduled to reduce its functionality (see 4.6.8) in the time indicated in the TIME TO REDUCED FUNCTIONALITY field; or
- b) the expander device is currently operating with reduced functionality (see 4.6.8).

A REDUCED FUNCTIONALITY bit set to zero indicates that the expander device is not scheduled to reduce functionality and that the contents of the TIME TO REDUCED FUNCTIONALITY field shall be ignored.

● Author: RElliott
Subject: Highlight
Date: 6/30/2008 6:16:52 PM
T ACCEPT - DONE

SAS address

add "(see 4.2.4)" to support the new section

● Author: lsi-bbesmer
Subject: Highlight
Date: 7/14/2008 6:07:06 PM

T REJECT (new fields at the end of DISCOVER will be more useful for what this was being used for. Current wording is correct as is.)

Need to clarify the usage of connector element index. Current usage assumes that CEI is the same value for all phys w/in a connector.

If the REDUCED FUNCTIONALITY bit is set to one, then the TIME TO REDUCED FUNCTIONALITY field indicates the time, in 100 ms increments, remaining until the expander device is scheduled to reduce functionality. The expander device starts the reduced functionality delay timer after originating a Broadcast (Expander) (see 4.6.8).

The INITIAL TIME TO REDUCED FUNCTIONALITY field indicates the minimum period of time, in 100 ms increments, that an expander device waits from originating a Broadcast (Expander) to reducing functionality. The expander device should set the default value for the INITIAL TIME TO REDUCED FUNCTIONALITY field to at least 2 000 ms (i.e., 14h).

The MAXIMUM REDUCED FUNCTIONALITY TIME field indicates the maximum time, in seconds, that the expander device responds with OPEN_REJECT (RETRY) to connection requests that map to an expander phy or an SMP target port that is not accessible during expander device reduced functionality. This timer starts after the reduced functionality delay timer expires.

The LAST SELF-CONFIGURATION STATUS DESCRIPTOR INDEX field is defined in the REPORT SELF-CONFIGURATION STATUS response (see 10.4.3.6).

The MAXIMUM NUMBER OF STORED SELF-CONFIGURATION STATUS DESCRIPTORS field indicates the maximum number of self-configuration status descriptors (see 10.4.3.6.4) that the management device server supports.

The LAST PHY EVENT LIST DESCRIPTOR INDEX field is defined in the REPORT PHY EVENT LIST response (see 10.4.3.16).

The MAXIMUM NUMBER OF STORED PHY EVENT LIST DESCRIPTORS field indicates the maximum number of phy event list descriptors (see 10.4.3.14.4) that the management device server supports.

The STP REJECT TO OPEN LIMIT field indicates the minimum time in 10 μ s increments that an STP port waits to establish a connection request with an initiator port on an I_T nexus after receiving an OPEN_REJECT (RETRY), OPEN_REJECT (CONTINUE 0), or OPEN_REJECT (CONTINUE 1). An STP REJECT TO OPEN LIMIT field set to 0000h indicates that the time limit is vendor specific.

The CRC field is defined in 10.4.3.3.8.

10.4.3.5 REPORT MANUFACTURER INFORMATION function

The REPORT MANUFACTURER INFORMATION function returns vendor and product identification. This SMP function may be implemented by any management device server.

Table 250 defines the request format.

Table 250 — REPORT MANUFACTURER INFORMATION request

Byte\Bit	7	6	5	4	3	2	1	0	
0	SMP FRAME TYPE (40h)								
1	FUNCTION (01h)								
2	ALLOCATED RESPONSE LENGTH								
3	REQUEST LENGTH (00h)								
4	(MSB)	CRC						(LSB)	
7									

The SMP FRAME TYPE field is defined in 10.4.3.2.2 and shall be set to the value defined in table 250.

The FUNCTION field is defined in 10.4.3.2.3 and shall be set to the value defined in table 250.

The ALLOCATED RESPONSE LENGTH field is defined in 10.4.3.2.4.

This page contains no comments

If the ALLOCATED RESPONSE LENGTH field is set to 00h, then the management device server shall:

- a) set the RESPONSE LENGTH field to 00h in the response frame; and
- b) return the first 60 bytes defined in table 251 plus the CRC field as the response frame.

If the ALLOCATED RESPONSE LENGTH field is not set to 00h, then the management device server shall:

- a) set the RESPONSE LENGTH field in the response frame to the non-zero value defined in table 251; and
- b) return the response frame as specified by the ALLOCATED RESPONSE LENGTH field.

The REQUEST LENGTH field is defined in 10.4.3.2.5 and shall be set to the value defined in table 250.

The CRC field is defined in 10.4.3.2.8.

This page contains no comments

Table 251 defines the response format.

Table 251 — REPORT MANUFACTURER INFORMATION response

Byte\Bit	7	6	5	4	3	2	1	0
0	SMP FRAME TYPE (41h)							
1	FUNCTION (01h)							
2	FUNCTION RESULT							
3	RESPONSE LENGTH (00h or 0Eh)							
4	(MSB)	EXPANDER CHANGE COUNT						(LSB)
5	Reserved							
6	Reserved							
7	Reserved							
8	Reserved							SAS-1.1 FORMAT
9	Reserved							
11	Reserved							
12	(MSB)	VENDOR IDENTIFICATION						(LSB)
19	Reserved							
20	(MSB)	PRODUCT IDENTIFICATION						(LSB)
35	Reserved							
36	(MSB)	PRODUCT REVISION LEVEL						(LSB)
39	Reserved							
40	(MSB)	COMPONENT VENDOR IDENTIFICATION						(LSB)
47	Reserved							
48	(MSB)	COMPONENT ID						(LSB)
49	Reserved							
50	COMPONENT REVISION LEVEL							
51	Reserved							
52	Vendor specific							
59	Reserved							
60	(MSB)	CRC						(LSB)
63	Reserved							

This page contains no comments

The SMP FRAME TYPE field is defined in 10.4.3.3.2 and shall be set to the value defined in table 251.

The FUNCTION field is defined in 10.4.3.3.3 and shall be set to the value defined in table 251.

The FUNCTION RESULT field is defined in 10.4.3.3.4.

The RESPONSE LENGTH field is defined in 10.4.3.3.5 and shall be set to one of the values defined in table 251 based on the ALLOCATED RESPONSE LENGTH field in the request frame.

The EXPANDER CHANGE COUNT field is defined in the SMP REPORT GENERAL response (see 10.4.3.4).

A SAS-1.1 FORMAT bit set to one indicates that bytes 40 through 59 are as defined in this standard. A SAS-1.1 FORMAT bit set to zero indicates that bytes 40 through 59 are vendor-specific as defined in the original version of this standard.

ASCII data fields (e.g., the VENDOR IDENTIFICATION field, the PRODUCT IDENTIFICATION field, and PRODUCT REVISION LEVEL field, and the COMPONENT VENDOR IDENTIFICATION field) shall contain only graphic codes (i.e., code values 20h through 7Eh). Left-aligned fields shall place any unused bytes at the end of the field (i.e., at the highest offset) and the unused bytes shall be filled with space characters (i.e., 20h).

The VENDOR IDENTIFICATION field contains eight bytes of ASCII data identifying the vendor of the subsystem (e.g., the board or enclosure) containing the component. The data shall be left-aligned within the field. The vendor identification string shall be one assigned by INCITS for use in the standard INQUIRY data VENDOR IDENTIFICATION field. A list of assigned vendor identification strings is in SPC-4 and on the T10 web site (<http://www.t10.org>).

The PRODUCT IDENTIFICATION field contains 16 bytes of ASCII data identifying the type of the subsystem (e.g., the board or enclosure model number) containing the component, as defined by the vendor of the subsystem. The data shall be left-aligned within the field. The PRODUCT IDENTIFICATION field should be changed whenever the subsystem design changes in a way noticeable to a user (e.g., a different stock-keeping unit (SKU)).

The PRODUCT REVISION LEVEL field contains four bytes of ASCII data identifying the revision level of the subsystem (e.g., the board or enclosure) containing the component, as defined by the vendor of the subsystem. The data shall be left-aligned within the field. The PRODUCT REVISION LEVEL field should be changed whenever the subsystem design changes (e.g., any component change, even including resistor values).

All components on a subsystem should have the same values for their VENDOR IDENTIFICATION fields, PRODUCT IDENTIFICATION fields, and PRODUCT REVISION LEVEL fields.

NOTE 109 - Application clients may use the VENDOR IDENTIFICATION field and PRODUCT IDENTIFICATION field to identify the subsystem (e.g., for a user interface). Application clients may use the VENDOR IDENTIFICATION field, PRODUCT IDENTIFICATION field, PRODUCT REVISION LEVEL field to perform workarounds for problems in a specific revision of a subsystem.

The COMPONENT VENDOR IDENTIFICATION field contains eight bytes of ASCII data identifying the vendor of the component (e.g., the expander device) containing the management device server. The data shall be left-aligned within the field. The component vendor identification string shall be one assigned by INCITS for use in the standard INQUIRY data VENDOR IDENTIFICATION field. A list of assigned vendor identification strings is in SPC-4 and on the T10 web site (<http://www.t10.org>).

The COMPONENT ID field contains a 16-bit identifier identifying the type of the component (e.g., the expander device model number) containing the management device server, as defined by the vendor of the component. The COMPONENT ID field should be changed whenever the component's programming interface (e.g., the management device server definition) changes.

The COMPONENT REVISION LEVEL field contains an 8-bit identifier identifying the revision level of the component (e.g., the expander device) containing the management device server, as defined by the vendor of the component. The COMPONENT REVISION LEVEL field should be changed whenever the component changes but its programming interface does not change.

NOTE 110 - Application clients may use the COMPONENT VENDOR IDENTIFICATION field and the COMPONENT ID field to interpret vendor-specific information (e.g., vendor-specific SMP functions) correctly for that component. Application clients may use the COMPONENT VENDOR IDENTIFICATION field, the

Page: 576

Author: elx-bmartin
Subject: Comment on Text
Date: 5/23/2008 3:58:10 PM

T REJECT ("the original" gives a stronger hint that it's SAS-1.0 only. Although the bit name is pretty clear too...)

s/b

a previous

Author: lsi-bday
Subject: Highlight
Date: 5/26/2008 12:19:33 PM

T REJECT (previous versions to SAS-2 will mean both SAS-1 and SAS-1.1; these bits were only vendor specific in SAS-1.)

the original version

suggest

previous versions

Author: wdc-mevans
Subject: Highlight
Date: 5/26/2008 12:22:23 PM

T ACCEPT - DONE (global change to "see [http:// ...](#)". Mark will suggest similar change to similar wording in SPC-4)

(<http://www.t10.org>)

s/b

(i.e., at <http://www.t10.org>)

Author: wdc-mevans
Subject: Highlight
Date: 5/26/2008 12:23:39 PM

T REJECT

component, as

s/b

component as

Author: wdc-mevans
Subject: Highlight
Date: 5/26/2008 12:22:52 PM

T REJECT (we don't use i.e. for acronyms)

unit (SKU)).

s/b

unit number (i.e, SKU)).

Author: wdc-mevans
Subject: Highlight
Date: 5/26/2008 12:23:11 PM

T ACCEPT - DONE (with "see " - see previous comment on [http](#))

(<http://www.t10.org>)

s/b

(i.e., at <http://www.t10.org>)

Author: wdc-mevans
Subject: Highlight
Date: 5/26/2008 12:23:25 PM

T REJECT

server, as

Comments from page 576 continued on next page

The SMP FRAME TYPE field is defined in 10.4.3.3.2 and shall be set to the value defined in table 251.

The FUNCTION field is defined in 10.4.3.3.3 and shall be set to the value defined in table 251.

The FUNCTION RESULT field is defined in 10.4.3.3.4.

The RESPONSE LENGTH field is defined in 10.4.3.3.5 and shall be set to one of the values defined in table 251 based on the ALLOCATED RESPONSE LENGTH field in the request frame.

The EXPANDER CHANGE COUNT field is defined in the SMP REPORT GENERAL response (see 10.4.3.4).

A SAS-1.1 FORMAT bit set to one indicates that bytes 40 through 59 are as defined in this standard. A SAS-1.1 FORMAT bit set to zero indicates that bytes 40 through 59 are vendor-specific as defined in the original version of this standard.

ASCII data fields (e.g., the VENDOR IDENTIFICATION field, the PRODUCT IDENTIFICATION field, and PRODUCT REVISION LEVEL field, and the COMPONENT VENDOR IDENTIFICATION field) shall contain only graphic codes (i.e., code values 20h through 7Eh). Left-aligned fields shall place any unused bytes at the end of the field (i.e., at the highest offset) and the unused bytes shall be filled with space characters (i.e., 20h).

The VENDOR IDENTIFICATION field contains eight bytes of ASCII data identifying the vendor of the subsystem (e.g., the board or enclosure) containing the component. The data shall be left-aligned within the field. The vendor identification string shall be one assigned by INCITS for use in the standard INQUIRY data VENDOR IDENTIFICATION field. A list of assigned vendor identification strings is in SPC-4 and on the T10 web site (<http://www.t10.org>).

The PRODUCT IDENTIFICATION field contains 16 bytes of ASCII data identifying the type of the subsystem (e.g., the board or enclosure model number) containing the component, as defined by the vendor of the subsystem. The data shall be left-aligned within the field. The PRODUCT IDENTIFICATION field should be changed whenever the subsystem design changes in a way noticeable to a user (e.g., a different stock-keeping unit (SKU)).

The PRODUCT REVISION LEVEL field contains four bytes of ASCII data identifying the revision level of the subsystem (e.g., the board or enclosure) containing the component, as defined by the vendor of the subsystem. The data shall be left-aligned within the field. The PRODUCT REVISION LEVEL field should be changed whenever the subsystem design changes (e.g., any component change, even including resistor values).

All components on a subsystem should have the same values for their VENDOR IDENTIFICATION fields, PRODUCT IDENTIFICATION fields, and PRODUCT REVISION LEVEL fields.

NOTE 109 - Application clients may use the VENDOR IDENTIFICATION field and PRODUCT IDENTIFICATION field to identify the subsystem (e.g., for a user interface). Application clients may use the VENDOR IDENTIFICATION field, PRODUCT IDENTIFICATION field, PRODUCT REVISION LEVEL field to perform workarounds for problems in a specific revision of a subsystem.

The COMPONENT VENDOR IDENTIFICATION field contains eight bytes of ASCII data identifying the vendor of the component (e.g., the expander device) containing the management device server. The data shall be left-aligned within the field. The component vendor identification string shall be one assigned by INCITS for use in the standard INQUIRY data VENDOR IDENTIFICATION field. A list of assigned vendor identification strings is in SPC-4 and on the T10 web site (<http://www.t10.org>).

The COMPONENT ID field contains a 16-bit identifier identifying the type of the component (e.g., the expander device model number) containing the management device server, as defined by the vendor of the component. The COMPONENT ID field should be changed whenever the component's programming interface (e.g., the management device server definition) changes.

The COMPONENT REVISION LEVEL field contains an 8-bit identifier identifying the revision level of the component (e.g., the expander device) containing the management device server, as defined by the vendor of the component. The COMPONENT REVISION LEVEL field should be changed whenever the component changes but its programming interface does not change.

NOTE 110 - Application clients may use the COMPONENT VENDOR IDENTIFICATION field and the COMPONENT ID field to interpret vendor-specific information (e.g., vendor-specific SMP functions) correctly for that component. Application clients may use the COMPONENT VENDOR IDENTIFICATION field, the

s/b
server as

Author: wdc-mevans
Subject: Highlight
Date: 5/26/2008 12:23:30 PM
TREJECT

server, as
s/b
server as

COMPONENT ID field, and the COMPONENT REVISION LEVEL field to perform workarounds for problems in a specific revision of a component.

The vendor-specific bytes are defined by the vendor of the subsystem (e.g., the board or enclosure) containing the component.

The CRC field is defined in 10.4.3.3.8.

10.4.3.6 REPORT SELF-CONFIGURATION STATUS function

10.4.3.6.1 REPORT SELF-CONFIGURATION STATUS function overview

The REPORT SELF-CONFIGURATION STATUS function returns self-configuration expander device status. This SMP function shall be implemented by the management device server in self-configuring expander devices and shall not be implemented by any other management device servers.

10.4.3.6.2 REPORT SELF-CONFIGURATION STATUS request

Table 252 defines the request format.

Table 252 — REPORT SELF-CONFIGURATION STATUS request

Byte\Bit	7	6	5	4	3	2	1	0	
0	SMP FRAME TYPE (40h)								
1	FUNCTION (03h)								
2	ALLOCATED RESPONSE LENGTH								
3	REQUEST LENGTH (01h)								
4	Reserved								
5									
6	(MSB)	STARTING SELF-CONFIGURATION STATUS DESCRIPTOR INDEX							
7								(LSB)	
8	(MSB)	CRC							
11								(LSB)	

The SMP FRAME TYPE field is defined in 10.4.3.2.2 and shall be set to the value defined in table 252.

The FUNCTION field is defined in 10.4.3.2.3 and shall be set to the value defined in table 252.

The ALLOCATED RESPONSE LENGTH field is defined in 10.4.3.2.4.

The REQUEST LENGTH field is defined in 10.4.3.2.5 and shall be set to the value defined in table 252.

The STARTING SELF-CONFIGURATION STATUS DESCRIPTOR INDEX field specifies the first self-configuration status descriptor that the management device server shall return in the SMP response frame. If the specified index does not contain a valid self-configuration status descriptor, then the STARTING SELF-CONFIGURATION STATUS DESCRIPTOR INDEX field in the response may differ from the specified index.

The CRC field is defined in 10.4.3.2.8.

Author: Isi-bbesmer

Subject: Note

Date: 5/30/2008 3:45:32 PM

 ACCEPT - DONE (added "A starting self-configuration status descriptor index field specifies that the device server shall return no self-configuration status descriptors.")

The response for this request indicates that a value of zero has special meaning that is not described here.

10.4.3.6.3 REPORT SELF-CONFIGURATION STATUS response

Table 253 defines the response format.

Table 253 — REPORT SELF-CONFIGURATION STATUS response

Byte\Bit	7	6	5	4	3	2	1	0
0	SMP FRAME TYPE (41h)							
1	FUNCTION (03h)							
2	FUNCTION RESULT							
3	RESPONSE LENGTH $((n - 7) / 4)$							
4	(MSB)	EXPANDER CHANGE COUNT						(LSB)
5								
6	(MSB)	STARTING SELF-CONFIGURATION STATUS DESCRIPTOR INDEX						(LSB)
7								
8	(MSB)	TOTAL NUMBER OF SELF-CONFIGURATION STATUS DESCRIPTORS						(LSB)
9								
10	(MSB)	LAST SELF-CONFIGURATION STATUS DESCRIPTOR INDEX						(LSB)
11								
12	SELF-CONFIGURATION STATUS DESCRIPTOR LENGTH							
13								
18	Reserved							
19	NUMBER OF SELF-CONFIGURATION STATUS DESCRIPTORS							
Self-configuration status descriptor list								
20	Self-configuration status descriptor (first)(see table 254 in 10.4.3.6.4)							
...	...							
n - 4	Self-configuration status descriptor (last)(see table 254 in 10.4.3.6.4)							
n - 3	(MSB)	CRC						(LSB)
n								

The SMP FRAME TYPE field is defined in 10.4.3.3.2 and shall be set to the value defined in table 253.

The FUNCTION field is defined in 10.4.3.3.3 and shall be set to the value defined in table 253.

The FUNCTION RESULT field is defined in 10.4.3.3.4.

This page contains no comments

The RESPONSE LENGTH field is defined in 10.4.3.3.5 and shall be set to the value defined in table 253. A RESPONSE LENGTH field set to 00h does not have a special meaning based on the ALLOCATED RESPONSE LENGTH field in the request frame.

The EXPANDER CHANGE COUNT field is defined in the SMP REPORT GENERAL response (see 10.4.3.4). If the SMP initiator port detects a change in the value of this field while retrieving multiple response frames, it should start again because the status information returned is incomplete and inconsistent.

The STARTING SELF-CONFIGURATION STATUS DESCRIPTOR INDEX field indicates the index of the first self-configuration status descriptor being returned. If the STARTING SELF-CONFIGURATION STATUS DESCRIPTOR INDEX field in the SMP request is set to 0000h, then the management device server shall set the STARTING SELF-CONFIGURATION STATUS DESCRIPTOR INDEX field to 0000h, set the TOTAL NUMBER OF SELF-CONFIGURATION STATUS DESCRIPTORS field to 0000h, and return no descriptors. If the STARTING SELF-CONFIGURATION STATUS DESCRIPTOR INDEX field in the SMP request does not contain a valid descriptor, then the management device server shall set the STARTING SELF-CONFIGURATION STATUS DESCRIPTOR INDEX field to the next index, in ascending order wrapping from FFFFh to 0001h, that contains a valid descriptor. Otherwise, this field shall be set to the same value as the STARTING SELF-CONFIGURATION STATUS DESCRIPTOR INDEX field in the SMP request.

The SELF-CONFIGURATION DESCRIPTOR LENGTH field indicates the length, in devices, of the REPORT SELF-CONFIGURATION STATUS descriptor (see table 254 in 10.4.3.6.4).

The TOTAL NUMBER OF SELF-CONFIGURATION STATUS DESCRIPTORS field indicates how many self-configuration status descriptors are available at this time from the management device server.

The LAST SELF-CONFIGURATION STATUS DESCRIPTOR INDEX field indicates the index of the last recorded self-configuration status descriptor.

The NUMBER OF SELF-CONFIGURATION STATUS DESCRIPTORS field indicates how many self-configuration status descriptors follow in this SMP response frame.

The self-configuration status descriptor list contains self-configuration status descriptors. The management device server shall return either all the self-configuration status descriptors that fit in one SMP response frame or all the self-configuration status descriptors until the index indicated in the LAST SELF-CONFIGURATION STATUS DESCRIPTOR INDEX field is reached. The self-configuration status descriptor list shall start with the self-configuration status descriptor specified by the STARTING SELF-CONFIGURATION STATUS DESCRIPTOR INDEX field in ascending order, wrapping from FFFFh to 0001h, based on the self-configuration status descriptor index. The self-configuration status descriptor list shall not contain any truncated self-configuration status descriptors. If the STARTING SELF-CONFIGURATION STATUS DESCRIPTOR INDEX field is equal to the LAST SELF-CONFIGURATION STATUS DESCRIPTOR INDEX field, then the self-configuration status descriptor at that index shall be returned.

The CRC field is defined in 10.4.3.3.8.

Page: 579

● Author: lsi-gpenokie
Subject: Highlight
Date: 5/8/2008 8:31:28 PM
T REJECT

Global (there are 16 other instances of this same statement that should also be changed)
This << A RESPONSE LENGTH field set to 00h does not have a special meaning based on the ALLOCATED RESPONSE LENGTH field in the request frame. >> should be made into a note as the information is not normative.

● Author: RElliott
Subject: Highlight
Date: 6/30/2008 6:16:52 PM
T ACCEPT - DONE

SMP initiator port
s/b
management application client

● Author: wdc-mevans
Subject: Highlight
Date: 6/2/2008 9:45:29 AM
T ACCEPT - DONE (with "response frames")

it should start again
s/b
then the SMP initiator port should retrieve the frame again

● Author: lsi-bbesmer
Subject: Highlight
Date: 6/2/2008 9:46:10 AM
T REJECT (but changed to "is possibly". We're not trying to grant permission here, which "may" is supposed to mean.)

is
s/b
may be

● Author: lsi-gpenokie
Subject: Highlight
Date: 5/26/2008 12:24:41 PM
T REJECT (nothing wrong with "because")

This << start again because the status information >> should be << start again as the status information >>

● Author: lsi-gpenokie
Subject: Highlight
Date: 5/29/2008 3:01:51 PM
T ACCEPT - DONE

This << If the STARTING SELF-CONFIGURATION STATUS DESCRIPTOR INDEX field in the SMP request is set to 0000h, then the management device server shall set the STARTING SELF-CONFIGURATION STATUS DESCRIPTOR INDEX field to 0000h, set the TOTAL NUMBER OF SELF-CONFIGURATION STATUS DESCRIPTORS field to 0000h, and return no descriptors. >> would be easier to understand if it was made into an a,b,c list.

● Author: RElliott
Subject: Underline
Date: 6/30/2008 6:16:52 PM
T ACCEPT - DONE

contain
s/b
specify

Comments from page 579 continued on next page

The RESPONSE LENGTH field is defined in 10.4.3.3.5 and shall be set to the value defined in table 253. A RESPONSE LENGTH field set to 00h does not have a special meaning based on the ALLOCATED RESPONSE LENGTH field in the request frame.

The EXPANDER CHANGE COUNT field is defined in the SMP REPORT GENERAL response (see 10.4.3.4). If the SMP initiator port detects a change in the value of this field while retrieving multiple response frames, it should start again because the status information returned is incomplete and inconsistent.

The STARTING SELF-CONFIGURATION STATUS DESCRIPTOR INDEX field indicates the index of the first self-configuration status descriptor being returned. If the STARTING SELF-CONFIGURATION STATUS DESCRIPTOR INDEX field in the SMP request is set to 0000h, then the management device server shall set the STARTING SELF-CONFIGURATION STATUS DESCRIPTOR INDEX field to 0000h, set the TOTAL NUMBER OF SELF-CONFIGURATION STATUS DESCRIPTORS field to 0000h, and return no descriptors. If the STARTING SELF-CONFIGURATION STATUS DESCRIPTOR INDEX field in the SMP request does not contain a valid descriptor, then the management device server shall set the STARTING SELF-CONFIGURATION STATUS DESCRIPTOR INDEX field to the next index, in ascending order wrapping from FFFFh to 0001h, that contains a valid descriptor. Otherwise, this field shall be set to the same value as the STARTING SELF-CONFIGURATION STATUS DESCRIPTOR INDEX field in the SMP request.

The SELF-CONFIGURATION DESCRIPTOR LENGTH field indicates the length, in devices, of the REPORT SELF-CONFIGURATION STATUS descriptor (see table 254 in 10.4.3.6.4).

The TOTAL NUMBER OF SELF-CONFIGURATION STATUS DESCRIPTORS field indicates how many self-configuration status descriptors are available at this time from the management device server.

The LAST SELF-CONFIGURATION STATUS DESCRIPTOR INDEX field indicates the index of the last recorded self-configuration status descriptor.

The NUMBER OF SELF-CONFIGURATION STATUS DESCRIPTORS field indicates how many self-configuration status descriptors follow in this SMP response frame.

The self-configuration status descriptor list contains self-configuration status descriptors. The management device server shall return either all the self-configuration status descriptors that fit in one SMP response frame or all the self-configuration status descriptors until the index indicated in the LAST SELF-CONFIGURATION STATUS DESCRIPTOR INDEX field is reached. The self-configuration status descriptor list shall start with the self-configuration status descriptor specified by the STARTING SELF-CONFIGURATION STATUS DESCRIPTOR INDEX field in ascending order, wrapping from FFFFh to 0001h, based on the self-configuration status descriptor index. The self-configuration status descriptor list shall not contain any truncated self-configuration status descriptors. If the STARTING SELF-CONFIGURATION STATUS DESCRIPTOR INDEX field is equal to the LAST SELF-CONFIGURATION STATUS DESCRIPTOR INDEX field, then the self-configuration status descriptor at that index shall be returned.

The CRC field is defined in 10.4.3.3.8.

Author: Isi-gpenokie
Subject: Highlight
Date: 5/29/2008 3:03:23 PM

T REJECT (the index is what is in ascending order. That rewording makes it less clear, and you might think the descriptor is ascending order (but that doesn't compute))

This << field to the next index, in ascending order wrapping from FFFFh to 0001h, that contains a valid descriptor. >> should be << field to the next index that contains a valid descriptor in ascending order wrapping from FFFFh to 0001h. >>

Author: wdc-mevans
Subject: Highlight
Date: 5/29/2008 3:03:39 PM

T REJECT (see Isi-gpenokie reply)

index, in ascending order wrapping from FFFFh to 0001h, that contains a valid descriptor.

s/b

index that contains a valid descriptor in ascending order wrapping from FFFFh to 0001h.

Author: RElliott
Subject: Underline
Date: 6/30/2008 6:16:52 PM

T ACCEPT - DONE

Otherwise

s/b

If the starting self-configuration status descriptor index field is not set to 0000h and specifies a valid descriptor

Author: RElliott
Subject: Highlight
Date: 6/30/2008 6:16:52 PM

T ACCEPT - DONE

SELF-CONFIGURATION DESCRIPTOR LENGTH

s/b

SELF-CONFIGURATION STATUS DESCRIPTOR LENGTH

to match table

Author: RElliott
Subject: Highlight
Date: 6/30/2008 6:16:52 PM

T ACCEPT - DONE

REPORT SELF-CONFIGURATION STATUS descriptor

s/b

self-configuration status descriptor

Author: Isi-bbesmer
Subject: Note
Date: 6/11/2008 11:12:14 AM

T REJECT (6/11 per brad)

Should this indicate that this value shall be 4 for expanders compliant w/this standard?

Author: RElliott
Subject: Underline
Date: 6/30/2008 6:16:52 PM

T ACCEPT - DONE

how many self-configuration status

descriptors follow in this SMP response frame

s/b

the number of self-configuration status descriptors in the self-configuration status descriptor list

Comments from page 579 continued on next page

The RESPONSE LENGTH field is defined in 10.4.3.3.5 and shall be set to the value defined in table 253. A RESPONSE LENGTH field set to 00h does not have a special meaning based on the ALLOCATED RESPONSE LENGTH field in the request frame.

The EXPANDER CHANGE COUNT field is defined in the SMP REPORT GENERAL response (see 10.4.3.4). If the SMP initiator port detects a change in the value of this field while retrieving multiple response frames, it should start again because the status information returned is incomplete and inconsistent.

The STARTING SELF-CONFIGURATION STATUS DESCRIPTOR INDEX field indicates the index of the first self-configuration status descriptor being returned. If the STARTING SELF-CONFIGURATION STATUS DESCRIPTOR INDEX field in the SMP request is set to 0000h, then the management device server shall set the STARTING SELF-CONFIGURATION STATUS DESCRIPTOR INDEX field to 0000h, set the TOTAL NUMBER OF SELF-CONFIGURATION STATUS DESCRIPTORS field to 0000h, and return no descriptors. If the STARTING SELF-CONFIGURATION STATUS DESCRIPTOR INDEX field in the SMP request does not contain a valid descriptor, then the management device server shall set the STARTING SELF-CONFIGURATION STATUS DESCRIPTOR INDEX field to the next index, in ascending order wrapping from FFFFh to 0001h, that contains a valid descriptor. Otherwise, this field shall be set to the same value as the STARTING SELF-CONFIGURATION STATUS DESCRIPTOR INDEX field in the SMP request.

The SELF-CONFIGURATION DESCRIPTOR LENGTH field indicates the length, in descriptors, of the REPORT SELF-CONFIGURATION STATUS descriptor (see table 254 in 10.4.3.6.4).

The TOTAL NUMBER OF SELF-CONFIGURATION STATUS DESCRIPTORS field indicates how many self-configuration status descriptors are available at this time from the management device server.

The LAST SELF-CONFIGURATION STATUS DESCRIPTOR INDEX field indicates the index of the last recorded self-configuration status descriptor.

The NUMBER OF SELF-CONFIGURATION STATUS DESCRIPTORS field indicates how many self-configuration status descriptors follow in this SMP response frame.

The self-configuration status descriptor list contains self-configuration status descriptors. The management device server shall return either all the self-configuration status descriptors that fit in one SMP response frame or all the self-configuration status descriptors until the index indicated in the LAST SELF-CONFIGURATION STATUS DESCRIPTOR INDEX field is reached. The self-configuration status descriptor list shall start with the self-configuration status descriptor specified by the STARTING SELF-CONFIGURATION STATUS DESCRIPTOR INDEX field in ascending order, wrapping from FFFFh to 0001h, based on the self-configuration status descriptor index. The self-configuration status descriptor list shall not contain any truncated self-configuration status descriptors. If the STARTING SELF-CONFIGURATION STATUS DESCRIPTOR INDEX field is equal to the LAST SELF-CONFIGURATION STATUS DESCRIPTOR INDEX field, then the self-configuration status descriptor at that index shall be returned.

The CRC field is defined in 10.4.3.3.8.

Author: RElliott
Subject: Underline
Date: 6/30/2008 6:16:52 PM
T ACCEPT - DONE

Fix this incomplete sentence:

The self-configuration status descriptor list shall start with the self-configuration status descriptor specified by the STARTING SELF-CONFIGURATION STATUS DESCRIPTOR INDEX field in ascending order, wrapping from FFFFh to 0001h, based on the self-configuration status descriptor index.

s/b

The self-configuration status descriptor list shall start with the self-configuration status descriptor specified by the starting self-configuration status descriptor index field, and shall continue with self-configuration status descriptor sorted in ascending order, wrapping from FFFFh to 0001h, based on the self-configuration status descriptor index

Author: lsi-gpenokie
Subject: Highlight
Date: 5/30/2008 4:02:24 PM
T REJECT (other problems in this sentence)

This << field in ascending order, wrapping from FFFFh to 0001h, based on the self-configuration status descriptor index. >> should be << field in ascending order based on the self-configuration status descriptor index wrapping from FFFFh to 0001h. >

Author: wdc-mevans
Subject: Highlight
Date: 5/30/2008 4:02:20 PM
T REJECT (other problems in this sentence)

order, wrapping from FFFFh to 0001h, based on the self-configuration status descriptor index.

s/b

order based on the self-configuration status descriptor index wrapping from FFFFh to 0001h.

10.4.3.6.4 Self-configuration status descriptor

Each self-configuration status descriptor follows the format defined in table 254.

Table 254 — Self-configuration status descriptor

Byte/Bit	7	6	5	4	3	2	1	0	
0	STATUS TYPE								
1	Reserved							FINAL	
2	Reserved								
3	PHY IDENTIFIER								
4	Reserved								
7	Reserved								
8	(MSB)	SAS ADDRESS							
15								(LSB)	

The STATUS TYPE field indicates the type of status being reported and is defined in table 255.

Table 255 — STATUS TYPE field (part 1 of 2)

Code	Description
00h	Reserved
01h	Error not related to a specific layer
02h	The expander device currently has a connection or is currently attempting to establish a connection with the SMP target port with the indicated SAS address.
03h	Expander route table is full. The expander device was not able to add the indicated SAS address to the expander route table.
04h	Expander device is out of resources (e.g., it discovered too many SAS addresses while performing the discover process through a subtractive port). This does not affect the expander route table.
05h - 1Fh	Reserved for status not related to specific layers
Status reported by the phy layer	
20h	Error reported by the phy layer
21h	All phys in the expander port containing the indicated phy lost dword synchronization
22h - 3Fh	Reserved for status reported by the phy layer
Status reported by the link layer	
40h	Error reported by the link layer
41h	Connection request failed: Open Timeout timer expired
42h	Connection request failed: Received an abandon-class OPEN_REJECT (e.g., BAD DESTINATION, PROTOCOL NOT SUPPORTED, ZONE VIOLATION, STP RESOURCES BUSY, WRONG DESTINATION)
43h	Connection request failed: Received a vendor-specific number of retry-class OPEN_REJECTs (e.g. RETRY, PATHWAY BLOCKED)

This page contains no comments

Table 255 — STATUS TYPE field (part 2 of 2)

Code	Description
44h	Connection request failed: I_T nexus loss occurred (e.g., OPEN_REJECT (NO DESTINATION)) for longer than the time specified by the STP SMP I_T NEXUS LOSS TIME field in the CONFIGURE GENERAL function
45h	Connection request failed: Received BREAK
46h	Connection established: SMP response frame had a CRC error
47h - 5Fh	Reserved for status reported by the link layer
Status reported by the port layer	
60h	Error reported by the port layer
61h	During an SMP connection, there was no SMP response frame within the maximum SMP connection time
62h - 7Fh	Reserved for status reported by the port layer
Status reported by the transport layer	
80h	Error reported by the transport layer
81h - 9Fh	Reserved for status reported by the transport layer
Status reported by the application layer	
A0h	Error reported by the application layer
A1h	SMP response frame is too short
A2h	SMP response frame contains field(s) with unsupported values
A3h	SMP response frame contains results inconsistent with other SMP response frames (e.g., the DISCOVER response ATTACHED SAS ADDRESS field does not contain the SAS address the expander device expected)
A4h	The SAS ADDRESS field contains the SAS address of a self-configuring expander device that returned a REPORT GENERAL response with the CONFIGURING bit set to one. Accesses to SAS addresses two levels beyond this expander device may not succeed until the indicated expander device completes configuration. This is not necessarily an error.
A5h - BFh	Reserved for status reported by the application layer
Other status	
C0h - DFh	Reserved
E0h - FFh	Vendor-specific

A FINAL bit set to one indicates that the expander device is no longer attempting to establish connections to the SMP target port with the indicated SAS address as part of the discover process because of the error indicated by the descriptor. A FINAL bit set to zero indicates that the expander device is still attempting to access the SMP target port with the indicated SAS address as part of the discover process.

The PHY IDENTIFIER field indicates the phy (see 4.2.7) that was used to request a connection with the SMP target port with the indicated SAS address.

The SAS ADDRESS field indicates the SAS address of the SMP target port to which the expander device established a connection or attempted to establish a connection.

● Author: RElliott
Subject: Highlight
Date: 6/30/2008 6:16:52 PM
T ACCEPT - DONE

transport
s/b
SMP transport layer
to parallel ghoulder comment on application layer below

● Author: RElliott
Subject: Highlight
Date: 6/30/2008 6:16:52 PM
T ACCEPT - DONE

transport
s/b
SMP transport layer
to parallel ghoulder comment on application layer below

● Author: RElliott
Subject: Highlight
Date: 6/30/2008 6:16:52 PM
T ACCEPT - DONE

transport
s/b
SMP transport layer
to parallel ghoulder comment on application layer below

● Author: stx-ghoulder
Subject: Highlight
Date: 5/6/2008 4:07:50 PM
T REJECT (no, there's just one application layer)

application layer
Shouldn't this be layers (plural)?

● Author: RElliott
Subject: Highlight
Date: 6/30/2008 6:16:52 PM
T ACCEPT - DONE

application
s/b
management application layer

to match other comments

● Author: RElliott
Subject: Highlight
Date: 6/30/2008 6:16:52 PM
T ACCEPT - DONE

two levels
s/b
two or more levels
to match lsi-bbesmer comment in 4.8.1

Table 255 — STATUS TYPE field (part 2 of 2)

Code	Description
44h	Connection request failed: I_T nexus loss occurred (e.g., OPEN_REJECT (NO DESTINATION) for longer than the time specified by the STP SMP I_T NEXUS LOSS TIME field in the CONFIGURE GENERAL function
45h	Connection request failed: Received BREAK
46h	Connection established: SMP response frame had a CRC error
47h - 5Fh	Reserved for status reported by the link layer
Status reported by the port layer	
60h	Error reported by the port layer
61h	During an SMP connection, there was no SMP response frame within the maximum SMP connection time
62h - 7Fh	Reserved for status reported by the port layer
Status reported by the transport layer	
80h	Error reported by the transport layer
81h - 9Fh	Reserved for status reported by the transport layer
Status reported by the application layer	
A0h	Error reported by the application layer
A1h	SMP response frame is too short
A2h	SMP response frame contains field(s) with unsupported values
A3h	SMP response frame contains results inconsistent with other SMP response frames (e.g., the DISCOVER response ATTACHED SAS ADDRESS field does not contain the SAS address the expander device expected)
A4h	The SAS ADDRESS field contains the SAS address of a self-configuring expander device that returned a REPORT GENERAL response with the CONFIGURING bit set to one. Accesses to SAS addresses two levels beyond this expander device may not succeed until the indicated expander device completes configuration. This is not necessarily an error.
A5h - BFh	Reserved for status reported by the application layer
Other status	
C0h - DFh	Reserved
E0h - FFh	Vendor-specific



A FINAL bit set to one indicates that the expander device is no longer attempting to establish connections to the SMP target port with the indicated SAS address as part of the discover process because of the error indicated by the descriptor. A FINAL bit set to zero indicates that the expander device is still attempting to access the SMP target port with the indicated SAS address as part of the discover process.

The PHY IDENTIFIER field indicates the phy (see 4.2.7) that was used to request a connection with the SMP target port with the indicated SAS address.

The SAS ADDRESS field indicates the SAS address of the SMP target port to which the expander device established a connection or attempted to establish a connection.

Author: RElliott
Subject: Note
Date: 6/30/2008 6:16:52 PM

 ACCEPT - DONE

Change A4h to:

with the configuring bit set to one, the self configuring bit set to zero, and the zone configuring bit set to zero.

Add A5h with:

with the self configuring bit set to one.

Add A6h: with

with the zone configuring bit set to one.

to match Isi-bbesmer comment on first page

Author: stx-goulder
Subject: Highlight
Date: 5/6/2008 4:07:50 PM

 REJECT

application layer

Should be layers (plural).

Author: Isi-gpenokie
Subject: Highlight
Date: 5/6/2008 4:07:50 PM

 REJECT

This << discover process because of the error indicated >> should be << discover process as a result of the error indicated >>

Author: elx-bmartin
Subject: Comment on Text
Date: 5/6/2008 4:07:50 PM

 ACCEPT - DONE (also, globally fixed all references to phy identifier fields to use the same wording: "indicates the phy identifier (see 4.2.8) of the phy ...")

This reference should be 4.2.8

Author: RElliott
Subject: Highlight
Date: 6/30/2008 6:16:52 PM

 ACCEPT - DONE

SAS address

add "(see 4.2.4)" to support the new section

10.4.3.7 REPORT ZONE PERMISSION TABLE function

10.4.3.7.1 REPORT ZONE PERMISSION TABLE function overview

The REPORT ZONE PERMISSION function returns a set of zone permission table entries. This function shall be supported by all zoning expander devices.

10.4.3.7.2 REPORT ZONE PERMISSION TABLE request

Table 256 defines the request format.

Table 256 — REPORT ZONE PERMISSION TABLE request

Byte/Bit	7	6	5	4	3	2	1	0	
0	SMP FRAME TYPE (40h)								
1	FUNCTION (04h)								
2	ALLOCATED RESPONSE LENGTH								
3	REQUEST LENGTH (01h)								
4	Reserved						REPORT TYPE		
5	Reserved								
6	STARTING SOURCE ZONE GROUP								
7	MAXIMUM NUMBER OF ZONE PERMISSION DESCRIPTORS								
8	(MSB)	CRC						(LSB)	
11									

The SMP FRAME TYPE field is defined in 10.4.3.2.2 and shall be set to the value defined in table 256.

The FUNCTION field is defined in 10.4.3.2.3 and shall be set to the value defined in table 256.

The ALLOCATED RESPONSE LENGTH field is defined in 10.4.3.2.4.

The REQUEST LENGTH field is defined in 10.4.3.2.5 and shall be set to the value defined in table 256.

The REPORT TYPE field specifies the values that the management device server shall return and is defined in table 257.

Table 257 — REPORT TYPE field

Code	Description
00b	Current
01b	Shadow
10b	Saved
11b	Default

The STARTING SOURCE ZONE GROUP field specifies the first source zone group, (i.e., s) returned. If the value in this field exceeds the end of the zone permission table then the management device server shall return a function result of SOURCE ZONE GROUP DOES NOT EXIST in the response frame (see table 245 in 10.4.3.3).

● Author: RElliott
Subject: Note
Date: 9/2/2008 7:20:47 PM
 ACCEPT - DONE (

Could also just define that zeros are returned, and the application is expected to know the value of the SAVING ZONE PERMISSION TABLE SUPPORTED bit and the SAVING ZONE MANAGER PASSWORD SUPPORTD bit in the REPORT GENERAL response. But, an error is just as easy and might better avoid misinterpretation.

All the other REPORT TYPE values are mandatory, so SAVED is the only one that needs a special error.)

(from Bill Martin, Emulex)

Section 10.4.3.7 REPORT ZONE PERMISSION TABLE defines REPORT TYPE, which includes saved. If the report type is set to SAVED, and saving is not supported. I believe the command should return SAVING NOT SUPPORTED (as indicated in Table 245, page 562 for various zone configuration commands).

10.4.3.7 should indicate this response and this should be added to table 245 as an additional condition for reporting SAVING NOT SUPPORTED" and SAVING NOT SUPPORTED should be added to the priority list of responses for REPORT ZONE PERMISSION TABLE in Table 246.

● Author: RElliott
Subject: Highlight
Date: 6/30/2008 6:16:52 PM
 ACCEPT - DONE

then
s/b
, then

The MAXIMUM NUMBER OF ZONE PERMISSION DESCRIPTORS field specifies the maximum number of complete zone permission descriptors that the management device server shall return.

The CRC field is defined in 10.4.3.2.8.

10.4.3.7.3 REPORT ZONE PERMISSION TABLE response

Table 258 defines the response format.

Table 258 — REPORT ZONE PERMISSION TABLE response

Byte\Bit	7	6	5	4	3	2	1	0
0	SMP FRAME TYPE (41h)							
1	FUNCTION (04h)							
2	FUNCTION RESULT							
3	RESPONSE LENGTH $((n - 7) / 4)$							
4	(MSB)	EXPANDER CHANGE COUNT						(LSB)
5								
6	ZONE LOCKED	Reserved					REPORT TYPE	
7	NUMBER OF ZONE GROUPS			Reserved				
8	Reserved							
13	Reserved							
14	STARTING SOURCE ZONE GROUP							
15	NUMBER OF ZONE PERMISSION DESCRIPTORS							
Zone permission descriptor list								
16	Zone permission descriptor (first) (see table 259 in 10.4.3.7.4)							
31								
...	...							
n - 20	Zone permission descriptor (last) (see table 259 in 10.4.3.7.4)							
n - 4								
n - 3	(MSB)	CRC						(LSB)
n								

The SMP FRAME TYPE field is defined in 10.4.3.3.2 and shall be set to the value defined in table 258.

The FUNCTION field is defined in 10.4.3.3.3 and shall be set to the value defined in table 258.

The FUNCTION RESULT field is defined in 10.4.3.3.4.

The RESPONSE LENGTH field is defined in 10.4.3.3.5 and shall be set to one of the values defined in table 258 based on the ALLOCATED RESPONSE LENGTH field in the request frame.

● Author: RElliott
Subject: Note
Date: 6/30/2008 6:16:52 PM
 ACCEPT - DONE

Per 6/11 LB call, make byte 13 into a Zone Permission Descriptor Length field.

This is implied by the NUMBER OF ZONE GROUPS field, but there is no certain way to understand what Reserved values in that field mean if it is ever changed. Two fields will let the descriptor grow to include other fields after the of zone permission bits.

● Author: RElliott
Subject: Highlight
Date: 6/30/2008 6:16:52 PM
 ACCEPT - DONE

see table 259

add "or table 260"

● Author: RElliott
Subject: Highlight
Date: 6/30/2008 6:16:52 PM
 ACCEPT - DONE

31

s/b

31 or 47

● Author: RElliott
Subject: Highlight
Date: 6/30/2008 6:16:52 PM
 ACCEPT - DONE

n - 20

s/b

(n - 20) or

(n - 36)

● Author: RElliott
Subject: Highlight
Date: 6/30/2008 6:16:52 PM
 ACCEPT - DONE

see table 259

add "or table 260"

The EXPANDER CHANGE COUNT field is defined in the SMP REPORT GENERAL response (see 10.4.3.4). If the SMP initiator port detects a change in the value of this field while retrieving multiple response frames, it should start again because the status information returned is incomplete and inconsistent.

The ZONE LOCKED bit is defined in the SMP REPORT GENERAL response.

The REPORT TYPE field indicates the value of the REPORT TYPE field in the request frame.

The NUMBER OF ZONE GROUPS field indicates the number of elements in the zone permission descriptor list and is defined in the REPORT GENERAL response (see table 249 in 10.4.3.4).

The STARTING SOURCE ZONE GROUP field indicates the first source zone group (i.e., s) being returned, and is set to the same value as the STARTING SOURCE ZONE GROUP field in the SMP request frame.

The NUMBER OF ZONE PERMISSION DESCRIPTORS field indicates how many zone permission descriptors follow in this SMP response frame.

The zone permission descriptor list contains a zone permission descriptor as defined in 10.4.3.7.4 for each source zone group in ascending order starting with the source zone group specified in the STARTING SOURCE ZONE GROUP field in the request.

The CRC field is defined in 10.4.3.3.8.

10.4.3.7.4 Zone permission descriptor

Table 259 defines the zone permission descriptor containing 128 entries.

Table 259 — Zone permission descriptor for a source zone group (i.e., s) with 128 zone groups

Byte\Bit	7	6	5	4	3	2	1	0
0	ZP[s, 127]	ZP[s, 126]	ZP[s, 125]	ZP[s, 124]	ZP[s, 123]	ZP[s, 122]	ZP[s, 121]	ZP[s, 120]
...	...							
15	ZP[s, 7] (0b)	ZP[s, 6] (0b)	ZP[s, 5] (0b)	ZP[s, 4] (0b)	ZP[s, 3] (0b)	ZP[s, 2] (0b)	ZP[s, 1] (1b)	ZP[s, 0] (0b)

Table 260 defines the zone permission descriptor containing 256 entries.

Table 260 — Zone permission descriptor for a source zone group (i.e., s) with 256 zone groups

Byte\Bit	7	6	5	4	3	2	1	0
0	ZP[s, 255]	ZP[s, 254]	ZP[s, 253]	ZP[s, 252]	ZP[s, 251]	ZP[s, 250]	ZP[s, 249]	ZP[s, 248]
...	...							
31	ZP[s, 7] (0b)	ZP[s, 6] (0b)	ZP[s, 5] (0b)	ZP[s, 4] (0b)	ZP[s, 3] (0b)	ZP[s, 2] (0b)	ZP[s, 1] (1b)	ZP[s, 0] (0b)

The zone permission descriptor contains all of the zone permission table entries for the source zone group (i.e., s).

Page: 584

● Author: wdc-mevans

Subject: Highlight

Date: 5/30/2008 4:05:22 PM

 ACCEPT - DONE (but kept the "it" based on first noun/subject convention, and used "response frames" rather than "frames")

it should start

s/b

then the SMP initiator port should retrieve the frames

● Author: RElliott

Subject: Highlight

Date: 6/30/2008 6:16:52 PM

 ACCEPT - DONE

elements in the zone permission descriptor

s/b

zone groups supported by the expander device

● Author: wdc-mevans

Subject: Highlight

Date: 5/26/2008 12:25:50 PM

 REJECT

returned, and

s/b

returned and

● Author: lsi-gpenokie

Subject: Highlight

Date: 5/29/2008 4:17:25 PM

 ACCEPT - DONE

This << and is set to the same value as the >> looks like a requirement that should be stated as << and shall be set to the same value as the >>

● Author: RElliott

Subject: Underline

Date: 6/30/2008 6:16:52 PM

 ACCEPT - DONE

how many zone permission descriptors follow in

this SMP response frame

s/b

the number of zone permission descriptors in the zone permission descriptor list

● Author: RElliott

Subject: Note

Date: 6/30/2008 6:16:52 PM

 ACCEPT - DONE

Add a table introducing these 2 tables and explaining how the NUMBER OF ZONE GROUPS field indicates which one is applicable

Table 261 defines how the zone permission descriptor bits shall be set by the management device server.

Table 261 — Zone permission descriptor bit requirements

Source zone group (i.e., s)	Management device server requirement(s) ^a
0	ZP[s, 0] shall be set to zero. ZP[s, 1] shall be set to one. ZP[s, 2 through (z-1)] shall be set to zero.
1	ZP[s, 0 through (z-1)] shall be set to one.
4, 5, 6 or 7	ZP[s, 0] shall be set to zero. ZP[s, 1] shall be set to one. ZP[s, 4 through (z-1)] shall be set to zero.
2, 3, or 8 through (z-1) ^a	ZP[s, 0] shall be set to zero. ZP[s, 1] shall be set to one. ZP[s, 2 through 3] shall be set to zero or one as specified by the CONFIGURE ZONE PERMISSION TABLE function (see 10.4.3.26). ZP[s, 4 through 7] shall be set to zero. ZP[s, 8 through (z-1)] shall be set to zero or one as specified by the CONFIGURE ZONE PERMISSION TABLE function.

^a The number of zone groups (i.e., z) is reported in NUMBER OF ZONE GROUPS field.

10.4.3.8 REPORT ZONE MANAGER PASSWORD function

The REPORT ZONE MANAGER PASSWORD function returns the zone manager password (see 4.9.1). This SMP function shall be implemented by all management device servers in zoning expander devices. This function shall only be processed if:

- a) the request is received from an SMP initiator port that has access to zone group 2 (see 4.9.3.2); or
- b) the request is received from any SMP initiator port while physical presence is asserted.

If physical presence is not asserted and the SMP initiator port does not have access to zone group 2, then the management device server shall return a function result of NO MANAGEMENT ACCESS RIGHTS in the response frame (see table 245 in 10.4.3.3).

Table 262 defines the request format.

Table 262 — REPORT ZONE MANAGER PASSWORD request

Byte\Bit	7	6	5	4	3	2	1	0	
0	SMP FRAME TYPE (40h)								
1	FUNCTION (05h)								
2	ALLOCATED RESPONSE LENGTH								
3	REQUEST LENGTH (00h)								
4	(MSB)	CRC							
7								(LSB)	

The SMP FRAME TYPE field is defined in 10.4.3.2.2 and shall be set to the value defined in table 262.

The FUNCTION field is defined in 10.4.3.2.3 and shall be set to the value defined in table 262.

The ALLOCATED RESPONSE LENGTH field is defined in 10.4.3.2.4.

● Author: RElliott
Subject: Note
Date: 6/30/2008 6:16:52 PM
 ACCEPT - DONE

Add "Other management device servers shall not implement this function.")

● Author: RElliott
Subject: Note
Date: 6/30/2008 6:16:52 PM
 ACCEPT - DONE

add " and shall be implemented by a management device server supporting the CONFIGURE ZONE MANAGER PASSWORD function (see 10.4.3.24)"

● Author: wdc-mevans
Subject: Highlight
Date: 8/28/2008 9:26:19 AM
 REJECT (only 2 items being ANDed)

asserted and
s/b
asserted, and

● Author: RElliott
Subject: Note
Date: 9/2/2008 7:07:10 PM

 ACCEPT - DONE (add a REPORT TYPE field to make this like the others. There are no shadow values, though.)

(from Bill Martin, Emulex)

The REPORT ZONE MANAGER PASSWORD does not specify which Zone Manager Password to report. This may be a big change at this point, but there is a current zone manager password, a shadow zone manager password, and a saved zone manager password. There should have been a REPORT TYPE field as in the REPORT ZONE PERMISSION TABLE request.

The REQUEST LENGTH field is defined in 10.4.3.2.5 and shall be set to the value defined in table 262.

The CRC field is defined in 10.4.3.2.8.

Table 263 defines the response format.

Table 263 — REPORT ZONE MANAGER PASSWORD response

Byte\Bit	7	6	5	4	3	2	1	0
0	SMP FRAME TYPE (41h)							
1	FUNCTION (04h)							
2	FUNCTION RESULT							
3	RESPONSE LENGTH (09h)							
4	(MSB)	EXPANDER CHANGE COUNT						(LSB)
5								
6	Reserved							
7								
8	ZONE MANAGER PASSWORD							
39								
40	(MSB)	CRC						(LSB)
43								

The SMP FRAME TYPE field is defined in 10.4.3.3.2 and shall be set to the value defined in table 263.

The FUNCTION field is defined in 10.4.3.3.3 and shall be set to the value defined in table 263.

The FUNCTION RESULT field is defined in 10.4.3.3.4.

The RESPONSE LENGTH field is defined in 10.4.3.3.5 and shall be set to the value defined in table 263. A RESPONSE LENGTH field set to 00h does not have a special meaning based on the ALLOCATED RESPONSE LENGTH field in the request frame.

The EXPANDER CHANGE COUNT field is defined in the SMP REPORT GENERAL response (see 10.4.3.4).

The ZONE MANAGER PASSWORD field indicates the zone manager password.

The CRC field is defined in 10.4.3.3.8.

10.4.3.9 REPORT BROADCAST function

10.4.3.9.1 REPORT BROADCAST function overview

The REPORT BROADCAST function returns information about Broadcasts (see 4.1.13) that were either originated from this expander device or SAS device, or received on a phy directly attached to an end device.

This SMP function may implemented by any management device server.

● Author: RElliott
Subject: Highlight
Date: 6/30/2008 6:16:52 PM

T ACCEPT - DONE

2. Section 10.4.3.8, for REPORT ZONE MANAGER PASSWORD function, table 264, byte 1 shows the function code as 04h instead of 05h.

(from Tim McLeod, Data Domain; T10 reflector 5/9/2008)

● Author: elx-bmartin
Subject: Highlight
Date: 5/6/2008 4:07:50 PM

T ACCEPT - DONE

may implemented

s.b.

may be implemented

10.4.3.9.2 REPORT BROADCAST request

Table 264 defines the request format.

Table 264 — REPORT BROADCAST request

Byte\Bit	7	6	5	4	3	2	1	0
0	SMP FRAME TYPE (40h)							
1	FUNCTION (06h)							
2	ALLOCATED RESPONSE LENGTH							
3	REQUEST LENGTH (01h)							
4	Reserved				BROADCAST TYPE			
5	Reserved							
7	Reserved							
8	(MSB)	CRC						(LSB)
11								

The SMP FRAME TYPE field is defined in 10.4.3.2.2 and shall be set to the value defined in table 264.

The FUNCTION field is defined in 10.4.3.2.3 and shall be set to the value defined in table 264.

The ALLOCATED RESPONSE LENGTH field is defined in 10.4.3.2.4.

The REQUEST LENGTH field is defined in 10.4.3.2.5 and shall be set to the value defined in table 264.

The BROADCAST TYPE field, defined in the ZONED BROADCAST request (see table 307 in 10.4.3.20), specifies the type of Broadcast for which counts shall be returned in the response frame.

The CRC field is defined in 10.4.3.2.8.

Author: wdc-mevans
Subject: Highlight
Date: 5/26/2008 12:26:43 PM

TREJECT

field, defined in the ZONED BROADCAST request (see table 307 in 10.4.3.20), specifies

s/b

field defined in the ZONED BROADCAST request (see table 307 in 10.4.3.20) specifies

10.4.3.9.3 REPORT BROADCAST response

Table 265 defines the response format.

Table 265 — REPORT BROADCAST response

Byte/Bit	7	6	5	4	3	2	1	0
0	SMP FRAME TYPE (41h)							
1	FUNCTION (06h)							
2	FUNCTION RESULT							
3	RESPONSE LENGTH ((n - 7) / 4)							
4	(MSB)	EXPANDER CHANGE COUNT						(LSB)
5								
6	Reserved				BROADCAST TYPE			
7	NUMBER OF BROADCAST DESCRIPTORS							
Broadcast descriptor list								
8	Broadcast descriptor (first) (see table 288 in 10.4.3.9.4)							
15								
...	...							
n - 11	Broadcast descriptor (last) (see table 288 in 10.4.3.9.4)							
n - 4								
n - 3	(MSB)	CRC						(LSB)
n								

The SMP FRAME TYPE field is defined in 10.4.3.3.2 and shall be set to the value defined in table 265.

The FUNCTION field is defined in 10.4.3.3.3 and shall be set to the value defined in table 265.

The FUNCTION RESULT field is defined in 10.4.3.3.4.

The RESPONSE LENGTH field is defined in 10.4.3.3.5 and shall be set to the value defined in table 265. A RESPONSE LENGTH field set to 00h does not have a special meaning based on the ALLOCATED RESPONSE LENGTH field in the request frame.

The EXPANDER CHANGE COUNT field is defined in the SMP REPORT GENERAL response (see 10.4.3.4).

The BROADCAST TYPE field indicates the value of the BROADCAST TYPE field in the request frame.

The NUMBER OF BROADCAST DESCRIPTORS field indicates how many broadcast descriptors follow.

NOTE 111 - The number of broadcast descriptors is limited to 126 by the SMP response frame size.

The broadcast descriptor list contains broadcast descriptors as defined in 10.4.3.9.4. Broadcast descriptors shall be returned for all Broadcasts of the type specified in the BROADCAST TYPE field, for which the count is non-zero. Broadcast descriptors shall be returned with the descriptor, if any, pertaining to no particular phy (i.e., PHY IDENTIFIER field set to FFh) first, followed by descriptors, if any, in ascending order sorted by the PHY IDENTIFIER field.

● Author: RElliott
Subject: Note
Date: 6/30/2008 6:16:52 PM
 ACCEPT - DONE

Per 6/11 LB call, add 4 bytes to slip in a BROADCAST DESCRIPTOR LENGTH field. New arrangement is:
7,8,9 Reserved
10 Broadcast Descriptor Length
11 Number of Broadcast Descriptors

● Author: Isi-gpenokie
Subject: Highlight
Date: 5/6/2008 4:07:50 PM
 ACCEPT - DONE

This is not the correct table reference. It should be table 266.

● Author: Isi-gpenokie
Subject: Highlight
Date: 5/6/2008 4:07:50 PM
 ACCEPT - DONE

This is not the correct table reference. It should be table 266.

● Author: RElliott
Subject: Highlight
Date: 6/30/2008 6:16:52 PM
 ACCEPT - DONE

how many broadcast descriptors follow.
s/b
the number of Broadcast descriptors in the Broadcast descriptor list

● Author: wdc-mevans
Subject: Highlight
Date: 5/26/2008 12:26:58 PM
 ACCEPT - DONE

field, for
s/b
field for

● Author: wdc-mevans
Subject: Highlight
Date: 5/29/2008 4:18:25 PM
 ACCEPT - DONE (in each descriptor)

field.
s/b
field in the descriptor.

The CRC field is defined in 10.4.3.3.8.

10.4.3.9.4 REPORT BROADCAST response broadcast descriptor

Table 266 defines the broadcast descriptor.

Table 266 — Broadcast descriptor

Byte\Bit	7	6	5	4	3	2	1	0
0	Reserved				BROADCAST TYPE			
1	PHY IDENTIFIER							
2	Reserved				BROADCAST REASON			
3	Reserved							
4	(MSB)	BROADCAST COUNT						(LSB)
5								
6	Reserved							
15								

The BROADCAST TYPE field, defined in the ZONED BROADCAST request (see table 308 in 10.4.3.20), indicates the type of Broadcast described by this broadcast descriptor.

The PHY IDENTIFIER field indicates the phy that caused the Broadcast described by this broadcast descriptor to be originated or the phy on which the Broadcast was received. A PHY IDENTIFIER field set to FFh indicates that no specific phy caused the Broadcast described by this broadcast descriptor.

The BROADCAST COUNT field counts the number of Broadcasts that were either:

- a) originated by the SAS device or expander device; or
- b) received by a phy attached to an end device.

If the SAS device or expander device has originated the Broadcast or received the Broadcast since transmitting a REPORT BROADCAST response, it shall increment this field at least once from the value in the previous REPORT BROADCAST response. It shall not increment this field when forwarding a Broadcast. This field shall wrap to at least 0001h after the maximum value (i.e., FFFFh) has been reached.

NOTE 112 - A management application client that uses the BROADCAST COUNT field should read and save all the BROADCAST COUNT field values after performing the discover process (see 4.7), and then read them after each receipt of each Broadcast to ensure that none of the counts increments a multiple of 65 535 times between reading them.

Author: RElliott
Subject: Highlight
Date: 6/30/2008 6:16:52 PM
T ACCEPT - DONE

3. Section 10.4.3.9.4, the title should have the "REPORT BROADCAST response" removed and just be "Broadcast descriptor".

(from Tim McLeod, Data Domain; T10 reflector 5/9/2008)

Author: wdc-mevans
Subject: Highlight
Date: 5/26/2008 12:27:30 PM
T REJECT

field, defined in the ZONED BROADCAST request (see table 308 in 10.4.3.20), indicates
s/b
field defined in the ZONED BROADCAST request (see table 308 in 10.4.3.20) indicates

Author: RElliott
Subject: Highlight
Date: 6/30/2008 6:16:52 PM
T ACCEPT - DONE
counts

s/b
indicates

Author: wdc-mevans
Subject: Highlight
Date: 5/26/2008 12:27:45 PM
T REJECT (it's only the Broadcast being described by this descriptor)

the Broadcast
s/b
a Broadcast

Author: wdc-mevans
Subject: Highlight
Date: 5/26/2008 12:27:54 PM
T REJECT (it's only the Broadcast being described by this descriptor)

the Broadcast
s/b
a Broadcast

Author: lsi-gpenokie
Subject: Highlight
Date: 5/6/2008 4:07:50 PM
T REJECT (but added "then")

This << it shall increment this field >> should be << the SAS device or expander device shall increment this field >>

Author: wdc-mevans
Subject: Highlight
Date: 5/26/2008 12:28:44 PM
T REJECT(first noun/subject convention, but added "then")

it
s/b
then the SAS device or expander device

Author: lsi-gpenokie

The CRC field is defined in 10.4.3.3.8.

10.4.3.9.4 REPORT BROADCAST response broadcast descriptor

Table 266 defines the broadcast descriptor.

Table 266 — Broadcast descriptor

Byte\Bit	7	6	5	4	3	2	1	0	
0	Reserved				BROADCAST TYPE				
1	PHY IDENTIFIER								
2	Reserved				BROADCAST REASON				
3	Reserved								
4	(MSB)	BROADCAST COUNT							
5								(LSB)	
6	Reserved								
15									

The BROADCAST TYPE field, defined in the ZONED BROADCAST request (see table 308 in 10.4.3.20), indicates the type of Broadcast described by this broadcast descriptor.

The PHY IDENTIFIER field indicates the phy that caused the Broadcast described by this broadcast descriptor to be originated or the phy on which the Broadcast was received. A PHY IDENTIFIER field set to FFh indicates that no specific phy caused the Broadcast described by this broadcast descriptor.

The BROADCAST COUNT field counts the number of Broadcasts that were either:

- a) originated by the SAS device or expander device, or
- b) received by a phy attached to an end device.

If the SAS device or expander device has originated the Broadcast or received the Broadcast since transmitting a REPORT BROADCAST response, it shall increment this field at least once from the value in the previous REPORT BROADCAST response. It shall not increment this field when forwarding a Broadcast. This field shall wrap to at least 0001h after the maximum value (i.e., FFFFh) has been reached.

NOTE 112 - A management application client that uses the BROADCAST COUNT field should read and save all the BROADCAST COUNT field values after performing the discover process (see 4.7), and then read them after each receipt of each Broadcast to ensure that none of the counts increments a multiple of 65 535 times between reading them.

Subject: Highlight

Date: 8/28/2008 9:27:55 AM

T ACCEPT - DONE (combine these into an a)b) list so the lengthy qualified compound noun isn't confused)

This << It shall not increment >> should be << The SAS device or expander device shall not increment >>

● Author: wdc-mevans

Subject: Highlight

Date: 5/26/2008 12:28:56 PM

T REJECT (subject of previous sentence)

It

s/b

The SAS device or expander device

● Author: lsi-gpenokie

Subject: Highlight

Date: 5/30/2008 4:08:40 PM

T REJECT (there are 79 uses of "this field" in the standard, including 3 lines above this one. They keep the wording from being unreadably verbose.)

This << This field shall >> should be << The BROADCAST COUNT field shall >>

For Broadcasts that are received, the BROADCAST REASON field shall be set to Fh. For Broadcasts that are originated, the BROADCAST REASON field indicates the reason that the Broadcast described by this broadcast descriptor was originated and is defined in table 267.

Table 267 — BROADCAST REASON field

BROADCAST TYPE field	BROADCAST REASON field	Description
0h (i.e., Broadcast (Change))	0h	Unspecified ^{a b}
4h (i.e., Broadcast (Expander))	0h	Unspecified
	1h	A phy event peak value detector has reached its threshold value.
	2h	A phy event peak value detector has been cleared by the SMP CONFIGURE PHY EVENT function (see 10.4.3.30)
	3h	The expander device is going to temporarily have reduced functionality (e.g., disable SMP access, reduced performance, disable phy to phy communication) for a period of time (see 4.6.8)
8h (i.e., Broadcast (Zone Activate))	0h	Unspecified
All others		Reserved
^a In an expander device, the Broadcast (Change) count is also reported in the REPORT GENERAL response (see 10.4.3.4) and in other SMP response frames containing an EXPANDER CHANGE COUNT field. ^b Broadcast (Change)s originated by this expander device or SAS device shall be counted, with the PHY IDENTIFIER field set to FFh.		

10.4.3.10 DISCOVER function

The DISCOVER function returns information about the specified phy. This SMP function provides information from the IDENTIFY address frame received by the phy and additional phy-specific information. This SMP function shall be implemented by all management device servers.

NOTE 113 - The DISCOVER LIST function (see 10.4.3.15) returns information about one or more phys.

● Author: RElliott
Subject: Highlight
Date: 6/30/2008 6:16:52 PM

T ACCEPT - DONE

BROADCAST REASON field

s/b

BROADCAST REASON field for originated Broadcasts

● Author: wdc-mevans
Subject: Highlight
Date: 5/26/2008 12:29:12 PM

T ACCEPT - DONE (just deleting temporarily, leaving "going to have reduced". It has not actually started reducing anything yet.)

going to temporarily have reduced

s/b

reducing

Table 268 defines the request format.

Table 268 — DISCOVER request

Byte/Bit	7	6	5	4	3	2	1	0	
0	SMP FRAME TYPE (40h)								
1	FUNCTION (10h)								
2	ALLOCATED RESPONSE LENGTH								
3	REQUEST LENGTH (00h or 02h)								
4	Reserved								
7	Reserved								
8	Reserved							IGNORE ZONE GROUP	
9	PHY IDENTIFIER								
10	Reserved								
11	Reserved								
12	(MSB)	CRC							
15							(LSB)		

The SMP FRAME TYPE field is defined in 10.4.3.2.2 and shall be set to the value defined in table 268.

The FUNCTION field is defined in 10.4.3.2.3 and shall be set to the value defined in table 268.

The ALLOCATED RESPONSE LENGTH field is defined in 10.4.3.2.4.

If the ALLOCATED RESPONSE LENGTH field is set to 00h, then the management device server shall:

- a) set the RESPONSE LENGTH field to 00h in the response frame; and
- b) return the first 52 bytes defined in table 269 plus the CRC field as the response frame.

If the ALLOCATED RESPONSE LENGTH field is not set to 00h, then the management device server shall:

- a) set the RESPONSE LENGTH field in the response frame to the non-zero value defined in table 269; and
- b) return the response frame as specified by the ALLOCATED RESPONSE LENGTH field.

The REQUEST LENGTH field is defined in 10.4.3.2.5 and shall be set to the one of the values defined in table 268 based on the LONG RESPONSE bit in the REPORT GENERAL response (see 10.4.3.4). A REQUEST LENGTH field set to 00h specifies that there are 2 dwords before the CRC field.

An IGNORE ZONE GROUP bit set to one specifies that the management device server shall return information about the specified phy (i.e., the phy specified by the PHY IDENTIFIER field) regardless of the zone permission table.

An IGNORE ZONE GROUP bit set to zero specifies that the management device server shall:

- a) if the SMP initiator port has access to the specified phy based on the zone permission table, return the requested information; or
- b) if the SMP initiator port does not have access to the specified phy, return a function result of PHY VACANT in the response frame (see table 245 in 10.4.3.3).

This page contains no comments

If the management device server is not in a zoning expander device with zoning enabled, it shall ignore the IGNORE_ZONE_GROUP bit.

The PHY IDENTIFIER field specifies the phy (see 4.2.8) for which the information is being requested.

The CRC field is defined in 10.4.3.2.8.

Table 269 defines the response format.

Table 269 — DISCOVER response (part 1 of 3)

Byte\Bit	7	6	5	4	3	2	1	0
0	SMP FRAME TYPE (41h)							
1	FUNCTION (10h)							
2	FUNCTION RESULT							
3	RESPONSE LENGTH (00h or 1Ah)							
4	(MSB)	EXPANDER CHANGE COUNT						(LSB)
5								
6	Reserved							
8								
9	PHY IDENTIFIER							
10	Reserved							
11								
12	Reserved	ATTACHED DEVICE TYPE			ATTACHED REASON			
13	Reserved			NEGOTIATED LOGICAL LINK RATE				
14	Reserved			ATTACHED SSP INITIATOR	ATTACHED STP INITIATOR	ATTACHED SMP INITIATOR	ATTACHED SATA HOST	
15	ATTACHED SATA PORT SELECTOR	Reserved		ATTACHED SSP TARGET	ATTACHED STP TARGET	ATTACHED SMP TARGET	ATTACHED SATA DEVICE	
16	SAS ADDRESS							
23								
24	ATTACHED SAS ADDRESS							
31								
32	ATTACHED PHY IDENTIFIER							
33	Reserved				ATTACHED INSIDE ZPSDS PERSISTENT	ATTACHED REQUESTED INSIDE ZPSDS	ATTACHED BREAK_REPLY CAPABLE	
34	Reserved							
39								
40	PROGRAMMED MINIMUM PHYSICAL LINK RATE				HARDWARE MINIMUM PHYSICAL LINK RATE			
41	PROGRAMMED MAXIMUM PHYSICAL LINK RATE				HARDWARE MAXIMUM PHYSICAL LINK RATE			
42	PHY CHANGE COUNT							

Author: RElliott
Subject: Highlight
Date: 6/30/2008 6:16:52 PM
ACCEPT - DONE

T

it
s/b
then it

Table 269 — DISCOVER response (part 2 of 3)

Byte\Bit	7	6	5	4	3	2	1	0
43	VIRTUAL PHY	Reserved			PARTIAL PATHWAY TIMEOUT VALUE			
44	Reserved			ROUTING ATTRIBUTE				
45	Reserved	CONNECTOR TYPE						
46	CONNECTOR ELEMENT INDEX							
47	CONNECTOR PHYSICAL LINK							
48	Reserved							
49								
50	Vendor specific							
51								
52	ATTACHED DEVICE NAME							
59								
60	Reserved	REQUESTED INSIDE ZPSDS CHANGED BY EXPANDER	INSIDE ZPSDS PERSISTENT	REQUESTED INSIDE ZPSDS	Reserved	ZONE GROUP PERSISTENT	INSIDE ZPSDS	ZONING ENABLED
61	Reserved							
62								
63	ZONE GROUP							
64	SELF-CONFIGURATION STATUS							
65	SELF-CONFIGURATION LEVELS COMPLETED							
66	Reserved							
67								
68	SELF-CONFIGURATION SAS ADDRESS							
75								
76	PROGRAMMED PHY CAPABILITIES							
79								
80	CURRENT PHY CAPABILITIES							
83								
84	ATTACHED PHY CAPABILITIES							
87								
88	Reserved							
93								

This page contains no comments

Table 269 — DISCOVER response (part 3 of 3)

Byte\Bit	7	6	5	4	3	2	1	0
94	REASON				NEGOTIATED PHYSICAL LINK RATE			
95	Reserved						NEGOTIATED SSC	HARDWARE MUXING SUPPORTED
96	Reserved	DEFAULT INSIDE ZPSDS PERSISTENT	DEFAULT REQUESTED INSIDE ZPSDS	Reserved	DEFAULT ZONE GROUP PERSISTENT	Reserved	DEFAULT ZONING ENABLED	
97	Reserved							
98	Reserved							
99	DEFAULT ZONE GROUP							
100	Reserved	SAVED INSIDE ZPSDS PERSISTENT	SAVED REQUESTED INSIDE ZPSDS	Reserved	SAVED ZONE GROUP PERSISTENT	Reserved	SAVED ZONING ENABLED	
101	Reserved							
102	Reserved							
103	SAVED ZONE GROUP							
104	Reserved	SHADOW INSIDE ZPSDS PERSISTENT	SHADOW REQUESTED INSIDE ZPSDS	Reserved	SHADOW ZONE GROUP PERSISTENT	Reserved		
105	Reserved							
106	Reserved							
107	SHADOW ZONE GROUP							
108	(MSB)							
111	CRC							
	(LSB)							

The SMP FRAME TYPE field is defined in 10.4.3.3.2 and shall be set to the value defined in table 269.

The FUNCTION field is defined in 10.4.3.3.3 and shall be set to the value defined in table 269.

The FUNCTION RESULT field is defined in 10.4.3.3.4.

The RESPONSE LENGTH field is defined in 10.4.3.3.5 and shall be set to one of the values defined in table 269 based on the ALLOCATED RESPONSE LENGTH field in the request frame.

The EXPANDER CHANGE COUNT field is defined in the SMP REPORT GENERAL response (see 10.4.3.4).

The PHY IDENTIFIER field indicates the phy for which information is being returned.

● Author: hpq-relliott

Subject: Note

Date: 7/14/2008 2:34:27 PM

 REJECT (5/7 no interest in the SAS LB meeting at least)

Add a field indicating drive presence (if known)

● Author: hpq-relliott

Subject: Note

Date: 8/28/2008 2:26:59 PM

 ACCEPT - DONE (8/28 incorporated r1 7/14 WG made further changes that will be in 08-183r1)

Incorporate 08-183 SAS-2 Add device slot numbering fields to DISCOVER, which adds 3 new fields to fully describe the device slot (i.e., drive bay) in a variety of system topologies.

The ATTACHED DEVICE TYPE field indicates the device type attached to this phy and is defined in table 270.

Table 270 — ATTACHED DEVICE TYPE field

Code	Description
000b	No device attached
001b	SAS device or SATA device
010b	Expander device
011b	Expander device compliant with a previous version of this standard
All others	Reserved

If the phy is a physical phy, the ATTACHED DEVICE TYPE field shall only be set to a value other than 000b after:

- a) if a SAS device or expander device is attached, after the identification sequence is complete;
- b) if a SATA phy is attached and the STP/SATA bridge does not retrieve IDENTIFY (PACKET) DEVICE data, after the STP/SATA bridge receives the initial Register - Device to Host FIS; or
- c) if a SATA phy is attached and the STP/SATA bridge retrieves IDENTIFY (PACKET) DEVICE data, after the STP/SATA bridge receives IDENTIFY (PACKET) DEVICE data or it encounters a failure retrieving that data.

If the phy is a physical phy and a SAS phy or expander phy is attached, the ATTACHED REASON field indicates the value of the REASON field received in the IDENTIFY address frame (see 7.8.2) during the identification sequence. If the phy is a physical phy and a SATA phy is attached, the ATTACHED REASON field shall be set to 0h after the initial Register - Device to Host FIS has been received. If the phy is a virtual phy, the ATTACHED REASON field shall be set to 0h.

The NEGOTIATED LOGICAL LINK RATE field is defined in table 271 and indicates the logical link rate being used by the phy. For physical phys, this is negotiated during the link reset sequence. For virtual phys, this field should be set to the maximum physical link rate supported by the expander device. This field may be different from the negotiated physical link rate when multiplexing is enabled.

Table 271 — NEGOTIATED LOGICAL LINK RATE field

NEGOTIATED PHYSICAL LINK RATE field	Multiplexing	NEGOTIATED LOGICAL LINK RATE field
9h (i.e., G2)	Disabled	9h (i.e., 3 Gbps)
	Enabled	8h (i.e., 1.5 Gbps)
Ah (i.e., G3)	Disabled	Ah (i.e., 6 Gbps)
	Enabled	9h (i.e., 3 Gbps)
All others	Any	Same as the NEGOTIATED LOGICAL LINK RATE field

NOTE 114 - In previous versions of this standard that did not define multiplexing, the NEGOTIATED LOGICAL LINK RATE field was called the NEGOTIATED PHYSICAL LINK RATE field and the NEGOTIATED PHYSICAL LINK RATE field in byte 94 did not exist.

● Author: Isi-gpenokie
Subject: Cross-Out
Date: 5/6/2008 4:07:50 PM
T ACCEPT - DONE

This << after >> should be deleted as there is an <<after>> in each item. No need to have << after .. after >>.

● Author: wdc-mevans
Subject: Cross-Out
Date: 5/26/2008 12:29:45 PM
T ACCEPT - DONE

after
[Delete the redundant word.]

● Author: RElliott
Subject: Highlight
Date: 6/30/2008 6:16:52 PM
T ACCEPT - DONE
the
s/b
then the

● Author: RElliott
Subject: Highlight
Date: 6/30/2008 6:16:52 PM
T ACCEPT - DONE
the
s/b
then the

● Author: RElliott
Subject: Highlight
Date: 6/30/2008 6:16:52 PM
T ACCEPT - DONE
the
s/b
then the

● Author: RElliott
Subject: Highlight
Date: 6/30/2008 6:16:52 PM
T ACCEPT - DONE
the
s/b
then the

Table 272 defines the ATTACHED SATA PORT SELECTOR bit and the ATTACHED SATA DEVICE bit.

Table 272 — ATTACHED SATA PORT SELECTOR and ATTACHED SATA DEVICE bits

ATTACHED SATA PORT SELECTOR bit value ^{a b d}	ATTACHED SATA DEVICE bit value ^{c d}	Description
0	0	Either: a) the phy is a virtual phy; or b) the phy is a physical phy, and neither a SATA port selector nor a SATA device is attached and ready on the selected phy.
0	1	The phy is a physical phy and the attached phy is a SATA device phy. No SATA port selector is present (i.e., the SP state machine did not detect COMWAKE in response to the initial COMINIT, but sequenced through the normal (non-SATA port selector) SATA device OOB sequence).
1	0	The phy is a physical phy, the attached phy is a SATA port selector host phy, and either: a) the attached phy is the inactive host phy, or b) the attached phy is the active host phy and a SATA device is either not present or not ready behind the SATA port selector (i.e., the SP state machine detected COMWAKE while waiting for COMINIT).
1	1	The phy is a physical phy, the attached phy is a SATA port selector's active host phy and a SATA device is present behind the SATA port selector (i.e., the SP state machine detected COMWAKE while waiting for COMINIT, timed out waiting for COMSAS, and exchanged COMWAKE with an attached SATA device).
<p>^a The ATTACHED SATA PORT SELECTOR bit is invalid if the NEGOTIATED LOGICAL LINK RATE field is set to UNKNOWN (i.e., 0h), DISABLED (i.e., 1h), or RESET_IN_PROGRESS (i.e., 5h).</p> <p>^b Whenever the ATTACHED SATA PORT SELECTOR bit changes, the phy shall originate a Broadcast (Change)(see 7.11).</p> <p>^c For the purposes of the ATTACHED SATA DEVICE bit, a SATA port selector is not considered a SATA device.</p> <p>^d The ATTACHED SATA PORT SELECTOR bit and the ATTACHED SATA DEVICE bit are updated as specified in the SP state machine (see 6.8).</p>		

An ATTACHED SATA HOST bit set to one indicates a SATA host port is attached. An ATTACHED SATA HOST bit set to zero indicates a SATA host port is not attached.

NOTE 115 - Support for SATA hosts is outside the scope of this standard.

If a SAS phy reset sequence occurs (see 6.7.4)(i.e., one or more of the ATTACHED SSP INITIATOR PORT bit, ATTACHED STP INITIATOR PORT bit, the ATTACHED SMP INITIATOR PORT bit, the ATTACHED SSP TARGET PORT bit, the ATTACHED STP TARGET PORT bit, and/or the ATTACHED SMP TARGET PORT bit is set to one), then the ATTACHED SATA PORT SELECTOR bit, the ATTACHED SATA DEVICE bit, and the ATTACHED SATA HOST bit shall each be set to zero.

An ATTACHED SSP INITIATOR PORT bit set to one indicates that the attached phy supports an SSP initiator port. An ATTACHED SSP INITIATOR PORT bit set to zero indicates that the attached phy does not support an SSP initiator port. If the phy is a physical phy, the ATTACHED SSP INITIATOR PORT bit indicates the value of the SSP INITIATOR PORT bit received in the IDENTIFY address frame (see 7.8.2) during the identification sequence.

An ATTACHED STP INITIATOR PORT bit set to one indicates that the attached phy supports an STP initiator port. An ATTACHED STP INITIATOR PORT bit set to zero indicates that the attached phy does not support an STP

Page: 596

Author: lsi-bday
Subject: Highlight
Date: 8/28/2008 2:30:56 PM

T ACCEPT - DONE (7/14 "and the attached phy is neither a SAS phy nor an expander phy (i.e., the attached phy did not respond with COMSAS within the COMSAS Timeout)". Also apply this to the other lsi-bday comment.

7/9 yes. don't know for sure that it is a SATA device. This bit really means "attached non-SAS device" or "attached potential SATA device". Don't want to delay setting the bit until COMWAKE, which would mess up spinup hold handling. If a SAS device is unplugged after sending COMINIT but before sending COMSAS, the phy could be confused.)

The phy is a physical phy and the attached phy is a SATA device phy.

Since ATTACHED SATA DEVICE is set to one prior to actually getting a COMWAKE back from device, this row can be hit when no SATA device is present.

Author: RElliott
Subject: Note
Date: 8/28/2008 2:30:44 PM

T ACCEPT - DONE (7/14 Port Selector bit cleared out of SP1. SATA Device set in SP7. Mark this row as "Obsolete".)

(from Brian Day 4/17 reflector)

on an active port of a port selector, the PS bit gets cleared by the COMINIT, so the device runs with these set to 01b

Might be impossible to get into the 11b state

Author: RElliott
Subject: Highlight
Date: 8/31/2008 5:35:31 PM

T ACCEPT - DONE

bit is invalid
s/b
bit shall be ignored

to avoid misusing the "ignored" keyword

Author: wdc-mevans
Subject: Highlight
Date: 5/6/2008 4:07:50 PM

T ACCEPT - DONE

ATTACHED
s/b

the ATTACHED

[or all "the"s after the first "the" may be deleted. This form is used on the next page. One way or another, they should be consistent,]

Author: RElliott
Subject: Highlight
Date: 6/30/2008 6:16:52 PM

T ACCEPT - DONE

the
s/b
then the

initiator port. If the phy is a physical phy, ~~the ATTACHED STP INITIATOR PORT bit indicates the value of the STP INITIATOR PORT bit received in the IDENTIFY address frame (see 7.8.2) during the identification sequence.~~

~~An ATTACHED SMP INITIATOR PORT bit set to one indicates that the attached phy supports an SMP initiator port. An ATTACHED SMP INITIATOR PORT bit set to zero indicates that the attached phy does not support an SMP initiator port. If the phy is a physical phy, the ATTACHED SMP INITIATOR PORT bit indicates the value of the SMP INITIATOR PORT bit received in the IDENTIFY address frame (see 7.8.2) during the identification sequence.~~

~~An ATTACHED SSP TARGET PORT bit set to one indicates that the attached phy supports an SSP target port. An ATTACHED SSP TARGET PORT bit set to zero indicates that the attached phy does not support an SSP target port. If the phy is a physical phy, the ATTACHED SSP TARGET PORT bit indicates the value of the SSP TARGET PORT bit received in the IDENTIFY address frame (see 7.8.2) during the identification sequence.~~

~~An ATTACHED STP TARGET PORT bit set to one indicates that the attached phy supports an STP target port. An ATTACHED STP TARGET PORT bit set to zero indicates that the attached phy does not support an STP target port. If the phy is a physical phy, the ATTACHED STP TARGET PORT bit indicates the value of the STP TARGET PORT bit received in the IDENTIFY address frame (see 7.8.2) during the identification sequence.~~

~~An ATTACHED SMP TARGET PORT bit set to one indicates that the attached phy supports an SMP target port. An ATTACHED SMP TARGET PORT bit set to zero indicates that the attached phy does not support an SMP target port. If the phy is a physical phy, the ATTACHED SMP TARGET PORT bit indicates the value of the SMP TARGET PORT bit received in the IDENTIFY address frame (see 7.8.2) during the identification sequence.~~

~~If the phy is a physical phy, the ATTACHED SSP INITIATOR PORT bit, ATTACHED STP INITIATOR PORT bit, ATTACHED SMP INITIATOR PORT bit, ATTACHED SSP TARGET PORT bit, ATTACHED STP TARGET PORT bit, and ATTACHED SMP TARGET PORT bit shall be updated at the end of the identification sequence.~~

~~If a SATA phy reset sequence occurs (see 6.7.3) (i.e., the ATTACHED SATA PORT SELECTOR bit is set to one, the ATTACHED SATA DEVICE bit is set to one, or the ATTACHED SATA HOST bit is set to one), then the ATTACHED SSP INITIATOR PORT bit, ATTACHED STP INITIATOR PORT bit, ATTACHED SMP INITIATOR PORT bit, ATTACHED SSP TARGET PORT bit, ATTACHED STP TARGET PORT bit, and ATTACHED SMP TARGET PORT bit shall each be set to zero.~~

~~If the phy is an expander phy, the SAS ADDRESS field contains the SAS address of the expander device (see 4.2.4). If the phy is a SAS phy, the SAS ADDRESS field contains the SAS address of the SAS port (see 4.2.7). If the phy is a physical phy, the SAS ADDRESS field contains the value of the SAS ADDRESS field transmitted in the IDENTIFY address frame (see 7.8.2) during the identification sequence.~~

The ATTACHED SAS ADDRESS field is defined as follows:

- a) if the attached port is an expander port, then the ATTACHED SAS ADDRESS field contains the SAS address of the attached expander device (see 4.2.4);
- b) if the attached port is a SAS port, then the ATTACHED SAS ADDRESS field contains SAS address of the attached SAS port (see 4.2.7); or
- c) if the attached port is a SATA device port, then the ATTACHED SAS ADDRESS field contains the SAS address of the STP/SATA bridge (see 4.6.2).

For a physical phy, the ATTACHED SAS ADDRESS field contains the value of the SAS ADDRESS field received in the IDENTIFY address frame (see 7.8.2) during the identification sequence, and shall be updated:

- a) after the identification sequence completes, if a SAS phy or expander phy is attached; or
- b) after the COMSAS Detect Timeout timer expires (see 6.8.3.9), if a SATA phy is attached.

An STP initiator port should not make a connection request to the attached SAS address until the ATTACHED DEVICE TYPE field is set to a value other than 000b (see table 270).

The ATTACHED PHY IDENTIFIER field is defined as follows:

- a) if the attached phy is a SAS phy, then the ATTACHED PHY IDENTIFIER field contains the phy identifier of the attached SAS phy in the attached SAS device;
- b) if the attached phy is an expander phy, then the ATTACHED PHY IDENTIFIER field contains the phy identifier (see 4.2.8) of the attached expander phy in the attached expander device;
- c) if the attached phy is a SATA device phy, then the ATTACHED PHY IDENTIFIER field contains 00h;

● Author: RElliott
Subject: Highlight
Date: 6/30/2008 6:16:52 PM
T ACCEPT - DONE
the
s/b
then the

● Author: RElliott
Subject: Highlight
Date: 6/30/2008 6:16:52 PM
T ACCEPT - DONE
the
s/b
then the

● Author: RElliott
Subject: Highlight
Date: 6/30/2008 6:16:52 PM
T ACCEPT - DONE
the
s/b
then the

● Author: RElliott
Subject: Highlight
Date: 6/30/2008 6:16:52 PM
T ACCEPT - DONE
the
s/b
then the

● Author: RElliott
Subject: Highlight
Date: 6/30/2008 6:16:52 PM
T ACCEPT - DONE
the
s/b
then the

● Author: RElliott
Subject: Highlight
Date: 6/30/2008 6:16:52 PM
T ACCEPT - DONE
the
s/b
then the

● Author: wdc-mevans
Subject: Highlight
Date: 5/6/2008 4:07:50 PM
T ACCEPT - DONE
ATTACHED
s/b

initiator port. If the phy is a physical phy, the ATTACHED STP INITIATOR PORT bit indicates the value of the STP INITIATOR PORT bit received in the IDENTIFY address frame (see 7.8.2) during the identification sequence.

An ATTACHED SMP INITIATOR PORT bit set to one indicates that the attached phy supports an SMP initiator port. An ATTACHED SMP INITIATOR PORT bit set to zero indicates that the attached phy does not support an SMP initiator port. If the phy is a physical phy, the ATTACHED SMP INITIATOR PORT bit indicates the value of the SMP INITIATOR PORT bit received in the IDENTIFY address frame (see 7.8.2) during the identification sequence.

An ATTACHED SSP TARGET PORT bit set to one indicates that the attached phy supports an SSP target port. An ATTACHED SSP TARGET PORT bit set to zero indicates that the attached phy does not support an SSP target port. If the phy is a physical phy, the ATTACHED SSP TARGET PORT bit indicates the value of the SSP TARGET PORT bit received in the IDENTIFY address frame (see 7.8.2) during the identification sequence.

An ATTACHED STP TARGET PORT bit set to one indicates that the attached phy supports an STP target port. An ATTACHED STP TARGET PORT bit set to zero indicates that the attached phy does not support an STP target port. If the phy is a physical phy, the ATTACHED STP TARGET PORT bit indicates the value of the STP TARGET PORT bit received in the IDENTIFY address frame (see 7.8.2) during the identification sequence.

An ATTACHED SMP TARGET PORT bit set to one indicates that the attached phy supports an SMP target port. An ATTACHED SMP TARGET PORT bit set to zero indicates that the attached phy does not support an SMP target port. If the phy is a physical phy, the ATTACHED SMP TARGET PORT bit indicates the value of the SMP TARGET PORT bit received in the IDENTIFY address frame (see 7.8.2) during the identification sequence.

If the phy is a physical phy, the ATTACHED SSP INITIATOR PORT bit, ATTACHED STP INITIATOR PORT bit, ATTACHED SMP INITIATOR PORT bit, ATTACHED SSP TARGET PORT bit, ATTACHED STP TARGET PORT bit, and ATTACHED SMP TARGET PORT bit shall be updated at the end of the identification sequence.

If a SATA phy reset sequence occurs (see 6.7.3) (i.e., the ATTACHED SATA PORT SELECTOR bit is set to one, the ATTACHED SATA DEVICE bit is set to one, or the ATTACHED SATA HOST bit is set to one), then the ATTACHED SSP INITIATOR PORT bit, ATTACHED STP INITIATOR PORT bit, ATTACHED SMP INITIATOR PORT bit, ATTACHED SSP TARGET PORT bit, ATTACHED STP TARGET PORT bit, and ATTACHED SMP TARGET PORT bit shall each be set to zero.

If the phy is an expander phy, the SAS ADDRESS field contains the SAS address of the expander device (see 4.2.4). If the phy is a SAS phy, the SAS ADDRESS field contains the SAS address of the SAS port (see 4.2.7). If the phy is a physical phy, the SAS ADDRESS field contains the value of the SAS ADDRESS field transmitted in the IDENTIFY address frame (see 7.8.2) during the identification sequence.

The ATTACHED SAS ADDRESS field is defined as follows:

- a) if the attached port is an expander port, then the ATTACHED SAS ADDRESS field contains the SAS address of the attached expander device (see 4.2.4);
- b) if the attached port is a SAS port, then the ATTACHED SAS ADDRESS field contains SAS address of the attached SAS port (see 4.2.7); or
- c) if the attached port is a SATA device port, then the ATTACHED SAS ADDRESS field contains the SAS address of the STP/SATA bridge (see 4.6.2).

For a physical phy, the ATTACHED SAS ADDRESS field contains the value of the SAS ADDRESS field received in the IDENTIFY address frame (see 7.8.2) during the identification sequence, and shall be updated:

- a) after the identification sequence completes, if a SAS phy or expander phy is attached; or
- b) after the COMSAS Detect Timeout timer expires (see 6.8.3.9), if a SATA phy is attached.

An STP initiator port should not make a connection request to the attached SAS address until the ATTACHED DEVICE TYPE field is set to a value other than 000b (see table 270).

The ATTACHED PHY IDENTIFIER field is defined as follows:

- a) if the attached phy is a SAS phy, then the ATTACHED PHY IDENTIFIER field contains the phy identifier of the attached SAS phy in the attached SAS device;
- b) if the attached phy is an expander phy, then the ATTACHED PHY IDENTIFIER field contains the phy identifier (see 4.2.8) of the attached expander phy in the attached expander device;
- c) if the attached phy is a SATA device phy, then the ATTACHED PHY IDENTIFIER field contains 00h;

the ATTACHED
[or all "the"s after the first "the" may be deleted. This form is used on the next page. One way or another, they should be consistent,]

● Author: wdc-mevans
Subject: Highlight
Date: 5/6/2008 4:07:50 PM
T ACCEPT - DONE

ATTACHED
s/b
the ATTACHED
[or all "the"s after the first "the" may be deleted. This form is used on the next page. One way or another, they should be consistent,]

● Author: RElliott
Subject: Highlight
Date: 6/30/2008 6:16:52 PM
T ACCEPT - DONE

the
s/b
then the

● Author: RElliott
Subject: Highlight
Date: 6/30/2008 6:16:52 PM
T ACCEPT - DONE

the
s/b
then the

● Author: RElliott
Subject: Highlight
Date: 6/30/2008 6:16:52 PM
T ACCEPT - DONE

the
s/b
then the

● Author: Isi-gpenokie
Subject: Highlight
Date: 5/30/2008 4:10:19 PM
T REJECT (that puts the "if" in between "shall be updated" and "after ...")

This << a) after the identification sequence completes, if a SAS phy or expander phy is attached; or
b) after the COMSAS Detect Timeout timer expires (see 6.8.3.9), if a SATA phy is attached >> should be << a) if a SAS phy or expander phy is attached, then after the identification sequence completes; or
b) if a SATA phy is attached, then after the COMSAS Detect Timeout timer expires (see 6.8.3.9). >> to make this a.b.c list consistent with the others.

- d) if the attached phy is a SATA port selector phy and the expander device is able to determine the port of the SATA port selector to which it is attached, then the ATTACHED PHY IDENTIFIER field contains 00h or 01h; or
- e) if the attached phy is a SATA port selector phy and the expander device is not able to determine the port of the SATA port selector to which it is attached, then the ATTACHED PHY IDENTIFIER field contains 00h.

If the phy is a physical phy and the attached phy is a SAS phy or an expander phy, the ATTACHED PHY IDENTIFIER field contains the value of the PHY IDENTIFIER field received in the IDENTIFY address frame (see 7.8.2) during the identification sequence.

For a physical phy, the ATTACHED PHY IDENTIFIER field shall be updated:

- a) after the identification sequence completes, if a SAS phy or expander phy is attached; or
- b) after the COMSAS Detect Timeout timer expires (see 6.8.3.9), if a SATA phy is attached.

If the phy is a physical phy, the ATTACHED INSIDE ZPSDS PERSISTENT bit indicates the value of the INSIDE ZPSDS PERSISTENT bit received in the IDENTIFY address frame (see 7.8.2) from the attached phy during the identification sequence. If the phy is a virtual phy, the ATTACHED INSIDE ZPSDS PERSISTENT bit shall be set to zero.

If the phy is a physical phy, the ATTACHED REQUESTED INSIDE ZPSDS bit indicates the value of the REQUESTED INSIDE ZPSDS bit received in the IDENTIFY address frame (see 7.8.2) from the attached phy during the identification sequence. If the phy is a virtual phy, the ATTACHED REQUESTED INSIDE ZPSDS bit shall be set to zero.

If the phy is a physical phy, the ATTACHED BREAK_REPLY CAPABLE bit indicates the value of the BREAK_REPLY CAPABLE bit received in the IDENTIFY address frame (see 7.8.2) during the identification sequence. If a phy reset sequence occurs (see 6.7) then the ATTACHED BREAK_REPLY CAPABLE bit shall be set to zero. If the phy is a virtual phy, the ATTACHED BREAK_REPLY CAPABLE bit shall be set to zero.

The PROGRAMMED MINIMUM PHYSICAL LINK RATE field indicates the minimum physical link rate set by the PHY CONTROL function (see 10.4.3.28). The values are defined in table 273. The default value shall be the value of the HARDWARE MINIMUM PHYSICAL LINK RATE field.

The HARDWARE MINIMUM PHYSICAL LINK RATE field indicates the minimum physical link rate supported by the phy. The values are defined in table 274.

The PROGRAMMED MAXIMUM PHYSICAL LINK RATE field indicates the maximum physical link rate set by the PHY CONTROL function (see 10.4.3.28). The values are defined in table 273. The default value shall be the value of the HARDWARE MAXIMUM PHYSICAL LINK RATE field.

Table 273 — PROGRAMMED MINIMUM PHYSICAL LINK RATE and PROGRAMMED MAXIMUM PHYSICAL LINK rate fields

Code	Description
0h	Not programmable
1h - 7h	Reserved
8h	1.5 Gbps
9h	3 Gbps
Ah	6 Gbps
Bh - Fh	Reserved for future physical link rates

Author: RElliott
Subject: Highlight
Date: 6/30/2008 6:16:52 PM

T ACCEPT - DONE
the
s/b
then the

Author: lsi-gpenokie
Subject: Highlight
Date: 5/30/2008 4:10:28 PM

T REJECT (that puts the "if" in between "shall be updated" and "after ...")

This

<< a) after the identification sequence completes, if a SAS phy or expander phy is attached; or
b) after the COMSAS Detect Timeout timer expires (see 6.8.3.9), if a SATA phy is attached. >>
should be

<< a) if a SAS phy or expander phy is attached, then after the identification sequence completes; or
b) if a SATA phy is attached, then after the COMSAS Detect Timeout timer expires (see 6.8.3.9). >> to make this a.b.c list
consistent with the others.

Author: RElliott
Subject: Highlight
Date: 6/30/2008 6:16:52 PM

T ACCEPT - DONE
the
s/b
then the

Author: RElliott
Subject: Highlight
Date: 6/30/2008 6:16:52 PM

T ACCEPT - DONE
the
s/b
then the

Author: RElliott
Subject: Highlight
Date: 6/30/2008 6:16:52 PM

T ACCEPT - DONE
the
s/b
then the

Author: RElliott
Subject: Highlight
Date: 6/30/2008 6:16:52 PM

T ACCEPT - DONE
the
s/b
then the

Author: RElliott
Subject: Highlight

- d) if the attached phy is a SATA port selector phy and the expander device is able to determine the port of the SATA port selector to which it is attached, then the ATTACHED PHY IDENTIFIER field contains 00h or 01h; or
- e) if the attached phy is a SATA port selector phy and the expander device is not able to determine the port of the SATA port selector to which it is attached, then the ATTACHED PHY IDENTIFIER field contains 00h.

If the phy is a physical phy and the attached phy is a SAS phy or an expander phy, the ATTACHED PHY IDENTIFIER field contains the value of the PHY IDENTIFIER field received in the IDENTIFY address frame (see 7.8.2) during the identification sequence.

For a physical phy, the ATTACHED PHY IDENTIFIER field shall be updated:

- a) after the identification sequence completes, if a SAS phy or expander phy is attached; or
- b) after the COMSAS Detect Timeout timer expires (see 6.8.3.9), if a SATA phy is attached.

If the phy is a physical phy, the ATTACHED INSIDE ZPSDS PERSISTENT bit indicates the value of the INSIDE ZPSDS PERSISTENT bit received in the IDENTIFY address frame (see 7.8.2) from the attached phy during the identification sequence. If the phy is a virtual phy, the ATTACHED INSIDE ZPSDS PERSISTENT bit shall be set to zero.

If the phy is a physical phy, the ATTACHED REQUESTED INSIDE ZPSDS bit indicates the value of the REQUESTED INSIDE ZPSDS bit received in the IDENTIFY address frame (see 7.8.2) from the attached phy during the identification sequence. If the phy is a virtual phy, the ATTACHED REQUESTED INSIDE ZPSDS bit shall be set to zero.

If the phy is a physical phy, the ATTACHED BREAK_REPLY CAPABLE bit indicates the value of the BREAK_REPLY CAPABLE bit received in the IDENTIFY address frame (see 7.8.2) during the identification sequence. If a phy reset sequence occurs (see 6.7) then the ATTACHED BREAK_REPLY CAPABLE bit shall be set to zero. If the phy is a virtual phy, the ATTACHED BREAK_REPLY CAPABLE bit shall be set to zero.

The PROGRAMMED MINIMUM PHYSICAL LINK RATE field indicates the minimum physical link rate set by the PHY CONTROL function (see 10.4.3.28). The values are defined in table 273. The default value shall be the value of the HARDWARE MINIMUM PHYSICAL LINK RATE field.

The HARDWARE MINIMUM PHYSICAL LINK RATE field indicates the minimum physical link rate supported by the phy. The values are defined in table 274.

The PROGRAMMED MAXIMUM PHYSICAL LINK RATE field indicates the maximum physical link rate set by the PHY CONTROL function (see 10.4.3.28). The values are defined in table 273. The default value shall be the value of the HARDWARE MAXIMUM PHYSICAL LINK RATE field.

Table 273 — PROGRAMMED MINIMUM PHYSICAL LINK RATE and PROGRAMMED MAXIMUM PHYSICAL LINK rate fields

Code	Description
0h	Not programmable
1h - 7h	Reserved
8h	1.5 Gbps
9h	3 Gbps
Ah	6 Gbps
Bh - Fh	Reserved for future physical link rates

Date: 6/30/2008 6:16:52 PM

T ACCEPT - DONE

the
s/b
then the

● Author: Isi-gpenokie

Subject: Highlight

Date: 5/6/2008 4:07:50 PM

T ACCEPT - DONE

This << sequence occurs (see 6.7) then the >> is missing a comma before the then.

● Author: RElliott

Subject: Highlight

Date: 6/30/2008 6:16:52 PM

T ACCEPT - DONE

the
s/b
then the

The **HARDWARE MAXIMUM PHYSICAL LINK RATE** field indicates the maximum physical link rate supported by the phy. The values are defined in table 274. If the phy is a virtual phy, this field should be set to the maximum physical link rate supported by the expander device.

Table 274 — **HARDWARE MINIMUM PHYSICAL LINK RATE and HARDWARE MAXIMUM PHYSICAL LINK RATE fields**

Code	Description
0h - 7h	Reserved
8h	1.5 Gbps
9h	3 Gbps
Ah	6 Gbps
Bh - Fh	Reserved for future physical link rates

The **PHY CHANGE COUNT** field counts the number of Broadcast (Change)s originated by an expander phy. Expander devices shall support this field. Other device types shall not support this field. This field shall be set to 00h at power on. The expander device shall increment this field at least once when:

- a) it originates a Broadcast (Change) for an expander phy-related reason described in 7.11 from the specified expander phy; or
- b) the zone phy information changes for the specified expander phy (e.g., when a locked expander device is unlocked (see 4.9.6.5)),

and shall not increment this field when forwarding a Broadcast (Change).

After incrementing the **PHY CHANGE COUNT** field, the expander device is not required to increment the **PHY CHANGE COUNT** field again unless a **DISCOVER response** is transmitted. The **PHY CHANGE COUNT** field shall wrap to 00h after the maximum value (i.e., FFh) has been reached.

NOTE 116 - Application clients that use the **PHY CHANGE COUNT** field should read it often enough to ensure that it does not increment a multiple of 256 times between reading the field.

A **VIRTUAL PHY** bit set to one indicates that the phy is a virtual phy and is part of an internal port and the attached device is contained within the expander device. A **VIRTUAL PHY** bit set to zero indicates that the phy is a physical phy and the attached device is not contained within the expander device.

The **PARTIAL PATHWAY TIMEOUT VALUE** field indicates the partial pathway timeout value in microseconds (see 7.12.4.4) set by the **PHY CONTROL** function (see 10.4.3.28).

NOTE 117 - The recommended default value for **PARTIAL PATHWAY TIMEOUT VALUE** is 7 μs.

● Author: wdc-mevans
Subject: Highlight
Date: 5/23/2008 2:30:44 PM
T ACCEPT - DONE (as "indicates")
counts
s/b
contains

● Author: wdc-mevans
Subject: Highlight
Date: 5/26/2008 12:30:50 PM
T REJECT (first noun/subject convention)
it
s/b
the expander phy

● Author: wdc-mevans
Subject: Highlight
Date: 5/26/2008 12:31:46 PM
T ACCEPT - DONE
(see 4.9.6.5)),
and
s/b
(see 4.9.6.5)).
The expander device

● Author: elx-bmartin
Subject: Comment on Text
Date: 5/30/2008 4:12:50 PM
T ACCEPT - DONE (also added "for the phy", since returning DISCOVER response for another phy doesn't matter.)
DISCOVER response
s/b
DISCOVER response or a DISCOVER_LIST response

The ROUTING ATTRIBUTE field indicates the routing attribute supported by the phy (see 4.6.7.1) and is defined in table 275.

Table 275 — ROUTING ATTRIBUTE field

Code	Name	Description
0h	Direct routing attribute	Direct routing method for attached end devices. Attached expander devices are not supported on this phy.
1h	Subtractive routing attribute	Either: a) subtractive routing method for attached expander devices; or b) direct routing method for attached end devices.
2h	Table routing attribute	Either: a) table routing method for attached expander devices; or b) direct routing method for attached end devices.
All others	Reserved	

The ROUTING ATTRIBUTE field shall not change based on the attached device type.

The CONNECTOR TYPE field indicates the type of connector used to access the phy, as reported by the enclosure services process for the enclosure (see the SAS Connector element in SES-2). A CONNECTOR TYPE field set to 00h indicates no connector information is available and that the CONNECTOR ELEMENT INDEX field and the CONNECTOR PHYSICAL LINK fields are **invalid** and shall be ignored.

The CONNECTOR ELEMENT INDEX field indicates the element index of the SAS Connector element representing the connector used to access the **phy, as** reported by the enclosure services process for the enclosure (see the SAS Connector element in SES-2).

The CONNECTOR PHYSICAL LINK field indicates the physical link in the connector used to access the **phy, as** reported by the enclosure services process for the enclosure (see the SAS Connector element in SES-2).

The ATTACHED DEVICE NAME field is defined as follows:

- a) if the attached phy is an expander phy, then the ATTACHED DEVICE NAME field contains the device name of the attached expander device (see 4.2.4);
- b) if the attached phy is a SAS phy, then the ATTACHED DEVICE NAME field contains the device name of the attached SAS device (see 4.2.7); or
- c) if the attached phy is a SATA device phy, then the ATTACHED DEVICE NAME field contains the world wide name of the SATA device (see 4.6.2) or 00000000 00000000h.

● Author: RElliott
Subject: Highlight
Date: 6/30/2008 6:16:52 PM
T ACCEPT - DONE (deleted. "shall be ignored" suffices)

invalid
s/b
different word to avoid keyword

● Author: wdc-mevans
Subject: Highlight
Date: 5/26/2008 12:32:05 PM

T REJECT

phy, as
s/b
phy as

● Author: wdc-mevans
Subject: Highlight
Date: 5/26/2008 12:32:12 PM

T REJECT

phy, as
s/b
phy as

For physical phys, table 276 defines how the ATTACHED DEVICE NAME field is updated.

Table 276 — ATTACHED DEVICE NAME field

Condition	Update time	Value
A SAS phy or expander phy is attached	Completion of the identification sequence	The management device server shall set this field to the DEVICE NAME field in the incoming IDENTIFY address frame (i.e., the attached expander device name or attached SAS device name (see 4.2.4))
A SATA phy is attached	Expiration of the COMSAS Detect Timeout timer (see 6.6.3)	The management device server shall set this field to 00000000 00000000h
	Reception of IDENTIFY (PACKET) DEVICE data from the SATA device ^a	Either: a) if IDENTIFY (PACKET) DEVICE data word 255 (i.e. the Integrity word) is correct and words 108-111 (i.e., the World Wide Name field) are not set to zero, the management device server shall set this field to the world wide name indicated by words 108-111 according to table 12 in 4.2.5; b) if IDENTIFY (PACKET) DEVICE data word 255 (i.e. the Integrity word) is correct and words 108-111 (i.e., the World Wide Name) are set to zero, the management device server shall set this field to 00000000 00000000h; or c) if IDENTIFY (PACKET) DEVICE data word 255 (i.e., the Integrity word) is not correct, the management device server shall set this field to 00000000 00000000h.
	Processing a PHY CONTROL function SET ATTACHED DEVICE NAME phy operation	The management device server shall set this field to the value specified in the ATTACHED DEVICE NAME field in the PHY CONTROL request (see 10.4.3.28).
^a This row only applies if the expander device originates the IDENTIFY (PACKET) DEVICE command.		

A REQUESTED INSIDE ZPSDS CHANGED BY EXPANDER bit set to one indicates that the zoning expander device set the REQUESTED INSIDE ZPSDS bit to zero in the zone phy information at the completion of the last link reset sequence. A REQUESTED INSIDE ZPSDS CHANGED BY EXPANDER bit set to zero indicates that the zoning expander device did not set the REQUESTED INSIDE ZPSDS bit to zero in the zone phy information at the completion of the last link reset sequence.

NOTE 118 - The zone manager may use the REQUESTED INSIDE ZPSDS CHANGED BY EXPANDER bit to determine why the REQUESTED INSIDE ZPSDS bit has changed in the DISCOVER response from the value to which it last set the bit.

The INSIDE ZPSDS PERSISTENT bit indicates the value of the INSIDE ZPSDS PERSISTENT bit in the zone phy information (see 4.9.3.1).

The REQUESTED INSIDE ZPSDS bit indicates the value of the REQUESTED INSIDE ZPSDS bit in the zone phy information (see 4.9.3.1).

The ZONE GROUP PERSISTENT bit indicates the value of the ZONE GROUP PERSISTENT bit in the zone phy information (see 4.9.3.1).

The INSIDE ZPSDS bit indicates the value of the INSIDE ZPSDS bit in the zone phy information (see 4.9.3.1).

A ZONING ENABLED bit set to one indicates that zoning is enabled in the expander device. A ZONING ENABLED bit set to zero indicates that zoning is disabled in the expander device.

● Author: Isi-bbesmer

Subject: Note

Date: 7/9/2008 11:15:16 AM



REJECT (for SAS, this follows the Attached SAS Address convention of preserving the previous value, only updating it when an identification sequence completes. For SATA, it is cleared each time (since the value doesn't show up in a nice IDENTIFY address frame). So, they are different. It might be more confusing to mention the "don't change" cases here while not mentioning them for other fields.)

Do we need to add what to report if nothing is attached?

● Author: RElliott

Subject: Highlight

Date: 6/30/2008 6:16:52 PM

T ACCEPT - DONE

the

s/b

then the

● Author: RElliott

Subject: Highlight

Date: 6/30/2008 6:16:52 PM

T ACCEPT - DONE

the

s/b

then the

● Author: RElliott

Subject: Highlight

Date: 6/30/2008 6:16:52 PM

T ACCEPT - DONE

the

s/b

then the

The ZONE GROUP field indicates the value of the ZONE GROUP field in the zone phy information (see 4.9.3.1).

The SELF-CONFIGURATION STATUS field indicates the status of a self-configuring expander device pertaining to the specified phy and is defined in table 277.

Table 277 — SELF-CONFIGURATION STATUS field

Code	Description
00h	No status available
01h - FFh	As defined for the STATUS TYPE field in the self-configuration status descriptor in the REPORT SELF-CONFIGURATION STATUS response (see table 253 in 10.4.3.6)

The SELF-CONFIGURATION LEVELS COMPLETED field indicates the number of levels of expander devices beyond the expander port containing the specified phy for which the self-configuring expander device's management application client has completed the discover process and is defined in table 278.

Table 278 — SELF-CONFIGURATION LEVELS COMPLETED field

Code	Description
00h	The management application client: a) has not begun the discover process through the expander port containing the specified phy; b) has not completed the discover process through the expander port containing the specified phy; or c) an expander device is not attached to the expander port containing the specified phy.
01h	The management application client has completed discovery of the expander device attached to the expander port containing the specified phy (i.e., level 1).
02h	The management application client has completed discovery of the expander devices attached to the expander device attached to the expander port containing the specified phy (i.e., level 2).
...	...
FFh	The management application client has completed discovery of the expander devices attached at level 255.

NOTE 119 - The self-configuration levels completed field does not reflect the level of externally configurable expander devices that the configuration subprocess updates to enable the discover process to proceed to higher levels.

The SELF-CONFIGURATION SAS ADDRESS field indicates the SAS address of the SMP target port to which the self-configuring expander device established a connection or attempted to establish a connection using the specified phy and resulted in the status indicated by the SELF-CONFIGURATION STATUS field.

The PROGRAMMED PHY CAPABILITIES field indicates the SNW-3 phy capabilities bits that are going to be transmitted in the next link reset sequence containing SNW-3 as defined in table 98 in 6.7.4.2.3.3.

The CURRENT PHY CAPABILITIES field indicates the outgoing SNW-3 phy capabilities bits transmitted in the last link reset sequence as defined in table 98 in 6.7.4.2.3.3. If the last link reset sequence did not include SNW-3 or was a SATA link reset sequence, the CURRENT PHY CAPABILITIES field shall be set to zero.

The ATTACHED PHY CAPABILITIES field indicates the incoming SNW-3 phy capabilities bits received in the last SNW-3 as defined in table 98 in 6.7.4.2.3.3. If the last link reset sequence did not include SNW-3 or was a SATA link reset sequence, the ATTACHED PHY CAPABILITIES field shall be set to zero.

The REASON field indicates the reason for the last reset of the phy. If the phy is a physical phy, the REASON field indicates the value of the REASON field transmitted in the IDENTIFY address frame (see 7.8.2) during the

● Author: wdc-mevans
Subject: Highlight
Date: 5/6/2008 4:07:50 PM
T REJECT

process and
s/b
process. The SELF-CONFIGURATION LEVELS COMPLETED field

● Author: RElliott
Subject: Highlight
Date: 6/30/2008 6:16:52 PM
T ACCEPT - DONE

SAS address

add "(see 4.2.4)" to support the new section

● Author: RElliott
Subject: Underline
Date: 6/30/2008 6:16:52 PM
T ACCEPT - DONE

zero
s/b
00000000h

● Author: RElliott
Subject: Highlight
Date: 6/30/2008 6:16:52 PM
T ACCEPT - DONE

the
s/b
then the

● Author: RElliott
Subject: Underline
Date: 6/30/2008 6:16:52 PM
T ACCEPT - DONE

zero
s/b
00000000h

● Author: RElliott
Subject: Highlight
Date: 6/30/2008 6:16:52 PM
T ACCEPT - DONE

the
s/b
then the

● Author: RElliott
Subject: Highlight
Date: 6/30/2008 6:16:52 PM
T ACCEPT - DONE

the

The ZONE GROUP field indicates the value of the ZONE GROUP field in the zone phy information (see 4.9.3.1).

The SELF-CONFIGURATION STATUS field indicates the status of a self-configuring expander device pertaining to the specified phy and is defined in table 277.

Table 277 — SELF-CONFIGURATION STATUS field

Code	Description
00h	No status available
01h - FFh	As defined for the STATUS TYPE field in the self-configuration status descriptor in the REPORT SELF-CONFIGURATION STATUS response (see table 253 in 10.4.3.6)

The SELF-CONFIGURATION LEVELS COMPLETED field indicates the number of levels of expander devices beyond the expander port containing the specified phy for which the self-configuring expander device's management application client has completed the discover process and is defined in table 278.

Table 278 — SELF-CONFIGURATION LEVELS COMPLETED field

Code	Description
00h	The management application client: <ul style="list-style-type: none"> a) has not begun the discover process through the expander port containing the specified phy; b) has not completed the discover process through the expander port containing the specified phy; or c) an expander device is not attached to the expander port containing the specified phy.
01h	The management application client has completed discovery of the expander device attached to the expander port containing the specified phy (i.e., level 1).
02h	The management application client has completed discovery of the expander devices attached to the expander device attached to the expander port containing the specified phy (i.e., level 2).
...	...
FFh	The management application client has completed discovery of the expander devices attached at level 255.

NOTE 119 - The self-configuration levels completed field does not reflect the level of externally configurable expander devices that the configuration subprocess updates to enable the discover process to proceed to higher levels.

The SELF-CONFIGURATION SAS ADDRESS field indicates the SAS address of the SMP target port to which the self-configuring expander device established a connection or attempted to establish a connection using the specified phy and resulted in the status indicated by the SELF-CONFIGURATION STATUS field.

The PROGRAMMED PHY CAPABILITIES field indicates the SNW-3 phy capabilities bits that are going to be transmitted in the next link reset sequence containing SNW-3 as defined in table 98 in 6.7.4.2.3.3.

The CURRENT PHY CAPABILITIES field indicates the outgoing SNW-3 phy capabilities bits transmitted in the last link reset sequence as defined in table 98 in 6.7.4.2.3.3. If the last link reset sequence did not include SNW-3 or was a SATA link reset sequence, the CURRENT PHY CAPABILITIES field shall be set to zero.

The ATTACHED PHY CAPABILITIES field indicates the incoming SNW-3 phy capabilities bits received in the last SNW-3 as defined in table 98 in 6.7.4.2.3.3. If the last link reset sequence did not include SNW-3 or was a SATA link reset sequence, the ATTACHED PHY CAPABILITIES field shall be set to zero.

The REASON field indicates the reason for the last reset of the phy. If the phy is a physical phy, the REASON field indicates the value of the REASON field transmitted in the IDENTIFY address frame (see 7.8.2) during the

s/b
then the

identification sequence. If the phy is a physical phy and a SATA phy is attached, the REASON field indicates the reason for the link reset sequence (see 7.8.2).

A NEGOTIATED SSC field set to one indicates that SSC is enabled (see 5.3.8). A NEGOTIATED SSC field set to zero indicates that SSC is disabled. The NEGOTIATED SSC field is only valid when the NEGOTIATED PHYSICAL LINK RATE field is greater than or equal to 8h.

The NEGOTIATED PHYSICAL LINK RATE field is defined in table 279. If the phy is a physical phy, this field indicates the physical link rate negotiated during the link reset sequence. If the phy is a virtual phy, this field should be set to the maximum physical link rate supported by the expander device. The negotiated physical link rate may be less than the programmed minimum physical link rate or greater than the programmed maximum physical link rate if the programmed physical link rates have been changed since the last link reset sequence.

Table 279 — NEGOTIATED PHYSICAL LINK RATE field

SP state machine ResetStatus state machine variable	Code	Description
UNKNOWN	0h	Phy is enabled; unknown physical link rate. ^a
DISABLED	1h	Phy is disabled.
PHY_RESET_PROBLEM	2h	Phy is enabled; a phy reset problem occurred (see 6.7.4.2.4).
SPINUP_HOLD	3h	Phy is enabled; detected a SATA device and entered the SATA spinup hold state. The SMP PHY CONTROL function (see 10.4.3.28) phy operations of LINK RESET and HARD RESET may be used to release the phy.
PORT_SELECTOR	4h	Phy is enabled; detected a SATA port selector. The physical link rate has not been negotiated since the last time the phy's SP state machine entered the SP0:OOB_COMINIT state. The SATA spinup hold state has not been entered since the last time the phy's SP state machine entered the SP0:OOB_COMINIT state. The value in this field may change to 3h, 8h, 9h, or Ah if attached to the active phy of the SATA port selector. Presence of a SATA port selector is indicated by the ATTACHED SATA PORT SELECTOR bit (see table 272).
RESET_IN_PROGRESS	5h	Phy is enabled; the expander phy is performing an SMP PHY CONTROL function (see 10.4.3.28) phy operation of LINK RESET or HARD RESET. This value is returned if the specified phy contained a value of 8h, 9h, or Ah in this field when an SMP PHY CONTROL function phy operation of LINK RESET or HARD RESET phy operation is processed.
UNSUPPORTED_PHY_ATTACHED	6h	Phy is enabled; a phy is attached without any commonly supported settings.
Reserved	7h	Reserved
G1	8h	Phy is enabled; 1.5 Gbps physical link rate.
G2	9h	Phy is enabled; 3 Gbps physical link rate.
G3	Ah	Phy is enabled; 6 Gbps physical link rate.
Reserved	Bh - Fh	Phy is enabled; reserved for future logical or physical link rates.

^a This code may be used by an application client in its local data structures to indicate an unknown negotiated logical or physical link rate (e.g., before the discover process has queried the phy).

● Author: RElliott
Subject: Highlight
Date: 6/30/2008 6:16:52 PM
T ACCEPT - DONE
the
s/b
then the

● Author: RElliott
Subject: Highlight
Date: 6/30/2008 6:16:52 PM
T ACCEPT - DONE
NEGOTIATED SSC field
s/b
NEGOTIATED SSC bit

● Author: RElliott
Subject: Highlight
Date: 6/30/2008 6:16:52 PM
T ACCEPT - DONE
NEGOTIATED SSC field
s/b
NEGOTIATED SSC bit

● Author: RElliott
Subject: Highlight
Date: 6/30/2008 6:16:52 PM
T ACCEPT - DONE
NEGOTIATED SSC field
s/b
NEGOTIATED SSC bit

● Author: lsi-bday
Subject: Highlight
Date: 8/28/2008 2:31:56 PM
T ACCEPT - DONE (7/9 yes. SATA is not conclusive until COMWAKE exchange. At this point, only a COMSAS timeout has occurred.)
detected a SATA device
suggest:
did not detect as SAS device

A **HARDWARE MUXING SUPPORTED** bit set to one indicates that the phy supports multiplexing (see 6.10). A **HARDWARE MUXING SUPPORTED** bit set to zero indicates that the phy does not support multiplexing. This value is not adjusted based on the negotiated physical link rate.

The **DEFAULT INSIDE ZPSDS PERSISTENT** bit contains the default value of the **INSIDE ZPSDS PERSISTENT** bit in the zone phy information (see 4.9.3.1).

The **DEFAULT REQUESTED INSIDE ZPSDS** bit contains the default value of the **REQUESTED INSIDE ZPSDS** bit in the zone phy information (see 4.9.3.1).

The **DEFAULT ZONE GROUP PERSISTENT** bit contains the default value of the **ZONE GROUP PERSISTENT** bit in the zone phy information (see 4.9.3.1).

The **DEFAULT ZONING ENABLED** bit contains the default value of the **ZONING ENABLED** bit (see 4.9.3.1).

The **DEFAULT ZONE GROUP** field contains the default value of the **ZONE GROUP** field in the zone phy information (see 4.9.3.1).

The **SAVED INSIDE ZPSDS PERSISTENT** bit contains the saved value of the **INSIDE ZPSDS PERSISTENT** bit in the zone phy information (see 4.9.3.1).

The **SAVED REQUESTED INSIDE ZPSDS** bit contains the saved value of the **REQUESTED INSIDE ZPSDS** bit in the zone phy information (see 4.9.3.1).

The **SAVED ZONE GROUP PERSISTENT** bit contains the saved value of the **ZONE GROUP PERSISTENT** bit in the zone phy information (see 4.9.3.1).

The **SAVED ZONING ENABLED** bit contains the saved value of the **ZONING ENABLED** bit (see 4.9.3.1).

The **SAVED ZONE GROUP** field contains the saved value of the **ZONE GROUP** field in the zone phy information (see 4.9.3.1).

The **SHADOW INSIDE ZPSDS PERSISTENT** bit contains the shadow value of the **INSIDE ZPSDS PERSISTENT** bit in the zone phy information (see 4.9.3.1).

The **SHADOW REQUESTED INSIDE ZPSDS** bit contains the shadow value of the **REQUESTED INSIDE ZPSDS** bit in the zone phy information (see 4.9.3.1).

The **SHADOW ZONE GROUP PERSISTENT** bit contains the shadow value of the **ZONE GROUP PERSISTENT** bit in the zone phy information (see 4.9.3.1).

The **SHADOW ZONING ENABLED** bit contains the shadow value of the **ZONING ENABLED** bit (see 4.9.3.1).

The **SHADOW ZONE GROUP** field contains the shadow value of the **ZONE GROUP** field in the zone phy information (see 4.9.3.1).

The **CRC** field is defined in 10.4.3.3.8.

10.4.3.11 REPORT PHY ERROR LOG function

The **REPORT PHY ERROR LOG** function returns error logging information about the specified phy. This SMP function may be implemented by any management device server.

This page contains no comments

Table 280 defines the request format.

Table 280 — REPORT PHY ERROR LOG request

Byte\Bit	7	6	5	4	3	2	1	0	
0	SMP FRAME TYPE (40h)								
1	FUNCTION (11h)								
2	ALLOCATED RESPONSE LENGTH								
3	REQUEST LENGTH (00h or 02h)								
4	Reserved								
8	Reserved								
9	PHY IDENTIFIER								
10	Reserved								
11	Reserved								
12	(MSB)	CRC							
15								(LSB)	

The SMP FRAME TYPE field is defined in 10.4.3.2.2 and shall be set to the value defined in table 280.

The FUNCTION field is defined in 10.4.3.2.3 and shall be set to the value defined in table 280.

The ALLOCATED RESPONSE LENGTH field is defined in 10.4.3.2.4.

If the ALLOCATED RESPONSE LENGTH field is set to 00h, then the management device server shall:

- a) set the RESPONSE LENGTH field to 00h in the response frame; and
- b) return the first 28 bytes defined in table 281 plus the CRC field as the response frame.

If the ALLOCATED RESPONSE LENGTH field is not set to 00h, then the management device server shall:

- a) set the RESPONSE LENGTH field in the response frame to the non-zero value defined in table 281; and
- b) return the response frame as specified by the ALLOCATED RESPONSE LENGTH field.

The REQUEST LENGTH field is defined in 10.4.3.2.5 and shall be set to the one of the values defined in table 280 based on the LONG RESPONSE bit in the REPORT GENERAL response (see 10.4.3.4). A REQUEST LENGTH field set to 00h specifies that there are 2 dwords before the CRC field.

The PHY IDENTIFIER field specifies the phy (see 4.2.8) for which information shall be reported.

The CRC field is defined in 10.4.3.2.8.

This page contains no comments

Table 281 defines the response format.

Table 281 — REPORT PHY ERROR LOG response

Byte\Bit	7	6	5	4	3	2	1	0
0	SMP FRAME TYPE (41h)							
1	FUNCTION (11h)							
2	FUNCTION RESULT							
3	RESPONSE LENGTH (00h or 06h)							
4	(MSB)	EXPANDER CHANGE COUNT						(LSB)
5								
6	Reserved							
8								
9	PHY IDENTIFIER							
10	Reserved							
11								
12	(MSB)	INVALID DWORD COUNT						(LSB)
15								
16	(MSB)	RUNNING DISPARITY ERROR COUNT						(LSB)
19								
20	(MSB)	LOSS OF DWORD SYNCHRONIZATION COUNT						(LSB)
23								
24	(MSB)	PHY RESET PROBLEM COUNT						(LSB)
27								
28	(MSB)	CRC						(LSB)
31								

The SMP FRAME TYPE field is defined in 10.4.3.3.2 and shall be set to the value defined in table 281.

The FUNCTION field is defined in 10.4.3.3.3 and shall be set to the value defined in table 281.

The FUNCTION RESULT field is defined in 10.4.3.3.4.

The RESPONSE LENGTH field is defined in 10.4.3.3.5 and shall be set to one of the values defined in table 281 based on the ALLOCATED RESPONSE LENGTH field in the request frame.

The EXPANDER CHANGE COUNT field is defined in the SMP REPORT GENERAL response (see 10.4.3.4).

The PHY IDENTIFIER field indicates the phy (see 4.2.8) for which information is being reported.

The INVALID DWORD COUNT field indicates the number of invalid dwords (see 3.1.114) that have been received outside of phy reset sequences (i.e., between when the SP state machine (see 6.8) sends a Phy Layer Ready

Author: RElliott
Subject: Highlight
Date: 6/30/2008 6:16:52 PM
ACCEPT - DONE

after
reported.

add
and is the same as the phy identifier field in the request frame.

(SAS) confirmation or Phy Layer Ready (SATA) confirmation and when it sends a Phy Layer Not Ready confirmation to the link layer). The count shall stop at the maximum value. The INVALID DWORD COUNT field is set to a vendor-specific value after power on.

The RUNNING DISPARITY ERROR COUNT field indicates the number of dwords containing running disparity errors (see 6.2) that have been received outside of phy reset sequences. The count shall stop at the maximum value. The RUNNING DISPARITY ERROR COUNT field is set to a vendor-specific value after power on.

The LOSS OF DWORD SYNCHRONIZATION COUNT field indicates the number of times the phy has restarted the link reset sequence because it lost dword synchronization (see 6.9) (i.e., the SP state machine transitioned from SP15:SAS_PHY_Ready or SP22:SATA_PHY_Ready to SP0:OOB_COMINIT (see 6.8)). The count shall stop at the maximum value. The LOSS OF DWORD SYNCHRONIZATION COUNT field is set to a vendor-specific value after power on.

The PHY RESET PROBLEM COUNT field indicates the number of times a phy reset problem (see 6.7.4.2.4) occurred. The count shall stop at the maximum value. The PHY RESET PROBLEM COUNT field is set to a vendor-specific value after power on.

The CRC field is defined in 10.4.3.3.8.

10.4.3.12 REPORT PHY SATA function

The REPORT PHY SATA function returns information about the SATA state for a specified phy. This SMP function shall be implemented by management device servers behind SMP target ports that share SAS addresses with STP target ports and by management device servers in expander devices with STP/SATA bridges. This SMP function shall not be implemented by any other type of management device server.

Table 282 defines the request format.

Table 282 — REPORT PHY SATA request

Byte/Bit	7	6	5	4	3	2	1	0	
0	SMP FRAME TYPE (40h)								
1	FUNCTION (12h)								
2	ALLOCATED RESPONSE LENGTH								
3	REQUEST LENGTH (00h or 02h)								
4	Reserved								
8	Reserved								
9	PHY IDENTIFIER								
10	AFFILIATION CONTEXT								
11	Reserved								
12	(MSB)	CRC							
15								(LSB)	

The SMP FRAME TYPE field is defined in 10.4.3.2.2 and shall be set to the value defined in table 282.

The FUNCTION field is defined in 10.4.3.2.3 and shall be set to the value defined in table 282.

The ALLOCATED RESPONSE LENGTH field is defined in 10.4.3.2.4.

● Author: RElliott
Subject: Highlight
Date: 6/30/2008 6:16:52 PM
T ACCEPT - DONE

(see 6.2) that

point to new RD section

If the ALLOCATED RESPONSE LENGTH field is set to 00h, then the management device server shall:

- a) set the RESPONSE LENGTH field to 00h in the response frame; and
- b) return the first 56 bytes defined in table 283 plus the CRC field as the response frame.

If the ALLOCATED RESPONSE LENGTH field is not set to 00h, then the management device server shall:

- a) set the RESPONSE LENGTH field in the response frame to the non-zero value defined in table 283; and
- b) return the response frame as specified by the ALLOCATED RESPONSE LENGTH field.

The REQUEST LENGTH field is defined in 10.4.3.2.5 and shall be set to one of the values defined in table 282 based on the LONG RESPONSE bit in the REPORT GENERAL response (see 10.4.3.4). A REQUEST LENGTH field set to 00h specifies that there are 2 dwords before the CRC field.

The PHY IDENTIFIER field specifies the phy (see 4.2.8) for which information shall be reported.

The AFFILIATION CONTEXT field specifies the relative identifier of the affiliation context for which information shall be reported (see 7.17.4).

The CRC field is defined in 10.4.3.2.8.

Table 283 defines the response format.

Table 283 — REPORT PHY SATA response (part 1 of 2)

Byte\Bit	7	6	5	4	3	2	1	0	
0	SMP FRAME TYPE (41h)								
1	FUNCTION (12h)								
2	FUNCTION RESULT								
3	RESPONSE LENGTH (00h or 10h)								
4	(MSB) EXPANDER CHANGE COUNT (LSB)								
5									
6	Reserved								
8									
9	PHY IDENTIFIER								
10	Reserved								
11	Reserved					STP I_T NEXUS LOSS OCCURRED	AFFILIATIONS SUPPORTED	AFFILIATION VALID	
12	Reserved								
15									
16	STP SAS ADDRESS								
23									
24	REGISTER DEVICE TO HOST FIS								
43									

This page contains no comments

Table 283 — REPORT PHY SATA response (part 2 of 2)

Byte/Bit	7	6	5	4	3	2	1	0	
44	Reserved								
47	Reserved								
48	AFFILIATED STP INITIATOR SAS ADDRESS								
55	AFFILIATED STP INITIATOR SAS ADDRESS								
56	STP I_T NEXUS LOSS SAS ADDRESS								
63	STP I_T NEXUS LOSS SAS ADDRESS								
64	Reserved								
65	AFFILIATION CONTEXT								
66	CURRENT AFFILIATION CONTEXTS								
67	MAXIMUM AFFILIATION CONTEXTS								
68	(MSB)	CRC							
71								(LSB)	

The SMP FRAME TYPE field is defined in 10.4.3.3.2 and shall be set to the value defined in table 283.

The FUNCTION field is defined in 10.4.3.3.3 and shall be set to the value defined in table 283.

The FUNCTION RESULT field is defined in 10.4.3.3.4.

The RESPONSE LENGTH field is defined in 10.4.3.3.5 and shall be set to one of the values defined in table 283 based on the ALLOCATED RESPONSE LENGTH field in the request frame.

The EXPANDER CHANGE COUNT field is defined in the SMP REPORT GENERAL response (see 10.4.3.4).

The PHY IDENTIFIER field indicates the phy (see 4.2.8) for which information is being reported and is the same as the PHY IDENTIFIER field in the request frame.

An STP I_T NEXUS LOSS OCCURRED bit set to one indicates that the STP target port encountered an I_T nexus loss in the specified affiliation context for the STP initiator port whose SAS address is indicated in the STP I_T NEXUS LOSS SAS ADDRESS field. An STP I_T NEXUS LOSS OCCURRED bit set to zero indicates that:

- a) an I_T nexus loss has not occurred in the specified affiliation context;
- b) an I_T nexus loss has occurred in the specified affiliation context and been cleared by the SMP PHY CONTROL function CLEAR STP I_T NEXUS LOSS phy operation (see table 333 in 10.4.3.28); or
- c) the STP target port has successfully established a connection with the indicated STP initiator port in the specified affiliation context.

An AFFILIATIONS SUPPORTED bit set to one indicates that the specified affiliation context is supported by the STP target port containing the specified phy. An AFFILIATIONS SUPPORTED bit set to zero indicates that the specified affiliation context is not supported by the STP target port containing the specified phy.

An AFFILIATION VALID bit set to one indicates that the STP target port is currently maintaining an affiliation in the specified affiliation context and the AFFILIATED STP INITIATOR SAS ADDRESS field is valid. An AFFILIATION VALID bit set to zero indicates that the STP target port is not currently maintaining an affiliation in the specified affiliation context and the AFFILIATED STP INITIATOR SAS ADDRESS field is not valid.

The STP SAS ADDRESS field indicates the SAS address (see 4.2.2) of the STP target port that contains the specified phy.

Author: RElliott
Subject: Highlight
Date: 6/30/2008 6:16:52 PM
ACCEPT - DONE

SAS address (see 4.2.2)

point to new 4.2.4

The REGISTER DEVICE TO HOST FIS field indicates the contents of the initial Register - Device to Host FIS. For an STP/SATA bridge, this is delivered by the attached SATA device after a link reset sequence (see SATA-2). For a native STP target port in an end device, this is directly provided.

The FIS contents shall be stored with little-endian byte ordering (i.e., the first byte, byte 24, contains the FIS Type).

For an STP/SATA bridge, the first byte of the field (i.e., the FIS Type) shall be initialized to zero on power on and whenever the phy has restarted the link reset sequence after losing dword synchronization (see 6.9) (i.e., the SP state machine transitioned from SP22:SATA_PHY_Ready to SP0:OOB_COMINIT (see 6.8)) to indicate the field is invalid and the attached SATA device has not delivered a Register - Device to Host FIS. The first byte of the field shall be set to 34h when the attached SATA device has delivered the initial Register - Device to Host FIS. The remaining contents of the REGISTER DEVICE TO HOST FIS field shall remain constant until a link reset sequence causes the attached SATA device to deliver another initial Register - Device to Host FIS.

If the AFFILIATION VALID bit is set to one, the AFFILIATED STP INITIATOR SAS ADDRESS field indicates the SAS address (see 4.2.2) of the STP initiator port that has an affiliation in the specified affiliation context with the STP target port that contains the specified phy. If the AFFILIATION VALID bit is set to zero, the AFFILIATED STP INITIATOR SAS ADDRESS field may contain the SAS address of the STP initiator port that previously had an affiliation in the specified affiliation context with the STP target port that contains the specified phy.

The STP I_T NEXUS LOSS SAS ADDRESS field indicates the SAS address (see 4.2.2) of the last STP initiator port for which the STP target port experienced an I_T nexus loss (see 4.5) in the specified affiliation context.

The AFFILIATION CONTEXT field indicates the relative identifier of the affiliation context for which affiliation-related information (i.e., the AFFILIATIONS SUPPORTED bit, the AFFILIATION VALID bit, the AFFILIATED STP INITIATOR SAS ADDRESS field, the STP I_T NEXUS LOSS OCCURRED bit, and the STP I_T NEXUS LOSS SAS ADDRESS field) is being reported (see 7.17.4) and is the same as the AFFILIATION CONTEXT field in the request frame.

The CURRENT AFFILIATION CONTEXTS field indicates the current number of affiliations established by the STP target port.

The MAXIMUM AFFILIATION CONTEXTS field indicates the maximum number of affiliation contexts supported by the STP target port.

The CRC field is defined in 10.4.3.3.8.

10.4.3.13 REPORT ROUTE INFORMATION function

The REPORT ROUTE INFORMATION function returns an expander route entry from a phy-based expander route table within an expander device (see 4.6.7.3). This SMP function shall be supported by management device servers in expander devices if the EXPANDER ROUTE INDEXES field is set to a non-zero value in the SMP REPORT GENERAL response (see 10.4.3.4). This SMP function may be used as a diagnostic tool to resolve topology issues.

Page: 610

● Author: wdc-mevans
Subject: Highlight
Date: 5/6/2008 4:07:50 PM
T ACCEPT - DONE

(i.e., the first byte, byte 24, contains the FIS Type)
s/b
(e.g., the first byte of the field (i.e., byte 24) contains the FIS Type)

● Author: RElliott
Subject: Highlight
Date: 9/1/2008 7:07:05 PM
T ACCEPT - DONE

initialized to zero
s/b
set to 00h

● Author: RElliott
Subject: Highlight
Date: 8/31/2008 5:38:58 PM
T ACCEPT - DONE

the field is invalid and the attached SATA device has not delivered a Register – Device to Host FIS
s/b
that the register device to host fis field does not contain the Register - Device to Host FIS contents of the currently attached SATA device

to avoid misusing the "invalid" keyword

● Author: RElliott
Subject: Highlight
Date: 6/30/2008 6:16:52 PM
T ACCEPT - DONE
the
s/b
then the

● Author: RElliott
Subject: Highlight
Date: 6/30/2008 6:16:52 PM
T ACCEPT - DONE

SAS address (see 4.2.2)

point to new 4.2.4

● Author: RElliott
Subject: Highlight
Date: 6/30/2008 6:16:52 PM
T ACCEPT - DONE
the
s/b
then the

● Author: RElliott
Subject: Highlight
Date: 6/30/2008 6:16:52 PM

The REGISTER DEVICE TO HOST FIS field indicates the contents of the initial Register - Device to Host FIS. For an STP/SATA bridge, this is delivered by the attached SATA device after a link reset sequence (see SATA-2). For a native STP target port in an end device, this is directly provided.

The FIS contents shall be stored with little-endian byte ordering (i.e., the first byte, byte 24, contains the FIS Type).

For an STP/SATA bridge, the first byte of the field (i.e., the FIS Type) shall be initialized to zero on power on and whenever the phy has restarted the link reset sequence after losing dword synchronization (see 6.9)(i.e., the SP state machine transitioned from SP22:SATA_PHY_Ready to SP0:OOB_COMINIT (see 6.8)) to indicate the field is invalid and the attached SATA device has not delivered a Register – Device to Host FIS. The first byte of the field shall be set to 34h when the attached SATA device has delivered the initial Register – Device to Host FIS. The remaining contents of the REGISTER DEVICE TO HOST FIS field shall remain constant until a link reset sequence causes the attached SATA device to deliver another initial Register – Device to Host FIS.

If the AFFILIATION VALID bit is set to one, the AFFILIATED STP INITIATOR SAS ADDRESS field indicates the SAS address (see 4.2.2) of the STP initiator port that has an affiliation in the specified affiliation context with the STP target port that contains the specified phy. If the AFFILIATION VALID bit is set to zero, the AFFILIATED STP INITIATOR SAS ADDRESS field may contain the SAS address of the STP initiator port that previously had an affiliation in the specified affiliation context with the STP target port that contains the specified phy.

The STP I_T NEXUS LOSS SAS ADDRESS field indicates the SAS address (see 4.2.2) of the last STP initiator port for which the STP target port experienced an I_T nexus loss (see 4.5) in the specified affiliation context.

The AFFILIATION CONTEXT field indicates the relative identifier of the affiliation context for which affiliation-related information (i.e., the AFFILIATIONS SUPPORTED bit, the AFFILIATION VALID bit, the AFFILIATED STP INITIATOR SAS ADDRESS field, the STP I_T NEXUS LOSS OCCURRED bit, and the STP I_T NEXUS LOSS SAS ADDRESS field) is being reported (see 7.17.4) and is the same as the AFFILIATION CONTEXT field in the request frame.

The CURRENT AFFILIATION CONTEXTS field indicates the current number of affiliations established by the STP target port.

The MAXIMUM AFFILIATION CONTEXTS field indicates the maximum number of affiliation contexts supported by the STP target port.

The CRC field is defined in 10.4.3.3.8.

10.4.3.13 REPORT ROUTE INFORMATION function

The REPORT ROUTE INFORMATION function returns an expander route entry from a phy-based expander route table within an expander device (see 4.6.7.3). This SMP function shall be supported by management device servers in expander devices if the EXPANDER ROUTE INDEXES field is set to a non-zero value in the SMP REPORT GENERAL response (see 10.4.3.4). This SMP function may be used as a diagnostic tool to resolve topology issues.

T ACCEPT - DONE

SAS address (see 4.2.2)

point to new 4.2.4

Table 284 defines the request format.

Table 284 — REPORT ROUTE INFORMATION request

Byte\Bit	7	6	5	4	3	2	1	0	
0	SMP FRAME TYPE (40h)								
1	FUNCTION (13h)								
2	ALLOCATED RESPONSE LENGTH								
3	REQUEST LENGTH (00h or 02h)								
4	Reserved								
5	Reserved								
6	(MSB)	EXPANDER ROUTE INDEX							
7							(LSB)		
8	Reserved								
9	PHY IDENTIFIER								
10	Reserved								
11	Reserved								
12	(MSB)	CRC							
15							(LSB)		

The SMP FRAME TYPE field is defined in 10.4.3.2.2 and shall be set to the value defined in table 284.

The FUNCTION field is defined in 10.4.3.2.3 and shall be set to the value defined in table 284.

The ALLOCATED RESPONSE LENGTH field is defined in 10.4.3.2.4.

If the ALLOCATED RESPONSE LENGTH field is set to 00h, then the management device server shall:

- a) set the RESPONSE LENGTH field to 00h in the response frame; and
- b) return the first 40 bytes defined in table 285 plus the CRC field as the response frame.

If the ALLOCATED RESPONSE LENGTH field is not set to 00h, then the management device server shall:

- a) set the RESPONSE LENGTH field in the response frame to the non-zero value defined in table 285; and
- b) return the response frame as specified by the ALLOCATED RESPONSE LENGTH field.

The REQUEST LENGTH field is defined in 10.4.3.2.5 and shall be set to one of the values defined in table 284 based on the LONG RESPONSE bit in the REPORT GENERAL response (see 10.4.3.4). A REQUEST LENGTH field set to 00h specifies that there are 2 dwords before the CRC field.

The EXPANDER ROUTE INDEX field specifies the expander route index for the expander route entry being requested (see 4.6.7.3).

The PHY IDENTIFIER field specifies the phy for which the expander route entry is being requested.

The CRC field is defined in 10.4.3.2.8.

This page contains no comments

Table 285 defines the response format.

Table 285 — REPORT ROUTE INFORMATION response

Byte\Bit	7	6	5	4	3	2	1	0
0	SMP FRAME TYPE (41h)							
1	FUNCTION (13h)							
2	FUNCTION RESULT							
3	RESPONSE LENGTH (00h or 09h)							
4	(MSB)	EXPANDER CHANGE COUNT						(LSB)
5								
6	(MSB)	EXPANDER ROUTE INDEX						(LSB)
7								
8	Reserved							
9	PHY IDENTIFIER							
10	Reserved							
11								
12	EXPANDER ROUTE ENTRY DISABLED	Reserved						
13	Reserved							
15								
16	ROUTED SAS ADDRESS							
23								
24	Reserved							
39								
40	(MSB)	CRC						(LSB)
43								

The SMP FRAME TYPE field is defined in 10.4.3.3.2 and shall be set to the value defined in table 285.

The FUNCTION field is defined in 10.4.3.3.3 and shall be set to the value defined in table 285.

The FUNCTION RESULT field is defined in 10.4.3.3.4.

The RESPONSE LENGTH field is defined in 10.4.3.3.5 and shall be set to one of the values defined in table 285 based on the ALLOCATED RESPONSE LENGTH field in the request frame.

The EXPANDER CHANGE COUNT field is defined in the SMP REPORT GENERAL response (see 10.4.3.4).

This page contains no comments

The EXPANDER ROUTE INDEX field indicates the expander route index for the expander route entry being returned (see 4.6.7.3).

The PHY IDENTIFIER field indicates the phy identifier for the expander route entry being returned.

The EXPANDER ROUTE ENTRY DISABLED bit indicates whether the ECM shall use the expander route entry to route connection requests (see 4.6.7.3). If the EXPANDER ROUTE ENTRY DISABLED bit is set to zero, then the ECM shall use the expander route entry to route connection requests. If the EXPANDER ROUTE ENTRY DISABLED bit is set to one, the ECM shall not use the expander route entry to route connection requests.

The ROUTED SAS ADDRESS field indicates the SAS address in the expander route entry (see 4.6.7.3).

The CRC field is defined in 10.4.3.3.8.

10.4.3.14 REPORT PHY EVENT function

10.4.3.14.1 REPORT PHY EVENT function overview

The REPORT PHY EVENT function returns phy events (see 4.11) concerning the specified phy. This SMP function may be implemented by any management device server.

NOTE 120 - The REPORT PHY EVENT LIST function (see 10.4.3.16) returns information about one or more phys.

10.4.3.14.2 REPORT PHY EVENT request

Table 286 defines the request format.

Table 286 — REPORT PHY EVENT request

Byte\Bit	7	6	5	4	3	2	1	0	
0	SMP FRAME TYPE (40h)								
1	FUNCTION (14h)								
2	ALLOCATED RESPONSE LENGTH								
3	REQUEST LENGTH (02h)								
4	Reserved								
5	Reserved								
8	Reserved								
9	PHY IDENTIFIER								
10	Reserved								
11	Reserved								
12	(MSB)	CRC							
15							(LSB)		

The SMP FRAME TYPE field is defined in 10.4.3.2.2 and shall be set to the value defined in table 286.

The FUNCTION field is defined in 10.4.3.2.3 and shall be set to the value defined in table 286.

The ALLOCATED RESPONSE LENGTH field is defined in 10.4.3.2.4.

The REQUEST LENGTH field is defined in 10.4.3.2.5 and shall be set to the value defined in table 286.

Page: 613

● Author: RElliott
Subject: Highlight
Date: 6/30/2008 6:16:52 PM
T ACCEPT - DONE

after
returned.

add
and is the same as the phy identifier field in the request frame.

● Author: wdc-mevans
Subject: Highlight
Date: 5/6/2008 4:07:50 PM

T REJECT (According to m-w.com, "whether" is for an "indirect question involving stated or implied alternatives" while "whether or not" means "in any case". Here, the two alternatives (bit set to 0 and bit set to 1) are both stated in the rest of the paragraph, so it seems more appropriate to forgo the "or not" phrase.

http://www.pearsonlongman.com/ae/azar/grammar_ex/message_board/archive/articles/00095.htm also describes the NY Times style guidelines.)

whether
s/b
whether or not

● Author: RElliott
Subject: Highlight
Date: 6/30/2008 6:16:52 PM

T ACCEPT - DONE
the
s/b
then the

● Author: RElliott
Subject: Highlight
Date: 6/30/2008 6:16:52 PM

T ACCEPT - DONE

SAS address

add "(see 4.2.4)" to support the new section

The PHY IDENTIFIER field specifies the phy (see 4.2.7) for which information shall be reported.

The CRC field is defined in 10.4.3.2.8.

10.4.3.14.3 REPORT PHY EVENT response

Table 287 defines the response format.

Table 287 — REPORT PHY EVENT response

Byte/Bit	7	6	5	4	3	2	1	0
0	SMP FRAME TYPE (41h)							
1	FUNCTION (14h)							
2	FUNCTION RESULT							
3	RESPONSE LENGTH $((n - 7) / 4)$							
4	(MSB)	EXPANDER CHANGE COUNT						(LSB)
5								
6	Reserved							
8								
9	PHY IDENTIFIER							
10	Reserved							
14								
15	NUMBER OF PHY EVENT DESCRIPTORS							
Phy event descriptor list								
16	Phy event descriptor (first)(see table 288 in 10.4.3.14.4)							
27								
...	...							
n - 15	Phy event descriptor (last)(see table 288 in 10.4.3.14.4)							
n - 4								
n - 3	(MSB)	CRC						(LSB)
n								

The SMP FRAME TYPE field is defined in 10.4.3.3.2 and shall be set to the value defined in table 287.

The FUNCTION field is defined in 10.4.3.3.3 and shall be set to the value defined in table 287.

The FUNCTION RESULT field is defined in 10.4.3.3.4.

The RESPONSE LENGTH field is defined in 10.4.3.3.5 and shall be set to the value defined in table 287. A RESPONSE LENGTH field set to 00h does not have a special meaning based on the ALLOCATED RESPONSE LENGTH field in the request frame.

The EXPANDER CHANGE COUNT field is defined in the SMP REPORT GENERAL response (see 10.4.3.4).

● Author: elx-bmartin
Subject: Comment on Text
Date: 5/6/2008 4:07:50 PM

 ACCEPT - DONE

This reference should be 4.2.8

● Author: RElliott
Subject: Note
Date: 6/30/2008 6:16:52 PM

 ACCEPT - DONE

Per 6/11 LB call, change byte 14 to a Phy Event Descriptor Length field

The PHY IDENTIFIER field indicates the phy (see 4.2.7) for which information is being reported.

The NUMBER OF PHY EVENT DESCRIPTORS field indicates how many phy event descriptors follow.

The phy event descriptor list contains phy event descriptors as defined in 10.4.3.14.4.

The CRC field is defined in 10.4.3.3.8.

10.4.3.14.4 REPORT PHY EVENT response phy event descriptor

Table 288 defines the phy event descriptor.

Table 288 — Phy event descriptor

Byte/Bit	7	6	5	4	3	2	1	0	
0	Reserved								
2	Reserved								
3	PHY EVENT SOURCE								
4	(MSB)	PHY EVENT							
7		PHY EVENT						(LSB)	
8	(MSB)	PEAK VALUE DETECTOR THRESHOLD							
11		PEAK VALUE DETECTOR THRESHOLD						(LSB)	

The PHY EVENT SOURCE field, defined in table 37 in 4.11, indicates the type of phy event being reported in the PHY EVENT field.

The PHY EVENT field indicates the value (i.e., the count or peak value detected) of the phy event indicated by the PHY EVENT SOURCE field.

If the phy event source is a peak value detector, the PEAK VALUE DETECTOR THRESHOLD field indicates the value of the peak value detector that causes the expander device to originate a Broadcast (Expander)(see 7.2.6.4). If the phy event source is not a peak value detector, then the PEAK VALUE DETECTOR THRESHOLD field is reserved.

10.4.3.15 DISCOVER LIST function

10.4.3.15.1 DISCOVER LIST function overview

The DISCOVER LIST function returns information about the device (i.e., some fields from the REPORT GENERAL response (see 10.4.3.4)) and one or more phys (i.e., some fields from the DISCOVER response (see 10.4.3.10)). This SMP function shall be implemented by all management device servers. This function is intended to provide the necessary information in a single SMP response for a self-configuring expander device to perform the discover process and configure its own expander routing table.

Page: 615

Author: elx-bmartin
Subject: Comment on Text
Date: 5/6/2008 4:07:50 PM
T ACCEPT - DONE

This reference should be 4.2.8

Author: RElliott
Subject: Highlight
Date: 6/30/2008 6:16:52 PM
T ACCEPT - DONE

after
reported.

add
and is the same as the phy identifier field in the request frame.

Author: RElliott
Subject: Highlight
Date: 6/30/2008 6:16:52 PM
T ACCEPT - DONE

how many phy event descriptors follow.
s/b
the number of phy event descriptors in the phy event descriptor list

Author: hpq-relliott
Subject: Note
Date: 6/20/2008 12:18:11 PM
ACCEPT - DONE (

Added: "The phy event descriptor list shall contain no more than one phy event descriptor with the same value in the phy event source field."

6/11 no sorting required, but only allow one entry in the list.)

Require the phy event descriptors be in ascending order sorted by the phy event source.

Require that only one entry be present per phy event source.

(or, treat this as a log, where events are added as they occur)

Author: RElliott
Subject: Underline
Date: 6/30/2008 6:16:52 PM
T ACCEPT - DONE

REPORT PHY EVENT response phy event descriptor
s/b
Phy event descriptor

(matching comment on 10.4.3.9.4 by Data Domain)

Author: RElliott
Subject: Highlight
Date: 6/30/2008 6:16:52 PM
T ACCEPT - DONE

the
s/b

Comments from page 615 continued on next page

The PHY IDENTIFIER field indicates the phy (see 4.2.7) for which information is being reported.

The NUMBER OF PHY EVENT DESCRIPTORS field indicates how many phy event descriptors follow.

The phy event descriptor list contains phy event descriptors as defined in 10.4.3.14.4.

The CRC field is defined in 10.4.3.3.8.

10.4.3.14.4 REPORT PHY EVENT response phy event descriptor

Table 288 defines the phy event descriptor.

Table 288 — Phy event descriptor

Byte/Bit	7	6	5	4	3	2	1	0
0	Reserved							
2	Reserved							
3	PHY EVENT SOURCE							
4	(MSB)	PHY EVENT						(LSB)
7	(LSB)							
8	(MSB)	PEAK VALUE DETECTOR THRESHOLD						(LSB)
11	(LSB)							

The PHY EVENT SOURCE field, defined in table 37 in 4.11, indicates the type of phy event being reported in the PHY EVENT field.

The PHY EVENT field indicates the value (i.e., the count or peak value detected) of the phy event indicated by the PHY EVENT SOURCE field.

If the phy event source is a peak value detector, the PEAK VALUE DETECTOR THRESHOLD field indicates the value of the peak value detector that causes the expander device to originate a Broadcast (Expander)(see 7.2.6.4). If the phy event source is not a peak value detector, then the PEAK VALUE DETECTOR THRESHOLD field is reserved.

10.4.3.15 DISCOVER LIST function

10.4.3.15.1 DISCOVER LIST function overview

The DISCOVER LIST function returns information about the device (i.e., some fields from the REPORT GENERAL response (see 10.4.3.4)) and one or more phys (i.e., some fields from the DISCOVER response (see 10.4.3.10)). This SMP function shall be implemented by all management device servers. This function is intended to provide the necessary information in a single SMP response for a self-configuring expander device to perform the discover process and configure its own expander routing table.

then the

Author: lsi-gpenokie
Subject: Highlight
Date: 5/6/2008 4:07:50 PM

T ACCEPT - DONE

This << This function is intended to provide the necessary information in a single SMP response >> should be << This function provides the necessary information in a single SMP response >>

10.4.3.15.2 DISCOVER LIST request

Table 289 defines the request format.

Table 289 — DISCOVER LIST request

Byte/Bit	7	6	5	4	3	2	1	0
0	SMP FRAME TYPE (40h)							
1	FUNCTION (20h)							
2	ALLOCATED RESPONSE LENGTH							
3	REQUEST LENGTH (06h)							
4	Reserved							
7	Reserved							
8	STARTING PHY IDENTIFIER							
9	MAXIMUM NUMBER OF DISCOVER LIST DESCRIPTORS							
10	IGNORE ZONE GROUP	Reserved			PHY FILTER			
11	Reserved				DESCRIPTOR TYPE			
12	Reserved							
15	Reserved							
16	Vendor-specific							
27	Vendor-specific							
28	(MSB)	CRC						(LSB)
31	(LSB)							

The SMP FRAME TYPE field is defined in 10.4.3.2.2 and shall be set to the value defined in table 289.

The FUNCTION field is defined in 10.4.3.2.3 and shall be set to the value defined in table 289.

The ALLOCATED RESPONSE LENGTH field is defined in 10.4.3.2.4.

The REQUEST LENGTH field is defined in 10.4.3.2.5 and shall be set to the value defined in table 289.

The STARTING PHY IDENTIFIER field specifies the phy identifier of the first phy for which the information is being requested.

The MAXIMUM NUMBER OF DISCOVER LIST DESCRIPTORS field specifies the maximum number of complete DISCOVER LIST descriptors that the management device server shall return.

The IGNORE ZONE GROUP bit is defined in the SMP DISCOVER request (see 10.4.3.10).

This page contains no comments

The PHY FILTER field is defined in table 290 and specifies a filter limiting which phys that the management device server shall return in the DISCOVER LIST descriptor list in the DISCOVER response.

Table 290 — PHY FILTER field

Code	Description
0h	All phys.
1h	Phys with the ATTACHED DEVICE TYPE field (see 10.4.3.10) set to 010b or 011b (i.e., attached to expander devices).
2h	Phys with the ATTACHED DEVICE TYPE field (see 10.4.3.10) set to a value other than zero (i.e., attached to end devices or expander devices).
All others	Reserved

The DESCRIPTOR TYPE field is defined in table 291 and specifies the DISCOVER LIST descriptor format and length.

Table 291 — DESCRIPTOR TYPE field

Code	DISCOVER LIST descriptor format	Descriptor length
0h	DISCOVER response defined in table 269 (see 10.4.3.10), not including the CRC field.	The length of the DISCOVER response, not including the CRC field
1h	SHORT FORMAT descriptor defined in table 293 (see 10.4.3.15.4)	24 bytes
All others	Reserved	

The CRC field is defined in 10.4.3.2.8.

10.4.3.15.3 DISCOVER LIST response

Table 292 defines the response format.

Table 292 — DISCOVER LIST response (part 1 of 2)

Byte\Bit	7	6	5	4	3	2	1	0
0	SMP FRAME TYPE (41h)							
1	FUNCTION (20h)							
2	FUNCTION RESULT							
3	RESPONSE LENGTH ((n - 7) / 4)							
4	(MSB)	EXPANDER CHANGE COUNT						(LSB)
5								
6	Reserved							
7								
8	STARTING PHY IDENTIFIER							
9	NUMBER OF DISCOVER LIST DESCRIPTORS							
10	Reserved				PHY FILTER			
11	Reserved				DESCRIPTOR TYPE			

Page: 617

● Author: Isi-bbesmer
Subject: Note
Date: 8/28/2008 2:42:17 PM
 ACCEPT - DONE (for 1h and 2h: only return phys that do not return a function result of PHY VACANT)

Need to clarify if this includes VACANT phys or not.

● Author: RElliott
Subject: Highlight
Date: 6/30/2008 6:16:52 PM
 ACCEPT - DONE
zero
s/b
000b

● Author: Isi-bbesmer
Subject: Highlight
Date: 5/26/2008 12:33:29 PM
 ACCEPT - DONE (changed to "(i.e., phys attached..." to clarify that the i.e. is providing other words for the whole description, not just the latter part. Same change in 1h)

This example here is opposite of what this filters.

● Author: elx-bmartin
Subject: Highlight
Date: 5/30/2008 4:32:16 PM
 ACCEPT - DONE (yes. Added "starting with byte 0 and" before "not including" to clarify.)

DISCOVER response defined in table 269 (see 10.4.3.10), not including the CRC field.

Does this include the SMP Frame Type, Function, and Function Result?

● Author: Isi-gpenokie
Subject: Highlight
Date: 5/30/2008 4:30:08 PM
 ACCEPT - DONE (though this will quickly become out of date as the DISCOVER response grows. The number is currently 8, not 9, with a 112 byte DISCOVER response.
1028-48-4=976, 976/112=8.7.

Added two table footnotes:

"a A maximum response frame size of 1 028 bytes supports 8 112-byte DISCOVER LIST descriptors containing DISCOVER responses.

b A maximum response frame size of 1 028 bytes supports 40 24-byte SHORT FORMAT descriptors."

Should state here that this allows a maximum of 9 phys of information to be returned in with one function request.

● Author: RElliott
Subject: Note
Date: 6/30/2008 6:16:52 PM
 ACCEPT - DONE (added "starting with byte 0 and" before "not including" to clarify)

4. Section 10.4.3.15.2, for the DISCOVER LIST request, table 292 lists for 0h that descriptor length will be "The length of the DISCOVER response, not including the CRC field." as described in section 10.4.3.10, table 270. Do these descriptor also include the response header fields of SMP FRAME TYPE, FUNCTION, FUNCTION RESULT, RESPONSE LENGTH and EXPANDER CHANGE COUNT?

(from Tim McLeod, Data Domain; T10 reflector 5/9/2008)

Comments from page 617 continued on next page

The PHY FILTER field is defined in table 290 and specifies a filter limiting which phys that the management device server shall return in the DISCOVER LIST descriptor list in the DISCOVER response.

Table 290 — PHY FILTER field

Code	Description
0h	All phys.
1h	Phys with the ATTACHED DEVICE TYPE field (see 10.4.3.10) set to 010b or 011b (i.e., attached to expander devices).
2h	Phys with the ATTACHED DEVICE TYPE field (see 10.4.3.10) set to a value other than zero (i.e., attached to end devices or expander devices).
All others	Reserved

The DESCRIPTOR TYPE field is defined in table 291 and specifies the DISCOVER LIST descriptor format and length.

Table 291 — DESCRIPTOR TYPE field

Code	DISCOVER LIST descriptor format	Descriptor length
0h	DISCOVER response defined in table 269 (see 10.4.3.10), not including the CRC field.	The length of the DISCOVER response, not including the CRC field
1h	SHORT FORMAT descriptor defined in table 293 (see 10.4.3.15.4)	24 bytes
All others	Reserved	

The CRC field is defined in 10.4.3.2.8.

10.4.3.15.3 DISCOVER LIST response

Table 292 defines the response format.

Table 292 — DISCOVER LIST response (part 1 of 2)

Byte\Bit	7	6	5	4	3	2	1	0
0	SMP FRAME TYPE (41h)							
1	FUNCTION (20h)							
2	FUNCTION RESULT							
3	RESPONSE LENGTH ((n - 7) / 4)							
4	(MSB)	EXPANDER CHANGE COUNT						(LSB)
5								
6	Reserved							
7								
8	STARTING PHY IDENTIFIER							
9	NUMBER OF DISCOVER LIST DESCRIPTORS							
10	Reserved				PHY FILTER			
11	Reserved				DESCRIPTOR TYPE			

● Author: Isi-gpenokie

Subject: Highlight

Date: 5/30/2008 4:26:29 PM

 ACCEPT - DONE (though this can easily become out of date)

Should state here that this allows a maximum of 40 phys of information to be returned in with one function request.

● Author: RElliott

Subject: Note

Date: 6/30/2008 6:16:52 PM

 REJECT

The 6/11 LB call discussed whether to move the NUMBER OF DISCOVER LIST DESCRIPTORS field to byte 47 (immediately in front of the descriptor list), and decided not to do so.

Table 292 — DISCOVER LIST response (part 2 of 2)

Byte\Bit	7	6	5	4	3	2	1	0
12	DESCRIPTOR LENGTH							
13	Reserved							
15	Reserved							
16	ZONING SUPPORTED	ZONING ENABLED	Reserved			CONFIGURING	EXTERNALLY CONFIGURABLE ROUTE TABLE	
17	Reserved							
18	(MSB)	LAST SELF-CONFIGURATION STATUS DESCRIPTOR INDEX						(LSB)
19								
20	(MSB)	LAST PHY EVENT LIST DESCRIPTOR INDEX						(LSB)
21								
22	Reserved							
31								
32	Vendor specific							
47								
DISCOVER LIST descriptor list								
48	DISCOVER LIST descriptor (first)(see table 291 in 10.4.3.15.1, and table 269 in 10.4.3.10 or table 293 in 10.4.3.15.4)							
...								
n - 4	DISCOVER LIST descriptor (last)(see table 291 in 10.4.3.15.1, and table 269 in 10.4.3.10 or table 293 in 10.4.3.15.4)							
n - 3	(MSB)	CRC						(LSB)
n								

The SMP FRAME TYPE field is defined in 10.4.3.3.2 and shall be set to the value defined in table 292.

The FUNCTION field is defined in 10.4.3.3.3 and shall be set to the value defined in table 292.

The FUNCTION RESULT field is defined in 10.4.3.3.4.

The RESPONSE LENGTH field is defined in 10.4.3.3.5 and shall be set to the value defined in table 292. A RESPONSE LENGTH field set to 00h does not have a special meaning based on the ALLOCATED RESPONSE LENGTH field in the request frame.

The EXPANDER CHANGE COUNT field is defined in the SMP REPORT GENERAL response (see 10.4.3.4).

The STARTING PHY IDENTIFIER field indicates the phy identifier of the first phy in the DISCOVER LIST descriptor list.

NOTE 121 - The STARTING PHY IDENTIFIER field may be different than the STARTING PHY IDENTIFIER field in the request frame (see 10.4.3.15.2) due to the filter specified by the PHY FILTER field in the request frame.

The NUMBER OF DISCOVER LIST DESCRIPTORS field indicates the number of DISCOVER LIST descriptors returned in the DISCOVER LIST descriptor list.

● Author: RElliott
Subject: Highlight
Date: 6/30/2008 6:16:52 PM
 ACCEPT - DONE

DESCRIPTOR LENGTH
s/b
DISCOVER LIST DESCRIPTOR LENGTH

to match convention used in these other response frames:
REPORT SELF-CONFIGURATION STATUS response has a SELF-CONFIGURATION DESCRIPTOR LENGTH field

REPORT PHY EVENT LIST response has a PHY EVENT LIST DESCRIPTOR LENGTH field

● Author: RElliott
Subject: Note
Date: 6/30/2008 6:16:52 PM
 ACCEPT - DONE

Add:
SELF CONFIGURING to bit 3
ZONE CONFIGURING to bit 2

to match Isi-bbesmer comment on first page

● Author: RElliott
Subject: Underline
Date: 6/30/2008 6:16:52 PM
 ACCEPT - DONE

different than the

fix font

● Author: RElliott
Subject: Note
Date: 6/30/2008 6:16:52 PM
 ACCEPT - DONE (added "The phy filter field indicates the phy filter (see table 292 in 10.4.3.15.2) being used and is the same as the phy filter field in the request frame.")

Need a PHY FILTER paragraph

(from Brad Besmer, LSI)

The **DESCRIPTOR LENGTH** field indicates the **length** of the DISCOVER LIST descriptor (see table 291 in 10.4.3.15.2).

The ZONING SUPPORTED bit is defined in the SMP REPORT GENERAL response (see 10.4.3.4).

The ZONING ENABLED bit is defined in the SMP REPORT GENERAL response (see 10.4.3.4).

The CONFIGURING bit is defined in the SMP DISCOVER response (see 10.4.3.10).

The EXTERNALLY CONFIGURABLE ROUTE TABLE bit is defined in the SMP REPORT GENERAL response (see 10.4.3.4).

The LAST SELF-CONFIGURATION STATUS DESCRIPTOR INDEX field is defined in the REPORT SELF-CONFIGURATION STATUS response (see 10.4.3.6).

The LAST PHY EVENT LIST DESCRIPTOR INDEX field is defined in the REPORT PHY EVENT LIST response (see 10.4.3.16).

The DISCOVER LIST descriptor list contains DISCOVER LIST descriptors for each phy:

- a) starting with the phy whose phy identifier is specified in the STARTING PHY IDENTIFIER field in the request (see 10.4.3.15.2);
- b) satisfying the filter specified in the PHY FILTER field in the request (see table 290 in 10.4.3.15.2); and
- c) that is able to be included in the response frame without being truncated.

Each DISCOVER LIST descriptor shall use the format specified in the DESCRIPTOR TYPE field in the request (see table 291 in 10.4.3.15.2)

The management device server shall not include DISCOVER LIST descriptors for phys with phy identifiers greater than or equal to the NUMBER OF PHYs field reported in the SMP REPORT GENERAL response (see 10.4.3.4). The management device server shall not include partial DISCOVER LIST descriptors.

The CRC field is defined in 10.4.3.3.8.

10.4.3.15.4 DISCOVER LIST response SHORT FORMAT descriptor

Table 293 defines the SHORT FORMAT descriptor.

Table 293 — SHORT FORMAT descriptor

Byte/Bit	7	6	5	4	3	2	1	0
0	PHY IDENTIFIER							
1	FUNCTION RESULT							
2	Restricted	ATTACHED DEVICE TYPE			ATTACHED REASON			
3	Restricted for DISCOVER response byte 13			NEGOTIATED LOGICAL LINK RATE				
4	Restricted for DISCOVER response byte 14			ATTACHED SSP INITIATOR	ATTACHED STP INITIATOR	ATTACHED SMP INITIATOR	ATTACHED SATA HOST	
5	ATTACHED SATA PORT SELECTOR	Restricted for DISCOVER response byte 15			ATTACHED SSP TARGET	ATTACHED STP TARGET	ATTACHED SMP TARGET	ATTACHED SATA DEVICE
6	VIRTUAL PHY	Reserved			ROUTING ATTRIBUTE			
7	REASON				Reserved			
8	ZONE GROUP							

Page: 619

● Author: RElliott
Subject: Highlight
Date: 6/30/2008 6:16:52 PM
 ACCEPT - DONE

length
s/b
length, in dwords,

● Author: RElliott
Subject: Highlight
Date: 6/30/2008 6:16:52 PM
 ACCEPT - DONE

DESCRIPTOR LENGTH
s/b
DISCOVER LIST DESCRIPTOR LENGTH

to match convention in other response frames
(see matching comment in table)

● Author: RElliott
Subject: Note
Date: 6/30/2008 6:16:52 PM
 ACCEPT - DONE

Add:
The self configuring bit is defined in the REPORT GENERAL response (see 10.4.3.4).
The zone configuring bit is defined in the REPORT GENERAL response (see 10.4.3.4).

to match Isi-bbesmer comment on first page

● Author: Isi-gpenokie
Subject: Sticky Note
Date: 5/8/2008 8:42:51 PM
 REJECT (item c says the list ends with the last full, non-truncated descriptor. It is up to the management application client to send another DISCOVER LIST request with a higher STARTING PHY IDENTIFIER field to obtain additional descriptors.)

OK so what happens if the number of descriptors exceeds the maximum possible length of the response?

● Author: hpq-relliott
Subject: Note
Date: 6/20/2008 12:19:43 PM
 ACCEPT - DONE (6/11 yes)

add d)
sorted in ascending order based on phy identifier;

● Author: RElliott
Subject: Note
Date: 6/30/2008 6:16:52 PM
 ACCEPT - DONE

Add "(see n of n)" to table 293 SHORT FORMAT descriptor title

● Author: RElliott
Subject: Note

Comments from page 619 continued on next page

The **DESCRIPTOR LENGTH** field indicates the **length** of the DISCOVER LIST descriptor (see table 291 in 10.4.3.15.2).

The ZONING SUPPORTED bit is defined in the SMP REPORT GENERAL response (see 10.4.3.4).

The ZONING ENABLED bit is defined in the SMP REPORT GENERAL response (see 10.4.3.4).

 The CONFIGURING bit is defined in the SMP DISCOVER response (see 10.4.3.10).

The EXTERNALLY CONFIGURABLE ROUTE TABLE bit is defined in the SMP REPORT GENERAL response (see 10.4.3.4).

The LAST SELF-CONFIGURATION STATUS DESCRIPTOR INDEX field is defined in the REPORT SELF-CONFIGURATION STATUS response (see 10.4.3.6).

The LAST PHY EVENT LIST DESCRIPTOR INDEX field is defined in the REPORT PHY EVENT LIST response (see 10.4.3.16).

 The DISCOVER LIST descriptor list contains DISCOVER LIST descriptors for each phy:

- a) starting with the phy whose phy identifier is specified in the STARTING PHY IDENTIFIER field in the request (see 10.4.3.15.2);
- b) satisfying the filter specified in the PHY FILTER field in the request (see table 290 in 10.4.3.15.2); and
- c) that is able to be included in the response frame without being truncated.

 Each DISCOVER LIST descriptor shall use the format specified in the DESCRIPTOR TYPE field in the request (see table 291 in 10.4.3.15.2)

The management device server shall not include DISCOVER LIST descriptors for phys with phy identifiers greater than or equal to the NUMBER OF PHYs field reported in the SMP REPORT GENERAL response (see 10.4.3.4). The management device server shall not include partial DISCOVER LIST descriptors.

The CRC field is defined in 10.4.3.3.8.

10.4.3.15.4 DISCOVER LIST response SHORT FORMAT descriptor

Table 293 defines the SHORT FORMAT descriptor.

Table 293 — SHORT FORMAT descriptor

Byte\Bit	7	6	5	4	3	2	1	0
0	PHY IDENTIFIER							
1	FUNCTION RESULT							
2	Restricted	ATTACHED DEVICE TYPE			ATTACHED REASON			
3	Restricted for DISCOVER response byte 13				NEGOTIATED LOGICAL LINK RATE			
4	Restricted for DISCOVER response byte 14				ATTACHED SSP INITIATOR	ATTACHED STP INITIATOR	ATTACHED SMP INITIATOR	ATTACHED SATA HOST
5	ATTACHED SATA PORT SELECTOR	Restricted for DISCOVER response byte 15			ATTACHED SSP TARGET	ATTACHED STP TARGET	ATTACHED SMP TARGET	ATTACHED SATA DEVICE
6	VIRTUAL PHY	Reserved			ROUTING ATTRIBUTE			
7	REASON					Reserved		
8	ZONE GROUP							

Date: 9/2/2008 7:05:57 PM

 ACCEPT - DONE

Add the NEGOTIATED PHYSICAL LINK RATE field to the SHORT FORMAT descriptor for DISCOVER LIST.

Multiplexing is not strictly necessary for filling in routing tables. However, after a Broadcast (Change) due to a change in multiplexing configuration, nothing in the SHORT FORMAT descriptor will change, possibly causing confusion.

(from Brad Besmer, LSI)

Table 293 — SHORT FORMAT descriptor

Byte\Bit	7	6	5	4	3	2	1	0
9	Restricted for DISCOVER response byte 60		INSIDE ZPSDS PERSISTENT	REQUESTED INSIDE ZPSDS	Reserved	ZONE GROUP PERSISTENT	INSIDE ZPSDS	Reserved
10	ATTACHED PHY IDENTIFIER							
11	PHY CHANGE COUNT							
12	ATTACHED SAS ADDRESS							
19								
20								
23	Reserved							

The PHY IDENTIFIER field indicates the phy for which ~~physical configuration link~~ information is being returned.

The FUNCTION RESULT field indicates the value that is returned in the FUNCTION RESULT field in the SMP DISCOVER response for the specified phy (e.g., SMP FUNCTION ACCEPTED, PHY VACANT, or PHY DOES NOT EXIST). If the FUNCTION RESULT field is set to PHY VACANT or PHY DOES NOT EXIST, **the** rest of the fields in the SHORT FORMAT descriptor shall be ignored.

The fields in the SHORT FORMAT descriptor not defined in this subclause are defined in the SMP DISCOVER response (see 10.4.3.10).

10.4.3.16 REPORT PHY EVENT LIST function

10.4.3.16.1 REPORT PHY EVENT LIST function overview

The REPORT PHY EVENT LIST function returns phy events (see 4.11). This SMP function may be implemented by any management device server.

10.4.3.16.2 REPORT PHY EVENT LIST request

Table 294 defines the request format.

Table 294 — REPORT PHY EVENT LIST request

Byte\Bit	7	6	5	4	3	2	1	0	
0	SMP FRAME TYPE (40h)								
1	FUNCTION (21h)								
2	ALLOCATED RESPONSE LENGTH								
3	REQUEST LENGTH (01h)								
4	Reserved								
5									
6	(MSB)	STARTING PHY EVENT LIST DESCRIPTOR INDEX							
7								(LSB)	
8	(MSB)								
		CRC							
11								(LSB)	

● Author: RElliott
Subject: Cross-Out
Date: 6/30/2008 6:16:52 PM
~~T~~ ACCEPT - DONE

physical configuration link

● Author: RElliott
Subject: Highlight
Date: 6/30/2008 6:16:52 PM
T ACCEPT - DONE

the
s/b
then the

The SMP FRAME TYPE field is defined in 10.4.3.2.2 and shall be set to the value defined in table 294.

The FUNCTION field is defined in 10.4.3.2.3 and shall be set to the value defined in table 294.

The ALLOCATED RESPONSE LENGTH field is defined in 10.4.3.2.4.

The REQUEST LENGTH field is defined in 10.4.3.2.5 and shall be set to the value defined in table 294.

The STARTING PHY EVENT LIST DESCRIPTOR INDEX field specifies the first phy event list descriptor that the management device server shall return in the SMP response frame. A STARTING PHY EVENT LIST DESCRIPTOR INDEX field set to 0000h is reserved. The requested starting index and the indicated starting index in the response may differ.

The CRC field is defined in 10.4.3.2.8.

This page contains no comments

10.4.3.16.3 REPORT PHY EVENT LIST response

Table 295 defines the response format.

Table 295 — REPORT PHY EVENT LIST response

Byte/Bit	7	6	5	4	3	2	1	0
0	SMP FRAME TYPE (41h)							
1	FUNCTION (21h)							
2	FUNCTION RESULT							
3	RESPONSE LENGTH $((n - 7) / 4)$							
4	(MSB)	EXPANDER CHANGE COUNT						(LSB)
5								
6	(MSB)	<u>STARTING PHY EVENT LIST DESCRIPTOR INDEX</u>						(LSB)
7								
8	(MSB)	LAST PHY EVENT LIST DESCRIPTOR INDEX						(LSB)
9								
10	PHY EVENT LIST DESCRIPTOR LENGTH							
11	Reserved							
14								
15	NUMBER OF PHY EVENT LIST DESCRIPTORS							
Phy event list descriptor list								
16	Phy event list descriptor (first)(see table 296 in 10.4.3.16.4)							
...	...							
n - 4	Phy event list descriptor (last)(see table 296 in 10.4.3.16.4)							
n - 3	(MSB)	CRC						(LSB)
n								

The SMP FRAME TYPE field is defined in 10.4.3.3.2 and shall be set to the value defined in table 295.

The FUNCTION field is defined in 10.4.3.3.3 and shall be set to the value defined in table 295.

The FUNCTION RESULT field is defined in 10.4.3.3.4.

The RESPONSE LENGTH field is defined in 10.4.3.3.5 and shall be set to the value defined in table 295. A RESPONSE LENGTH field set to 00h does not have a special meaning based on the ALLOCATED RESPONSE LENGTH field in the request frame.

The EXPANDER CHANGE COUNT field is defined in the SMP REPORT GENERAL response (see 10.4.3.4).

Author: RElliott
Subject: Underline
Date: 6/30/2008 6:16:52 PM
T ACCEPT - DONE

STARTING PHY EVENT LIST DESCRIPTOR INDEX

s/b

FIRST PHY EVENT LIST DESCRIPTOR INDEX

to avoid confusion between the request/response field names. They are not always identical.

This matches the field names in other functions.

The STARTING PHY EVENT LIST DESCRIPTOR INDEX field indicates the index of the first phy event list descriptor being returned. If the STARTING PHY EVENT LIST DESCRIPTOR INDEX field in the SMP request is 0000h, then the management device server shall set the STARTING PHY EVENT LIST DESCRIPTOR INDEX field to 0000h. If the STARTING PHY EVENT LIST DESCRIPTOR INDEX field specified in the SMP request does not contain a valid descriptor, then the device management server shall set the STARTING PHY EVENT LIST DESCRIPTOR INDEX field to the next index, in ascending order wrapping from FFFFh to 0001h, that contains a valid descriptor. Otherwise, this field shall be set to the same value as the STARTING PHY EVENT LIST DESCRIPTOR INDEX field in the SMP request frame.

The DESCRIPTOR LENGTH field indicates the length of the phy event list descriptor (see table 288 in 10.4.3.14.4).

The LAST PHY EVENT LIST DESCRIPTOR INDEX field indicates the last index of the last recorded phy event list descriptor.

The NUMBER OF PHY EVENT LIST DESCRIPTORS field indicates how many phy event list descriptors follow.



The phy event list descriptor list contains phy event list descriptors as defined in 10.4.3.14.4.

The CRC field is defined in 10.4.3.3.8.

10.4.3.16.4 REPORT PHY EVENT LIST response phy event list descriptor

Table 296 defines the phy event list descriptor.

Table 296 — Phy event list descriptor

Byte/Bit	7	6	5	4	3	2	1	0	
0	Reserved								
1	Reserved								
2	PHY IDENTIFIER								
3	PHY EVENT SOURCE								
4	(MSB)	PHY EVENT							
7								(LSB)	
8	(MSB)	PEAK VALUE DETECTOR THRESHOLD							
11								(LSB)	

The PHY IDENTIFIER field indicates the phy for which information is being returned.

The PHY EVENT SOURCE field, defined in table 37 in 4.11, indicates the type of phy event being reported in the PHY EVENT field.

The PHY EVENT field indicates the value (i.e., the count or peak value detected) of the phy event indicated by the PHY EVENT SOURCE field.

If the phy event source is a peak value detector, the PEAK VALUE DETECTOR THRESHOLD field indicates the value of the peak value detector that causes the expander device to originate a Broadcast (Expander)(see 7.2.6.4). If the phy event source is not a peak value detector, then the PEAK VALUE DETECTOR THRESHOLD field is reserved.

Author: RElliott
Subject: Underline
Date: 6/30/2008 6:16:52 PM
T ACCEPT - DONE

STARTING
s/b
FIRST

Author: RElliott
Subject: Underline
Date: 6/30/2008 6:16:52 PM
T ACCEPT - DONE

STARTING
s/b
FIRST

Author: RElliott
Subject: Underline
Date: 6/30/2008 6:16:52 PM
T ACCEPT - DONE

STARTING
s/b
FIRST

Author: wdc-mevans
Subject: Highlight
Date: 5/30/2008 4:46:24 PM
T REJECT (this is modifying "next index" not "descriptor")

index, in ascending order wrapping from FFFFh to 0001h, that contains a valid descriptor.
s/b
index that contains a valid descriptor in ascending order wrapping from FFFFh to 0001h.

Author: RElliott
Subject: Underline
Date: 6/30/2008 6:16:52 PM
T ACCEPT - DONE

see table 288 in 10.4.3.14.4
s/b
see table 296 in 10.4.3.16.4

Author: RElliott
Subject: Highlight
Date: 6/30/2008 6:16:52 PM
T ACCEPT - DONE

length
s/b
length, in dwords,

Author: RElliott
Subject: Highlight
Date: 6/30/2008 6:16:52 PM
T ACCEPT - DONE

DESCRIPTOR LENGTH
s/b

The STARTING PHY EVENT LIST DESCRIPTOR INDEX field indicates the index of the first phy event list descriptor being returned. If the STARTING PHY EVENT LIST DESCRIPTOR INDEX field in the SMP request is 0000h, then the management device server shall set the STARTING PHY EVENT LIST DESCRIPTOR INDEX field to 0000h. If the STARTING PHY EVENT LIST DESCRIPTOR INDEX field specified in the SMP request does not contain a valid descriptor, then the device management server shall set the STARTING PHY EVENT LIST DESCRIPTOR INDEX field to the next **index, in ascending order wrapping from FFFFh to 0001h, that contains a valid descriptor.** Otherwise, this field shall be set to the same value as the STARTING PHY EVENT LIST DESCRIPTOR INDEX field in the SMP request frame.

The **DESCRIPTOR LENGTH** field indicates the **length** of the phy event list descriptor (see table 288 in 10.4.3.14.4).

The LAST PHY EVENT LIST DESCRIPTOR INDEX field indicates the last index of the last recorded phy event list descriptor.

The NUMBER OF PHY EVENT LIST DESCRIPTORS field indicates **how many phy event list descriptors follow.**



The phy event list descriptor list contains phy event list descriptors as defined in 10.4.3.14.4.

The CRC field is defined in 10.4.3.3.8.

10.4.3.16.4 REPORT PHY EVENT LIST response phy event list descriptor

Table 296 defines the phy event list descriptor.

Table 296 — Phy event list descriptor

Byte\Bit	7	6	5	4	3	2	1	0	
0	Reserved								
1	Reserved								
2	PHY IDENTIFIER								
3	PHY EVENT SOURCE								
4	(MSB)	PHY EVENT							
7							(LSB)		
8	(MSB)	PEAK VALUE DETECTOR THRESHOLD							
11							(LSB)		

The PHY IDENTIFIER field indicates the phy for which information is being returned.

The PHY EVENT SOURCE field, defined in table 37 in 4.11, indicates the type of phy event being reported in the PHY EVENT field.

The PHY EVENT field indicates the value (i.e., the count or peak value detected) of the phy event indicated by the PHY EVENT SOURCE field.

If the phy event source is a peak value detector, **the** PEAK VALUE DETECTOR THRESHOLD field indicates the value of the peak value detector that causes the expander device to originate a Broadcast (Expander)(see 7.2.6.4). If the phy event source is not a peak value detector, then the PEAK VALUE DETECTOR THRESHOLD field is reserved.

PHY EVENT LIST DESCRIPTOR LENGTH

to match table

Author: RElliott
Subject: Highlight
Date: 6/30/2008 6:16:52 PM

 ACCEPT - DONE
how many phy event list descriptors follow
s/b
the number of phy event list descriptors in the phy phy event list descriptor list

Author: RElliott
Subject: Underline
Date: 6/30/2008 6:16:52 PM

 ACCEPT - DONE
in 10.4.3.14.4
s/b
in 10.4.3.16.4

Author: Isi-gpenokie
Subject: Sticky Note
Date: 6/20/2008 1:10:35 PM

 ACCEPT - DONE (added text based on the self-configuration status descriptor list text.

The phy event list descriptor list contains phy event list descriptors as defined in 10.4.3.16.4. The management device server shall return either all the phy event list descriptors that fit in one SMP response frame or all the phy event list descriptors until the index indicated in the last phy event list descriptor index field is reached. The phy event list descriptor list shall start with the phy event list descriptor indicated by the first phy event list descriptor index field, and continue with phy event list descriptors sorted in ascending order, wrapping from FFFFh to 0001h, based on the phy event list descriptor index. The phy event list descriptor list shall not contain any truncated phy event list descriptors. If the first phy event list descriptor index field is equal to the last phy event list descriptor index field, then the phy event list descriptor at that index shall be returned.
)

What happens if the number of phy events is too many to contain within the REPORT PHY EVENT LIST response?

Author: RElliott
Subject: Underline
Date: 6/30/2008 6:16:52 PM

 ACCEPT - DONE
REPORT PHY EVENT LIST response phy event list descriptor
s/b
Phy event list descriptor

(matching comment on 10.4.3.9.4 by Data Domain)

Author: RElliott
Subject: Highlight
Date: 6/30/2008 6:16:52 PM

 ACCEPT - DONE
the
s/b
then the

10.4.3.17 REPORT EXPANDER ROUTE TABLE LIST function

10.4.3.17.1 REPORT EXPANDER ROUTE TABLE LIST function overview

The REPORT EXPANDER ROUTE TABLE LIST function returns the contents of an expander-based expander route table (see 4.6.7.3 and 4.9.3.4). The list may be in any order. Self-configuring expander devices shall support this function.

10.4.3.17.2 REPORT EXPANDER ROUTE TABLE LIST request

Table 297 defines the request format.

Table 297 — REPORT EXPANDER ROUTE TABLE LIST request

Byte/Bit	7	6	5	4	3	2	1	0
0	SMP FRAME TYPE (40h)							
1	FUNCTION (22h)							
2	ALLOCATED RESPONSE LENGTH							
3	REQUEST LENGTH (06h)							
4	Reserved							
7	Reserved							
8	(MSB)	MAXIMUM NUMBER OF REPORT EXPANDER ROUTE TABLE DESCRIPTORS						(LSB)
9								
10	(MSB)	STARTING ROUTED SAS ADDRESS INDEX						(LSB)
11								
12	Reserved							
18	Reserved							
19	STARTING PHY IDENTIFIER							
20	Reserved							
27	Reserved							
28	(MSB)	CRC						(LSB)
31								

The SMP FRAME TYPE field is defined in 10.4.3.2.2 and shall be set to the value defined in table 297.

The FUNCTION field is defined in 10.4.3.2.3 and shall be set to the value defined in table 297.

The ALLOCATED RESPONSE LENGTH field is defined in 10.4.3.2.4.

The REQUEST LENGTH field is defined in 10.4.3.2.5 and shall be set to the value defined in table 297.

The MAXIMUM NUMBER OF REPORT EXPANDER ROUTE TABLE DESCRIPTORS field specifies the maximum number of REPORT EXPANDER ROUTE TABLE descriptors that the management device server shall return.

The STARTING ROUTED SAS ADDRESS INDEX field specifies the index of the first routed SAS address to be returned in the descriptor list.

● Author: RElliott
Subject: Underline
Date: 8/28/2008 2:43:07 PM
T ACCEPT - DONE

to be returned
s/b
that the management device server shall return

● Author: RElliott
Subject: Underline
Date: 8/28/2008 2:42:59 PM
T ACCEPT - DONE

descriptor list
s/b
expander route table descriptor list

(using the new name)

The STARTING PHY IDENTIFIER field specifies the first phy identifier of the phy identifier bit map returned in the REPORT EXPANDER ROUTE TABLE descriptor (see table 299 in 10.4.3.17.3). The value of this field shall be aligned to a boundary of 48 (e.g., 0, 48, 96) and not exceed the value of the NUMBER OF PHYS field reported in the REPORT GENERAL response (see 10.4.3.4).

The CRC field is defined in 10.4.3.2.8.

10.4.3.17.3 REPORT EXPANDER ROUTE TABLE LIST response

Table 298 defines the response format.

Table 298 — REPORT EXPANDER ROUTE TABLE LIST response

Byte\Bit	7	6	5	4	3	2	1	0
0	SMP FRAME TYPE (41h)							
1	FUNCTION (22h)							
2	FUNCTION RESULT							
3	RESPONSE LENGTH ((n - 7) / 4)							
4	(MSB)	EXPANDER CHANGE COUNT						(LSB)
5								
6	(MSB)	EXPANDER ROUTE TABLE CHANGE COUNT						(LSB)
7								
8	Reserved				CONFIGURING		Reserved	
9	Reserved							
10	(MSB)	NUMBER OF REPORT EXPANDER ROUTE TABLE DESCRIPTORS						(LSB)
11								
12	(MSB)	FIRST Routed SAS ADDRESS INDEX						(LSB)
13								
14	(MSB)	LAST Routed SAS ADDRESS INDEX						(LSB)
15								
16	Reserved							
18								
19	STARTING PHY IDENTIFIER							
20								
31	Reserved							
<u>REPORT EXPANDER ROUTE TABLE descriptor list</u>								
32	REPORT EXPANDER ROUTE TABLE descriptor (first)(see table 299 in							
47	10.4.3.17.4)							
...	...							
n - 20	REPORT EXPANDER ROUTE TABLE descriptor (last)(see table 299 in							
n - 4	10.4.3.17.4)							
n - 3	(MSB)	CRC						(LSB)
n								

Page: 625

● Author: RElliott
Subject: Underline
Date: 6/30/2008 6:16:52 PM
 ACCEPT - DONE

the REPORT EXPANDER ROUTE TABLE descriptor
s/b
each REPORT EXPANDER ROUTE TABLE descriptor

● Author: RElliott
Subject: Underline
Date: 6/30/2008 6:16:52 PM
 ACCEPT - DONE

The value of this field shall be
aligned to a boundary of 48 (e.g., 0, 48, 96)
s/b
This field should be set to a multiple of 48 (e.g., 0, 48, 96)

There is no error reported if it is not, so "shall" is too strong. Adding comment in response that the device server shall round down the starting phy identifier if needed.

● Author: RElliott
Subject: Highlight
Date: 6/30/2008 6:16:52 PM
 ACCEPT - DONE

not exceed the value of the NUMBER OF PHYS field reported in the REPORT GENERAL response
s/b
shall be less than the value indicated in the REPORT GENERAL response

● Author: RElliott
Subject: Note
Date: 6/30/2008 6:16:52 PM
 ACCEPT - DONE

Add
SELF CONFIGURING to bit 3
ZONE CONFIGURING to bit 2

to match Isi-bbesmer comment on first page

● Author: RElliott
Subject: Note
Date: 6/30/2008 6:16:52 PM
 ACCEPT - DONE

Per 6/11 LB call, change byte 10 to an Expander Route Table Descriptor Length field

● Author: RElliott
Subject: Highlight
Date: 6/30/2008 6:16:52 PM
 ACCEPT - DONE

Per 6/11 LB call, change the Number of Expander Route Table Descriptors field to one byte only in byte 11, to match the "Number of" fields in all the other functions that have descriptor lists.

● Author: RElliott
Subject: Note
Date: 6/30/2008 6:16:52 PM

Comments from page 625 continued on next page

The STARTING PHY IDENTIFIER field specifies the first phy identifier of the phy identifier bit map returned in the REPORT EXPANDER ROUTE TABLE descriptor (see table 299 in 10.4.3.17.3). The value of this field shall be aligned to a boundary of 48 (e.g., 0, 48, 96) and not exceed the value of the NUMBER OF PHYS field reported in the REPORT GENERAL response (see 10.4.3.4).

The CRC field is defined in 10.4.3.2.8.

10.4.3.17.3 REPORT EXPANDER ROUTE TABLE LIST response

Table 298 defines the response format.

Table 298 — REPORT EXPANDER ROUTE TABLE LIST response

Byte\Bit	7	6	5	4	3	2	1	0
0	SMP FRAME TYPE (41h)							
1	FUNCTION (22h)							
2	FUNCTION RESULT							
3	RESPONSE LENGTH ((n - 7) / 4)							
4	(MSB)	EXPANDER CHANGE COUNT						(LSB)
5								
6	(MSB)	EXPANDER ROUTE TABLE CHANGE COUNT						(LSB)
7								
8	Reserved					CONFIGURING	Reserved	
9	Reserved							
10	(MSB)	NUMBER OF REPORT EXPANDER ROUTE TABLE DESCRIPTORS						(LSB)
11								
12	(MSB)	FIRST ROUTED SAS ADDRESS INDEX						(LSB)
13								
14	(MSB)	LAST ROUTED SAS ADDRESS INDEX						(LSB)
15								
16	Reserved							
18								
19	STARTING PHY IDENTIFIER							
20								
31	Reserved							
<u>REPORT EXPANDER ROUTE TABLE descriptor list</u>								
32	REPORT EXPANDER ROUTE TABLE descriptor (first)(see table 299 in							
47	10.4.3.17.4)							
...	...							
n - 20	REPORT EXPANDER ROUTE TABLE descriptor (last)(see table 299 in							
n - 4	10.4.3.17.4)							
n - 3	(MSB)	CRC						(LSB)
n								

 REJECT

The 6/11 LB call discussed whether to move the NUMBER OF REPORT EXPANDER ROUTE TABLE DESCRIPTORS field to byte 31 (immediately in front of the descriptor list), and decided not to do so.

Author: RElliott
Subject: Underline
Date: 6/30/2008 6:16:52 PM

T ACCEPT - DONE

REPORT EXPANDER ROUTE TABLE descriptor list

s/b

Expander route table descriptor list

The SMP FRAME TYPE field is defined in 10.4.3.3.2 and shall be set to the value defined in table 298.

The FUNCTION field is defined in 10.4.3.3.3 and shall be set to the value defined in table 298.

The FUNCTION RESULT field is defined in 10.4.3.3.4.

The RESPONSE LENGTH field is defined in 10.4.3.3.5 and shall be set to the value defined in table 298. A RESPONSE LENGTH field set to 00h does not have a special meaning based on the ALLOCATED RESPONSE LENGTH field in the request frame.

The EXPANDER CHANGE COUNT field is defined in the SMP REPORT GENERAL response (see 10.4.3.4).

The EXPANDER ROUTE TABLE CHANGE COUNT field counts the number of times the expander route table has been modified by the self-configuring expander device. Self-configuring expander devices shall support this field. This field shall be set to at least 0001h at power on. If the self-configuring expander device modified the expander route table since responding to a previous REPORT EXPANDER ROUTE TABLE LIST request, it shall increment this field at least once from the value in the previous REPORT EXPANDER ROUTE TABLE LIST response. This field shall wrap to at least 0001h after the maximum value (i.e., FFFFh) has been reached.

NOTE 122 - Application clients that use the EXPANDER ROUTE TABLE CHANGE COUNT field should read it often enough to ensure that it does not increment a multiple of 65 536 times between reading the field.

The CONFIGURING bit is defined in the REPORT GENERAL response (see 10.4.3.4).

The NUMBER OF REPORT EXPANDER ROUTE TABLE DESCRIPTORS field indicates the number of REPORT EXPANDER ROUTE TABLE descriptors contained in the REPORT EXPANDER ROUTE TABLE descriptor list.

The FIRST ROUTED SAS ADDRESS INDEX field indicates the index of the first REPORT EXPANDER ROUTE TABLE descriptor reported in the REPORT EXPANDER ROUTE TABLE descriptor list.

The LAST ROUTED SAS ADDRESS INDEX field indicates the index of the last REPORT EXPANDER ROUTE TABLE descriptor reported in the REPORT EXPANDER ROUTE TABLE descriptor list. The management application client may set the STARTING ROUTED SAS ADDRESS INDEX field in its next REPORT EXPANDER ROUTE TABLE LIST request to the value of this field plus one.

The STARTING PHY IDENTIFIER field indicates the value of the STARTING PHY IDENTIFIER field in the request frame.

The REPORT EXPANDER ROUTE TABLE descriptor list contains REPORT EXPANDER ROUTE TABLE descriptors as defined in 10.4.3.17.4.

The CRC field is defined in 10.4.3.3.8.

10.4.3.17.4 REPORT EXPANDER ROUTE TABLE descriptor

Table 299 defines the REPORT EXPANDER ROUTE TABLE descriptor.

Table 299 — REPORT EXPANDER ROUTE TABLE descriptor

Byte/Bit	7	6	5	4	3	2	1	0
0	ROUTED SAS ADDRESS							
7								
8	(starting phy identifier + 47)							(starting phy identifier + 40)
13	(starting phy identifier + 7)							(starting phy identifier)
14	ZONE GROUP VALID	Reserved						
15	ZONE GROUP							

Page: 626

Author: RElliott
Subject: Highlight
Date: 6/30/2008 6:16:52 PM
 ACCEPT - DONE

counts
s/b
indicates

Author: wdc-mevans
Subject: Highlight
Date: 5/6/2008 4:07:50 PM
 REJECT (would have to be "the self-configuring expander device" which is too wordy. There is no confusion about who "it" is here. Will add "then" though)

it
s/b
then the expander device

Author: Isi-gpenokie
Subject: Highlight
Date: 5/6/2008 4:07:50 PM
 REJECT (but will add "then")

This << request, it shall increment >> should be << request, the self-configuring expander device shall increment >>

Author: RElliott
Subject: Note
Date: 6/30/2008 6:16:52 PM
 ACCEPT - DONE

Add:
The self configuring bit is defined in the REPORT GENERAL response (see 10.4.3.4).
The zone configuring bit is defined in the REPORT GENERAL response (see 10.4.3.4).

to match Isi-bbesmer comment on first page

Author: RElliott
Subject: Cross-Out
Date: 6/30/2008 6:16:52 PM
 ACCEPT - DONE

contained

Author: RElliott
Subject: Underline
Date: 6/30/2008 6:16:52 PM
 ACCEPT - DONE

after:
indicates the value of the STARTING PHY IDENTIFIER field in the request frame.

add ", rounded down to a multiple of 48."

There is no function result to report an error if the STARTING PHY IDENTIFIER field in the request is not a multiple of 48, so this is a way to handle that possibility and keep the response data self-coherent.

Author: hpq-relliott
Subject: Note
Date: 6/20/2008 1:09:43 PM

Comments from page 626 continued on next page

The SMP FRAME TYPE field is defined in 10.4.3.3.2 and shall be set to the value defined in table 298.

The FUNCTION field is defined in 10.4.3.3.3 and shall be set to the value defined in table 298.

The FUNCTION RESULT field is defined in 10.4.3.3.4.

The RESPONSE LENGTH field is defined in 10.4.3.3.5 and shall be set to the value defined in table 298. A RESPONSE LENGTH field set to 00h does not have a special meaning based on the ALLOCATED RESPONSE LENGTH field in the request frame.

The EXPANDER CHANGE COUNT field is defined in the SMP REPORT GENERAL response (see 10.4.3.4).

The EXPANDER ROUTE TABLE CHANGE COUNT field **counts** the number of times the expander route table has been modified by the self-configuring expander device. Self-configuring expander devices shall support this field. This field shall be set to at least 0001h at power on. If the self-configuring expander device modified the expander route table since responding to a previous REPORT EXPANDER ROUTE TABLE LIST **request, it shall increment** this field at least once from the value in the previous REPORT EXPANDER ROUTE TABLE LIST response. This field shall wrap to at least 0001h after the maximum value (i.e., FFFFh) has been reached.

NOTE 122 - Application clients that use the EXPANDER ROUTE TABLE CHANGE COUNT field should read it often enough to ensure that it does not increment a multiple of 65 536 times between reading the field.

The CONFIGURING bit is defined in the REPORT GENERAL response (see 10.4.3.4).

The NUMBER OF REPORT EXPANDER ROUTE TABLE DESCRIPTORS field indicates the number of REPORT EXPANDER ROUTE TABLE descriptors **contained** in the REPORT EXPANDER ROUTE TABLE descriptor list.

The FIRST ROUTED SAS ADDRESS INDEX field indicates the index of the first REPORT EXPANDER ROUTE TABLE descriptor reported in the REPORT EXPANDER ROUTE TABLE descriptor list.

The LAST ROUTED SAS ADDRESS INDEX field indicates the index of the last REPORT EXPANDER ROUTE TABLE descriptor reported in the REPORT EXPANDER ROUTE TABLE descriptor list. The management application client may set the STARTING ROUTED SAS ADDRESS INDEX field in its next REPORT EXPANDER ROUTE TABLE LIST request to the value of this field plus one.

The STARTING PHY IDENTIFIER field indicates the value of the STARTING PHY IDENTIFIER field in the request frame.

The REPORT EXPANDER ROUTE TABLE descriptor list contains REPORT EXPANDER ROUTE TABLE descriptors as defined in 10.4.3.17.4.

The CRC field is defined in 10.4.3.3.8.

10.4.3.17.4 REPORT EXPANDER ROUTE TABLE descriptor

Table 299 defines the REPORT EXPANDER ROUTE TABLE descriptor.

Table 299 — REPORT EXPANDER ROUTE TABLE descriptor

Byte/Bit	7	6	5	4	3	2	1	0
0	ROUTED SAS ADDRESS							
7								
8	(starting phy identifier + 47)							(starting phy identifier + 40)
13	(starting phy identifier + 7)							(starting phy identifier)
14	ZONE GROUP VALID	Reserved						
15	ZONE GROUP							

ACCEPT - DONE (

Added:

"The expander route table descriptor list contains expander route table descriptors as defined in 10.4.3.17.4. The management device server shall return either all the expander route table descriptors that fit in one SMP response frame or all the expander route table descriptors until the index indicated in the last routed sas address index field is reached. The expander route table descriptor list shall start with the expander route table descriptor indicated by the first routed sas address index field, and continue with expander route table descriptors sorted in a vendor-specific order based on the routed SAS address index. The expander route table descriptor list shall not contain any truncated expander route table descriptors. If the first routed sas address index field is equal to the last routed sas address index field, then the expander route table descriptor at that index shall be returned."

6/11: no, don't want to require the device server to make the table look different just for clean presentation to the application client. The descriptors are sorted by the vendor-specific index. Make that clear.)

Require the REPORT EXPANDER ROUTE TABLE descriptor list be sorted in ascending order based on routed SAS address

(internally it need not be sorted, but for reporting purposes some order is helpful)

Author: RElliott
Subject: Underline
Date: 6/30/2008 6:16:52 PM

T ACCEPT - DONE

Global
REPORT EXPANDER ROUTE TABLE descriptor
s/b
expander route table descriptor

to match names of other descriptors.

The ROUTED SAS ADDRESS field indicates the routed SAS address.

The PHY BIT MAP field indicates the phy(s) to which connection requests to the SAS address indicated by the ROUTED SAS ADDRESS field may be forwarded. This field is a bit map where each bit position indicates a corresponding phy (e.g., bit zero of byte 5 indicates the phy indicated by the starting phy identifier). A bit set to one indicates that connection requests to the SAS address indicated by the ROUTED SAS ADDRESS field may be forwarded to the corresponding phy. A bit set to zero indicates that connection requests to the SAS address indicated by the ROUTED SAS ADDRESS field are not forwarded to that corresponding phy. Bits representing phys beyond the value of the NUMBER OF PHYS field reported in the REPORT GENERAL response (see 10.4.3.4) shall be set to zero.

A ZONE GROUP VALID bit set to zero indicates that the ZONE GROUP field shall be ignored. A ZONE GROUP VALID bit set to one indicates that the ZONE GROUP field is valid.

The ZONE GROUP field is defined in 4.9.3.1.

10.4.3.18 CONFIGURE GENERAL function

The CONFIGURE GENERAL function requests actions by the device containing the management device server. This SMP function may be implemented by any management device server. In zoning expander devices, if zoning is enabled then this function shall only be processed from SMP initiator ports that have access to zone group 2 (see 4.9.3.2).

● Author: Isi-gpenokie
Subject: Highlight
Date: 5/30/2008 5:03:23 PM

T ACCEPT - DONE (changed 5 to 13. The first and second 8 bytes swapped positions a while back.)

This << (e.g., bit zero of byte 5 indicates the phy indicated by the starting phy identifier). >> does not compute. Byte 5 is in the middle of the ROUTED SAS ADDRESS field.

● Author: RElliott
Subject: Highlight
Date: 6/30/2008 6:16:52 PM

T ACCEPT - DONE

enabled then
s/b
enabled, then

Table 300 defines the request format.

Table 300 — CONFIGURE GENERAL request

Byte\Bit	7	6	5	4	3	2	1	0
0	SMP FRAME TYPE (40h)							
1	FUNCTION (80h)							
2	ALLOCATED RESPONSE LENGTH							
3	REQUEST LENGTH (04h)							
4	(MSB)	EXPECTED EXPANDER CHANGE COUNT						(LSB)
5								
6	Reserved							
7								
8	Reserved		UPDATE STP REJECT TO OPEN LIMIT	UPDATE INITIAL TIME TO REDUCED FUNCTIONALITY	UPDATE STP SMP I_T NEXUS LOSS TIME	UPDATE STP MAXIMUM CONNECT TIME LIMIT	UPDATE STP BUS INACTIVITY TIME LIMIT	
9	Reserved							
10	(MSB)	STP BUS INACTIVITY TIME LIMIT						(LSB)
11								
12	(MSB)	STP MAXIMUM CONNECT TIME LIMIT						(LSB)
13								
14	(MSB)	STP SMP I_T NEXUS LOSS TIME						(LSB)
15								
16	INITIAL TIME TO REDUCED FUNCTIONALITY							
17	Reserved							
18	(MSB)	STP REJECT TO OPEN LIMIT						(LSB)
19								
20	(MSB)	CRC						(LSB)
23								

The SMP FRAME TYPE field is defined in 10.4.3.2.2 and shall be set to the value defined in table 300.

The FUNCTION field is defined in 10.4.3.2.3 and shall be set to the value defined in table 300.

The ALLOCATED RESPONSE LENGTH field is defined in 10.4.3.2.4.

The REQUEST LENGTH field is defined in 10.4.3.2.5 and shall be set to the value defined in table 300.

This page contains no comments

If the management device server is not in an expander device or the EXPECTED EXPANDER CHANGE COUNT field is set to 0000h, the EXPECTED EXPANDER CHANGE COUNT field shall be ignored. If the management device server is in an expander device and the EXPECTED EXPANDER CHANGE COUNT field is not set to 0000h, then:

- a) if the EXPECTED EXPANDER CHANGE COUNT field contains the current expander change count (i.e., the value of the EXPANDER CHANGE COUNT field that would be returned by an SMP REPORT GENERAL response at this time), the management device server shall process the function, and
- b) if the EXPECTED EXPANDER CHANGE COUNT field does not contain the current expander change count, the management device server shall return a function result of INVALID EXPANDER CHANGE COUNT in the response frame (see table 245 in 10.4.3.3).

An UPDATE STP REJECT TO OPEN LIMIT bit set to one specifies that the STP REJECT TO OPEN LIMIT field shall be honored. An UPDATE STP REJECT TO OPEN LIMIT bit set to zero specifies that the STP REJECT TO OPEN LIMIT field shall be ignored.

An UPDATE INITIAL TIME TO REDUCED FUNCTIONALITY bit set to one specifies that the INITIAL TIME TO REDUCED FUNCTIONALITY field shall be honored. An UPDATE INITIAL TIME TO REDUCED FUNCTIONALITY bit set to zero specifies that the INITIAL TIME TO REDUCED FUNCTIONALITY field shall be ignored.

An UPDATE STP BUS INACTIVITY TIME LIMIT bit set to one specifies that the STP BUS INACTIVITY TIME LIMIT field shall be honored. An UPDATE STP BUS INACTIVITY TIME LIMIT bit set to zero specifies that the STP BUS INACTIVITY TIME LIMIT field shall be ignored.

An UPDATE STP MAXIMUM CONNECT TIME LIMIT bit set to one specifies that the STP MAXIMUM CONNECT TIME LIMIT field shall be honored. An UPDATE STP MAXIMUM CONNECT TIME LIMIT bit set to zero specifies that the STP MAXIMUM CONNECT TIME LIMIT field shall be ignored.

An UPDATE STP SMP I_T NEXUS LOSS TIME bit set to one specifies that the STP SMP I_T NEXUS LOSS TIME field shall be honored. An UPDATE STP SMP I_T NEXUS LOSS TIME bit set to zero specifies that the STP SMP I_T NEXUS LOSS TIME field shall be ignored.

The STP BUS INACTIVITY TIME LIMIT field specifies the maximum time in 100 μs increments that an STP target port is permitted to maintain a connection (see 4.1.12) while transmitting and receiving SATA_SYNC. When this time is exceeded, the STP target port shall close the connection. A value of 0000h in this field specifies that there is no bus inactivity time limit. This value is reported in the STP BUS INACTIVITY TIME LIMIT field in the SMP REPORT GENERAL response (see 10.4.3.4). The bus inactivity time limit is enforced by the port layer (see 8.2.3).

The STP MAXIMUM CONNECT TIME LIMIT field specifies the maximum duration of a connection (see 4.1.12) in 100 μs increments (e.g., a value of 0001h in this field means that the time is less than or equal to 100 μs and a value of 0002h in this field means that the time is less than or equal to 200 μs). When this time is exceeded, the STP target port shall close the connection at the next opportunity. If the STP target port is transferring a frame when the maximum connection time limit is exceeded, the STP target port shall complete transfer of the frame before closing the connection. A value of 0000h in this field specifies that there is no maximum connection time limit. This value is reported in the STP MAXIMUM CONNECT TIME LIMIT field in the SMP REPORT GENERAL response (see 10.4.3.4). The maximum connection time limit is enforced by the port layer (see 8.2.3).

The STP SMP I_T NEXUS LOSS TIME field specifies the minimum time that an STP target port or SMP initiator port shall retry connection requests that are rejected with responses indicating the destination port may no longer be present (see 8.2.2) before recognizing an I_T nexus loss (see 4.5). Table 301 defines the values of the STP SMP I_T NEXUS LOSS TIME field. This value is enforced by the port layer (see 8.2.2).

Table 301 — STP SMP I_T NEXUS LOSS TIME field

Code	Description
0000h	Vendor-specific amount of time.
0001h to FFFEh	Time in milliseconds.
FFFFh	The port shall never recognize an I_T nexus loss (i.e., it shall retry the connection requests forever).

● Author: RElliott
Subject: Highlight
Date: 6/30/2008 6:16:52 PM

T ACCEPT - DONE
the
s/b
then the

● Author: Isi-gpenokie
Subject: Highlight
Date: 7/17/2008 10:19:48 PM

T ACCEPT - DONE (field returned if an SMP REPORT GENERAL function were processed at this time)

This << field that would be returned by >> should be << field that's returned by >>

● Author: Isi-gpenokie
Subject: Highlight
Date: 5/6/2008 4:07:50 PM

T ACCEPT - DONE

This << time), the management >> should be << time), then the management >>

● Author: Isi-gpenokie
Subject: Highlight
Date: 5/6/2008 4:07:50 PM

T ACCEPT - DONE

This << count, the management device >> should be << count, then the management device >>

● Author: Isi-gpenokie
Subject: Highlight
Date: 5/6/2008 4:07:50 PM

T ACCEPT - DONE

This << is exceeded, the STP target >> should be << is exceeded, then the STP target >>

NOTE 123 - The default value of the STP SMP I_T NEXUS LOSS TIME field should be non-zero. It is recommended that this value be 2 000 ms.

NOTE 124 - An STP initiator port should retry connection requests for at least the time indicated by the STP SMP I_T NEXUS LOSS TIME field in the SMP REPORT GENERAL response for the STP target port to which it is trying to establish a connection.

The INITIAL TIME TO REDUCED FUNCTIONALITY field specifies the minimum period of time, in 100 ms increments, that an expander device shall wait from originating a Broadcast (Expander) to reducing functionality (see 4.6.8). This value is reported in the INITIAL TIME TO REDUCED FUNCTIONALITY field in the SMP REPORT GENERAL response (see 10.4.3.4).

The STP REJECT TO OPEN LIMIT field specifies the minimum time in 10 μ s increments that an STP port shall wait to establish a connection request with an initiator port on an I_T nexus after receiving an OPEN_REJECT (RETRY), OPEN_REJECT (CONTINUE 0), or OPEN_REJECT (CONTINUE 1). This value may be rounded as defined in SPC-4. An STP REJECT TO OPEN LIMIT field set to 0000h specifies that the minimum time is vendor specific. This minimum time is enforced by the port layer (see 8.2.3). This value is reported in the STP REJECT TO OPEN LIMIT field in the SMP REPORT GENERAL response (see 10.4.3.4).

The CRC field is defined in 10.4.3.2.8.

Table 300 defines the response format.

Table 302 — CONFIGURE GENERAL response

Byte\Bit	7	6	5	4	3	2	1	0	
0	SMP FRAME TYPE (41h)								
1	FUNCTION (80h)								
2	FUNCTION RESULT								
3	RESPONSE LENGTH (00h)								
4	(MSB)	CRC							
7							(LSB)		

The SMP FRAME TYPE field is defined in 10.4.3.3.2 and shall be set to the value defined in table 302.

The FUNCTION field is defined in 10.4.3.3.3 and shall be set to the value defined in table 302.

The FUNCTION RESULT field is defined in 10.4.3.3.4.

The RESPONSE LENGTH field is defined in 10.4.3.3.5 and shall be set to the value defined in table 302. A RESPONSE LENGTH field set to 00h does not have a special meaning based on the ALLOCATED RESPONSE LENGTH field in the request frame.

The CRC field is defined in 10.4.3.3.8.

10.4.3.19 ENABLE DISABLE ZONING function

The ENABLE DISABLE ZONING function enables or disables zoning. This SMP function shall be supported by SMP target ports in zoning expander devices (see 4.9). Other SMP target ports shall not support this SMP function.

This function is an SMP zone configuration function (see 4.9.6.3).



Author: RElliott

Subject: Note

Date: 9/3/2008 6:58:01 PM

 ACCEPT - DONE

1) ENABLE DISABLE ZONING function is missing this paragraph:
SMP zone configuration functions change the zoning expander shadow values, which do not become zoning expander current values until the zoning expander device processes the activate step (see 4.9.6.4).

(from Brad Besmer, LSI)

Table 303 defines the request format.

Table 303 — ENABLE DISABLE ZONING request

Byte\Bit	7	6	5	4	3	2	1	0
0	SMP FRAME TYPE (40h)							
1	FUNCTION (81h)							
2	ALLOCATED RESPONSE LENGTH							
3	REQUEST LENGTH (02h)							
4	(MSB)	EXPECTED EXPANDER CHANGE COUNT						(LSB)
5								
6	Reserved						SAVE	
7	Reserved							
8	Reserved						ENABLE DISABLE ZONING	
9	Reserved							
11	Reserved							
12	(MSB)	CRC						(LSB)
15								

The SMP FRAME TYPE field is defined in 10.4.3.2.2 and shall be set to the value defined in table 303.

The FUNCTION field is defined in 10.4.3.2.3 and shall be set to the value defined in table 303.

The ALLOCATED RESPONSE LENGTH field is defined in 10.4.3.2.4.

The REQUEST LENGTH field is defined in 10.4.3.2.5 and shall be set to the value defined in table 303.

The EXPECTED EXPANDER CHANGE COUNT field is defined in the CONFIGURE GENERAL request (see 10.4.3.18).

The SAVE field specifies whether the management device server shall apply the specified changes to the current value and/or the saved value of the zoning enabled setting and is defined in table 304.

Table 304 — SAVE field

Code	Values updated	Return function result of SAVING NOT SUPPORTED if saving is not supported
00b	Current	no
01b	Saved ^a	yes
10b	Saved ^a , if saving is supported, and current.	no
11b	Saved ^a and current.	yes

^a The management device server shall return the function result without waiting for the save to complete, and set the SAVING bit to one in the REPORT GENERAL response until the save is complete.

Page: 631

Author: wdc-mevans

Subject: Highlight

Date: 5/6/2008 4:07:50 PM

T REJECT (it's not a question of whether the changes happen or not - something is always updated. The field dictates which values are updated)

whether

s/b

whether or not

Author: wdc-mevans

Subject: Highlight

Date: 5/6/2008 4:07:50 PM

T REJECT

setting and

s/b

setting. The SAVE field

Author: RElliott

Subject: Highlight

Date: 9/3/2008 6:56:02 PM

T ACCEPT - DONE

current value

s/b

shadow value

(from Brad Besmer, LSI)

Author: RElliott

Subject: Highlight

Date: 9/3/2008 6:56:33 PM

T ACCEPT - DONE

current

s/b

shadow

(from Brad Besmer, LSI)

Author: RElliott

Subject: Highlight

Date: 9/3/2008 6:56:11 PM

T ACCEPT - DONE

current

s/b

shadow

(from Brad Besmer, LSI)

Author: RElliott

Subject: Highlight

Date: 9/3/2008 6:56:21 PM

T ACCEPT - DONE

Comments from page 631 continued on next page

Table 303 defines the request format.

Table 303 — ENABLE DISABLE ZONING request

Byte\Bit	7	6	5	4	3	2	1	0
0	SMP FRAME TYPE (40h)							
1	FUNCTION (81h)							
2	ALLOCATED RESPONSE LENGTH							
3	REQUEST LENGTH (02h)							
4	(MSB)	EXPECTED EXPANDER CHANGE COUNT						(LSB)
5	Reserved						SAVE	
6	Reserved							
7	Reserved						ENABLE DISABLE ZONING	
8	Reserved							
9	Reserved							
11	Reserved							
12	(MSB)	CRC						(LSB)
15								

The SMP FRAME TYPE field is defined in 10.4.3.2.2 and shall be set to the value defined in table 303.

The FUNCTION field is defined in 10.4.3.2.3 and shall be set to the value defined in table 303.

The ALLOCATED RESPONSE LENGTH field is defined in 10.4.3.2.4.

The REQUEST LENGTH field is defined in 10.4.3.2.5 and shall be set to the value defined in table 303.

The EXPECTED EXPANDER CHANGE COUNT field is defined in the CONFIGURE GENERAL request (see 10.4.3.18).

The SAVE field specifies whether the management device server shall apply the specified changes to the current value and/or the saved value of the zoning enabled setting and is defined in table 304.

Table 304 — SAVE field

Code	Values updated	Return function result of SAVING NOT SUPPORTED if saving is not supported
00b	Current	no
01b	Saved ^a	yes
10b	Saved ^a , if saving is supported, and current.	no
11b	Saved ^a and current.	yes

^a The management device server shall return the function result without waiting for the save to complete, and set the SAVING bit to one in the REPORT GENERAL response until the save is complete.

current
s/b
shadow

(from Brad Besmer, LSI)

● Author: RElliott
Subject: Note
Date: 9/3/2008 7:21:36 PM
 ACCEPT - DONE

Add to a:
Saving only begins during the activate step (see 4.9.6.4).

to match comment in activate step section

The ENABLE DISABLE ZONING field is defined in table 305.

Table 305 — ENABLE DISABLE ZONING field

Code	Description
00b	No change
01b	Enable zoning
10b	Disable zoning
11b	Reserved

If the ENABLE DISABLE ZONING field is set to 11b (i.e., reserved), the management device server shall return a function result of UNKNOWN ENABLE DISABLE ZONING VALUE in the response frame (see table 245 in 10.4.3.3).

The CRC field is defined in 10.4.3.2.8.

Table 306 defines the response format.

Table 306 — ENABLE DISABLE ZONING response

Byte\Bit	7	6	5	4	3	2	1	0
0	SMP FRAME TYPE (41h)							
1	FUNCTION (81h)							
2	FUNCTION RESULT							
3	RESPONSE LENGTH (00h)							
4	(MSB)	CRC						(LSB)
7								

The SMP FRAME TYPE field is defined in 10.4.3.3.2 and shall be set to the value defined in table 306.

The FUNCTION field is defined in 10.4.3.3.3 and shall be set to the value defined in table 306.

The FUNCTION RESULT field is defined in 10.4.3.3.4.

The RESPONSE LENGTH field is defined in 10.4.3.3.5 and shall be set to the value defined in table 306. A RESPONSE LENGTH field set to 00h does not have a special meaning based on the ALLOCATED RESPONSE LENGTH field in the request frame.

The CRC field is defined in 10.4.3.3.8.

10.4.3.20 ZONED BROADCAST function

The ZONED BROADCAST function requests that the specified Broadcast (see 4.1.13) be forwarded as specified in 4.9.5. This SMP function shall be supported by management device servers in zoning expander devices (see 4.9). Other management device servers shall not support this SMP function. This SMP function shall only be processed from SMP initiator ports that have access to zone group 3 (see 4.9.3.2).

Author: RElliott
Subject: Highlight
Date: 6/30/2008 6:16:52 PM

T ACCEPT - DONE

the

s/b

then the

Table 307 defines the request format.

Table 307 — ZONED BROADCAST request

Byte\Bit	7	6	5	4	3	2	1	0
0	SMP FRAME TYPE (40h)							
1	FUNCTION (85h)							
2	ALLOCATED RESPONSE LENGTH							
3	REQUEST LENGTH $((n - 7) / 4)$							
4	Restricted							
5								
6	Reserved				BROADCAST TYPE			
7	NUMBER OF BROADCAST SOURCE ZONE GROUPS							
Broadcast source zone group list								
8	BROADCAST SOURCE ZONE GROUP (first)							
...	...							
	BROADCAST SOURCE ZONE GROUP (last)							
	PAD (if needed)							
n - 4								
n - 3	(MSB)							
	CRC							
n	(LSB)							

The SMP FRAME TYPE field is defined in 10.4.3.2.2 and shall be set to the value defined in table 307.

The FUNCTION field is defined in 10.4.3.2.3 and shall be set to the value defined in table 307.

The ALLOCATED RESPONSE LENGTH field is defined in 10.4.3.2.4.

The REQUEST LENGTH field is defined in 10.4.3.2.5 and shall be set to the value defined in table 307.

This page contains no comments

The BROADCAST TYPE field specifies the type of Broadcast that shall be forwarded and is defined in Table 308.

Table 308 — BROADCAST TYPE field

Code	Description
0000b	Broadcast (Change)
0001b	Broadcast (Reserved Change 0)
0010b	Broadcast (Reserved Change 1)
0011b	Broadcast (SES)
0100b	Broadcast (Expander)
0101b	Broadcast (Asynchronous Event)
0110b	Broadcast (Reserved 3)
0111b	Broadcast (Reserved 4)
1000b	Broadcast (Zone Activate)
All others	Reserved for Broadcasts only supported by the ZONED BROADCAST function

The NUMBER OF BROADCAST SOURCE ZONE GROUPS field specifies the number of zone groups to which the specified Broadcast is to be forwarded.

The broadcast source zone group list contains BROADCAST SOURCE ZONE GROUP fields.

Each BROADCAST SOURCE ZONE GROUP field specifies a source zone group for the Broadcast. The expander device forwards the Broadcast to each destination zone group accessible to that source zone group.

The PAD field contains zero, one, two, or three bytes set to 00h such that the total length of the SMP request is a multiple of four.

The CRC field is defined in 10.4.3.2.8.

Table 309 defines the response format.

Table 309 — ZONED BROADCAST response

Byte/Bit	7	6	5	4	3	2	1	0	
0	SMP FRAME TYPE (41h)								
1	FUNCTION (85h)								
2	FUNCTION RESULT								
3	RESPONSE LENGTH (00h)								
4	(MSB)	CRC							
7								(LSB)	

The SMP FRAME TYPE field is defined in 10.4.3.3.2 and shall be set to the value defined in table 309.

The FUNCTION field is defined in 10.4.3.3.3 and shall be set to the value defined in table 309.

The FUNCTION RESULT field is defined in 10.4.3.3.4.

The RESPONSE LENGTH field is defined in 10.4.3.3.5 and shall be set to the value defined in table 309. A RESPONSE LENGTH field set to 00h does not have a special meaning based on the ALLOCATED RESPONSE LENGTH field in the request frame.

● Author: hpq-relliott

Subject: Note

Date: 6/20/2008 7:56:28 PM

 ACCEPT - DONE (Added:

"The Broadcast source zone group list shall contain no more than one entry for each source zone group."

6/11 require that no source zone group be included more than once. Don't require sorting.)

Require the broadcast source zone group list to be sorted in ascending order.

● Author: RElliott

Subject: Highlight

Date: 6/30/2008 6:16:52 PM

 ACCEPT - DONE

at end of sentence with "forwards"

add:

"as specified in 4.9.5"

● Author: wdc-mevans

Subject: Highlight

Date: 5/26/2008 12:35:30 PM

 ACCEPT - DONE

four.

s/b

four bytes.

The CRC field is defined in 10.4.3.3.8.

10.4.3.21 ZONE LOCK function

The ZONE LOCK function locks a zoning expander device to provide exclusive access to SMP zone configuration functions (see 4.9.6.3) for one zone manager. All zoning expander devices shall support this function.

If:

- a) the ZONING ENABLED bit is set to one, the ZONE LOCKED bit is set to zero in the REPORT GENERAL response (see 10.4.3.4), and the SMP initiator port has access to zone group 2 (see 4.9.3.2);
- b) the ZONING ENABLED bit is set to one, the ZONE LOCKED bit is set to zero in the REPORT GENERAL response (see 10.4.3.4), and the PHYSICAL PRESENCE ASSERTED bit is set to one in the REPORT GENERAL response;
- c) the ZONING ENABLED bit is set to one, the ZONE LOCKED bit is set to zero in the REPORT GENERAL response (see 10.4.3.4), and the request contains the correct zone manager password (see 4.9.1);
- d) the ZONING ENABLED bit is set to zero and the PHYSICAL PRESENCE ASSERTED bit is set to one in the REPORT GENERAL response,
- e) the ZONING ENABLED bit is set to one, the ZONE LOCKED bit is set to one in the REPORT GENERAL response, and the request originated from the active zone manager; or
- f) the ZONING ENABLED bit is set to zero and the request contains the correct zone manager password,

then the management device server shall:

- a) set the ACTIVE ZONE MANAGER SAS ADDRESS field to the SAS address of the SMP initiator port in the ZONE LOCK response and the REPORT GENERAL response; and
- b) set the ZONE LOCKED bit to one in the REPORT GENERAL response.

When the management device server changes the ZONE LOCKED bit from zero to one, the locked zoning expander device sets the zoning expander shadow values equal to the zoning expander active values.

Table 310 defines the request format.

Table 310 — ZONE LOCK request

Byte\Bit	7	6	5	4	3	2	1	0
0	SMP FRAME TYPE (40h)							
1	FUNCTION (86h)							
2	ALLOCATED RESPONSE LENGTH							
3	REQUEST LENGTH (09h)							
4	(MSB)	EXPECTED EXPANDER CHANGE COUNT						(LSB)
5								
6	(MSB)	ZONE LOCK INACTIVITY TIME LIMIT						(LSB)
7								
8								
39	ZONE MANAGER PASSWORD							
40	(MSB)	CRC						(LSB)
43								

● Author: RElliott
Subject: Cross-Out
Date: 6/30/2008 6:16:52 PM
 ACCEPT - DONE

Delete this, as it is already in a)
(see 10.4.3.4),

● Author: RElliott
Subject: Cross-Out
Date: 6/30/2008 6:16:52 PM
 ACCEPT - DONE

Delete this, as it is already in a)
(see 10.4.3.4),

● Author: RElliott
Subject: Note
Date: 6/30/2008 6:16:52 PM
 ACCEPT - DONE

swap d) and e) so all the ZONING ENABLED bit set to one cases are together

The SMP FRAME TYPE field is defined in 10.4.3.2.2 and shall be set to the value defined in table 310.

The FUNCTION field is defined in 10.4.3.2.3 and shall be set to the value defined in table 310.

The ALLOCATED RESPONSE LENGTH field is defined in 10.4.3.2.4.

The REQUEST LENGTH field is defined in 10.4.3.2.5 and shall be set to the value defined in table 310.

The EXPECTED EXPANDER CHANGE COUNT field is defined in the CONFIGURE GENERAL request (see 10.4.3.18).

An ACTIVATE REQUIRED bit set to one specifies that the zoning expander device shall be unlocked only if the activate step has been completed. An ACTIVATE REQUIRED bit set to zero specifies that the zoning expander device shall be unlocked.

The ZONE LOCK INACTIVITY TIME LIMIT field specifies the minimum time that the locked expander device shall allow between any SMP zone configuration function requests or SMP ZONE LOCK requests from the active zone manager (i.e., the maximum time that a zone manager may allow to pass without accessing the locked expander device) and is reported in the SMP REPORT GENERAL response (see 10.4.3.21). This field specifies the number of 100 ms increments that a locked zoning expander device shall remain locked without processing any SMP zone configuration function or SMP ZONE LOCK function (e.g., a value of one in this field means that the time is less than or equal to 100 ms and a value of two in this field means that the time is less than or equal to 200 ms). A value of zero in this field specifies that there is no zone lock inactivity time limit (i.e., the zone lock inactivity timer is disabled).

The ZONE MANAGER PASSWORD field specifies a password used to allow permission to lock without physical presence being asserted.

The CRC field is defined in 10.4.3.2.8.

Table 311 defines the response format.

Table 311 — ZONE LOCK response

Byte\Bit	7	6	5	4	3	2	1	0
0	SMP FRAME TYPE (41h)							
1	FUNCTION (86h)							
2	FUNCTION RESULT							
3	RESPONSE LENGTH (03h)							
4	Reserved							
7								
8	ACTIVE ZONE MANAGER SAS ADDRESS							
15								
16	(MSB)	CRC						
19								(LSB)

The SMP FRAME TYPE field is defined in 10.4.3.3.2 and shall be set to the value defined in table 311.

The FUNCTION field is defined in 10.4.3.3.3 and shall be set to the value defined in table 311.

The FUNCTION RESULT field is defined in 10.4.3.3.4.

● Author: Isi-gpenokie
Subject: Highlight
Date: 5/26/2008 12:35:50 PM
T ACCEPT - DONE

This << response(see 10.4.3.21). >> should be << response (see 10.4.3.21). >> there is a missing space.

● Author: Isi-gpenokie
Subject: Highlight
Date: 5/30/2008 5:03:58 PM
T REJECT (5/7 "this field" is OK as long as other fields are not being mentioned in the paragraph.)

This << This field specifies the number of 100 ms >> should be << The ZOND LOCK INACTIVITY TIME LIMIT field specifies the number of 100 ms >>

● Author: RElliott
Subject: Highlight
Date: 6/30/2008 6:16:52 PM
T ACCEPT - DONE

one
s/b
0001h

● Author: RElliott
Subject: Highlight
Date: 6/30/2008 6:16:52 PM
T ACCEPT - DONE

two
s/b
0002h

● Author: RElliott
Subject: Highlight
Date: 6/30/2008 6:16:52 PM
T ACCEPT - DONE

zero
s/b
0000h

The RESPONSE LENGTH field is defined in 10.4.3.3.5 and shall be set to the value defined in table 311. A RESPONSE LENGTH field set to 00h does not have a special meaning based on the ALLOCATED RESPONSE LENGTH field in the request frame.

The ACTIVE ZONE MANAGER SAS ADDRESS field is defined in the REPORT GENERAL response (see 10.4.3.4).

The CRC field is defined in 10.4.3.3.8.

10.4.3.22 ZONE ACTIVATE function

The ZONE ACTIVATE function causes the zoning expander device to set the zoning expander active values equal to the zoning expander shadow values (see 4.9.6.4). All zoning expander devices shall support this function. This function is an SMP zone configuration function (see 4.9.6.3).

Table 312 defines the request format.

Table 312 — ZONE ACTIVATE request

Byte\Bit	7	6	5	4	3	2	1	0
0	SMP FRAME TYPE (40h)							
1	FUNCTION (87h)							
2	ALLOCATED RESPONSE LENGTH							
3	REQUEST LENGTH (01h)							
4	(MSB)	EXPECTED EXPANDER CHANGE COUNT						(LSB)
5								
6	Reserved							
7								
8	(MSB)	CRC						(LSB)
11								

The SMP FRAME TYPE field is defined in 10.4.3.2.2 and shall be set to the value defined in table 312.

The FUNCTION field is defined in 10.4.3.2.3 and shall be set to the value defined in table 312.

The ALLOCATED RESPONSE LENGTH field is defined in 10.4.3.2.4.

The REQUEST LENGTH field is defined in 10.4.3.2.5 and shall be set to the value defined in table 312.

The EXPECTED EXPANDER CHANGE COUNT field is defined in the CONFIGURE GENERAL request (see 10.4.3.18).

The CRC field is defined in 10.4.3.2.8.

This page contains no comments

Table 313 defines the response format.

Table 313 — ZONE ACTIVATE response

Byte\Bit	7	6	5	4	3	2	1	0	
0	SMP FRAME TYPE (41h)								
1	FUNCTION (87h)								
2	FUNCTION RESULT								
3	RESPONSE LENGTH (00h)								
4	(MSB)	CRC							
7								(LSB)	

The SMP FRAME TYPE field is defined in 10.4.3.3.2 and shall be set to the value defined in table 313.

The FUNCTION field is defined in 10.4.3.3.3 and shall be set to the value defined in table 313.

The FUNCTION RESULT field is defined in 10.4.3.3.4.

The RESPONSE LENGTH field is defined in 10.4.3.3.5 and shall be set to the value defined in table 313. A RESPONSE LENGTH field set to 00h does not have a special meaning based on the ALLOCATED RESPONSE LENGTH field in the request frame.

The CRC field is defined in 10.4.3.3.8.

10.4.3.23 ZONE UNLOCK function

The ZONE UNLOCK function unlocks a zoning expander device (see 4.9.6.5). All zoning expander devices shall support this function. This function is an SMP zone configuration function (see 4.9.6.3).

If a locked zoning expander device processes a ZONE UNLOCK request from the active zone manager then the management device server shall set the ZONE LOCKED bit to zero in the REPORT GENERAL response (see 10.4.3.4). If the CONFIGURING bit is set to one in the REPORT GENERAL response then the zoning expander device shall set the CONFIGURING bit to zero and originate a Broadcast (Change) from either:

- a) each zone group whose zone permission table entries or zone phy information has changed; or
- b) zone group 1.

● Author: RElliott
Subject: Highlight
Date: 6/30/2008 6:16:52 PM
 ACCEPT - DONE

CONFIGURING bit
s/b
ZONE CONFIGURING bit

to match Isi-bbesmer comment on first page

● Author: RElliott
Subject: Note
Date: 8/31/2008 6:38:03 PM

 ACCEPT - DONE (7/14 yes, keep the Broadcast rule in the model section only. See comment in that section about preserving the if configuring bit was set to one rule.)

Should this Broadcast (Change) rule just refer to 4.9.6.5?

● Author: RElliott
Subject: Highlight
Date: 6/30/2008 6:16:52 PM
 ACCEPT - DONE

CONFIGURING bit
s/b
ZONE CONFIGURING bit

to match Isi-bbesmer comment on first page

Table 314 defines the request format.

Table 314 — ZONE UNLOCK request

Byte\Bit	7	6	5	4	3	2	1	0	
0	SMP FRAME TYPE (40h)								
1	FUNCTION (88h)								
2	ALLOCATED RESPONSE LENGTH								
3	REQUEST LENGTH (01h)								
4	Restricted								
5	Reserved								
6	Reserved							ACTIVATE REQUIRED	
7	Reserved								
8	(MSB)	CRC							
11							(LSB)		

The SMP FRAME TYPE field is defined in 10.4.3.2.2 and shall be set to the value defined in table 314.

The FUNCTION field is defined in 10.4.3.2.3 and shall be set to the value defined in table 312.

The ALLOCATED RESPONSE LENGTH field is defined in 10.4.3.2.4.

The REQUEST LENGTH field is defined in 10.4.3.2.5 and shall be set to the value defined in table 312.

An ACTIVATE REQUIRED bit set to one specifies that the management device server shall unlock the zoning expander device only if the activate step has been completed. An ACTIVATE REQUIRED bit set to zero specifies that the management device server shall unlock the zoning expander device regardless of whether the activate step has been completed.

The CRC field is defined in 10.4.3.2.8.

Table 315 defines the response format.

Table 315 — ZONE UNLOCK response

Byte\Bit	7	6	5	4	3	2	1	0	
0	SMP FRAME TYPE (41h)								
1	FUNCTION (88h)								
2	FUNCTION RESULT								
3	RESPONSE LENGTH (00h)								
4	(MSB)	CRC							
7							(LSB)		

The SMP FRAME TYPE field is defined in 10.4.3.3.2 and shall be set to the value defined in table 315.

The FUNCTION field is defined in 10.4.3.3.3 and shall be set to the value defined in table 315.

This page contains no comments

The FUNCTION RESULT field is defined in 10.4.3.3.4.

The RESPONSE LENGTH field is defined in 10.4.3.3.5 and shall be set to the value defined in table 315. A RESPONSE LENGTH field set to 00h does not have a special meaning based on the ALLOCATED RESPONSE LENGTH field in the request frame.

The CRC field is defined in 10.4.3.3.8.

10.4.3.24 CONFIGURE ZONE MANAGER PASSWORD function

The CONFIGURE ZONE MANAGER PASSWORD function configures the zone manager password (see 4.9.1). This SMP function shall be supported by SMP target ports in zoning expander devices. Other SMP target ports shall not support this SMP function. This SMP function shall only be processed if:

- a) the request is received from any SMP initiator port and specifies the correct zone manager password; or
- b) the request is received from any SMP initiator port while physical presence is asserted.

Table 316 defines the request format.

Table 316 — CONFIGURE ZONE MANAGER PASSWORD request

Byte\Bit	7	6	5	4	3	2	1	0
0	SMP FRAME TYPE (40h)							
1	FUNCTION (89h)							
2	ALLOCATED RESPONSE LENGTH							
3	REQUEST LENGTH (11h)							
4	(MSB)	EXPECTED EXPANDER CHANGE COUNT						(LSB)
5	Reserved						SAVE	
6	Reserved							
7	Reserved							
8	ZONE MANAGER PASSWORD							
39	ZONE MANAGER PASSWORD							
40	NEW ZONE MANAGER PASSWORD							
71	NEW ZONE MANAGER PASSWORD							
72	(MSB)	CRC						(LSB)
75	CRC							

The SMP FRAME TYPE field is defined in 10.4.3.2.2 and shall be set to the value defined in table 316.

The FUNCTION field is defined in 10.4.3.2.3 and shall be set to the value defined in table 316.

The ALLOCATED RESPONSE LENGTH field is defined in 10.4.3.2.4.

The REQUEST LENGTH field is defined in 10.4.3.2.5 and shall be set to the value defined in table 316.

The EXPECTED EXPANDER CHANGE COUNT field is defined in the CONFIGURE GENERAL request (see 10.4.3.18).

● Author: RElliott
Subject: Highlight
Date: 6/30/2008 6:16:52 PM
T ACCEPT - DONE

SMP target ports
s/b
management device servers

● Author: RElliott
Subject: Highlight
Date: 6/30/2008 6:16:52 PM
T ACCEPT - DONE

SMP target ports
s/b
management device servers

The SAVE field specifies whether the management device server shall apply the specified changes to the current value and/or the saved value of the zone manager password and is defined in table 317.

Table 317 — SAVE field

Code	Values updated	Return function result of SAVING NOT SUPPORTED if saving is not supported
00b	Current	no
01b	Saved ^a	yes
10b	Saved ^a , if saving is supported, and current.	no
11b	Saved ^a and current.	yes

^a The management device server shall return the function result without waiting for the save to complete, and set the SAVING bit to one in the REPORT GENERAL response until the save is complete.

If physical presence is not asserted and the ZONE MANAGER PASSWORD field does not match the current zone manager password maintained by the management device server, then the management device server shall return a function result of NO MANAGEMENT ACCESS RIGHTS in the response frame (see table 245 in 10.4.3.3).

The NEW ZONE MANAGER PASSWORD field specifies a new value for the zone manager password maintained by the management device server. A NEW ZONE MANAGER PASSWORD field set to zero specifies that the zone manager password is disabled and all zone managers have access. A NEW ZONE MANAGER PASSWORD field set to DISABLED (see table 26 in 4.9.1) specifies that the zone manager password is disabled and shall only be allowed if physical presence is asserted.

The CRC field is defined in 10.4.3.2.8.

Table 318 defines the response format.

Table 318 — CONFIGURE ZONE MANAGER PASSWORD response

Byte\Bit	7	6	5	4	3	2	1	0
0	SMP FRAME TYPE (41h)							
1	FUNCTION (89h)							
2	FUNCTION RESULT							
3	RESPONSE LENGTH (00h)							
4	(MSB)	CRC						(LSB)
7								

The SMP FRAME TYPE field is defined in 10.4.3.3.2 and shall be set to the value defined in table 318.

The FUNCTION field is defined in 10.4.3.3.3 and shall be set to the value defined in table 318.

The FUNCTION RESULT field is defined in 10.4.3.3.4.

The RESPONSE LENGTH field is defined in 10.4.3.3.5 and shall be set to the value defined in table 318. A RESPONSE LENGTH field set to 00h does not have a special meaning based on the ALLOCATED RESPONSE LENGTH field in the request frame.

The CRC field is defined in 10.4.3.3.8.

● Author: RElliott
Subject: Note
Date: 9/2/2008 7:06:49 PM
 ACCEPT - DONE

Add footnote emphasizing that this does update current values, not shadow values. There is no shadow password.

● Author: RElliott
Subject: Underline
Date: 6/30/2008 6:16:52 PM
 ACCEPT - DONE

zero
s/b
ZERO (see table 26 in 4.9.1)

● Author: RElliott
Subject: Highlight
Date: 6/30/2008 6:16:52 PM
 ACCEPT - DONE

and shall
s/b
and access shall

● Author: hpq-relliott
Subject: Note
Date: 9/2/2008 7:25:29 PM
 ACCEPT - DONE (29h assigned to DISABLED PASSWORD NOT SUPPORTED)

7/14 yes, add a new function result for this)

The expander device should be allowed to prohibit use of DISABLED (policy choice). If so, define which function result to return if it is attempted.

10.4.3.25 CONFIGURE ZONE PHY INFORMATION function

10.4.3.25.1 CONFIGURE ZONE PHY INFORMATION function overview

The CONFIGURE ZONE PHY INFORMATION function configures zone phy information for one or more phys in a locked zoning expander device. This function shall be supported by all zoning expander devices. This function is an SMP zone configuration function (see 4.9.6.3).

SMP zone configuration functions change the zoning expander shadow values. These do not become zoning expander active values until the activate step (see 4.9.6.4).

10.4.3.25.2 CONFIGURE ZONE PHY INFORMATION request

Table 319 defines the request format.

Table 319 — CONFIGURE ZONE PHY INFORMATION request

Byte\Bit	7	6	5	4	3	2	1	0
0	SMP FRAME TYPE (40h)							
1	FUNCTION (8Ah)							
2	ALLOCATED RESPONSE LENGTH							
3	REQUEST LENGTH ((n - 7) / 4)							
4	(MSB)	EXPECTED EXPANDER CHANGE COUNT						(LSB)
5	Reserved						SAVE	
6	NUMBER OF ZONE PHY CONFIGURATION DESCRIPTORS							
7	Zone phy configuration descriptor list							
8	Zone phy configuration descriptor (first)(see table 321 in 10.4.3.25.3)							
11	...							
n - 7	Zone phy configuration descriptor (last)(see table 321 in 10.4.3.25.3)							
n - 4	...							
n - 3	(MSB)	CRC						(LSB)
n								

The SMP FRAME TYPE field is defined in 10.4.3.2.2 and shall be set to the value defined in table 319.

The FUNCTION field is defined in 10.4.3.2.3 and shall be set to the value defined in table 319.

The ALLOCATED RESPONSE LENGTH field is defined in 10.4.3.2.4.

The REQUEST LENGTH field is defined in 10.4.3.2.5 and shall be set to the value defined in table 319.

The EXPECTED EXPANDER CHANGE COUNT field is defined in the SMP CONFIGURE GENERAL request (see 10.4.3.18).

● Author: RElliott
Subject: Highlight
Date: 9/3/2008 6:57:44 PM
 ACCEPT - DONE

values. These do
s/b
values, which do

● Author: RElliott
Subject: Note
Date: 6/30/2008 6:16:52 PM
 ACCEPT - DONE

Per 6/11 LB call, change the reserved bits in byte 6 to a Zone Phy Configuration Descriptor Length field.

The participants preferred not to extend the length of this frame. Since the descriptor is only 4 bytes so far, it is unlikely that restricting the field to 6 bits will cause problems.

● Author: RElliott
Subject: Note
Date: 6/30/2008 6:16:52 PM
 REJECT

The 6/11 LB call discussed whether to add 4 bytes to the CONFIGURE ZONE PHY INFORMATION request frame to allow for a one-byte ZONE PHY CONFIGURATION DESCRIPTOR LENGTH field (like the others all have), and decided not to do so.

The SAVE field specifies whether the management device server shall apply the specified changes to the **current value** and/or the saved value of the zone phy information and is defined in table 320.

Table 320 — SAVE field

Code	Values updated	Return function result of SAVING NOT SUPPORTED if saving is not supported
00b	Current	no
01b	Saved ^a	yes
10b	Saved ^a , if saving is supported, and current .	no
11b	Saved ^a and current .	yes

^a The management device server shall return the function result without waiting for the save to complete, and set the SAVING bit to one in the REPORT GENERAL response until the save is complete.

The NUMBER OF ZONE PHY CONFIGURATION DESCRIPTORS field specifies the number of zone phy configuration descriptors in the **request**.

The zone phy configuration descriptor list contains zone phy configuration descriptors as defined in 10.4.3.25.3.

The CRC field is defined in 10.4.3.2.8.

10.4.3.25.3 Zone phy configuration descriptor

Table 321 defines the zone phy configuration descriptor.

Table 321 — Zone phy configuration descriptor

Byte\Bit	7	6	5	4	3	2	1	0
0	PHY IDENTIFIER							
1	Reserved	INSIDE ZPSDS PERSISTENT	REQUESTED INSIDE ZPSDS	Reserved	ZONE GROUP PERSISTENT	Reserved		
2	Reserved							
3	ZONE GROUP							

The PHY IDENTIFIER field specifies the phy to which the zone phy configuration descriptor information shall be applied.

The INSIDE ZPSDS PERSISTENT bit specifies the value of the INSIDE ZPSDS PERSISTENT bit in the zone phy information (see 4.9.3.1).

The REQUESTED INSIDE ZPSDS bit specifies the value of the REQUESTED INSIDE ZPSDS bit in the zone phy information (see 4.9.3.1).

The ZONE GROUP PERSISTENT bit specifies the value of the ZONE GROUP PERSISTENT bit in the zone phy information (see 4.9.3.1).

The ZONE GROUP field specifies the value of the ZONE GROUP field in the zone phy information (see 4.9.3.1).

Page: 643

● Author: RElliott
Subject: Highlight
Date: 9/3/2008 7:07:59 PM
 ACCEPT - DONE

current value
s/b
saved value

(per Brad Besmer, LSI and Tim Symons, PMC-Sierra)

● Author: RElliott
Subject: Highlight
Date: 9/3/2008 7:08:09 PM
 ACCEPT - DONE

Current
s/b
Saved

(per Brad Besmer, LSI and Tim Symons, PMC-Sierra)

● Author: RElliott
Subject: Highlight
Date: 9/3/2008 7:08:26 PM
 ACCEPT - DONE

current
s/b
saved

(per Brad Besmer, LSI and Tim Symons, PMC-Sierra)

● Author: RElliott
Subject: Highlight
Date: 9/3/2008 7:08:35 PM
 ACCEPT - DONE

current
s/b
saved

(per Brad Besmer, LSI and Tim Symons, PMC-Sierra)

● Author: RElliott
Subject: Note
Date: 9/3/2008 7:21:48 PM
 ACCEPT - DONE

Add to a:
Saving only begins during the activate step (see 4.9.6.4).

to match comment in activate step section

● Author: RElliott

Comments from page 643 continued on next page

The SAVE field specifies whether the management device server shall apply the specified changes to the **current value** and/or the saved value of the zone phy information and is defined in table 320.

Table 320 — SAVE field

Code	Values updated	Return function result of SAVING NOT SUPPORTED if saving is not supported
00b	Current	no
01b	Saved ^a	yes
10b	Saved ^a , if saving is supported, and current.	no
11b	Saved ^a and current.	yes

^a The management device server shall return the function result without waiting for the save to complete and set the SAVING bit to one in the REPORT GENERAL response until the save is complete.

The NUMBER OF ZONE PHY CONFIGURATION DESCRIPTORS field specifies the number of zone phy configuration descriptors in the **request.**

The zone phy configuration descriptor list contains zone phy configuration descriptors as defined in 10.4.3.25.3.

The CRC field is defined in 10.4.3.2.8.

10.4.3.25.3 Zone phy configuration descriptor

Table 321 defines the zone phy configuration descriptor.

Table 321 — Zone phy configuration descriptor

Byte\Bit	7	6	5	4	3	2	1	0
0	PHY IDENTIFIER							
1	Reserved	INSIDE ZPSDS PERSISTENT	REQUESTED INSIDE ZPSDS	Reserved	ZONE GROUP PERSISTENT	Reserved		
2	Reserved							
3	ZONE GROUP							

The PHY IDENTIFIER field specifies the phy to which the zone phy configuration descriptor information shall be applied.

The INSIDE ZPSDS PERSISTENT bit specifies the value of the INSIDE ZPSDS PERSISTENT bit in the zone phy information (see 4.9.3.1).

The REQUESTED INSIDE ZPSDS bit specifies the value of the REQUESTED INSIDE ZPSDS bit in the zone phy information (see 4.9.3.1).

The ZONE GROUP PERSISTENT bit specifies the value of the ZONE GROUP PERSISTENT bit in the zone phy information (see 4.9.3.1).

The ZONE GROUP field specifies the value of the ZONE GROUP field in the zone phy information (see 4.9.3.1).

Subject: Highlight
Date: 6/30/2008 6:16:52 PM
 ACCEPT - DONE

request
s/b
zone phy configuration descriptor list

● Author: RElliott
Subject: Note
Date: 6/30/2008 6:16:52 PM
 ACCEPT - DONE
Add:

Because the maximum number of response bytes is 1 023 bytes (see 9.4.3), the length of the header is 8 bytes, and the length of the zone phy configuration descriptor is 4 bytes, the zone phy configuration descriptor list has a maximum of 254 entries.

● Author: hpq-relliott
Subject: Note
Date: 6/20/2008 1:28:06 PM
 ACCEPT - DONE (

Added:
"contains... for each expander phy in the expander device."

Added:
"The zone phy configuration descriptor list shall contain no more than one zone phy configuration descriptor with the same value in the phy identifier field."

6/11 no sort needed. No duplicates allowed, though.)

Require the zone phy configuration descriptor list to be sorted in ascending order based on phy identifier

10.4.3.25.4 CONFIGURE ZONE PHY INFORMATION response

Table 322 defines the response format.

Table 322 — CONFIGURE ZONE PHY INFORMATION response

Byte\Bit	7	6	5	4	3	2	1	0	
0	SMP FRAME TYPE (41h)								
1	FUNCTION (8Ah)								
2	FUNCTION RESULT								
3	RESPONSE LENGTH (00h)								
4	(MSB)	CRC							
7								(LSB)	

The SMP FRAME TYPE field is defined in 10.4.3.3.2 and shall be set to the value defined in table 322.

The FUNCTION field is defined in 10.4.3.3.3 and shall be set to the value defined in table 322.

The FUNCTION RESULT field is defined in 10.4.3.3.4.

The RESPONSE LENGTH field is defined in 10.4.3.3.5 and shall be set to the value defined in table 322. A RESPONSE LENGTH field set to 00h does not have a special meaning based on the ALLOCATED RESPONSE LENGTH field in the request frame.

The CRC field is defined in 10.4.3.3.8.

10.4.3.26 CONFIGURE ZONE PERMISSION TABLE function**10.4.3.26.1 CONFIGURE ZONE PERMISSION TABLE function overview**

The CONFIGURE ZONE PERMISSION TABLE function configures the zone permission table. This function shall be supported by all zoning expander devices. This function is an SMP zone configuration function (see 4.9.6.3).

SMP zone configuration functions change the zoning expander shadow values and do not become zoning expander active values until the zoning expander device processes the activate step (see 4.9.6.4).

Annex I describes examples of using multiple zone configuration descriptors.

Author: RElliott
Subject: Highlight
Date: 9/3/2008 7:09:33 PM
ACCEPT - DONE

T

values and do not
s/b
values, which do not

10.4.3.26.2 CONFIGURE ZONE PERMISSION TABLE request

Table 323 defines the request format.

Table 323 — CONFIGURE ZONE PERMISSION TABLE request

Byte/Bit	7	6	5	4	3	2	1	0
0	SMP FRAME TYPE (40h)							
1	FUNCTION (8Bh)							
2	ALLOCATED RESPONSE LENGTH							
3	REQUEST LENGTH $((n - 7) / 4)$							
4	(MSB)	EXPECTED EXPANDER CHANGE COUNT						(LSB)
5								
6	STARTING SOURCE ZONE GROUP							
7	NUMBER OF ZONE PERMISSION CONFIGURATION DESCRIPTORS							
8	NUMBER OF ZONE GROUPS	Reserved				SAVE		
9	Reserved							
15	Reserved							
Zone permission configuration descriptor list								
16	Zone permission configuration descriptor (first)(see table 326 in 10.4.3.26.3)							
31	...							
n - 20	Zone permission configuration descriptor (last)(see table 326 in 10.4.3.26.3)							
n - 4								
n - 3	(MSB)	CRC						(LSB)
n								

The SMP FRAME TYPE field is defined in 10.4.3.2.2 and shall be set to the value defined in table 323.

The FUNCTION field is defined in 10.4.3.2.3 and shall be set to the value defined in table 323.

The ALLOCATED RESPONSE LENGTH field is defined in 10.4.3.2.4.

The REQUEST LENGTH field is defined in 10.4.3.2.5 and shall be set to the value defined in table 323.

The EXPECTED EXPANDER CHANGE COUNT field is defined in the SMP CONFIGURE GENERAL request (see 10.4.3.18).

The STARTING SOURCE GROUP field specifies the first source zone group (i.e., s) to be written with the first zone permission configuration descriptor.

The NUMBER OF ZONE PERMISSION CONFIGURATION DESCRIPTORS field specifies the number of zone permission configuration descriptors that follow.

Page: 645

● Author: RElliott
Subject: Note
Date: 6/30/2008 6:16:52 PM
 REJECT

The 6/11 LB call discussed whether to move the NUMBER OF ZONE CONFIGURATION DESCRIPTORS field to byte 15 (immediately in front of the descriptor list), and decided not to do so.

● Author: RElliott
Subject: Note
Date: 6/30/2008 6:16:52 PM
 ACCEPT - DONE

Per the 6/11 LB call, add a Zone Permission Configuration Descriptor Length field (in byte 9). Do not move the Number Of field to byte 14.

The Number Of Zone Groups field sort of does the same thing, but this will let the descriptor grow beyond just having zone group bits. Also, this field is always understandable while the Reserved values for the Number Of Zone Groups field (which could be defined in the future) cannot be understood by current software.

● Author: lsi-gpenokie
Subject: Cross-Out
Date: 5/29/2008 5:52:19 PM
 ACCEPT - DONE (also applied globally to similar wording. Added "in the zone permission configuration descriptor list")

This << that follow >> is not needed.

The NUMBER OF ZONE GROUPS field specifies the number of elements in each zone permission configuration descriptor and is defined in table 324.

Table 324 — NUMBER OF ZONE GROUPS field

Code	Description
00b	128 zone groups
01b	256 zone groups
All others	Reserved

The SAVE field specifies whether the management device server shall apply the specified changes to the current value and/or the saved value of the zone permission table and is defined in table 325.

Table 325 — SAVE field

Code	Values updated	Return function result of SAVING NOT SUPPORTED if saving is not supported
00b	Current	no
01b	Saved ^a	yes
10b	Saved ^a , if saving is supported, and current.	no
11b	Saved ^a and current.	yes

^a The management device server shall return the function result without waiting for the save to complete, and set the SAVING bit to one in the REPORT GENERAL response until the save is complete.

The zone permission configuration descriptor list contains zone permission configuration descriptors as defined in 10.4.3.26.3. The device server shall process the zone permission configuration descriptors in order (i.e., a subsequent zone permission configuration descriptor overrides a previous zone permission configuration descriptor).

The CRC field is defined in 10.4.3.2.8.

10.4.3.26.3 Zone permission configuration descriptor

Table 326 defines the zone permission configuration descriptor containing 128 zone groups.

Table 326 — Zone permission configuration descriptor for source zone group (i.e., s) for 128 zone groups

Byte\Bit	7	6	5	4	3	2	1	0
0	ZP[s, 127]	ZP[s, 126]	ZP[s, 125]	ZP[s, 124]	ZP[s, 123]	ZP[s, 122]	ZP[s, 121]	ZP[s, 120]
...	...							
15	ZP[s, 7] (ignored)	ZP[s, 6] (ignored)	ZP[s, 5] (ignored)	ZP[s, 4] (ignored)	ZP[s, 3]	ZP[s, 2]	ZP[s, 1] (ignored)	ZP[s, 0] (ignored)

● Author: RElliott
Subject: Highlight
Date: 9/3/2008 7:44:35 PM

 ACCEPT - DONE
current
s/b
shadow

(per Brad Besmer)

● Author: RElliott
Subject: Highlight
Date: 9/3/2008 7:44:32 PM

 ACCEPT - DONE
current
s/b
shadow

(per Brad Besmer)

● Author: RElliott
Subject: Highlight
Date: 9/3/2008 7:44:40 PM

 ACCEPT - DONE
current
s/b
shadow

(per Brad Besmer)

● Author: RElliott
Subject: Highlight
Date: 9/3/2008 7:44:44 PM

 ACCEPT - DONE
current
s/b
shadow

(per Brad Besmer)

● Author: RElliott
Subject: Note
Date: 9/3/2008 7:21:55 PM

 ACCEPT - DONE

Add to a:
Saving only begins during the activate step (see 4.9.6.4).

to match comment in activate step section

● Author: RElliott
Subject: Underline
Date: 6/30/2008 6:16:52 PM

 ACCEPT - DONE

The NUMBER OF ZONE GROUPS field specifies the number of elements in each zone permission configuration descriptor and is defined in table 324.

Table 324 — NUMBER OF ZONE GROUPS field

Code	Description
00b	128 zone groups
01b	256 zone groups
All others	Reserved

The SAVE field specifies whether the management device server shall apply the specified changes to the **current** value and/or the saved value of the zone permission table and is defined in table 325.

Table 325 — SAVE field

Code	Values updated	Return function result of SAVING NOT SUPPORTED if saving is not supported
00b	Current	no
01b	Saved ^a	yes
10b	Saved ^a , if saving is supported, and current .	no
11b	Saved ^a and current .	yes

^a The management device server shall return the function result without waiting for the save to complete, and set the SAVING bit to one in the REPORT GENERAL response until the save is complete.

The zone permission configuration descriptor list contains zone permission configuration descriptors as defined in 10.4.3.26.3. The device server shall process the zone permission configuration descriptors in order (i.e., a subsequent zone permission configuration descriptor overrides a previous zone permission configuration descriptor).

The CRC field is defined in 10.4.3.2.8.

10.4.3.26.3 Zone permission configuration descriptor

Table 326 defines the zone permission configuration descriptor containing 128 zone groups.

Table 326 — Zone permission configuration descriptor for source zone group (i.e., s) for 128 zone groups

Byte\Bit	7	6	5	4	3	2	1	0
0	ZP[s, 127]	ZP[s, 126]	ZP[s, 125]	ZP[s, 124]	ZP[s, 123]	ZP[s, 122]	ZP[s, 121]	ZP[s, 120]
...	...							
15	ZP[s, 7] (ignored)	ZP[s, 6] (ignored)	ZP[s, 5] (ignored)	ZP[s, 4] (ignored)	ZP[s, 3]	ZP[s, 2]	ZP[s, 1] (ignored)	ZP[s, 0] (ignored)

The zone permission configuration descriptor list contains zone permission configuration descriptors as defined in 10.4.3.26.3.
s/b

The zone permission configuration descriptor list contains a zone permission configuration descriptor as defined in 10.4.3.26.3 for each source zone group in ascending order starting with the source zone group specified in the starting source group field.

so the sorting order is explicit.

Author: RElliott
Subject: Note
Date: 6/30/2008 6:16:52 PM

 ACCEPT - DONE

Add:

The zone permission configuration descriptor format is based on the number of zone groups field as defined in table 328.
with a table showing:

Number Of Zone Groups field Zone permission configuration descriptor format

00b Table 329

01b Table 330

All others Reserved

Table 327 defines the zone permission configuration descriptor containing 256 zone groups.

Table 327 — Zone permission configuration descriptor for source zone group (i.e., s) for 256 zone groups

Byte\Bit	7	6	5	4	3	2	1	0
0	ZP[s, 255]	ZP[s, 254]	ZP[s, 253]	ZP[s, 252]	ZP[s, 251]	ZP[s, 250]	ZP[s, 249]	ZP[s, 248]
...	...							
31	ZP[s, 7] (ignored)	ZP[s, 6] (ignored)	ZP[s, 5] (ignored)	ZP[s, 4] (ignored)	ZP[s, 3]	ZP[s, 2]	ZP[s, 1] (ignored)	ZP[s, 0] (ignored)

The zone permission configuration descriptor contains all of the zone permission table entries for the source zone group (i.e., s). To preserve symmetry about the ZP[s, s] table axis, the management device server shall apply the same value to both the source and destination zone groups for the zone permission entries.

Table 328 defines how the zone permission descriptor bits shall be set by the management application client and processed by the management device server.

Table 328 — Zone permission configuration descriptor bit requirements

Source zone group (i.e., s)	Management application client requirement(s) ^a	Management device server requirement(s) ^a
0	ZP[s, 0] shall be set to zero. ZP[s, 1] shall be set to one. ZP[s, 2 through (z-1)] shall be set to zero.	ZP[s, 0 through (z-1)] shall be ignored.
1	ZP[s, 0 through (z-1)] shall be set to one.	ZP[s, 0 through (z-1)] shall be ignored.
4, 5, 6 or 7	ZP[s, 0] shall be set to zero. ZP[s, 1] shall be set to one. ZP[s, 4 through (z-1)] shall be set to zero.	ZP[s, 0 through (z-1)] shall be ignored.
2, 3, or 8 through (z-1) ^a	ZP[s, 0] shall be set to zero. ZP[s, 1] shall be set to one. ZP[s, 2 through 3] may be set to zero or one. ZP[s, 4 through 7] shall be set to zero. ZP[s, 8 through (z-1)] may be set to zero or one.	ZP[s, 0 through 1] shall be ignored. ZP[s, 2 through 3] shall be processed. ZP[s, 4 through 7] shall be ignored. ZP[s, 8 through (z-1)] shall be processed. For each source zone group t other than s, ZP[t, s] shall be set to ZP[s, t].

^a The number of zone groups (i.e., z) is specified in NUMBER OF ZONE GROUPS field.

Author: RElliott
Subject: Highlight
Date: 7/17/2008 6:05:23 PM
ACCEPT - DONE

T

shall
s/b
shall be

10.4.3.26.4 CONFIGURE ZONE PERMISSION TABLE response

Table 329 defines the response format.

Table 329 — CONFIGURE ZONE PERMISSION TABLE response

Byte\Bit	7	6	5	4	3	2	1	0	
0	SMP FRAME TYPE (41h)								
1	FUNCTION (8Bh)								
2	FUNCTION RESULT								
3	RESPONSE LENGTH (00h)								
4	(MSB)	CRC							
7								(LSB)	

The SMP FRAME TYPE field is defined in 10.4.3.3.2 and shall be set to the value defined in table 329.

The FUNCTION field is defined in 10.4.3.3.3 and shall be set to the value defined in table 329.

The FUNCTION RESULT field is defined in 10.4.3.3.4.

The RESPONSE LENGTH field is defined in 10.4.3.3.5 and shall be set to the value defined in table 329. A RESPONSE LENGTH field set to 00h does not have a special meaning based on the ALLOCATED RESPONSE LENGTH field in the request frame.

The CRC field is defined in 10.4.3.3.8.

10.4.3.27 CONFIGURE ROUTE INFORMATION function

The CONFIGURE ROUTE INFORMATION function sets an expander route entry within the expander route table of a configurable expander device. This SMP function shall be supported by management device servers in expander devices if the CONFIGURABLE ROUTE TABLE field is set to one in the SMP REPORT GENERAL response (see 10.4.3.4). Other management device servers shall not support this SMP function.

This page contains no comments

Table 330 defines the request format.

Table 330 — CONFIGURE ROUTE INFORMATION request

Byte\Bit	7	6	5	4	3	2	1	0
0	SMP FRAME TYPE (40h)							
1	FUNCTION (90h)							
2	ALLOCATED RESPONSE LENGTH							
3	REQUEST LENGTH (00h or 09h)							
4	(MSB)	EXPECTED EXPANDER CHANGE COUNT						(LSB)
5								
6	(MSB)	EXPANDER ROUTE INDEX						(LSB)
7								
8	Reserved							
9	PHY IDENTIFIER							
10	Reserved							
11								
12	DISABLE EXPANDER ROUTE ENTRY	Reserved						
13	Reserved							
15								
16	ROUTED SAS ADDRESS							
23								
24	Reserved							
39								
40	(MSB)	CRC						(LSB)
43								

The SMP FRAME TYPE field is defined in 10.4.3.2.2 and shall be set to the value defined in table 330.

The FUNCTION field is defined in 10.4.3.2.3 and shall be set to the value defined in table 330.

The ALLOCATED RESPONSE LENGTH field is defined in 10.4.3.2.4.

If the ALLOCATED RESPONSE LENGTH field is set to 00h, then the management device server shall:

- a) set the RESPONSE LENGTH field to 00h in the response frame; and
- b) return the first 4 bytes defined in table 331 plus the CRC field as the response frame.

This page contains no comments

If the ALLOCATED RESPONSE LENGTH field is not set to 00h, then the management device server shall:

- a) set the RESPONSE LENGTH field in the response frame to the value defined in table 331 (i.e., 00h); and
- b) return the response frame as specified by the ALLOCATED RESPONSE LENGTH field.

~~NOTE 125 – Future versions of this standard may change the value defined in table 331.~~

The REQUEST LENGTH field is defined in 10.4.3.2.5 and shall be set to one of the values defined in table 330 based on the LONG RESPONSE bit in the REPORT GENERAL response (see 10.4.3.4). A REQUEST LENGTH field set to 00h specifies that there are 9 dwords before the CRC field.

The EXPECTED EXPANDER CHANGE COUNT field is defined in the SMP CONFIGURE GENERAL request (see 10.4.3.18).

The EXPANDER ROUTE INDEX field specifies the expander route index for the expander route entry being configured (see 4.6.7.3).

The PHY IDENTIFIER field specifies the phy for which the expander route entry is being configured (see 4.6.7.3).

The DISABLE EXPANDER ROUTE ENTRY bit specifies whether the ECM shall use the expander route entry to route connection requests (see 4.6.7.3). If the DISABLE EXPANDER ROUTE ENTRY bit is set to zero, then the ECM shall use the expander route entry to route connection requests. If the DISABLE EXPANDER ROUTE ENTRY bit is set to one, the ECM shall not use the expander route entry to route connection requests.

The ROUTED SAS ADDRESS field specifies the SAS address for the expander route entry being configured (see 4.6.7.3).

The CRC field is defined in 10.4.3.2.8.

Table 331 defines the response format.

Table 331 — CONFIGURE ROUTE INFORMATION response

Byte/Bit	7	6	5	4	3	2	1	0	
0	SMP FRAME TYPE (41h)								
1	FUNCTION (90h)								
2	FUNCTION RESULT								
3	RESPONSE LENGTH (00h)								
4	(MSB)	CRC							
7								(LSB)	

The SMP FRAME TYPE field is defined in 10.4.3.3.2 and shall be set to the value defined in table 331.

The FUNCTION field is defined in 10.4.3.3.3 and shall be set to the value defined in table 331.

The FUNCTION RESULT field is defined in 10.4.3.3.4.

The RESPONSE LENGTH field is defined in 10.4.3.3.5 and shall be set to the value defined in table 331.

The CRC field is defined in 10.4.3.3.8.

10.4.3.28 PHY CONTROL function

The PHY CONTROL function requests actions by the specified phy. This SMP function may be implemented by any management device server. In zoning expander devices, if zoning is enabled then this function shall only be processed from SMP initiator ports that have access to zone group 2 or the zone group of the specified phy (see 4.9.3.2).

Page: 650

● Author: Isi-gpenokie

Subject: Cross-Out

Date: 5/6/2008 4:07:50 PM

 REJECT (it's a warning, so software might avoid the stupid mistakes that led to this field being added)

Predicting the future in not a good idea so delete this note << NOTE 125 - Future versions of this standard may change the value defined in table 331. >>

● Author: Isi-gpenokie

Subject: Highlight

Date: 5/6/2008 4:07:50 PM

 ACCEPT - DONE

This << one, the ECM shall not use >> should be << one, then the ECM shall not use >>

● Author: RElliott

Subject: Highlight

Date: 6/30/2008 6:16:52 PM

 ACCEPT - DONE

enabled then

s/b

enabled, then

Table 332 defines the request format.

Table 332 — PHY CONTROL request

Byte\Bit	7	6	5	4	3	2	1	0
0	SMP FRAME TYPE (40h)							
1	FUNCTION (91h)							
2	ALLOCATED RESPONSE LENGTH							
3	REQUEST LENGTH (00h or 09h)							
4	(MSB)	EXPECTED EXPANDER CHANGE COUNT						(LSB)
5								
6	Reserved							
8								
9	PHY IDENTIFIER							
10	PHY OPERATION							
11	Reserved							UPDATE PARTIAL PATHWAY TIMEOUT VALUE
12	Reserved							
23								
24	ATTACHED DEVICE NAME							
31								
32	PROGRAMMED MINIMUM PHYSICAL LINK RATE				Reserved			
33	PROGRAMMED MAXIMUM PHYSICAL LINK RATE				Reserved			
34	Reserved							
35								
36	Reserved				PARTIAL PATHWAY TIMEOUT VALUE			
37	Reserved							
39								
40	(MSB)	CRC						(LSB)
43								

The SMP FRAME TYPE field is defined in 10.4.3.2.2 and shall be set to the value defined in table 332.

The FUNCTION field is defined in 10.4.3.2.3 and shall be set to the value defined in table 332.

This page contains no comments

The ALLOCATED RESPONSE LENGTH field is defined in 10.4.3.2.4.

If the ALLOCATED RESPONSE LENGTH field is set to 00h, then the management device server shall:

- a) set the RESPONSE LENGTH field to 00h in the response frame; and
- b) return the first 4 bytes defined in table 335 plus the CRC field as the response frame.

If the ALLOCATED RESPONSE LENGTH field is not set to 00h, then the management device server shall:

- a) set the RESPONSE LENGTH field in the response frame to the value defined in table 335 (i.e., 00h); and
- b) return the response frame as specified by the ALLOCATED RESPONSE LENGTH field.

~~NOTE 126 — Future versions of this standard may change the value defined in table 335.~~

The REQUEST LENGTH field is defined in 10.4.3.2.5 and shall be set to one of the values defined in table 332 based on the LONG RESPONSE bit in the REPORT GENERAL response (see 10.4.3.4). A REQUEST LENGTH field set to 00h specifies that there are 9 dwords before the CRC field.

The EXPECTED EXPANDER CHANGE COUNT field is defined in the SMP CONFIGURE GENERAL request (see 10.4.3.18).

The PHY IDENTIFIER field specifies the phy (see 4.2.8) to which the SMP PHY CONTROL request applies.

Table 333 defines the PHY OPERATION field.

Table 333 — PHY OPERATION field (part 1 of 3)

Code	Operation	Description
00h	NOP	No operation.
^a Phys compliant with previous versions of this standard did not reject this phy operation due to affiliations. ^b Phys compliant with previous versions of this standard returned SMP FUNCTION REJECTED.		

● Author: Isi-gpenokie

Subject: Cross-Out

Date: 5/6/2008 4:07:50 PM

 REJECT (this is a warning to software to not make the same mistake that led to this field being added)

Predicting the future in not a good idea so delete this note << NOTE 126 - Future versions of this standard may change the value defined in table 335. >>

● Author: Isi-gpenokie

Subject: Highlight

Date: 5/30/2008 5:04:53 PM

 ACCEPT - DONE (changed to "2")

You should change the orphans on this table so that you don't get one row all be it's self on one page <<Table 333 — PHY OPERATION field (part 1 of 3) >>

Table 333 — PHY OPERATION field (part 2 of 3)

Code	Operation	Description
01h	LINK RESET	<p>If:</p> <ul style="list-style-type: none"> a) a SAS phy is attached; b) a SATA phy is attached and there is no affiliation; or c) a SATA phy is attached and an affiliation exists for the STP initiator port with the same SAS address as the SMP initiator port that opened this SMP connection, <p>then:</p> <ul style="list-style-type: none"> a) if the specified phy is a physical phy, perform a link reset sequence (see 4.4) on the specified phy and enable the specified phy; and b) if the specified phy is a virtual phy, perform an internal reset and enable the specified phy. <p>If a SATA phy is attached and an affiliation does not exist for the STP initiator port with the same SAS address as the SMP initiator port that opened this SMP connection, then the management device server shall return a function result of AFFILIATION VIOLATION in the response frame (see table 245 in 10.4.3.3).^a</p> <p>See 7.11 for Broadcast (Change) requirements related to this phy operation in an expander device.</p> <p>Any affiliation (see 7.17.4) shall continue to be present. The phy shall bypass the SATA spinup hold state, if implemented (see 6.8.3.9).</p> <p>The management device server shall return the PHY CONTROL response without waiting for the LINK RESET phy operation to complete.</p> <p>While the LINK RESET phy operation is in progress, the management device server sets the NEGOTIATED PHYSICAL LINK RATE field and the NEGOTIATED PHYSICAL LINK RATE field to RESET_IN_PROGRESS in the SMP DISCOVER response (see 10.4.3.10).</p>
02h	HARD RESET	<p>If the specified phy is a physical phy, perform a link reset sequence (see 4.4) on the specified phy and enable the specified phy. If the attached phy is a SAS phy or an expander phy, the link reset sequence shall include a hard reset sequence (see 4.4.2). If the attached phy is a SATA phy, the phy shall bypass the SATA spinup hold state. See 7.11 for Broadcast (Change) requirements related to this phy operation in an expander device.</p> <p>If the specified phy is a virtual phy, perform an internal reset and enable the specified phy.</p> <p>Any affiliation (see 7.17.4) shall be cleared.</p> <p>The management device server shall return the PHY CONTROL response without waiting for the HARD RESET phy operation to complete.</p> <p>While the HARD RESET phy operation is in progress, the management device server sets the NEGOTIATED PHYSICAL LINK RATE field and the NEGOTIATED PHYSICAL LINK RATE field to RESET_IN_PROGRESS in the SMP DISCOVER response (see 10.4.3.10).</p>
<p>^a Phys compliant with previous versions of this standard did not reject this phy operation due to affiliations.</p> <p>^b Phys compliant with previous versions of this standard returned SMP FUNCTION REJECTED.</p>		

● Author: RElliott
Subject: Highlight
Date: 6/30/2008 6:16:52 PM
T ACCEPT - DONE

perform
s/b
then perform

● Author: RElliott
Subject: Highlight
Date: 6/30/2008 6:16:52 PM
T ACCEPT - DONE

perform
s/b
then perform

● Author: lsi-bday
Subject: Cross-Out
Date: 6/30/2008 6:08:17 PM
~~**T**~~ ACCEPT - DONE (Deleted).

5/5 either weaken to a "sometimes sets", or remove)

While the LINK RESET phy operation is in progress, the management device server sets the NEGOTIATED PHYSICAL LINK RATE field and the NEGOTIATED PHYSICAL LINK RATE field to RESET_IN_PROGRESS in the SMP DISCOVER response (see 10.4.3.10).

This is only true for certain cases based on SP state machine ResetStatus variable.

● Author: lsi-gpenokie
Subject: Highlight
Date: 5/6/2008 4:07:50 PM
T ACCEPT - DONE

This << expander phy, the link reset sequence >> should be << expander phy, then the link reset sequence >>

● Author: RElliott
Subject: Highlight
Date: 6/30/2008 6:16:52 PM
T ACCEPT - DONE

the
s/b
then the

● Author: RElliott
Subject: Highlight
Date: 6/30/2008 6:16:52 PM
T ACCEPT - DONE

perform
s/b
then perform

● Author: lsi-bday
Subject: Cross-Out
Date: 6/30/2008 6:08:29 PM

Table 333 — PHY OPERATION field (part 2 of 3)

Code	Operation	Description
01h	LINK RESET	<p>If:</p> <ul style="list-style-type: none"> a) a SAS phy is attached; b) a SATA phy is attached and there is no affiliation; or c) a SATA phy is attached and an affiliation exists for the STP initiator port with the same SAS address as the SMP initiator port that opened this SMP connection, <p>then:</p> <ul style="list-style-type: none"> a) if the specified phy is a physical phy, perform a link reset sequence (see 4.4) on the specified phy and enable the specified phy; and b) if the specified phy is a virtual phy, perform an internal reset and enable the specified phy. <p>If a SATA phy is attached and an affiliation does not exist for the STP initiator port with the same SAS address as the SMP initiator port that opened this SMP connection, then the management device server shall return a function result of AFFILIATION VIOLATION in the response frame (see table 245 in 10.4.3.3).^a</p> <p>See 7.11 for Broadcast (Change) requirements related to this phy operation in an expander device.</p> <p>Any affiliation (see 7.17.4) shall continue to be present. The phy shall bypass the SATA spinup hold state, if implemented (see 6.8.3.9).</p> <p>The management device server shall return the PHY CONTROL response without waiting for the LINK RESET phy operation to complete.</p> <p>While the LINK RESET phy operation is in progress, the management device server sets the NEGOTIATED PHYSICAL LINK RATE field and the NEGOTIATED PHYSICAL LINK RATE field to RESET_IN_PROGRESS in the SMP DISCOVER response (see 10.4.3.10).</p>
02h	HARD RESET	<p>If the specified phy is a physical phy, perform a link reset sequence (see 4.4) on the specified phy and enable the specified phy. If the attached phy is a SAS phy or an expander phy, the link reset sequence shall include a hard reset sequence (see 4.4.2). If the attached phy is a SATA phy, the phy shall bypass the SATA spinup hold state. See 7.11 for Broadcast (Change) requirements related to this phy operation in an expander device.</p> <p>If the specified phy is a virtual phy, perform an internal reset and enable the specified phy.</p> <p>Any affiliation (see 7.17.4) shall be cleared.</p> <p>The management device server shall return the PHY CONTROL response without waiting for the HARD RESET phy operation to complete.</p> <p>While the HARD RESET phy operation is in progress, the management device server sets the NEGOTIATED PHYSICAL LINK RATE field and the NEGOTIATED PHYSICAL LINK RATE field to RESET_IN_PROGRESS in the SMP DISCOVER response (see 10.4.3.10).</p>
<p>^a Phys compliant with previous versions of this standard did not reject this phy operation due to affiliations.</p> <p>^b Phys compliant with previous versions of this standard returned SMP FUNCTION REJECTED.</p>		

 ACCEPT - DONE (Deleted. See LINK RESET comment above)

While the HARD RESET phy operation is in progress, the management device server sets the NEGOTIATED PHYSICAL LINK RATE field and the NEGOTIATED PHYSICAL LINK RATE field to RESET_IN_PROGRESS in the SMP DISCOVER response (see 10.4.3.10).

Table 333 — PHY OPERATION field (part 3 of 3)

Code	Operation	Description
03h	DISABLE	Disable the specified phy (i.e., stop transmitting valid dwords and receiving dwords on the specified phy). The LINK RESET and HARD RESET operations may be used to enable the phy. See 7.11 for Broadcast (Change) requirements related to this phy operation in an expander device.
04h	Reserved	
05h	CLEAR ERROR LOG	Clear the error log counters reported in the REPORT PHY ERROR LOG function (see 10.4.3.11) for the specified phy.
06h	CLEAR AFFILIATION	Clear an affiliation (see 7.17.4) from the STP initiator port with the same SAS address as the SMP initiator port that opened this SMP connection. If there is no such affiliation, the management device server shall return a function result of AFFILIATION VIOLATION ^b in the response frame (see table 245 in 10.4.3.3).
07h	TRANSMIT SATA PORT SELECTION SIGNAL	<p>This function shall only be supported by phys in an expander device.</p> <p>If the expander phy incorporates an STP/SATA bridge and supports SATA port selectors, the phy shall transmit the SATA port selection signal (see 6.6) which causes the SATA port selector to select the attached phy as the active host phy and make its other host phy inactive. See 7.11 for Broadcast (Change) requirements related to this phy operation in an expander device.</p> <p>Any affiliation (see 7.17.4) shall be cleared.</p> <p>If the expander phy does not support SATA port selectors, then the management device server shall return a function result of PHY DOES NOT SUPPORT SATA.</p> <p>If the expander phy supports SATA port selectors but is attached to a SAS phy or an expander phy, the management device server shall return a function result of SMP FUNCTION FAILED in the response frame (see table 245 in 10.4.3.3).</p>
08h	CLEAR STP I_T NEXUS LOSS	The STP I_T NEXUS LOSS OCCURRED bit in the REPORT PHY SATA function (see 10.4.3.12) shall be set to zero.
09h	SET ATTACHED DEVICE NAME	If the expander phy is attached to a SATA phy, set the ATTACHED DEVICE NAME field reported in the DISCOVER response (see 10.4.3.10) to the value of the ATTACHED DEVICE NAME field in the PHY CONTROL request.
All others	Reserved	
<p>^a Phys compliant with previous versions of this standard did not reject this phy operation due to affiliations.</p> <p>^b Phys compliant with previous versions of this standard returned SMP FUNCTION REJECTED.</p>		

If the operation specified by the PHY OPERATION field is unknown, the management device sever shall return a function result of SMP FUNCTION FAILED in the response frame (see table 245 in 10.4.3.3) and not process any other fields in the request.

If the PHY IDENTIFIER field specifies the phy which is being used for the SMP connection and a phy operation of LINK RESET, HARD RESET, or DISABLE is requested, the management device server shall not perform the requested operation and shall return a function result of SMP FUNCTION FAILED in the response frame (see table 245 in 10.4.3.3).

Page: 654

● Author: lsi-gpenokie
Subject: Cross-Out
Date: 5/6/2008 4:07:50 PM
T REJECT (there could be affiliations for other ports)

This term << such >> adds nothing and should be deleted.

● Author: RElliott
Subject: Highlight
Date: 6/30/2008 6:16:52 PM
T ACCEPT - DONE
the
s/b
then the

● Author: lsi-gpenokie
Subject: Highlight
Date: 5/6/2008 4:07:50 PM
T ACCEPT - DONE

This << selectors, the phy shall transmit >> should be << selectors, then the phy shall transmit >>

● Author: RElliott
Subject: Highlight
Date: 6/30/2008 6:16:52 PM
T ACCEPT - DONE
the
s/b
then the

● Author: RElliott
Subject: Highlight
Date: 6/30/2008 6:16:52 PM
T ACCEPT - DONE
set
s/b
, then set

● Author: RElliott
Subject: Highlight
Date: 6/30/2008 6:16:52 PM
T ACCEPT - DONE
the
s/n
then the

● Author: lsi-gpenokie
Subject: Highlight
Date: 5/6/2008 4:07:50 PM
T ACCEPT - DONE

This << is requested, the management >> should be << is requested, then the management >>

An UPDATE PARTIAL PATHWAY TIMEOUT VALUE bit set to one specifies that the PARTIAL PATHWAY TIMEOUT VALUE field shall be honored. An UPDATE PARTIAL PATHWAY TIMEOUT VALUE bit set to zero specifies that the PARTIAL PATHWAY TIMEOUT VALUE field shall be ignored.

The ATTACHED DEVICE NAME field is used by the SET ATTACHED DEVICE NAME phy operation and is reserved for all other phy operations. If a management application client detects the ATTACHED DEVICE NAME field set to zero in the DISCOVER response when a SATA device is attached, it shall set the ATTACHED DEVICE NAME field based on the IDENTIFY (PACKET) DEVICE data retrieved by an ATA application client in the same SAS initiator device as follows:

- a) if IDENTIFY (PACKET) DEVICE data word 255 (i.e., the Integrity word) is correct and words 108-111 (i.e., the World Wide Name field) are not set to zero, set this field to the world wide name indicated by words 108-111 according to table 12 in 4.2.5;
- b) if IDENTIFY (PACKET) DEVICE data word 255 (i.e., the Integrity word) is correct and words 108-111 (i.e., the World Wide Name) are set to zero, set this field to 00000000 00000000h; or
- c) if IDENTIFY (PACKET) DEVICE data word 255 (i.e., the Integrity word) is not correct, set this field to 00000000 00000000h.

The PROGRAMMED MINIMUM PHYSICAL LINK RATE field specifies the minimum physical link rate the phy shall support during a link reset sequence (see 4.4.1). Table 334 defines the values for this field. This value is reported in the DISCOVER response (see 10.4.3.10). If this field is changed along with a phy operation of LINK RESET or HARD RESET, that phy operation shall utilize the new value for this field.

The PROGRAMMED MAXIMUM PHYSICAL LINK RATE field specifies the maximum physical link rates the phy shall support during a link reset sequence (see 4.4.1). Table 334 defines the values for this field. This value is reported in the DISCOVER response (see 10.4.3.10). If this field is changed along with a phy operation of LINK RESET or HARD RESET, that phy operation shall utilize the new value for this field.

Table 334 — PROGRAMMED MINIMUM PHYSICAL LINK RATE and PROGRAMMED MAXIMUM PHYSICAL LINK RATE fields

Code	Description
0h	Do not change current value
1h - 7h	Reserved
8h	1.5 Gbps
9h	3 Gbps
Ah	6 Gbps
Bh - Fh	Reserved for future physical link rates

If the PROGRAMMED MINIMUM PHYSICAL LINK RATE field or the PROGRAMMED MAXIMUM PHYSICAL LINK RATE field is set to an unsupported or reserved value, or the PROGRAMMED MINIMUM PHYSICAL LINK RATE field and PROGRAMMED MAXIMUM PHYSICAL LINK RATE field are set to an invalid combination of values (e.g., the minimum is greater than the maximum), the management device server shall not change either of their values and may return a function result of SMP FUNCTION FAILED in the response frame (see table 245 in 10.4.3.3). If it returns a function result of SMP FUNCTION FAILED, it shall not perform the requested phy operation.

The PARTIAL PATHWAY TIMEOUT VALUE field specifies the amount of time in microseconds the expander phy shall wait after receiving an Arbitrating (Blocked On Partial) confirmation from the ECM before requesting that the ECM resolve pathway blockage (see 7.12.4.5). A PARTIAL PATHWAY TIMEOUT VALUE field value of zero (i.e., 0 μs) specifies that partial pathway resolution shall be requested by the expander phy immediately upon reception of an Arbitrating (Blocked On Partial) confirmation from the ECM. This value is reported in the DISCOVER response (see 10.4.3.10). The PARTIAL PATHWAY TIMEOUT VALUE field is only honored when the UPDATE PARTIAL PATHWAY TIMEOUT VALUE bit is set to one.

The CRC field is defined in 10.4.3.2.8.

● Author: Isi-gpenokie
Subject: Highlight
Date: 5/6/2008 4:07:50 PM
T ACCEPT - DONE (keeping "it")

This << device is attached, it shall set the ATTACHED >> should be << device is attached, then the management application client shall set the ATTACHED >>

● Author: RElliott
Subject: Highlight
Date: 6/30/2008 6:16:52 PM
T ACCEPT - DONE

zero
s/b
00000000 00000000h

● Author: Isi-gpenokie
Subject: Highlight
Date: 5/30/2008 5:06:01 PM
T ACCEPT - DONE (added "then" but kept "this field")

This << set to zero, set this field to the >> should be << set to zero, then set the ATTACHED DEVICE NAME field to the >>

● Author: Isi-gpenokie
Subject: Highlight
Date: 5/30/2008 5:06:05 PM
T ACCEPT - DONE (added "then" but kept "this field")

This << set to zero, set this field to >> should be << set to zero, then set the ATTACHED DEVICE NAME field to >>

● Author: Isi-gpenokie
Subject: Highlight
Date: 5/30/2008 5:06:11 PM
T ACCEPT - DONE (added "then" but kept "this field")

This << correct, set this field to >> should be << correct, then set the ATTACHED DEVICE NAME field to >>

● Author: Isi-gpenokie
Subject: Highlight
Date: 5/6/2008 4:07:50 PM
T ACCEPT - DONE

This << HARD RESET, that phy operation >> should be << HARD RESET, then that phy operation >>

● Author: Isi-gpenokie
Subject: Highlight
Date: 5/6/2008 4:07:50 PM
T ACCEPT - DONE

This << HARD RESET, that phy >> should be << HARD RESET, then that phy >>

● Author: Isi-gpenokie
Subject: Highlight
Date: 5/6/2008 4:07:50 PM
T ACCEPT - DONE

This << the maximum), the management device >> should be << the maximum), then the management device >>

● Author: Isi-gpenokie
Subject: Highlight

An UPDATE PARTIAL PATHWAY TIMEOUT VALUE bit set to one specifies that the PARTIAL PATHWAY TIMEOUT VALUE field shall be honored. An UPDATE PARTIAL PATHWAY TIMEOUT VALUE bit set to zero specifies that the PARTIAL PATHWAY TIMEOUT VALUE field shall be ignored.

The ATTACHED DEVICE NAME field is used by the SET ATTACHED DEVICE NAME phy operation and is reserved for all other phy operations. If a management application client detects the ATTACHED DEVICE NAME field set to zero in the DISCOVER response when a SATA device is attached, it shall set the ATTACHED DEVICE NAME field based on the IDENTIFY (PACKET) DEVICE data retrieved by an ATA application client in the same SAS initiator device as follows:

- a) if IDENTIFY (PACKET) DEVICE data word 255 (i.e., the Integrity word) is correct and words 108-111 (i.e., the World Wide Name field) are not set to zero, set this field to the world wide name indicated by words 108-111 according to table 12 in 4.2.5;
- b) if IDENTIFY (PACKET) DEVICE data word 255 (i.e., the Integrity word) is correct and words 108-111 (i.e., the World Wide Name) are set to zero, set this field to 00000000 00000000h; or
- c) if IDENTIFY (PACKET) DEVICE data word 255 (i.e., the Integrity word) is not correct, set this field to 00000000 00000000h.

The PROGRAMMED MINIMUM PHYSICAL LINK RATE field specifies the minimum physical link rate the phy shall support during a link reset sequence (see 4.4.1). Table 334 defines the values for this field. This value is reported in the DISCOVER response (see 10.4.3.10). If this field is changed along with a phy operation of LINK RESET or HARD RESET, that phy operation shall utilize the new value for this field.

The PROGRAMMED MAXIMUM PHYSICAL LINK RATE field specifies the maximum physical link rates the phy shall support during a link reset sequence (see 4.4.1). Table 334 defines the values for this field. This value is reported in the DISCOVER response (see 10.4.3.10). If this field is changed along with a phy operation of LINK RESET or HARD RESET, that phy operation shall utilize the new value for this field.

Table 334 — PROGRAMMED MINIMUM PHYSICAL LINK RATE and PROGRAMMED MAXIMUM PHYSICAL LINK RATE fields

Code	Description
0h	Do not change current value
1h - 7h	Reserved
8h	1.5 Gbps
9h	3 Gbps
Ah	6 Gbps
Bh - Fh	Reserved for future physical link rates

If the PROGRAMMED MINIMUM PHYSICAL LINK RATE field or the PROGRAMMED MAXIMUM PHYSICAL LINK RATE field is set to an unsupported or reserved value, or the PROGRAMMED MINIMUM PHYSICAL LINK RATE field and PROGRAMMED MAXIMUM PHYSICAL LINK RATE field are set to an invalid combination of values (e.g., the minimum is greater than the maximum), the management device server shall not change either of their values and may return a function result of SMP FUNCTION FAILED in the response frame (see table 245 in 10.4.3.3). If it returns a function result of SMP FUNCTION FAILED, it shall not perform the requested phy operation.

The PARTIAL PATHWAY TIMEOUT VALUE field specifies the amount of time in microseconds the expander phy shall wait after receiving an Arbitrating (Blocked On Partial) confirmation from the ECM before requesting that the ECM resolve pathway blockage (see 7.12.4.5). A PARTIAL PATHWAY TIMEOUT VALUE field value of zero (i.e., 0 μs) specifies that partial pathway resolution shall be requested by the expander phy immediately upon reception of an Arbitrating (Blocked On Partial) confirmation from the ECM. This value is reported in the DISCOVER response (see 10.4.3.10). The PARTIAL PATHWAY TIMEOUT VALUE field is only honored when the UPDATE PARTIAL PATHWAY TIMEOUT VALUE bit is set to one.

The CRC field is defined in 10.4.3.2.8.

Date: 5/30/2008 5:06:49 PM

T ACCEPT - DONE

This << If it returns a function >> should be << If the management device server returns a function >>

Author: lsi-gpenokie

Subject: Highlight

Date: 5/30/2008 5:07:21 PM

T REJECT (but added "then". After accepting the previous comment in this sentence, the first noun/subject convention holds, justifying keeping "it"))

This << FAILED, it shall not perform >> should be << FAILED, then the management device server shall not perform >>

Table 335 defines the response format.

Table 335 — PHY CONTROL response

Byte\Bit	7	6	5	4	3	2	1	0
0	SMP FRAME TYPE (41h)							
1	FUNCTION (91h)							
2	FUNCTION RESULT							
3	RESPONSE LENGTH (00h)							
4	(MSB)	CRC						(LSB)
7								

The SMP FRAME TYPE field is defined in 10.4.3.3.2 and shall be set to the value defined in table 335.

The FUNCTION field is defined in 10.4.3.3.3 and shall be set to the value defined in table 335.

The FUNCTION RESULT field is defined in 10.4.3.3.4.

The RESPONSE LENGTH field is defined in 10.4.3.3.5 and shall be set to the value defined in table 335.

The CRC field is defined in 10.4.3.3.8.

10.4.3.29 PHY TEST FUNCTION function

The PHY TEST FUNCTION function requests actions by the specified phy. This SMP function may be implemented by any management device server. In zoning expander devices, if zoning is **enabled then** this function shall only be processed from SMP initiator ports that have access to zone group 2 or the zone group of the specified phy (see 4.9.3.2).

Author: RElliott
Subject: Highlight
Date: 6/30/2008 6:16:52 PM
ACCEPT - DONE

T

enabled then
s/b
enabled, then

Table 336 defines the request format.

Table 336 — PHY TEST FUNCTION request

Byte\Bit	7	6	5	4	3	2	1	0
0	SMP FRAME TYPE (40h)							
1	FUNCTION (92h)							
2	ALLOCATED RESPONSE LENGTH							
3	REQUEST LENGTH (00h or 09h)							
4	(MSB)	EXPECTED EXPANDER CHANGE COUNT						(LSB)
5								
6	Reserved							
8								
9	PHY IDENTIFIER							
10	PHY TEST FUNCTION							
11	PHY TEST PATTERN							
12								
14	Reserved							
15	Reserved	PHY TEST PATTERN SATA	PHY TEST PATTERN SSC	PHY TEST PATTERN PHYSICAL LINK RATE				
16								
18	Reserved							
19	PHY TEST PATTERN DWORDS CONTROL							
20								
27	PHY TEST PATTERN DWORDS							
28								
39	Reserved							
40	(MSB)	CRC						(LSB)
43								

The SMP FRAME TYPE field is defined in 10.4.3.2.2 and shall be set to the value defined in table 336.

The FUNCTION field is defined in 10.4.3.2.3 and shall be set to the value defined in table 336.

The ALLOCATED RESPONSE LENGTH field is defined in 10.4.3.2.4.

If the ALLOCATED RESPONSE LENGTH field is set to 00h, then the management device server shall:

- a) set the RESPONSE LENGTH field to 00h in the response frame; and

This page contains no comments

b) return the first 4 bytes defined in table 339 plus the CRC field as the response frame.

If the ALLOCATED RESPONSE LENGTH field is not set to 00h, then the management device server shall:

- a) set the RESPONSE LENGTH field in the response frame to the value defined in table 339 (i.e., 00h); and
- b) return the response frame as specified by the ALLOCATED RESPONSE LENGTH field.

~~NOTE 127 - Future versions of this standard may change the value defined in table 339.~~

The REQUEST LENGTH field is defined in 10.4.3.2.5 and shall be set to one of the values defined in table 336 based on the LONG RESPONSE bit in the REPORT GENERAL response (see 10.4.3.4). A REQUEST LENGTH field set to 00h specifies that there are 9 dwords before the CRC field.

The EXPECTED EXPANDER CHANGE COUNT field is defined in the SMP CONFIGURE GENERAL request (see 10.4.3.18).

The PHY IDENTIFIER field specifies the phy (see 4.2.8) to which the SMP PHY TEST PATTERN request applies.

If the PHY IDENTIFIER field specifies the phy which is being used for the SMP connection, the management device server shall not perform the requested operation and shall return a function result of SMP FUNCTION FAILED in the response frame (see table 245 in 10.4.3.3).

The PHY TEST FUNCTION field specifies the phy test function to be performed, and is defined in table 337. If the PHY TEST FUNCTION field specifies a phy test function that is not supported by the phy, the management device server shall return a function result of UNKNOWN PHY TEST FUNCTION in the response frame (see table 245 in 10.4.3.3).

Table 337 — PHY TEST FUNCTION field

Code	Name	Description
00h	STOP	<p>If the selected phy is performing a phy test function, then the selected phy shall stop performing the phy test function and originate a link reset sequence.</p> <p>If the selected phy is not performing a phy test function, then this function has no effect on the selected phy.</p>
01h	TRANSMIT PATTERN	<p>If the selected phy is not performing a phy test function, the selected phy shall be set to transmit the phy test pattern specified by the PHY TEST PATTERN field at the physical link rate specified by the PHY TEST PATTERN PHYSICAL LINK RATE field and set to ignore its receiver. If the selected phy receives data while transmitting the pattern, then the selected phy shall ignore the received data.</p> <p>If the selected phy is performing a phy test function, the management device server shall return a function result of PHY TEST FUNCTION IN PROGRESS in the response frame (see table 245 in 10.4.3.3).</p>
02h - EFh	Reserved	
F0h - FFh	Vendor specific	

If the PHY TEST FUNCTION field is set to 01h (i.e., TRANSMIT PATTERN), the PHY TEST PATTERN field specifies the phy test pattern to be performed, and is the same as that defined in table 231 for the Protocol-Specific diagnostic page (see 10.2.9.2). The phy test pattern shall be sent at the physical link rate specified by the PHY TEST PATTERN PHYSICAL LINK RATE field.

The PHY TEST PATTERN SATA bit is as defined in the Protocol-Specific diagnostic page (see 10.2.9.2).

The PHY TEST PATTERN SSC field is as defined in table 232 for the Protocol-Specific diagnostic page (see 10.2.9.2).

● Author: lsi-gpenokie
Subject: Cross-Out
Date: 5/6/2008 4:07:50 PM
T REJECT (see previous comment like this)

Predicting the future in not a good idea so delete this note << NOTE 127 - Future versions of this standard may change the value defined in table 339. >>

● Author: lsi-gpenokie
Subject: Highlight
Date: 5/6/2008 4:07:50 PM
T ACCEPT - DONE

This << connection, the management >> should be << connection, then the management >>

● Author: wdc-mevans
Subject: Highlight
Date: 5/26/2008 12:38:24 PM
T ACCEPT - DONE

which
s/b
that

● Author: wdc-mevans
Subject: Highlight
Date: 5/26/2008 12:38:41 PM
T REJECT

performed, and
s/b
performed and

● Author: lsi-gpenokie
Subject: Highlight
Date: 5/6/2008 4:07:50 PM
T ACCEPT - DONE

This << the phy, the management >> should be << the phy, then the management >>

● Author: lsi-gpenokie
Subject: Highlight
Date: 5/6/2008 4:07:50 PM
T ACCEPT - DONE

This << test function, the selected phy >> should be << test function, then the selected phy >>

● Author: lsi-gpenokie
Subject: Highlight
Date: 5/6/2008 4:07:50 PM
T ACCEPT - DONE

This << test function, the management >> should be << test function, then the management >>

● Author: lsi-gpenokie
Subject: Highlight
Date: 5/6/2008 4:07:50 PM
T ACCEPT - DONE

This << TRANSMIT PATTERN), the PHY TEST PATTERN >> should be << TRANSMIT PATTERN), then the PHY TEST PATTERN >>

The PHY TEST PATTERN PHYSICAL LINK RATE field specifies the physical link rate at which the phy test function, if any, shall be performed. Table 338 defines the values for this field.

Table 338 — PHY TEST PATTERN PHYSICAL LINK RATE field

Code	Description
0h - 7h	Reserved
8h	1.5 Gbps
9h	3 Gbps
Ah	6 Gbps
Bh - Fh	Reserved for future physical link rates

The PHY TEST PATTERN DWORDS CONTROL field and the PHY TEST PATTERN DWORDS field are as defined in table 231 for the Protocol-Specific diagnostic page (see 10.2.9.2).

The CRC field is defined in 10.4.3.2.8.

Table 339 defines the response format.

Table 339 — PHY TEST FUNCTION response

Byte\Bit	7	6	5	4	3	2	1	0	
0	SMP FRAME TYPE (41h)								
1	FUNCTION (92h)								
2	FUNCTION RESULT								
3	RESPONSE LENGTH (00h)								
4	(MSB)	CRC							
7								(LSB)	

The SMP FRAME TYPE field is defined in 10.4.3.3.2 and shall be set to the value defined in table 339.

The FUNCTION field is defined in 10.4.3.3.3 and shall be set to the value defined in table 339.

The FUNCTION RESULT field is defined in 10.4.3.3.4.

The RESPONSE LENGTH field is defined in 10.4.3.3.5 and shall be set to the value defined in table 339.

The CRC field is defined in 10.4.3.3.8.

10.4.3.30 CONFIGURE PHY EVENT function

10.4.3.30.1 CONFIGURE PHY EVENT function overview

The CONFIGURE PHY EVENT function configures phy events (see 4.11) about the specified phy. This SMP function may be implemented by any management device server. In zoning expander devices, if zoning is enabled then this function shall only be processed from SMP initiator ports that have access to zone group 2 or the zone group of the specified phy (see 4.9.3.2).

● Author: wdc-mevans
Subject: Highlight
Date: 5/6/2008 4:07:50 PM

T ACCEPT - DONE
about
s/b
for

● Author: wdc-mevans
Subject: Highlight
Date: 5/6/2008 4:07:50 PM

T ACCEPT - DONE
enabled then
s/b
enabled, then

10.4.3.30.2 CONFIGURE PHY EVENT request

Table 340 defines the request format.

Table 340 — CONFIGURE PHY EVENT request

Byte\Bit	7	6	5	4	3	2	1	0	
0	SMP FRAME TYPE (40h)								
1	FUNCTION (93h)								
2	ALLOCATED RESPONSE LENGTH								
3	REQUEST LENGTH $((n - 7) / 4)$								
4	(MSB)	EXPECTED EXPANDER CHANGE COUNT							
5								(LSB)	
6	Reserved							CLEAR PEAKS	
7	Reserved								
8	Reserved								
9	PHY IDENTIFIER								
10	Reserved								
11	NUMBER OF PHY EVENT CONFIGURATION DESCRIPTORS								
Phy event configuration descriptor list									
12	Phy event configuration descriptor (first)(see table 341 in 10.4.3.30.3)								
	...								
n - 4	Phy event configuration descriptor (last)(see table 341 in 10.4.3.30.3)								
n - 3	(MSB)	CRC							
n								(LSB)	

The SMP FRAME TYPE field is defined in 10.4.3.2.2 and shall be set to the value defined in table 340.

The FUNCTION field is defined in 10.4.3.2.3 and shall be set to the value defined in table 340.

The ALLOCATED RESPONSE LENGTH field is defined in 10.4.3.2.4.

The REQUEST LENGTH field is defined in 10.4.3.2.5 and shall be set to the value defined in table 340.

The EXPECTED EXPANDER CHANGE COUNT field is defined in the SMP CONFIGURE GENERAL request (see 10.4.3.18).

A CLEAR PEAKS field set to one specifies that all phy event peak value detectors shall be set to zero. A CLEAR PEAKS field set to zero specifies no change to the phy event peak value detectors.

The PHY IDENTIFIER field specifies the phy (see 4.2.7) for which information shall be reported.

Page: 660

● Author: RElliott
Subject: Note
Date: 6/30/2008 6:16:52 PM
 ACCEPT - DONE

Per 6/11 LB call, change byte 10 to a Phy Event Configuration Descriptor Length field

● Author: Isi-gpenokie
Subject: Oval
Date: 5/6/2008 4:07:50 PM
 ACCEPT - DONE

This cell should have a << 19 >> in it.

● Author: Isi-gpenokie
Subject: Oval
Date: 5/6/2008 4:07:50 PM
 ACCEPT - DONE

This cell should have a << n - 11 >> in it.

● Author: RElliott
Subject: Highlight
Date: 6/30/2008 6:16:52 PM
 ACCEPT - DONE

field
s/b
bit

● Author: Isi-bbesmer
Subject: Note
Date: 5/26/2008 12:39:04 PM

 REJECT (that's the point of them. Wrapping counters are to be multi-initiator friendly, unlike saturating counters. If clearing is allowed, then one initiator confuses the others whenever it clears a counter.)

I don't see any method to clear Wrapping Counters.

● Author: RElliott
Subject: Highlight
Date: 6/30/2008 6:16:52 PM
 ACCEPT - DONE

field
s/b
bit

● Author: elx-bmartin
Subject: Comment on Text
Date: 5/6/2008 4:07:50 PM
 ACCEPT - DONE

This reference should be 4.2.8

The NUMBER OF PHY EVENT CONFIGURATION DESCRIPTORS field specifies the number of phy event configuration descriptors, and shall be set to the same value as the NUMBER OF PHY EVENT DESCRIPTORS field in the SMP REPORT PHY EVENT function (see 10.4.3.14).

The phy event configuration descriptor list contains phy event configuration descriptors as defined in 10.4.3.30.3.

The CRC field is defined in 10.4.3.2.8.

10.4.3.30.3 CONFIGURE PHY EVENT request phy event configuration descriptor

Table 341 defines the phy event configuration descriptor.

Table 341 — Phy event configuration descriptor

Byte\Bit	7	6	5	4	3	2	1	0
0	Reserved							
2	PHY EVENT SOURCE							
3	(MSB)	PEAK VALUE DETECTOR THRESHOLD						(LSB)
7								

The PHY EVENT SOURCE field, defined in table 37 in 4.11, specifies the type of event that shall be recorded by the corresponding phy event monitor.

If the phy event source is a peak value detector, the PEAK VALUE DETECTOR THRESHOLD field specifies the value of the peak value detector that causes the expander device to originate a Broadcast (Expander)(see 7.2.6.4). If the phy event source is not a peak value detector, the PEAK VALUE DETECTOR THRESHOLD field is reserved.

If the PHY EVENT SOURCE field contains a value that is not supported, the management device server shall return a function result of UNKNOWN PHY EVENT SOURCE in the response frame (see table 245 in 10.4.3.3).

10.4.3.30.4 CONFIGURE PHY EVENT response

Table 342 defines the response format.

Table 342 — CONFIGURE PHY EVENT response

Byte\Bit	7	6	5	4	3	2	1	0
0	SMP FRAME TYPE (41h)							
1	FUNCTION (93h)							
2	FUNCTION RESULT							
3	RESPONSE LENGTH (00h)							
4	(MSB)	CRC						(LSB)
7								

The SMP FRAME TYPE field is defined in 10.4.3.3.2 and shall be set to the value defined in table 342.

The FUNCTION field is defined in 10.4.3.3.3 and shall be set to the value defined in table 342.

● Author: RElliott
Subject: Highlight
Date: 6/30/2008 6:16:52 PM
T ACCEPT - DONE

descriptors
add
"in the phy event configuration descriptor list"

● Author: RElliott
Subject: Underline
Date: 6/30/2008 6:16:52 PM
T ACCEPT - DONE

CONFIGURE PHY EVENT request phy event configuration descriptor
s/b
Phy event configuration descriptor

(matching comment on 10.4.3.9.4 by Data Domain)

● Author: RElliott
Subject: Highlight
Date: 6/30/2008 6:16:52 PM
T ACCEPT - DONE

the
s/b
then the

● Author: RElliott
Subject: Highlight
Date: 6/30/2008 6:16:52 PM
T ACCEPT - DONE

the
s/b
then the

● Author: RElliott
Subject: Highlight
Date: 6/30/2008 6:16:52 PM
T ACCEPT - DONE

the
s/b
then the

The FUNCTION RESULT field is defined in 10.4.3.3.4.

The RESPONSE LENGTH field is defined in 10.4.3.3.5 and shall be set to the value defined in table 342. A RESPONSE LENGTH field set to 00h does not have a special meaning based on the ALLOCATED RESPONSE LENGTH field in the request frame.

The CRC field is defined in 10.4.3.3.8.

This page contains no comments

Annex A
(normative)

Jitter tolerance patterns

A.1 Jitter tolerance pattern (JTPAT)

The jitter tolerance pattern (JTPAT) consists of:

- 1) a long run of low transition density pattern;
- 2) a long run of high transition density pattern; and
- 3) another short run of low transition density pattern.

The transitions between the pattern segments stress the receiver. The JTPAT is designed to contain the phase shift in both polarities, from 0 to 1 and from 1 to 0. The critical pattern sections with the phase shifts are underlined in table A.1 and table A.2.

Table A.1 shows the JTPAT when there is positive running disparity (RD+) (see 6.2) at the beginning of the pattern. The 8b and 10b values of each character are shown.

Table A.1 — JTPAT for RD+

Dword(s)	Beginning RD	First character	Second character	Third character	Fourth character	Ending RD
0 to 40	RD+	D30.3 (7Eh)	D30.3 (7Eh)	D30.3 (7Eh)	D30.3 (7Eh)	RD+
		<u>1000011100b</u>	<u>0111100011b</u>	<u>1000011100b</u>	<u>0111100011b</u>	
The above dword of low transition density pattern is sent a total of 41 times						
41	RD+	D30.3 (7Eh)	D30.3 (7Eh)	D30.3 (7Eh)	D20.3 (74h)	RD-
		<u>1000011100b</u>	<u>0111100011b</u>	<u>1000011100b</u>	<u>0010111100b</u>	
The above dword containing phase shift <u>11100001011b</u> is sent 1 time						
42	RD-	D30.3 (7Eh)	D11.5 (ABh)	D21.5 (B5h)	D21.5 (B5h)	RD+
		<u>0111100011b</u>	<u>110100</u> 101010b	1010101010b	1010101010b	
The above dword containing phase shift <u>00011110100b</u> is sent 1 time						
43 to 54	RD+	D21.5 (B5h)	D21.5 (B5h)	D21.5 (B5h)	D21.5 (B5h)	RD+
		<u>1010101010b</u>	<u>1010101010b</u>	<u>1010101010b</u>	<u>1010101010b</u>	
The above dword of high transition density pattern is sent a total of 12 times						
55	RD+	D21.5 (B5h)	D30.2 (5Eh)	D10.2 (4Ah)	D30.3 (7Eh)	RD+
		<u>1010101010b</u>	<u>10000</u> 101010b	<u>0101010101b</u>	<u>0111100011b</u>	
The above dword containing phase shift <u>01010000b</u> and <u>10101111b</u> is sent 1 time						

● Author: RElliott
Subject: Highlight
Date: 6/30/2008 6:16:52 PM
T ACCEPT - DONE

see 6.2) at

point to new RD section

● Author: lsi-gpenokie
Subject: Highlight
Date: 5/6/2008 4:07:50 PM

T REJECT (I dislike mixing numbers and words for the same basic statement. Since many entries here "41", "12", etc., this entry uses "1")

Global in annex A tables

This << sent 1 time >> should be << sent one time >>

If the same 8b characters specified in table A.1 are used when there is negative running disparity (RD-) at the beginning of the pattern, the resulting 10b pattern is different and does not provide the critical phase shifts. To achieve the same phase shift effects with RD-, a different 8b pattern is required. Table A.2 shows the JTPAT when there is negative running disparity (RD-) at the beginning of the pattern. The 8b and 10b values of each character are shown.

Table A.2 — JTPAT for RD-

Dword(s)	Beginning RD	First character	Second character	Third character	Fourth character	Ending RD
0 to 40	RD-	D30.3 (7Eh)	D30.3 (7Eh)	D30.3 (7Eh)	D30.3 (7Eh)	RD-
		0111100011b	1000011100b	0111100011b	1000011100b	
The above dword of low transition density pattern is sent a total of 41 times						
41	RD-	D30.3 (7Eh)	D30.3 (7Eh)	D30.3 (7Eh)	D11.3 (6Bh)	RD+
		0111100011b	1000011100b	0111100011b	1101000011b	
The above dword containing phase shift 00011110100b is sent 1 time						
42	RD+	D30.3 (7Eh)	D20.2 (54h)	D10.2 (4Ah)	D10.2 (4Ah)	RD-
		1000011100b	0010110101b	0101010101b	0101010101b	
The above dword containing phase shift 11100001011b is sent 1 time						
43 to 54	RD-	D10.2 (4Ah)	D10.2 (4Ah)	D10.2 (4Ah)	D10.2 (4Ah)	RD-
		0101010101b	0101010101b	0101010101b	0101010101b	
The above dword of high transition density pattern is sent a total of 12 times						
55	RD-	D10.2 (4Ah)	D30.5 (BEh)	D21.5 (B5h)	D30.3 (7Eh)	RD-
		0101010101b	0111101010b	1010101010b	1000011100b	
The above dword containing phase shift 10101111b and 01010000b is sent 1 time						

● Author: Isi-gpenokie
Subject: Highlight
Date: 5/6/2008 4:07:50 PM

T ACCEPT - DONE

This << of the pattern, the resulting 10b >> should be << of the pattern, then the resulting 10b >>

Table A.3 shows a pattern containing both JTPAT for RD+ and JTPAT for RD-. The 10b pattern resulting from encoding the 8b pattern contains the desired bit sequences for the phase shifts with both starting running disparities.

Table A.3 — JTPAT for RD+ and RD-

Dword(s)	First character	Second character	Third character	Fourth character	Notes
0 to 40	D30.3(7Eh)	D30.3(7Eh)	D30.3(7Eh)	D30.3(7Eh)	This dword is sent a total of 41 times.
	
41	D30.3(7Eh)	D30.3(7Eh)	D30.3(7Eh)	D20.3(74h)	This dword is sent once.
42	D30.3(7Eh)	D11.5(ABh)	D21.5(B5h)	D21.5(B5h)	This dword is sent once.
43 to 54	D21.5(B5h)	D21.5(B5h)	D21.5(B5h)	D21.5(B5h)	This dword is sent a total of 12 times.
	
55	D21.5(B5h)	D30.2(5Eh)	D10.2(4Ah)	D30.3(7Eh)	This dword is sent once.
56 to 96	D30.3(7Eh)	D30.3(7Eh)	D30.3(7Eh)	D30.3(7Eh)	This dword is sent a total of 41 times.
	
97	D30.3(7Eh)	D30.3(7Eh)	D30.3(7Eh)	D11.3(6Bh)	This dword is sent once.
98	D30.3(7Eh)	D20.2(54h)	D10.2(4Ah)	D10.2(4Ah)	This dword is sent once.
99 to 110	D10.2(4Ah)	D10.2(4Ah)	D10.2(4Ah)	D10.2(4Ah)	This dword is sent a total of 12 times.
	
111	D10.2(4Ah)	D30.5(BEh)	D21.5(B5h)	D30.3(7Eh)	This dword is sent once.

A.2 Compliant jitter tolerance pattern (CJTPAT)

The compliant jitter tolerance pattern (CJTPAT) is the JTPAT for RD+ and RD- (see table A.3 in A.1) included as the payload in an SSP DATA frame or an SMP frame. The CJTPAT is:

- 1) SOF;
- 2) 6 data dwords containing either:
 - A) an SSP DATA frame header; or
 - B) an SMP frame header followed by 23 bytes;
- 3) 112 data dwords containing JTPAT for RD+ and RD-;
- 4) 1 data dword containing a CRC value; and
- 5) EOF.

Deletable primitives may be included in the transmission of the CJTPAT, but the number of deletable primitives transmitted should be as small as possible so that the percentage of the transfer that is the JTPAT is as high as possible.

Because the SOF, EOF, and CRC are the same in SSP and SMP, CJTPAT complies with:

- a) the SSP frame transmission format defined by the SSP link layer (see figure 189 in 7.16.3);
- b) the SSP frame format defined by the SSP transport layer (see table 163 in 9.2.1);
- c) the SMP frame transmission format defined by the SMP link layer (see figure 203 in 7.18.1); and
- d) the SMP frame format defined by the SMP transport layer (see table 191 in 9.4.1).

When a phy transmits a frame, it XORs the 8b data provided by the application layer with the output of a scrambler before transmission (see 7.6). It does not modify primitives and it re-initializes the scrambler at the beginning of each frame (e.g., at SOF). If the application layer XORs the desired 8b pattern with the expected output of the scrambler prior to submitting it to the transmitter, then the transmitter transmits the desired pattern. The 8b data dwords are scrambled by XORing the pattern with the expected scrambler dword output, taking into account the position of the 8b data dwords within the frame.

Page: 665

Author: lsi-gpenokie

Subject: Highlight

Date: 5/6/2008 4:07:50 PM

T REJECT (keeping all numbers in this list)

This << 6 data dwords containing >> should be << six data dwords containing >>

Author: stx-goulder

Subject: Highlight

Date: 7/17/2008 6:09:08 PM

T ACCEPT - DONE (7/15 "23 vendor specific bytes".

Don't care for purposes of getting CJPAT on the wire)

B) an SMP frame header followed by 23 bytes;

Are the 23 bytes random data bytes or is there a restriction on what they should be that needs to be stated here?

Author: lsi-gpenokie

Subject: Highlight

Date: 5/6/2008 4:07:50 PM

T REJECT (keeping all numbers in this list)

This << 1 data dword containing >> should be << one data dword containing >>

Author: lsi-gpenokie

Subject: Highlight

Date: 5/6/2008 4:07:50 PM

T ACCEPT - DONE (a rare victory for the anti-because cause)

This << Because the SOF, EOF, and CRC are the same in SSP and SMP, CJTPAT >> should be << As a result of SOF, EOF, and CRC being the same in SSP and SMP, CJTPAT >>

Author: wdc-mevans

Subject: Highlight

Date: 5/6/2008 4:07:50 PM

T REJECT

it
s/b
the phy

Author: wdc-mevans

Subject: Cross-Out

Date: 5/25/2008 7:57:36 PM

T ACCEPT - DONE (see response to lsi-gpenokie comment)

it
s/b
[Delete the unnecessary word.]

Author: lsi-gpenokie

Subject: Highlight

Date: 5/6/2008 4:07:50 PM

T ACCEPT - DONE (as "The phy re-initializes the scrambler at the beginning of each frame (e.g., at SOF) and does not modify primitives."
")

This << It does not modify primitives >> should be << The phy does not modify primitives >>

Author: wdc-mevans

Subject: Highlight

Date: 5/6/2008 4:07:50 PM

T ACCEPT - DONE

Comments from page 665 continued on next page

Table A.3 shows a pattern containing both JTPAT for RD+ and JTPAT for RD-. The 10b pattern resulting from encoding the 8b pattern contains the desired bit sequences for the phase shifts with both starting running disparities.

Table A.3 — JTPAT for RD+ and RD-

Dword(s)	First character	Second character	Third character	Fourth character	Notes
0 to 40	D30.3(7Eh)	D30.3(7Eh)	D30.3(7Eh)	D30.3(7Eh)	This dword is sent a total of 41 times.
	
41	D30.3(7Eh)	D30.3(7Eh)	D30.3(7Eh)	D20.3(74h)	This dword is sent once.
42	D30.3(7Eh)	D11.5(ABh)	D21.5(B5h)	D21.5(B5h)	This dword is sent once.
43 to 54	D21.5(B5h)	D21.5(B5h)	D21.5(B5h)	D21.5(B5h)	This dword is sent a total of 12 times.
	
55	D21.5(B5h)	D30.2(5Eh)	D10.2(4Ah)	D30.3(7Eh)	This dword is sent once.
56 to 96	D30.3(7Eh)	D30.3(7Eh)	D30.3(7Eh)	D30.3(7Eh)	This dword is sent a total of 41 times.
	
97	D30.3(7Eh)	D30.3(7Eh)	D30.3(7Eh)	D11.3(6Bh)	This dword is sent once.
98	D30.3(7Eh)	D20.2(54h)	D10.2(4Ah)	D10.2(4Ah)	This dword is sent once.
99 to 110	D10.2(4Ah)	D10.2(4Ah)	D10.2(4Ah)	D10.2(4Ah)	This dword is sent a total of 12 times.
	
111	D10.2(4Ah)	D30.5(BEh)	D21.5(B5h)	D30.3(7Eh)	This dword is sent once.

A.2 Compliant jitter tolerance pattern (CJTPAT)

The compliant jitter tolerance pattern (CJTPAT) is the JTPAT for RD+ and RD- (see table A.3 in A.1) included as the payload in an SSP DATA frame or an SMP frame. The CJTPAT is:

- 1) SOF;
- 2) 6 data dwords containing either:
 - A) an SSP DATA frame header; or
 - B) an SMP frame header followed by 23 bytes;
- 3) 112 data dwords containing JTPAT for RD+ and RD-;
- 4) 1 data dword containing a CRC value; and
- 5) EOF.

Deletable primitives may be included in the transmission of the CJTPAT, but the number of deletable primitives transmitted should be as small as possible so that the percentage of the transfer that is the JTPAT is as high as possible.

Because the SOF, EOF, and CRC are the same in SSP and SMP, CJTPAT complies with:

- a) the SSP frame transmission format defined by the SSP link layer (see figure 189 in 7.16.3);
- b) the SSP frame format defined by the SSP transport layer (see table 163 in 9.2.1);
- c) the SMP frame transmission format defined by the SMP link layer (see figure 203 in 7.18.1); and
- d) the SMP frame format defined by the SMP transport layer (see table 191 in 9.4.1).

When a phy transmits a frame, it XORs the 8b data provided by the application layer with the output of a scrambler before transmission (see 7.6). It does not modify primitives and it re-initializes the scrambler at the beginning of each frame (e.g., at SOF). If the application layer XORs the desired 8b pattern with the expected output of the scrambler prior to submitting it to the transmitter, then the transmitter transmits the desired pattern. The 8b data dwords are scrambled by XORing the pattern with the expected scrambler dword output, taking into account the position of the 8b data dwords within the frame.

It
s/b
The phy

Figure A.1 shows how to pre-scramble CJTPAT into the phy transmitter so CJTPAT results on the physical link.

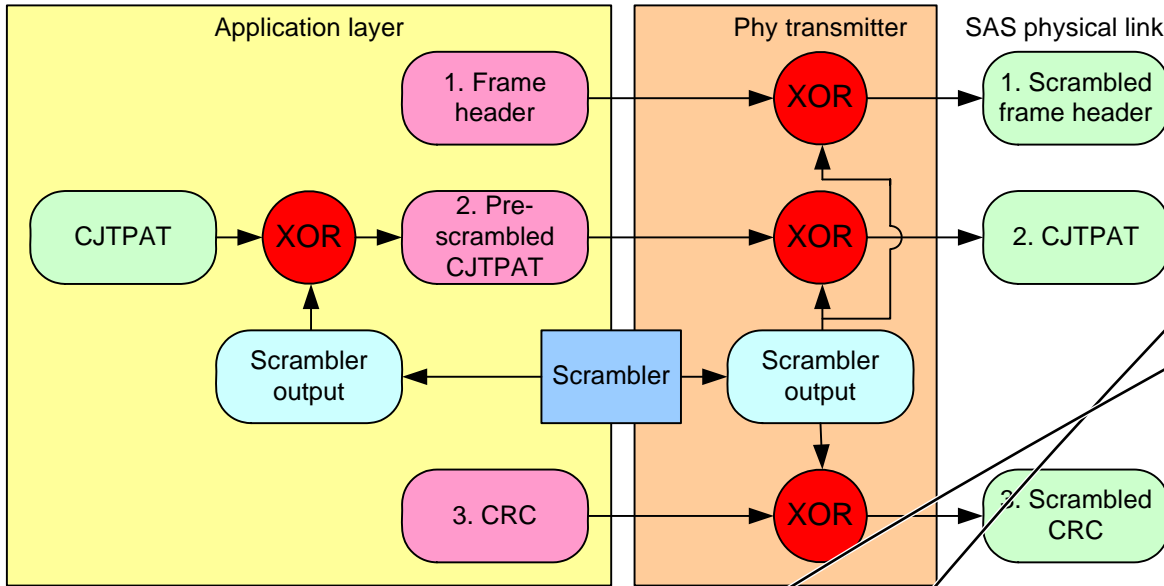

Figure A.1 — CJTPAT pre-scrambling

Table A.4 defines CJTPAT.

The “SSP frame contents” column in table A.4 shows the interpretation of the frame if viewed as an SSP DATA frame.

The “SMP frame contents” column in table A.4 shows the interpretation of the frame if viewed as an SMP frame.

The “Pre-scrambled CJTPAT” column in table A.4 shows the result of XORing CJTPAT with the expected scrambler output before presenting the frame to the phy transmitter. If the data in this column is supplied to the phy transmitter and it is scrambled again, the data in the “CJTPAT” column is transmitted onto the physical link. The frame header is not pre-scrambled, and the CRC is calculated over the frame header and the pre-scrambled CJTPAT.

The “Scrambler output” column in table A.4 shows the scrambler output for each data dword in the frame. The scrambler output is independent of the data pattern.

● Author: Isi-gpenokie
Subject: Highlight
Date: 5/6/2008 4:07:50 PM
T ACCEPT - DONE

This << scrambled again, the data in the >> should be << scrambled again, then the data in the >>

● Author: wdc-mevans
Subject: Highlight
Date: 5/6/2008 4:07:50 PM
T REJECT (changing "and it" to "where it" instead, which reads better)

it
s/b
the data

The "CJTPAT" column in table A.4 shows CJTPAT, transmitted on the physical link.

Table A.4 — CJTPAT (part 1 of 4)

Data dword number	SSP frame contents	SMP frame contents	Pre-scrambled CJTPAT	Scrambler output	CJTPAT
Not applicable	SOF		SOF	Not applicable	SOF
0	SSP frame header	SMP frame header and 3 frame-type dependent bytes	unknown	C2D2768Dh	unknown
1		Frame-type dependent bytes	unknown	1F26B368h	unknown
2			unknown	A508436Ch	unknown
3			unknown	3452D354h	unknown
4			unknown	8A559502h	unknown
5			unknown	BB1ABE1Bh	unknown
6	INFORMATION UNIT field (dwords 0 - 7)	Frame-type dependent bytes	8428C943h	FA56B73Dh	7E7E7E7Eh
7			2D887565h	53F60B1Bh	7E7E7E7Eh
8			8EFEE23Fh	F0809C41h	7E7E7E7Eh
9			0A01BD34h	747FC34Ah	7E7E7E7Eh
10			C0F82CEFh	BE865291h	7E7E7E7Eh
11			0411D9C8h	7A6FA7B6h	7E7E7E7Eh
12			4F1D98A8h	3163E6D6h	7E7E7E7Eh
13			8E488072h	F036FE0Ch	7E7E7E7Eh
14	INFORMATION UNIT field (dwords 8-15)	Frame-type dependent bytes	608D9457h	1EF3EA29h	7E7E7E7Eh
15			954A58EAh	EB342694h	7E7E7E7Eh
16			2DFB4569h	53853B17h	7E7E7E7Eh
17			9734A233h	E94ADC4Dh	7E7E7E7Eh
18			235E70F6h	5D200E88h	7E7E7E7Eh
19			177F93AEh	6901EDD0h	7E7E7E7Eh
20			84E046A0h	FA9E38DEh	7E7E7E7Eh
21			16A53579h	68DB4B07h	7E7E7E7Eh
22	INFORMATION UNIT field (dwords 16 - 23)	Frame-type dependent bytes	3B743D05h	450A437Bh	7E7E7E7Eh
23			E873A976h	960DD708h	7E7E7E7Eh
24			414B98E6h	3F35E698h	7E7E7E7Eh
25			8008E6DBh	FE7698A5h	7E7E7E7Eh
26			B670896Bh	C80EF715h	7E7E7E7Eh
27			181EEED1h	666090AFh	7E7E7E7Eh
28			848EABB5h	FAF0D5CBh	7E7E7E7Eh
29			55FC7EE1h	2B82009Fh	7E7E7E7Eh

This page contains no comments

Table A.4 — CJTPAT (part 2 of 4)

Data dword number	SSP frame contents	SMP frame contents	Pre-scrambled CJTPAT	Scrambler output	CJTPAT
30	INFORMATION UNIT field (dwords 24 - 31)	Frame-type dependent bytes	704F0AEFh	0E317491h	7E7E7E7Eh
31			088A1460h	76F46A1Eh	7E7E7E7Eh
32			8A131736h	F46D6948h	7E7E7E7Eh
33			05B3F4Edh	7BCD8A93h	7E7E7E7Eh
34			6B6DD300h	1513AD7Eh	7E7E7E7Eh
35			600C8090h	1E72FEEh	7E7E7E7Eh
36			DE6AD445h	A014AA3Bh	7E7E7E7Eh
37			5DD4AA99h	23AAD4E7h	7E7E7E7Eh
38	INFORMATION UNIT field (dwords 32 - 39)	Frame-type dependent bytes	CEA2E019h	B0DC9E67h	7E7E7E7Eh
39			9EDB0D85h	E0A573FBh	7E7E7E7Eh
40			78B4EA31h	06CA944Fh	7E7E7E7Eh
41			1D9CEC6Ch	63E29212h	7E7E7E7Eh
42			3B061C13h	4578626Dh	7E7E7E7Eh
43			2D5872EDh	53260C93h	7E7E7E7Eh
44			40275C7Ch	3E592202h	7E7E7E7Eh
45			5510B41Dh	2B6ECA63h	7E7E7E7Eh
46	INFORMATION UNIT field (dwords 40 - 47)	Frame-type dependent bytes	1D146161h	636A1F1Fh	7E7E7E7Eh
47			4BCBD799h	35B5A9EDh	7E7E7E74h
48			34091548h	4AA2A0FDh	7EABB5B5h
49			C41A5423h	71AFE196h	B5B5B5B5h
50			5460CED7h	E1D57B62h	B5B5B5B5h
51			E015E33Fh	55A0568Ah	B5B5B5B5h
52			37643CDDh	82D18968h	B5B5B5B5h
53			96F9014Ah	234CB4FFh	B5B5B5B5h
54	INFORMATION UNIT field (dwords 48 - 55)	Frame-type dependent bytes	36FDABCAh	83481E7Fh	B5B5B5B5h
55			07AF5DCAh	B21AE87Fh	B5B5B5B5h
56			1C705F78h	A9C5EACDh	B5B5B5B5h
57			D7B41976h	6201ACC3h	B5B5B5B5h
58			43BC8C7Bh	F60939CEh	B5B5B5B5h
59			8CEAC3C8h	395F767Dh	B5B5B5B5h
60			9A10EDF4h	2FA55841h	B5B5B5B5h
61			36330004h	836D4A7Ah	B55E4A7Eh

This page contains no comments

Table A.4 — CJTPAT (part 3 of 4)

Data dword number	SSP frame contents	SMP frame contents	Pre-scrambled CJTPAT	Scrambler output	CJTPAT
62	INFORMATION UNIT field (dwords 56 - 63)	Frame-type dependent bytes	46F32604h	388D587Ah	7E7E7E7Eh
63			09438122h	773DFF5Ch	7E7E7E7Eh
64			425DE2CDh	3C239CB3h	7E7E7E7Eh
65			2833EFDEh	564D91A0h	7E7E7E7Eh
66			3D93759Fh	43ED0BE1h	7E7E7E7Eh
67			E60A57D9h	987429A7h	7E7E7E7Eh
68			9B53A5DCh	E52DDBA2h	7E7E7E7Eh
69			99F3B601h	E78DC87Fh	7E7E7E7Eh
70	INFORMATION UNIT field (dwords 64 - 71)	Frame-type dependent bytes	74C6B817h	0AB8C669h	7E7E7E7Eh
71			1AAEFDB7h	64D083C9h	7E7E7E7Eh
72			7B438744h	053DF93Ah	7E7E7E7Eh
73			9097A794h	EEE9D9Eah	7E7E7E7Eh
74			3AC345E9h	44BD3B97h	7E7E7E7Eh
75			719C35F2h	0FE24B8Ch	7E7E7E7Eh
76			8CF328EAh	F28D5694h	7E7E7E7Eh
77			1D6EC8A7h	6310B6D9h	7E7E7E7Eh
78	INFORMATION UNIT field (dwords 72 - 79)	Frame-type dependent bytes	69ECD0B0h	1792AECEh	7E7E7E7Eh
79			742850DFh	0A562EA1h	7E7E7E7Eh
80			CE36A117h	B048DF69h	7E7E7E7Eh
81			68645606h	161A2878h	7E7E7E7Eh
82			2B67B52Fh	5519CB51h	7E7E7E7Eh
83			678BC028h	19F5BE56h	7E7E7E7Eh
84			9181CAC8h	EFFFB4B6h	7E7E7E7Eh
85			CDFC100Ch	B3826E72h	7E7E7E7Eh
86	INFORMATION UNIT field (dwords 80 - 87)	Frame-type dependent bytes	9A0C53A4h	E4722DDAh	7E7E7E7Eh
87			1EC12F57h	60BF5129h	7E7E7E7Eh
88			5AF3EE8Bh	248D90F5h	7E7E7E7Eh
89			3378AC62h	4D06D21Ch	7E7E7E7Eh
90			00E86812h	7E96166Ch	7E7E7E7Eh
91			21D19DCAh	5FAFE3B4h	7E7E7E7Eh
92			2E12C62Bh	506CB855h	7E7E7E7Eh
93			258E4EE6h	5BF03098h	7E7E7E7Eh

This page contains no comments

Table A.4 — CJTPAT (part 4 of 4)

Data dword number	SSP frame contents	SMP frame contents	Pre-scrambled CJTPAT	Scrambler output	CJTPAT
94	INFORMATION UNIT field (dwords 88 - 95)	Frame-type dependent bytes	38AAC8CDh	46D4B6B3h	7E7E7E7Eh
95			7B65E06Fh	051B9E11h	7E7E7E7Eh
96			7F22BB28h	015CC556h	7E7E7E7Eh
97			9C6E4B91h	E21035EFh	7E7E7E7Eh
98			281E330Bh	56604D75h	7E7E7E7Eh
99			50081922h	2E76675Ch	7E7E7E7Eh
100			796A088Eh	071476F0h	7E7E7E7Eh
101			D18EF995h	AFF087EBh	7E7E7E7Eh
102	INFORMATION UNIT field (dwords 96 - 103)	Frame-type dependent bytes	651CA57Fh	1B62DB01h	7E7E7E7Eh
103			5D186107h	23661F6Ch	7E7E7E6Bh
104			8623FA6Dh	F877B027h	7E544A4Ah
105			BFA9C3E8h	F5E389A2h	4A4A4A4Ah
106			A48D7C5Bh	EEC73611h	4A4A4A4Ah
107			064EB1D9h	4C04FB93h	4A4A4A4Ah
108			A29D4578h	E8D70F32h	4A4A4A4Ah
109			F5BA761Eh	BFF03C54h	4A4A4A4Ah
110	INFORMATION UNIT field (dwords 104 - 111)	Frame-type dependent bytes	A90A764Bh	E3403C01h	4A4A4A4Ah
111			6AB08034h	20FACA7Eh	4A4A4A4Ah
112			D3080FC6h	9942458Ch	4A4A4A4Ah
113			7DA881C3h	37E2CB89h	4A4A4A4Ah
114			1050DDC9h	5A1A9783h	4A4A4A4Ah
115			8402E075h	CE48AA3Fh	4A4A4A4Ah
116			4C83ED2Bh	06C9A761h	4A4A4A4Ah
117			4C7E8BD5h	06C03EABh	4ABEB57Eh
118	CRC field ^a		depends on contents of first 6 data dwords	3D2D7984h	depends on contents of first 6 data dwords
Not applicable	EOF		<primitive>	<primitive>	<primitive>

^a The CRC field shall be set to a valid value for the frame.

A phy or test equipment transmitting CJTPAT outside connections may transmit it with fixed content as defined in table A.5.

Table A.5 shows CJTPAT with fixed content:

- a) interpreted as an SSP frame, with the FRAME TYPE field in the frame header set to 01h (i.e., DATA), each other field in the frame header set to zero, the INFORMATION UNIT field containing JTPAT for RD+ and RD-, and the CRC field set to a fixed value; and

This page contains no comments

- b) interpreted as an SMP frame, with the SMP FRAME TYPE field in the frame header set to 01h (i.e., reserved), the frame-type dependent bytes containing JTPAT for RD+ and RD-, and the CRC field set to a fixed value.

Table A.5 — CJTPAT with fixed content

Data dword number	SSP frame contents	SMP frame contents	Pre-scrambled CJTPAT	Scrambler output	CJTPAT
Not applicable	SOF		SOF	Not applicable	SOF
0	FRAME TYPE field set to 01h (i.e., DATA frame) and 23 subsequent bytes each set to 00h	SMP FRAME TYPE field set to 01h (i.e., reserved) and 23 subsequent frame-type dependent bytes each set to 00h	01000000h	C2D2768Dh	C3D2768Dh
1			00000000h	1F26B368h	1F26B368h
2			00000000h	A508436Ch	A508436Ch
3			00000000h	3452D354h	3452D354h
4			00000000h	8A559502h	8A559502h
5			00000000h	BB1ABE1Bh	BB1ABE1Bh
6	INFORMATION UNIT field	Frame-type dependent bytes	See the INFORMATION UNIT field in table A.4		
117					
118	CRC field		79C211AAh	3D2D7984h	44EF682Eh
Not applicable	EOF		EOF	Not applicable	EOF

A.3 Considerations for a phy transmitting JTPAT and CJTPAT

A phy may be configured to transmit JTPAT for RD+ and RD- (see A.2) by:

- a) using the SMP PHY TEST FUNCTION function (see 10.4.3.29) or the Protocol-Specific diagnostic page (see 10.2.9.2) specifying the phy, with the PHY TEST FUNCTION field set to 01h (i.e., TRANSMIT PATTERN), and the PHY TEST PATTERN field set to 01h (i.e., JTPAT); **and**
- b) vendor-specific mechanisms.

A phy may be configured to transmit CJTPAT (see A.2) by:

- a) using the SMP PHY TEST FUNCTION function (see 10.4.3.29) or the Protocol-Specific diagnostic page (see 10.2.9.2) specifying the phy, with the PHY TEST FUNCTION field set to 01h (i.e., TRANSMIT PATTERN), and the PHY TEST PATTERN field set to 02h (i.e., CJTPAT);
- b) including CJTPAT as a data pattern while perform SCSI commands (e.g., the WRITE BUFFER command if the phy is in an initiator port, or the SCSI READ BUFFER command if the phy is in a target port). The frame length and scrambling need to be predictable to ensure the desired pattern is transmitted on the physical link; **and**
- c) vendor-specific mechanisms.

A.4 Considerations for a phy receiving JTPAT and CJTPAT

If a phy receives JTPAT (see A.1) **inside or outside** a connection, **it** considers the data dwords to be idle dwords and ignores them.

If a phy receives CJTPAT (see A.2) outside a connection, **the** SL receiver (see 7.14.2) considers the SOF and EOF to be unexpected dwords and ignores them, and considers the data dwords to be idle dwords and ignores them.

Phy-layer based phy event counters (e.g., invalid dword count, running disparity error count, loss of dword synchronization count, elasticity buffer overflow count, and received ERROR count) count events that occur while receiving idle dwords, so may be used to count events while receiving JTPAT or CTPAT.

Page: 671

● Author: hpq-relliott
Subject: Note
Date: 5/6/2008 4:07:50 PM
ACCEPT - DONE (and fixed my C program output format that caused this confusion)

(Leon Krantz, Marvell)

In dword 118, 79C211AAh should be swapped with 44EF682Eh

● Author: lsi-gpenokie
Subject: Highlight
Date: 5/6/2008 4:07:50 PM

T ACCEPT - DONE
This << and >> should be << or >> as this is one or the other not both.

● Author: lsi-gpenokie
Subject: Highlight
Date: 5/6/2008 4:07:50 PM

T ACCEPT - DONE
This << and >> should be << or >> as this is one or the other not both.

● Author: wdc-mevans
Subject: Highlight
Date: 5/23/2008 3:11:26 PM

T REJECT (first noun/subject convention)
it
s/b
the phy

● Author: intc-mseidel
Subject: Highlight
Date: 5/6/2008 4:07:50 PM

T REJECT (this is emphasizing that they are idle dwords both inside and outside connections - the fact that there is a connection doesn't matter. This differs for CJTPAT in the next sentence.)

It is not necessary to require that a phy receiving JTPAT inside a connection to treat the data dwords as idle dwords and ignore them; "inside or outside" in the first sentence s/b "outside".

● Author: RElliott
Subject: Highlight
Date: 6/30/2008 6:16:52 PM

T ACCEPT - DONE
the
s/b
then the

If a phy receives CJTPAT inside an SSP connection, the phy expects it to have a valid frame header (e.g., valid frame type, source SAS address, etc.) and follow SSP frame transmission rules (e.g., RRDY credit, ACK or NAK exchange).

If a phy receives CJTPAT inside an SMP connection, the phy expects it to have a valid frame header (e.g., valid frame type) and follow SMP frame transmission rules (e.g., only one frame is transmitted in each direction per connection). Sending CJTPAT inside SMP connections is not recommended.

No standard mechanism is defined to configure a phy to expect to receive JTPAT or CJTPAT (e.g., to compare the incoming pattern to the expected pattern).

Page: 672

● Author: wdc-mevans
Subject: Highlight
Date: 5/23/2008 3:13:36 PM

T REJECT (this "considerations for a phy receiving" section is describing the rules in other places of the standard that frames inside SSP connections must look like SSP frames. This is not a place to mandate that a transmitter place CJTPAT inside an SSP frame; that's already been communicated earlier in this annex.)

the phy expects it to have a valid frame header (e.g., valid frame type, source SAS address, etc.)

s/b

then the CJTPAT shall be contained in an SSP DATA frame (e.g., including valid frame type, source SAS address, etc.)

● Author: Isi-gpenokie
Subject: Cross-Out
Date: 7/17/2008 6:12:02 PM

T ACCEPT - DONE (7/15 change to "i.e., all fields in the frame header including frame type and source SAS address"...

all the fields must be valid, but they're not all listed here - just two of them. Each one does not individually serve as an example for being a "valid frame header")

The << , etc. >> is redundant and should be deleted.

● Author: RElliott
Subject: Note
Date: 6/30/2008 6:16:52 PM

T ACCEPT - DONE

the

s/b

then the

(twice)

● Author: wdc-mevans
Subject: Highlight
Date: 5/23/2008 3:13:52 PM

T REJECT (see reply on previous paragraph)

the phy expects it to have a valid frame header (e.g., valid frame type)

s/b

then the CJTPAT shall be contained in an SMP frame (e.g., including svalid frame type)

● Author: Isi-gpenokie
Subject: Highlight
Date: 5/6/2008 4:07:50 PM

T ACCEPT - DONE

This << No standard mechanism is defined to configure a phy to expect to >> should be << This standard defines no mechanism for configuring a phy to expect to >>

Annex B (informative)

Signal performance measurements

B.1 Signal performance measurements overview

This annex specifies the configuration requirements for making electrical performance measurements. These measurements consist of signal output, signal tolerance, and return loss. Standard loads are used in all cases so that independent specification of connection components and transportability of the measurement results are possible.

B.2 Simple physical link

B.2.1 Simple physical link overview

The physical link is considered to consist of the following component parts:

- the transmitter device;
- the interconnect; and
- the receiver device.

Each of those components is connected by a separable connector. On a TxRx connection, signals travel in opposite directions down the same nominal path.

Figure B.1 shows a physical link and the location of the connectors.

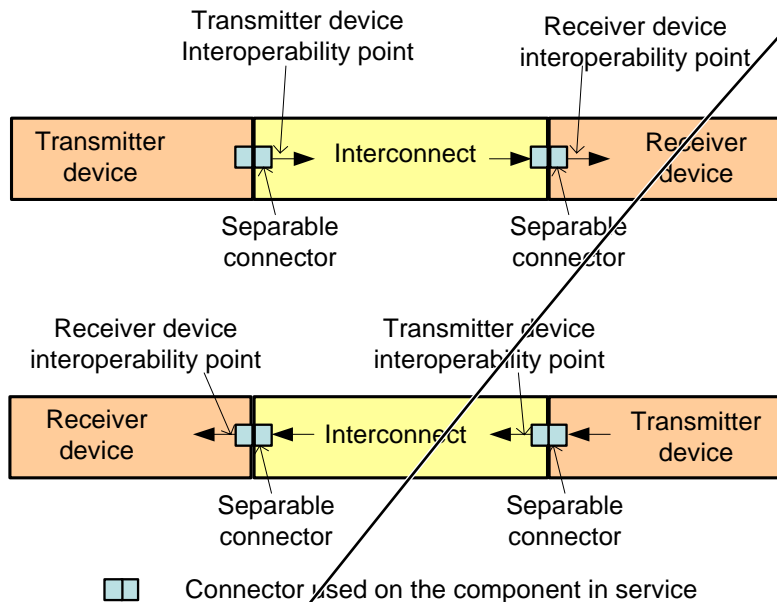

Figure B.1 — A simple physical link

Since connectors are always used in the mated condition, the only access to the signals is before the signal enters the mated connector (i.e., upstream) or after the signal exits the connector (i.e., downstream). Even if signals were able to be practically accessed at the point of mating within the connector, such access would disturb the connector to the point that the measurement of the signal would be compromised (e.g., attempting to access the unmated connector with probes does not provide valid results because the connector is not in the same condition when unmated as when mated and the probe contact points are not at the same location as the connector contact points).

In this annex, signal outputs are always measured downstream of the mated connector (see figure B.1) so that the contribution of the mated connector to the signal properties is included in the measurement. This

Page: 673

● Author: RElliott
Subject: Highlight
Date: 8/28/2008 3:47:48 PM

T ACCEPT - DONE (changed this to "methodologies". Added comments for other "requir*" changes that seemed acceptable)

Get rid of "requirements" and "requir*" everywhere where they might be viewed as placing requirements

● Author: wdc-mevans
Subject: Cross-Out
Date: 5/25/2008 7:59:13 PM

T ACCEPT - DONE (Alvin: Accept. Remove "practically and add practical in the first sentence of the paragraph)

practically
[Delete the unnecessary word.]

● Author: lsi-gpenokie
Subject: Highlight
Date: 5/30/2008 5:12:00 PM

T ACCEPT - DONE (as " may disturb the connector to the point that the measurement of the signal is compromised")

This << such access would disturb the connector to the point that the measurement of the signal would be compromised >> should be << such access disturbs the connector to the point that the measurement of the signal is compromised >>

approach assigns a portion of the connector losses to the upstream component, but it also makes the signal measurement conservative. If the connectors on both ends of the interconnect are the same, the additional loss at the downstream connector is offset by the reduced loss at the upstream connector. For transmitter devices, a slightly stronger transmitter is required to pass the signal through the downstream half of the connector that does not belong to the transmitter device. The signal coming into receiver devices is specified after the signal has passed through the connector.

~~Examination of the details of the measurement methods described in this annex shows that the mated connector issue may not be as severe as it appears.~~

B.2.2 Assumptions for the structure of the transmitter device and the receiver device

Figure B.2 shows the details of a transmitter device.

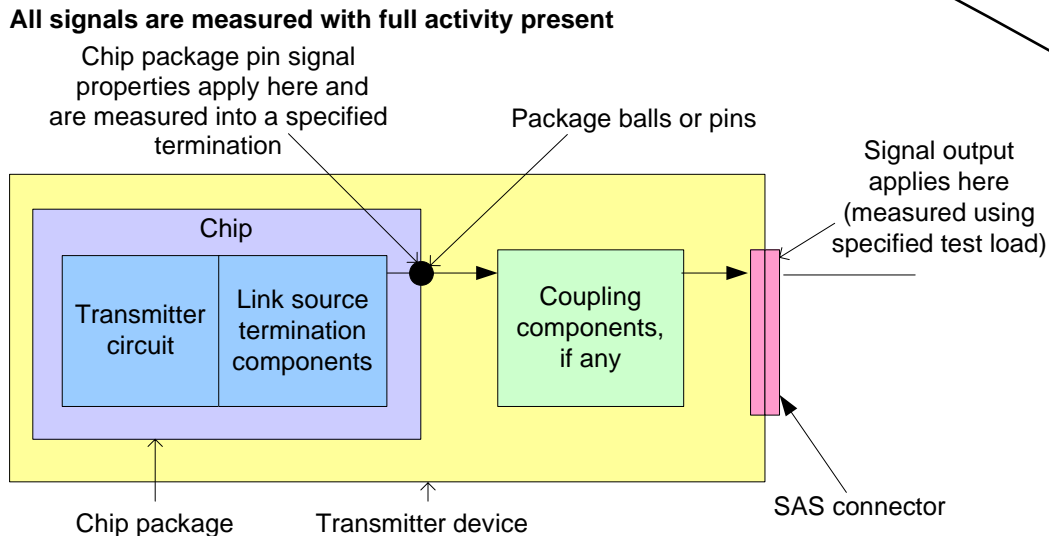

Figure B.2 — Transmitter device details

As figure B.2 shows, any of the following internal parts of this transmitter device may be labeled as the transmitter:

- the transmitter circuit in the chip;
- the chip itself; and
- the chip and its associated chip package.

The term transmitter is therefore not well defined and is not used in the terminology without a modifier.

The transmitter device contains:

- a connector (i.e., half a mated pair);
- coupling components, if any;
- PCB traces and vias;
- the chip package;
- ESD protection devices, if any;
- the source termination; and
- the transmitter circuit.

It is assumed that the source termination is contained within the chip package.

Interoperability points may be defined at the chip package pins in some standards (e.g., Ethernet XAUI). This standard does not define requirements at chip package pins.

● Author: RElliott
Subject: Highlight
Date: 6/30/2008 6:16:52 PM

T ACCEPT - DONE
the
s/b
then the

● Author: RElliott
Subject: Cross-Out
Date: 8/31/2008 5:01:40 PM

T ACCEPT - DONE

Delete this:

For transmitter devices, a slightly stronger transmitter is required to pass the signal through the downstream half of the connector that does not belong to the transmitter device. The signal coming into receiver devices is specified after the signal has passed through the connector.

because George Penokie (LSI) doesn't like the word "required"

● Author: RElliott
Subject: Highlight
Date: 8/31/2008 5:01:30 PM

T REJECT (moot)

transmitter
s/b
transmitter circuit

● Author: lsi-gpenokie
Subject: Cross-Out
Date: 5/6/2008 4:07:50 PM

T ACCEPT - DONE

This << Examination of the details of the measurement methods described in this annex shows that the mated connector issue may not be as severe as it appears.>> is an editorial comment and should not be in a standard.

● Author: lsi-gpenokie
Subject: Highlight
Date: 5/6/2008 4:07:50 PM

T ACCEPT - DONE

This << and >> should be << or >> as this list is one or the other but not all.

● Author: RElliott
Subject: Highlight
Date: 8/28/2008 3:13:50 PM

T ACCEPT - DONE

Interoperability points may be defined at the chip package pins in some standards (e.g., Ethernet XAUI). This standard does not define requirements at chip package pins.

s/b

Although interoperability points are defined at the chip package pins in some standards (e.g., Ethernet XAUI), this standard does not define requirements at chip package pins.

Figure B.3 shows the details of a receiver device. It is similar to the transmitter device.

All signals measured with full activity present

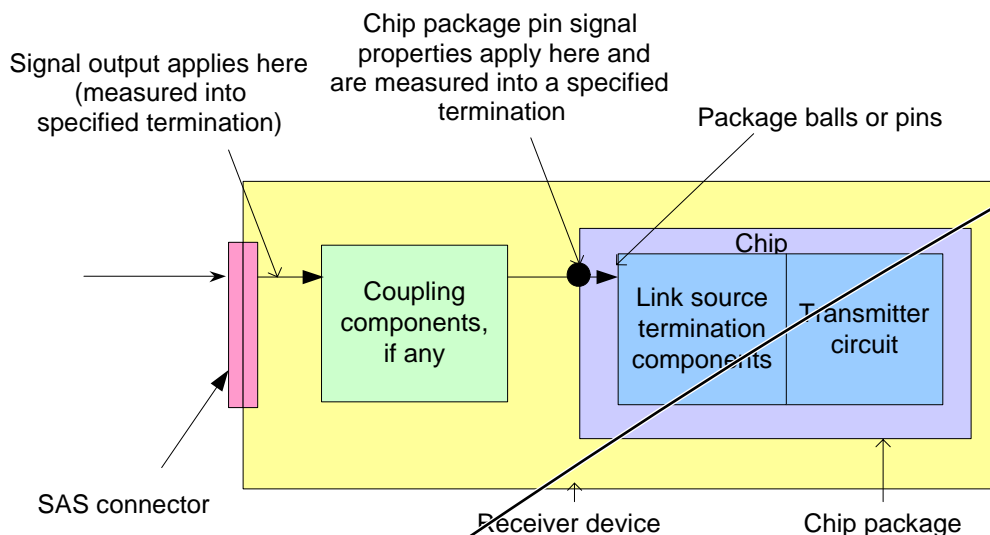

Figure B.3 — Receiver device details

As figure B.3 shows, any of the following internal parts of this receiver device may be labeled as the receiver:

- the receiver circuit in the chip;
- the chip itself; and
- the chip and its associated chip package.

The term receiver is therefore not well defined and is not used in the terminology without a modifier.

The receiver device contains:

- a connector (i.e., half a mated pair);
- coupling components, if any;
- PCB traces and vias;
- the chip package;
- ESD protection devices, if any;
- the physical link termination; and
- the receiver circuit.

It is assumed that the physical link termination is contained within the chip package.

B.2.3 Definition of receiver sensitivity and receiver device sensitivity

The term **receiver sensitivity is problematic in common usage**. This term is not used for interoperability in standards. A related term applicable to the receiver device input signal is receiver device sensitivity. While these two terms are related, they are significantly different because of the noise environment assumed. The description in this subclause is used to uniquely define these terms with the understanding that this standard discourages usage of either term.

For 1.5 Gbps and 3 Gbps, receiver device sensitivity is defined as the minimum vertical inner eye opening measured at the signal output point for the input to the receiver device at which the receiver chip (i.e., the receiver circuit in the chip package on the board containing the receiver device interoperability point as shown in figure B.3) delivers the required BER (see 5.3.3) with:

- the minimum horizontal eye opening;
- all activity expected in the application for the receiver circuit present (i.e., not quiesced as for the receiver sensitivity definition); and
- the CJTPAT pattern being received (see Annex A).

● Author: Isi-gpenokie
Subject: Highlight
Date: 5/6/2008 4:07:50 PM
T ACCEPT - DONE

This << and >> should be << or >> as this list is one or the other but not all.

● Author: Isi-gpenokie
Subject: Highlight
Date: 9/4/2008 11:22:31 AM

T ACCEPT - DONE (Alvin: Accept. Change the first two sentences to read:
"The term receiver sensitivity is not a well defined term and therefore is not used for interoperability in this standard. " Also changed "stressed receiver sensitivity" to "stressed receiver device sensitivity" throughout chapter 5)

This << receiver sensitivity is problematic in common usage. This term is not used for interoperability in standards.>> should be << receiver sensitivity is not a well defined term and therefore is not used for interoperability in this standard. >>

For 6 Gbps, receiver device sensitivity is defined as the minimum vertical inner eye opening determined by simulation. The signal measured at the input to the receiver device is processed in a manner to simulate the additional interconnect losses (e.g., board traces, chip package). Then, the equalization function provided by the receiver circuit is applied to determine the resulting eye opening.

Special test conditions are required to measure these sensitivities (see B.8). The terminology used in this standard is signal tolerance instead of receiver device sensitivity.

B.3 Measurement ~~architecture requirements~~

B.3.1 General

Signal specifications are only meaningful if the signals are able to be measured with practical instrumentation. Another requirement is that different laboratories making measurements on the same signal get the same results within acceptable measurement error (i.e., the measurements need to be accessible, verifiable, and transportable). As of the publishing of this standard, there are no accepted standard for creating signals with traceable properties and with all the properties required for an effective signal specification architecture for high speed serial applications.

Some of the elements required for practical, verifiable, and transportable signal measurements are included in this standard.

Having signal specifications at interoperability points that do not depend on the actual properties of the other physical link components not under test requires that specified known test loads be used for the signal measurements. In service, the load presented to the interoperability point is that of the actual component and environment.

Interfacing with practical instruments ~~also~~ requires that specified impedance environments be used. This forces a signal measurement architecture where the impedance environment is 50 ohm single-ended (i.e., 100 ohm differential). It also forces the requirement for instrumentation-quality loads of the correct value.

Instrumentation-quality loads are readily available for simple transmission line termination. However, none are available for more complex loads that include specified propagation time, insertion loss properties, crosstalk properties, and jitter creation properties.

For signal tolerance measurements, the signal is calibrated before applying it to the interoperability point under test. This signal calibration is done by adjusting the properties of the specified signal source system as measured into a laboratory-quality test load until the desired signal tolerance specifications are met. The signal source system is then disconnected from the laboratory-quality test load and connected to the interoperability point under test. It is assumed that any changes to the signal from the calibration state to the measurement state are caused by the interoperability point under test and are therefore part of the performance sought by the measurement.

B.3.2 Relationship between signal compliance measurements at interoperability points and operation in systems

The signal measurements in this standard apply under specified test conditions that simulate some parts of the conditions existing in service (e.g., this simulation includes full-duplex traffic on all phys and under all applicable environmental conditions). Other features existing in service (e.g., non-ideal return loss in parts of the physical link that are not present when measuring signals in the specified test conditions) may be included in the specifications themselves. This methodology is required to specify signal performance requirements for each side of the interoperability point that do not depend on knowing the properties of the other side.

Measuring signals in an actual functioning system at an interoperability point does not verify compliance for the components on either side of the interoperability point, although it does verify that the specific combination of components in the system at the time of the measurement produces compliant signals. Interaction between components on either side of the interoperability point may allow the signal measured to be compliant, but this compliance may have resulted because one component does not meet the specification while the other exceeds the specification.

Page: 676

Author: RElliott
Subject: Highlight
Date: 8/28/2008 3:18:45 PM
T ACCEPT - DONE

The terminology used in this standard is signal tolerance instead of receiver device sensitivity.

s/b

This standard uses the term signal tolerance instead of receiver device sensitivity.

Author: RElliott
Subject: Highlight
Date: 8/28/2008 3:18:32 PM
T ACCEPT - DONE

Special test conditions are required to measure these sensitivities (see B.8).

s/b

B.8 describes special test conditions to measure these sensitivities.

Author: RElliott
Subject: Cross-Out
Date: 8/28/2008 3:19:32 PM
T ACCEPT - DONE

requirements

Author: RElliott
Subject: Highlight
Date: 8/28/2008 3:20:59 PM
T ACCEPT - DONE

Measurement

s/b

Signal measurement

Author: wdc-mevans
Subject: Highlight
Date: 5/6/2008 4:07:50 PM
T ACCEPT - DONE

standard

s/b

standards

Author: Isi-gpenokie
Subject: Cross-Out
Date: 5/25/2008 8:02:39 PM
T ACCEPT - DONE (per Alvin)

Delete << also >> as it adds nothing.

Author: Isi-gpenokie
Subject: Highlight
Date: 8/29/2008 6:31:04 PM
T ACCEPT - DONE (merge into previous sentence with "and also forces")

This << It also forces the requirement for in >> should be << Interfacing with practical instruments also forces the requirement for in >>

Comments from page 676 continued on next page

For 6 Gbps, receiver device sensitivity is defined as the minimum vertical inner eye opening determined by simulation. The signal measured at the input to the receiver device is processed in a manner to simulate the additional interconnect losses (e.g., board traces, chip package). Then, the equalization function provided by the receiver circuit is applied to determine the resulting eye opening.

Special test conditions are required to measure these sensitivities (see B.8). The terminology used in this standard is signal tolerance instead of receiver device sensitivity.

B.3 Measurement architecture requirements

B.3.1 General

Signal specifications are only meaningful if the signals are able to be measured with practical instrumentation. Another requirement is that different laboratories making measurements on the same signal get the same results within acceptable measurement error (i.e., the measurements need to be accessible, verifiable, and transportable). As of the publishing of this standard, there are no accepted standard for creating signals with traceable properties and with all the properties required for an effective signal specification architecture for high speed serial applications.

Some of the elements required for practical, verifiable, and transportable signal measurements are included in this standard.

Having signal specifications at interoperability points that do not depend on the actual properties of the other physical link components not under test requires that specified known test loads be used for the signal measurements. In service, the load presented to the interoperability point is that of the actual component and environment.

Interfacing with practical instruments also requires that specified impedance environments be used. This forces a signal measurement architecture where the impedance environment is 50 ohm single-ended (i.e., 100 ohm differential). It also forces the requirement for instrumentation-quality loads of the correct value.

Instrumentation-quality loads are readily available for simple transmission line termination. However, none are available for more complex loads that include specified propagation time, insertion loss properties, crosstalk properties, and jitter creation properties.

For signal tolerance measurements, the signal is calibrated before applying it to the interoperability point under test. This signal calibration is done by adjusting the properties of the specified signal source system as measured into a laboratory-quality test load until the desired signal tolerance specifications are met. The signal source system is then disconnected from the laboratory-quality test load and connected to the interoperability point under test. It is assumed that any changes to the signal from the calibration state to the measurement state are caused by the interoperability point under test and are therefore part of the performance sought by the measurement.

B.3.2 Relationship between signal compliance measurements at interoperability points and operation in systems

The signal measurements in this standard apply under specified test conditions that simulate some parts of the conditions existing in service (e.g., this simulation includes full-duplex traffic on all phys and under all applicable environmental conditions). Other features existing in service (e.g., non-ideal return loss in parts of the physical link that are not present when measuring signals in the specified test conditions) may be included in the specifications themselves. This methodology is required to specify signal performance requirements for each side of the interoperability point that do not depend on knowing the properties of the other side.

Measuring signals in an actual functioning system at an interoperability point does not verify compliance for the components on either side of the interoperability point, although it does verify that the specific combination of components in the system at the time of the measurement produces compliant signals. Interaction between components on either side of the interoperability point may allow the signal measured to be compliant, but this compliance may have resulted because one component does not meet the specification while the other exceeds the specification.

● Author: lsi-gpenokie
Subject: Highlight
Date: 7/17/2008 5:50:54 PM
T ACCEPT - DONE (7/15 "in the signal specifications.")

What << specifications >> are being talked about here?

● Author: lsi-gpenokie
Subject: Highlight
Date: 7/17/2008 5:51:57 PM
T ACCEPT - DONE (7/15 "signal specifications")

What << specifications >> are being talked about here?

● Author: lsi-gpenokie
Subject: Highlight
Date: 7/17/2008 5:52:03 PM
T ACCEPT - DONE (7/15 "signal specifications")

What << specifications >> are being talked about here?

It is recommended that additional margin be allowed when performing signal compliance measurements to account for conditions existing in service that may not have been accounted for in the specified measurements and specifications.

B.4 De-embedding connectors in test fixtures

Connectors are part of the test fixtures (e.g. test loads) required for obtaining access to the interoperability points. This is intrinsic for most practical measurements because the connectors used on the service components are different from those used on the instrumentation.

The effects of the portions of the connector that is used on the test fixture need to be accounted for in order to not penalize the interoperability point under test by the performance of the test fixture connector. This accounting process is termed de-embedding.

Figure B.4 shows two cases that apply.

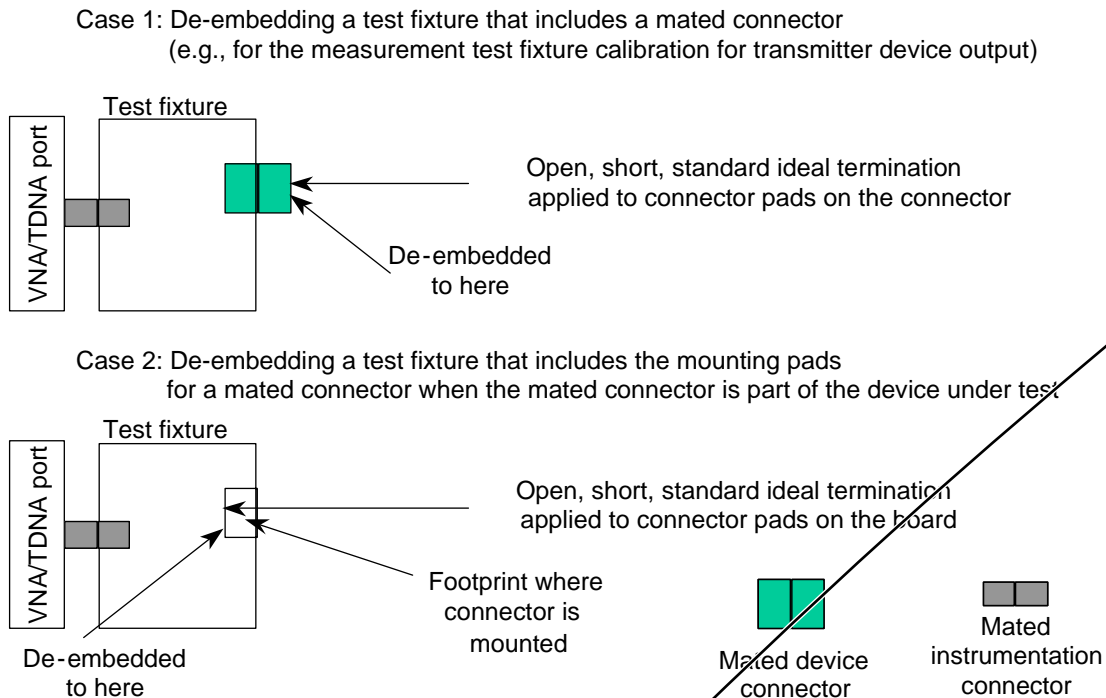

Figure B.4 — De-embedding of connectors in test fixtures

The de-embedding process assumes that the test fixture is linear and that S-parameter methodologies (see B.9) are used. Fundamentally, an S-parameter model for the test fixture with or without the connector in place is the result. Knowing this model for the test fixture, with or without the connector in place, allows simulation of the impact of the test fixture on the signal measurement.

B.5 Measurement conditions for signal output at the transmitter device

The measurement conditions required for a differential transmitter device signal output are shown in figure B.5. Figure B.5 applies to the following cases:

- the transmitter device is directly attached to the zero length test load (see 5.3.2.2); and
- the transmitter device is attached to the TCTF test load (see 5.3.2.3).

● Author: RElliott
Subject: Highlight
Date: 6/30/2008 6:16:52 PM
T ACCEPT - DONE

It is recommended that additional margin be allowed
s/b
Additional margin should be allowed

● Author: lsi-gpenokie
Subject: Highlight
Date: 7/17/2008 5:52:27 PM
T ACCEPT - DONE (7/15 "signal specifications")

What << specifications >> are being talked about here?

● Author: RElliott
Subject: Cross-Out
Date: 8/28/2008 3:23:52 PM
T ACCEPT - DONE

required

To simulate the properties of the interconnect assembly, instrumentation-quality test loads as shown in figure B.6 are used.

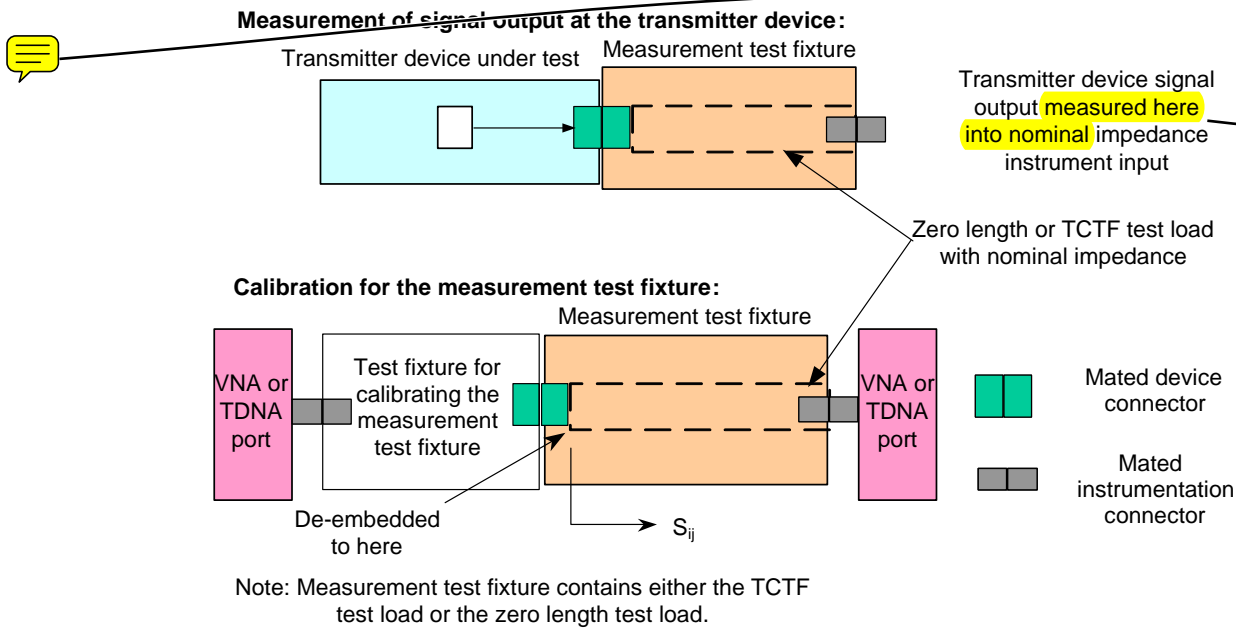

Figure B.5 — Measurement conditions for signal output at the transmitter device

An instrumentation-quality cable assembly connecting the measurement test fixture to the instrumentation port is usually required. This cable assembly is considered part of the instrumentation and is not specifically shown in figure B.5, figure B.6, figure B.7, figure B.8, figure B.9, figure B.10, and figure B.11.

A measurement test fixture may be constructed from an instrumentation-quality TCTF test load with instrumentation-quality connectors and a connector adapter as shown in figure B.6. This scheme may be useful when using multiple device connector types but adds extra components that may increase loss and delay. For best accuracy, this scheme is not recommended. Extra components make it more difficult for the transmitter device to meet the required output specifications.

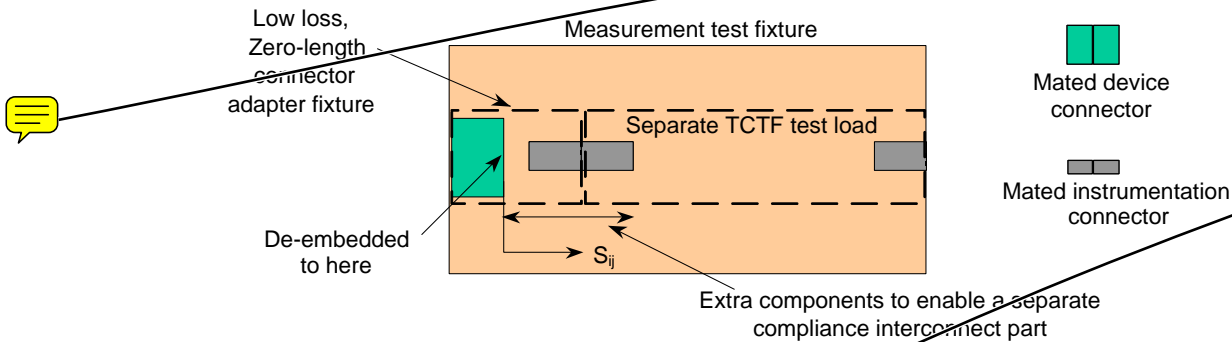



Figure B.6 — Transmitter device signal output measurement test fixture details

B.6 Measurement conditions for signal tolerance at the transmitter device

The measurement conditions required for the signal tolerance at the differential transmitter device interoperability point are shown in figure B.7. Figure B.7 shows the test signal is launched into the interconnect assembly (e.g., cable assembly or PCB) that is attached to the receiver device.

Page: 678

● Author: RElliott
Subject: Note
Date: 8/31/2008 5:04:18 PM
 ACCEPT - LAST

check figure size of B.5

● Author: Isi-gpenokie
Subject: Highlight
Date: 6/9/2008 2:22:46 PM
 ACCEPT - DONE (delete "here")

In the statement << measured here >> it is not clear where << here >> is. This needs to be fixed.

● Author: RElliott
Subject: Highlight
Date: 6/30/2008 6:16:52 PM
 ACCEPT - DONE

scheme
s/b
method

to match Isi-gpenokie comment in next sentence

● Author: Isi-gpenokie
Subject: Highlight
Date: 5/30/2008 5:15:53 PM
 ACCEPT - DONE

This << this scheme is not >> should be << this method is not >>

● Author: RElliott
Subject: Note
Date: 8/31/2008 5:04:59 PM
 ACCEPT - LAST

check figure size of B.6

● Author: Isi-gpenokie
Subject: Cross-Out
Date: 8/31/2008 5:02:14 PM
 ACCEPT - DONE (although "required" is not a keyword, this was in SAS-1.1, and this is discussing the theoretical measurement requirements, not anything specified in the standard (see the next paragraph))

This is an informative annex so the term << required >> is not allowed.

This standard does not include this performance requirement but is included here for completeness.

Measurement of signal tolerance at transmitter device (e.g., IT and CT):

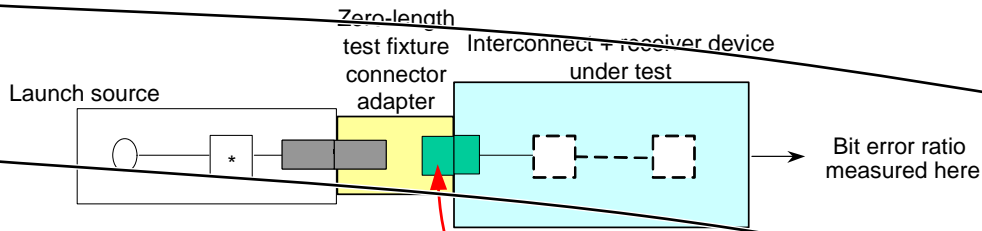

Calibration for the launch source:

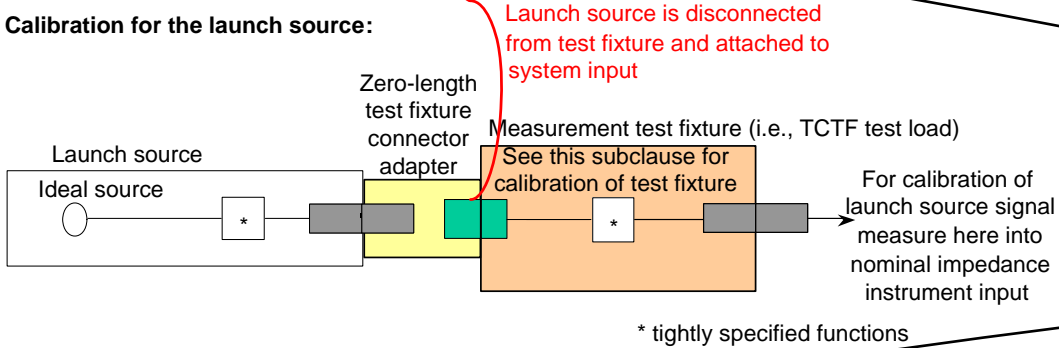

Figure B.7 — Measurement conditions for signal tolerance at the transmitter device

Figure B.8 shows calibration of the measurement test fixture.

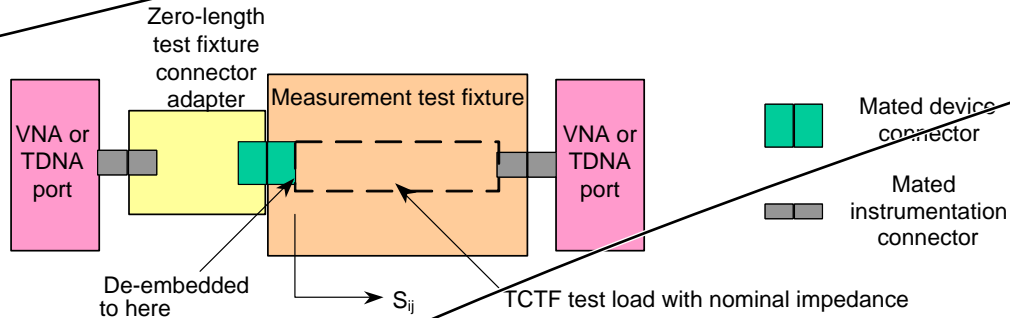

Figure B.8 — Calibration of test fixture for signal tolerance at the transmitter device

B.7 Measurement conditions for signal output at the receiver device

Figure B.9 shows the measurement conditions for the signal output at the receiver device.

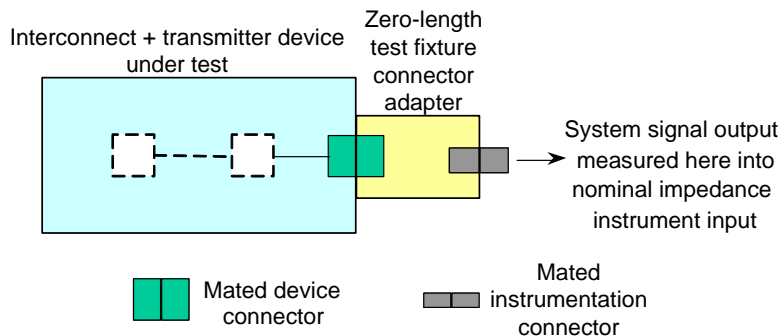



Figure B.9 — Measurement conditions for signal output at the receiver device

Page: 679

● Author: Isi-gpenokie
Subject: Highlight
Date: 5/6/2008 4:07:50 PM

 ACCEPT - DONE

This << requirement but is included here >> should be << requirement but it is included here >>

● Author: RElliott
Subject: Note
Date: 8/31/2008 5:04:26 PM

 ACCEPT - LAST

Check figure size of B.7

● Author: hpq-relliott
Subject: Note
Date: 8/28/2008 3:46:05 PM

 ACCEPT - DONE

add more shading on figures in chapter B

● Author: RElliott
Subject: Note
Date: 8/31/2008 5:04:34 PM

 ACCEPT - LAST

Check figure size of B.8

● Author: RElliott
Subject: Note
Date: 8/31/2008 5:04:39 PM

 ACCEPT - LAST

Check figure size of B.9

The interconnect may be the zero-length connector adaptor where the transmitter device is connected directly to the receiver device.

B.8 Measurement conditions for signal tolerance at the receiver device

Figure B.10 shows the measurement conditions ~~required~~ for the signal tolerance at the differential receiver device interoperability point (see 5.3.7.3).

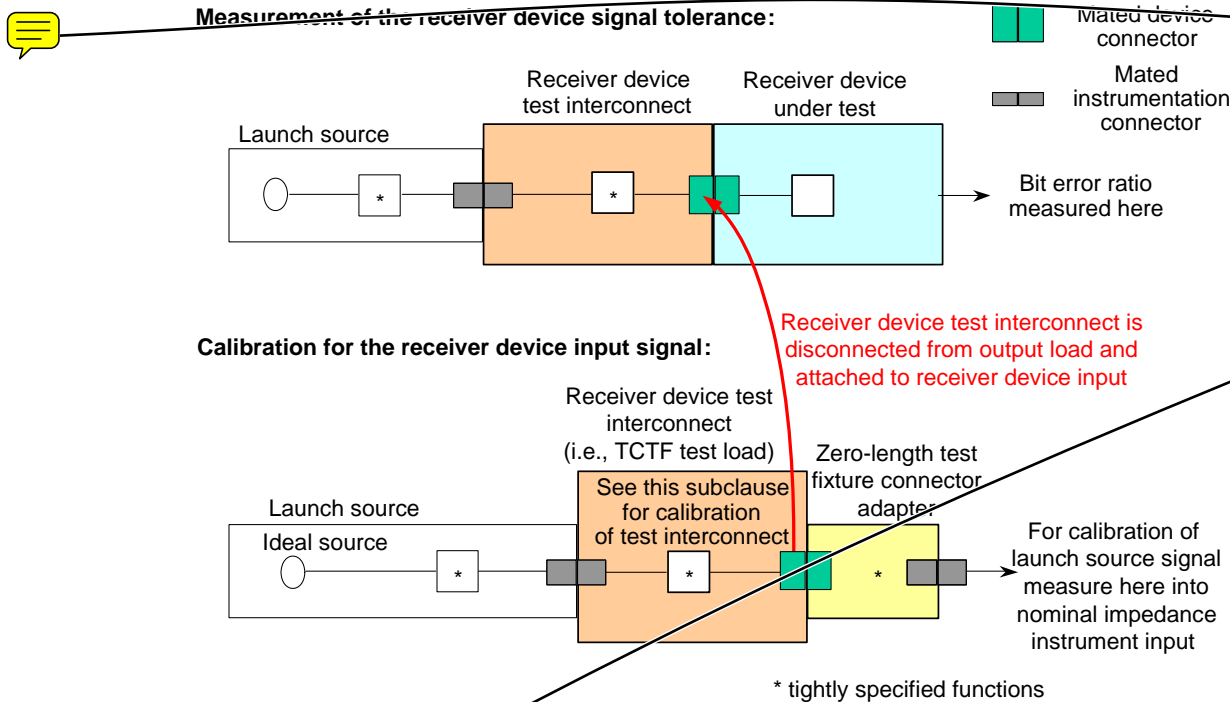
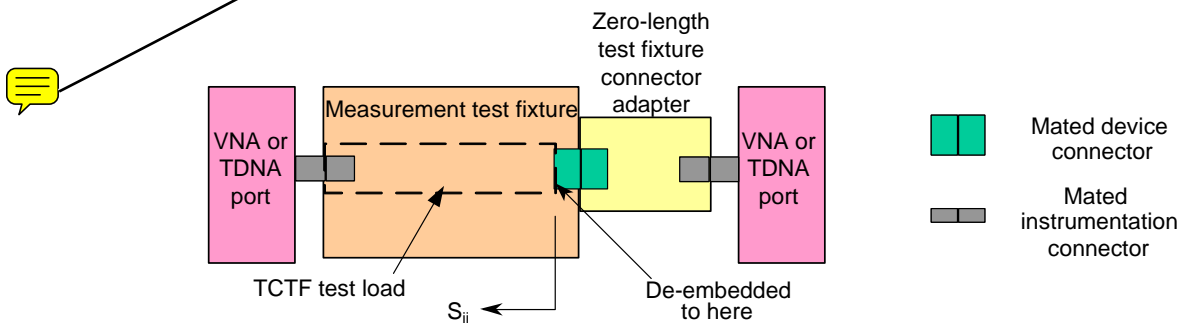

Figure B.10 — Measurement conditions for signal tolerance at the receiver device

Figure B.11 shows calibration of the measurement test fixture.



Notes:

1 This is not identical to the measurement test fixture used for the transmitter output signal even though the connector genders are the same. The pins used in the SAS connector are for the Rx (i.e., not the Tx) signals and the signals flow the other way. The S_{22} measurement here is the same as the S_{11} measurement for the transmitter output signal but on different pins.

2 The S_{21} and S_{12} are used to create the desired jitter in this application and are not as critical.

Figure B.11 — Calibration of test fixture for signal tolerance at the receiver device

● Author: RElliott
Subject: Cross-Out
Date: 8/28/2008 3:24:44 PM
 ACCEPT - DONE

required

● Author: RElliott
Subject: Note
Date: 8/31/2008 5:04:44 PM
 ACCEPT - LAST

Check figure size of B.10

● Author: RElliott
Subject: Note
Date: 8/31/2008 5:04:53 PM
 ACCEPT - LAST

Check figure size of B.11

B.9 S-parameter measurements

B.9.1 S-parameter overview

Properties of physical link elements that are linear may be represented by S-parameter (i.e., scattering parameter) spectra. There are two problematic areas when applying S-parameters to differential electrical physical links:

- a) naming conventions; and
- b) use of single-ended vector network methods on differential and common-mode systems.

This subclause explores both of these areas.

Measurement configurations for the most common conditions are described in some detail.

B.9.2 S-parameter naming conventions

There are two types of measurements performed with S-parameters:

- a) return loss from the same port of the element; and
- b) insertion loss across the element.

Each S-parameter is a function of frequency returning complex numbers and is expressed with:

- a) a magnitude component, usually expressed in dB; and
- b) a phase component.

For a two-port linear element having ports i and j with the signals being either differential or common-mode, S_{ij} is the ratio of the signal coming out of the i th port (i.e., the response) to the signal coming into the j th port (i.e., the stimulus).

A port number convention is used where the downstream port is always port 2 and the upstream port is always port 1. The stream direction is determined by the direction of the primary signal launched from the transmitter device to the receiver device (e.g., in this standard, since each differential pair carries a signal in only one direction, the port nearest the transmitter device is port 1 and the port nearest the receiver device is port 2).

There are four combinations of ports for a two-ported system yielding the following S-parameters:

- a) S_{11} (i.e., negative return loss): measured at port 1;
- b) S_{21} (i.e., negative insertion loss): measured at port 1;
- c) S_{22} (i.e., negative upstream return loss): measured at port 2 of the element. The measurement is the same kind of measurement that is done at port 1 to measure S_{11} ; and
- d) S_{12} (i.e., negative upstream insertion loss): measured at port 2 of the element. The measurement is the same kind of measurement that is done at port 1 to measure S_{21} .

● Author: RElliott
Subject: Note
Date: 9/4/2008 5:39:57 PM
 ACCEPT - DONE

Reword B.9.1 to merge in B.9.5 content as:

Properties of physical link elements that are linear may be represented by S-parameter (i.e., scattering parameter) spectra.

S-parameters are the preferred method of capturing the linear properties of physical link elements. A frequency domain spectrum output is used for all S-parameters and specifying pass/fail limits to such a spectrum may overconstrain the system because some peaks and properties are benign to the application.

There are two problematic areas when applying S-parameters to differential electrical physical links:

a) naming conventions (see B.9.2); and

b) use of single-ended vector network methods on differential and common-mode systems (see B.9.3).

B.9.4 describes using special test fixtures to make S-parameter measurements.

● Author: Isi-gpenokie
Subject: Highlight
Date: 9/4/2008 5:39:16 PM
 REJECT (

9/4 moot - major rewording

"this subclause" is B.9.1 - it needs to mean B.9)

This << are described in some detail. >> should be << are described in this subclause. >>

● Author: stx-alvin-cox
Subject: Note
Date: 5/30/2008 5:17:31 PM
 REJECT (Alvin: leave the term)

Should we use the term "return loss" here?

Figure B.12 shows the port naming conventions for physical link elements, loads, and where those elements exit.

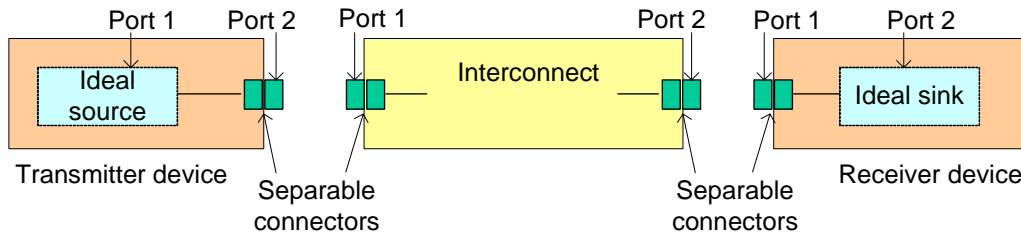

The transmitter device port 1 and receiver device port 2 are internal and are not defined.

Port definitions for loads used for signal output testing and S-parameter measurements in multilane configurations:

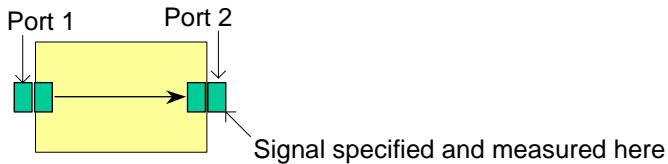

This load has ideal differential and common mode properties

Figure B.12 — S-parameter port naming conventions

B.9.3 Use of single-ended instrumentation in differential applications

There are four categories of S-parameters for a differential system:

- a) S_{DDij} : differential stimulus, differential response;
- b) S_{CDij} : differential stimulus, common-mode response (i.e., mode conversion causing emissions);
- c) S_{DCij} : common-mode stimulus, differential response (i.e., mode conversion causing susceptibility); and
- d) S_{CCij} : common-mode stimulus, common-mode response.

Figure B.13 shows the connections that are made to a four port VNA or TDNA for measuring S-parameters on a four single-ended port black box device.

This page contains no comments

VNA ports are all single-ended; the differential and common-mode properties for differential ports are calculated internal to the VNA or may be mathematically derived. If using a TDNA, consult the details for the specific instrument. Four analyzer ports are required to measure the properties of two differential ports.

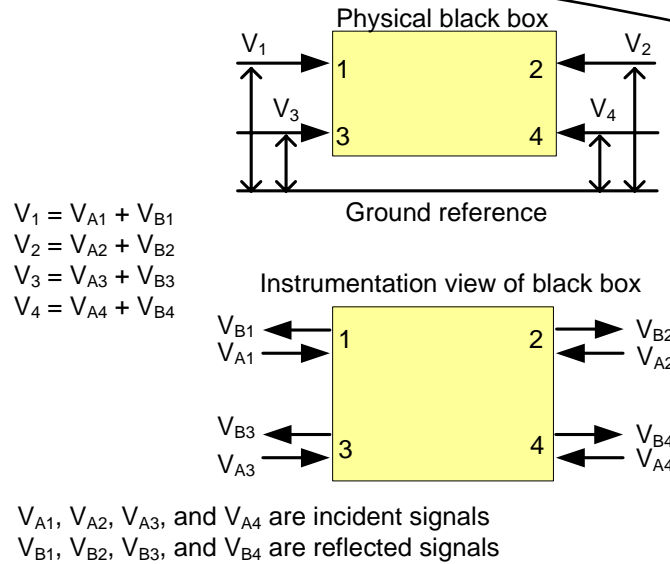

Figure B.13 — Four single-ended port or two differential port element

Figure B.14 shows the set of S-parameters for a single-ended system and for a differential system.

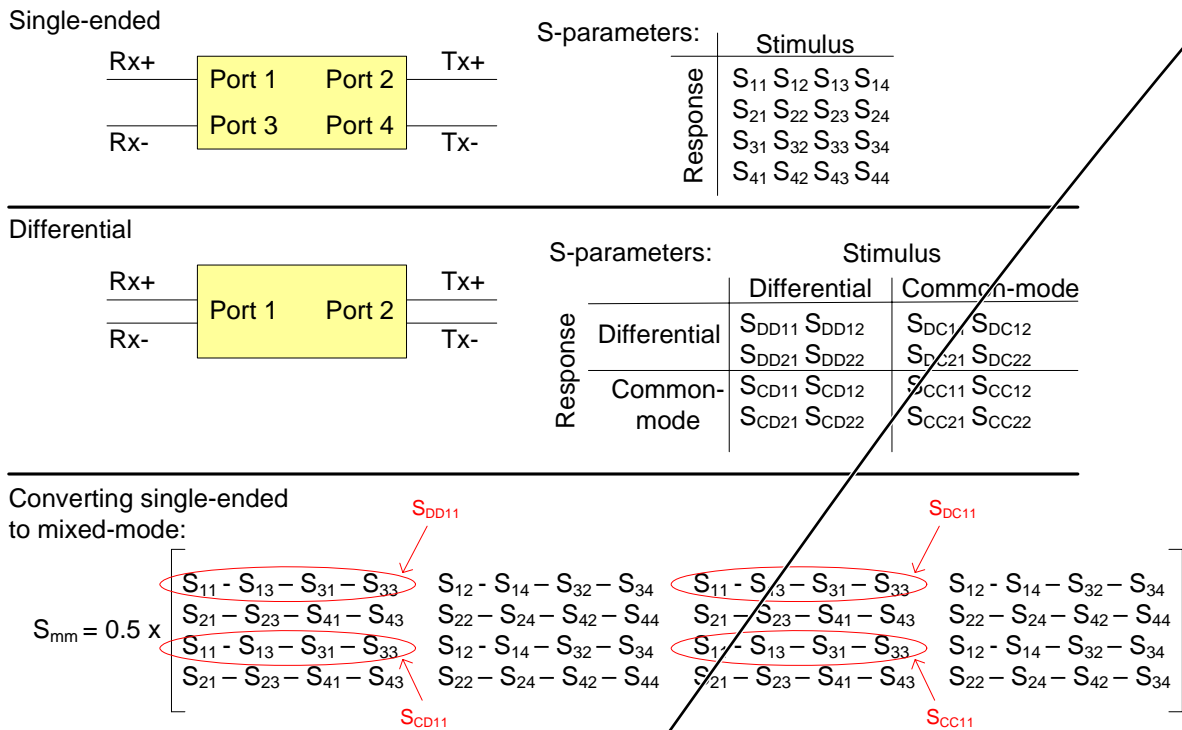

Figure B.14 — S-parameters for single-ended and differential systems

See SFF-8416 for details on connections required for differential S-parameter measurements.

Page: 683

● Author: Isi-gpenokie
Subject: Highlight
Date: 6/9/2008 4:54:19 PM

T ACCEPT - DONE (changed to "Since VNA ports..., the differential...")

This << are all single-ended; the differential and common >> should be << are all single-ended. The differential and common >>

● Author: RElliott
Subject: Highlight
Date: 6/30/2008 6:16:52 PM

T ACCEPT - DONE

may
s/b
are

● Author: RElliott
Subject: Cross-Out
Date: 8/28/2008 3:25:21 PM

T ACCEPT - DONE

connections required for

B.9.4 Measurement configurations for physical link elements

B.9.4.1 Measurement configuration overview

Special test fixtures are required to make S-parameter measurements partly because the connectors used on real physical link elements are different from those used on instrumentation. The goal is for these test fixtures to be as invisible as possible.

All of the measurements in this annex are of S_{11} . A more complete set of S-parameters is used as part of the calibration process for test fixtures.

B.9.4.2 Transmitter device S_{11} measurements

Figure B.15 shows the configuration to be used for the transmitter device S_{11} measurements.

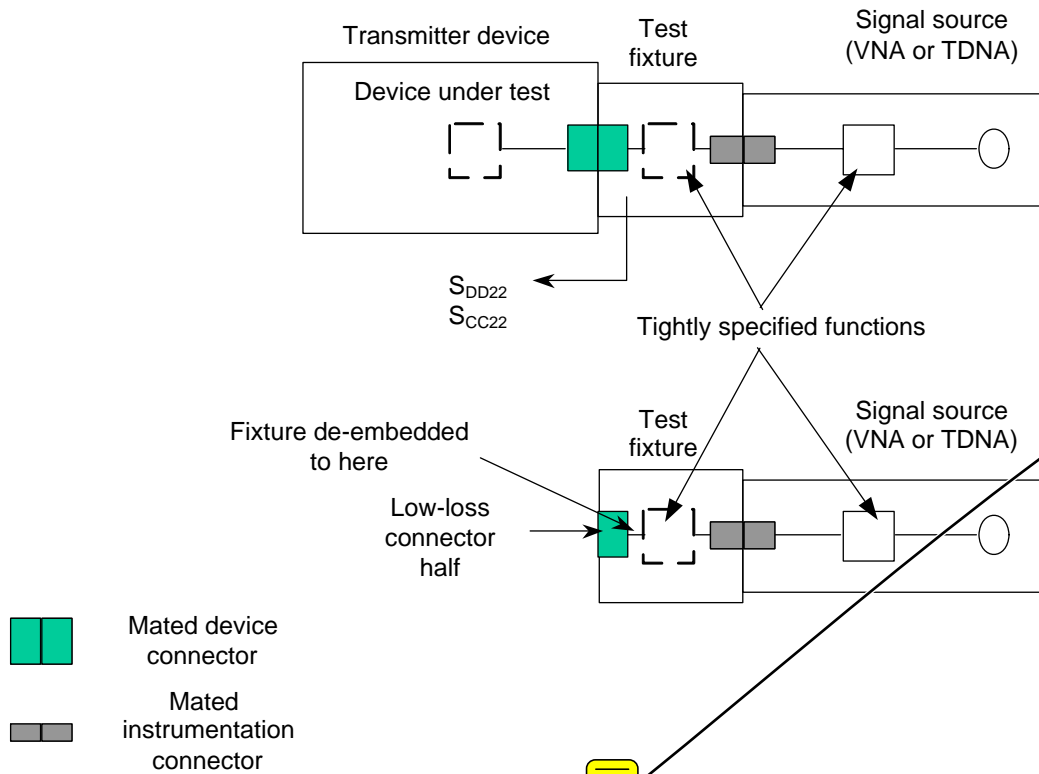

Figure B.15 — Measurement conditions for S_{22} at the transmitter device connector

The test fixture in figure B.15 uses low loss connectors to avoid penalizing the transmitter device under test for the test fixture half of the connector. If the test fixture half of the device connector is poor then the transmitter device has to compensate for those losses.

The test fixture losses up to the mounting points for the device connector are de-embedded using the methods described in figure B.4.

● Author: lsi-gpenokie

Subject: Highlight

Date: 6/6/2008 2:56:58 PM

T REJECT (nothing wrong with "because", and "partly" does change the meaning a bit)

This << measurements partly because the connectors used on real physical link elements are different from those used on instrumentation>> should be << measurements as a result of the connectors used on real physical link elements being different from those used on instrumentation>>

● Author: RElliott

Subject: Highlight

Date: 6/30/2008 6:16:52 PM

T ACCEPT - DONE (Alvin: Accept. Change first sentence to:

All of the measurements in this annex are of S11 or S22.

)

All of the measurements in this annex are of S11.

is untrue; section B.9.4.5 is titled "TxRx connection S22 measurements"

● Author: stx-alvin-cox

Subject: Note

Date: 5/6/2008 4:07:50 PM

T ACCEPT - DONE (this is S11)

S22 or S11? Text and figure need to be consistent.

● Author: RElliott

Subject: Cross-Out

Date: 6/30/2008 6:16:52 PM

T ACCEPT - DONE (Alvin: all this does is restate the first sentence, poorly)

If the test fixture half of the device connector is poor then the transmitter device has to compensate for those losses.

● Author: RElliott

Subject: Highlight

Date: 6/30/2008 6:16:52 PM

T REJECT (moot, sentence deleted)

poor then

s/b

poor, then

● Author: lsi-gpenokie

Subject: Highlight

Date: 6/6/2008 3:05:40 PM

T REJECT (this is really a "must" expressing a statement of fact type requirement. The transmitter device doesn't make any extra effort here or comply with any particular new requirement; however, its output is degraded by the test fixture and if it isn't good enough to overcome that, it may be declared a failure even though it works fine in a real system. However, deleting the whole sentence.)

This << device has to compensate for those >> should be << device should compensate for those >>

B.9.4.3 Receiver device S_{11} measurements

Figure B.16 shows the configuration to be used for the receiver device S_{11} measurements.

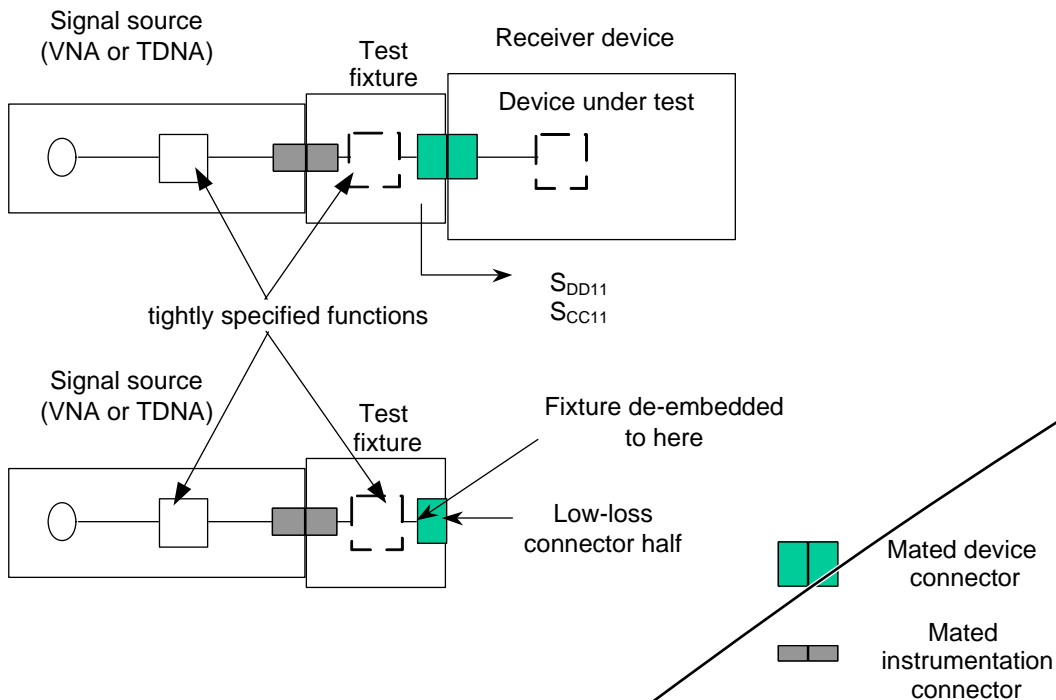

Figure B.16 — Measurement conditions for S_{11} at the receiver device connector

The test fixture in figure B.16 uses low loss connectors to avoid penalizing the receiver device under test for the test fixture half of the connector. ~~If the test fixture half of the device connector is poor then the receiver device has to compensate for those losses.~~

The test fixture losses up to the mounting points for the device connector are de-embedded using the methods described in figure B.4.

B.9.4.4 TxRx connection S_{11} measurements at IT or CT

Figure B.17 shows the conditions for making S_{11} measurements of the interconnect attached to the transmitter device.

This measurement, like the signal tolerance measurement at the transmitter device connector, requires both the interconnect and the receiver device to be in place and the combination is measured. If the receiver device is replaced by an ideal load then S_{11} does not represent in-service conditions. If the interconnect is very lossy then the effects of the load on the far end (i.e., where the receiver device is located) are not significant and an ideal load may be used. However, if the interconnect is not very lossy (e.g., the zero length test load), then the measured S_{11} may be dominated by the properties of the receiver device and not the properties of the interconnect.

Page: 685

Author: RElliott
Subject: Cross-Out
Date: 6/30/2008 6:16:52 PM
TACCEPT - DONE (delete per Alvin)

If the test fixture half of the device connector is poor then the receiver device has to compensate for those losses.

Author: lsi-gpenokie
Subject: Highlight
Date: 5/30/2008 5:25:31 PM
TREJECT (see previous page)

This << device has to compensate for those >> should be << device should compensate for those >>

Author: lsi-gpenokie
Subject: Highlight
Date: 6/6/2008 3:10:57 PM
TACCEPT - DONE ("has both... in place when")

This << connector, requires both the interconnect and the receiver device to be in place and the combination >> should be << connector, assumes both the interconnect and the receiver device are in place and that the combination>>

Author: RElliott
Subject: Highlight
Date: 6/30/2008 6:16:52 PM
TACCEPT - DONE

and
s/b
when

Author: lsi-gpenokie
Subject: Highlight
Date: 5/6/2008 4:07:50 PM
TACCEPT - DONE

This << ideal load then S11 does >> should be << ideal load, then S11 does >> that's a missing comma.

Author: wdc-mevans
Subject: Highlight
Date: 5/6/2008 4:07:50 PM
TACCEPT - DONE

load then
s/b
load, then

Author: lsi-gpenokie
Subject: Highlight
Date: 5/6/2008 4:07:50 PM
TACCEPT - DONE

This << very lossy then the effects >> should be << very lossy, then the effects >>. Missing comma.

Author: wdc-mevans
Subject: Highlight
Date: 5/6/2008 4:07:50 PM
TACCEPT - DONE

lossy then

Comments from page 685 continued on next page

B.9.4.3 Receiver device S_{11} measurements

Figure B.16 shows the configuration to be used for the receiver device S_{11} measurements.

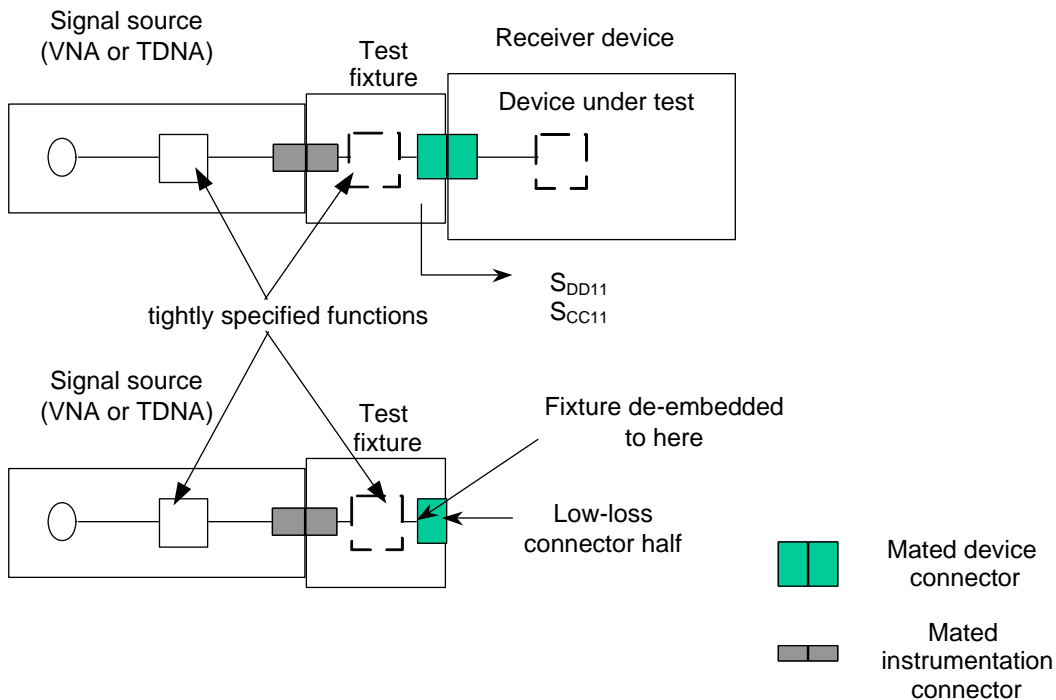

Figure B.16 — Measurement conditions for S_{11} at the receiver device connector

The test fixture in figure B.16 uses low loss connectors to avoid penalizing the receiver device under test for the test fixture half of the connector. ~~If the test fixture half of the device connector is poor then the receiver device has to compensate for those losses.~~

The test fixture losses up to the mounting points for the device connector are de-embedded using the methods described in figure B.4.

B.9.4.4 TxRx connection S_{11} measurements at IT or CT

Figure B.17 shows the conditions for making S_{11} measurements of the interconnect attached to the transmitter device.

This measurement, like the signal tolerance measurement at the transmitter device connector, requires both the interconnect and the receiver device to be in place and the combination is measured. If the receiver device is replaced by an ideal load then S_{11} does not represent in-service conditions. If the interconnect is very lossy then the effects of the load on the far end (i.e., where the receiver device is located) are not significant and an ideal load may be used. However, if the interconnect is not very lossy (e.g., the zero length test load), then the measured S_{11} may be dominated by the properties of the receiver device and not the properties of the interconnect.

s/b
lossy, then

For short physical links, S_{11} performance may be the limiting factor for the entire physical link due to severe unattenuated reflections that create large DJ.

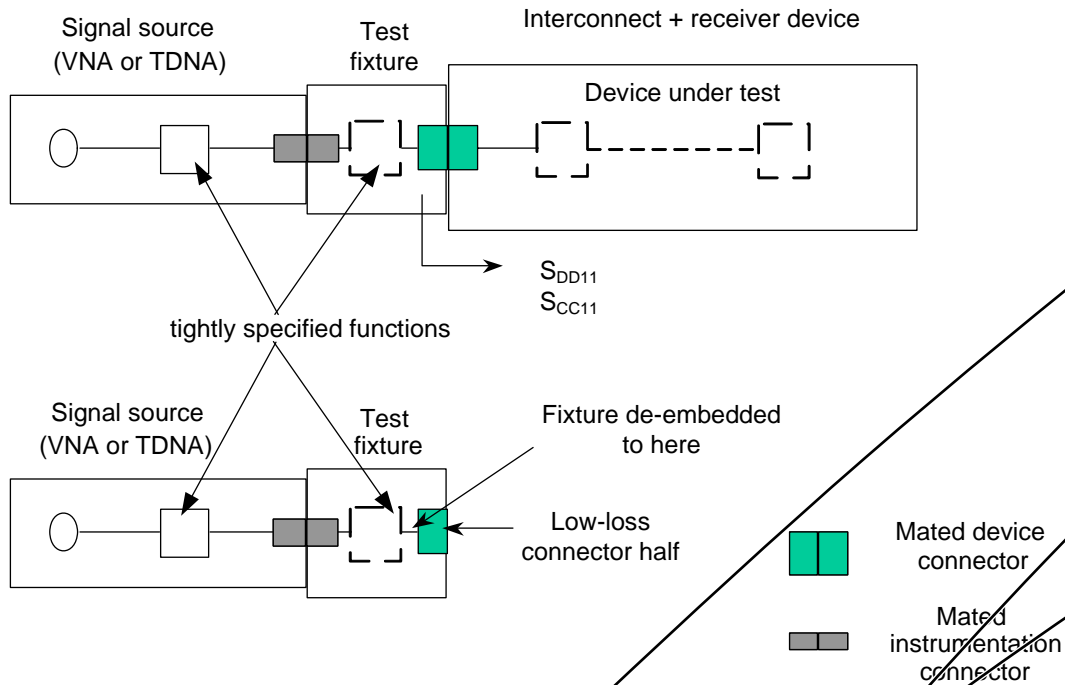

Figure B.17 — Measurement conditions for S_{11} at IT or CR

B.9.4.5 TxRx connection S_{22} measurements at IR or CR

Figure B.18 shows the conditions for making S_{22} measurements of the interconnect attached to the receiver device.

This measurement is unique in that it requires both the interconnect and the transmitter device to be in place as the combination is measured. This may be considered a reverse direction signal tolerance measurement. If the transmitter device is replaced by an ideal load then, S_{22} does not represent in-service conditions. If the interconnect is very lossy then the effects of the load on the far end (i.e., where the transmitter device is located) are not significant and an ideal load may be used. However, if the interconnect is not very lossy (e.g., the zero length test load), then the measured S_{22} may be dominated by the properties of the transmitter device and not the properties of the interconnect.

● Author: RElliott
Subject: Cross-Out
Date: 6/30/2008 6:16:52 PM
T ACCEPT - DONE

is unique in that it

● Author: Isi-gpenokie
Subject: Highlight
Date: 6/6/2008 3:11:39 PM
T ACCEPT - DONE ("has... in place when")

This << that it requires both the interconnect >> should be << that it assumes both the interconnect >>

● Author: wdc-mevans
Subject: Highlight
Date: 5/6/2008 4:07:50 PM
T ACCEPT - DONE

load then
s/b
load, then

● Author: wdc-mevans
Subject: Highlight
Date: 5/6/2008 4:07:50 PM
T ACCEPT - DONE

lossy then
s/b
lossy, then

● Author: Isi-gpenokie
Subject: Highlight
Date: 5/6/2008 4:07:50 PM
T ACCEPT - DONE

This << very lossy then the effects >> should be << very lossy, then the effects >> . Missing comma.

For short physical links, S_{22} may be the limiting factor for the entire physical link due to severe unattenuated reflections that create large DJ.

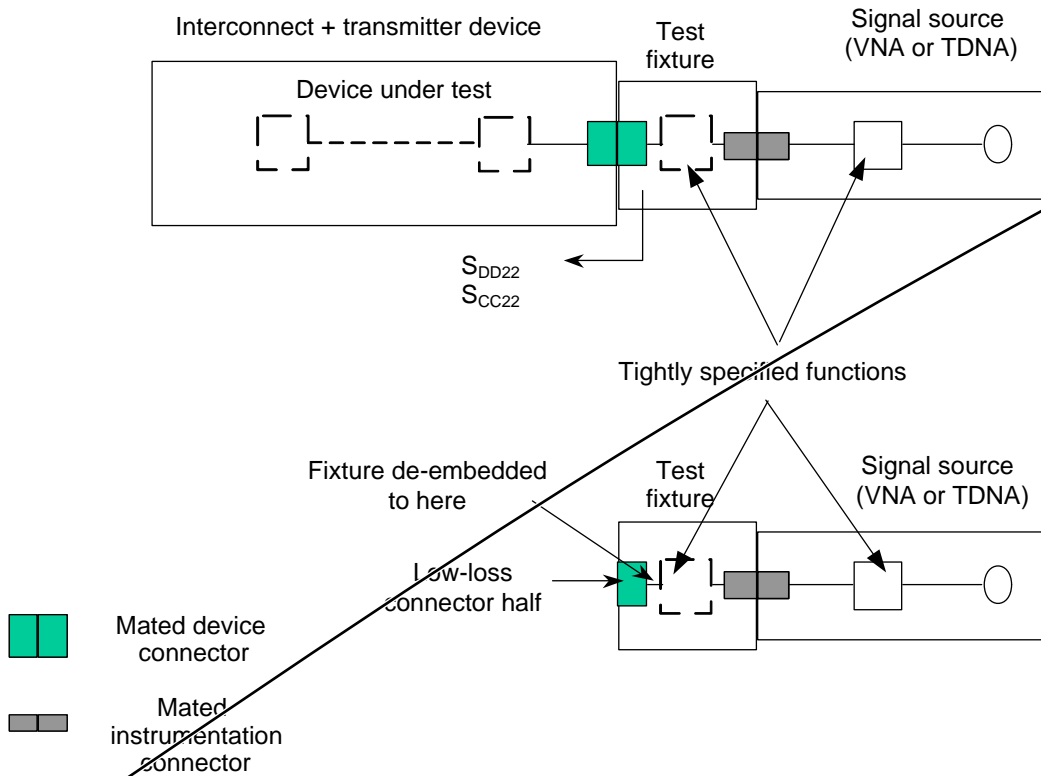

Figure B.18 — Measurement conditions for S_{22} at IR or CR

B.9.5 Summary for S-parameter measurements

S-parameters are the preferred method of capturing the linear properties of physical link elements. **Complex, but tractable, methods are required to use single-ended instruments for differential and common-mode applications. Careful attention to test configuration details is required.**

A frequency domain spectrum **output is required for all S-parameters** and specifying pass/fail limits to such a spectrum may overconstrain **the system because some peaks and properties are benign to the application.**

B.10 Calibration of jitter measurement devices (JMDs)

B.10.1 Calibration of JMDs overview

The response of a jitter measurement device (JMD) to known jitter levels is calibrated and verified in two frequency bands:

- the lower frequency band is at the fundamental of the SSC modulation frequency (i.e., 30 kHz); and
- the ~~second higher~~ frequency band is in the transition region between the reference clock tracking and not tracking the jitter (i.e., approximately ~~2.6~~ MHz).

The reference clock is part of the JMD and may be implemented in hardware or software. By calibrating the JMD to these two bands, the response to jitter is calibrated and allows for improved correlation among JMDs.

The lower frequency band requirement is tested with a D24.3 pattern on which 20.8 ns peak-to-peak sinusoidal phase (time) modulation at 30 kHz \pm 1 % is added. The ratio of the reported jitter to the amount **actually applied (which is measured independently) is the attenuation and shall meet the requirement specified in 5.3.5.2.**

The frequency deviation of the clock in the data source is related to the SSC frequency deviation by the following equation:

Author: RElliott
Subject: Note
Date: 9/4/2008 5:37:49 PM
 ACCEPT - DONE

Move remaining sentences of B.9.5 into B.9.1

Author: RElliott
Subject: Cross-Out
Date: 9/4/2008 5:37:07 PM
 ACCEPT - DONE

Delete:

Complex,
but tractable, methods are required to use single-ended instruments for differential and common-mode applications. Careful attention to test configuration details is required.

which is basically stated already in B.9.1.

Author: Isi-gpenokie
Subject: Highlight
Date: 9/4/2008 5:37:26 PM
 REJECT (
9/14 moot; sentence deleted

7/15 add "However," too.

"Careful attention" is not related to single-ended. That's a general statement for the whole paragraph. Adding "however" with incorrect punctuation tying it to the single-ended sentence would be a mistake. Agree to change the middle sentence to simply " It is possible to use single-ended instruments for differential and common-mode applications. ")

This << Complex, but tractable, methods are required to use single-ended instruments for differential and common-mode applications. Careful attention to test configuration details is required.>> should be << With complex, but tractable, methods it is possible to use single-ended instruments for differential and common-mode applications, however, careful attention to test configuration details is essential.>>

Author: Isi-gpenokie
Subject: Highlight
Date: 6/6/2008 3:14:30 PM
 ACCEPT - DONE (per Alvin)

This << output is required for all S-parameters >> should be << output is used for all S-parameters >>

Author: Isi-gpenokie
Subject: Highlight
Date: 5/30/2008 5:27:53 PM
 REJECT (Alvin: Reject. Leave "because".)

This << the system because some peaks and >> should be << the system as some peaks and >>

Author: hpq-relliott
Subject: Note
Date: 6/9/2008 1:17:04 PM
 ACCEPT - DONE (reworded to avoid shalls)

shalls in informative annex

Author: RElliott
Subject: Cross-Out
Date: 6/30/2008 6:16:52 PM

For short physical links, S_{22} may be the limiting factor for the entire physical link due to severe unattenuated reflections that create large DJ.

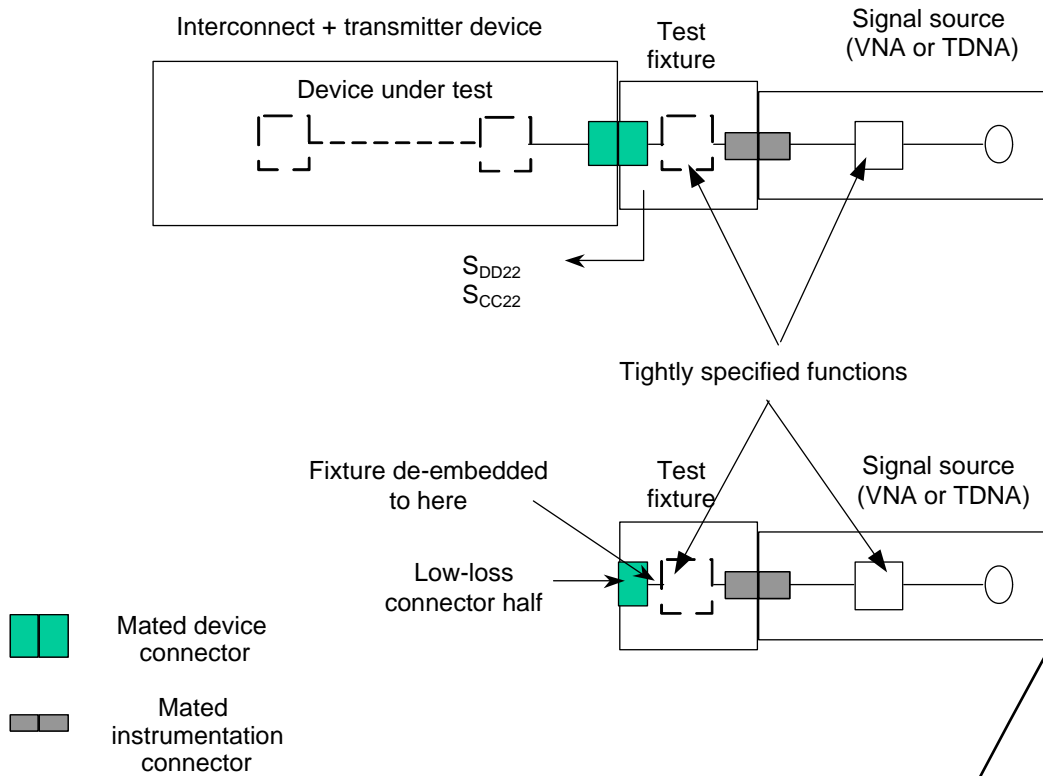

Figure B.18 — Measurement conditions for S_{22} at IR or CR

B.9.5 Summary for S-parameter measurements

S-parameters are the preferred method of capturing the linear properties of physical link elements. **Complex, but tractable, methods are required to use single-ended instruments for differential and common-mode applications. Careful attention to test configuration details is required.**

A frequency domain spectrum **output is required for all S-parameters** and specifying pass/fail limits to such a spectrum may overconstrain **the system because some peaks and** properties are benign to the application.

B.10 Calibration of jitter measurement devices (JMDs)

B.10.1 Calibration of JMDs overview

The response of a jitter measurement device (JMD) to known jitter levels is calibrated and verified in two frequency bands:

- the lower frequency band is at the fundamental of the SSC modulation frequency (i.e., 30 kHz); and
- the ~~second~~ higher frequency band is in the transition region between the reference clock tracking and not tracking the jitter (i.e., approximately 2.6 MHz).

The reference clock is part of the JMD and may be implemented in hardware or software. By calibrating the JMD to these two bands, the response to jitter is calibrated and allows for improved correlation among JMDs.

The lower frequency band requirement is tested with a D24.7 pattern on which 20.8 ns peak-to-peak sinusoidal phase (time) modulation at $30 \text{ kHz} \pm 1\%$ is added. The ratio of the reported jitter to the amount **actually applied (which is measured independently) is the attenuation and shall meet the requirement specified in 5.3.5.2.**

The frequency deviation of the clock in the data source is related to the SSC frequency deviation by the following equation:

TACCEPT - DONE

second

● Author: lsi-gpenokie
Subject: Highlight
Date: 6/9/2008 4:44:52 PM

TREJECT (wdc-mevans wording used instead)

This << actually applied (which is measured independently) is the >> should be << actually applied, measured independently, is the >>

● Author: lsi-gpenokie
Subject: Highlight
Date: 6/9/2008 12:42:48 PM

TACCEPT - DONE (wdc-mevans wording used instead)

This is an informative annex and therefore is not allowed to contains requirements and the statement << and shall meet the requirement specified in 5.3.5.2. >> is a requirement. This has to be deleted or reworded to eliminate any notion that this is a requirement.

● Author: wdc-mevans
Subject: Highlight
Date: 6/9/2008 12:44:04 PM

TACCEPT - DONE

actually applied (which is measured independently) is the attenuation and shall meet the requirement specified in 5.3.5.2.
s/b
of jitter applied is the attenuation, which is specified in 5.3.5.2.

● Author: stx-alvin-cox
Subject: Inserted Text
Date: 6/9/2008 12:42:35 PM

TREJECT (wdc-mevans wording used instead)

should

$$\Delta f = \text{SSC}_{\text{tol}} \times f_{\text{baud}}$$

where:

- Δf is the frequency deviation in Hz
 f_{baud} is the baud rate (e.g., 6 GHz for 6 Gbps)(see 5.3.3.1)
 SSC_{tol} is the SSC frequency deviation (see 5.3.8.1)

The sinusoidal phase modulation is related to frequency modulation by the following equation:

$$\Delta f = f_m \times \Delta\phi$$

where:

- Δf is the frequency deviation in Hz
 f_m is the modulation frequency in Hz
 $\Delta\phi$ is the phase deviation in radians

Assuming a triangular SSC modulation profile, the phase deviation is related to the phase modulation in time by the following equation:

$$\Delta\phi = 2 \times \pi \times f_{\text{baud}} \times \Delta T$$

where:

- $\Delta\phi$ is the phase deviation in radians
 f_{baud} is the baud rate (e.g., 6 GHz for 6 Gbps)
 ΔT is the integral of a triangular, 5 000 ppm, center-spread SSC modulation profile at 30 kHz which is equivalent to a sinusoidal phase (time) modulation with a peak-to-peak amplitude of 20.83 ns, independent of f_{baud}

From these relationships, the SSC frequency deviation from the JTF test parameters is as follows:

$$\text{SSC}_{\text{tol}} = 2 \times \pi \times f_m \times \Delta T$$

Calculated for the test conditions, SSC_{tol} is within the specification limits:

$$\text{SSC}_{\text{tol}} = 2 \times \pi \times (3.0 \times 10^4) \times (20.83 \times 10^{-9}) = 3\,926 \text{ ppm}$$

From these calculations, either frequency or phase modulation may be used. A separate means of verifying the level of the modulation is used to make sure the test conditions are correct. The independent, separate means of verification of the 30 kHz test signal is equivalent to a frequency demodulator or wide range, phase demodulator.

Two tests are performed in the upper frequency band:

- a) the adjustment of the -3 dB bandwidth of the JTF, and
- b) the verification of the peaking (see 5.3.5.2).

~~Both of these tests use a D24.3 pattern with sinusoidal periodic phase modulation or periodic jitter (PJ) that has been independently verified to produce 0.5 UI ± 10% peak-to-peak consistently over a frequency range of 0.5 MHz to 50 MHz. In both tests, a 0 dB reference level is initially determined so all other measurements are relative to this level, not the absolute level of the source. It is important that the PJ source level does not vary in amplitude over this test range, or the variation needs to be extracted in the final calculations.~~

For the tests in the upper frequency band it is necessary to have a phase or jitter modulator. The independent separate means of verification of the 2.6 MHz and 50 MHz test signals is equivalent to a DJ measurement with constant clock.

There are two typical JMD adjustments for clock recovery: loop bandwidth and peaking (i.e., damping). These adjustments may refer to the closed loop response or be specific to a particular design, so they may not be used directly to ensure the JTF response to jitter. The loop bandwidth should be adjusted initially (with the peaking fixed) and if both the low frequency band requirements and the high frequency band requirements are

Author: RElliott
Subject: Underline
Date: 6/30/2008 6:16:52 PM
 ACCEPT - DONE

center-spread
s/b
center-spreading

Author: RElliott
Subject: Note
Date: 6/30/2008 6:16:52 PM
 ACCEPT - DONE

upper
s/b
higher

Author: pmcs-gfortin
Subject: Highlight
Date: 6/9/2008 12:45:26 PM

 REJECT (Alvin: Reject. Although the proportional characteristics indicate the goodness of the measurement device, there are some measurement devices that will provide adequate results without meeting absolute limits on proportionality.)

Section B.10 only mandates the use of a D24.3 pattern to adjust the -3dB bandwidth of the JTF and does not describe how to verify that the JTF -3dB corner varies proportionally to the transition density of the pattern.

It is proposed to replace the highlighted text with:

"Three tests are performed in the upper frequency band:

- a) the adjustment of the -3 dB bandwidth of the JTF; and
- b) the verification of the peaking (see 5.3.5.2); and
- c) the verification of the displacement of the -3 dB bandwidth of the JTF with varying pattern density."

This will bring the JTF calibration procedure in line with the last paragraph of section 5.3.5.2 (page 185) that states:

"A proportional decrease of the JTF -3 dB corner frequency should be observed for a decrease in pattern transition density compared to a 0.5 transition density. If a JMD shifts the JTF -3 dB corner frequency in a manner that does not match this characteristic, or does not shift at all, measurements of jitter with patterns with transition densities different than 0.5 may lead to discrepancies in reported jitter levels. In the case of reported jitter discrepancies between JMDs, the JMD with the shift of the -3 dB corner frequency that is closest to the proportional characteristic of the reference channel shall be considered correct. This characteristic may be measured with the conditions defined above for measuring the -3 dB corner frequency, but substituting other patterns with different transition densities."

Further comments target the same objective of consistency between B.10 and 5.3.5.2.

Author: RElliott
Subject: Note
Date: 6/30/2008 6:16:52 PM
 ACCEPT - DONE

Delete the "the"s in the a)b) list

Author: pmcs-gfortin
Subject: Cross-Out
Date: 6/9/2008 12:45:45 PM
 REJECT (Alvin: Reject due to tests not being changed.)

To account for the addition of a 3rd test.

$$\Delta f = \text{SSC}_{\text{tol}} \times f_{\text{baud}}$$

where:

- Δf is the frequency deviation in Hz
 f_{baud} is the baud rate (e.g., 6 GHz for 6 Gbps)(see 5.3.3.1)
 SSC_{tol} is the SSC frequency deviation (see 5.3.8.1)

The sinusoidal phase modulation is related to frequency modulation by the following equation:

$$\Delta f = f_m \times \Delta\phi$$

where:

- Δf is the frequency deviation in Hz
 f_m is the modulation frequency in Hz
 $\Delta\phi$ is the phase deviation in radians

Assuming a triangular SSC modulation profile, the phase deviation is related to the phase modulation in time by the following equation:

$$\Delta\phi = 2 \times \pi \times f_{\text{baud}} \times \Delta T$$

where:

- $\Delta\phi$ is the phase deviation in radians
 f_{baud} is the baud rate (e.g., 6 GHz for 6 Gbps)
 ΔT is the integral of a triangular, 5 000 ppm, center-spread SSC modulation profile at 30 kHz which is equivalent to a sinusoidal phase (time) modulation with a peak-to-peak amplitude of 20.83 ns, independent of f_{baud}

From these relationships, the SSC frequency deviation from the JTF test parameters is as follows:

$$\text{SSC}_{\text{tol}} = 2 \times \pi \times f_m \times \Delta T$$

Calculated for the test conditions, SSC_{tol} is within the specification limits:

$$\text{SSC}_{\text{tol}} = 2 \times \pi \times (3.0 \times 10^4) \times (20.83 \times 10^{-9}) = 3.926 \text{ ppm}$$

From these calculations, either frequency or phase modulation may be used. A separate means of verifying the level of the modulation is used to make sure the test conditions are correct. The independent, separate means of verification of the 30 kHz test signal is equivalent to a frequency demodulator or wide range, phase demodulator.

Two tests are performed in the upper frequency band:

- the adjustment of the -3 dB bandwidth of the JTF; and
- the verification of the peaking (see 5.3.5.2).

Both of these tests use a D24.3 pattern with sinusoidal periodic phase modulation or periodic jitter (PJ) that has been independently verified to produce $0.3 \text{ UI} \pm 10\%$ peak-to-peak consistently over a frequency range of 0.5 MHz to 50 MHz. In both tests, a 0 dB reference level is initially determined so all other measurements are relative to this level, not the absolute level of the source. It is important that the PJ source level does not vary in amplitude over this test range, or the variation needs to be extracted in the final calculations.

For the tests in the upper frequency band it is necessary to have a phase or jitter modulator. The independent separate means of verification of the 2.6 MHz and 50 MHz test signals is equivalent to a DJ measurement with constant clock.

There are two typical JMD adjustments for clock recovery: loop bandwidth and peaking (i.e., damping). These adjustments may refer to the closed loop response or be specific to a particular design, so they may not be used directly to ensure the JTF response to jitter. The loop bandwidth should be adjusted initially (with the peaking fixed) and if both the low frequency band requirements and the high frequency band requirements are

Author: RElliott
Subject: Highlight
Date: 6/30/2008 6:16:52 PM
T ACCEPT - DONE

upper
s/b
higher

Author: Isi-gpenokie
Subject: Highlight
Date: 6/9/2008 12:53:21 PM
T ACCEPT - DONE (Alvin: Accept)

Make this <<There are two typical JMD adjustments for clock recovery: loop bandwidth and peaking (i.e., damping). >> into an a.b.c list.

Author: RElliott
Subject: Underline
Date: 6/30/2008 6:16:52 PM
T ACCEPT - DONE

should be adjusted initially
s/b
is initially adjusted

Author: RElliott
Subject: Highlight
Date: 6/30/2008 6:16:52 PM
T ACCEPT - DONE

(with the peaking fixed) and if both
s/b
with the peaking fixed. If both

not able to be **simultaneously met, the peaking should** be adjusted to modify the JTF shape in the upper band. In the case of hardware based reference clocks, moderate levels of peaking may be required to achieve the proper attenuation at 30 kHz. The peaking setting is usually specific to the JMD. With software based clock recovery, the suggested starting peaking level may be low, close to the critically damped condition of peaking of 0.707.

The test sequence for all measurements also removes the baseline DJ, DJ of the source, and DJ of the JMD such that what is being measured is the reported jitter only due to the added test jitter and not any baseline residual jitter **in the test system. This is important to insure the accuracy** of the measurement at low reported jitter levels.

B.10.2 JMD Calibration Procedure

This calibration procedure is based on the following **performance requirements:**

- the -3 dB corner frequency of the JTF **shall be** 2.6 MHz \pm 0.5 MHz;
- the magnitude peaking of the JTF **shall be** 3.5 dB maximum; and
- the attenuation at 30 kHz \pm 1 % **shall be** 72 dB to 75 dB.

The JTF **-3dB** corner frequency and the magnitude peaking requirements **shall be measured** with sinusoidal PJ applied, with a peak-to-peak amplitude of 0.3 UI \pm 10 %. The relative attenuation at 30 kHz **shall be measured** with sinusoidal phase **(time)** modulation applied, with a peak-to-peak amplitude of 20.8 ns \pm 10 %.

Resource requirements:

- a pattern generator for SAS signals;
- a sine wave source, 30 kHz, and 0.5 MHz to 50 MHz;
- test cables; and
- a jitter measurement device.

The response to jitter of **the JMD (the reference clock is part of the JMD) is measured** with three different jitter modulation frequencies corresponding to the three cases:

- SSC (full tracking);**
- jitter (no tracking);** and
- the boundary between SSC and jitter.

The jitter source is independently verified by **separate means. This ensures the jitter** response of the JMD is reproducible across different test setups.

The **three** test signals are:

- a 1.5 GHz \pm 0.01 % square wave (i.e., a 6 Gbps D24.3 (i.e., 00110011) pattern) with rise time longer than 0.25 UI 20 % to 80 % and with a sinusoidal phase modulation of 20.8 ns \pm 10 % peak to peak at 30 kHz \pm 1%;
- a 1.5 GHz square wave with a sinusoidal phase modulation of 100 ps \pm 10% peak to peak at 50 MHz \pm 1 %; and
- a 1.5 GHz square wave with no modulation.

An independent, separate means of verification of the test signals is used to make sure the level of the modulation is correct.

The following test procedure **checks two conditions: the JTF attenuation and the JTF bandwidth.**

- adjust the pattern generator for a 6 Gbps D24.3 pattern (00110011b, with a rise time within specified limits) modulation to produce a 30 kHz \pm 1 %, 20.8 ns \pm 10 % peak-to-peak sinusoidal phase modulation;
- verify the level of modulation meets the requirements and record the peak-to-peak level as DJ_SSC. The independent, separate means of verification of the 30 kHz test signal is equivalent to a frequency demodulator or wide range phase demodulator. This may be measured with:
 - a time interval error plot with constant frequency clock on a real time oscilloscope;
 - an equivalent time oscilloscope; or
 - a frequency demodulator;

Page: 689

Author: RElliott
Subject: Underline
Date: 6/30/2008 6:16:52 PM
 ACCEPT - DONE

should be
s/b
is

Author: Isi-gpenokie
Subject: Highlight
Date: 5/6/2008 4:07:50 PM
 ACCEPT - DONE

This << simultaneously met, the peaking should >> should be << simultaneously met, then the peaking should >>

Author: RElliott
Subject: Highlight
Date: 6/30/2008 6:16:52 PM
 ACCEPT - DONE

insure
s/b
ensure

Author: Isi-gpenokie
Subject: Highlight
Date: 6/9/2008 12:54:06 PM
 REJECT (Alvin: Reject. The sentence break aids in the readability.)

This << in the test system. This is important to insure the accuracy >> should be << in the test system to insure the accuracy >>

Author: Isi-gpenokie
Subject: Highlight
Date: 6/9/2008 12:57:18 PM
 REJECT (rewritten)

This << performance requirements: >> should be << performance settings: >>

Author: Isi-gpenokie
Subject: Sticky Note
Date: 6/9/2008 12:56:23 PM
 ACCEPT - DONE (Alvin: rewritten to remove shalls)

There are several << shall >> in this informative annex that have to be removed. There are also several boarder line statements that are very close to stating requirements that should be looked at to make sure no requirement is implied.

Author: Isi-gpenokie
Subject: Highlight
Date: 6/9/2008 1:26:02 PM
 REJECT (rewritten to not mention the number)

This << shall be >> should be << is set to >>

Author: wdc-mevans
Subject: Highlight
Date: 6/9/2008 12:57:06 PM
 REJECT (rewritten to not mention the number)

shall be
s/b
is

not able to be **simultaneously met, the peaking should** be adjusted to modify the JTF shape in the upper band. In the case of hardware based reference clocks, moderate levels of peaking may be required to achieve the proper attenuation at 30 kHz. The peaking setting is usually specific to the JMD. With software based clock recovery, the suggested starting peaking level may be low, close to the critically damped condition of peaking of 0.707.

The test sequence for all measurements also removes the baseline DJ, DJ of the source, and DJ of the JMD such that what is being measured is the reported jitter only due to the added test jitter and not any baseline residual jitter **in the test system. This is important to insure the accuracy** of the measurement at low reported jitter levels.

B.10.2 JMD Calibration Procedure

This calibration procedure is based on the following **performance requirements:**

- a) the -3 dB corner frequency of the JTF **shall be** 2.6 MHz \pm 0.5 MHz;
- b) the magnitude peaking of the JTF **shall be** 3.5 dB maximum; and
- c) the attenuation at 30 kHz \pm 1 % **shall be** 72 dB to 75 dB.

The JTF **-3dB** corner frequency and the magnitude peaking requirements **shall be measured** with sinusoidal PJ applied, with a peak-to-peak amplitude of 0.3 UI \pm 10 %. The relative attenuation at 30 kHz **shall be measured** with sinusoidal phase (time) modulation applied, with a peak-to-peak amplitude of 20.8 ns \pm 10 %.

Resource requirements:

- a) a pattern generator for SAS signals;
- b) a sine wave source, 30 kHz, and 0.5 MHz to 50 MHz;
- c) test cables; and
- d) a jitter measurement device.

The response to jitter of **the JMD (the reference clock is part of the JMD) is measured** with three different jitter modulation frequencies corresponding to the three cases:

- a) **SSC (full tracking);**
- b) **jitter (no tracking);** and
- c) the boundary between SSC and jitter.

The jitter source is independently verified by **separate means. This ensures the jitter** response of the JMD is reproducible across different test setups.

The **three** test signals are:

- a) a 1.5 GHz \pm 0.01 % square wave (i.e., a 6 Gbps D24.3 (i.e., 00110011) pattern) with rise time longer than 0.25 UI 20 % to 80 % and with a sinusoidal phase modulation of 20.8 ns \pm 10 % peak to peak at 30 kHz \pm 1%;
- b) a 1.5 GHz square wave with a sinusoidal phase modulation of 100 ps \pm 10% peak to peak at 50 MHz \pm 1 %; and
- c) a 1.5 GHz square wave with no modulation.

An independent, separate means of verification of the test signals is used to **make sure** the level of the modulation is correct.

The following test procedure **checks two conditions: the JTF attenuation and the JTF bandwidth.**

- 1) adjust the pattern generator for a 6 Gbps D24.3 pattern (00110011b, with a rise time within specified limits) modulation to produce a 30 kHz \pm 1 %, 20.8 ns \pm 10 % peak-to-peak sinusoidal phase modulation;
- 2) verify the level of modulation meets the requirements and record the peak-to-peak level as DJ_SSC. The independent, separate means of verification of the 30 kHz test signal is equivalent to a frequency demodulator or wide range phase demodulator. This may be measured with:
 - A) a time interval error plot with constant frequency clock on a real time oscilloscope;
 - B) an equivalent time oscilloscope; or
 - C) a frequency demodulator;

Author: wdc-mevans
Subject: Highlight
Date: 6/9/2008 12:57:01 PM
 REJECT (rewritten to not mention the number)

shall be
s/b
is

Author: Isi-gpenokie
Subject: Highlight
Date: 6/9/2008 1:26:05 PM
 REJECT (rewritten to not mention the number)

This << shall be >> should be << is set to >>

Author: RElliott
Subject: Note
Date: 6/30/2008 6:16:52 PM
 ACCEPT - DONE

Replace "This calibration ... and all text prior to "Resource requirements:" with the following:

The calibration procedure is based on the JTF characteristics stated in 5.3.5.2 for:

- a) the -3dB corner frequency of the JTF;
- b) the magnitude peaking of the JTF; and
- c) the attenuation at 30kHz.

(from Alvin)

Author: Isi-gpenokie
Subject: Highlight
Date: 6/9/2008 1:26:11 PM
 REJECT (rewritten to not mention the number)

This << shall be >> should be << is set to >>

Author: wdc-mevans
Subject: Highlight
Date: 6/9/2008 12:56:51 PM
 REJECT (rewritten to not mention the number)

shall be
s/b
is

Author: stx-alvin-cox
Subject: Note
Date: 6/9/2008 12:59:52 PM
 REJECT (complete rewrite instead)

Add sentence here: " See 5.3.4.2 for actual specified values. The values given above are for reference purposes only and may not reflect the actual standard requirements.

Author: stx-alvin-cox
Subject: Cross-Out
Date: 6/9/2008 4:52:11 PM
 REJECT (sentence deleted)

Author: Isi-gpenokie
Subject: Highlight
Date: 6/9/2008 12:58:00 PM
 REJECT (sentence deleted)

This << shall be measured >> should be << are measured >>

not able to be **simultaneously met, the peaking should** be adjusted to modify the JTF shape in the upper band. In the case of hardware based reference clocks, moderate levels of peaking may be required to achieve the proper attenuation at 30 kHz. The peaking setting is usually specific to the JMD. With software based clock recovery, the suggested starting peaking level may be low, close to the critically damped condition of peaking of 0.707.

The test sequence for all measurements also removes the baseline DJ, DJ of the source, and DJ of the JMD such that what is being measured is the reported jitter only due to the added test jitter and not any baseline residual jitter **in the test system. This is important to insure the accuracy** of the measurement at low reported jitter levels.

B.10.2 JMD Calibration Procedure

This calibration procedure is based on the following **performance requirements:**

- the -3 dB corner frequency of the JTF **shall be** 2.6 MHz \pm 0.5 MHz;
- the magnitude peaking of the JTF **shall be** 3.5 dB maximum; and
- the attenuation at 30 kHz \pm 1 % **shall be** 72 dB to 75 dB.

The JTF **-3dB** corner frequency and the magnitude peaking requirements **shall be measured** with sinusoidal PJ applied, with a peak-to-peak amplitude of 0.3 UI \pm 10 %. The relative attenuation at 30 kHz **shall be measured** with sinusoidal phase (time) modulation applied, with a peak-to-peak amplitude of 20.8 ns \pm 10 %.

Resource requirements:

- a pattern generator for SAS signals;
- a sine wave source, 30 kHz, and 0.5 MHz to 50 MHz;
- test cables; and
- a jitter measurement device.

The response to jitter of **the JMD (the reference clock is part of the JMD) is measured** with three different jitter modulation frequencies corresponding to the three cases:

- SSC (full tracking);**
- jitter (no tracking);** and
- the boundary between SSC and jitter.

The jitter source is independently verified by **separate means. This ensures the jitter** response of the JMD is reproducible across different test setups.

The **three** test signals are:

- a 1.5 GHz \pm 0.01 % square wave (i.e., a 6 Gbps D24.3 (i.e., 00110011) pattern) with rise time longer than 0.25 UI 20 % to 80 % and with a sinusoidal phase modulation of 20.8 ns \pm 10 % peak to peak at 30 kHz \pm 1%;
- a 1.5 GHz square wave with a sinusoidal phase modulation of 100 ps \pm 10% peak to peak at 50 MHz \pm 1 %; and
- a 1.5 GHz square wave with no modulation.

An independent, separate means of verification of the test signals is used to **make sure** the level of the modulation is correct.

The following test procedure **checks two conditions: the JTF attenuation and the JTF bandwidth.**

- adjust the pattern generator for a 6 Gbps D24.3 pattern (00110011b, with a rise time within specified limits) modulation to produce a 30 kHz \pm 1 %, 20.8 ns \pm 10 % peak-to-peak sinusoidal phase modulation;
- verify the level of modulation meets the requirements and record the peak-to-peak level as DJ_SSC. The independent, separate means of verification of the 30 kHz test signal is equivalent to a frequency demodulator or wide range phase demodulator. This may be measured with:
 - a time interval error plot with constant frequency clock on a real time oscilloscope;
 - an equivalent time oscilloscope; or
 - a frequency demodulator;

Author: wdc-mevans
Subject: Highlight
Date: 6/9/2008 12:58:06 PM
T REJECT (sentence deleted)
shall be
s/b
are

Author: RElliott
Subject: Highlight
Date: 6/30/2008 6:16:52 PM
T REJECT (sentence deleted)
-3dB
add space after 3

Author: stx-alvin-cox
Subject: Inserted Text
Date: 6/9/2008 1:26:26 PM
T^A REJECT (sentence deleted)
should

Author: stx-alvin-cox
Subject: Cross-Out
Date: 6/9/2008 12:58:34 PM
~~**T**~~ REJECT (sentence deleted)

Author: wdc-mevans
Subject: Highlight
Date: 6/9/2008 12:58:25 PM
T REJECT (sentence deleted)
shall be
s/b
is

Author: Isi-gpenokie
Subject: Highlight
Date: 6/9/2008 12:58:19 PM
T REJECT (sentence deleted)
This << shall be measured >> should be << are measured >>

Author: stx-alvin-cox
Subject: Inserted Text
Date: 6/9/2008 12:58:42 PM
T^A REJECT (sentence deleted)
should

Author: wdc-mevans
Subject: Highlight
Date: 6/9/2008 12:58:10 PM
T REJECT (sentence deleted)
(time)
s/b
(i.e., time)

Author: Isi-gpenokie
Subject: Highlight
Date: 6/9/2008 12:59:13 PM

not able to be **simultaneously met, the peaking should** be adjusted to modify the JTF shape in the upper band. In the case of hardware based reference clocks, moderate levels of peaking may be required to achieve the proper attenuation at 30 kHz. The peaking setting is usually specific to the JMD. With software based clock recovery, the suggested starting peaking level may be low, close to the critically damped condition of peaking of 0.707.

The test sequence for all measurements also removes the baseline DJ, DJ of the source, and DJ of the JMD such that what is being measured is the reported jitter only due to the added test jitter and not any baseline residual jitter **in the test system. This is important to insure the accuracy** of the measurement at low reported jitter levels.

B.10.2 JMD Calibration Procedure

This calibration procedure is based on the following **performance requirements:**

- a) the -3 dB corner frequency of the JTF **shall be** 2.6 MHz \pm 0.5 MHz;
- b) the magnitude peaking of the JTF **shall be** 3.5 dB maximum; and
- c) the attenuation at 30 kHz \pm 1 % **shall be** 72 dB to 75 dB.

The JTF **-3dB** corner frequency and the magnitude peaking requirements **shall be measured** with sinusoidal PJ applied, with a peak-to-peak amplitude of 0.3 UI \pm 10 %. The relative attenuation at 30 kHz **shall be measured** with sinusoidal phase (time) modulation applied, with a peak-to-peak amplitude of 20.8 ns \pm 10 %.

Resource requirements:

- a) a pattern generator for SAS signals;
- b) a sine wave source, 30 kHz, and 0.5 MHz to 50 MHz;
- c) test cables; and
- d) a jitter measurement device.

The response to jitter of **the JMD (the reference clock is part of the JMD) is measured** with three different jitter modulation frequencies corresponding to the three cases:

- a) **SSC (full tracking);**
- b) **jitter (no tracking);** and
- c) the boundary between SSC and jitter.

The jitter source is independently verified by **separate means. This ensures the jitter** response of the JMD is reproducible across different test setups.

The **three** test signals are:

- a) a 1.5 GHz \pm 0.01 % square wave (i.e., a 6 Gbps D24.3 (i.e., 00110011) pattern) with rise time longer than 0.25 UI 20 % to 80 % and with a sinusoidal phase modulation of 20.8 ns \pm 10 % peak to peak at 30 kHz \pm 1%;
- b) a 1.5 GHz square wave with a sinusoidal phase modulation of 100 ps \pm 10% peak to peak at 50 MHz \pm 1 %; and
- c) a 1.5 GHz square wave with no modulation.

An independent, separate means of verification of the test signals is used to **make sure** the level of the modulation is correct.

The following test procedure **checks two conditions: the JTF attenuation and the JTF bandwidth.**

- 1) adjust the pattern generator for a 6 Gbps D24.3 pattern (00110011b, with a rise time within specified limits) modulation to produce a 30 kHz \pm 1 %, 20.8 ns \pm 10 % peak-to-peak sinusoidal phase modulation;
- 2) verify the level of modulation meets the requirements and record the peak-to-peak level as DJ_SSC. The independent, separate means of verification of the 30 kHz test signal is equivalent to a frequency demodulator or wide range phase demodulator. This may be measured with:
 - A) a time interval error plot with constant frequency clock on a real time oscilloscope;
 - B) an equivalent time oscilloscope; or
 - C) a frequency demodulator;

T ACCEPT - DONE (as "The JMD calibration equipment is as follows:")

This << Resource requirements: >> should be << Calibration equipment: >>

● Author: RElliott
Subject: Underline
Date: 6/30/2008 6:16:52 PM

T ACCEPT - DONE

jitter measurement device
s/b
JMD

● Author: wdc-mevans
Subject: Highlight
Date: 7/15/2008 5:32:29 PM

T ACCEPT - DONE

(the
s/b
i.e., the

● Author: Isi-gpenokie
Subject: Highlight
Date: 6/9/2008 2:10:03 PM

T REJECT (that is not an in-other-words. Just deleting it instead)

This << the JMD (the reference clock is part of the JMD) is measured >> should be << the JMD (i.e., the reference clock is part of the JMD) is measured >>

● Author: wdc-mevans
Subject: Highlight
Date: 6/9/2008 1:01:18 PM

T ACCEPT - DONE (Alvin: Change to:
(i.e., the JMD fully tracks))

(full tracking);
s/b
with full tracking;

● Author: Isi-gpenokie
Subject: Highlight
Date: 6/9/2008 1:01:24 PM

T ACCEPT - DONE (Alvin: Change to:
(i.e., the JMD fully tracks))

This << SSC (full tracking); >> should be << SSC (i.e., full tracking); >>

● Author: wdc-mevans
Subject: Highlight
Date: 6/9/2008 1:01:36 PM

T ACCEPT - DONE (Alvin: Change to:
(i.e., the JMD does not track))

(no tracking);
s/b
with no tracking;

● Author: Isi-gpenokie
Subject: Highlight
Date: 6/9/2008 1:00:56 PM

T ACCEPT - DONE (Alvin: Change to:
(i.e., the JMD does not track))

This << jitter (no tracking) >> should be << jitter (i.e., no tracking) >>

not able to be **simultaneously met, the peaking should** be adjusted to modify the JTF shape in the upper band. In the case of hardware based reference clocks, moderate levels of peaking may be required to achieve the proper attenuation at 30 kHz. The peaking setting is usually specific to the JMD. With software based clock recovery, the suggested starting peaking level may be low, close to the critically damped condition of peaking of 0.707.

The test sequence for all measurements also removes the baseline DJ, DJ of the source, and DJ of the JMD such that what is being measured is the reported jitter only due to the added test jitter and not any baseline residual jitter **in the test system. This is important to insure the accuracy** of the measurement at low reported jitter levels.

B.10.2 JMD Calibration Procedure

This calibration procedure is based on the following **performance requirements:**

- a) the -3 dB corner frequency of the JTF **shall be** 2.6 MHz \pm 0.5 MHz;
- b) the magnitude peaking of the JTF **shall be** 3.5 dB maximum; and
- c) the attenuation at 30 kHz \pm 1 % **shall be** 72 dB to 75 dB.

The JTF **-3dB** corner frequency and the magnitude peaking requirements **shall be measured** with sinusoidal PJ applied, with a peak-to-peak amplitude of 0.3 UI \pm 10 %. The relative attenuation at 30 kHz **shall be measured** with sinusoidal phase (time) modulation applied, with a peak-to-peak amplitude of 20.8 ns \pm 10 %.

Resource requirements:

- a) a pattern generator for SAS signals;
- b) a sine wave source, 30 kHz, and 0.5 MHz to 50 MHz;
- c) test cables; and
- d) a jitter measurement device.

The response to jitter of **the JMD (the reference clock is part of the JMD) is measured** with three different jitter modulation frequencies corresponding to the three cases:

- a) **SSC (full tracking);**
- b) **jitter (no tracking);** and
- c) the boundary between SSC and jitter.

The jitter source is independently verified by **separate means. This ensures the jitter** response of the JMD is reproducible across different test setups.

The **three** test signals are:

- a) a 1.5 GHz \pm 0.01 % square wave (i.e., a 6 Gbps D24.3 (i.e., 00110011) pattern) with rise time longer than 0.25 UI 20 % to 80 % and with a sinusoidal phase modulation of 20.8 ns \pm 10 % peak to peak at 30 kHz \pm 1%;
- b) a 1.5 GHz square wave with a sinusoidal phase modulation of 100 ps \pm 10% peak to peak at 50 MHz \pm 1 %; and
- c) a 1.5 GHz square wave with no modulation.

An independent, separate means of verification of the test signals is used to **make sure** the level of the modulation is correct.

The following test procedure **checks two conditions: the JTF attenuation and the JTF bandwidth.**

- 1) adjust the pattern generator for a 6 Gbps D24.3 pattern (00110011b, with a rise time within specified limits) modulation to produce a 30 kHz \pm 1 %, 20.8 ns \pm 10 % peak-to-peak sinusoidal phase modulation;
- 2) verify the level of modulation meets the requirements and record the peak-to-peak level as DJ_SSC. The independent, separate means of verification of the 30 kHz test signal is equivalent to a frequency demodulator or wide range phase demodulator. This may be measured with:
 - A) a time interval error plot with constant frequency clock on a real time oscilloscope;
 - B) an equivalent time oscilloscope; or
 - C) a frequency demodulator;

Author: Isi-gpenokie
Subject: Highlight
Date: 6/9/2008 1:02:27 PM
T ACCEPT - DONE (adding "that" too)

This << separate means. This ensures the jitter >> should be << separate means to ensure the jitter >>

Author: RElliott
Subject: Underline
Date: 6/30/2008 6:16:52 PM
T ACCEPT - DONE

Change:

The three test signals are:

- a) a 1.5 GHz \pm 0.01 % square wave (i.e., a 6 Gbps D24.3 (i.e., 00110011) pattern) with rise time longer than 0.25 UI 20 % to 80 % and with a sinusoidal phase modulation of 20.8 ns \pm 10 % peak to peak at 30 kHz \pm 1%;
- b) a 1.5 GHz square wave with a sinusoidal phase modulation of 100 ps \pm 10% peak to peak at 50 MHz \pm 1 %; and
- c) a 1.5 GHz square wave with no modulation.

to:

The JMD calibration pattern is a 1.5 GHz \pm 0.01 % square wave (i.e., a 6 Gbps D24.3 pattern (i.e., repeating 0011b)) with rise time longer than 0.25 UI 20 % to 80 %.

Refer to the amount of modulation in the 1) 6) and 13) that follow, since that's what changes. Keep the square wave +/- and rise time the same for all uses.

Author: pmcs-gfortin
Subject: Highlight
Date: 6/9/2008 1:02:51 PM
T REJECT (Alvin: Reject. Added tests not incorporated.)

"five"

Author: pmcs-gfortin
Subject: Highlight
Date: 6/9/2008 1:03:09 PM
T REJECT (Alvin: Reject. Added tests not incorporated.)

It is proposed to add below this line:

- "d) a 900 MHz square wave with a sinusoidal phase modulation of 100 ps \pm 10% peak to peak at 50 MHz \pm 1 %; and
- e) a 900 MHz square wave with no modulation."

Author: RElliott
Subject: Underline
Date: 6/30/2008 6:16:52 PM
T ACCEPT - DONE

make sure
s/b
ensure that

Author: Isi-gpenokie
Subject: Highlight
Date: 5/6/2008 4:07:50 PM
T ACCEPT - DONE (dropping "condition" entirely)

This << checks two conditions: the JTF attenuation and the JTF bandwidth. >> should be << checks the JTF attenuation condition and the JTF bandwidth condition. >>

Author: RElliott
Subject: Underline
Date: 6/30/2008 6:16:52 PM

Comments from page 689 continued on next page

not able to be **simultaneously met, the peaking should** be adjusted to modify the JTF shape in the upper band. In the case of hardware based reference clocks, moderate levels of peaking may be required to achieve the proper attenuation at 30 kHz. The peaking setting is usually specific to the JMD. With software based clock recovery, the suggested starting peaking level may be low, close to the critically damped condition of peaking of 0.707.

The test sequence for all measurements also removes the baseline DJ, DJ of the source, and DJ of the JMD such that what is being measured is the reported jitter only due to the added test jitter and not any baseline residual jitter **in the test system. This is important to insure the accuracy** of the measurement at low reported jitter levels.

B.10.2 JMD Calibration Procedure

This calibration procedure is based on the following **performance requirements:**

- a) the -3 dB corner frequency of the JTF **shall be** 2.6 MHz \pm 0.5 MHz;
- b) the magnitude peaking of the JTF **shall be** 3.5 dB maximum; and
- c) the attenuation at 30 kHz \pm 1 % **shall be** 72 dB to 75 dB.

The JTF **-3dB** corner frequency and the magnitude peaking requirements **shall be measured** with sinusoidal PJ applied, with a peak-to-peak amplitude of 0.3 UI \pm 10 %. The relative attenuation at 30 kHz **shall be measured** with sinusoidal phase **(time)** modulation applied, with a peak-to-peak amplitude of 20.8 ns \pm 10 %.

Resource requirements:

- a) a pattern generator for SAS signals;
- b) a sine wave source, 30 kHz, and 0.5 MHz to 50 MHz;
- c) test cables; and
- d) a jitter measurement device.

The response to jitter of **the JMD (the reference clock is part of the JMD) is measured** with three different jitter modulation frequencies corresponding to the three cases:

- a) **SSC (full tracking);**
- b) **jitter (no tracking);** and
- c) the boundary between SSC and jitter.

The jitter source is independently verified by **separate means. This ensures the jitter** response of the JMD is reproducible across different test setups.

The **three** test signals are:

- a) a 1.5 GHz \pm 0.01 % square wave (i.e., a 6 Gbps D24.3 (i.e., 00110011) pattern) with rise time longer than 0.25 UI 20 % to 80 % and with a sinusoidal phase modulation of 20.8 ns \pm 10 % peak to peak at 30 kHz \pm 1%;
- b) a 1.5 GHz square wave with a sinusoidal phase modulation of 100 ps \pm 10% peak to peak at 50 MHz \pm 1 %; and
- c) a 1.5 GHz square wave with no modulation.

An independent, separate means of verification of the test signals is used to **make sure** the level of the modulation is correct.

The following test procedure **checks two conditions: the JTF attenuation and the JTF bandwidth.**

- 1) adjust the pattern generator for a 6 Gbps D24.3 pattern (00110011b, with a rise time within specified limits) modulation to produce a 30 kHz \pm 1 %, 20.8 ns \pm 10 % peak-to-peak sinusoidal phase modulation;
- 2) verify the level of modulation meets the requirements and record the peak-to-peak level as DJ_SSC. The independent, separate means of verification of the 30 kHz test signal is equivalent to a frequency demodulator or wide range phase demodulator. This may be measured with:
 - A) a time interval error plot with constant frequency clock on a real time oscilloscope;
 - B) an equivalent time oscilloscope; or
 - C) a frequency demodulator;

T ACCEPT - DONE

Change:

for a 6 Gbps D24.3 pattern (00110011b, with a rise time within specified limits) modulation to produce a $30 \text{ kHz} \pm 1 \%$, $20.8 \text{ ns} \pm 10 \%$ peak-to-peak sinusoidal phase modulation

to:

test pattern a) (referring to the previous list)

- 3) apply the test signal to the JMD. Turn off the sinusoidal phase modulation. Record the reported DJ as DJ_SSCOFF;
- 4) turn on the sinusoidal phase modulation. Record the reported DJ as DJ_SSCON;
- 5) calculate and record the reported DJ as DJ_MSSC by subtracting the DJ with modulation off from DJ with modulation on (i.e., $DJ_MSSC = DJ_SSCON - DJ_SSCOFF$). Calculate the jitter attenuation by $20 \times \log_{10}(DJ_MSSC / DJ_SSC)$. This value shall fall within the range of -72 dB to -75 dB. Adjust the JMD settings to match this requirement;
- 6) adjust the pattern generator for a 6 Gbps D24.3 pattern (00110011) and modulation to produce a 50 MHz $\pm 1\%$, 0.3 $\pm 10\%$ UI peak-to-peak (100 ps) sinusoidal phase modulation (i.e., periodic jitter (PJ));
- 7) verify the level of modulation meets the requirements and record the peak-to-peak level as DJ_M. The independent verification of the 50 MHz test signal is a jitter measurement by separate means from the JMD under calibration. This may be measured with:
 - A) a time interval error plot with constant frequency clock on a real time oscilloscope;
 - B) an equivalent time oscilloscope with histogram and constant frequency clock;
 - C) a bit error rate tester (BERT) using a constant frequency clock; or
 - D) a spectral analysis with the Bessel expansion of angle modulated sidebands;
- 8) apply the test signal to the JMD. Turn off the sinusoidal phase modulation. Record the reported DJ as DJ_MOFF;
- 9) turn on the sinusoidal phase modulation. Record the reported DJ as DJ_MON;
- 10) calculate the difference in reported DJ for these two cases, $DJ_MM = DJ_MON - DJ_MOFF$. Calculate the -3dB value: $DJ_3DB = DJ_MM \times 0.707$;
- 11) adjust the frequency of the PJ source to 2.6 MHz ± 0.1 MHz. Measure the reported DJ difference between PJ on versus PJ off (i.e., $DJ = DJ_ON - DJ_OFF$) and compare DJ to DJ_3DB. Shift the frequency of the PJ source until the reported DJ difference between PJ on versus PJ off is equal to DJ_3DB. The PJ frequency is the -3 dB bandwidth of the JTF; record this value as F_3DB;
- 12) adjust the JMD settings to bring the PJ -3dB corner frequency to 2.6 MHz ± 0.5 MHz. Repeat steps 4) through 12) until both the jitter attenuation and -3 dB frequency are in the acceptable ranges;
- 13) check the peaking of the JTF. Adjust the pattern generator for a 6 Gbps D24.3 pattern and modulation to produce sinusoidal phase modulation (PJ) at the -3 dB BW frequency found above, and 0.3 $\pm 10\%$ UI peak-to-peak (100 ps). Increase the frequency of the modulation to find the maximum reported DJ. It is not necessary to increase beyond 20 MHz. Measure the reported DJ difference between PJ on versus PJ off as $DJ_PK = DJ_PKON - DJ_PKOFF$. Record it as DJ_PK and the frequency as F_3PK; and
- 14) calculate the JTF Peaking value: $20 \times \log_{10}(DJ_PK / DJ_MM)$. Record this value.

Page: 690

● Author: stx-alvin-cox
Subject: Cross-Out
Date: 6/9/2008 4:43:25 PM
T REJECT (reworded instead)

● Author: wdc-mevans
Subject: Highlight
Date: 6/9/2008 4:43:46 PM
T ACCEPT - DONE (but pointing to 5.3.5.2, rather than giving the range of -72 to -75 dB)

This value shall fall within the range of -72 dB to -75 dB. Adjust the JMD settings to match this requirement;
s/b
Adjust JMD value settings to fall within the range of -72 dB to -75 dB.

● Author: stx-alvin-cox
Subject: Inserted Text
Date: 6/9/2008 4:43:16 PM
T REJECT (reworded instead)
should

● Author: RElliott
Subject: Underline
Date: 6/30/2008 6:16:52 PM
T ACCEPT - DONE

Change:
for a 6 Gbps D24.3 pattern (00110011) and modulation to produce a 50 MHz $\pm 1\%$, 0.3 $\pm 10\%$ UI peak-to-peak (100 ps) sinusoidal phase modulation (i.e., periodic jitter (PJ))

to:
test pattern b) (referencing the previous list)

● Author: wdc-mevans
Subject: Highlight
Date: 6/9/2008 1:33:04 PM
T REJECT (deleted instead)

(00110011)
s/b
(i.e., 00110011)

● Author: wdc-mevans
Subject: Highlight
Date: 6/9/2008 1:33:14 PM
T REJECT (deleted instead)

(100 ps)
s/b
(i.e., 100 ps)

● Author: wdc-mevans
Subject: Highlight
Date: 6/9/2008 1:08:19 PM
T REJECT (this is an acronym)

(BERT)
s/b
(i.e., BERT)

Comments from page 690 continued on next page

- 3) apply the test signal to the JMD. Turn off the sinusoidal phase modulation. Record the reported DJ as DJ_SSCOFF;
- 4) turn on the sinusoidal phase modulation. Record the reported DJ as DJ_SSCON;
- 5) calculate and record the reported DJ as DJ_MSSC by subtracting the DJ with modulation off from DJ with modulation on (i.e., $DJ_MSSC = DJ_SSCON - DJ_SSCOFF$). Calculate the jitter attenuation by $20 \times \log_{10}(DJ_MSSC / DJ_SSC)$. This value shall fall within the range of -72 dB to -75 dB. Adjust the JMD settings to match this requirement;
- 6) adjust the pattern generator for a 6 Gbps D24.3 pattern (00110011) and modulation to produce a 50 MHz $\pm 1\%$, 0.3 $\pm 10\%$ UI peak-to-peak (100 ps) sinusoidal phase modulation (i.e., periodic jitter (PJ));
- 7) verify the level of modulation meets the requirements and record the peak-to-peak level as DJ_M. The independent verification of the 50 MHz test signal is a jitter measurement by separate means from the JMD under calibration. This may be measured with:
 - A) a time interval error plot with constant frequency clock on a real time oscilloscope;
 - B) an equivalent time oscilloscope with histogram and constant frequency clock;
 - C) a bit error rate tester (BERT) using a constant frequency clock; or
 - D) a spectral analysis with the Bessel expansion of angle modulated sidebands;
- 8) apply the test signal to the JMD. Turn off the sinusoidal phase modulation. Record the reported DJ as DJ_MOFF;
- 9) turn on the sinusoidal phase modulation. Record the reported DJ as DJ_MON;
- 10) calculate the difference in reported DJ for these two cases, $DJ_MM = DJ_MON - DJ_MOFF$. Calculate the -3dB value: $DJ_3DB = DJ_MM \times 0.707$;
- 11) adjust the frequency of the PJ source to 2.6 MHz ± 0.1 MHz. Measure the reported DJ difference between PJ on versus PJ off (i.e., $DJ = DJ_ON - DJ_OFF$) and compare DJ to DJ_3DB. Shift the frequency of the PJ source until the reported DJ difference between PJ on versus PJ off is equal to DJ_3DB. The PJ frequency is the -3 dB bandwidth of the JTF; record this value as F_3DB;
- 12) adjust the JMD settings to bring the PJ -3dB corner frequency to 2.6 MHz ± 0.5 MHz. Repeat steps 4) through 12) until both the jitter attenuation and -3 dB frequency are in the acceptable ranges;
- 13) check the peaking of the JTF. Adjust the pattern generator for a 6 Gbps D24.3 pattern and modulation to produce sinusoidal phase modulation (PJ) at the -3 dB BW frequency found above, and 0.3 $\pm 10\%$ UI peak-to-peak (100 ps). Increase the frequency of the modulation to find the maximum reported DJ. It is not necessary to increase beyond 20 MHz. Measure the reported DJ difference between PJ on versus PJ off as $DJ_PK = DJ_PKON - DJ_PKOFF$. Record it as DJ_PK and the frequency as F_3PK; and
- 14) calculate the JTF Peaking value: $20 \times \log_{10}(DJ_PK / DJ_MM)$. Record this value.

Author: lsi-gpenokie

Subject: Highlight

Date: 6/9/2008 1:09:41 PM

 ACCEPT - DONE (Alvin: Accept.

Change "calculate the difference in reported DJ for these two cases, $DJ_{MM} = DJ_{MON} - DJ_{MOFF}$. Calculate the -3dB value: $DJ_{3DB} = DJ_{MM} \times 0.707$;"

to

calculate the following:

a) the difference in reported DJ (i.e., $DJ_{MM} = DJ_{MON} - DJ_{MOFF}$); and

b) the -3dB value (i.e., $DJ_{3DB} = DJ_{MM} \times 0.707$);

)

Make this << for these two cases, $DJ_{MM} = DJ_{MON} - DJ_{MOFF}$. Calculate the -3dB value: $DJ_{3DB} = DJ_{MM} \times 0.707$; >> into an a,b,c list.

Author: RElliott

Subject: Note

Date: 6/30/2008 6:16:52 PM

 ACCEPT - DONE

add space to -3dB

Author: RElliott

Subject: Underline

Date: 6/30/2008 6:16:52 PM

 ACCEPT - DONE

versus

s/b

and

Author: pmcs-gfortin

Subject: Highlight

Date: 6/9/2008 1:10:14 PM

 ACCEPT - DONE

DJ_3DB

Author: RElliott

Subject: Highlight

Date: 6/30/2008 6:16:52 PM

 ACCEPT - DONE

-3dB

add space

Author: RElliott

Subject: Underline

Date: 6/30/2008 6:16:52 PM

 ACCEPT - DONE

the -3 dB BW frequency found above,

s/b

at F_3DB

Author: wdc-mevans

Subject: Highlight

Date: 6/9/2008 2:16:03 PM

 REJECT (deleting instead)

Comments from page 690 continued on next page

- 3) apply the test signal to the JMD. Turn off the sinusoidal phase modulation. Record the reported DJ as DJ_SSCOFF;
- 4) turn on the sinusoidal phase modulation. Record the reported DJ as DJ_SSCON;
- 5) calculate and record the reported DJ as DJ_MSSC by subtracting the DJ with modulation off from DJ with modulation on (i.e., $DJ_MSSC = DJ_SSCON - DJ_SSCOFF$). Calculate the jitter attenuation by $20 \times \log_{10}(DJ_MSSC / DJ_SSC)$. This value shall fall within the range of -72 dB to -75 dB. Adjust the JMD settings to match this requirement;
- 6) adjust the pattern generator for a 6 Gbps D24.3 pattern (00110011) and modulation to produce a 50 MHz $\pm 1\%$, 0.3 $\pm 10\%$ UI peak-to-peak (100 ps) sinusoidal phase modulation (i.e., periodic jitter (PJ));
- 7) verify the level of modulation meets the requirements and record the peak-to-peak level as DJ_M. The independent verification of the 50 MHz test signal is a jitter measurement by separate means from the JMD under calibration. This may be measured with:
 - A) a time interval error plot with constant frequency clock on a real time oscilloscope;
 - B) an equivalent time oscilloscope with histogram and constant frequency clock;
 - C) a bit error rate tester (BERT) using a constant frequency clock; or
 - D) a spectral analysis with the Bessel expansion of angle modulated sidebands;
- 8) apply the test signal to the JMD. Turn off the sinusoidal phase modulation. Record the reported DJ as DJ_MOFF;
- 9) turn on the sinusoidal phase modulation. Record the reported DJ as DJ_MON;
- 10) calculate the difference in reported DJ for these two cases, $DJ_MM = DJ_MON - DJ_MOFF$. Calculate the -3dB value: $DJ_3DB = DJ_MM \times 0.707$;
- 11) adjust the frequency of the PJ source to 2.6 MHz ± 0.1 MHz. Measure the reported DJ difference between PJ on versus PJ off (i.e., $DJ = DJ_ON - DJ_OFF$) and compare DJ to DJ_3DB. Shift the frequency of the PJ source until the reported DJ difference between PJ on versus PJ off is equal to DJ_3DB. The PJ frequency is the -3 dB bandwidth of the JTF; record this value as F_3DB;
- 12) adjust the JMD settings to bring the PJ -3dB corner frequency to 2.6 MHz ± 0.5 MHz. Repeat steps 4) through 12) until both the jitter attenuation and -3 dB frequency are in the acceptable ranges;
- 13) check the peaking of the JTF. Adjust the pattern generator for a 6 Gbps D24.3 pattern and modulation to produce sinusoidal phase modulation (PJ) at the -3 dB BW frequency found above, and 0.3 $\pm 10\%$ UI peak-to-peak (100 ps). Increase the frequency of the modulation to find the maximum reported DJ. It is not necessary to increase beyond 20 MHz. Measure the reported DJ difference between PJ on versus PJ off as $DJ_PK = DJ_PKON - DJ_PKOFF$. Record it as DJ_PK and the frequency as F_3PK; and
- 14) calculate the JTF Peaking value: $20 \times \log_{10}(DJ_PK / DJ_MM)$. Record this value.

(PJ)
s/b
(i.e., PJ)

● Author: wdc-mevans
Subject: Highlight
Date: 6/9/2008 1:10:39 PM
T ACCEPT - DONE

(100 ps).
s/b
(i.e., 100 ps).

● Author: pmcs-gfortin
Subject: Highlight
Date: 6/9/2008 1:12:12 PM
T REJECT (Alvin: Reject. Tests to verify proportionality are not planned to be added.)

It is proposed to add below this line:

"15) adjust the pattern generator for a 6 Gbps D30.3 pattern (001111000111000011100) and modulation to produce a 50 MHz $\pm 1\%$, 0.3 $\pm 10\%$ UI peak-to-peak (100 ps) sinusoidal phase modulation (i.e., periodic jitter (PJ));

16) verify the level of modulation meets the requirements and record the peak-to-peak level as DJ_M_LOWTD.

The independent verification of the 50 MHz test signal is a jitter measurement by separate means from the JMD under calibration. This may be measured with:

A) a time interval error plot with constant frequency clock on a real time oscilloscope;

B) an equivalent time oscilloscope with histogram and constant frequency clock;

C) a bit error rate tester (BERT) using a constant frequency clock; or

D) a spectral analysis with the Bessel expansion of angle modulated sidebands;

17) apply the test signal to the JMD. Turn off the sinusoidal phase modulation. Record the reported DJ as DJ_MOFF_LOWTD;

18) turn on the sinusoidal phase modulation. Record the reported DJ as DJ_MON_LOWTD;

19) calculate the difference in reported DJ for these two cases, DJ_MM_LOWTD = DJ_MON_LOWTD - DJ_MOFF_LOWTD.

Calculate

the -3dB value: DJ_3DB_LOWTD = DJ_MM_LOWTD \times 0.707;

20) adjust the frequency of the PJ source to 1.6 MHz \pm 0.1 MHz. Measure the reported DJ difference between PJ on versus PJ off (i.e., DJ_LOWTD = DJ_ON_LOWTD - DJ_OFF_LOWTD) and compare DJ to DJ_3DB_LOWTD. Shift the

frequency of the PJ source until the reported DJ difference between PJ on versus PJ off is equal to

DJ_3DB_LOWTD. The PJ frequency is the -3 dB bandwidth of the JTF; record this value as F_3DB_LOWTD; F_3DB_LOWTD should be 1.6 MHz \pm 0.3 MHz."

Annex C
(informative)

SAS to SAS phy reset sequence examples

Figure C.1 shows a speed negotiation between a phy A that supports only SNW-1 attached to a phy B that only supports SNW-1. Both phys run:

- 1) SNW-1, supported by both phys; and
- 2) SNW-2, supported by neither phy.

Both phys then select 1.5 Gbps for Final-SNW, which is used to establish the negotiated physical link rate.

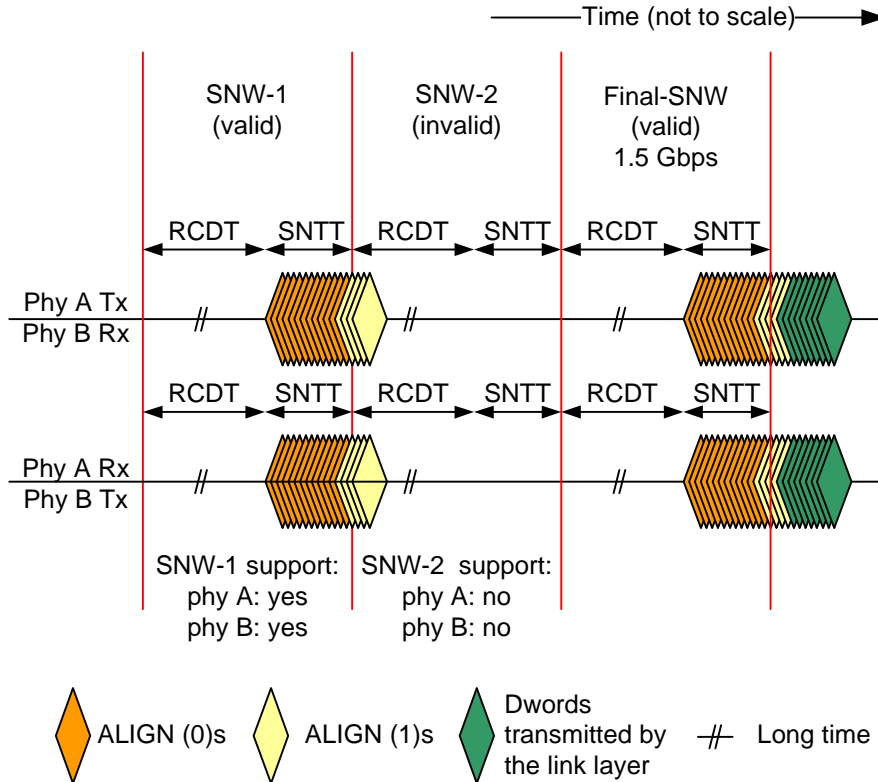

Figure C.1 — SAS speed negotiation sequence (phy A: SNW-1 only, phy B: SNW-1 only)

Figure C.2 shows a speed negotiation between a phy A that supports SNW-1 and SNW-2 attached to a phy B that supports SNW-1 and SNW-2. Both phys run:

- 1) SNW-1, supported by both phys;
- 2) SNW-2, supported by both phys; and
- 3) SNW-3, supported by neither phy.

This page contains no comments

Both phys then select 3 Gbps for Final-SNW, which is used to establish the negotiated physical link rate.

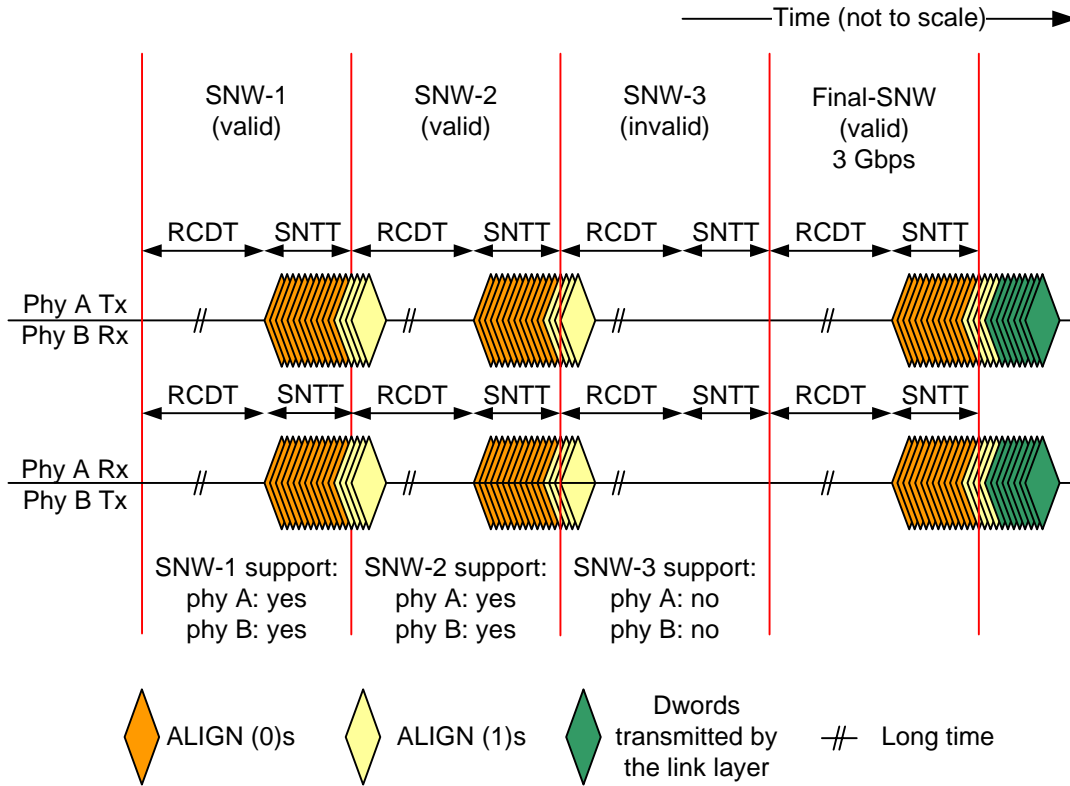

Figure C.2 — SAS speed negotiation sequence (phy A: SNW-1, SNW-2, phy B: SNW-1, SNW-2)

Figure C.3 shows a speed negotiation between a phy A that supports SNW-1 through SNW-3 attached to a phy B that only supports SNW-1 and SNW-2. Both phys run:

- 1) SNW-1, supported by both phys;
- 2) SNW-2, supported by both phys; and
- 3) SNW-3, supported by phy A but not by phy B.

This page contains no comments

Both phys then select 3 Gbps for Final-SNW, which is used to establish the negotiated physical link rate.

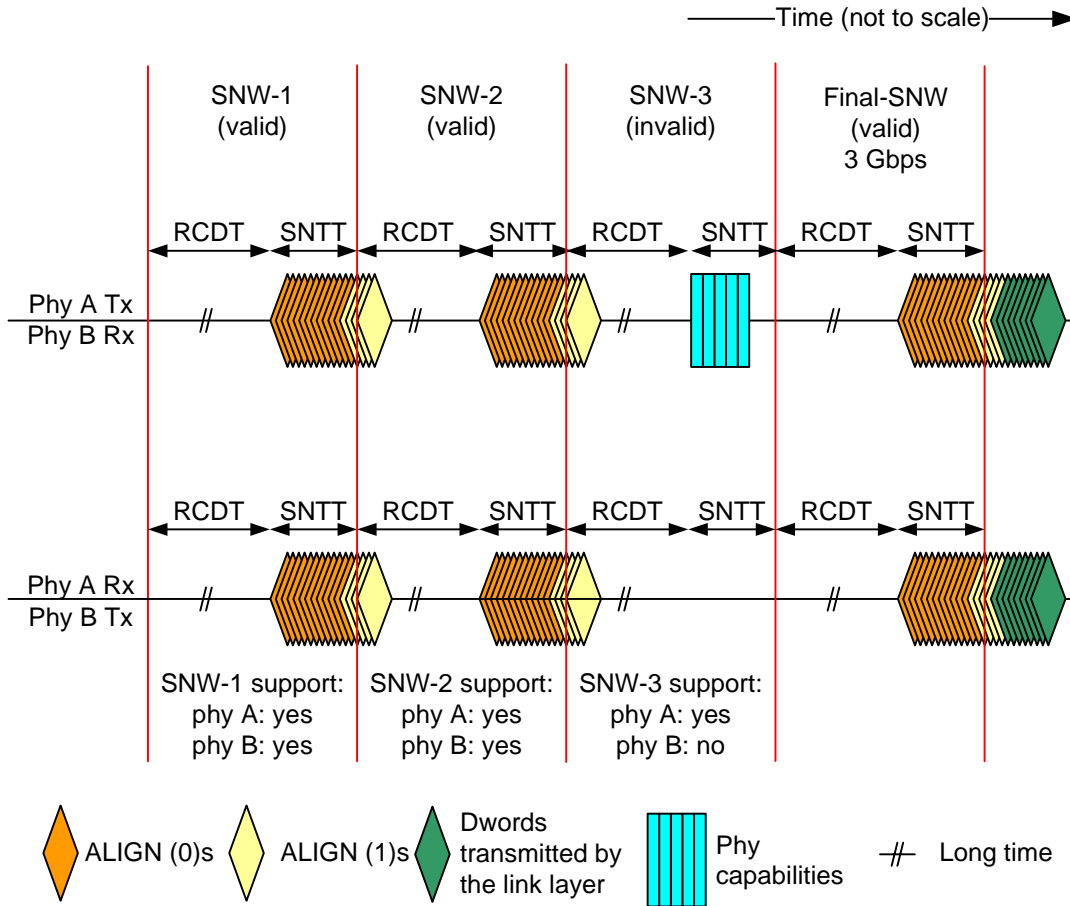

Figure C.3 — SAS speed negotiation sequence (phy A: SNW-1, SNW-2, SNW-3, phy B: SNW-1, SNW-2)

Figure C.4 shows a speed negotiation between a phy A that supports SNW-2 and SNW-3 attached to a phy B that only supports SNW-1 and SNW-2. Both phys run:

- 1) SNW-1, supported by phy B but not by phy A;
- 2) SNW-2, supported by both phys; and
- 3) SNW-3, supported by phy A but not by phy B.

This page contains no comments

Both phys then select 3 Gbps for Final-SNW, which is used to establish the negotiated physical link rate.

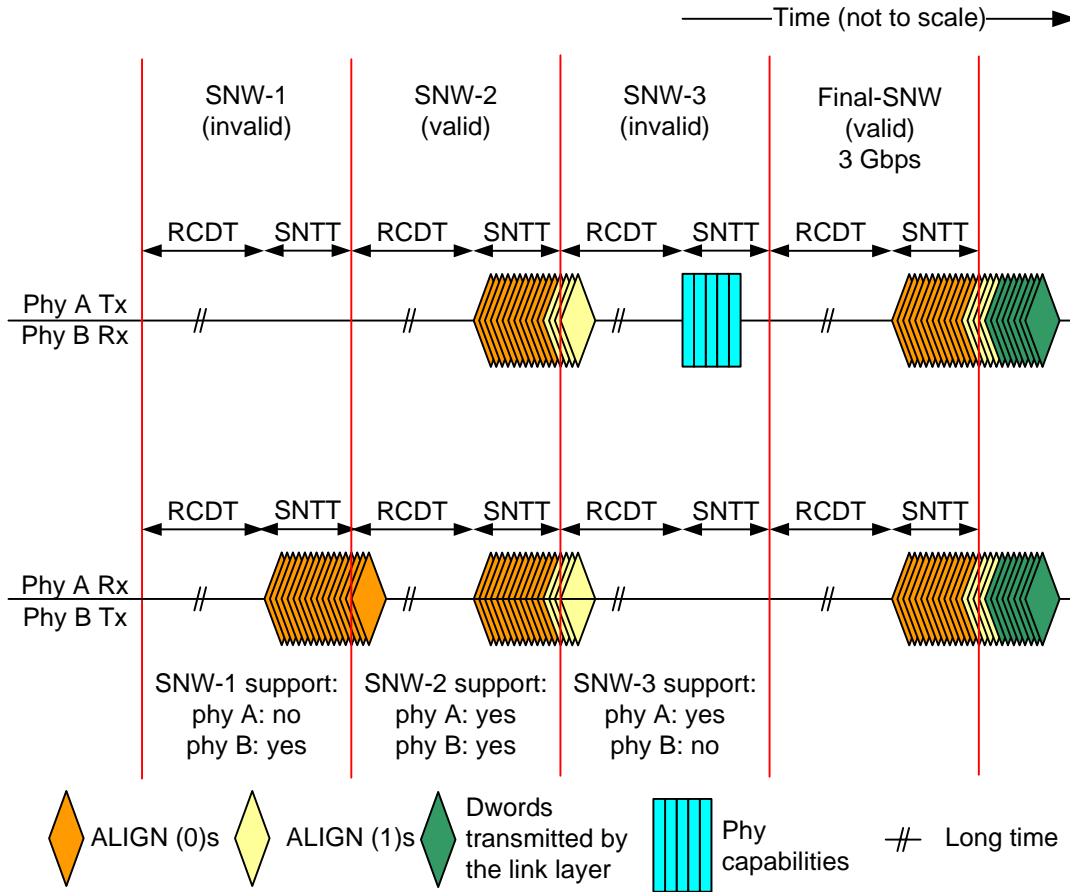

Figure C.4 — SAS speed negotiation sequence (phy A: SNW-2, SNW-3, phy B: SNW-1, SNW-2)

Figure C.5 shows a speed negotiation between a phy A that only supports SNW-1 attached to a phy B that only supports SNW-2. Both phys run:

- 1) SNW-1, supported by phy A but not by phy B; and
- 2) SNW-2, supported by phy B but not by phy A.

Phy B continues to run SNW-3, but phy A determines speed negotiation is unsuccessful and may attempt another phy reset sequence after a hot-plug timeout.

This page contains no comments

Phy B determines speed negotiation is not succeeding after SNW-3 and may retry the phy reset sequence after a hot-plug timeout.

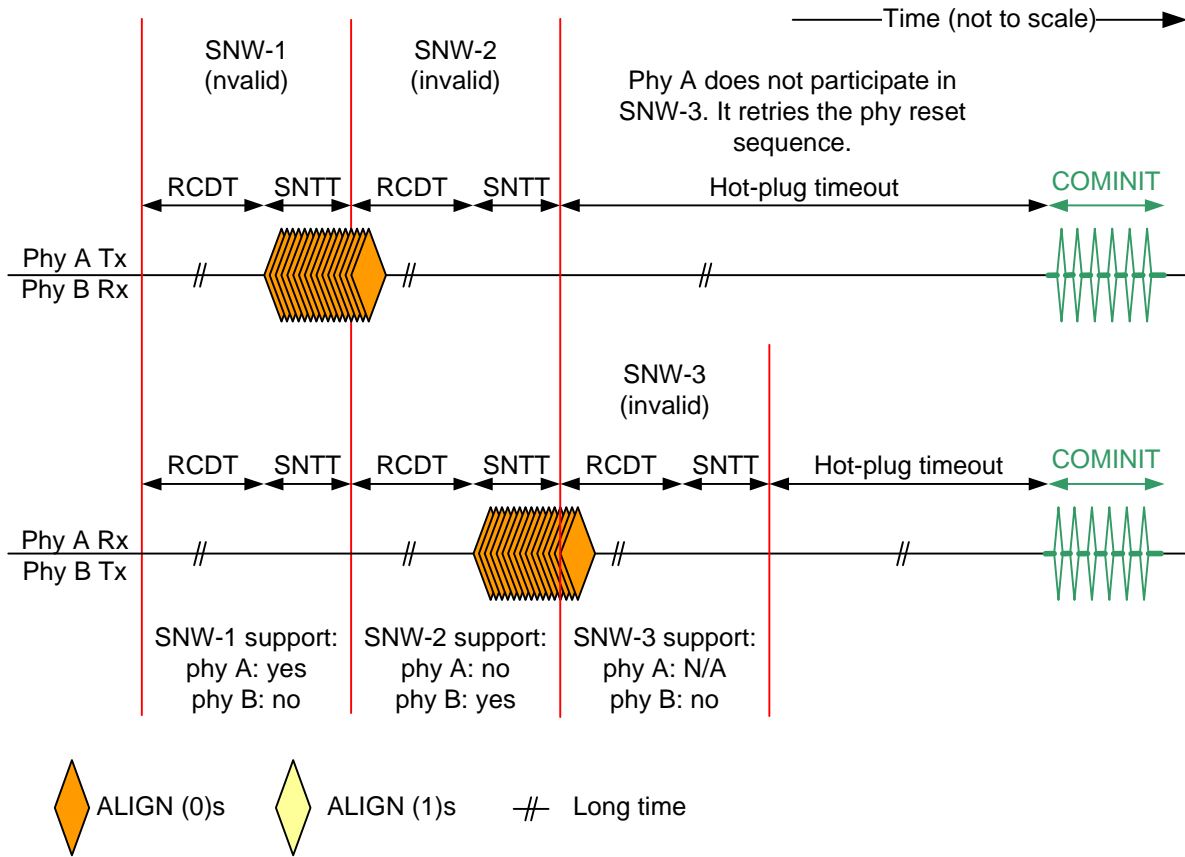

Figure C.5 — SAS speed negotiation sequence (phy A: SNW-1 only, phy B: SNW-2 only)

This page contains no comments

Annex D (informative)

CRC

D.1 CRC generator and checker implementation examples

Figure D.1 shows an example of a CRC generator.

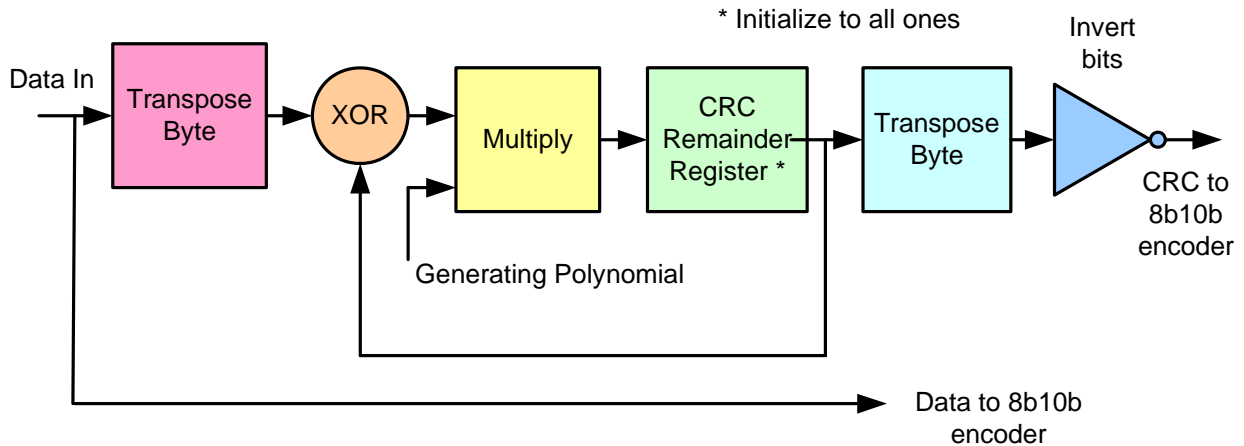

Figure D.1 — CRC generator example

Figure D.2 shows an example of a CRC checker.

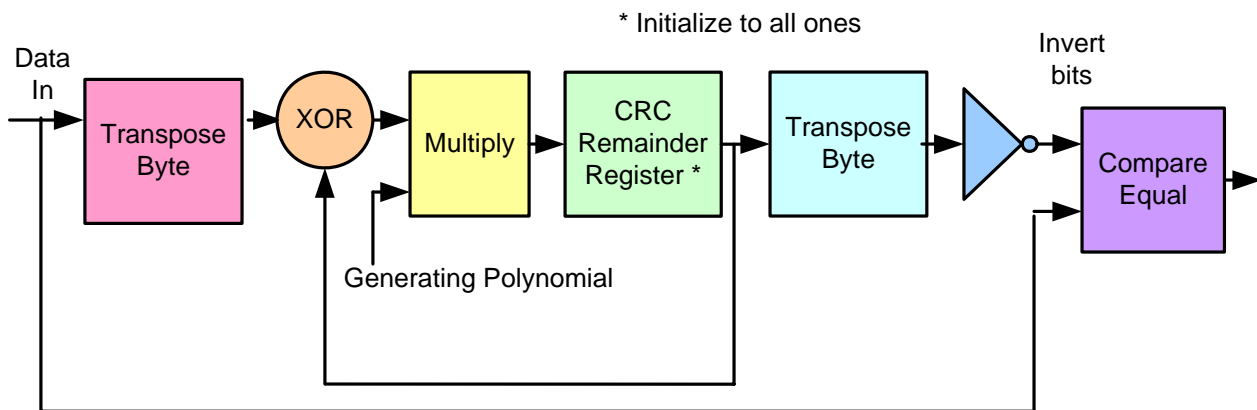

Figure D.2 — CRC checker example

D.2 CRC implementation in C

The following is an example C program that generates the value for the CRC field in frames. The inputs are the data dwords for the frame and the number of data dwords.

```
#include <stdio.h>

void main (void) {

    static unsigned long data_dwords[] = {
        0x06D0B992L, 0x00B5DF59L, 0x00000000L,
        0x00000000L, 0x1234FFFFL, 0x00000000L,
        0x00000000L, 0x00000000L, 0x00000000L,
        0x08000012L, 0x01000000L, 0x00000000L,
```

This page contains no comments

```

        0x00000000L}; /* example data dwords */

unsigned long calculate_crc(unsigned long *, unsigned long);
unsigned long crc;

crc = calculate_crc(data_dwords, 13);
printf ("Example CRC is %x\n", crc);
}

/* returns crc value */
unsigned long calculate_crc(unsigned long *frame, unsigned long length) {
long poly = 0x04C11DB7L;
unsigned long crc_gen, x;
union {
    unsigned long lword;
    unsigned char byte[4];
} b_access;
static unsigned char xpose[] = {
    0x0, 0x8, 0x4, 0xC, 0x2, 0xA, 0x6, 0xE,
    0x1, 0x9, 0x5, 0xD, 0x3, 0xB, 0x7, 0xF};
unsigned int i, j, fb;

crc_gen = ~0; /* seed generator with all ones */
for (i = 0; i < length; i++) {
    x = *frame++; /* get word */
    b_access.lword = x; /* transpose bits in byte */
    for (j = 0; j < 4; j++) {
        b_access.byte[j] = xpose[b_access.byte[j] >> 4] |
            xpose[b_access.byte[j] & 0xF] << 4;
    }
    x = b_access.lword;

    for (j = 0; j < 32; j++) { /* serial shift register implementation */
        fb = ((x & 0x80000000L) > 0) ^ ((crc_gen & 0x80000000L) > 0);
        x <<= 1;
        crc_gen <<= 1;
        if (fb)
            crc_gen ^= poly;
    }
}

b_access.lword = crc_gen; /* transpose bits in CRC */
for (j = 0; j < 4; j++) {
    b_access.byte[j] = xpose[b_access.byte[j] >> 4] |
        xpose[b_access.byte[j] & 0xF] << 4;
}
crc_gen = b_access.lword;

return ~crc_gen; /* invert output */
}

```

D.3 CRC implementation with XORs

These equations implement the multiply function shown in figure D.1 and figure D.2. The ^ symbol represents an XOR operation.

```

crc00 = d00^d06^d09^d10^d12^d16^d24^d25^d26^d28^d29^d30^d31;
crc01 = d00^d01^d06^d07^d09^d11^d12^d13^d16^d17^d24^d27^d28;

```

This page contains no comments

crc02 = d00^d01^d02^d06^d07^d08^d09^d13^d14^d16^d17^d18^d24^d26^d30^d31;
crc03 = d01^d02^d03^d07^d08^d09^d10^d14^d15^d17^d18^d19^d25^d27^d31;
crc04 = d00^d02^d03^d04^d06^d08^d11^d12^d15^d18^d19^d20^d24^d25^d29^d30^d31;
crc05 = d00^d01^d03^d04^d05^d06^d07^d10^d13^d19^d20^d21^d24^d28^d29;
crc06 = d01^d02^d04^d05^d06^d07^d08^d11^d14^d20^d21^d22^d25^d29^d30;
crc07 = d00^d02^d03^d05^d07^d08^d10^d15^d16^d21^d22^d23^d24^d25^d28^d29;
crc08 = d00^d01^d03^d04^d08^d10^d11^d12^d17^d22^d23^d28^d31;
crc09 = d01^d02^d04^d05^d09^d11^d12^d13^d18^d23^d24^d29;
crc10 = d00^d02^d03^d05^d09^d13^d14^d16^d19^d26^d28^d29^d31;
crc11 = d00^d01^d03^d04^d09^d12^d14^d15^d16^d17^d20^d24^d25^d26^d27^d28^d31;
crc12 = d00^d01^d02^d04^d05^d06^d09^d12^d13^d15^d17^d18^d21^d24^d27^d30^d31;
crc13 = d01^d02^d03^d05^d06^d07^d10^d13^d14^d16^d18^d19^d22^d25^d28^d31;
crc14 = d02^d03^d04^d06^d07^d08^d11^d14^d15^d17^d19^d20^d23^d26^d29;
crc15 = d03^d04^d05^d07^d08^d09^d12^d15^d16^d18^d20^d21^d24^d27^d30;
crc16 = d00^d04^d05^d08^d12^d13^d17^d19^d21^d22^d24^d26^d29^d30;
crc17 = d01^d05^d06^d09^d13^d14^d18^d20^d22^d23^d25^d27^d30^d31;
crc18 = d02^d06^d07^d10^d14^d15^d19^d21^d23^d24^d26^d28^d31;
crc19 = d03^d07^d08^d11^d15^d16^d20^d22^d24^d25^d27^d29;
crc20 = d04^d08^d09^d12^d16^d17^d21^d23^d25^d26^d28^d30;
crc21 = d05^d09^d10^d13^d17^d18^d22^d24^d26^d27^d29^d31;
crc22 = d00^d09^d11^d12^d14^d16^d18^d19^d23^d24^d26^d27^d29^d31;
crc23 = d00^d01^d06^d09^d13^d15^d16^d17^d19^d20^d26^d27^d29^d31;
crc24 = d01^d02^d07^d10^d14^d16^d17^d18^d20^d21^d27^d28^d30;
crc25 = d02^d03^d08^d11^d15^d17^d18^d19^d21^d22^d28^d29^d31;
crc26 = d00^d03^d04^d06^d10^d18^d19^d20^d22^d23^d24^d25^d26^d28^d31;
crc27 = d01^d04^d05^d07^d11^d19^d20^d21^d23^d24^d25^d26^d27^d29;
crc28 = d02^d05^d06^d08^d12^d20^d21^d22^d24^d25^d26^d27^d28^d30;
crc29 = d03^d06^d07^d09^d13^d21^d22^d23^d25^d26^d27^d28^d29^d31;
crc30 = d04^d07^d08^d10^d14^d22^d23^d24^d26^d27^d28^d29^d30;
crc31 = d05^d08^d09^d11^d15^d23^d24^d25^d27^d28^d29^d30^d31;

This page contains no comments

D.4 CRC examples

Table D.1 shows several CRC examples. Data is shown in dwords, from first to last.

Table D.1 — CRC examples

Frame contents	CRC	Frame contents	CRC
<SOF> 00010203h 04050607h 08090A0Bh 0C0D0E0Fh 10111213h 14151617h 18191A1Bh 1C1D1E1Fh <CRC> <EOF>	8A7E2691h	<SOF> 00000000h 00000000h 00000000h 00000000h 00000000h 00000000h 00000000h 00000000h 00000001h <CRC> <EOF>	3B650D6Eh
<SOF> 00000001h 00000000h 00000000h 00000000h 00000000h 00000000h 00000000h 00000000h 00000000h <CRC> <EOF>	898C0D7Ah	<SOF> 06D0B992h 00B5DF59h 00000000h 00000000h 1234FFFFh 00000000h 00000000h 00000000h 00000000h 00000000h 08000012h 01000000h 00000000h 00000000h <CRC> <EOF>	3F4F1C26h

This page contains no comments

Annex E (informative)

SAS address hashing

E.1 SAS address hashing overview

See 4.2.2 for a description of hashed SAS addresses and the algorithm used to create them.

E.2 Hash collision probability

The following are Monte-Carlo simulations evaluating the probability of collision in a system containing 128 addressable SAS ports. Four models were used for the models for the simulations:

- a) random model;
- b) sequential mode;
- c) lots model; and
- d) three lots model.

The random model uses a system with 128 randomly chosen 64-bit integers as SAS addresses.

The sequential model uses a system with 128 sequentially-assigned SAS addresses starting from a random 64-bit base.

The lots model uses:

- a) Two sequentially assigned SAS addresses with unique company IDs and random vendor-specific identifiers;
- b) 125 randomly drawn SAS addresses from a 10 000-unit production lot. The vendor-specific identifiers within the lot were assigned by 10 SAS address-writers, randomly drawn from a pool of 4 096 possible SAS address-writers. Each SAS address-writer assigns vendor-specific identifiers sequentially within its own subset of the vendor-specific identifiers, starting from a randomly chosen base at the beginning of the production run; and
- c) One randomly chosen SAS address with another unique company ID, representing a replacement unit.

The three lots model uses:

- a) Two sequentially assigned SAS addresses with unique company IDs and random vendor-specific identifiers;
- b) 125 randomly drawn SAS addresses from three 10 000-unit lots. The vendor-specific identifiers within each lot were assigned by 10 SAS address-writers, randomly drawn from a pool of 4 096 possible SAS address-writers for that vendor. Each SAS address-writer assigns vendor-specific identifiers sequentially within its own subset of the vendor-specific identifiers, starting from a randomly chosen base at the beginning of the production run. Each of the three lots has a different company ID; and
- c) One randomly chosen SAS address with another unique company ID, representing a replacement unit.

Table E.1 lists the results of Monte-Carlo simulation.

Table E.1 — Monte-Carlo simulation results

SAS address model	Trials	Collisions	Average collisions per system
lots	2 000 000 000	45 063	0.000 022 531 5
three lots	2 000 000 000	662 503	0.000 331 251 5
random	10 000 000	4 882	0.000 488 2
sequential	10 000 000	0	0

Author: Isi-gpenokie

Subject: Rectangle

Date: 5/6/2008 4:07:50 PM

 REJECT (with long numbers like this it's better to line up their decimal points)

These cells should all be centered.

E.3 Hash generation

One way to implement the hashing encoder in hardware is to use serial shift registers as shown in figure E.1. For error correction purposes, the number of data bits is limited to 39. For hashing purposes, the circuit shown serves as a divider. Because the period of this generator polynomial is 63, any binary sequence of length exceeding 63 is treated as a 63-bit sequence with $(\text{bit } 63) \times L + k$ added to $(\text{bit } k \text{ modulo } 2)$ for $k = 0, 1, \dots, 62$ and any integer L . Therefore, using this generator polynomial to hash a 64-bit address is equivalent to hashing a 63-bit sequence with bit 63 added modulo 2 to bit 0. With this wrapping, a binary sequence of any length is treated as an equivalent binary sequence of 63 bits, which, in turn, is treated as a degree-62 polynomial. After feeding this equivalent degree-62 polynomial into the circuit shown, the shift register contains the remainder from dividing the degree-62 input polynomial by the generator polynomial. This remainder is the hashed result.

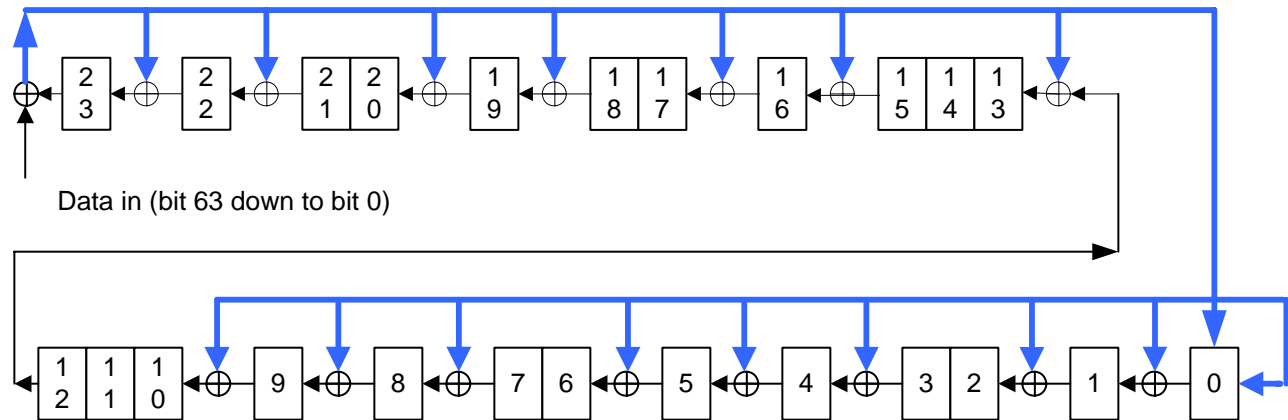

Figure E.1 — BCH(69, 39, 9) code generator

E.4 Hash implementation in C

The following is an example C program that generates a 24-bit hashed value from a 64-bit value.

```
typedef unsigned int uint32_t;
uint32_t hash(uint32_t upperbits, uint32_t lowerbits)
{
    const unsigned distance_9_poly = 0x01DB2777;
    uint32_t msb = 0x01000000;
    uint32_t moving_one, leading_bit;
    int i;
    unsigned regg;
    regg = 0;
    moving_one = 0x80000000;
    for (i = 31; i >= 0; i--) {
        leading_bit = 0;
        if (moving_one & upperbits) leading_bit = msb;
        regg <<= 1;
        regg ^= leading_bit;
        if (regg & msb) regg ^= distance_9_poly;
        moving_one >>= 1;
    }
    moving_one = 0x80000000;
    for (i = 31; i >= 0; i--) { // note lower limit of i = 0;
        leading_bit = 0;
        if (moving_one & lowerbits) leading_bit = msb;
        regg <<= 1;
        regg ^= leading_bit;
        if (regg & msb) regg ^= distance_9_poly;
    }
}
```

This page contains no comments

```

        moving_one >= 1;
    }
    return regg & 0x0FFFFFFF;
}

```

E.5 Hash implementation with XORs

These equations generate the 24-bit hashed SAS address for the SSP frame header from a 64-bit SAS address. The ^ symbol represents an XOR.

```

hash00=d00^d01^d03^d05^d07^d09^d10^d11^d12^d15^d16^d17^d18^d19^d20^d21^d22^
d23^d24^d25^d28^d30^d31^d33^d34^d36^d38^d39^d63;
hash01=d00^d02^d03^d04^d05^d06^d07^d08^d09^d13^d15^d26^d28^d29^d30^d32^d33^
d35^d36^d37^d38^d40^d63;
hash02=d00^d04^d06^d08^d11^d12^d14^d15^d17^d18^d19^d20^d21^d22^d23^d24^d25^
d27^d28^d29^d37^d41^d63;
hash03=d01^d05^d07^d09^d12^d13^d15^d16^d18^d19^d20^d21^d22^d23^d24^d25^d26^
d28^d29^d30^d38^d42;
hash04=d00^d01^d02^d03^d05^d06^d07^d08^d09^d11^d12^d13^d14^d15^d18^d26^d27^
d28^d29^d33^d34^d36^d38^d43^d63;
hash05=d00^d02^d04^d05^d06^d08^d11^d13^d14^d17^d18^d20^d21^d22^d23^d24^d25^
d27^d29^d31^d33^d35^d36^d37^d38^d44^d63;
hash06=d00^d06^d10^d11^d14^d16^d17^d20^d26^d31^d32^d33^d37^d45^d63;
hash07=d01^d07^d11^d12^d15^d17^d18^d21^d27^d32^d33^d34^d38^d46;
hash08=d00^d01^d02^d03^d05^d07^d08^d09^d10^d11^d13^d15^d17^d20^d21^d23^d24^
d25^d30^d31^d35^d36^d38^d47^d63;
hash09=d00^d02^d04^d05^d06^d07^d08^d14^d15^d17^d19^d20^d23^d26^d28^d30^d32^
d33^d34^d37^d38^d48^d63;
hash10=d00^d06^d08^d10^d11^d12^d17^d19^d22^d23^d25^d27^d28^d29^d30^d35^d36^
d49^d63;
hash11=d01^d07^d09^d11^d12^d13^d18^d20^d23^d24^d26^d28^d29^d30^d31^d36^d37^
d50;
hash12=d02^d08^d10^d12^d13^d14^d19^d21^d24^d25^d27^d29^d30^d31^d32^d37^d38^
d51;
hash13=d00^d01^d05^d07^d10^d12^d13^d14^d16^d17^d18^d19^d21^d23^d24^d26^d32^
d34^d36^d52^d63;
hash14=d01^d02^d06^d08^d11^d13^d14^d15^d17^d18^d19^d20^d22^d24^d25^d27^d33^
d35^d37^d53;
hash15=d02^d03^d07^d09^d12^d14^d15^d16^d18^d19^d20^d21^d23^d25^d26^d28^d34^
d36^d38^d54;
hash16=d00^d01^d04^d05^d07^d08^d09^d11^d12^d13^d18^d23^d25^d26^d27^d28^d29^
d30^d31^d33^d34^d35^d36^d37^d38^d55^d63;
hash17=d00^d02^d03^d06^d07^d08^d11^d13^d14^d15^d16^d17^d18^d20^d21^d22^d23^
d25^d26^d27^d29^d32^d33^d35^d37^d56^d63;
hash18=d01^d03^d04^d07^d08^d09^d12^d14^d15^d16^d17^d18^d19^d21^d22^d23^d24^
d26^d27^d28^d30^d33^d34^d36^d38^d57;
hash19=d00^d01^d02^d03^d04^d07^d08^d11^d12^d13^d21^d27^d29^d30^d33^d35^d36^
d37^d38^d58^d63;
hash20=d00^d02^d04^d07^d08^d10^d11^d13^d14^d15^d16^d17^d18^d19^d20^d21^d23^
d24^d25^d33^d37^d59^d63;
hash21=d01^d03^d05^d08^d09^d11^d12^d14^d15^d16^d17^d18^d19^d20^d21^d22^d24^
d25^d26^d34^d38^d60;
hash22=d00^d01^d02^d03^d04^d05^d06^d07^d11^d13^d24^d26^d27^d28^d30^d31^d33^
d34^d35^d36^d38^d61^d63;
hash23=d00^d02^d04^d06^d08^d09^d10^d11^d14^d15^d16^d17^d18^d19^d20^d21^d22^
d23^d24^d27^d29^d30^d32^d33^d35^d37^d38^d62^d63;

```

This page contains no comments

E.6 Hash examples

Table E.2 shows examples using simple SAS addresses as input values. Two of the input values hash to the same value.

Table E.2 — Hash results for simple SAS addresses



64-bit input value	24-bit hashed value
00000000_00000000h	000000h
00000000_00000001h	DB2777h
FFFFFFFF_FFFFFFFFh	DB2777h

Table E.3 shows examples using realistic SAS addresses as input values.

Table E.3 — Hash results for realistic SAS addresses

64-bit input value	24-bit hashed value
50010753_4F0CFC88h	D0B992h
50010B92_B3CBF639h	B5DF59h
5002037E_157FEC63h	B064F7h
50004CF6_FBCE3889h	88FF12h
50020374_C4657EC7h	F36570h
50010D92_A016E450h	9F9571h
50002A58_850ACC66h	64B6B9h
50008C7B_EE7910DEh	8D6135h
500508BD_C22CAC94h	86ECF1h
500805F3_334B0AD3h	752AB2h
500A0B8A_FAA6A820h	5543A7h
500805E6_BCC55C68h	463DEDh

● Author: RElliott

Subject: Note

Date: 6/30/2008 6:16:52 PM

 ACCEPT - DONE

Change _ to non-blocking space in the hex numbers in tables E.2 and E.3 to follow the prevailing convention.

Table E.4 shows examples using a walking ones pattern to generate the input values.

Table E.4 — Hash results for a walking ones pattern

64-bit input value	24-bit hashed value	64-bit input value	24-bit hashed value
0000000000000001h	DB2777h	0000000100000000h	8232C2h
0000000000000002h	6D6999h	0000000200000000h	DF42F3h
0000000000000004h	DAD332h	0000000400000000h	65A291h
0000000000000008h	6E8113h	0000000800000000h	CB4522h
0000000000000010h	DD0226h	0000001000000000h	4DAD33h
0000000000000020h	61233Bh	0000002000000000h	9B5A66h
0000000000000040h	C24676h	0000004000000000h	ED93BBh
0000000000000080h	5FAB9Bh	0000008000000000h	000001h
0000000000000100h	BF5736h	0000010000000000h	000002h
0000000000000200h	A5891Bh	0000020000000000h	000004h
0000000000000400h	903541h	0000040000000000h	000008h
0000000000000800h	FB4DF5h	0000080000000000h	000010h
0000000000001000h	2DBC9Dh	0000100000000000h	000020h
0000000000002000h	5B793Ah	0000200000000000h	000040h
0000000000004000h	B6F274h	0000400000000000h	000080h
0000000000008000h	B6C39Fh	0000800000000000h	000100h
0000000000010000h	B6A049h	0001000000000000h	000200h
0000000000020000h	B667E5h	0002000000000000h	000400h
0000000000040000h	B7E8BDh	0004000000000000h	000800h
0000000000080000h	B4F60Dh	0008000000000000h	001000h
0000000000100000h	B2CB6Dh	0010000000000000h	002000h
0000000000200000h	BEB1ADh	0020000000000000h	004000h
0000000000400000h	A6442Dh	0040000000000000h	008000h
0000000000800000h	97AF2Dh	0080000000000000h	010000h
0000000001000000h	F4792Dh	0100000000000000h	020000h
0000000002000000h	33D52Dh	0200000000000000h	040000h
0000000004000000h	67AA5Ah	0400000000000000h	080000h
0000000008000000h	CF54B4h	0800000000000000h	100000h
0000000010000000h	458E1Fh	1000000000000000h	200000h
0000000020000000h	8B1C3Eh	2000000000000000h	400000h
0000000040000000h	CD1F0Bh	4000000000000000h	800000h
0000000080000000h	411961h	8000000000000000h	DB2777h

This page contains no comments

Table E.5 shows examples using a walking zeros pattern to generate the input values.

Table E.5 — Hash results for a walking zeros pattern

64-bit input value	24-bit hashed value	64-bit input value	24-bit hashed value
FFFFFFFFFFFFFFFFFEh	000000h	FFFFFFFFFFFFFFFFFh	5915B5h
FFFFFFFFFFFFFFFFFDh	B64EEh	FFFFFFFFDFFFFFFFFh	046584h
FFFFFFFFFFFFFFFFFBh	01F445h	FFFFFFFFBFFFFFFFFh	BE85E6h
FFFFFFFFFFFFFFFFF7h	B5A664h	FFFFFFFF7FFFFFFFFh	106255h
FFFFFFFFFFFFFFFFFEFh	062551h	FFFFFFFFEFFFFFFFFh	968A44h
FFFFFFFFFFFFFFFFDFh	BA044Ch	FFFFFFFFDFFFFFFFFh	407D11h
FFFFFFFFFFFFFFFFBFh	196101h	FFFFFFFFBFFFFFFFFh	36B4CCh
FFFFFFFFFFFFFFFFF7Fh	848CECh	FFFFFFFF7FFFFFFFFh	DB2776h
FFFFFFFFFFFFFFFFEFFh	647041h	FFFFFFFFEFFFFFFFFh	DB2775h
FFFFFFFFFFFFFFFFDFh	7EAE6Ch	FFFFFFFFDFFFFFFFFh	DB2773h
FFFFFFFFFFFFFFFFBFh	4B1236h	FFFFFFFFBFFFFFFFFh	DB277Fh
FFFFFFFFFFFFFFFF7FFh	206A82h	FFFFFFFF7FFFFFFFFh	DB2767h
FFFFFFFFFFFFFFFFEFFh	F69BEAh	FFFFFFFFEFFFFFFFFh	DB2757h
FFFFFFFFFFFFFFFFDFh	805E4Dh	FFFFFFFFDFFFFFFFFh	DB2737h
FFFFFFFFFFFFFFFFBFh	6DD503h	FFFFFFFFBFFFFFFFFh	DB27F7h
FFFFFFFFFFFFFFFF7FFh	6DE4E8h	FFFFFFFF7FFFFFFFFh	DB2677h
FFFFFFFFFFFFFFFFEFFh	6D873Eh	FFFFFFFFEFFFFFFFFh	DB2577h
FFFFFFFFFFFFFFFFDFh	6D4092h	FFFFFFFFDFFFFFFFFh	DB2377h
FFFFFFFFFFFFFFFFBFh	6CCFCAh	FFFFFFFFBFFFFFFFFh	DB2F77h
FFFFFFFFFFFFFFFF7FFh	6FD17Ah	FFFFFFFF7FFFFFFFFh	DB3777h
FFFFFFFFFFFFFFFFEFFh	69EC1Ah	FFFFFFFFEFFFFFFFFh	DB0777h
FFFFFFFFFFFFFFFFDFh	6596DAh	FFFFFFFFDFFFFFFFFh	DB6777h
FFFFFFFFFFFFFFFFBFh	7D635Ah	FFFFFFFFBFFFFFFFFh	DBA777h
FFFFFFFFFFFFFFFF7FFh	4C885Ah	FFFFFFFF7FFFFFFFFh	DA2777h
FFFFFFFFFFFFFFFFEFFh	2F5E5Ah	FFFFFFFFEFFFFFFFFh	D92777h
FFFFFFFFFFFFFFFFDFh	E8F25Ah	FFFFFFFFDFFFFFFFFh	DF2777h
FFFFFFFFFFFFFFFFBFh	BC8D2Dh	FFFFFFFFBFFFFFFFFh	D32777h
FFFFFFFFFFFFFFFF7FFh	1473C3h	FFFFFFFF7FFFFFFFFh	CB2777h
FFFFFFFFFFFFFFFFEFFh	9EA968h	FFFFFFFFEFFFFFFFFh	FB2777h
FFFFFFFFFFFFFFFFDFh	503B49h	FFFFFFFFDFFFFFFFFh	9B2777h
FFFFFFFFFFFFFFFFBFh	16387Ch	FFFFFFFFBFFFFFFFFh	5B2777h
FFFFFFFFFFFFFFFF7FFh	9A3E16h	FFFFFFFF7FFFFFFFFh	000000h

This page contains no comments

Annex F (informative)

Scrambling

F.1 Scrambler implementation example

Figure F.1 shows an example of a data scrambler. This example generates the value to XOR with the dword input with two 16 bit parallel multipliers. 16 bits wide is the maximum width for the multiplier as the generating polynomial is 16 bits.

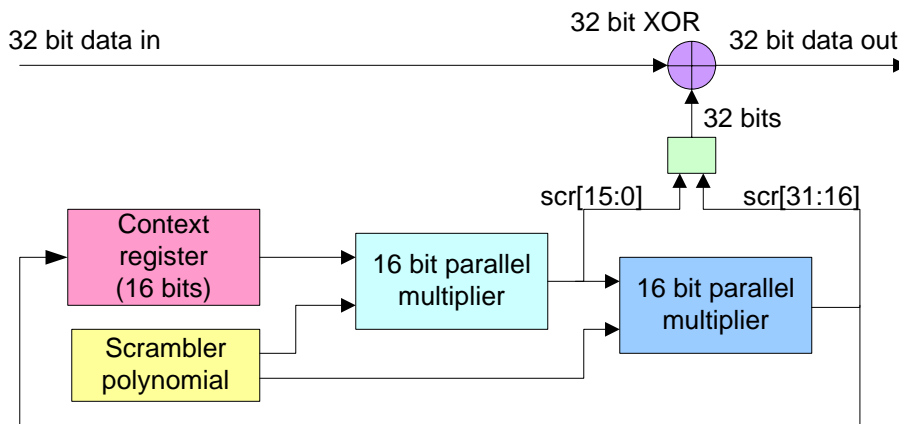

Figure F.1 — Scrambler

The generator polynomial is:

$$G(x) = x^{16} + x^{15} + x^{13} + x^4 + 1$$

For all implementations, the context register is initialized to produce a first dword output of C2D2768Dh for a dword input of all zeros.

F.2 Scrambler implementation in C

The following is an example C program that generates the scrambled data dwords for transmission. The inputs are the data dword to scramble and control indication to reinitialize the residual value (e.g., following an SOF).

```
#include <stdio.h>

unsigned long scramble(int reset, unsigned long dword);
void main(void)
{
    int i;

    for (i = 0; i < 12; i++)
        printf(" %08X \n",scramble(i==0, 0));/* scramble all 0s */
}

#define poly 0xA011
unsigned long scramble(int reset, unsigned long dword) {
    static unsigned short scramble;
    int i;

    if (reset)
        scramble = 0xFFFF;
```

This page contains no comments

```

for (i = 0; i < 32; i++) /* serial shift register implementation */
{
    dword ^= (scramble & 0x8000)? (1 << i):0;
    scramble = (scramble << 1) ^ ((scramble & 0x8000)? poly:0);
}
return dword;
}

```

F.3 Scrambler implementation with XORs

These equations generate the scrambled dwords to XOR with dwords before transmission and dword reception to recover the original data. The ^ symbol represents an XOR operation. The initialized value for $d[15:0]$ is F0F6h (i.e., 0xF0F6) in this example.

```

scr0=d15^d13^d4^d0;
scr1=d15^d14^d13^d5^d4^d1^d0;
scr2=d14^d13^d6^d5^d4^d2^d1^d0;
scr3=d15^d14^d7^d6^d5^d3^d2^d1;
scr4=d13^d8^d7^d6^d3^d2^d0;
scr5=d14^d9^d8^d7^d4^d3^d1;
scr6=d15^d10^d9^d8^d5^d4^d2;
scr7=d15^d13^d11^d10^d9^d6^d5^d4^d3^d0;
scr8=d15^d14^d13^d12^d11^d10^d7^d6^d5^d1^d0;
scr9=d14^d12^d11^d8^d7^d6^d4^d2^d1^d0;
scr10=d15^d13^d12^d9^d8^d7^d5^d3^d2^d1;
scr11=d15^d14^d10^d9^d8^d6^d3^d2^d0;
scr12=d13^d11^d10^d9^d7^d3^d1^d0;
scr13=d14^d12^d11^d10^d8^d4^d2^d1;
scr14=d15^d13^d12^d11^d9^d5^d3^d2;
scr15=d15^d14^d12^d10^d6^d3^d0;
scr16=d11^d7^d1^d0;
scr17=d12^d8^d2^d1;
scr18=d13^d9^d3^d2;
scr19=d14^d10^d4^d3;
scr20=d15^d11^d5^d4;
scr21=d15^d13^d12^d6^d5^d4^d0;
scr22=d15^d14^d7^d6^d5^d4^d1^d0;
scr23=d13^d8^d7^d6^d5^d4^d2^d1^d0;
scr24=d14^d9^d8^d7^d6^d5^d3^d2^d1;
scr25=d15^d10^d9^d8^d7^d6^d4^d3^d2;
scr26=d15^d13^d11^d10^d9^d8^d7^d5^d3^d0;
scr27=d15^d14^d13^d12^d11^d10^d9^d8^d6^d1^d0;
scr28=d14^d12^d11^d10^d9^d7^d4^d2^d1^d0;
scr29=d15^d13^d12^d11^d10^d8^d5^d3^d2^d1;
scr30=d15^d14^d12^d11^d9^d6^d3^d2^d0;
scr31=d12^d10^d7^d3^d1^d0;

```

This page contains no comments

This page contains no comments

Annex G (informative)

ATA architectural notes

G.1 STP differences from Serial ATA (SATA)

Some of the differences of STP compared with SATA are:

- a) STP adds addressing of multiple SATA devices. Each SATA device is assigned a SAS address by its attached expander device with STP/SATA bridge functionality. The STP initiator port **understands addressing** more than one STP target port;
- b) STP allows multiple STP initiator ports to share access to a SATA device behind an STP/SATA bridge using affiliations (see 7.17.4);
- c) interface power management is not supported;
- d) far-end analog loopback testing is not supported;
- e) far-end retimed loopback testing is not supported;
- f) near-end analog loopback testing is not supported;
- g) use of SATA_CONT is required; and
- h) BIST Activate frames are not supported.

G.2 STP differences from Serial ATA II

The following features of Serial ATA II are **specifically** excluded from SAS STP or handled differently in a SAS domain:

- a) extended differential voltages;
- b) enclosure services;
- c) staggered spin-up (see 6.11);
- d) device activity indication;
- e) presence detect; and
- f) power management improvements.

G.3 Affiliation policies

G.3.1 Affiliation policies overview

SATA is based on a model that assumes a SATA device is controlled by a single SATA **host, and** does not address the notion of multiple SATA hosts having the ability to access any given SATA device.

With STP/SATA bridges, SATA devices are cast into an environment where multiple STP initiator ports, by sharing the SATA host port of the STP/SATA bridge, have access to the same SATA device. The SATA protocol used inside STP connections does not account for the possibility that more than one STP initiator port **might be** vying for access to the SATA device. Affiliations provide a way to ensure contention for a SATA device does not result in incoherent access to the SATA device when commands from different STP initiator ports collide at the SATA device.

To prevent a SATA device from confusing commands from one STP initiator port with commands from another, an STP initiator port **needs a means** to maintain exclusive access to a SATA or STP device for the duration of the processing of a command.

For example, consider the case where an STP initiator port establishes a connection to send a command (e.g., a read), and then closes the connection while the SATA device (e.g., a disk drive) retrieves the data (e.g., performs a seek operation to the track containing the data). If, after the connection is closed, another STP initiator port is allowed to establish a connection and send another command, **the** SATA device would no longer have a means to determine which STP initiator port should receive the data when the device requests the connection to send the data for the first command. This is because, unlike SCSI target devices, SATA devices have no notion of multiple SATA hosts.

● Author: wdc-mevans
Subject: Highlight
Date: 5/22/2008 5:07:38 PM
T ACCEPT - DONE

understands addressing
s/b
is capable of addressing

● Author: wdc-mevans
Subject: Cross-Out
Date: 5/22/2008 5:07:55 PM
T ACCEPT - DONE

specifically
s/b
[Delete the unnecessary word.]

● Author: wdc-mevans
Subject: Highlight
Date: 5/6/2008 4:07:50 PM
T REJECT (these are not logically being ANDed, this is joining two independent clauses)

host, and
s/b
host and

● Author: wdc-mevans
Subject: Highlight
Date: 5/22/2008 5:09:36 PM
T ACCEPT - DONE

might be
s/b
is

● Author: wdc-mevans
Subject: Highlight
Date: 5/22/2008 5:12:29 PM
T REJECT (this matches the "means" defined in the last paragraph of the section)

needs a means
s/b
implements a method

● Author: RElliott
Subject: Highlight
Date: 6/30/2008 6:16:52 PM
T ACCEPT - DONE

the
s/b
then the

The consequences are worse for write commands **since the result could be** wrong data written to media, with the original data being overwritten and permanently lost.

Affiliations provide a means for an STP initiator port to establish atomic access to a SATA device across the processing of a command or series of commands to the SATA device, without requiring the STP initiator port to maintain a connection open to the STP target port for the duration of command processing.

G.3.2 Affiliation policy for static STP initiator port to STP target port mapping

Affiliations should not be used to enforce policies establishing fixed associations between STP initiator ports and STP target ports.

G.3.3 Affiliation policy with SATA queued commands and multiple STP initiator ports

When sharing an affiliation context, STP initiator ports using queued commands when other STP initiator ports may be accessing the same STP target port should, at vendor-specific intervals, allow commands to complete and release the affiliation to allow other STP initiator ports access to the STP target port.

G.3.4 Applicability of affiliation for STP target ports

Affiliation may or may not be necessary for STP target ports depending on whether the STP target port tracks the STP initiator port's SAS address on each command received. If the STP target port has the means to manage and track commands from each STP initiator port independently, then affiliations are not necessary because the STP target port is capable of associating each information transfer with the appropriate STP initiator port, and is capable of establishing a connection to the appropriate STP initiator port when sending information back for a command.

An STP target port capable of tracking commands may support a limited number of STP initiator ports (~~i.e., more than one, but less than one per command~~) and use multiple affiliations in order to manage that restriction.

An STP target port that behaves the same as a SATA device, in that it maintains only a single **ATA task file register context** to be shared among all STP initiator **ports, supports** a single affiliation in order to provide a way for STP initiator ports to maintain exclusive access to the STP target port while commands remain outstanding. In this model, an STP target port is capable of establishing connections to an STP initiator port, but is only capable of remembering the SAS address of the last STP initiator port to establish a connection, and therefore is only capable of requesting a connection back to that same STP initiator port.

See 10.4.3.12 for an explanation of how an STP target port reports support for affiliations.

G.4 SATA port selector considerations

Not all the protocol elements for STP initiator ports to manage a SATA port selector (see SATA-2) in a SAS domain are defined in this standard. Additional coordination between STP initiator ports may be needed to avoid conflicting usage of the SATA port selector between STP initiator ports (e.g., between two SAS domains). Such additional coordination is outside the scope of this standard.

G.5 SATA device not transmitting initial Register Device-to-Host FIS

Some SATA devices do not return the initial Register Device-to-Host FIS after a link reset sequence if they did not detect the COMINIT during the link reset sequence (e.g., if the SATA device originated the link reset sequence). While waiting for the initial Register Device-to-Host FIS, an STP/SATA bridge responds as follows:

- a) In the SMP DISCOVER response (see 10.4.3.10):
 - A) the ATTACHED DEVICE TYPE field is set to 000b;
 - B) the NEGOTIATED LOGICAL LINK RATE field and the NEGOTIATED PHYSICAL LINK RATE field are set to a value indicating the phy is enabled at a valid link rate (e.g., G1 (i.e., 8h), G2 (i.e., 9h), or G3 (i.e., Ah));
 - C) the ATTACHED SATA DEVICE bit is set to one; and
 - D) the ATTACHED SAS ADDRESS field is set to the SAS address of the STP target port of the STP/SATA bridge;

Page: 710

● Author: wdc-mevans
Subject: Highlight
Date: 5/22/2008 5:13:04 PM

T REJECT (there's no guarantee that they will result in data loss)

since the result could be
s/b
resulting in

● Author: wdc-mevans
Subject: Cross-Out
Date: 5/22/2008 5:15:22 PM

T REJECT (a native STP target port would allow each command to come from a new initiator. This is describing the more likely case for STP/SATA bridges where the STP target port is forced to limit the number of STP initiators to something less than one per command.)

(i.e., more than one, but less than one per command)
s/b

[Delete this confusing parenthetical statement. It is not possible to have "less than one [initiator port] per command.]

● Author: RElliott
Subject: Highlight
Date: 6/30/2008 6:16:52 PM

T ACCEPT - DONE

ATA task file register context
s/b
affiliation context

and delete "supports a single affiliation in order to"

● Author: wdc-mevans
Subject: Highlight
Date: 5/22/2008 5:16:20 PM

T REJECT (that would turn this into an incomplete sentence)

ports, supports
s/b
ports and supports

● Author: RElliott
Subject: Underline
Date: 6/30/2008 6:16:52 PM

T ACCEPT - DONE

In
s/b
in

(part of global change to lowercase a)b)c) entries)

and

- b) returns OPEN_REJECT (NO DESTINATION) for connection requests to the SAS address of the STP target port.

If an STP initiator port detects this situation for a vendor-specific amount of time, an SMP application client should send an SMP PHY CONTROL function requesting a phy operation of LINK RESET or HARD RESET to originate a new link reset sequence. The SATA device is expected to detect the COMINIT during this link reset sequence and provide the initial Register Device-to-Host FIS.

This page contains no comments

Annex H

(informative)

Minimum deletable primitive insertion rate summary

Table H.1 shows all the possible combinations of deletable primitive (see 7.2.5) insertion rates for physical link rate tolerance management (see 7.3) and rate matching (see 7.13).

Table H.1 — Minimum deletable primitive insertion rate examples

Physical link rate	Connection rate	Deletable primitive insertion rate (per specified number of dwords)
6 Gbps	6 Gbps	4 per 512 (physical link rate tolerance management)
	3 Gbps	4 per 512 (physical link rate tolerance management) + 1 per 2 (rate matching)
	1.5 Gbps	4 per 512 (physical link rate tolerance management) + 3 per 4 (rate matching)
3 Gbps	3 Gbps	2 per 256 (physical link rate tolerance management)
	1.5 Gbps	2 per 256 (physical link rate tolerance management) + 1 per 2 (rate matching)
1.5 Gbps	1.5 Gbps	1 per 128 (physical link rate tolerance management)

This page contains no comments

Annex I

(informative)

Zone permission configuration descriptor examples

This annex provides examples of using multiple zone permission configuration descriptors in the SMP CONFIGURE ZONE PERMISSION TABLE function (see 10.4.3.26) if the number of zone groups is 128.

Table I.1 shows an example initial value of the zone permission table.

Table I.1 — Zone permission table example initial value

Zone group	0^a	1^a	2 to 3	4 to 7^a	8	9	10	11	12 to 127
0^a	0	1	0	0	0	0	0	0	0
1^a	1	1	1	1	1	1	1	1	1
2 to 3	0	1	0	0	0	0	0	0	0
4 to 7^a	0	1	0	0	0	0	0	0	0
8	0	1	0	0	0	0	0	0	0
9	0	1	0	0	0	0	0	0	0
10	0	1	0	0	0	0	0	0	0
11	0	1	0	0	0	0	0	0	0
12 to 127	0	1	0	0	0	0	0	0	0
^a Zone permission table entries for this zone group are not changeable.									

This page contains no comments

Table I.2 shows an example SMP CONFIGURE ZONE PERMISSION TABLE request where the STARTING ZONE GROUP field is set to 10 (i.e., 0Ah) and the zone permission configuration descriptor list contains two zone permission configuration descriptors.

Table I.2 — CONFIGURE ZONE PERMISSION TABLE request example

Byte\Bit	7	6	5	4	3	2	1	0
0	SMP FRAME TYPE (40h)							
1	FUNCTION (8Bh)							
2	Reserved							
3	REQUEST LENGTH (0Bh)							
4	(MSB) _____							
5	EXPECTED EXPANDER CHANGE COUNT _____ (LSB)							
6	STARTING SOURCE ZONE GROUP (0Ah)							
7	NUMBER OF ZONE PERMISSION CONFIGURATION DESCRIPTORS (02h)							
Zone permission configuration descriptor (first)(source zone group 10)								
8	FFh							
...	(each byte set to FFh)							
23	0Eh							
Zone permission configuration descriptor (second)(source zone group 11)								
24	00h							
...	(each byte set to 00h)							
47	00h							
48	(MSB) _____							
51	CRC _____ (LSB)							

This page contains no comments

Table I.3 shows the zone permission table after processing the first zone permission configuration descriptor (i.e., source zone group 10).

Table I.3 — Zone permission table after processing the first zone permission configuration descriptor

Zone group	0 ^a	1 ^a	2 to 3	4 to 7 ^a	8	9	10 ^b	11	12 to 127
0 ^a	0	1	0	0	0	0	0	0	0
1 ^a	1	1	1	1	1	1	1	1	1
2 to 3	0	1	0	0	0	0	1	0	0
4 to 7 ^a	0	1	0	0	0	0	0	0	0
8	0	1	0	0	0	0	1	0	0
9	0	1	0	0	0	0	1	0	0
10 ^b	0	1	1	0	1	1	1	1	1
11	0	1	0	0	0	0	1	0	0
12 to 127	0	1	0	0	0	0	1	0	0

^a Zone permission table entries for this zone group are not changeable.
^b Changeable entries in this zone group are changed by the descriptor.

Table I.4 shows the zone permission table after processing the second zone permission configuration descriptor (i.e., source zone group 11).

Table I.4 — Zone permission table after processing the second zone permission configuration descriptor

Zone group	0 ^a	1 ^a	2 to 3	4 to 7 ^a	8	9	10	11 ^b	12 to 127
0 ^a	0	1	0	0	0	0	0	0	0
1 ^a	1	1	1	1	1	1	1	1	1
2 to 3	0	1	0	0	0	0	1	0	0
4 to 7 ^a	0	1	0	0	0	0	0	0	0
8	0	1	0	0	0	0	1	0	0
9	0	1	0	0	0	0	1	0	0
10	0	1	1	0	1	1	1	0	1
11 ^b	0	1	0	0	0	0	0	0	0
12 to 127	0	1	0	0	0	0	1	0	0

^a Zone permission table entries for this zone group are not changeable.
^b Changeable entries in this zone group are changed by the descriptor.

This page contains no comments

Annex J
(informative)

Expander device handling of connections

J.1 Expander device handling of connections overview

This annex provides examples of how expander devices process connection requests.

Figure J.1 shows the topology used by examples in this annex.

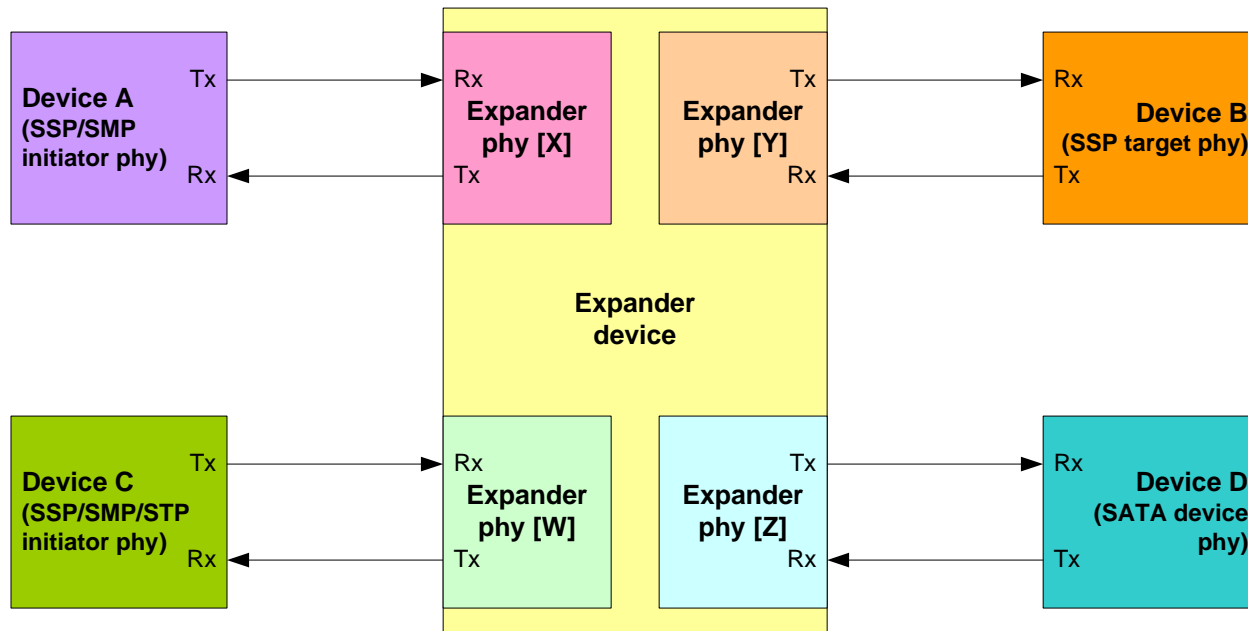

Figure J.1 — Example topology

This page contains no comments

Table J.1 defines the column headers used within the figures contained within this annex.

Table J.1 — Column descriptions for connection examples

Column header	Description
Phy [W] Rx	Expander phy [W] Receive from device C
Phy [W] Tx	Expander phy [W] Transmit to device C
Phy [W] XL state	Expander phy [W] XL state machine state (see 7.15)
Phy [W] XL req/rsp	Expander phy [W] XL requests and responses (see 4.6.6)
Phy [W] XL cnf/ind	Expander phy [W] XL confirmations and indications (see 4.6.6)
Phy [X] Rx	Expander phy [X] Receive from device A
Phy [X] Tx	Expander phy [X] Transmit to device A
Phy [X] XL state	Expander phy [X] XL state machine state (see 7.15)
Phy [X] XL req/rsp	Expander phy [X] XL requests and responses (see 4.6.6)
Phy [X] XL cnf/ind	Expander phy [X] XL confirmations and indications (see 4.6.6)
Phy [Y] XL cnf/ind	Expander phy [Y] XL confirmations and indications (see 4.6.6)
Phy [Y] XL req/rsp	Expander phy [Y] XL requests and responses (see 4.6.6)
Phy [Y] XL state	Expander phy [Y] XL state machine state (see 7.15)
Phy [Y] Tx	Expander phy [Y] Transmit to device B
Phy [Y] Rx	Expander phy [Y] Receive from device B
Phy [Z] XL cnf/ind	Expander phy [Y] XL confirmations and indications (see 4.6.6)
Phy [Z] XL req/rsp	Expander phy [Y] XL requests and responses (see 4.6.6)
Phy [Z] XL state	Expander phy [Y] XL state machine state (see 7.15)
Phy [Z] Tx	Expander phy [Y] Transmit to device D
Phy [Z] Rx	Expander phy [Y] Receive from device D

This page contains no comments

J.2 Connection request - OPEN_ACCEPT

Figure J.2 shows the establishment of a successful connection between two end devices.

Expander phy [X]				Expander phy [Y]			
Rx	Tx	XL state	XL req/rsp	XL cnf/ind	XL req/rsp	XL state	Rx
idle dwords	idle dwords	XL0:Idle				XL0:Idle	idle dwords
SOAF							
OPEN (A to B)							
EOAF							
idle dwords	AIP (NORMAL) and/or idle dwords	XL1: Request_Path	Request Path	Arbitrating (Normal)			
				Arb Won			
		XL2: Request_Open	Forward Open				
		XL3: Open_Cnf_Wait	Forward Dword (idle dwords)			XL5: Forward_Open	SOAF OPEN (A to B) EOAF
	AIP (WAITING ON DEVICE)				Arb Status (Waiting On Device)	XL6: Open_Rsp_Wait	idle dwords (forwarded or generated)
	idle dwords						
	OPEN_ACCEPT				Open Accept		OPEN_ACCEPT
connection dwords	connection dwords	XL7:Connected	Forward Dword (connection dwords)	Forward Dword (connection dwords)	Forward Dword (connection dwords)	XL7:Connected	idle dwords (forwarded)
							connection dwords

Figure J.2 — Connection request - OPEN_ACCEPT

This page contains no comments

J.3 Connection request - OPEN_REJECT by end device

Figure J.3 shows failure to establish a connection due to rejection of the connection request by an end device.

Expander phy [X]		Expander phy [Y]						
Rx	Tx	XL state	XL req/rsp	XL cnf/find	XL req/rsp	XL state	Tx	Rx
idle dwords	idle dwords	XL0:Idle				XL0:Idle	idle dwords	idle dwords
SOAF								
OPEN (A to B)		XL1: Request_Path	Request Path	Arbitrating (Normal)				
EOAF	AIP (NORMAL) and/or idle dwords			Arb Won				
idle dwords		XL2: Request_Open	Forward Open				SOAF	
							OPEN (A to B)	
		XL3: Open_Cnf_Wait	Forward Dword (idle dwords)				EOAF	
	AIP (WAITING ON DEVICE)						idle dwords (forwarded or generated)	
	idle dwords			Arb Status (Waiting On Device)				
	OPEN_REJECT			Open Reject				OPEN_REJECT
idle dwords	idle dwords	XL0:Idle				XL0:Idle	idle dwords	idle dwords

Figure J.3 — Connection request - OPEN_REJECT by end device

This page contains no comments

J.4 Connection request - OPEN_REJECT by expander device

Figure J.4 shows failure to establish a connection due to rejection of the connection request by an expander device.

Expander phy [X]		Expander phy [Y]					
Rx	Tx	XL state	XL req/rsp	XL cnf/ind	XL state	Tx	Rx
idle dwords	idle dwords	XL0:Idle			XL0:Idle	idle dwords	idle dwords
SOAF							
OPEN (A to B)							
EOAF							
idle dwords	AIP (NORMAL) and/or idle dwords	XL1: Request_Path	Request Path	Arbitrating (Normal)			
	OPEN_REJECT	XL4:Open_Reject		Arb Reject			
	idle dwords	XL0:Idle					

Figure J.4 — Connection request - OPEN_REJECT by expander device

This page contains no comments

J.5 Connection request - arbitration lost

Figure J.5 shows two end devices attempting to establish a connection at the same time. This example assumes that the OPEN (A to B) address frame has higher priority than the OPEN (B to A) address frame and therefore device A wins arbitration and device B loses arbitration.

Expander phy [X]		Expander phy [Y]					
Rx	Tx	XL state	XL req/rsp	XL cnf/find	XL state	Tx	Rx
idle dwords	idle dwords	XL0:Idle			XL0:Idle	idle dwords	idle dwords
SOAF							SOAF
OPEN (A to B)							OPEN (B to A)
EOAF							EOAF
idle dwords	AIP (NORMAL) and/or idle dwords	XL1: Request_Path	Request Path	Arbitrating (Normal)	XL1: Request_Path	AIP (NORMAL) and/or idle dwords	idle dwords
				Arb Won			
		XL2: Request_Open	Forward Open	Arb Lost	XL0:Idle	idle dwords	
					XL5: Forward_Open	SOAF	
						OPEN (A to B)	
						EOAF	
						idle dwords (forwarded or generated)	
	AIP (WAITING ON DEVICE)	XL3: Open_Cnf_Wait	Forward Dword (idle dwords)	Forward Dword (idle dwords)	XL6: Open_Rsp_Wait		
	idle dwords						
	OPEN_ACCEPT			Arb Status (Waiting On Device)	Open Accept		OPEN_ACCEPT
				Open Accept			
				Forward Dword (connection dwords)	Forward Dword (connection dwords)	idle dwords (forwarded)	connection dwords
connection dwords	connection dwords	XL7:Connected	Forward Dword (connection dwords)	Forward Dword (connection dwords)	XL7:Connected	connection dwords	connection dwords

Figure J.5 — Connection request - arbitration lost

This page contains no comments

J.6 Connection request - backoff and retry

Figure J.6 shows a higher priority OPEN address frame (B to C) received by a phy which has previously forwarded an OPEN address frame (A to B) whose source (A) differs from the winning destination (C). In this case expander phy [X] is required to back off and retry path arbitration (see 7.15.9).

		Expander phy [X]				Expander phy [Y]			
Rx	Tx	XL state	XL req/rsp	XL cnf/ind	XL cnf/ind	XL req/rsp	XL state	Tx	Rx
idle dwords	idle dwords	XL0: idle					XL0: idle	idle dwords	idle dwords
SOAF									
OPEN (A to B)									
EOAF									
idle dwords	AIP (NORMAL) and/or idle dwords	XL1: Request_Path	Request Path	Arbitrating (Normal)					
				Arb Won					
		XL2: Request_Open	Forward Open		Forward Open			SOAF	
							XL5: Forward_Open	OPEN (A to B)	
		XL3: Open_Cnf_Wait	Forward Dword (idle dwords)		Forward Dword (idle dwords)			EOAF	
	AIP (WAITING ON DEVICE)					Arb Status (Waiting On Device)		idle dwords (forwarded or generated)	
									SOAF
	idle dwords					Backoff Retry			OPEN (B to C)
									EOAF
		XL1: Request_Path	Request Path	Arbitrating (Normal)		Request Path	XL1: Request_Path		idle dwords
	AIP (NORMAL) and/or idle dwords				Arb Won			AIP (NORMAL) and/or idle dwords	
						Forward Open	XL2: Request_Open		

Figure J.6 — Connection request - backoff and retry

This page contains no comments

This page contains no comments

J.8 Connection close - single step

Figure J.8 shows an end device initiating the closing of a connection by transmitting CLOSE, followed by another end device responding with CLOSE at a later time.

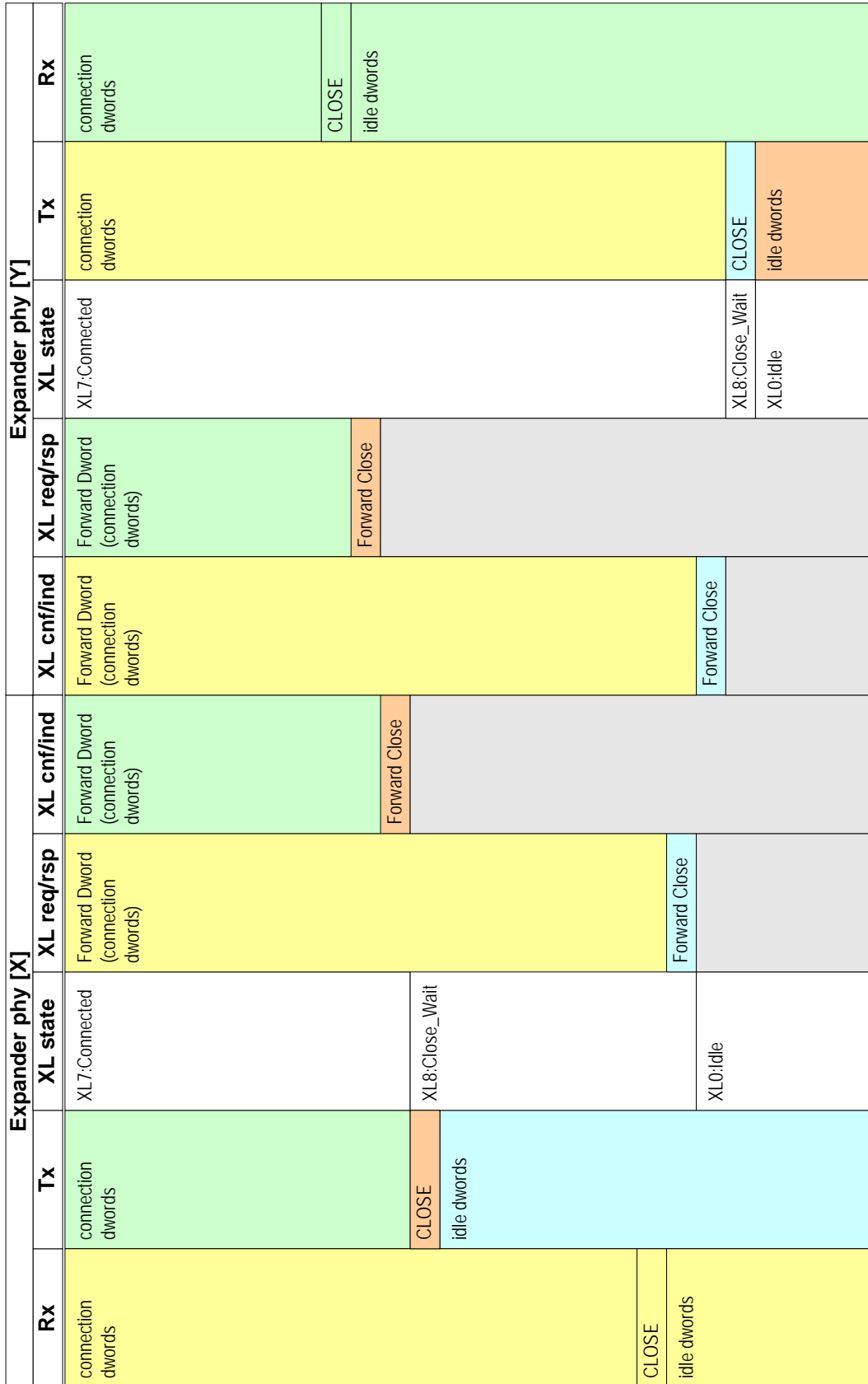

Figure J.8 — Connection close - single step

This page contains no comments

J.9 Connection close - simultaneous

Figure J.9 shows two end devices simultaneously transmitting CLOSE to each other.

Expander phy [X]		Expander phy [Y]							
Rx	Tx	XL state	XL req/rsp	XL cnf/find	XL cnf/find	XL req/rsp	XL state	Tx	Rx
connection dwords	connection dwords	XL7:Connected	Forward Dword (connection dwords)	Forward Dword (connection dwords)	Forward Dword (connection dwords)	Forward Dword (connection dwords)	XL7:Connected	connection dwords	connection dwords
CLOSE			Forward Close			Forward Close			CLOSE
idle dwords	CLOSE	XL8:Close_Wait		Forward Close			XL8:Close_Wait	CLOSE	idle dwords
	idle dwords	XL0:Idle					XL0:Idle	idle dwords	

Figure J.9 — Connection close - simultaneous

This page contains no comments

J.10 BREAK handling during path arbitration when the BREAK_REPLY method is disabled

Figure J.10 shows an expander device responding to the reception of a BREAK during path arbitration when the BREAK_REPLY method of responding to BREAK primitive sequences is disabled (see 7.12.5).

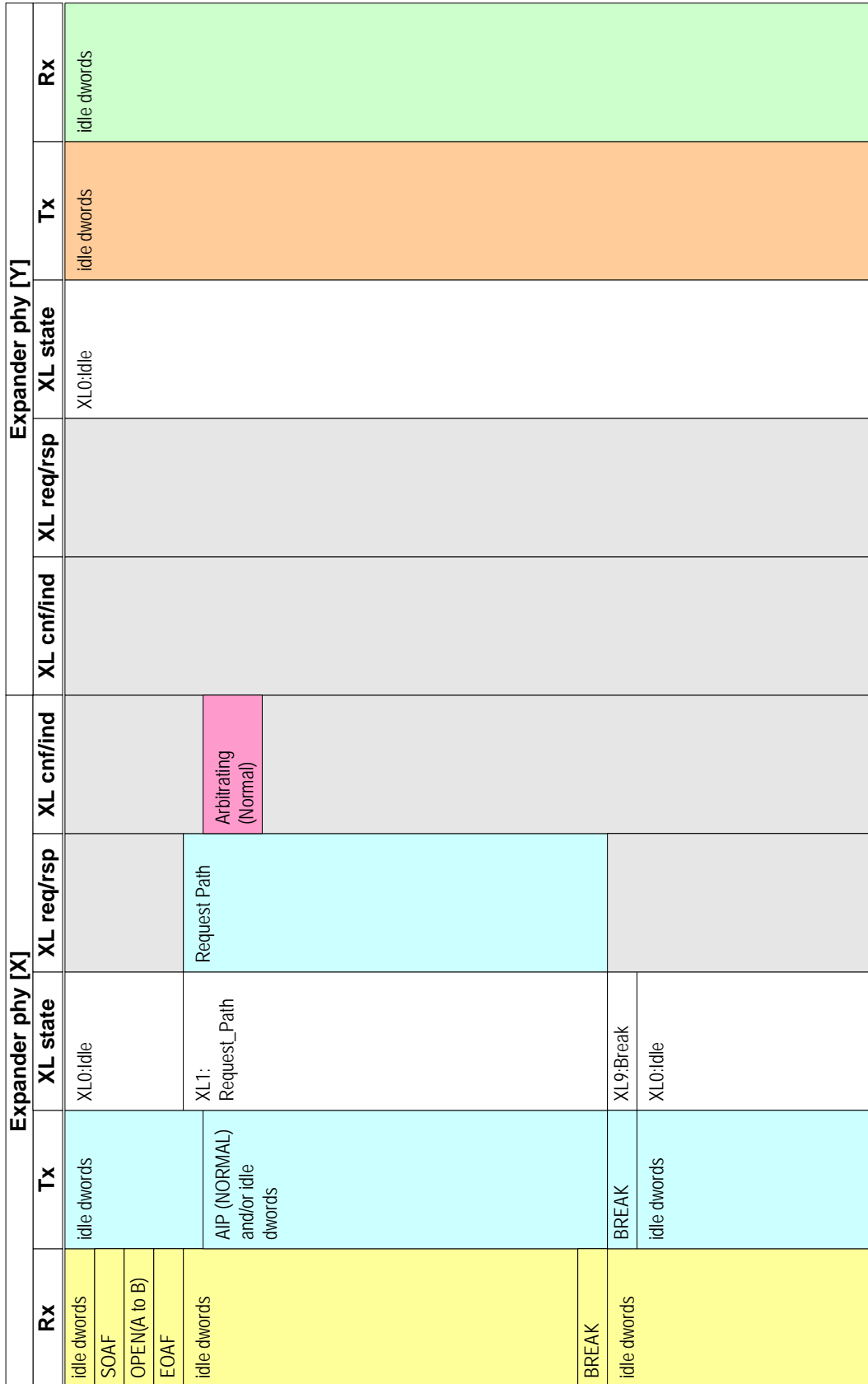

Figure J.10 — BREAK handling during path arbitration when the BREAK_REPLY method is disabled

This page contains no comments

J.11 BREAK handling during connection when the BREAK_REPLY method is disabled

Figure J.11 shows an expander device responding to the reception of a BREAK during a connection when the BREAK_REPLY method of responding to BREAK primitive sequences is disabled (see 7.12.5).

Expander phy [X]			Expander phy [Y]				
Rx	Tx	XL state	XL req/rsp	XL cnf/find	XL state	Tx	Rx
connection dwords	connection dwords	XL7:Connected	Forward Dword (connection dwords)	Forward Dword (connection dwords)	XL7:Connected	connection dwords	connection dwords
	BREAK	XL10: Break_Wait	Forward Break	Forward Break	Forward Break	BREAK	
idle dwords	idle dwords	XL0:Idle			XL0:Idle	idle dwords	idle dwords

Figure J.11 — BREAK handling during a connection when the BREAK_REPLY method is disabled

This page contains no comments

J.12 BREAK handling during path arbitration when the BREAK_REPLY method is enabled

Figure J.10 shows an expander device responding to the reception of a BREAK during path arbitration when the BREAK_REPLY method of responding to BREAK primitive sequences is enabled (see 7.12.5).

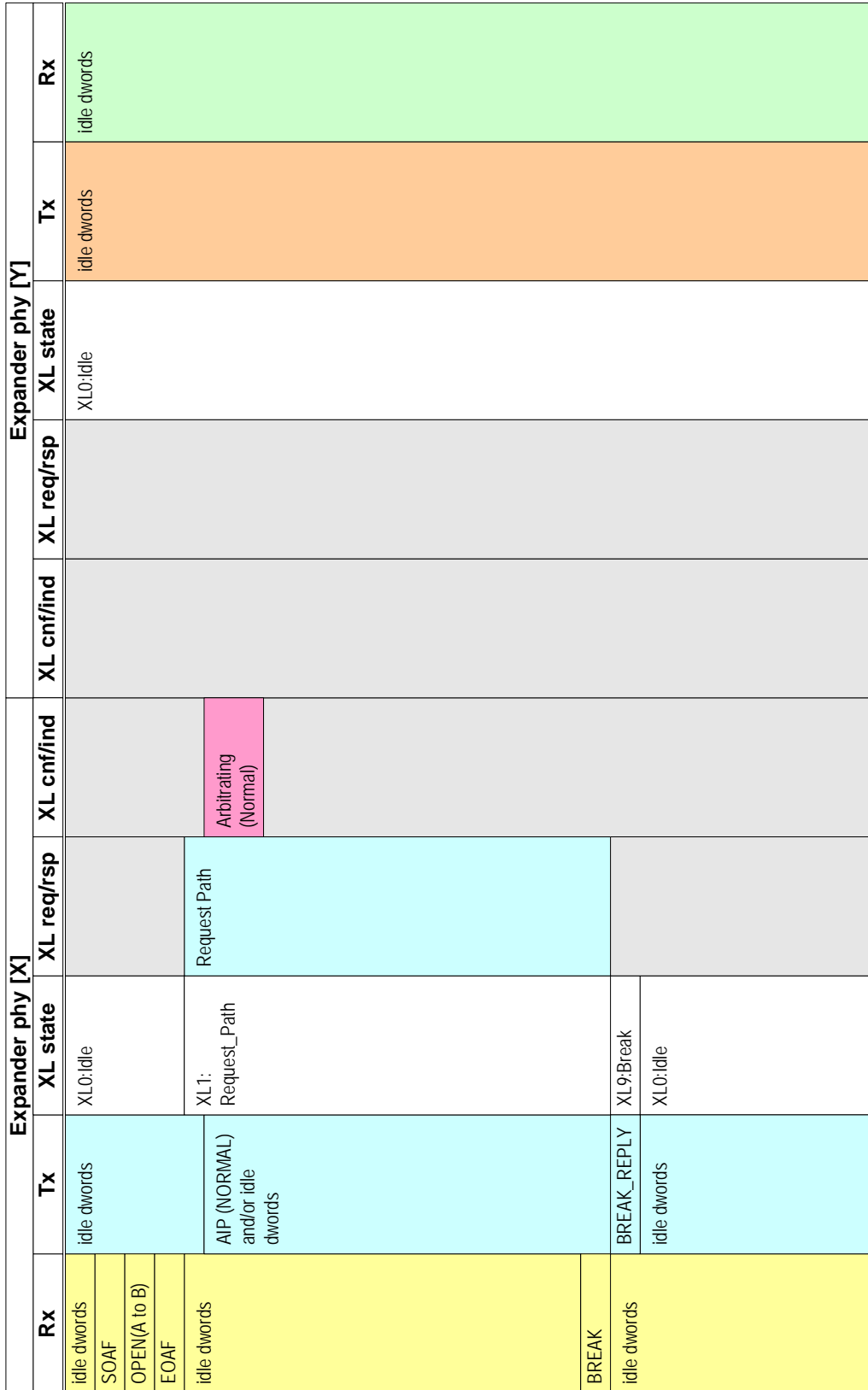

Figure J.12 — BREAK handling during path arbitration when the BREAK_REPLY method is enabled

This page contains no comments

J.13 BREAK handling during connection when BREAK_REPLY method is enabled

Figure J.11 shows an expander device responding to the reception of a BREAK during a connection when the BREAK_REPLY method of responding to BREAK primitive sequences is enabled (see 7.12.5).

		Expander phy [X]				Expander phy [Y]			
Rx	Tx	XL state	XL req/rsp	XL cnf/find	XL cnf/find	XL req/rsp	XL state	Tx	Rx
connection dwords	connection dwords	XL7:Connected	Forward Dword (connection dwords)	Forward Dword (connection dwords)	Forward Dword (connection dwords)	Forward Dword (connection dwords)	XL7:Connected	connection dwords	connection dwords
	BREAK		Forward Break	Forward Break	Forward Break	Forward Break		BREAK_REPLY	
BREAK_REPLY	idle dwords	XL10:Break_Wait					XL9:Break	idle dwords	idle dwords
idle dwords		XL0:Idle					XL0:Idle	idle dwords	

Figure J.13 — BREAK handling during a connection when the BREAK_REPLY method is enabled

This page contains no comments

J.14 STP connection - originated by STP initiator port

Figure J.14 shows an STP initiator port originating a connection to an STP target port in an STP/SATA bridge.

Expander phy [W] - STP target port in an STP/SATA bridge		Expander phy [Z] - SATA host port in an STP/SATA bridge						
Rx	Tx	XL state	XL req/rsp	XL cnf/ind	XL req/rsp	XL state	Tx	Rx
idle dwords	idle dwords	XL0:Idle					SYNC/CONT	SATA device dwords
SOAF								
OPEN (C to D)								
EOAF								
idle dwords	AIP (NORMAL) and/or idle dwords	XL1: Request_Path	Request Path	Arbitrating (Normal)				
		XL2: Request_Open	Forward Open	Arb Won				
		XL3: Open_Cnf_Wait	Forward Dword (idle dwords)		Forward Open			
	AIP (WAITING ON DEVICE)			Arb Status (Waiting On Device)	Forward Dword (idle dwords)	Arb Status (Waiting On Device)		
	idle dwords			Open Accept		Open Accept		
	OPEN_ACCEPT			Forward Dword (SATA device dwords ¹)		Forward Dword (SATA device dwords ¹)		
STP connection dwords	SATA device dwords ¹	XL7:Connected	Forward Dword (STP connection dwords)	Forward Dword (SATA device dwords)	Forward Dword (STP connection dwords)	Forward Dword (SATA device dwords)	STP connection dwords	
	SATA device dwords			Forward Dword (SATA device dwords)				

¹ STP/SATA bridge duplicates the dword stream which is being received from the SATA device before forwarding dwords - this ensures that a continued SATA primitive is correctly forwarded to the STP initiator port.

Figure J.14 — STP connection - originated by STP initiator port

This page contains no comments

J.15 STP connection - originated by STP target port in an STP/SATA bridge

Figure J.15 shows an STP target port in an STP/SATA bridge originating a connection on behalf of a SATA device which is requesting to transmit a frame.

Expander phy [W] - STP target port in an STP/SATA bridge		Expander phy [Z] - SATA host port in an STP/SATA bridge						
Rx	Tx	XL state	XL req/rsp	XL cnf/ind	XL req/rsp	XL state	Tx	Rx
idle dwords	idle dwords	XL0: Idle					SYNC/CONT	SYNC/CONT
SOAF	SOAF	XL5: Forward_Open		Arbitrating (Normal)	Request Path		STP connection dwords	SATA device dwords
OPEN (D to C)	OPEN (D to C)		Forward Open	Arb Won	Forward Open			
EOAF	EOAF		Forward Dword (idle dwords)		Forward Dword (idle dwords)			
idle dwords (forwarded or generated)	idle dwords (forwarded or generated)	XL6: Open_Rsp_Wait	Arb Status (Waiting On Device)	Forward Dword (SATA device dwords ^a)	Forward Dword (SATA device dwords ^a)			
OPEN_ACCEPT			Open Accept	Forward Dword (SATA device dwords)	Forward Dword (SATA device dwords)			
STP connection dwords	STP connection dwords	XL7: Connected	Transmit Dword (STP connection dwords)	Forward Dword (SATA device dwords ^a)	Forward Dword (SATA device dwords ^a)			
	SATA device dwords ^a			Forward Dword (SATA device dwords ^a)	Forward Dword (SATA device dwords ^a)			
	SATA device dwords			Forward Dword (SATA device dwords)	Forward Dword (SATA device dwords)			

^a STP/SATA bridge duplicates the dword stream which is being received from the SATA device before forwarding dwords. This ensures that a continued SATA primitive is correctly forwarded to the STP initiator port.

Figure J.15 — STP connection - originated by STP target port in an STP/SATA bridge

This page contains no comments

This page contains no comments

This page contains no comments

J.18 Connection request - XL1:Request_Path to XL5:Forward_Open transition

Figure J.18 shows the establishment of a connection following a XL1:Request_Path to XL5:Forward_Open transition by expander phy [Y].

Expander phy [X]		Expander phy [Y]						
Rx	Tx	XL state	XL req/rsp	XL cnf/ind	XL req/rsp	XL state	Tx	Rx
idle dwords	idle dwords	XL0:Idle				XL0:Idle	Idle dwords	Idle dwords
SOAF								SOAF
OPEN (A to B)								OPEN (B to A)
EOAF								EOAF
idle dwords	AIP (NORMAL) and/or idle dwords	XL1: Request_Path	Request Path	Arbitrating (Normal)	Request Path	XL1: Request_Path		idle dwords
				Arb Won				
		XL2: Request_Open	Forward Open		Forward Open	XL5: Forward_Open	SOAF	
		XL3: Open_Confirm_Wait	Forward Dword (idle dwords)		Forward Dword (idle dwords)		OPEN (A to B)	
	AIP (WAITING ON DEVICE)			Arb Status (Waiting on Device)	Arb Status (Waiting on Device)	XL6: Open_Response_Wait	Idle dwords (forwarded or generated)	
	idle dwords			Open Accept	Open Accept			OPEN_ACCEPT
	OPEN_ACCEPT			Forward Dword (connection dwords)	Forward Dword (connection dwords)	XL7:Connected	Idle dwords (forwarded)	connection dwords
connection dwords	connection dwords	XL7:Connected	Forward Dword (connection dwords)	Forward Dword (connection dwords)	Forward Dword (connection dwords)		connection dwords	

Figure J.18 — XL1:Request_Path to XL5:Forward_Open transition

This page contains no comments

J.19 Pathway blocked and pathway recovery example

Figure J.19 shows a topology used to illustrate pathway recovery. Exp[1] and Exp[2] are expander devices. A, B, and C are end devices. A attempts to open a connection to B while B attempts to open a connection to A.

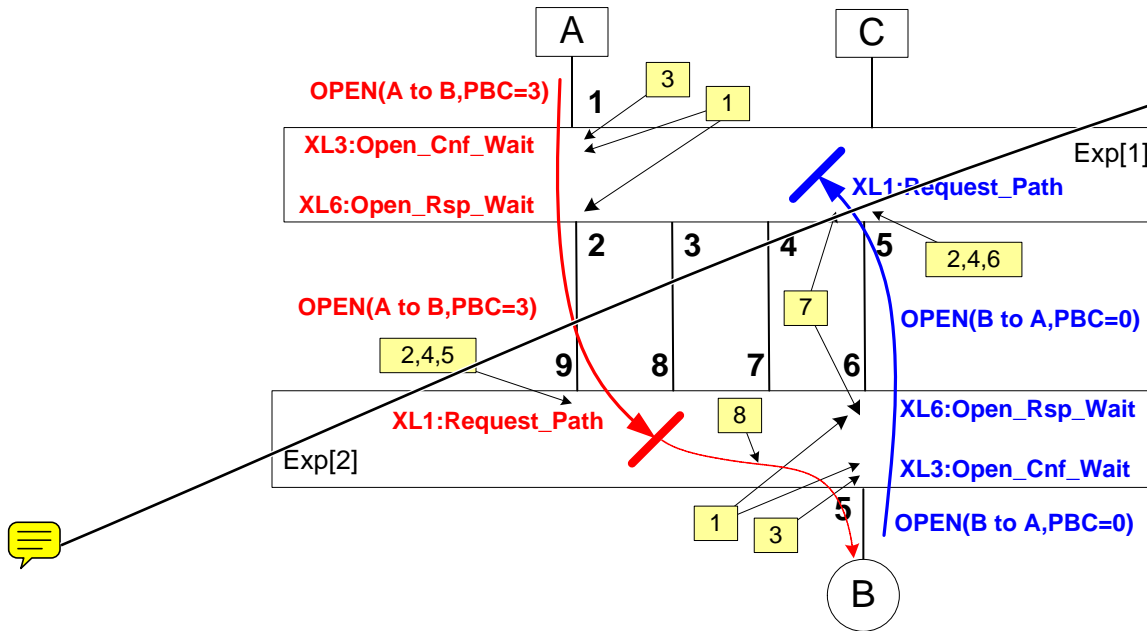



Figure J.19 — Partial pathway recovery

The sequence of events used to identify pathway blockage and to perform pathway recovery are as follows:

- 1) Exp[1].Phy[1,2] and Exp[2].Phy[5,6] each send Phy Status (Partial Pathway) responses to the ECM to indicate that they contain partial pathways;
- 2) Exp[1].Phy[5] and Exp[2].Phy[9] each receive Arbitrating (Waiting On Partial) confirmations from the ECM which cause them to transmit AIP (WAITING ON PARTIAL);
- 3) AIP (WAITING ON PARTIAL) is received by Exp[1].Phy[2] and Exp[2].Phy[6] then forwarded to Exp[1].Phy[1] and Exp[2].Phy[5] as an Arb Status (Waiting On Partial) confirmation. Exp[1].Phy[1] and Exp[2].Phy[5] each send Phy Status (Blocked On Partial) responses to ECM as confirmation that they are blocked waiting on a partial pathway in another expander device;
- 4) Exp[1].Phy[5] and Exp[2].Phy[9] each receive Arbitrating (Blocked On Partial) confirmations from the ECM while all destination phys send Phy Status (Blocked On Partial) responses which cause them to run their Partial Pathway Timeout timers;
- 5) The Partial Pathway Timeout timer expires in Exp[2].Phy[9]. This causes a request to the ECM to resolve pathway blockage. The pathway recovery priority for this phy is not lower than all phys within the destination port which are also blocked (i.e., the Request Path from Exp[2].Phy[9] has higher priority than the Request Path from Exp[2].Phy[5], which is receiving Arbitrating (Blocked On Partial)). The ECM does not provide an Arb Reject (Pathway Blocked) confirmation to Exp[2].Phy[9], so this expander phy waits for pathway resolution to occur elsewhere in the topology;
- 6) the Partial Pathway Timeout timer expires in Exp[1].Phy[5]. This causes a request to the ECM to resolve pathway blockage. The pathway recovery priority for this expander phy is lower than all expander phys within the destination port which are also blocked (i.e., the Request Path from Exp[1].Phy[5] is lower priority than the Request Path from Exp[1].Phy[5], which is receiving Arbitrating (Blocked On Partial)). The ECM provides an Arb Reject (Pathway Blocked) confirmation to Exp[1].Phy[5] which instructs this expander phy to reject the connection request using OPEN_REJECT (PATHWAY BLOCKED);

NOTE 128 - The Partial Pathway Timeout timer in Exp[1].Phy[5] might expire before, after, or at the same time the Partial Pathway Timeout timer expires in Exp[2].Phy[9].

● Author: RElliott
Subject: Note
Date: 7/9/2008 10:09:57 AM
 ACCEPT - DONE

Add Key:
Exp = expander
PBC = pathway blocked count

(from Ralph Weber, ENDL)

● Author: wdc-mevans
Subject: Highlight
Date: 5/23/2008 2:10:50 PM
 REJECT (not trying to grant permission here.)

might
s/b
may

- 7) OPEN_REJECT (PATHWAY BLOCKED) tears down partial pathway all the way to the originating end device (Device B);
- 8) Exp[2].Phy[9] receives Arb Won and the partial pathway is extended through Exp[2].Phy[5]; and
- 9) OPEN (A to B) is delivered to device B.

This page contains no comments

Annex K

(informative)

Primitive encoding

Table K.1 describes a set of the K28.5-based primitive encodings whose 40-bit values (after 8b10b encoding with either starting running disparity) have a Hamming distance (i.e., the number of bits different in two patterns) of at least 8. All the primitive encodings in 7.2 except for TRAIN and TRAIN_DONE were selected from this list. Unassigned encodings may be used by future versions of this standard.

Table K.1 — Primitives with Hamming distance of 8 (part 1 of 3)

Character				Assignment
1 st	2 nd	3 rd	4 th	
K28.5	D01.3	D01.3	D01.3	ALIGN (2)
K28.5	D01.4	D01.4	D01.4	ACK
K28.5	D01.4	D02.0	D31.4	RRDY (RESERVED 0)
K28.5	D01.4	D04.7	D24.0	NAK (RESERVED 1)
K28.5	D01.4	D07.3	D30.0	CREDIT_BLOCKED
K28.5	D01.4	D16.7	D07.3	NAK (RESERVED 2)
K28.5	D01.4	D24.0	D16.7	RRDY (NORMAL)
K28.5	D01.4	D27.4	D04.7	NAK (CRC ERROR)
K28.5	D01.4	D30.0	D02.0	RRDY (RESERVED 1)
K28.5	D01.4	D31.4	D29.7	NAK (RESERVED 0)
K28.5	D02.0	D01.4	D29.7	ERROR
K28.5	D02.0	D02.0	D02.0	HARD_RESET
K28.5	D02.0	D04.7	D01.4	CLOSE (RESERVED 1)
K28.5	D02.0	D07.3	D04.7	CLOSE (CLEAR AFFILIATION)
K28.5	D02.0	D16.7	D31.4	MUX (LOGICAL LINK 0)
K28.5	D02.0	D24.0	D07.3	BREAK
K28.5	D02.0	D29.7	D16.7	BREAK_REPLY
K28.5	D02.0	D30.0	D27.4	CLOSE (NORMAL)
K28.5	D02.0	D31.4	D30.0	CLOSE (RESERVED 0)
K28.5	D04.7	D01.4	D24.0	BROADCAST (EXPANDER)
K28.5	D04.7	D02.0	D01.4	BROADCAST (CHANGE)
K28.5	D04.7	D04.7	D04.7	BROADCAST (ASYNCHRONOUS EVENT)
K28.5	D04.7	D07.3	D29.7	BROADCAST (SES)
K28.5	D04.7	D16.7	D02.0	BROADCAST (RESERVED 3)
K28.5	D04.7	D24.0	D31.4	BROADCAST (RESERVED CHANGE 0)
K28.5	D04.7	D27.4	D07.3	BROADCAST (RESERVED CHANGE 1)
K28.5	D04.7	D29.7	D30.0	BROADCAST (RESERVED 4)
K28.5	D04.7	D31.4	D27.4	MUX (LOGICAL LINK 1)
K28.5	D07.0	D07.0	D07.0	ALIGN (1)
K28.5	D07.3	D01.4	D31.4	
K28.5	D07.3	D02.0	D04.7	

● Author: Isi-gpenokie
Subject: Highlight
Date: 5/6/2008 4:07:50 PM
T REJECT

This << of at least 8. >> should be << of at least eight. >>

● Author: Isi-gpenokie
Subject: Highlight
Date: 5/6/2008 4:07:50 PM
T REJECT

This << distance of 8 >> should be << distance of eight >>

Table K.1 — Primitives with Hamming distance of 8 (part 2 of 3)

Character				Assignment
1 st	2 nd	3 rd	4 th	
K28.5	D07.3	D04.7	D30.0	
K28.5	D07.3	D07.3	D07.3	
K28.5	D07.3	D24.0	D29.7	
K28.5	D07.3	D27.4	D16.7	
K28.5	D07.3	D29.7	D27.4	
K28.5	D07.3	D30.0	D24.0	
K28.5	D07.3	D31.4	D02.0	
K28.5	D10.2	D10.2	D27.3	ALIGN (0)
K28.5	D16.7	D01.4	D02.0	
K28.5	D16.7	D02.0	D07.3	
K28.5	D16.7	D04.7	D31.4	
K28.5	D16.7	D16.7	D16.7	OPEN_ACCEPT
K28.5	D16.7	D24.0	D27.4	
K28.5	D16.7	D27.4	D30.0	
K28.5	D16.7	D29.7	D24.0	
K28.5	D16.7	D30.0	D04.7	
K28.5	D16.7	D31.4	D01.4	
K28.5	D24.0	D01.4	D16.7	
K28.5	D24.0	D02.0	D29.7	
K28.5	D24.0	D04.7	D07.3	SOF
K28.5	D24.0	D07.3	D31.4	EOAF
K28.5	D24.0	D16.7	D27.4	EOF
K28.5	D24.0	D24.0	D24.0	
K28.5	D24.0	D27.4	D02.0	
K28.5	D24.0	D29.7	D04.7	
K28.5	D24.0	D30.0	D01.4	SOAF
K28.5	D27.3	D27.3	D27.3	ALIGN (3)
K28.5	D27.4	D01.4	D07.3	AIP (RESERVED WAITING ON PARTIAL)
K28.5	D27.4	D04.7	D02.0	
K28.5	D27.4	D07.3	D24.0	AIP (WAITING ON CONNECTION)
K28.5	D27.4	D16.7	D30.0	AIP (RESERVED 1)
K28.5	D27.4	D24.0	D04.7	AIP (WAITING ON PARTIAL)
K28.5	D27.4	D27.4	D27.4	AIP (NORMAL)
K28.5	D27.4	D29.7	D01.4	AIP (RESERVED 2)
K28.5	D27.4	D30.0	D29.7	AIP (WAITING ON DEVICE)
K28.5	D27.4	D31.4	D16.7	AIP (RESERVED 0)
K28.5	D29.7	D02.0	D30.0	OPEN_REJECT (RESERVED CONTINUE 0)
K28.5	D29.7	D04.7	D27.4	OPEN_REJECT (RESERVED STOP 1)
K28.5	D29.7	D07.3	D16.7	OPEN_REJECT (RESERVED INITIALIZE 1)

This page contains no comments

Table K.1 — Primitives with Hamming distance of 8 (part 3 of 3)

Character				Assignment
1 st	2 nd	3 rd	4 th	
K28.5	D29.7	D16.7	D04.7	OPEN_REJECT (PATHWAY BLOCKED)
K28.5	D29.7	D24.0	D01.4	OPEN_REJECT (RESERVED CONTINUE 1)
K28.5	D29.7	D27.4	D24.0	OPEN_REJECT (RETRY)
K28.5	D29.7	D29.7	D29.7	OPEN_REJECT (NO DESTINATION)
K28.5	D29.7	D30.0	D31.4	OPEN_REJECT (RESERVED INITIALIZE 0)
K28.5	D29.7	D31.4	D07.3	OPEN_REJECT (RESERVED STOP 0)
K28.5	D30.0	D01.4	D04.7	DONE (ACK/NAK TIMEOUT)
K28.5	D30.0	D02.0	D16.7	
K28.5	D30.0	D07.3	D27.4	DONE (CREDIT TIMEOUT)
K28.5	D30.0	D16.7	D01.4	DONE (RESERVED 0)
K28.5	D30.0	D24.0	D02.0	
K28.5	D30.0	D27.4	D29.7	DONE (RESERVED TIMEOUT 0)
K28.5	D30.0	D29.7	D31.4	DONE (RESERVED 1)
K28.5	D30.0	D30.0	D30.0	DONE (NORMAL)
K28.5	D30.0	D31.4	D24.0	DONE (RESERVED TIMEOUT 1)
K28.5	D31.3	D01.3	D07.0	NOTIFY (RESERVED 1)
K28.5	D31.3	D07.0	D01.3	NOTIFY (POWER LOSS EXPECTED)
K28.5	D31.3	D10.2	D10.2	NOTIFY (RESERVED 2)
K28.5	D31.3	D31.3	D31.3	NOTIFY (ENABLE SPINUP)
K28.5	D31.4	D01.4	D30.0	OPEN_REJECT (RESERVED ABANDON 3)
K28.5	D31.4	D02.0	D27.4	OPEN_REJECT (ZONE VIOLATION)
K28.5	D31.4	D04.7	D29.7	OPEN_REJECT (CONNECTION RATE NOT SUPPORTED)
K28.5	D31.4	D07.3	D02.0	OPEN_REJECT (RESERVED ABANDON 2)
K28.5	D31.4	D16.7	D24.0	OPEN_REJECT (WRONG DESTINATION)
K28.5	D31.4	D27.4	D01.4	OPEN_REJECT (STP RESOURCES BUSY)
K28.5	D31.4	D29.7	D07.3	OPEN_REJECT (PROTOCOL NOT SUPPORTED)
K28.5	D31.4	D30.0	D16.7	OPEN_REJECT (RESERVED ABANDON 1)
K28.5	D31.4	D31.4	D31.4	OPEN_REJECT (BAD DESTINATION)

Table K.2 describes the K28.5-based primitive encodings that do not have Hamming distances of 8 from the other primitives.

Table K.2 — Primitives without Hamming distance of 8

Character				Assignment
1 st	2 nd	3 rd	4 th	
K28.5	D30.3	D30.3	D30.3	TRAIN
K28.5	D30.3	D30.3	D10.2	TRAIN_DONE

Author: Isi-gpenokie
Subject: Highlight
Date: 5/6/2008 4:07:50 PM

T REJECT

This << distances of 8 from the >> should be << distances of eight from the >>

Annex L (informative)

Discover process example implementation

L.1 Discover process example implementation overview

This annex includes a C program implementing the discover process. Table L.1 describes the source files.

Table L.1 — C program files

Filename	Description
SASDiscoverSimulation.h	header file
SASDiscoverSimulation.cpp	C source file

L.2 Header file

The following is the C header file for the discover process.

```
// SASDiscoverSimulation.h
// updated 2005/05/29

// assume the maximum number of phys in an expander device is 128
#define MAXIMUM_EXPANDER_PHYS 128

// assume the maximum number of indexes per phy is 128
#define MAXIMUM_EXPANDER_INDEXES 128

// limit to 8 initiators for this example
#define MAXIMUM_INITIATORS 8

// defines for address frame types
#define ADDRESS_IDENTIFY_FRAME 0x00
#define ADDRESS_OPEN_FRAME 0x01

// defines for SMP frame types
#define SMP_REQUEST_FRAME 0x40
#define SMP_RESPONSE_FRAME 0x41

// defines for SMP request functions
#define REPORT_GENERAL 0x00
#define REPORT_MANUFACTURER_INFORMATION 0x01
#define DISCOVER 0x10
#define REPORT_PHY_ERROR_LOG 0x11
#define REPORT_PHY_SATA 0x12
#define REPORT_ROUTE_INFORMATION 0x13
#define CONFIGURE_ROUTE_INFORMATION 0x90
#define PHY_CONTROL 0x91
#define PHY_TEST 0x92

// defines for the protocol bits
#define SATA 0x01
#define SMP 0x02
#define STP 0x04
#define SSP 0x08
```

Page: 740

● Author: hpq-relliott
Subject: Note
Date: 9/2/2008 7:46:18 PM
 ACCEPT - DONE

Changes to the .h and .cpp code are necessary to remove edge/fanout and edge expander device set handling. Delete "edge" and "fanout" from commands. Replace "edge expander device set" with a term for all the expanders beyond an S-S link. Otherwise, code should work as is.

● Author: RElliott
Subject: Highlight
Date: 6/30/2008 6:16:52 PM
 ACCEPT - DONE (deleted the number from the comment)

128
s/b
256

per lsi-bbesmer comment on figure 10

● Author: RElliott
Subject: Highlight
Date: 6/30/2008 6:16:52 PM
 ACCEPT - DONE

128
s/b
256

per lsi-bbesmer comment on figure 10

● Author: RElliott
Subject: Highlight
Date: 6/30/2008 6:16:52 PM
 ACCEPT - DONE (deleted the number from the comment)

128
s/b
256

per lsi-bbesmer comment on figure 10

● Author: RElliott
Subject: Highlight
Date: 6/30/2008 6:16:52 PM
 ACCEPT - DONE

128
s/b
256

per lsi-bbesmer comment on figure 10

```

// defines for open responses, arbitrary values, not defined in the spec
#define OPEN_ACCEPT 0
#define OPEN_REJECT_BAD_DESTINATION 1
#define OPEN_REJECT_RATE_NOT_SUPPORTED 2
#define OPEN_REJECT_NO_DESTINATION 3
#define OPEN_REJECT_PATHWAY_BLOCKED 4
#define OPEN_REJECT_PROTOCOL_NOT_SUPPORTED 5
#define OPEN_REJECT_RESERVE_ABANDON 6
#define OPEN_REJECT_RESERVE_CONTINUE 7
#define OPEN_REJECT_RESERVE_INITIALIZE 8
#define OPEN_REJECT_RESERVE_STOP 9
#define OPEN_REJECT_RETRY 10
#define OPEN_REJECT_STP_RESOURCES_BUSY 11
#define OPEN_REJECT_WRONG_DESTINATION 12
#define OPEN_REJECT_WAITING_ON_BREAK 13

// definitions for discovery algorithm use
enum
{
    SAS_SIMPLE_LEVEL_DESCENT = 0,
    SAS_UNIQUE_LEVEL_DESCENT
};

enum
{
    SAS_10_COMPATIBLE = 0,
    SAS_11_COMPATIBLE
};

// definitions for SMP function results
enum SMPFunctionResult
{
    SMP_REQUEST_ACCEPTED = 0, // from original example

    SMP_FUNCTION_ACCEPTED = 0,
    SMP_UNKNOWN_FUNCTION,
    SMP_FUNCTION_FAILED,
    SMP_INVALID_REQUEST_FRAME_LENGTH,
    SMP_PHY_DOES_NOT_EXIST = 0x10,
    SMP_INDEX_DOES_NOT_EXIST,
    SMP_PHY_DOES_NOT_SUPPORT_SATA,
    SMP_UNKNOWN_PHY_OPERATION,
    SMP_UNKNOWN_PHY_TEST_FUNCTION,
    SMP_UNKNOWN_PHY_TEST_FUNCTION_IN_PROGRESS,
    SMP_PHY_VACANT
};

// DeviceTypes
enum DeviceTypes
{
    NO_DEVICE = 0,
    END_DEVICE,
    EDGE_EXPANDER_DEVICE,
    FANOUT_EXPANDER_DEVICE,

    END = END_DEVICE, // from original example
    EDGE = EDGE_EXPANDER_DEVICE, // from original example
};

```

This page contains no comments

```
FANOUT = FANOUT_EXPANDER_DEVICE    // from original example
};

// RoutingAttribute
enum RoutingAttribute
{
    DIRECT = 0,
    SUBTRACTIVE,
    TABLE,

    // this attribute is a psuedo attribute, used to reflect the function
    // result of SMP_PHY_VACANT in a fabricated discover response
    PHY_NOT_USED = 15
};

// ConnectorType
enum ConnectorType
{
    UNKNOWN_CONNECTOR = 0,
    SFF_8470_EXTERNAL_WIDE,
    SFF_8484_INTERNAL_WIDE = 16,
    SFF_8482_BACKPLANE = 32,
    SATA_HOST_PLUG,
    SAS_DEVICE_PLUG,
    SATA_DEVICE_PLUG
};

// RouteFlag
enum DisableRouteEntry
{
    ENABLED = 0,
    DISABLED
};

// PhyLinkRate(s)
enum PhysicalLinkRate
{
    RATE_UNKNOWN = 0,
    PHY_DISABLED,
    PHY_FAILED,
    SPINUP_HOLD_OOB,
    PORT_SELECTOR_DETECTED,

    // this is a psuedo link rate, used to reflect the function
    // result of SMP_PHY_VACANT in a fabricated discover response
    PHY_DOES_NOT_EXIST,

    GBPS_1_5 = 8,
    GBPS_3_0
};

// PhyOperation
enum PhyOperation
{
    NOP = 0,
    LINK_RESET,
    HARD_RESET,
```

This page contains no comments

```

    DISABLE,
    CLEAR_ERROR_LOG = 5,
    CLEAR_AFFILIATION,
    TRANSMIT_SATA_PORT_SELECTION_SIGNAL
};

// provide the simple type definitions
typedef unsigned char byte;
typedef unsigned short word;
typedef unsigned long dword;
typedef unsigned _int64 quadword;

// the structures assume a char bitfield is valid, this is compiler
// dependent defines would be more portable, but less descriptive

// the Identify frame is exchanged following OOB, for this
// code it contains the identity information for the attached device
// and the initiator application client
struct Identify
{
    // byte 0
    byte AddressFrameType:4;           // ADDRESS_IDENTIFY_FRAME
    byte DeviceType:3;                // END_DEVICE
    //
    byte RestrictedByte0Bit7:1;

    // byte 1
    byte RestrictedByte1;

    // byte 2
    union
    {
        struct
        {
            byte RestrictedByte2Bit0:1;
            byte SMPInitiatorPort:1;
            byte STPInitiatorPort:1;
            byte SSPInitiatorPort:1;
            byte ReservedByte2Bit4_7:4;
        };
        byte InitiatorBits;
    };

    // byte 3
    union
    {
        struct
        {
            byte RestrictedByte3Bit0:1;
            byte SMPTargetPort:1;
            byte STPTargetPort:1;
            byte SSPTargetPort:1;
            byte ReservedByte3Bit4_7:4;
        };
        byte TargetBits;
    };
};

```

This page contains no comments

```

// byte 4-11
byte RestrictedByte4_11[8];

// byte 12-19
quadword SASAddress;

// byte 20
byte PhyIdentifier;

// byte 21-27
byte ReservedByte21_27[4];

// byte 28-31
dword CRC;
}; // struct Identify

// the Open address frame is used to send open requests
struct OpenAddress
{
// byte 0
byte AddressFrameType:4;           // ADDRESS_OPEN_FRAME
byte Protocol:3;                   // SMP
                                   // STP
                                   // SSP

byte InitiatorPort:1;

// byte 1
byte ConnectionRate:4;             // GBPS_1_5
                                   // GBPS_3_0

byte Features:4;

// byte 2-3
word InitiatorConnectionTag;

// byte 4-11
quadword DestinationSASAddress;

// byte 12-19
quadword SourceSASAddress;

// byte 20
byte CompatibleFeatures;

// byte 21
byte PathwayBlockedCount;

// byte 22-23
word ArbitrationWaitTime;

// byte 24-27
byte MoreCompatibleFeatures[4];

// byte 28-31
dword CRC[4];
}; // struct OpenAddress

// request specific bytes for a general input function

```

This page contains no comments

```

struct SMPRequestGeneralInput
{
    // byte 4-7
    dword CRC;
};

// request specific bytes for a phy input function
struct SMPRequestPhyInput
{
    // byte 4-7
    byte IgnoredByte4_7[4];

    // byte 8
    byte ReservedByte8;

    // byte 9
    byte PhyIdentifier;

    // byte 10
    byte IgnoredByte10;

    // byte 11
    byte ReservedByte11;

    // byte 12-15
    dword CRC;
}; // struct SMPRequestPhyInput

// the ConfigureRouteInformation structure is used to provide the
// expander route entry for the expander route table, it is intended
// to be referenced by the SMPRequestConfigureRouteInformation struct
struct ConfigureRouteInformation
{
    // byte 12
    byte IgnoredByte12Bit0_6:7;
    byte DisableRouteEntry:1; // if a routing error is detected
                             // then the route is disabled by
                             // setting this bit

    // byte 13-15
    byte IgnoredByte13_15[3];

    // byte 16-23
    quadword RoutedSASAddress; // identical to the AttachedSASAddress
                              // found through discovery

    // byte 24-35
    byte IgnoredByte24_35[12];

    // byte 36-39
    byte ReservedByte36_39[4];
}; // struct ConfigureRouteInformation

// request specific bytes for SMP ConfigureRouteInformation function
struct SMPRequestConfigureRouteInformation
{
    // byte 4-5

```

This page contains no comments

```

byte ReservedByte4_5[2];

// byte 6-7
word ExpanderRouteIndex;

// byte 8
byte ReservedByte8;

// byte 9
byte PhyIdentifier;

// byte 10-11
byte ReservedByte10_11[2];

// byte 12-39
struct ConfigureRouteInformation Configure;

// byte 40-43
dword CRC;
}; // struct SMPRequestConfigureRouteInformation

// the PhyControlInformation structure is used to provide the
// expander phy control values, it is intended
// to be referenced by the SMPRequestPhyControl struct
struct PhyControlInformation
{
// byte 12-31
byte IgnoredByte12_31[20];

// byte 32
byte IgnoredByte32Bit0_3:4;
byte ProgrammedMinimumPhysicalLinkRate:4;

// byte 33
byte IgnoredByte33Bit0_3:4;
byte ProgrammedMaximumPhysicalLinkRate:4;

// byte 34-35
byte IgnoredByte34_35[2];

// byte 36
byte PartialPathwayTimeoutValue:4;
byte ReservedByte36Bit4_7:4;

// byte 37-39
byte ReservedByte37_39[3];
}; // struct PhyControlInformation

// request specific bytes for SMP Phy Control function
struct SMPRequestPhyControl
{
// byte 4-7
byte IgnoredByte4_7[4];

// byte 8
byte ReservedByte8;

```

This page contains no comments

```

    // byte 9
    byte PhyIdentifier;

    // byte 10
    byte PhyOperation;

    // byte 11
    byte UpdatePartialPathwayTimeoutValue:1;
    byte ReservedByte11Bit1_7:7;

    // byte 12-39
    struct PhyControlInformation Control;

    // byte 40-43
    dword CRC;
}; // struct SMPRequestPhyControl

// request specific bytes for SMP Phy Test function
struct SMPRequestPhyTest
{
    // byte 4-7
    byte IgnoredByte4_7[4];

    // byte 8
    byte ReservedByte8;

    // byte 9
    byte PhyIdentifier;

    // byte 10
    byte PhyTestFunction;

    // byte 11
    byte PhyTestPattern;

    // byte 12-14
    byte ReservedByte12_14[3];

    // byte 15
    byte PhyTestPatternPhysicalLinkRate:4;
    byte ReservedByte15Bit4_7:4;

    // byte 16-39
    byte ReservedByte16_39[24];

    // byte 40-43
    dword CRC;
}; // struct SMPRequestPhyTest

// generic structure referencing an SMP Request, must be initialized
// before being used
struct SMPRequest
{
    // byte 0
    byte SMPFrameType; // always SMP_REQUEST_FRAME

    // byte 1

```

This page contains no comments

```

byte Function; // REPORT_GENERAL
                // REPORT_MANUFACTURER_INFORMATION
                // DISCOVER
                // REPORT_PHY_ERROR_LOG
                // REPORT_PHY_SATA
                // REPORT_ROUTE_INFORMATION
                // CONFIGURE_ROUTE_INFORMATION
                // PHY_CONTROL
                // PHY_TEST

// byte 2-3
byte ReservedByte2_3[2];

// bytes 4-n
union
{
    struct SMPRequestGeneralInput ReportGeneral;
    struct SMPRequestGeneralInput ReportManufacturerInformation;
    struct SMPRequestPhyInput Discover;
    struct SMPRequestPhyInput ReportPhyErrorLog;
    struct SMPRequestPhyInput ReportPhySATA;
    struct SMPRequestPhyInput ReportRouteInformation;
    struct SMPRequestConfigureRouteInformation ConfigureRouteInformation;
    struct SMPRequestPhyControl PhyControl;
    struct SMPRequestPhyTest PhyTest;
} Request;
}; // struct SMPRequest

// request specific bytes for SMP Report General response, intended to be
// referenced by SMPResponse
struct SMPResponseReportGeneral
{
    // byte 4-5
    word ExpanderChangeCount;

    // byte 6-7
    word ExpanderRouteIndexes;

    // byte 8
    byte ReservedByte8;

    // byte 9
    byte NumberOfPhys;

    // byte 10
    byte ConfigurableRouteTable:1;
    byte Configuring:1;
    byte ReservedByte10Bit2_7:6;

    // byte 11
    byte ReservedByte11;

    // byte 12-19
    byte EnclosureLogicalIdentifier[8];

    // byte 20-27
    byte ReservedByte20_27[8];

```

This page contains no comments

```

    // byte 28-31
    dword CRC;
}; // struct SMPResponseReportGeneral

struct SAS11FormatReportManufacturerInformation
{
    // byte 40-47
    byte ComponentVendorIdentification[8];

    // byte 48-49
    byte ComponentID[2];

    // byte 50
    byte ComponentRevisionID;

    // byte 51
    byte Reserved;

    // byte 52-59
    byte VendorSpecific[8];
}; // struct SAS11FormatReportManufacturerInformation

// request specific bytes for SMP Report Manufacturer Information response,
// intended to be referenced by SMPResponse
struct SMPResponseReportManufacturerInformation
{
    // byte 4-7
    byte IgnoredByte4_7[4];

    // byte 8
    byte SAS11Format:1;
    byte ReservedByte8_Bit1_7:7;

    // byte 9-10
    byte IgnoredByte9_10[2];

    // byte 11
    byte ReservedByte11;

    // byte 12-19
    byte VendorIdentification[8];

    // byte 20-35
    byte ProductIdentification[16];

    // byte 36-39
    byte ProductRevisionLevel[4];

    union
    {
        struct SAS11FormatReportManufacturerInformation SAS11;

        // byte 40-59
        byte VendorSpecific[20];
    };
};

```

This page contains no comments

```

    // byte 60-63
    dword CRC;
}; // struct SMPResponseReportManufacturerInformation

// the Discover structure is used to retrieve expander port information
// it is intended to be referenced by the SMPResponseDiscover structure
struct Discover
{
    // byte 12
    byte ReservedByte12Bit0_3:4;
    byte AttachedDeviceType:3;
    byte IgnoredByte12Bit7:1;

    // byte 13
    byte NegotiatedPhysicalLinkRate:4;
    byte ReservedByte13Bit4_7:4;

    // byte 14
    union
    {
        struct
        {
            byte AttachedSATAHost:1;
            byte AttachedSMPInitiator:1;
            byte AttachedSTPInitiator:1;
            byte AttachedSSPInitiator:1;
            byte ReservedByte14Bit4_7:4;
        };
        byte InitiatorBits;
    };

    // byte 15
    union
    {
        struct
        {
            byte AttachedSATADevice:1;
            byte AttachedSMPTarget:1;
            byte AttachedSTPTarget:1;
            byte AttachedSSPTarget:1;
            byte ReservedByte15Bit4_6:3;
            byte AttachedSATAPortSelector:1;
        };
        byte TargetBits;
    };

    // byte 16-23
    quadword SASAddress;

    // byte 24-31
    quadword AttachedSASAddress;

    // byte 32
    byte AttachedPhyIdentifier;

    // byte 33-39
    byte ReservedByte33_39[7];
};

```

This page contains no comments

```

// byte 40
byte HardwareMinimumPhysicalLinkRate:4;
byte ProgrammedMinimumPhysicalLinkRate:4;

// byte 41
byte HardwareMaximumPhysicalLinkRate:4;
byte ProgrammedMaximumPhysicalLinkRate:4;

// byte 42
byte PhyChangeCount;

// byte 43
byte PartialPathwayTimeoutValue:4;
byte IgnoredByte36Bit4_6:3;
byte VirtualPhy:1;

// byte 44
byte RoutingAttribute:4;
byte ReservedByte44Bit4_7:4;

// byte 45
byte ConnectorType:7;
byte ReservedByte45Bit7:1;

// byte 46
byte ConnectorElementIndex;

// byte 47
byte ConnectorPhysicalLink;

// byte 48-49
byte ReservedByte48_49[2];

// byte 50-51
byte VendorSpecific[2];

// byte 52-55
dword CRC;
}; // struct Discover

// response specific bytes for SMP Discover, intended to be referenced by
// SMPResponse
struct SMPResponseDiscover
{
// byte 4-7
byte IgnoredByte4_7;

// byte 8
byte ReservedByte8;

// byte 9
byte PhyIdentifier;

// byte 10
byte IgnoredByte10;

```

This page contains no comments

```

// byte 11
byte ReservedByte11;

union // original example used Results instead
      // of Result, this allows both
{
    // byte 12-55
    struct Discover Results;
    struct Discover Result;
};
}; // struct SMPResponseDiscover

// response specific bytes for SMP Report Phy Error Log, intended to be
// referenced by SMPResponse
struct SMPResponseReportPhyErrorLog
{
    // byte 4-7
    byte IgnoredByte4_7;

    // byte 8
    byte ReservedByte8;

    // byte 9
    byte PhyIdentifier;

    // byte 10
    byte IgnoredByte10;

    // byte 11
    byte ReservedByte11;

    // byte 12-15
    dword InvalidDwordCount;

    // byte 16-19
    dword DisparityErrorCount;

    // byte 20-23
    dword LossOfDwordSynchronizationCount;

    // byte 24-27
    dword PhyResetProblemCount;

    // byte 28-31
    dword CRC;
}; // struct SMPResponseReportPhyErrorLog

// this structure describes the Register Device to Host FIS defined in the
// SATA specification
struct RegisterDeviceToHostFIS
{
    // byte 24
    byte FISType;

    // byte 25
    byte ReservedByte25Bit0_5:6;
    byte Interrupt:1;
};

```

This page contains no comments

```
byte ReservedByte25Bit7:1;

// byte 26
byte Status;

// byte 27
byte Error;

// byte 28
byte SectorNumber;

// byte 29
byte CylLow;

// byte 30
byte CylHigh;

// byte 31
byte DevHead;

// byte 32
byte SectorNumberExp;

// byte 33
byte CylLowExp;

// byte 34
byte CylHighExp;

// byte 35
byte ReservedByte35;

// byte 36
byte SectorCount;

// byte 37
byte SectorCountExp;

// byte 38-43
byte ReservedByte38_43[6];
}; // struct RegisterDeviceToHostFIS

// response specific bytes for SMP Report Phy SATA, intended to be
// referenced by SMPResponse
struct SMPResponseReportPhySATA
{
    // byte 4-7
    byte IgnoredByte4_7;

    // byte 8
    byte ReservedByte8;

    // byte 9
    byte PhyIdentifier;

    // byte 10
    byte IgnoredByte10;
```

This page contains no comments

```

    // byte 11
    byte AffiliationValid:1;
    byte AffiliationsSupported:1;
    byte ReservedByte11Bit2_7:6;

    // byte 12-15
    byte ReservedByte12_15[4];

    // byte 16-32
    quadword STPSASAddress;

    // byte 24-43
    struct RegisterDeviceToHostFIS FIS;

    // byte 44-47
    byte ReservedByte44_47[4];

    // byte 48-55
    quadword AffiliatedSTPInitiatorSASAddress;

    // byte 56-59
    dword CRC;
}; // struct SMPResponseReportPhySATA

struct ReportRouteInformation
{
    // byte 12
    byte IgnoredByte12Bit0_6:7;
    byte ExpanderRouteEntryDisabled:1;

    // byte 13-15
    byte IgnoredByte13_15[3];

    // byte 16-23
    quadword RoutedSASAddress;

    // byte 24-35
    byte IgnoredByte24_35[12];

    // byte 36-39
    byte ReservedByte36_39[4];
}; // struct ReportRouteInformation

// response specific bytes for SMP Report Route Information, intended to be
// referenced by SMPResponse
struct SMPResponseReportRouteInformation
{
    // byte 4-5
    byte IgnoredByte4_5;

    // byte 6-7
    word ExpanderRouteIndex;

    // byte 8
    byte ReservedByte8;

```

This page contains no comments

```

    // byte 9
    byte PhyIdentifier;

    // byte 10
    byte IgnoredByte10;

    // byte 11
    byte ReservedByte11;

    // byte 12-39
    struct ReportRouteInformation Result;

    // byte 40-43
    dword CRC;
}; // struct SMPResponseReportRouteInformation

// response specific bytes for SMP Configure Route Information,
// intended to be referenced by SMPResponse
struct SMPResponseConfigureRouteInformation
{
    // byte 4-7
    dword CRC;
};

// response specific bytes for SMP Phy Control,
// intended to be referenced by SMPResponse
struct SMPResponsePhyControl
{
    // byte 4-7
    dword CRC;
};

// response specific bytes for SMP Phy Test,
// intended to be referenced by SMPResponse
struct SMPResponsePhyTest
{
    // byte 4-7
    dword CRC;
};

// generic structure referencing an SMP Response, must be initialized
// before being used
struct SMPResponse
{
    // byte 0
    byte SMPFrameType; // always 41h for SMP responses

    // byte 1
    byte Function;

    // byte 2
    byte FunctionResult;

    // byte 3
    byte ReservedByte3;

    // bytes 4-n

```

This page contains no comments

```

union
{
    struct SMPResponseReportGeneral ReportGeneral;
    struct SMPResponseReportManufacturerInformation
        ReportManufacturerInformation;
    struct SMPResponseDiscover Discover;
    struct SMPResponseReportPhyErrorLog ReportPhyErrorLog;
    struct SMPResponseReportPhySATA ReportPhySATA;
    struct SMPResponseReportRouteInformation ReportRouteInformation;
    struct SMPResponseConfigureRouteInformation ConfigureRouteInformation;
    struct SMPResponsePhyControl PhyControl;
    struct SMPResponsePhyTest PhyTest;
} Response;
}; // struct SMPResponse

// this structure is how this simulation obtains its knowledge about the
// initiator port that is doing the discover, it is not defined as part of
// the standard...
struct ApplicationClientKnowledge
{
    quadword SASAddress;
    byte NumberOfPhys;
    byte InitiatorBits;
    byte TargetBits;
};

// the RouteTableEntry structure is used to contain the internal copy of
// the expander route table
struct RouteTableEntry
{
    byte ExpanderRouteEntryDisabled;
    quadword RoutedSASAddress;
};

// the TopologyTable structure is the summary of the information gathered
// during the discover process, the table presented here is not concerned
// about memory resources consumed, production code would be more concerned
// about specifying necessary elements explicitly
struct TopologyTable
{
    // pointer to a simple list of expanders in topology
    // a walk thru this link will encounter all expanders in
    // discover order
    struct TopologyTable *Next;

    // simple reference to this device, primarily to keep identification of
    // this structure simple, otherwise, the only place the address is
    // located is within the Phy element
    quadword SASAddress;

    // information from REPORT_GENERAL
    struct SMPResponseReportGeneral Device;

    // information from DISCOVER
    struct SMPResponseDiscover Phy[MAXIMUM_EXPANDER_PHYS];

    // list of route indexes for each phy

```

This page contains no comments

```

word RouteIndex[MAXIMUM_EXPANDER_PHYS];

// internal copy of the route table for the expander
struct RouteTableEntry
    RouteTable[MAXIMUM_EXPANDER_PHYS][MAXIMUM_EXPANDER_INDEXES];

//
// in production code there would also be links to the necessary device
// information like end device; vendor, model, serial number, etc.
// the gathering of that type of information is not done here...
//
}; // struct TopologyTable

```

L.3 Source file

The following is the C source file for the discover process.

```

// SASDiscoverSimulation.cpp
// updated 2005/05/29
//
// This is a simple simulation and code implementation of the initiator
// based expander discovery and configuration.

// There is no attempt to handle phy errors, arbitration issues, etc.
// Production level implementation need to handle errors appropriately.

// Structure names used are equivalent to those referenced in the standard.

// Basic assumptions:
// 1. BROADCAST (CHANGE) primitives initiate rediscovery/reconfiguration
// 2. Table locations for SASAddresses are deterministic for a specific
//    topology only. When the topology changes, the location of a SASAddress
//    in an ASIC table cannot be assumed.
// 3. A complete discovery level occurs before the configuration of the
//    level begins. Multiple passes are required as the levels of expanders
//    encountered between the initiator and the end devices increases.
// 4. Configuration of a single expander occurs before proceeding to
//    subsequent attached expanders.
// 5. The Attached structure is filled in following OOB and is available
//    from the initialization routines.
// 6. The Iam structure is provide by the application client.

#include <malloc.h>
#include <memory.h>
#include <stdlib.h>

// include the SAS structures
#include "SASDiscoverSimulation.h"

// this defines the type of algorithm used for discover
int DiscoverAlgorithm = SAS_SIMPLE_LEVEL_DESCENT;
int SASCompatibility = SAS_11_COMPATIBLE;

// loaded by the application client, in this simulation it is provided
// in a text file, SASDeviceSetExample.ini
extern struct ApplicationClientKnowledge Iam[MAXIMUM_INITIATORS];

```

This page contains no comments

```

// obtained following OOB from the attached phy, in this simulation
// it is provided in a text file, SASDeviceSetExample.ini
extern struct Identify Attached[MAXIMUM_INITIATORS];

// buffers used to request and return SMP data
extern struct SMPRequest SMPRequestFrame;
extern struct SMPResponse SMPResponseFrame;

// resulting discover information ends up in this table
extern struct TopologyTable *SASDomain[MAXIMUM_INITIATORS];

// this is the function used to send an SMPRequest and get a response back
extern byte SMPRequest(byte PhyIdentifier,
                      quadword Source,
                      quadword Destination,
                      struct SMPRequest *SMPRequestFrame,
                      struct SMPResponse *SMPResponseFrame,
                      byte *OpenStatus,
                      byte Function,
                      ...);

// this function is used to output error information, it mimics fprintf
// functionality to an open trace file
extern int TracePrint(char *String, ...);

// this function gets the report general and discover information for
// a specific expander, the discover process begins at the subtractive
// boundary and progress downstream
static
struct TopologyTable *DiscoverExpander(byte PhyIdentifier,
                                       quadword SourceSASAddress,
                                       quadword DestinationSASAddress)
{
    struct TopologyTable *expander = 0;
    byte phyCount = 0;
    int error = 1;

    byte openStatus = OPEN_ACCEPT;

    // get the report general information for the expander
    SMPRequest(PhyIdentifier,
              SourceSASAddress,
              DestinationSASAddress,
              &SMPRequestFrame,
              &SMPResponseFrame,
              &openStatus,
              REPORT_GENERAL);

    // don't worry about too much in the 'else' case for this example,
    // production code needs to handle
    if((openStatus == OPEN_ACCEPT) &&
        (SMPResponseFrame.FunctionResult == SMP_FUNCTION_ACCEPTED))
    {
        if(SMPResponseFrame.Response.ReportGeneral.NumberOfPhys <=
            MAXIMUM_EXPANDER_PHYS)
        {

```

This page contains no comments

```

// allocate space to retrieve the expander information
expander = (struct TopologyTable *)
            calloc(1,
                  sizeof(struct TopologyTable));

// make sure we only do this if the allocation is successful
if(expander)
{
    // save the address of this expander
    expander->SASAddress = DestinationSASAddress;

    // copy the result into the topology table
    memcpy((void *)&(expander->Device),
           (void *)&SMPResponseFrame.Response.ReportGeneral,
           sizeof(struct SMPResponseReportGeneral));

    // now walk through all the phys of the expander
    for(phyCount = 0;
        (phyCount < expander->Device.NumberOfPhys);
        phyCount++)
    {
        // get the discover information for each phy
        SMPRequest(PhyIdentifier,
                  SourceSASAddress,
                  DestinationSASAddress,
                  &SMPRequestFrame,
                  &SMPResponseFrame,
                  &openStatus,
                  DISCOVER,
                  phyCount);

        // don't worry about the 'else' case for this example,
        // production code needs to handle
        if((openStatus == OPEN_ACCEPT) &&
           (SMPResponseFrame.FunctionResult == SMP_FUNCTION_ACCEPTED))
        {
            // clear the error flag
            error = 0;

            // copy the result into the topology table
            memcpy((void *)&(expander->Phy[phyCount]),
                   (void *)&SMPResponseFrame.Response.Discover,
                   sizeof(struct SMPResponseDiscover));
        }
        else if((openStatus == OPEN_ACCEPT) &&
                (SMPResponseFrame.FunctionResult == SMP_PHY_VACANT))
        {
            struct Discover *discover;

            discover = &SMPResponseFrame.Response.Discover.Result;

            // clear the error flag
            error = 0;

            // set the routing attribute and link rate to indicate that
            // the phy is not being used, this keeps it from being
            // included in the routing table information, these values

```

This page contains no comments

```

// are not defined in the spec at this time, but are listed
// as reserved values
discover->NegotiatedPhysicalLinkRate = PHY_DOES_NOT_EXIST;
discover->RoutingAttribute = PHY_NOT_USED;

// copy the result into the topology table
memcpy((void *)&(expander->Phy[phyCount]),
        (void *)&SMPResponseFrame.Response.Discover,
        sizeof(struct SMPResponseDiscover));
}
else
{
// if we had a problem on this link, then don't bother
// to do anything else, production code needs to be more
// robust...
// for this simulation example, the addresses are
// described as strings, so we can print them out...
// not true for production code...
TracePrint("\n"
           "discover error, %02Xh at %s\n",
           SMPResponseFrame.FunctionResult,
           (char *)&DestinationSASAddress);

// something happened so just bailout on this expander
error = 1;

// release the memory we allocated for this...
free(expander);
expander = 0;
break;
}
}
}
}
// the assumptions we made were exceeded, need to bump simulation
// limits...
else
{
TracePrint("\n"
           "report general error"
           ", NumberOfPhys %d exceeded limit %d on %s\n",
           expander->Device.NumberOfPhys,
           MAXIMUM_EXPANDER_PHYS,
           (char *)&DestinationSASAddress);
}
}
else
{
// if we had a problem getting report general for this expander,
// something is wrong, can't go any further down this path...
// production code needs to be more robust...
// for this simulation example, the addresses are
// described as strings, so we can print them out...
// not true for production code...
TracePrint("\n"
           "report general error, open %02Xh result %02Xh at %s\n",
           openStatus,

```

This page contains no comments

```

        SMPResponseFrame.FunctionResult,
        (char *)&DestinationSASAddress);
    }

    // the expander pointer is the error return, a null indicates something
    // bad happened...
    return(expander);
} // DiscoverExpander

// this routine searches upstream for the subtractive boundary that defines
// the edge expander device set
static
struct TopologyTable *FindBoundary(byte PhyIdentifier,
                                   quadword SourceSASAddress,
                                   struct TopologyTable *Expander,
                                   struct TopologyTable **DeviceSet)
{
    struct TopologyTable *expander = Expander;
    struct TopologyTable *nextExpander;

    struct Discover *discover;

    byte phyCount;

    int error = 0;
    int foundSubtractivePort = 0;

    quadword subtractiveSASAddress;
    byte attachedPhyIdentifier;

    // make sure the device set link is initialized
    *DeviceSet = 0;

    // outer loop searches for subtractive phys and finds the SAS addresses
    // connected to them, validates that the subtractive phys all resolve
    // to the same expander address, then moves upstream searching for the
    // edge expander device set boundary
    do
    {
        // initialize the subtractive address, a zero value is not valid
        subtractiveSASAddress = 0;
        attachedPhyIdentifier = 0;

        // walk through all the phys of this expander
        for(phyCount = 0;
            (phyCount < expander->Device.NumberOfPhys);
            phyCount++)
        {
            // this is just a pointer helper
            discover = &(expander->Phy[phyCount].Result);

            // look for phys with edge or fanout devices attached...
            if((discover->RoutingAttribute == SUBTRACTIVE) &&
                ((discover->AttachedDeviceType == EDGE_EXPANDER_DEVICE) ||
                 (discover->AttachedDeviceType == FANOUT_EXPANDER_DEVICE)))
            {
                // make sure all the subtractive phys point to the same address

```

This page contains no comments

```

// when we are connected to an expander device
if(!subtractiveSASAddress)
{
    subtractiveSASAddress = discover->AttachedSASAddress;
    attachedPhyIdentifier = discover->AttachedPhyIdentifier;
    foundSubtractivePort = 1;
}
// the addresses don't match... problem...
else if(subtractiveSASAddress !=
        discover->AttachedSASAddress)
{
    // production code needs to deal with this better, for this
    // example, the SASAddresses are assumed to strings
    // so just print out the error information
    TracePrint("\n"
               "topology error, diverging subtractive phys"
               ", '%s' != '%s' \n",
               (char *)&subtractiveSASAddress,
               (char *)&discover->AttachedSASAddress);
    error = 1;
    break;
}
}
}

// if no error, then decide if we need to go upstream or stop
if(!error)
{
    // if we have a subtractive address then go upstream to see
    // if it is part of the edge expander device set
    if(subtractiveSASAddress)
    {
        // get the discover information
        nextExpander = DiscoverExpander(PhyIdentifier,
                                       SourceSASAddress,
                                       subtractiveSASAddress);

        // if we successfully got the information from the next
        // expander then proceed upstream...
        if(nextExpander)
        {
            struct Discover *discover;

            // this is just a pointer helper
            discover = &(nextExpander->Phy[attachedPhyIdentifier].Result);

            // check to see if we are connected to the subtractive
            // port of the next expander, if we are then we have two
            // expander device sets connected together, stop here
            // and save the address of next expander in device set,
            // the return is expander
            if(discover->RoutingAttribute == SUBTRACTIVE)
            {
                *DeviceSet = nextExpander;
                break;
            }
            // go ahead and continue upstream looking for the boundary

```

This page contains no comments

```

        else
        {

            // release the memory we allocated for this
            free(expander);

            // move upstream to the next expander
            expander = nextExpander;
        }
    }
    // if there are no more upstream expanders stop here...
    else
    {
        break;
    }
}
// if we did not get a subtractive address this time around, stop
else
{
    // if we did find a subtractive port on a previous pass,
    // then return with expander pointing to the last device
    // with the subtractive port
    if(foundSubtractivePort)
    {
        break;
    }
    // if we never found a subtractive port, then return with a
    // null indicating there are no subtractive phys, don't free
    // the memory, because it is still in use by the calling routine
    else
    {
        expander = 0;
    }
}
}
// if there was an error make sure we return a null expander pointer
else
{
    // to get here, we had to see more than one subtractive phy that
    // connect to different SAS addresses, this is a topology error
    // do cleanup on any memory allocated if necessary
    if((expander != Expander) &&
        (expander != *DeviceSet))
    {
        // release the memory we allocated for this and make sure
        // we return a null
        free(expander);
        expander = 0;
    }
}
}
while(!error &&
    expander &&
    subtractiveSASAddress);

// on return expander contains the subtractive boundary expander
// or a null indicating there were no subtractive phys,

```

This page contains no comments

```

    // or a null indicating there was an error
    return(expander);
} // FindBoundary

// find the table structure associated with a specific SAS address
static
struct TopologyTable *FindExpander(struct TopologyTable *Expander,
                                   quadword SASAddress)
{
    // walk the list of expanders, when we find the one that matches, stop
    while(Expander)
    {
        // do the SASAddresses match
        if(SASAddress == Expander->SASAddress)
        {
            break;
        }

        Expander = Expander->Next;
    }

    return(Expander);
} // FindExpander

// this routine searches the subtractive phys for the upstream
// expander address
static
int UpstreamExpander(struct TopologyTable *Expander,
                    quadword *SASAddress,
                    byte *PhyIdentifier)
{
    struct Discover *discover;

    byte phyCount;

    int found = 0;

    // walk through all the phys of this expander, searching for subtractive
    // phys return the SASAddress and PhyIdentifier for the first subtractive
    // phy encountered, they are all be the same if they have anything
    // attached
    for(phyCount = 0;
        (phyCount < Expander->Device.NumberOfPhys);
        phyCount++)
    {
        // this is just a pointer helper
        discover = &(amp;Expander->Phy[phyCount].Result);

        // look for phys with edge or fanout devices attached...
        if((discover->RoutingAttribute == SUBTRACTIVE) &&
            ((discover->AttachedDeviceType == EDGE_EXPANDER_DEVICE) ||
             (discover->AttachedDeviceType == FANOUT_EXPANDER_DEVICE)))
        {
            *SASAddress = discover->AttachedSASAddress;
            *PhyIdentifier = discover->AttachedPhyIdentifier;
            found = 1;
            break;
        }
    }
}

```

This page contains no comments

```

    }
}

return(found);
} // UpstreamExpander

// this routine determines whether a SAS address is directly attached to
// an expander
static
int DirectAttached(struct TopologyTable *Expander,
                  quadword SASAddress)
{
    int direct = 0;
    byte phyCount;

    for(phyCount = 0;
        phyCount < Expander->Device.NumberOfPhys;
        phyCount++)
    {
        // did we find the address attached locally
        if(SASAddress ==
            Expander->Phy[phyCount].Result.AttachedSASAddress)
        {
            direct = 1;
            break;
        }
    }

    return(direct);
} // DirectAttached

// this route determines whether a SAS address is already in the route table
static
int AlreadyInTable(struct TopologyTable *Expander,
                  quadword *SASAddress,
                  byte PhyIdentifier)
{
    int inTable = 0;
    int routeIndex;

    for(routeIndex = 0;
        routeIndex < Expander->Device.ExpanderRouteIndexes;
        routeIndex++)
    {
        struct RouteTableEntry *entry =
            &Expander->RouteTable[PhyIdentifier][routeIndex];

        if(entry->RoutedSASAddress ==
            SASAddress)
        {
            inTable = 1;
            break;
        }
    }

    return(inTable);
} // AlreadyInTable

```

This page contains no comments

```

// this routine determines whether the SAS address, can be optimized out
// of the route table
static
int QualifiedAddress(struct TopologyTable *Expander,
                    byte PhyIdentifier,
                    quadword SASAddress,
                    byte RoutingAttribute,
                    byte *DisableRouteEntry)
{
    int qualified = 1;
    word routeIndex;

    if(DiscoverAlgorithm == SAS_UNIQUE_LEVEL_DESCENT)
    {
        if(((RoutingAttribute == SUBTRACTIVE) ||
            (RoutingAttribute == TABLE)) &&
            ((SASAddress == 0) ||
            (SASAddress == Expander->SASAddress) ||
            !memcmp(SASAddress, Expander->SASAddress, 8) ||
            DirectAttached(Expander, SASAddress) ||
            AlreadyInTable(Expander, SASAddress, PhyIdentifier)))
        {
            // if we made it here then we are disqualifying the address,
            // rules 2, 3, 4, and 5
            qualified = 0;
        }

        // if qualified, but the address is zero, then make sure it is
        // disabled
        if(qualified &&
            (SASAddress == 0))
        {
            *DisableRouteEntry = DISABLE;
        }
    }

    return(qualified);
} // QualifiedAddress

```

```

// this function is the configuration cycle from the current expander to
// the hub expander
static
int ConfigureExpander(byte PhyIdentifier,
                     quadword SourceSASAddress,
                     struct TopologyTable *HubExpander,
                     struct TopologyTable *ThisExpander)
{
    struct TopologyTable *thisExpander = ThisExpander;
    struct TopologyTable *expander = ThisExpander;
    struct TopologyTable *configureExpander;

    struct Discover *discover;

    quadword upstreamSASAddress = 0;
    byte upstreamPhyIdentifier = 0;

```

This page contains no comments

```

byte phyIndex;
word routeIndex;
byte openStatus = OPEN_ACCEPT;

int error = 0;

do
{
    // move upstream from here to find the expander table to configure with
    // information from "thisExpander"
    if(!UpstreamExpander(thisExpander,
                        &upstreamSASAddress,
                        &upstreamPhyIdentifier))
    {
        break;
    }

    if(upstreamSASAddress)
    {
        // get the expander associated with the upstream address
        configureExpander = FindExpander(HubExpander,
                                        upstreamSASAddress);

        // if we found an upstream expander, then program it's route
        // table
        if(configureExpander)
        {
            byte disableRouteEntry = ENABLED;

            for(phyIndex = 0;
                phyIndex < configureExpander->Device.NumberOfPhys;
                phyIndex++)
            {
                if(configureExpander->Phy[phyIndex].Result.AttachedSASAddress
                    == thisExpander->SASAddress)
                {
                    // loop through all the phys of the attached expander
                    for(routeIndex = 0;
                        ((routeIndex <
                            expander->Device.NumberOfPhys) &&
                            (configureExpander->RouteIndex[phyIndex] <
                                configureExpander->Device.ExpanderRouteIndexes));
                        routeIndex++)
                    {
                        discover = &(expander->Phy[routeIndex].Result);

                        // assume the route entry is enabled
                        disableRouteEntry = ENABLED;

                        // make sure if the attached device type is 0, that the
                        // SAS address is 0, to simplify the qualified address
                        // check
                        if(discover->AttachedDeviceType == 0)
                        {
                            discover->AttachedSASAddress = 0;
                        }
                    }
                }
            }
        }
    }
}

```

Author: RElliott
Subject: Highlight
Date: 6/30/2008 6:16:52 PM

T ACCEPT - DONE

it's

s/b

its

```

// check to see if the address needs to be configured
// in the route table, this decision is based on the
// optimization flag
if(QualifiedAddress(configureExpander,
                    phyIndex,
                    discover->AttachedSASAddress,
                    discover->RoutingAttribute,
                    &disableRouteEntry))
{
    word index = configureExpander->RouteIndex[phyIndex];

    struct RouteTableEntry *entry =
        &configureExpander->RouteTable[phyIndex][index];

    // configure the route indexes for the expander
    // with the attached address information
    SMPRequest(PhyIdentifier,
              SourceSASAddress,
              configureExpander->SASAddress,
              &SMPRequestFrame,
              &SMPResponseFrame,
              &openStatus,
              CONFIGURE_ROUTE_INFORMATION,
              index,
              phyIndex,
              disableRouteEntry,
              discover->AttachedSASAddress);

    if((openStatus != OPEN_ACCEPT) ||
        (SMPResponseFrame.FunctionResult !=
         SMP_FUNCTION_ACCEPTED))
    {
        error = 1;
        break;
    }

    // add the address to the internal copy of the
    // route table, if successfully configured
    entry->RoutedSASAddress =
        discover->AttachedSASAddress;

    // increment the route index for this phy
    configureExpander->RouteIndex[phyIndex]++;
}
}
}
}
}
}

// move upstream
thisExpander = configureExpander;
} while(!error &&

```

This page contains no comments

```

        thisExpander &&
        upstreamSASAddress);

    return(error);
} // ConfigureExpander

// this determines if the expander has a table routed phy attached to the
// SAS address and phyIndex provided
static
int CheckForTableAttribute(struct TopologyTable *Expander,
                          byte PhyIndex,
                          quadword SASAddress)
{
    int table = 0;
    byte phyCount;

    for(phyCount = 0;
        phyCount < Expander->Device.NumberOfPhys;
        phyCount++)
    {
        // did we find the address attached locally
        if((SASAddress ==
            Expander->Phy[phyCount].Result.AttachedSASAddress) &&
            (phyCount == PhyIndex) &&
            (Expander->Phy[phyCount].Result.RoutingAttribute == TABLE))
        {
            table = 1;
            break;
        }
    }

    return(table);
} // CheckForTableAttribute

// this discovers then configures as necessary the expanders it finds
// within the SAS domain that are "downstream"
static
struct TopologyTable *DiscoverAndConfigure(byte PhyIdentifier,
                                          quadword SourceSASAddress,
                                          struct TopologyTable *HubExpander,
                                          struct TopologyTable **DeviceSet)
{
    struct TopologyTable *currentExpander = HubExpander;
    struct TopologyTable *nextExpander;

    struct Discover *currentDiscover;

    quadword sasAddress;
    byte phyIndex;

    int error = 0;

    // this is a level descent traversal with a configuration stage
    // at each transition to a new level, if a configuration is required
    // by the expander

    // the discover process moves forward through the topology, but the

```

This page contains no comments

```

// configuration process stays anchored at the hub of the
// topology, meaning the fanout expander, or the top most subtractive
// edge expander device
// this ensures that as each new expander is added to the
// topology table list, it is in the configuration chain

while(!error &&
      currentExpander)
{
    // start at phy 0
    phyIndex = 0;

    // walk through all the phys of the current expander looking for
    // new expanders to add to the topology table
    do
    {
        // this is just a pointer helper
        currentDiscover = &(currentExpander->Phy[phyIndex].Result);

        // look for phys with edge or fanout devices attached...
        if((currentDiscover->RoutingAttribute == TABLE) &&
           ((currentDiscover->AttachedDeviceType == EDGE_EXPANDER_DEVICE) ||
            (currentDiscover->AttachedDeviceType == FANOUT_EXPANDER_DEVICE)
           ))
        {
            struct TopologyTable *thisExpander = currentExpander;
            struct TopologyTable *previousExpander = currentExpander;

            // check to see if we already have the address information
            // in our expander list
            while(thisExpander)
            {
                // if we do, then stop here
                if(currentDiscover->AttachedSASAddress ==
                   thisExpander->SASAddress)
                {
                    break;
                }

                // setup the pointer references
                previousExpander = thisExpander;
                thisExpander = thisExpander->Next;
            }

            // if we did not have the expander in our list, then get
            // the information
            if(!thisExpander)
            {
                // discover all the details about the attached expander
                // and insert into the master list
                thisExpander =
                    DiscoverExpander(PhyIdentifier,
                                     SourceSASAddress,
                                     currentDiscover->AttachedSASAddress);

                // if we got the discover information, then add it to the
                // list
            }
        }
    }
}

```

This page contains no comments

```

if(thisExpander)
{
if(CheckForTableAttribute(thisExpander,
                          phyIndex,
                          currentDiscover->SASAddress))
    {
        // output an error message
        TracePrint("\n"
                  "error table phys connected together\n");
    }
else
    {

previousExpander->Next = thisExpander;

// go through the configure cycle progressively ascending
// to each expander starting at "thisExpander"
ConfigureExpander(PhyIdentifier,
                  SourceSASAddress,
                  HubExpander,
                  thisExpander);
    }
}
}

// look for subtractive phys with edge or fanout devices attached...
else
if(DeviceSet &&
   (currentDiscover->RoutingAttribute == SUBTRACTIVE) &&
   ((currentDiscover->AttachedDeviceType == EDGE_EXPANDER_DEVICE) ||
    (currentDiscover->AttachedDeviceType == FANOUT_EXPANDER_DEVICE)))
{
    if(*DeviceSet == 0)
    {
        struct TopologyTable *thisExpander = currentExpander;
        struct TopologyTable *previousExpander = currentExpander;

        // check to see if we already have the address information
        // in our expander list
        while(thisExpander)
        {
            // if we do, then stop here
            if(!memcmp(&currentDiscover->AttachedSASAddress,
                      &thisExpander->SASAddress,
                      8))
            {
                break;
            }

            // setup the pointer references
            previousExpander = thisExpander;
            thisExpander = thisExpander->Next;
        }

        // if we did not have the expander in our list, then get
        // the information

```

This page contains no comments

```

        if(!thisExpander)
        {
            // discover all the details about the attached expander
            // and insert into the master list
            thisExpander =
                DiscoverExpander(PhyIdentifier,
                                SourceSASAddress,
                                currentDiscover->AttachedSASAddress);

            // if we got the discover information, then set it as the
            // other device set
            if(thisExpander)
            {
                *DeviceSet = thisExpander;
            }
        }
    }

    // move to the next phy on this expander
    phyIndex++;

} while(phyIndex <
        currentExpander->Device.NumberOfPhys);

// cycle to the next expander to discover
currentExpander = currentExpander->Next;
}

// return the top of expander list
return(HubExpander);
} // DiscoverAndConfigure

// this routine appends the leaf to the tree domain
static
void ConcatenateSASDomains(struct TopologyTable *Tree,
                          struct TopologyTable *Leaf)
{
    while(Tree)
    {
        if(Tree->Next == 0)
        {
            Tree->Next = Leaf;
            break;
        }

        Tree = Tree->Next;
    }
} // ConcatenateSASDomains

// validate the route table entries for all expanders
static
int ValidateRouteTables(byte PhyIdentifier,
                       quadword SourceSASAddress,
                       struct TopologyTable *Expander,
                       int SASCompatibility)
{

```

This page contains no comments

```

struct ReportRouteInformation *route;

// buffers used to request and return SMP data
struct SMPRequest request = { 0 };
struct SMPResponse response = { 0 };

byte phyIndex;
word routeIndex;

byte openStatus = OPEN_ACCEPT;

int valid = 1;

if(SASCompatibility == SAS_10_COMPATIBLE)
{
    // this is just a pointer helper
    route = &(response.Response.ReportRouteInformation.Result);

    // walk the list of expanders
    while(valid &&
           Expander)
    {
        if(Expander->Device.ConfigurableRouteTable)
        {
            struct RouteTableEntry *entry;

            word expanderRouteIndexes;

            _swab( (char *)&Expander->Device.ExpanderRouteIndexes,
                  (char *)&expanderRouteIndexes,
                  sizeof(word) );

            for(phyIndex = 0;
                (valid &&
                 (phyIndex < Expander->Device.NumberOfPhys));
                phyIndex++)
            {
                // loop through all the phys of the expander
                for(routeIndex = 0;
                    (valid &&
                     ((routeIndex <
                       Expander->RouteIndex[phyIndex]) &&
                      (routeIndex <
                       expanderRouteIndexes)));
                    routeIndex++)
                {
                    openStatus = OPEN_ACCEPT;

                    // report the route indexes for the expander
                    SMPRequest(PhyIdentifier,
                               SourceSASAddress,
                               Expander->SASAddress,
                               &request,
                               &response,
                               &openStatus,
                               REPORT_ROUTE_INFORMATION,
                               routeIndex,

```

This page contains no comments

```

        phyIndex);

    if((openStatus != OPEN_ACCEPT) ||
        (response.FunctionResult !=
         SMP_FUNCTION_ACCEPTED))
    {
        break;
    }

    entry = &(Expander->RouteTable[phyIndex][routeIndex]);

    if((memcmp(&entry->RoutedSASAddress,
               &route->RoutedSASAddress,
               8)) ||
        (entry->ExpanderRouteEntryDisabled !=
         route->ExpanderRouteEntryDisabled))
    {
        valid = 0;
    }
}
}
}

    Expander = Expander->Next;
}
}

return(valid);
} // ValidateRouteTables

// validate that the change count for the hub expander is still the same
// as when we started
static
int ChangeCount(byte PhyIdentifier,
                quadword SourceSASAddress,
                struct TopologyTable *Expander)
{
    // buffers used to request and return SMP data
    struct SMPRequest request = { 0 };
    struct SMPResponse response = { 0 };

    int change = 0;

    byte openStatus = OPEN_ACCEPT;

    // get the report general information for the expander
    SMPRequest(PhyIdentifier,
               SourceSASAddress,
               Expander->SASAddress,
               &request,
               &response,
               &openStatus,
               REPORT_GENERAL);

    // don't worry about too much in the 'else' case for this example,
    // production code needs to handle
    if((openStatus == OPEN_ACCEPT) &&

```

This page contains no comments

```

        (response.FunctionResult == SMP_FUNCTION_ACCEPTED))
    {
        if(response.Response.ReportGeneral.ExpanderChangeCount !=
            Expander->Device.ExpanderChangeCount)
        {
            change = 1;
        }
    }

    return(change);
} // ChangeCount

// delete all the topology information and start over
void DeleteSASDomain(struct TopologyTable **Expander)
{
    struct TopologyTable *expander = *Expander;
    struct TopologyTable *nextExpander = 0;

    // walk the list of expanders
    while(expander)
    {
        nextExpander = expander->Next;

        free(expander);

        expander = nextExpander;
    }

    *Expander = 0;
} // DeleteSASDomain

// the application client for the initiator device makes a call to
// this function to begin the discover process...
// to simplify the setup for the simulation, the DiscoverProcess gets
// the Initiator number to allow multiple initiators...
void DiscoverProcess(byte Initiator,
                    byte PhyIdentifier)
{
    // check to see if an expander is attached
    if((Attached[Initiator].DeviceType == EDGE_EXPANDER_DEVICE) ||
        (Attached[Initiator].DeviceType == FANOUT_EXPANDER_DEVICE))
    {
        struct TopologyTable *connectedExpander;

        // get some local variables to keep things simple
        quadword sourceSASAddress = Iam[Initiator].SASAddress;
        quadword destinationSASAddress = Attached[Initiator].SASAddress;

        // expander is attached, so begin by getting the information about
        // the connected expander
        connectedExpander = DiscoverExpander(PhyIdentifier,
                                            sourceSASAddress,
                                            destinationSASAddress);

        // make sure we get the information from the expander
        if(connectedExpander)
        {

```

This page contains no comments

```

struct TopologyTable *thisDeviceSet;
struct TopologyTable *attachedDeviceSet = 0;

int redoDiscover = 0;
int changed = 0;

do
{
    // go upstream on the subtractive phys until we discover that we
    // are attached to another subtractive phy or a fanout expander
    // then begin the discover process from that point, this works
    // because any new address that we find naturally moves
    // upstream due to the subtractive addressing method
    // if during the discover cycle, it is determined that there
    // are two device sets connected, then a second discover
    // and configuration cycle is required for the other device set
    thisDeviceSet = FindBoundary(PhyIdentifier,
                                sourceSASAddress,
                                connectedExpander,
                                &attachedDeviceSet);

    // set the root for the domain as the subtractive boundary
    if(thisDeviceSet)
    {
        // output a little information about the subtractive boundary
        TracePrint("subtractive boundary at %s\n",
                  (char *)&thisDeviceSet->SASAddress);

        SASDomain[Initiator] = thisDeviceSet;
    }
    // if there was no subtractive boundary, then the root is the
    // expander connected to the initiator
    else
    {
        // output a little information about the subtractive boundary
        TracePrint("connected expander at %s\n",
                  (char *)&connectedExpander->SASAddress);

        SASDomain[Initiator] = connectedExpander;
    }

    // begin the discover and configuration cycle
    DiscoverAndConfigure(PhyIdentifier,
                        sourceSASAddress,
                        SASDomain[Initiator],
                        &attachedDeviceSet);

    // if two device sets are connected, then the attached device set
    // has to be discovered and configured
    if(attachedDeviceSet)
    {
        // output a little information about the attached device set
        TracePrint("attached device set at %s\n",
                  (char *)&attachedDeviceSet->SASAddress);

        // discover and configure the attached device set
        DiscoverAndConfigure(PhyIdentifier,

```

Author: RElliott
Subject: Highlight
Date: 6/30/2008 6:16:52 PM

T ACCEPT - DONE
domain
s/b
SAS domain

```

        sourceSASAddress,
        attachedDeviceSet,
        0);

    // put the domains together
    ConcatenateSASDomains(SASDomain[Initiator],
        attachedDeviceSet);
}

// if the change count of the top most expander is different
// from when we started, then the topology was not stable
// so do the discover again
changed = ChangeCount(PhyIdentifier,
    sourceSASAddress,
    SASDomain[Initiator]);

// if we used the route table optimization,
// check the route tables for each expander phy, if they are
// incorrect then change back to the original discover algorithm
// and redo discover, continue to use the original algorithm
// for any new discover
if(!changed &&
    (DiscoverAlgorithm == SAS_UNIQUE_LEVEL_DESCENT) &&
    !ValidateRouteTables(PhyIdentifier,
        sourceSASAddress,
        SASDomain[Initiator],
        SASCompatibility))
{
    redoDiscover = 1;

    // if the change count of the top most expander is the same
    // as when we started the validation of the route tables
    // then the topology was stable, so change the algorithm
    // before the rediscover
    if(!ChangeCount(PhyIdentifier,
        sourceSASAddress,
        SASDomain[Initiator]))
    {
        DiscoverAlgorithm = SAS_SIMPLE_LEVEL_DESCENT;
    }

    // delete everything allocated and start over
    DeleteSASDomain(&SASDomain[Initiator]);
}

} while(redoDiscover ||
    changed);
}
} // DiscoverProcess

```

● Author: RElliott
Subject: Highlight
Date: 6/30/2008 6:16:52 PM

T ACCEPT - DONE
domains
s/b
SAS domains

Annex M (informative)

SAS icons

A SAS icon should be included on or near all connectors used by devices compliant with this standard.

NOTE 129 - Contact the SCSI Trade Association at <http://www.scsita.org> for versions of the SAS icons in various graphics formats.

Figure M.1 shows the primary SAS icon.

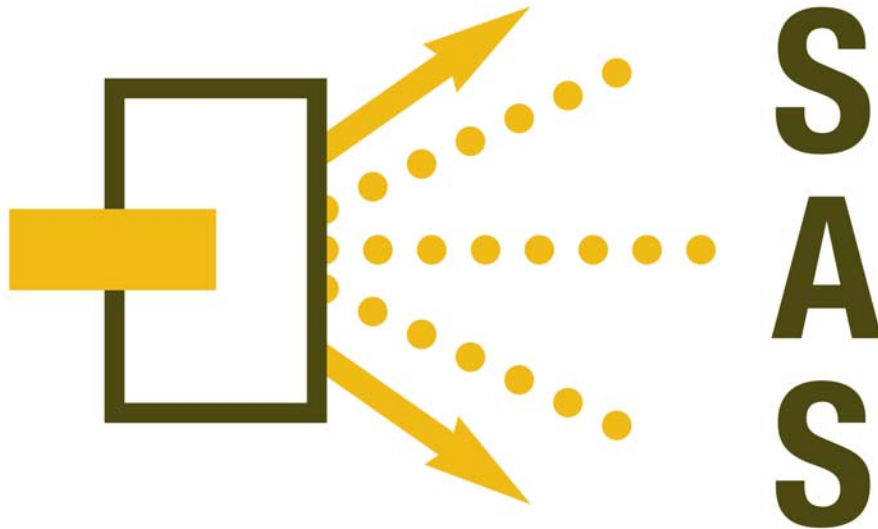

Figure M.1 — SAS primary icon

Figure M.2 shows an alternate SAS icon that may be used instead of the primary SAS icon when the area for the icon is small.

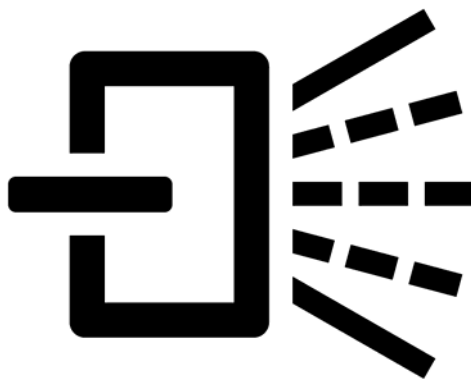

Figure M.2 — SAS alternate icon

This page contains no comments

Figure M.3 shows an alternate SAS icon with the SAS abbreviation letters alongside.

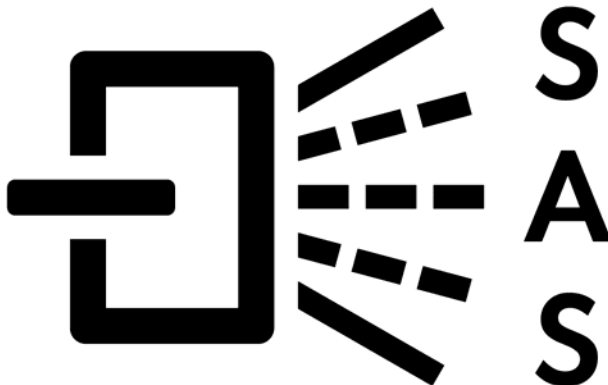

Figure M.3 — SAS alternate icon with SAS letters

This page contains no comments