

# Working Draft American National Standard

# Project T10/1559-D

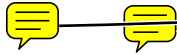

Revision 19  
12 November 2007

## Information technology - SCSI Enclosure Services - 2 (SES-2)

This is an internal working document of T10, a Technical Committee of Accredited Standards Committee INCITS (International Committee for Information Technology Standards). As such this is not a completed standard and has not been approved. The contents may be modified by the T10 Technical Committee. The contents are actively being modified by T10. This document is made available for review and comment only.

Permission is granted to members of INCITS, its technical committees, and their associated task groups to reproduce this document for the purposes of INCITS standardization activities without further permission, provided this notice is included. All other rights are reserved. Any duplication of this document for commercial or for-profit use is strictly prohibited.

T10 Technical Editor: Robert C Elliott  
Hewlett-Packard Corporation  
MC 140801  
PO Box 692000  
Houston, TX 77269-2000  
USA

Telephone: 281-518-5037  
Email: [elliott@hp.com](mailto:elliott@hp.com)

Reference number  
ISO/IEC 14776-372:200x  
ANSI INCITS \*\*\*-200x

# Summary of Comments on SCSI Enclosure Services - 2 (SES-2)

---

Page: i

---

● Author: relliott  
Subject: Note  
Date: 5/12/2008 3:36:09 PM  
 Key:

Adobe's (buggy) comment status features were used for this letter ballot comment resolution.

Review status:

**Accepted = comment accepted and implemented very closely to the way it was requested. Reply text may point out minor differences that the comment author probably won't care about.**

**Completed = comment will be accepted, but not implemented yet (e.g., "Delete revision history")**

**Rejected = comment not accepted or not implemented very closed to the way it was requested. The comment may have caused different changes to be made (either minor or major) - see the Reply text for details.**

**Comments by "relliott" were added by the editor during letter ballot, often to make sure the resolutions to the original comments are applied consistently throughout the whole document.**

Status  
relliott None 4/9/2008 6:58:28 PM

---

● Author: relliott  
Subject: Note  
Date: 5/12/2008 3:36:09 PM  
 Comment statistics

Total comments originally submitted: 285

- hpq-relliott: 44
- ibm-gop: 212
- symc-roger: 29

Comments added by editor while resolving other comments: 450

Total comments: 625

Total comments including replies: 731

Accepted: 535

Completed: 1 (remove revision history in ses2r20)

Rejected: 94

Replies: 104

No state: 2 (including this comment)

Total number of Adobe Acrobat crashes due to using built-in comment state feature: too many!

---

## Points of Contact

### International Committee for Information Technology Standards (INCITS) T10 Technical Committee

#### T10 Chair

John B. Lohmeyer  
LSI Corporation  
4420 Arrows West Drive  
Colorado Springs, CO 80907-3444  
USA

Telephone: (719) 533-7560  
Email: lohmeier@t10.org

T10 Web Site: <http://www.t10.org>

#### T10 Vice-Chair

George O. Penokie  
IBM Corporation  
MS: 2C6  
3605 Highway 52 N  
Rochester, MN 55901  
USA

Telephone: (507) 253-5208  
Email: [gop@us.ibm.com](mailto:gop@us.ibm.com)

#### T10 E-mail reflector:

Server: [majordomo@t10.org](mailto:majordomo@t10.org)

To subscribe send e-mail with 'subscribe' in message body

To unsubscribe send e-mail with 'unsubscribe' in message body

#### INCITS Secretariat

Suite 200  
1250 Eye Street, NW  
Washington, DC 20005  
USA

Telephone: 202-737-8888  
Web site: <http://www.incits.org>  
Email: [incits@itic.org](mailto:incits@itic.org)

#### Information Technology Industry Council

Web site: <http://www.itic.org>

#### Document Distribution

INCITS Online Store  
managed by Techstreet  
1327 Jones Drive  
Ann Arbor, MI 48105  
USA

Web site: <http://www.techstreet.com/incits.html>  
Telephone: (734) 302-7801 or (800) 699-9277

Global Engineering Documents, an IHS Company  
15 Inverness Way East  
Englewood, CO 80112-5704  
USA

Web site: <http://global.ihs.com>  
Telephone: (303) 397-7956 or (303) 792-2181 or (800) 854-7179

Author: ibm-gop  
Subject: Rectangle  
Date: 12/17/2007 12:10:49 PM -06'00'  
 Points of Contact

T10 Vice-Chair should be:

Mark S. Evans  
Western Digital Corporation  
5863 Rue Ferrari  
San Jose, CA 95138  
USA  
Telephone: (408) 363-5257  
Email: mark.evans@wdc.com

Status  
relliott Accepted 12/13/2007 8:22:43 PM -06'00'  
Status  
relliott Confirmed 12/13/2007 8:22:57 PM -06'00'

---

American National Standard  
for Information Technology

## **SCSI Enclosure Services - 2 (SES-2)**

Secretariat  
Information Technology Industry Council

Approved mm.dd.yy

American National Standards Institute, Inc.

### **ABSTRACT**

This standard describes a model for Small Computer System Interface (SCSI) access to services within an enclosure containing one or more SCSI devices. A SCSI command set is defined for managing various non-SCSI elements contained within the enclosure.

This standard maintains a high degree of compatibility with the SCSI Enclosure Services (SES) command set, INCITS 305-1998, and while providing additional functions, is not intended to require changes to presently installed devices or existing software.

This page contains no comments

## American National Standard

Approval of an American National Standard requires verification by ANSI that the requirements for due process, consensus, and other criteria for approval have been met by the standards developer. Consensus is established when, in the judgment of the ANSI Board of Standards Review, substantial agreement has been reached by directly and materially affected interests. Substantial agreement means much more than a simple majority, but not necessarily unanimity. Consensus requires that all views and objections be considered, and that effort be made towards their resolution.

The use of American National Standards is completely voluntary; their existence does not in any respect preclude anyone, whether he has approved the standards or not, from manufacturing, marketing, purchasing, or using products, processes, or procedures not conforming to the standards.

The American National Standards Institute does not develop standards and will in no circumstances give interpretation on any American National Standard. Moreover, no person shall have the right or authority to issue an interpretation of an American National Standard in the name of the American National Standards Institute. Requests for interpretations should be addressed to the secretariat or sponsor whose name appears on the title page of this standard.

**CAUTION NOTICE:** This American National Standard may be revised or withdrawn at any time. The procedures of the American National Standards Institute require that action be taken periodically to reaffirm, revise, or withdraw this standard. Purchasers of American National Standards may receive current information on all standards by calling or writing the American National Standards Institute.

**CAUTION:** The developers of this standard have requested that holders of patents that may be required for the implementation of the standard, disclose such patents to the publisher. However, neither the developers nor the publisher have undertaken a patent search in order to identify which, if any, patents may apply to this standard. As of the date of publication of this standard, following calls for the identification of patents that may be required for the implementation of the standard, no such claims have been made. No further patent search is conducted by the developer or the publisher in respect to any standard it processes. No representation is made or implied that licenses are not required to avoid infringement in the use of this standard.

Published by

**American National Standards Institute  
11 W. 42nd Street, New York, New York 10036**

Copyright © 2007 by Information Technology Industry Council (ITI).  
All rights reserved.

No part of this publication may be reproduced in any form, in an electronic retrieval system or otherwise, without prior written permission of ITI, 1250 Eye Street NW, Suite 200, Washington, DC 20005.

Printed in the United States of America

Author: relliott  
Subject: Highlight  
Date: 5/12/2008 3:36:09 PM

**T** 2007  
s/b  
2008

Status  
relliott Accepted 12/13/2007 8:26:02 PM -06'00'

Status  
relliott Confirmed 12/13/2007 8:26:08 PM -06'00'

---



## Revision Information

### R.1 Revision 0 (24 May 2002)

Based on SES revision 8b, NCITS.305:1998.

Incorporated SES Amendment #1 (NCITS.305/AM 1:2000).

Converted to FrameMaker 6.0 using the T10 standard template. Fixed hanging paragraphs.

Updated command, diagnostic page code, and mode page code tables to match SPC-3. Added READ BUFFER to list of supported commands.

 Added a log page code table. Changed all page names to Mixed Case and added diagnostic, log, or mode as appropriate. Changed ASC/ASCQ to "additional sense code."

Made name of RECEIVE DIAGNOSTIC RESULTS consistent. Made naming of additional sense codes consistent.

Removed asynchronous event reporting section.

### R.2 Revision 1 (24 July 2002)

Incorporated the following T10-approved proposals:

- a) 02-260r1 Mandatory REPORT LUNS support (Dave Peterson)
- b) 02-277r1 Obsolete Reserve/Release (Dave Peterson)
- c) 02-190r0 SES-2 Enclosure busy indication (Dennis Spicher/Rob Elliott)
- d) 02-191r1 SES-2 Invalid Operation Decode element type (Dennis Spicher/Rob Elliott)
- e) 02-192r0 SES-2 IDENT control for each element (Dennis Spicher/Rob Elliott)
- f) 02-193r0 SES-2 INVOP handling (Dennis Spicher/Rob Elliott)
- g) 02-194r1 SES-2 Protocol-specific device element information (Dennis Spicher/Rob Elliott)
- h) 02-248r1 SES-2 Cooling element fan speed in RPM (Thin Nguyen/Rob Elliott)
- i) 02-249r1 SES-2 Nonvolatile Cache element cache size (Thin Nguyen/Rob Elliott)
- j) 02-250r1 SES-2 Enclosure element (Thin Nguyen/Rob Elliott)
- k) 02-251r1 SES-2 Enclosure Status element bypass status enhancement (Dennis Spicher/Rob Elliott)

### R.3 Revision 2 (2 November 2002)

Incorporated the following changes:

- a) 02-189r1 SES-2 SPC-3 Vendor-specific diagnostic pages (Rob Elliott)
- b) Introduced "attached" wording in the model section (used by SPC-3)
- c) Per 02-346r1 and spc3r09, added REPORT SUPPORTED TASK MANAGEMENT FUNCTIONS as an optional command
- d) Imported paragraph formats from SAS revision 2c

### R.4 Revision 3 (31 May 2003)

Incorporated the following changes:

- a) 03-029r0 SES-2 Array Status element bypass status enhancement (Rob Elliott, HP) [03-048 T10 Plenary 1/2003]
- b) 03-059r1 SES-2 Enclosure/Array Control status element for device activity (Bob Sheffield, Intel) [03-179 T10 Plenary 5/2003]
- c) Changed references to FC-PH to SPC-3 for enclosure identifier formats
- d) Updated FrameMaker formatting to match final revision of SAS
- e) Converted the figures in the model section to Microsoft Visio.

### R.5 Revision 4 (15 July 2003)

Incorporated the following changes:

- a) Made bit acronym/name introductions consistent: The ABC (aa bb cc) bit ...
- b) 03-214r1 SES-2 Update to SAS Device Element Status descriptor (Rob Elliott, HP)
- c) 03-215r0 SES-2 Array Control and Array Status diagnostic page changes (Rob Elliott, HP). The proposal neglected to include all the Device element bits into the new Array Device elements; they

Page: v

---

Author: ibm-gop

Subject: Note

Date: 12/17/2007 12:11:01 PM -06'00'



Revision history needs to be removed.

Status

relliott Completed 12/19/2007 7:21:46 PM -06'00'

---

were merged during incorporation (except for the obsolete slot address field, which doesn't fit anyway).

### R.6 Revision 5 (15 November 2003)

Incorporated the following changes:

- a) Changed +245 to +235 degrees in the Temperature element. The math was off by 10 degrees.
- b) 03-347r1 SES-2 Reporting peer enclosure service processes (Rob Elliott, HP)
- c) Moved Annex A (subenclosures) into the main body.
- d) Moved Annex B (additional sense codes) into the main body.
- e) Renamed the vendor specific byte 1 of the Short Enclosure Status diagnostic page to the SHORT ENCLOSURE STATUS field, so it can be properly referenced by the Simple Subenclosure element
- f) Renamed the DISABLD bit to the DISABLED bit in the SCSI Port/Transceiver element and the Communications element
- g) Corrected some specifies/indicates

### R.7 Revision 6 (25 January 2004)

Incorporated the following changes per the January 2004 CAP WG (04-038r0) and T10 plenary (04-039r0):

- a) 04-007r0 SES-2 SPC-3 Generation codes for Help Text and String pages (Rob Elliott, HP). Dropped the format that lacks a length field if number of enclosures = 0 for the new pages since there is no backward compatibility concern.
- b) renamed the STATUS CODE field to the ELEMENT STATUS CODE field to reduce confusion with the SCSI status code (GOOD, CHECK CONDITION, etc.) and made its values one hex digit rather than two (since it's only a 4 bit field)
- c) Corrected the DEVICE ELEMENT STATUS DESCRIPTOR LENGTH (n - 2) notation to (n - 1) in 3 tables.
- d) Changed "set" to "set to one" and "cleared" to "set to zero" in element bit descriptions
- e) Converted . to , in numbers to follow ISO format. Added non-wrapping space before % signs.
- f) Other editorial corrections to head-off certain expected letter ballot comments

### R.8 Revision 7 (29 March 2004)

Incorporated the following changes per the March 2004 CAP WG (04-084r0) and T10 plenary (04-085r0):

- a) 04-010r2 SPC-3 SES-2 More diagnostic pages for SES (Rob Elliott, HP)
- b) 04-074r0 Supported SES diagnostic pages (Rob Elliott, HP)

### R.9 Revision 8 (7 May 2004)

Incorporated the following changes per the May 2004 CAP WG (04-134r0) and T10 plenary (04-135r0):

- a) 04-130r1 SES-2 Array Device element Status and Control page Clarifications (Kevin Marks, Dell)
- b) Use subenclosure rather than sub-enclosure consistently.

### R.10 Revision 9 (22 July 2004)

Incorporated the following changes per the July 2004 CAP WG (04-215r0) and T10 plenary (04-216r0):

- a) 04-031r3 SPC-3 SES-2 SBC-2 Miscellaneous diagnostic page topics (Rob Elliott, HP)
- b) Clarified "attached" wording in model

### R.11 Revision 10 (29 January 2005)

Incorporated the following changes per the September 2004 CAP WG (04-288r0) and T10 plenary (04-289r0) and January 2005 CAP WG (05-035r0) and T10 plenary (05-036r0):

- a) 04-290r1 SAM-3 SPC-3 SBC-2 SSC-3 SES-2 OSD-2 Condition and event definitions (Rob Elliott, HP)
- b) 04-296r1 Numbering conventions description (Mark Evans, Maxtor)
- c) 04-374r3 SES-2 Define a SAS Expander element (Rob Elliott, HP)
- d) 04-377r2 SES-2 Download Microcode diagnostic page (Rob Elliott, HP)
- e) 04-382r1 SES-2 Subenclosure Nickname diagnostic page (Rob Elliott, HP)
- f) removed some unused definitions and acronyms and updated others to match SBC-2 definitions
- g) changed "status type" to "status-type" and "control type" to "control-type" in diagnostic page references
- h) changed to "standalone" and "attached" wording in several places

This page contains no comments

- i) changed “initiator” and “initiator port” to “I\_T nexus” in several places to agree with recent changes to SAM-3 and SPC-3
- j) updated scores of sentences to use standard specifies/indicates phrasing
- k) changed “execute” to “process” or other T10 preferred wording throughout
- l) fixed attached range from 00h-1Fh to 00h-2Fh after the diagnostic page code table
- m) Marked REPORT LUNS as mandatory for an SES peripheral device; added SCC-2 and SMC-2 commands since SPC-3 lists them as optional for the SES device type
- n) Changed “device” to “enclosure services process” or “peripheral device” as appropriate. Eliminated “enclosure services processor” term.

### R.12 Revision 11 (12 March 2005)

Incorporated the following changes per the March 2004 CAP WG (05-096r0) and T10 plenary (05-097r0):

- a) Changed SAS Connector IDENTIFIER field reserved region from F0h-FFh to 40h-4Fh since there are only 7 bits available.
- b) Added “the Xyz element manages xyz.” introduction paragraph to each element description that did not have such an introduction.
- c) Renamed the control field ACTIVE bit to RQST ACTIVE. It’s new in SES-2 and this makes the name match other control bits and avoid conflicting with the status field ACTIVE bit.
- d) Corrected the reserved/vendor-specific ranges of CONNECTOR TYPE field values in the Connector element, since it is a 7-bit rather than 8-bit field
- e) Added connector type encodings for the SAS external compact connector and internal compact wide connectors being added to SAS-1.1 by 05-084r1
- f) 05-064r1 SES-2 Additional Element Status diagnostic page Valid bit (Rob Elliott, HP)
- g) 05-074r1 SPC-3 SPC-4 SES-2 SMC-3 Command requirements (Rob Elliott, HP)
- h) 05-005r2 SES-2: Audible Alarm Element Addition (Kevin Marks, Dell)

### R.13 Revision 12 (12 May 2005)

Incorporated the following changes per the May 2005 CAP WG (05-164r0) and T10 plenary (05-165r0):

- a) 05-180r0 SES-2 Bay Number Addition (Steve Fairchild, HP)
- b) 05-181r1 SES-2 Element Index Addition (Steve Fairchild, HP)
- c) Changed the name of the Configuration diagnostic page NUMBER OF ELEMENT TYPES SUPPORTED field to the NUMBER OF ELEMENT TYPE DESCRIPTOR HEADERS field, since it doesn’t really report the number of element types, it reports the number of type descriptor headers (one type can be in the type descriptor header list multiple times).
- d) Clarified that element index is based on all the elements, not just the elements of the same type, and doesn’t include overall statuses, by adding: “The ELEMENT INDEX field indicates the index of the element that this descriptor is describing. The index is based on the position of the ELEMENT STATUS field in the Enclosure Status diagnostic pages relative to all other ELEMENT STATUS fields. It does not include the OVERALL STATUS fields.”
- e) Fixed the SAS Connector element CONNECTOR TYPE field values again. Revision 11 was based on 6 bits not 7 bits. The range is 30h to 6Fh reserved, 70h to 7Fh vendor-specific (04-374r3 asked that the last 10h be vendor-specific).

### R.14 Revision 13 (12 November 2005)

Incorporated the following changes per the November 2005 CAP WG (05-419r0) and T10 plenary (05-420r0):

- a) Added an EIP=0 version of the Additional Element Status descriptor protocol-specific information for Fibre Channel without 2 extra reserved bytes (completing 05-181r1 inclusion)
- b) 05-300r0 SES-2 Add RQST MISSING to Device and Array Device elements (Kevin Marks, Dell). Note this is a write-only bit; there is not room in the status element to return the current value of the bit.
- c) 05-372r0 SES-2 Cooling element enlarge Actual Fan Speed field (Rob Elliott, HP)
- d) 05-400r0 SES-2 Update Connector Type field to SAS-1.1 names (Kevin Marks, Dell)

### R.15 Revision 14 (17 January 2006)

Incorporated the following changes per the January 2006 CAP WG (06-040r0) and T10 plenary (06-041r0):

- a) 06-036r1 SES-2 More Additional Element Status descriptors (Rob Elliott, HP)

This page contains no comments

**R.16 Revision 15 (13 May 2006)**

Incorporated the following changes per the May 2006 CAP WG (06-232r0) and T10 plenary (06-233r0):

- a) 05-011r2 SES-2 Display element enhancements (Rob Elliott, HP)
- b) 06-200r1 SES-2 Internal/External Vendor Specific connectors (George Penokie, IBM)

**R.17 Revision 16 (22 March 2007)**

Incorporated the following changes per the March 2007 CAP WG (07-116r0) and T10 plenary (07-117r0):

- a) 07-087r1 SAS-2 SES-2 Enclosure Connector Information (Brad Besmer, LSI Logic)
- b) 07-092r0 (Additional Element Status Bay Number for Fibre Channel) [Elliott]
- c) 07-095r0 (Cooling element Requested Speed Code of zero) [Elliott]
- d) 07-097r1 (Add failure indicator support to most elements) [Elliott]. In the SAS Connector element status, byte 1 bit 6 is already being used, so used byte 3 bit 6 instead.
- e) 07-104r1 (Clarify IDENT bit for unusual elements) [Elliott]
- f) 07-096r1 (Overall element handling) [Elliott]
- g) 07-098r0 (Additional Element Status for Enclosure Services Controller Electronics) [Elliott]
- h) Changed all the RQST IDENT bit, RQST FAIL bit, IDENT bit, and FAIL bit descriptions to just point to the Power Supply or Cooling element definitions rather than repeat the wording.
- i) Updated references: FCP-3 to FCP-4, SAM-3 to SAM-4, SPC-3 to SPC-4, SAS-1.1 to SAS-2, and ATA/ATAPI-7 V3 to SATA-2

**R.18 Revision 17 (14 May 2007)**

Incorporated the following changes per the May 2007 CAP WG (07-212r0) and T10 plenary (07-213r0):

- a) 07-163r0 SES-2 New element status code (George Penokie, IBM)
- b) 07-202r1 SES-2 Indication if element may be hot swapped (George Penokie, IBM)

**R.19 Revision 18 (17 July 2007)**

Incorporated the following changes per the July 2007 CAP WG (07-315r0) and T10 plenary (07-316r0):

- a) 07-118r2 SES-2 Enclosure element Power Cycle request (Dennis Spicher and Rob Elliott, HP)

**R.20 Revision 19 (12 November 2007)**

Incorporated the following changes per the November 2007 CAP WG (07-475r0) and T10 plenary (07-476r0):

- a) 07-428r0 SES-2 Additional Element Status length field correction (Rob Elliott, HP)
- b) 07-099r0 SES-2 Clarify no null termination of strings (Rob Elliott, HP)
- c) 07-457r0 SES-2 Bypass reason code (Rob Elliott and Mark Williams, HP)
- d) Updated some definitions to match SPC-4 and SAM-4.

**R.21 Pending**

Pending proposals (which might be deferred until SES-3) include:

- a) clarify what asynchronous events are reported via the SAS BROADCAST (SES) primitive
- b) change the terminology to clarify nested lists/control/status fields:
  - A) Configuration diagnostic page:
  - B) type descriptor --> element type descriptor
  - C) type descriptor list --> element type descriptor list = element type descriptor(s)
  - D) Enclosure Control/Status diagnostic pages:
  - E) OVERALL CONTROL field --> overall control descriptor
  - F) OVERALL STATUS field --> overall status descriptor
  - G) ELEMENT CONTROL field --> element control descriptor
  - H) ELEMENT STATUS field --> element status descriptor
  - I) common element type control descriptor list = overall control descriptor + element control descriptor(s)
  - J) common element type status descriptor list = overall status descriptor + element status descriptor(s)
  - K) Threshold Out/In diagnostic pages:
  - L) OVERALL THRESHOLD field for Threshold Out diagnostic page --> overall threshold control descriptor

This page contains no comments



- M) OVERALL THRESHOLD field for Threshold In diagnostic page --> overall threshold status descriptor
  - N) ELEMENT THRESHOLD field for Threshold Out diagnostic page --> element threshold control descriptor
  - O) ELEMENT THRESHOLD field for Threshold In diagnostic page --> element threshold status descriptor
  - P) common element type threshold control descriptor list = overall threshold control descriptor + element threshold control descriptor(s)
  - Q) common element type threshold status descriptor list = overall threshold status descriptor + element threshold status descriptor(s)
- c) provide more tutorial information/examples

This page contains no comments

## Contents

	Page
1 Scope .....	1
2 Normative references .....	2
2.1 Normative references .....	2
2.2 Approved references .....	2
2.3 References under development .....	3
2.4 Other references .....	3
3 Definitions, symbols, abbreviations, and conventions .....	4
3.1 Definitions .....	4
3.2 Symbols and abbreviations .....	6
3.3 Keywords .....	6
3.4 Conventions .....	7
4 SCSI enclosure services model .....	8
4.1 Access to the enclosure services process .....	8
4.1.1 Access to the enclosure services process overview .....	8
4.1.2 Standalone enclosure services process .....	8
4.1.3 Attached enclosure services process .....	9
4.2 Management of indicators and controls .....	10
4.3 Use of the Short Enclosure Status diagnostic page .....	11
4.4 Use of the Enclosure Busy diagnostic page .....	11
4.5 Invalid field errors .....	11
4.6 Reporting of enclosure failure information .....	12
4.6.1 Reporting overview .....	12
4.6.2 Polling .....	12
4.6.3 Timed completion function .....	12
4.6.4 CHECK CONDITION status .....	12
4.7 Subenclosures .....	12
4.8 Additional sense codes .....	13
5 Commands for enclosure services peripheral devices .....	15
6 Parameters for enclosure services devices .....	17
6.1 Diagnostic parameters .....	17
6.1.1 Diagnostic parameters overview .....	17
6.1.2 Configuration diagnostic page .....	19
6.1.2.1 Configuration diagnostic page overview .....	19
6.1.2.2 Enclosure descriptor list .....	21
6.1.2.3 Type descriptor header list .....	22
6.1.2.4 Type descriptor text list .....	23
6.1.3 Enclosure Control diagnostic page .....	23
6.1.4 Enclosure Status diagnostic page .....	25
6.1.5 Help Text diagnostic page .....	28
6.1.6 String Out diagnostic page .....	28
6.1.7 String In diagnostic page .....	29
6.1.8 Threshold Out diagnostic page .....	30
6.1.9 Threshold In diagnostic page .....	32
6.1.10 Element Descriptor diagnostic page .....	34
6.1.11 Short Enclosure Status diagnostic page .....	35
6.1.12 Enclosure Busy diagnostic page .....	36
6.1.13 Additional Element Status diagnostic page .....	37
6.1.13.1 Additional Element Status diagnostic page overview .....	37
6.1.13.2 Additional Element Status descriptor protocol-specific information for Fibre Channel .....	38

This page contains no comments

6.1.13.3 Additional Element Status descriptor protocol-specific information for SAS .....	41
6.1.13.3.1 Additional Element Status descriptor protocol-specific information for SAS overview .....	41
6.1.13.3.2 Additional Element Status descriptor protocol-specific information for Device and Array Device elements for SAS.....	42
6.1.13.3.3 Additional Element Status descriptor protocol-specific information for SAS Expander elements .....	45
6.1.13.3.4 Additional Element Status descriptor protocol-specific information for SCSI Initiator Port, SCSI Target Port, and Enclosure Services Controller Electronics elements for SAS .....	46
6.1.14 Subenclosure Help Text diagnostic page .....	47
6.1.15 Subenclosure String Out diagnostic page.....	48
6.1.16 Subenclosure String In diagnostic page .....	49
6.1.17 Supported SES Diagnostic Pages diagnostic page .....	50
6.1.18 Download Microcode Control diagnostic page.....	51
6.1.19 Download Microcode Status diagnostic page .....	54
6.1.20 Subenclosure Nickname Control diagnostic page .....	57
6.1.21 Subenclosure Nickname Status diagnostic page.....	58
6.2 Log parameters for enclosure services devices .....	59
6.3 Mode parameters for enclosure services devices .....	60
6.3.1 Mode parameters overview.....	60
6.3.2 Enclosure Services Management mode page .....	61
7 Element definitions .....	62
7.1 Element definitions overview .....	62
7.2 Formats for status and control fields .....	63
7.2.1 Formats for status and control fields overview.....	63
7.2.2 Format for all control fields.....	64
7.2.3 Format for all status fields.....	65
7.3 Field definitions for all element types .....	66
7.3.1 Unspecified element .....	66
7.3.2 Device element .....	66
7.3.3 Array Device element.....	69
7.3.4 Power Supply element .....	72
7.3.5 Cooling element.....	73
7.3.6 Temperature Sensor element .....	75
7.3.7 Door Lock element.....	76
7.3.8 Audible Alarm element.....	77
7.3.9 Enclosure Services Controller Electronics element .....	79
7.3.10 SCC Controller Electronics element .....	80
7.3.11 Nonvolatile Cache element.....	81
7.3.12 Invalid Operation Reason element.....	82
7.3.13 Uninterruptible Power Supply element.....	83
7.3.14 Display element .....	85
7.3.15 Key Pad Entry element .....	86
7.3.16 Enclosure element .....	87
7.3.17 SCSI Port/Transceiver element .....	89
7.3.18 Language element .....	90
7.3.19 Communication Port element.....	92
7.3.20 Voltage Sensor element.....	92
7.3.21 Current Sensor element.....	93
7.3.22 SCSI Target Port element.....	94
7.3.23 SCSI Initiator Port element .....	95
7.3.24 Simple Subenclosure element .....	96
7.3.25 SAS Expander element.....	97
7.3.26 SAS Connector element .....	98

This page contains no comments

## Tables

	Page
1 Standards bodies .....	2
2 ISO and American numbering conventions .....	7
3 Sense keys and additional sense codes .....	14
4 Commands for standalone enclosure services processes .....	15
5 Diagnostic page codes for enclosure service devices .....	18
6 Layout of Configuration diagnostic page .....	19
7 Configuration diagnostic page .....	20
8 Enclosure descriptor .....	21
9 Type descriptor header format .....	22
10 Enclosure Control diagnostic page .....	24
11 ELEMENT CONTROL and OVERALL CONTROL field processing .....	25
12 Enclosure Status diagnostic page .....	26
13 Help Text diagnostic page .....	28
14 String Out diagnostic page .....	29
15 String In diagnostic page .....	29
16 Threshold Out diagnostic page .....	30
17 OVERALL THRESHOLD and the ELEMENT THRESHOLD fields for Threshold Out diagnostic page .....	31
18 Threshold In diagnostic page .....	32
19 OVERALL THRESHOLD and ELEMENT THRESHOLD fields for Threshold In diagnostic page .....	33
20 Element Descriptor diagnostic page .....	34
21 Element descriptor by type descriptor .....	35
22 Overall descriptor format and element descriptor format .....	35
23 Short Enclosure Status diagnostic page .....	36
24 Enclosure Busy diagnostic page .....	36
25 Additional Element Status diagnostic page .....	37
26 Additional Element Status descriptor with the EIP bit set to one .....	38
27 Additional Element Status descriptor with the EIP bit set to zero .....	38
28 Additional Element Status descriptor protocol-specific information for Fibre Channel with the EIP bit set to one .....	39
29 Additional Element Status descriptor protocol-specific information for Fibre Channel with the EIP bit set to zero .....	39
30 Port descriptor .....	40
31 BYPASS REASON field .....	41
32 Additional Element Status descriptor protocol-specific information for SAS .....	42
33 DESCRIPTOR TYPE field .....	42
34 Additional Element Status descriptor protocol-specific information for Device and Array Device elements for SAS with the EIP bit set to one .....	42
35 Additional Element Status descriptor protocol-specific information for Device and Array Device elements for SAS with the EIP bit set to zero .....	43
36 Phy descriptor .....	44
37 Additional Element Status descriptor protocol-specific information for SAS Expander elements .....	45
38 Expander phy descriptor .....	45
39 Additional Element Status descriptor protocol-specific information for SCSI Initiator Port, SCSI Target Port, and Enclosure Services Controller Electronics elements for SAS .....	46
40 Phy descriptor .....	46
41 Subenclosure Help Text diagnostic page .....	47
42 Subenclosure help text format .....	48
43 Subenclosure String Out diagnostic page .....	48
44 Subenclosure String In diagnostic page .....	49
45 Subenclosure string in data format .....	50
46 Supported SES Diagnostic Pages diagnostic page .....	51
47 Download Microcode Control diagnostic page .....	52
48 DOWNLOAD MICROCODE MODE field .....	53
49 Download Microcode Status diagnostic page .....	54
50 Download microcode status descriptor format .....	55

This page contains no comments



51 SUBENCLOSURE DOWNLOAD MICROCODE STATUS field .....	56
52 Subenclosure Nickname Control diagnostic page .....	57
53 Subenclosure Nickname Status diagnostic page .....	58
54 Subenclosure nickname status descriptor format .....	59
55 SUBENCLOSURE NICKNAME STATUS field .....	59
56 Log page codes for enclosure services devices .....	60
57 Mode page codes for enclosure services devices .....	60
58 Enclosure Services Management mode page .....	61
59 Element type codes .....	63
60 ELEMENT CONTROL and OVERALL CONTROL fields .....	64
61 ELEMENT STATUS and OVERALL STATUS fields .....	65
62 ELEMENT STATUS CODE field .....	65
63 Unspecified element for control-type diagnostic pages .....	66
64 Unspecified element for status-type diagnostic pages .....	66
65 Device element for the Enclosure Control diagnostic page .....	67
66 Device element for the Enclosure Status diagnostic page .....	68
67 Array Device element for the Enclosure Control diagnostic page .....	70
68 Array Device element for the Enclosure Status diagnostic page .....	71
69 Power Supply element for control-type diagnostic pages .....	72
70 Power Supply element for status-type diagnostic pages .....	72
71 Cooling element for control-type diagnostic pages .....	74
72 REQUESTED SPEED CODE field .....	74
73 Cooling element for status-type diagnostic pages .....	74
74 ACTUAL SPEED CODE field .....	75
75 Temperature Sensor element for control-type diagnostic pages .....	75
76 Temperature Sensor element for status-type diagnostic pages .....	76
77 Door Lock element for control-type diagnostic pages .....	77
78 Door Lock element for status-type diagnostic pages .....	77
79 Audible Alarm element for control-type diagnostic pages .....	77
80 Audible Alarm element for status-type diagnostic pages .....	78
81 Enclosure Services Controller Electronics element for control-type diagnostic pages .....	79
82 Enclosure Services Controller Electronics element for status-type diagnostic pages .....	80
83 SCC Controller Electronics element for control-type diagnostic pages .....	80
84 SCC Controller Electronics element for status-type diagnostic pages .....	80
85 Nonvolatile Cache element for control-type diagnostic pages .....	81
86 Nonvolatile Cache element for status-type diagnostic pages .....	81
87 SIZE MULTIPLIER field and NONVOLATILE CACHE SIZE field .....	81
88 Invalid Operation Reason element for control-type diagnostic pages .....	82
89 Invalid Operation Reason element for status-type diagnostic pages .....	82
90 INVOP TYPE field .....	82
91 Invalid Operation Reason element for status-type diagnostic pages with INVOP TYPE of 00b .....	82
92 Invalid Operation Reason element for status-type diagnostic pages with INVOP TYPE of 01b .....	83
93 Invalid Operation Reason element for status-type diagnostic pages with INVOP TYPE of 11b .....	83
94 Uninterruptible Power Supply element for control-type diagnostic pages .....	83
95 Uninterruptible Power Supply element for status-type diagnostic pages .....	84
96 Display element for control-type diagnostic pages .....	85
97 DISPLAY MODE field .....	85
98 Display element for status-type diagnostic pages .....	86
99 DISPLAY MODE STATUS field .....	86
100 Key Pad Entry element for control-type diagnostic pages .....	86
101 Key Pad Entry element for status-type diagnostic pages .....	87
102 Enclosure element for control-type diagnostic pages .....	87
103 POWER CYCLE REQUEST field .....	87
104 POWER CYCLE DELAY field .....	88
105 POWER OFF DURATION field .....	88
106 Enclosure element for status-type diagnostic pages .....	88
107 TIME UNTIL POWER CYCLE field .....	89

This page contains no comments

108 REQUESTED POWER OFF DURATION field .....	89
109 SCSI Port/Transceiver element for control-type diagnostic pages .....	90
110 SCSI Port/Transceiver element for status-type diagnostic pages .....	90
111 Language element for control-type diagnostic pages .....	91
112 Language element for status-type diagnostic pages .....	91
113 Communication Port element for control-type diagnostic pages .....	92
114 Communication Port element for status-type diagnostic pages .....	92
115 Voltage Sensor element for control-type diagnostic pages .....	93
116 Voltage Sensor element for status-type diagnostic pages .....	93
117 Current Sensor element for control-type diagnostic pages .....	94
118 Current Sensor element for status-type diagnostic pages .....	94
119 SCSI Target Port element for control-type diagnostic pages .....	95
120 SCSI Target Port element for status-type diagnostic pages .....	95
121 SCSI Initiator Port element for control-type diagnostic pages .....	96
122 SCSI Initiator Port element for status-type diagnostic pages .....	96
123 Simple Subenclosure element for control-type diagnostic pages .....	96
124 Simple Subenclosure element for status-type diagnostic pages .....	97
125 SAS Expander element for control-type diagnostic pages .....	97
126 SAS Expander element for status-type diagnostic pages .....	97
127 SAS Connector element for control-type diagnostic pages .....	98
128 SAS Connector element for status-type diagnostic pages .....	98
129 CONNECTOR TYPE field .....	99

This page contains no comments

**Figures**

	Page
1 SCSI document relationships .....	1
2 Standalone enclosure services process .....	9
3 Attached enclosure services process .....	10
4 Subenclosures .....	13

This page contains no comments

**Foreword (This foreword is not part of this standard)**

Requests for interpretation, suggestions for improvement and addenda, or defect reports are welcome. They should be sent to the INCITS Secretariat, International Committee for Information Technology Standards, Information Technology Institute, 1250 Eye Street, NW, Suite 200, Washington, DC 20005-3922.

This standard was processed and approved for submittal to ANSI by the International Committee for Information Technology Standards (INCITS). Committee approval of the standard does not necessarily imply that all committee members voted for approval. At the time it approved this standard, INCITS had the following members:

Karen Higginbottom, Chair

David Michael, Vice-Chair

INCITS Technical Committee T10 - SCSI Storage Interfaces, which developed and reviewed this standard, had the following members:

John B. Lohmeyer, Chair

George O. Penokie, Vice-Chair

Ralph O. Weber, Secretary



## Page: xvi

---

● Author: ibm-gop  
Subject: Highlight  
Date: 12/17/2007 12:10:58 PM -06'00'

 Forward:  
Should be: Mark S. Evans

Status  
relliott Accepted 12/13/2007 8:26:46 PM -06'00'

Status  
relliott Confirmed 12/13/2007 8:26:50 PM -06'00'

---

● Author: relliott  
Subject: Note  
Date: 5/12/2008 3:36:09 PM  
 DONE (as of 1/30/2008)  
Add T10 member list

Status  
relliott Accepted 1/30/2008 7:28:44 PM -06'00'

---



## Introduction

This standard is divided into the following clauses:

Clause 1 (Scope) describes the relationship of this standard to the SCSI family of standards.

Clause 2 (Normative references) provides references to other standards and documents.

Clause 3 (Definitions, symbols, abbreviations, and conventions) describes terms and conventions used throughout this standard.

Clause 4 (SCSI enclosure services model) describes the model for SCSI enclosure services peripheral devices, both standalone and attached.

Clause 5 (Commands for enclosure services peripheral devices) defines the command set for an enclosure services peripheral device.

Clause 6 (Parameters for enclosure services devices) defines diagnostic pages, log pages, and mode parameters and pages specific to SCSI enclosure services peripheral devices.

Clause 7 (Element definitions) defines elements used by several of the diagnostic pages.

# Page: xvii

---

● Author: relliott  
Subject: Highlight  
Date: 5/12/2008 3:36:09 PM

 an enclosure  
s/b  
a SCSI enclosure

Status  
relliott Accepted 12/15/2007 4:27:51 PM -06'00'  
Status  
relliott Confirmed 12/15/2007 4:27:54 PM -06'00'

---

● Author: relliott  
Subject: Note  
Date: 5/12/2008 3:36:09 PM  
 disable hyphenation from this (and all) paragraph styles

Status  
relliott Accepted 12/15/2007 4:32:31 PM -06'00'  
Status  
relliott Confirmed 12/15/2007 4:32:27 PM -06'00'

---



This page contains no comments

American National Standard  
for Information Technology -

# SCSI Enclosure Services - 2 (SES-2)

## 1 Scope

This standard documents the commands and parameters necessary to manage and sense the state of the power supplies, cooling devices, displays, indicators, individual drives, and other non-SCSI elements installed in an enclosure. The command set uses the SCSI SEND DIAGNOSTIC and RECEIVE DIAGNOSTIC RESULTS commands (see SPC-4) to obtain configuration information for the enclosure and to set and sense standard bits for each type of element that may be installed in the enclosure.

The following concepts from previous versions of this standard are made obsolete by this standard:

- a) Array Control and Array Status diagnostic pages (page code 06h); and
- b) subenclosure support in the Help Text, String Out, and String In diagnostic pages.

Figure 1 shows the relationship of this standard to the other standards and related projects in the SCSI family of standards. It is intended to show the general structure of SCSI standards, and is not intended to imply a relationship such as a hierarchy, protocol stack, or system architecture.

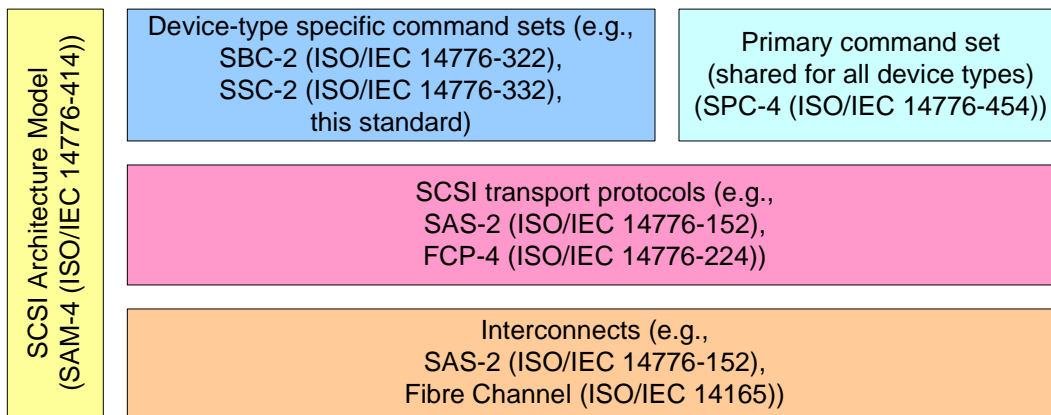

Figure 1 — SCSI document relationships

The set of SCSI standards specifies the interfaces, functions, and operations necessary to ensure interoperability between conforming SCSI implementations. This standard is a functional description. Conforming implementations may employ any design technique that does not violate interoperability.

# Page: 1

---

Author: ibm-gop  
Subject: Highlight  
Date: 12/17/2007 12:11:07 PM -06'00'

**T** Top of page

It would take a major miracle for SES-2 to be published in 2007. This should be either 2008 or the more safe 200x.

BSR INCITS xxx-2007

Status  
relliott Accepted 12/13/2007 8:37:42 PM -06'00'

Status  
relliott Confirmed 12/13/2007 8:37:45 PM -06'00'

---

Author: relliott  
Subject: Highlight  
Date: 5/12/2008 3:36:09 PM

**T** subenclosure support  
s/b

secondary subenclosure support

Status  
relliott Accepted 1/2/2008 6:52:32 PM -06'00'

---

## 2 Normative references

### 2.1 Normative references

The referenced standards and specifications contain provisions that, by reference in the text, constitute provisions of this standard. At the time of publication, the editions indicated were valid. All standards are subject to revision, and parties to agreements based on this standard are encouraged to investigate the possibility of applying the most recent editions of the standards listed below.

Copies of the following documents may be obtained from ANSI:

- a) approved ANSI standards;
- b) approved and draft international and regional standards (e.g., ISO and IEC); and
- c) approved and draft foreign standards (e.g., JIS and DIN).

For further information, contact ANSI Customer Service Department at 212-642-4900 (phone), 212-302-1286 (fax) or via the World Wide Web at <http://www.ansi.org>.

Additional availability contact information is provided below as needed.

Table 1 shows standards bodies and their web sites.

**Table 1 — Standards bodies**

Abbreviation	Standards body	Web site
ANSI	American National Standards Institute	<a href="http://www.ansi.org">http://www.ansi.org</a>
DIN	German Institute for Standardization	<a href="http://www.din.de">http://www.din.de</a>
IEC	International Engineering Consortium	<a href="http://www.iec.ch">http://www.iec.ch</a>
IEEE	Institute of Electrical and Electronics Engineers	<a href="http://www.ieee.org">http://www.ieee.org</a>
INCITS	International Committee for Information Technology Standards	<a href="http://www.incits.org">http://www.incits.org</a>
ISO	International Standards Organization	<a href="http://www.iso.ch">http://www.iso.ch</a>
ITI	Information Technology Industry Council	<a href="http://www.itic.org">http://www.itic.org</a>
JIS	Japanese Industrial Standards Committee	<a href="http://www.jisc.org">http://www.jisc.org</a>
T10	INCITS T10 SCSI storage interfaces	<a href="http://www.t10.org">http://www.t10.org</a>
T11	INCITS T11 Fibre Channel interfaces	<a href="http://www.t11.org">http://www.t11.org</a>
T13	INCITS T13 ATA storage interface	<a href="http://www.t13.org">http://www.t13.org</a>

### 2.2 Approved references

At the time of publication, the following referenced standards were approved.

ANSI INCITS 4-1986 (R2002), *Information Systems - Coded Character Sets - 7-Bit American National Standard Code for Information Interchange (7-Bit ASCII)*

ISO 639-1:2002, *Codes for the representation of names of languages - Part 1: Alpha-2 code*

ISO/IEC 8859-1:1998, *Information processing - 8-bit single-byte coded graphic character sets - Part 1: Latin alphabet No. 1*

ISO/IEC 10646-1:2000, *Universal Multiple-Octet Coded Character Set (UCS) - Part 1: Architecture and Basic Multilingual Plane (BMP)*

IEC 60027-2:2000, *Letter symbols to be used in electrical technology - Part 2: Telecommunications and electronics*

ISO/IEC 14776-342, *SCSI-3 Controller Commands - 2 (SCC-2)*(ANSI INCITS 318-1998)

Author: relliott  
Subject: Highlight  
Date: 5/12/2008 3:36:09 PM  
T Information processing  
s/b  
Information technology

to match how this is listed on the iso.org web site

Status  
relliott Accepted 1/2/2008 3:00:12 PM -06'00'

---

Author: relliott  
Subject: Highlight  
Date: 5/12/2008 3:36:09 PM  
T ISO/IEC 10646-1:2000  
s/b  
ISO/IEC 10646:2003  
without the Part stuff

Status  
relliott Accepted 1/2/2008 3:00:23 PM -06'00'

---



## 2.3 References under development

At the time of publication, the following referenced standards were still under development. For information on the current status of the document, or regarding availability, contact the relevant standards body or other organization as indicated.

ISO/IEC 14776-152, *Serial Attached SCSI - 2 (SAS-2)*(T10/1760-D)

ISO/IEC 14776-224, *Fibre Channel Protocol - 4 (FCP-4)*(T10/1828-D)

ISO/IEC 14776-414, *SCSI Architecture Model - 4 (SAM-4)*(T10/1683-D)

ISO/IEC 14776-454, *SCSI Primary Commands - 4 (SPC-4)*(T10/1731-D)

NOTE 1 - For more information on the current status of these documents, contact the INCITS Secretariat at 202-737-8888 (phone), 202-638-4922 (fax) or via Email at [incits@itic.org](mailto:incits@itic.org). To obtain copies of this document, contact Global Engineering at 15 Inverness Way, East Englewood, CO 80112-5704 at 303-792-2181 (phone), 800-854-7179 (phone), or 303-792-2192 (fax), or see <http://www.incits.org>.

## 2.4 Other references

For information on the current status of the listed documents, or regarding availability, contact the indicated organization.

*Serial ATA 2.6 (SATA-2)*. 15 February 2007

NOTE 2 - For information on the current status of Serial ATA documents, see the Serial ATA International Organization at <http://www.sata-io.org>.

SFF-8067, *Specification for 40-pin SCA-2 Connector w/Bidirectional ESI*, ~~Revision 3.3, 27 January 2005~~

SFF-8087, *Compact Multilane Series: Unshielded*

SFF-8088, *Compact Multilane Series: Shielded*

SFF-8470, *Shielded High Speed Multilane Copper Connector*

SFF-8482, *Unshielded Dual Port Serial Attachment Connector*

SFF-8484, *Multi-Lane Unshielded Serial Attachment Connectors*

NOTE 3 - For more information on the current status of the SFF documents, contact the SFF Committee at 408-867-6630 (phone), or 408-867-2115 (fax). To obtain copies of these documents, contact the SFF Committee at 14426 Black Walnut Court, Saratoga, CA 95070 at 408-867-6630 (phone) or 408-741-1600 (fax) or see <http://www.sffcommittee.org>.





*The Unicode Standard, Version 4.0*

NOTE 4 - For information on the current status and availability of the document, contact the Unicode Consortium at P.O. Box 700519, San Jose, CA 95170-0519 or see <http://www.unicode.org>.

## Page: 3

---

● Author: relliott  
Subject: Cross-Out  
Date: 5/12/2008 3:36:09 PM  
 Delete:  
 Revision 3.3, 27 January 2005

since none of the other SFF references include version numbers. [It is important to use a recent version of SFF-8067 since the SES diagnostic page address range was increased.]

Status  
relliott Accepted 1/2/2008 3:02:09 PM -06'00'

---

● Author: symc-roger  
Subject: Note  
Date: 12/17/2007 12:11:12 PM -06'00'  
 SYMANTEC 01  
PDF pg 21, pg 3, 2.4 Other references

Delete reference to Unicode - not used elsewhere in the document.

Proposed Resolution:

Remove reference

Status  
relliott Accepted 12/13/2007 8:40:02 PM -06'00'

Status  
relliott Confirmed 12/13/2007 8:40:06 PM -06'00'

---

## 3 Definitions, symbols, abbreviations, and conventions

### 3.1 Definitions

**3.1.1 application client:** An object that is the source of SCSI commands and task management function requests. See SAM-4.

**3.1.2 ASCII string:** A string of US-ASCII characters each encoded in 8 bits per ISO/IEC 8859-1 containing only graphic characters (i.e., code values 20h through 7Eh). ASCII strings do not contain the NUL character (i.e., 00h).

**3.1.3 attached enclosure services process:** An enclosure services process (see 3.1.13) that is attached to another device server. See 4.1.3.

**3.1.4 byte:** A sequence of eight contiguous bits considered as a unit.

**3.1.5 command descriptor block (CDB):** The structure used to communicate a command from an application client to a device server. See SAM-4.

**3.1.6 device server:** An object within a logical unit that processes SCSI tasks. See SAM-4.

**3.1.7 critical condition:** An enclosure condition established when one or more elements inside the enclosure have failed or are operating outside of their specifications. The failure of the element makes continued normal operation of at least some elements in the enclosure impossible. Some elements within the enclosure may be able to continue normal operation.

**3.1.8 device:** A mechanical, electrical, or electronic contrivance with a specific purpose.

**3.1.9 device slot:** A position into which a SCSI device may be inserted in an enclosure. The position provides appropriate power, signal, and control connections to the SCSI device. The position may also provide mechanical protection, locking capability, automatic insertion, visual device status indicators, and other features to manage the SCSI device in the enclosure.

**3.1.10 element:** An object related to an enclosure. The object can be controlled, interrogated, or described by the enclosure services process.

**3.1.11 enclosure:** The box, rack, or set of boxes providing the powering, cooling, mechanical protection, and external electronic interfaces for one or more SCSI devices.

**3.1.12 enclosure services (ES):** Those services that establish the mechanical environment, electrical environment, and external indicators and controls for the proper operation and maintenance of devices within an enclosure.

**3.1.13 enclosure services process:** The object that manages and implements enclosure services; either a standalone enclosure services process (see 3.1.29) or an attached enclosure services process (see 3.1.3). See 4.1.

**3.1.14 field:** A group of one or more contiguous bits.

**3.1.15 hard reset:** A condition resulting from the events defined by SAM-4 in which the SCSI device performs the hard reset operations described in SAM-4, this standard, and other applicable command standards (see table 4 in clause 5).

**3.1.16 I\_T nexus loss:** A condition resulting from the events defined by SAM-4 in which the SCSI device performs the I\_T nexus loss operations described in SAM-4, this standard, and other applicable command standards (see table 4 in clause 5).

## Page: 4

---

Author: ibm-gop  
Subject: Highlight  
Date: 12/13/2007 8:24:47 PM -06'00'

**T** 3.1.1 application client  
This << An object that is the source of SCSI commands and task management function requests. >> should be << A class whose objects are, or an object that is, the source of commands and task management function requests. >>

Status  
relliott Accepted 1/2/2008 3:03:33 PM -06'00'

---

Author: symc-roger  
Subject: Note  
Date: 12/13/2007 8:25:13 PM -06'00'

**S** SYMANTEC 02  
PDF pg 22, pg 4, 3.1.2 ASCII string

Make the exclusion of NUL character a requirement.

Proposed Resolution:

"ASCII strings shall not contain the NUL character (i.e., 00h)."

Status  
relliott Rejected 1/2/2008 4:41:09 PM -06'00'

---

Author: relliott  
Subject: Note  
Date: 1/2/2008 4:41:07 PM -06'00'



Shalls are not allowed in definitions.

If a string contains a NUL, it doesn't meet this definition and is something other than an ASCII string.

There might be some "shall"s in text defining the fields containing ASCII strings.

---

Author: relliott  
Subject: Highlight  
Date: 5/12/2008 3:36:09 PM

**T** device server  
s/b  
device server (see 3.1.3)

Status  
relliott Accepted 12/13/2007 9:24:02 PM -06'00'

Status  
relliott Confirmed 12/13/2007 9:23:59 PM -06'00'

---

Author: relliott  
Subject: Highlight  
Date: 5/12/2008 3:36:09 PM

**T** another device server  
s/b  
a device server in another SCSI target device

Status  
relliott Accepted 12/21/2007 5:56:36 PM -06'00'

---

Author: relliott  
Subject: Note  
Date: 5/12/2008 3:36:09 PM

**S** add

command

A request describing a unit of work to be performed by a device server. See SAM-4.

Comments from page 4 continued on next page

## 3 Definitions, symbols, abbreviations, and conventions

### 3.1 Definitions

**3.1.1 application client:** An object that is the source of SCSI commands and task management function requests. See SAM-4.

**3.1.2 ASCII string:** A string of US-ASCII characters each encoded in 8 bits per ISO/IEC 8859-1 containing only graphic characters (i.e., code values 20h through 7Eh). ASCII strings do not contain the NUL character (i.e., 00h).

**3.1.3 attached enclosure services process:** An enclosure services process (see 3.1.13) that is attached to another device server. See 4.1.3.

**3.1.4 byte:** A sequence of eight contiguous bits considered as a unit.

**3.1.5 command descriptor block (CDB):** The structure used to communicate a command from an application client to a device server. See SAM 4.

**3.1.6 device server:** An object within a logical unit that processes SCSI tasks. See SAM-4.

**3.1.7 critical condition:** An enclosure condition established when one or more elements inside the enclosure have failed or are operating outside of their specifications. The failure of the element makes continued normal operation of at least some elements in the enclosure impossible. Some elements within the enclosure may be able to continue normal operation.

**3.1.8 device:** A mechanical, electrical, or electronic contrivance with a specific purpose.

**3.1.9 device slot:** A position into which a SCSI device may be inserted in an enclosure. The position provides appropriate power, signal, and control connections to the SCSI device. The position may also provide mechanical protection, locking capability, automatic insertion, visual device status indicators, and other features to manage the SCSI device in the enclosure.

**3.1.10 element:** An object related to an enclosure. The object can be controlled, interrogated, or described by the enclosure services process.

**3.1.11 enclosure:** The box, rack, or set of boxes providing the powering, cooling, mechanical protection, and external electronic interfaces for one or more SCSI devices.

**3.1.12 enclosure services (ES):** Those services that establish the mechanical environment, electrical environment, and external indicators and controls for the proper operation and maintenance of devices within an enclosure.

**3.1.13 enclosure services process:** The object that manages and implements enclosure services; either a standalone enclosure services process (see 3.1.29) or an attached enclosure services process (see 3.1.3). See 4.1.

**3.1.14 field:** A group of one or more contiguous bits.

**3.1.15 hard reset:** A condition resulting from the events defined by SAM-4 in which the SCSI device performs the hard reset operations described in SAM-4, this standard, and other applicable command standards (see table 4 in clause 5).

**3.1.16 I\_T nexus loss:** A condition resulting from the events defined by SAM-4 in which the SCSI device performs the I\_T nexus loss operations described in SAM-4, this standard, and other applicable command standards (see table 4 in clause 5).

Status  
relliott Accepted 1/2/2008 4:24:22 PM -06'00'

---



Author: ibm-gop  
Subject: Highlight  
Date: 12/13/2007 8:24:47 PM -06'00'

 3.1.6 device server  
This << An object within a logical unit that processes SCSI tasks. >> should be << A class whose objects process, or an object that processes, SCSI [commands](#) according to the requirements for [command](#) management >>

Status  
relliott Rejected 1/2/2008 3:06:10 PM -06'00'

---

Author: relliott  
Subject: Note  
Date: 1/2/2008 3:06:07 PM -06'00'

 without "SCSI" in front of "commands"  
 without "according to the requirements for command management". Just referring to SAM-4 suffices at that point.

---

Author: symc-roger  
Subject: Note  
Date: 12/13/2007 8:25:13 PM -06'00'

 SYMANTEC 03  
PDF pg 22, pg 4, 3.1.6 Device Server

This definition is out of order, and should reference SAM-4.

Proposed Resolution:

Add "See SAM-4"

Status  
relliott Accepted 12/13/2007 10:27:43 PM -06'00'

Status  
relliott Confirmed 12/13/2007 10:27:47 PM -06'00'

---

Author: relliott  
Subject: Note  
Date: 12/13/2007 10:28:11 PM -06'00'

 it already references SAM-4. Moved the line to its proper position.

---

Author: relliott  
Subject: Note  
Date: 5/12/2008 3:36:09 PM

 add:  
**class**  
**A description of a set of objects (see 3.1.25) that share the same characteristics. See SAM-4.**  
**object**  
**An entity with a well-defined boundary and identity that encapsulates state and behavior. See SAM-4.**

---

Status  
relliott Accepted 1/2/2008 4:24:47 PM -06'00'

---

Author: ibm-gop  
Subject: Highlight  
Date: 12/13/2007 8:24:47 PM -06'00'

 3.1.10 element  
This << An object related to an enclosure. The object can be controlled, interrogated, or described by the enclosure services process. >> should be << A class related to an enclosure whose objects, or an object that is, controlled, interrogated, or described by the enclosure services process. >>

Status  
relliott Rejected 1/2/2008 4:10:25 PM -06'00'

---

Author: relliott  
Subject: Note  
Date: 1/2/2008 4:10:21 PM -06'00'

Comments from page 4 continued on next page

## 3 Definitions, symbols, abbreviations, and conventions

### 3.1 Definitions

**3.1.1 application client:** An object that is the source of SCSI commands and task management function requests. See SAM-4.

**3.1.2 ASCII string:** A string of US-ASCII characters each encoded in 8 bits per ISO/IEC 8859-1 containing only graphic characters (i.e., code values 20h through 7Eh). ASCII strings do not contain the NUL character (i.e., 00h).

**3.1.3 attached enclosure services process:** An enclosure services process (see 3.1.13) that is attached to another device server. See 4.1.3.

**3.1.4 byte:** A sequence of eight contiguous bits considered as a unit.

**3.1.5 command descriptor block (CDB):** The structure used to communicate a command from an application client to a device server. See SAM-4.

**3.1.6 device server:** An object within a logical unit that processes SCSI tasks. See SAM-4.

**3.1.7 critical condition:** An enclosure condition established when one or more elements inside the enclosure have failed or are operating outside of their specifications. The failure of the element makes continued normal operation of at least some elements in the enclosure impossible. Some elements within the enclosure may be able to continue normal operation.

**3.1.8 device:** A mechanical, electrical, or electronic contrivance with a specific purpose.

**3.1.9 device slot:** A position into which a SCSI device may be inserted in an enclosure. The position provides appropriate power, signal, and control connections to the SCSI device. The position may also provide mechanical protection, locking capability, automatic insertion, visual device status indicators, and other features to manage the SCSI device in the enclosure.

**3.1.10 element:** An object related to an enclosure. The object can be controlled, interrogated, or described by the enclosure services process.

**3.1.11 enclosure:** The box, rack, or set of boxes providing the powering, cooling, mechanical protection, and external electronic interfaces for one or more SCSI devices.

**3.1.12 enclosure services (ES):** Those services that establish the mechanical environment, electrical environment, and external indicators and controls for the proper operation and maintenance of devices within an enclosure.

**3.1.13 enclosure services process:** The object that manages and implements enclosure services; either a standalone enclosure services process (see 3.1.29) or an attached enclosure services process (see 3.1.3). See 4.1.

**3.1.14 field:** A group of one or more contiguous bits.

**3.1.15 hard reset:** A condition resulting from the events defined by SAM-4 in which the SCSI device performs the hard reset operations described in SAM-4, this standard, and other applicable command standards (see table 4 in clause 5).

**3.1.16 I\_T nexus loss:** A condition resulting from the events defined by SAM-4 in which the SCSI device performs the I\_T nexus loss operations described in SAM-4, this standard, and other applicable command standards (see table 4 in clause 5).

 Other changes to this definition remove the "object" term. Without adding UML to SES-2, it wouldn't make sense to define element as a class/object.

---

● Author: ibm-gop  
Subject: Highlight  
Date: 12/13/2007 8:24:47 PM -06'00'

 3.1.13 enclosure services process:

This << The object that manages and implements enclosure services; either a standalone enclosure services process (see 3.1.29) or an attached enclosure services process (see 3.1.3). >> should be << A class whose objects, or an object that, manages and implements enclosure services; either a standalone enclosure services process (see 3.1.29) or an attached enclosure services process (see 3.1.3). >>

Status  
relliott Rejected 1/2/2008 4:13:59 PM -06'00'

---

Author: relliott  
Subject: Note  
Date: 3/19/2008 1:21:51 PM

 Just changed "object" to "process" to avoid using the UML term and zapped the semicolon

---

● Author: symc-roger  
Subject: Note  
Date: 12/13/2007 8:25:13 PM -06'00'

 SYMANTEC 04  
PDF pg 22, pg 4, 3.1.14 field

Definition should reference SPC-4

Proposed Resolution:

Add "See SPC-4"

Status  
relliott Rejected 12/13/2007 10:29:28 PM -06'00'

---

Author: relliott  
Subject: Note  
Date: 12/13/2007 10:29:23 PM -06'00'

 SPC-4 doesn't own that term.

---



**3.1.17 information condition:** An enclosure condition that should be made known to the application client. The condition is not an error and does not reduce the capabilities of the devices in the enclosure.

**3.1.18 logical unit:** An externally addressable entity within a SCSI target device. See SAM-4.

**3.1.19 logical unit number:** An identifier for a logical unit. See SAM-4.

**3.1.20 logical unit reset:** A condition resulting from the events defined by SAM-4 in which the logical unit performs the logical unit reset operations described in SAM-4, this standard, and other applicable command standards (see table 4 in clause 5).

**3.1.21 noncritical condition:** An enclosure condition established when one or more elements inside the enclosure have failed or are operating outside of their specifications. The failure of the elements does not affect continued normal operation of the enclosure. All SCSI devices in the enclosure continue to operate according to their specifications. The ability of the devices to operate correctly if additional failures occur may be reduced by a noncritical condition.

**3.1.22 port:** A part of a SCSI device that connects the application client, device server, or task manager to a service delivery subsystem. See SAM-4.

**3.1.23 power on:** A condition resulting from the events defined by SAM-4 in which the SCSI device performs the power on operations described in SAM-4, this standard, and other applicable command standards (see table 4 in clause 5).

**3.1.24 redundancy:** The presence in an enclosure of one or more elements capable of automatically taking over the functions of an element that has failed.

**3.1.25 SCSI initiator device:** A SCSI device containing application clients and SCSI initiator ports that originate device service and task management requests to be processed by a SCSI target device and receive device service and task management responses from SCSI target devices. See SAM-4.

**3.1.26 SCSI initiator port:** A SCSI initiator device object acts as the connection between application clients and the service delivery subsystem through which requests and responses are routed. See SAM-4.

**3.1.27 SCSI target device:** A SCSI device containing logical units and SCSI target ports that receives device service and task management requests for processing and sends device service and task management responses to SCSI initiator devices. See SAM-4.

**3.1.28 SCSI target port:** A SCSI target device object that contains a task router and acts as the connection between device servers and task managers and the service delivery subsystem through which requests and responses are routed. See SAM-4.

**3.1.29 standalone enclosure services process:** An enclosure services process (see 3.1.13) that is also the device server. See 4.1.2.

**3.1.30 subenclosure:** An enclosure accessed through a primary subenclosure's enclosure service process (see 3.1.13). See 4.7.

**3.1.31 text string:** A string of characters using the character encoding and language specified by the Language element (see 7.3.18) containing only graphic characters. Text strings do not contain the NULL character (i.e., 00h or 0000h).

**3.1.32 unrecoverable condition:** An enclosure condition established when one or more elements inside the enclosure have failed and have disabled some functions of the enclosure. The enclosure may be incapable of recovering or bypassing the failure and requires repairs to correct the condition.

Author: ibm-gop  
Subject: Highlight  
Date: 12/13/2007 8:24:47 PM -06'00'

T 3.1.18 logical unit:

This << An externally addressable entity within a SCSI target device. >> should be << A class whose objects implement, or an object that implements a device model and manages [and](#) processes commands sent by an application client. >>

Status  
relliott Accepted 1/2/2008 3:08:53 PM -06'00'

Author: relliott  
Subject: Note  
Date: 1/2/2008 3:08:50 PM -06'00'  
...a device model THAT manages ...

Author: ibm-gop  
Subject: Highlight  
Date: 12/13/2007 8:24:47 PM -06'00'

T 3.1.19 logical unit number:

The title of this should be << logical unit number (LUN): >>

Status  
relliott Accepted 12/13/2007 8:41:06 PM -06'00'

Status  
relliott Confirmed 12/13/2007 8:41:11 PM -06'00'

Author: relliott  
Subject: Highlight  
Date: 5/12/2008 3:36:09 PM

T port:  
s/b  
SCSI port:

Status  
relliott Accepted 12/19/2007 7:23:46 PM -06'00'

Author: relliott  
Subject: Highlight  
Date: 5/12/2008 3:36:09 PM

T that connections the  
s/b  
that connects

Status  
relliott Accepted 12/20/2007 8:23:07 PM -06'00'

Author: ibm-gop  
Subject: Highlight  
Date: 12/13/2007 8:24:47 PM -06'00'

T 3.1.25 SCSI initiator device:

This << A SCSI device containing application clients and SCSI initiator ports that originate device service and task management requests to be processed by a SCSI target device and receive device service and task management responses from SCSI target devices. See SAM-4. >> should be << A class whose objects originate, or an object that originates, device service and [command](#) management requests to be processed by a SCSI target device and receives device service and [command](#) management responses from SCSI target devices. When used this term refers to SCSI initiator devices. See SAM-4. >>

Status  
relliott Accepted 1/2/2008 4:33:39 PM -06'00'

Author: relliott  
Subject: Note  
Date: 1/2/2008 3:40:53 PM -06'00'  
command management s/b task management  
and the "When used sentence" doesn't belong

**3.1.17 information condition:** An enclosure condition that should be made known to the application client. The condition is not an error and does not reduce the capabilities of the devices in the enclosure.

**3.1.18 logical unit:** An externally addressable entity within a SCSI target device. See SAM-4.

**3.1.19 logical unit number:** An identifier for a logical unit. See SAM-4.

**3.1.20 logical unit reset:** A condition resulting from the events defined by SAM-4 in which the logical unit performs the logical unit reset operations described in SAM-4, this standard, and other applicable command standards (see table 4 in clause 5).

**3.1.21 noncritical condition:** An enclosure condition established when one or more elements inside the enclosure have failed or are operating outside of their specifications. The failure of the elements does not affect continued normal operation of the enclosure. All SCSI devices in the enclosure continue to operate according to their specifications. The ability of the devices to operate correctly if additional failures occur may be reduced by a noncritical condition.

**3.1.22 port:** A part of a SCSI device that connects the application client, device server, or task manager to a service delivery subsystem. See SAM-4.

**3.1.23 power on:** A condition resulting from the events defined by SAM-4 in which the SCSI device performs the power on operations described in SAM-4, this standard, and other applicable command standards (see table 4 in clause 5).

**3.1.24 redundancy:** The presence in an enclosure of one or more elements capable of automatically taking over the functions of an element that has failed.

**3.1.25 SCSI initiator device:** A SCSI device containing application clients and SCSI initiator ports that originate device service and task management requests to be processed by a SCSI target device and receive device service and task management responses from SCSI target devices. See SAM-4.

**3.1.26 SCSI initiator port:** A SCSI initiator device object acts as the connection between application clients and the service delivery subsystem through which requests and responses are routed. See SAM-4.

**3.1.27 SCSI target device:** A SCSI device containing logical units and SCSI target ports that receives device service and task management requests for processing and sends device service and task management responses to SCSI initiator devices. See SAM-4.

**3.1.28 SCSI target port:** A SCSI target device object that contains a task router and acts as the connection between device servers and task managers and the service delivery subsystem through which requests and responses are routed. See SAM-4.

**3.1.29 standalone enclosure services process:** An enclosure services process (see 3.1.13) that is also the device server. See 4.1.2.

**3.1.30 subenclosure:** An enclosure accessed through a primary subenclosure's enclosure service process (see 3.1.13). See 4.7.

**3.1.31 text string:** A string of characters using the character encoding and language specified by the Language element (see 7.3.18) containing only graphic characters. Text strings do not contain the NULL character (i.e., 00h or 0000h).

**3.1.32 unrecoverable condition:** An enclosure condition established when one or more elements inside the enclosure have failed and have disabled some functions of the enclosure. The enclosure may be incapable of recovering or bypassing the failure and requires repairs to correct the condition.

---

Author: ibm-gop  
Subject: Highlight  
Date: 12/13/2007 8:24:47 PM -06'00'

**T** 3.1.26 SCSI initiator port:

This << A SCSI initiator device object acts as the connection between application clients and the service delivery subsystem through which requests and responses are routed. See SAM-4. >> should be << A class whose objects act, or an object that acts, the connection between application clients and a service delivery subsystem through which requests, indications, responses, and confirmations are routed. In all cases when this term is used it refers to a SCSI initiator port. See SAM-4. >>

Status

relliott Accepted 1/2/2008 4:34:25 PM -06'00'

---

Author: relliott

Subject: Note

Date: 1/2/2008 4:34:25 PM -06'00'

 with an added "as"

 without the "In all cases" sentence.

---

Author: ibm-gop  
Subject: Highlight  
Date: 12/13/2007 8:24:47 PM -06'00'

**T** 3.1.27 SCSI target device:

This << A SCSI device containing logical units and SCSI target ports that receives device service and task management requests for processing and sends device service and task management responses to SCSI initiator devices. See SAM-4. >> should be << A class whose objects receive, or an object that receives, device service and task management requests for processing and sends device service and task management responses to SCSI initiator devices. When used this term refers to SCSI target devices. See SAM-4 >>

Status

relliott Accepted 1/2/2008 4:34:48 PM -06'00'

---

Author: ibm-gop  
Subject: Highlight  
Date: 12/13/2007 8:24:47 PM -06'00'

**T** 3.1.28 SCSI target port:

This << A SCSI target device object that contains a task router and acts as the connection between device servers and task managers and the service delivery subsystem through which requests and responses are routed. See SAM-4. >> should be << A class whose objects contain, or an object that contains, a task router and acts as the connection between device servers and task managers and a service delivery subsystem through which indications and responses are routed. When this term is used it refers to a SCSI target port. See SAM-4 >>

Status

relliott Accepted 1/2/2008 4:35:09 PM -06'00'

---

Author: relliott

Subject: Note

Date: 1/2/2008 4:35:09 PM -06'00'

 Without "When this term" sentence.

---

Author: relliott  
Subject: Note  
Date: 5/12/2008 3:36:09 PM

 add

**simple subenclosure**

**A subenclosure (see 3.1.34) that does not support any SES diagnostic page (see 6.1.1) except the Short Enclosure Status diagnostic page (see 6.1.11). See 4.7.**

---

Status

relliott Accepted 12/21/2007 5:58:16 PM -06'00'

---

Author: relliott  
Subject: Note  
Date: 5/12/2008 3:36:09 PM

Comments from page 5 continued on next page

**3.1.17 information condition:** An enclosure condition that should be made known to the application client. The condition is not an error and does not reduce the capabilities of the devices in the enclosure.

**3.1.18 logical unit:** An externally addressable entity within a SCSI target device. See SAM-4.

**3.1.19 logical unit number:** An identifier for a logical unit. See SAM-4.

**3.1.20 logical unit reset:** A condition resulting from the events defined by SAM-4 in which the logical unit performs the logical unit reset operations described in SAM-4, this standard, and other applicable command standards (see table 4 in clause 5).

**3.1.21 noncritical condition:** An enclosure condition established when one or more elements inside the enclosure have failed or are operating outside of their specifications. The failure of the elements does not affect continued normal operation of the enclosure. All SCSI devices in the enclosure continue to operate according to their specifications. The ability of the devices to operate correctly if additional failures occur may be reduced by a noncritical condition.

**3.1.22 port:** A part of a SCSI device that connects the application client, device server, or task manager to a service delivery subsystem. See SAM-4.

**3.1.23 power on:** A condition resulting from the events defined by SAM-4 in which the SCSI device performs the power on operations described in SAM-4, this standard, and other applicable command standards (see table 4 in clause 5).

**3.1.24 redundancy:** The presence in an enclosure of one or more elements capable of automatically taking over the functions of an element that has failed.

**3.1.25 SCSI initiator device:** A SCSI device containing application clients and SCSI initiator ports that originate device service and task management requests to be processed by a SCSI target device and receive device service and task management responses from SCSI target devices. See SAM-4.

**3.1.26 SCSI initiator port:** A SCSI initiator device object acts as the connection between application clients and the service delivery subsystem through which requests and responses are routed. See SAM-4.

**3.1.27 SCSI target device:** A SCSI device containing logical units and SCSI target ports that receives device service and task management requests for processing and sends device service and task management responses to SCSI initiator devices. See SAM-4.

**3.1.28 SCSI target port:** A SCSI target device object that contains a task router and acts as the connection between device servers and task managers and the service delivery subsystem through which requests and responses are routed. See SAM-4.

**3.1.29 standalone enclosure services process:** An enclosure services process (see 3.1.13) that is also the device server. See 4.1.2.

**3.1.30 subenclosure:** An enclosure accessed through a primary subenclosure's enclosure service process (see 3.1.13). See 4.7.

**3.1.31 text string:** A string of characters using the character encoding and language specified by the Language element (see 7.3.18) containing only graphic characters. Text strings do not contain the NULL character (i.e., 00h or 0000h).

**3.1.32 unrecoverable condition:** An enclosure condition established when one or more elements inside the enclosure have failed and have disabled some functions of the enclosure. The enclosure may be incapable of recovering or bypassing the failure and requires repairs to correct the condition.

 Add:

**primary subenclosure**

**A subenclosure (see 3.1.34) whose enclosure services process (see 3.1.15) provides access to enclosure services information of all the subenclosures in an enclosure. See 4.6.**

**secondary subenclosure**

**A subenclosure (see 3.1.34) whose enclosure services process (see 3.1.15) does not access to enclosure services information of all the subenclosures in an enclosure. See 4.6.**

Status  
relliott Accepted 12/21/2007 5:54:31 PM -06'00'

---

Author: relliott  
Subject: Highlight  
Date: 5/12/2008 3:36:09 PM  
 device server  
s/b  
device server (see 3.1.6)

Status  
relliott Accepted 12/13/2007 9:24:23 PM -06'00'  
Status  
relliott Confirmed 12/13/2007 9:24:20 PM -06'00'

---

Author: relliott  
Subject: Note  
Date: 5/12/2008 3:36:09 PM

 Add:

**task manager**

**A class within a logical unit whose objects control, or an object that controls the sequencing of commands and processes task management functions. See SAM-4.**

Status  
relliott Accepted 1/2/2008 4:18:25 PM -06'00'

---

Author: relliott  
Subject: Highlight  
Date: 5/12/2008 3:36:09 PM  
 enclosure service process  
s/b  
enclosure services process

Status  
relliott Accepted 12/13/2007 9:17:46 PM -06'00'  
Status  
relliott Confirmed 12/13/2007 9:17:49 PM -06'00'

---

Author: symc-roger  
Subject: Note  
Date: 12/13/2007 8:25:13 PM -06'00'

 SYMANTEC 05  
PDF pg 23, pg 5, 3.1.30 subenclosure

Definition is recursive

Proposed Resolution:

subenclosure: An entity containing, and defining the scope of, one of more enclosure service processes (see 3.1.13). Each enclosure accessed shall have a single primary subenclosure, and may have other subenclosures. See 4.7.

Status  
relliott Rejected 12/21/2007 5:57:46 PM -06'00'

---

Author: relliott  
Subject: Note  
Date: 12/21/2007 5:57:46 PM -06'00'

Comments from page 5 continued on next page

**3.1.17 information condition:** An enclosure condition that should be made known to the application client. The condition is not an error and does not reduce the capabilities of the devices in the enclosure.

**3.1.18 logical unit:** An externally addressable entity within a SCSI target device. See SAM-4.

**3.1.19 logical unit number:** An identifier for a logical unit. See SAM-4.

**3.1.20 logical unit reset:** A condition resulting from the events defined by SAM-4 in which the logical unit performs the logical unit reset operations described in SAM-4, this standard, and other applicable command standards (see table 4 in clause 5).

**3.1.21 noncritical condition:** An enclosure condition established when one or more elements inside the enclosure have failed or are operating outside of their specifications. The failure of the elements does not affect continued normal operation of the enclosure. All SCSI devices in the enclosure continue to operate according to their specifications. The ability of the devices to operate correctly if additional failures occur may be reduced by a noncritical condition.

**3.1.22 port:** A part of a SCSI device that connects the application client, device server, or task manager to a service delivery subsystem. See SAM-4.

**3.1.23 power on:** A condition resulting from the events defined by SAM-4 in which the SCSI device performs the power on operations described in SAM-4, this standard, and other applicable command standards (see table 4 in clause 5).

**3.1.24 redundancy:** The presence in an enclosure of one or more elements capable of automatically taking over the functions of an element that has failed.

**3.1.25 SCSI initiator device:** A SCSI device containing application clients and SCSI initiator ports that originate device service and task management requests to be processed by a SCSI target device and receive device service and task management responses from SCSI target devices. See SAM-4.

**3.1.26 SCSI initiator port:** A SCSI initiator device object acts as the connection between application clients and the service delivery subsystem through which requests and responses are routed. See SAM-4.

**3.1.27 SCSI target device:** A SCSI device containing logical units and SCSI target ports that receives device service and task management requests for processing and sends device service and task management responses to SCSI initiator devices. See SAM-4.

**3.1.28 SCSI target port:** A SCSI target device object that contains a task router and acts as the connection between device servers and task managers and the service delivery subsystem through which requests and responses are routed. See SAM-4.

**3.1.29 standalone enclosure services process:** An enclosure services process (see 3.1.13) that is also the device server. See 4.1.2.

**3.1.30 subenclosure:** An enclosure accessed through a primary subenclosure's enclosure service process (see 3.1.13). See 4.7.

**3.1.31 text string:** A string of characters using the character encoding and language specified by the Language element (see 7.3.18) containing only graphic characters. Text strings do not contain the NULL character (i.e., 00h or 0000h).

**3.1.32 unrecoverable condition:** An enclosure condition established when one or more elements inside the enclosure have failed and have disabled some functions of the enclosure. The enclosure may be incapable of recovering or bypassing the failure and requires repairs to correct the condition.

 A portion of an enclosure (see 3.1.13) accessed through a primary subenclosure's (see 3.1.25) enclosure services process (see 3.1.15). See 4.6

---

● Author: relliott  
Subject: Note  
Date: 5/12/2008 3:36:09 PM

 add  
**task management function**  
**A task manager service capable of being requested by an application client to affect the processing of one or more commands. See SAM-4.**

Status  
relliott Accepted 1/2/2008 4:23:41 PM -06'00'

---

● Author: relliott  
Subject: Highlight  
Date: 5/12/2008 3:36:09 PM

 specified by the  
Language element  
s/b  
indicated by the Language element

Status  
relliott Accepted 1/4/2008 12:42:14 PM -06'00'

---

● Author: symc-roger  
Subject: Note  
Date: 12/13/2007 8:25:13 PM -06'00'

 SYMANTEC 06  
PDF pg 23, pg 5, 3.1.31 text string

Definition for graphic characters is required or it needs to be deleted, and the exclusion of NUL character needs to be a requirement

Proposed Resolution:

3.1.31 text string: A string of characters using the character encoding and language specified by the Language element (see 7.3.18). Text strings shall not contain the NULL character (i.e., 00h or 0000h).

Status  
relliott Rejected 1/2/2008 4:44:59 PM -06'00'

---

Author: relliott  
Subject: Note  
Date: 1/2/2008 4:45:00 PM -06'00'

 ISO/IEC 10646:2003 defines "graphic character" as **4.20 Graphic character**  
**A character, other than a control function, that has a visual representation normally handwritten, printed, or displayed.**

**For an ASCII string, SES-2 includes an i.e. pointing out that the phrase means 20h-7Eh. For a text string, the range varies based on language and encoding. I think the phrase is understandable without copying that definition or adding a "(see ISO/IEC 10646:2003)" after the phrase.**

---



## 3.2 Symbols and abbreviations

AC	alternating current
CDB	command descriptor block (see 3.1.5)
ES	enclosure services (see 3.1.12)
FCP	Fibre Channel Protocol standard (any version)(see 2.3)
FCP-4	Fibre Channel Protocol - 4 standard (see 2.3)
LED	light emitting diode
LSB	least significant bit
LUN	logical unit number (see 3.1.19)
ms	millisecond
MSB	most significant bit
RMS	root mean squared
SAS	Serial Attached SCSI standard (any version)(see 2.3)
SAS-2	Serial Attached SCSI - 2 standard (see 2.3)
SCSI	Small Computer System Interface family of standards (see 2.3)
SAM-4	SCSI Architecture Model - 4 standard (see 2.3)
SCC	SCSI Controller Commands standard (any version)(see 2.3)
SCC-2	SCSI Controller Commands - 2 standard (see 2.3)
SPC-4	SCSI Primary Commands - 4 standard (see 2.3)

## 3.3 Keywords

**3.3.1 invalid:** A keyword used to describe an illegal or unsupported bit, byte, word, field or code value. Receipt of an invalid bit, byte, word, field or code value shall be reported as an error.

**3.3.2 mandatory:** A keyword indicating an item that is required to be implemented as defined in this standard.

**3.3.3 may:** A keyword that indicates flexibility of choice with no implied preference (equivalent to “may or may not”).

**3.3.4 may not:** Keywords that indicates flexibility of choice with no implied preference (equivalent to “may or may not”).

**3.3.5 obsolete:** A keyword indicating that an item was defined in prior standards but has been removed from this standard.

**3.3.6 optional:** A keyword that describes features that are not required to be implemented by this standard. However, if any optional feature defined in this standard is implemented, it shall be implemented as defined in this standard.

**3.3.7 reserved:** A keyword referring to bits, bytes, words, fields and code values that are set aside for future standardization. Their use and interpretation may be specified by future extensions to this or other standards. A reserved bit, byte, word or field shall be set to zero, or in accordance with a future extension to this standard. Recipients are not required to check reserved bits, bytes, words or fields for zero values. Receipt of reserved code values in defined fields shall be reported as an error.

**3.3.8 shall:** A keyword indicating a mandatory requirement (equivalent to “is required”). Designers are required to implement all such mandatory requirements to ensure interoperability with other products that conform to this standard.

**3.3.9 should:** A keyword indicating flexibility of choice with a strongly preferred alternative (equivalent to “is strongly recommended”).

**3.3.10 vendor specific:** Something (e.g., a bit, field, or code value) that is not defined by this standard and may be used differently in various implementations.

## Page: 6

---

Author: relliott  
Subject: Note  
Date: 5/12/2008 3:36:09 PM  
 Change AC to A.C.  
and DC to D.C.

Status  
relliott Accepted 1/30/2008 7:01:27 PM -06'00'

---

Author: symc-roger  
Subject: Note  
Date: 12/13/2007 8:25:13 PM -06'00'  
 SYMANTEC 07  
PDF pg 24, pg 6, 3.2 Symbols and abbreviations

Add DC - used in Table 70

Proposed Resolution:

DC direct current

Status  
relliott Accepted 12/13/2007 8:59:24 PM -06'00'

Status  
relliott Confirmed 12/13/2007 8:59:27 PM -06'00'

---

Author: hpq-relliott  
Subject: Note  
Date: 12/13/2007 8:24:34 PM -06'00'  
 Add  
GPIO general purpose input/output

Status  
relliott Accepted 12/17/2007 3:59:52 PM -06'00'

Status  
relliott Confirmed 12/17/2007 3:59:49 PM -06'00'

---

Author: hpq-relliott  
Subject: Note  
Date: 12/13/2007 8:24:34 PM -06'00'  
 Add  
ESI Enclosure Services Interface (see SFF-8067)

Status  
relliott Accepted 12/17/2007 3:58:51 PM -06'00'

Status  
relliott Confirmed 12/17/2007 3:58:47 PM -06'00'

---

Author: relliott  
Subject: Note  
Date: 5/12/2008 3:36:09 PM  
 add  
rpm revolutions per minute

Status  
relliott Accepted 1/5/2008 6:31:26 PM -06'00'

---

Author: hpq-relliott  
Subject: Note  
Date: 12/13/2007 8:24:34 PM -06'00'  
 Add  
SBC SCSI Block Commands standard (any version)

(used in a figure)

Status  
relliott Rejected 1/2/2008 4:37:08 PM -06'00'

Comments from page 6 continued on next page

## 3.2 Symbols and abbreviations

AC	alternating current
CDB	command descriptor block (see 3.1.5)
ES	enclosure services (see 3.1.12)
FCP	Fibre Channel Protocol standard (any version)(see 2.3)
FCP-4	Fibre Channel Protocol - 4 standard (see 2.3)
LED	light emitting diode
LSB	least significant bit
LUN	logical unit number (see 3.1.19)
ms	millisecond
MSB	most significant bit
RMS	root mean squared
SAS	Serial Attached SCSI standard (any version)(see 2.3)
SAS-2	Serial Attached SCSI - 2 standard (see 2.3)
SCSI	Small Computer System Interface family of standards (see 2.3)
SAM-4	SCSI Architecture Model - 4 standard (see 2.3)
SCC	SCSI Controller Commands standard (any version)(see 2.3)
SCC-2	SCSI Controller Commands - 2 standard (see 2.3)
SPC-4	SCSI Primary Commands - 4 standard (see 2.3)

## 3.3 Keywords

**3.3.1 invalid:** A keyword used to describe an illegal or unsupported bit, byte, word, field or code value. Receipt of an invalid bit, byte, word, field or code value shall be reported as an error.

**3.3.2 mandatory:** A keyword indicating an item that is required to be implemented as defined in this standard.

**3.3.3 may:** A keyword that indicates flexibility of choice with no implied preference (equivalent to “may or may not”).

**3.3.4 may not:** Keywords that indicates flexibility of choice with no implied preference (equivalent to “may or may not”).

**3.3.5 obsolete:** A keyword indicating that an item was defined in prior standards but has been removed from this standard.

**3.3.6 optional:** A keyword that describes features that are not required to be implemented by this standard. However, if any optional feature defined in this standard is implemented, it shall be implemented as defined in this standard.

**3.3.7 reserved:** A keyword referring to bits, bytes, words, fields and code values that are set aside for future standardization. Their use and interpretation may be specified by future extensions to this or other standards. A reserved bit, byte, word or field shall be set to zero, or in accordance with a future extension to this standard. Recipients are not required to check reserved bits, bytes, words or fields for zero values. Receipt of reserved code values in defined fields shall be reported as an error.

**3.3.8 shall:** A keyword indicating a mandatory requirement (equivalent to “is required”). Designers are required to implement all such mandatory requirements to ensure interoperability with other products that conform to this standard.

**3.3.9 should:** A keyword indicating flexibility of choice with a strongly preferred alternative (equivalent to “is strongly recommended”).

**3.3.10 vendor specific:** Something (e.g., a bit, field, or code value) that is not defined by this standard and may be used differently in various implementations.

---

Author: relliott  
Subject: Note  
Date: 1/2/2008 4:37:08 PM -06'00'

 changed figure to use "direct-access block device" rather than "SBC" since it just refers to the device type value of 00h.  
The name for that is owned by SPC-4.

---

Author: hpq-relliott  
Subject: Note  
Date: 12/13/2007 8:24:34 PM -06'00'

 Add  
SCA-2

Status  
relliott Accepted 12/17/2007 6:16:17 PM -06'00'

Status  
relliott Confirmed 12/17/2007 6:16:13 PM -06'00'

---

Author: ibm-gop  
Subject: Highlight  
Date: 12/13/2007 8:24:47 PM -06'00'

 3.3 Keywords  
Should add in the following new keyword <<  
**prohibited: A keyword used to describe a feature, function, or coded value that is defined in a non-SCSI standard (i.e., a standard that is not a member of the SCSI family of standards) to which this standard makes a normative reference where the use of said feature, function, or coded value is not allowed for implementations of this standard. >>**

Status  
relliott Accepted 12/13/2007 8:57:03 PM -06'00'

Status  
relliott Confirmed 12/13/2007 8:57:06 PM -06'00'

---

Author: ibm-gop  
Subject: Highlight  
Date: 12/13/2007 8:24:47 PM -06'00'

 3.3.3 may  
This << preference (equivalent to "may or may not"). >> should be << preference. May is synonymous with the phrase "may or may not". >>

Status  
relliott Rejected 12/17/2007 6:22:39 PM -06'00'

---

Author: relliott  
Subject: Note  
Date: 12/17/2007 6:24:05 PM -06'00'

 Same as SPC, SBC, and SAS

---

Author: ibm-gop  
Subject: Highlight  
Date: 12/13/2007 8:24:47 PM -06'00'

 3.3.4 may not  
This << preference (equivalent to "may or may not"). >> should be << preference. May not is synonymous with the phrase "may or may not". >>

Status  
relliott Rejected 12/17/2007 6:22:23 PM -06'00'

---

Author: relliott  
Subject: Note  
Date: 12/17/2007 6:24:19 PM -06'00'

 This matches SPC, SBC, and SAS. The change only makes grammatical sense if "May not" is also in quotes, but you generally complain about quotes.

---

Author: ibm-gop  
Subject: Highlight  
Date: 12/13/2007 8:24:47 PM -06'00'

 3.3.6 optional:  
This << 3.3.6 optional; >> should be << 3.3.6 option, optional: >>.

## 3.2 Symbols and abbreviations

AC	alternating current
CDB	command descriptor block (see 3.1.5)
ES	enclosure services (see 3.1.12)
FCP	Fibre Channel Protocol standard (any version)(see 2.3)
FCP-4	Fibre Channel Protocol - 4 standard (see 2.3)
LED	light emitting diode
LSB	least significant bit
LUN	logical unit number (see 3.1.19)
ms	millisecond
MSB	most significant bit
RMS	root mean squared
SAS	Serial Attached SCSI standard (any version)(see 2.3)
SAS-2	Serial Attached SCSI - 2 standard (see 2.3)
SCSI	Small Computer System Interface family of standards (see 2.3)
SAM-4	SCSI Architecture Model - 4 standard (see 2.3)
SCC	SCSI Controller Commands standard (any version)(see 2.3)
SCC-2	SCSI Controller Commands - 2 standard (see 2.3)
SPC-4	SCSI Primary Commands - 4 standard (see 2.3)

## 3.3 Keywords

**3.3.1 invalid:** A keyword used to describe an illegal or unsupported bit, byte, word, field or code value. Receipt of an invalid bit, byte, word, field or code value shall be reported as an error.

**3.3.2 mandatory:** A keyword indicating an item that is required to be implemented as defined in this standard.

**3.3.3 may:** A keyword that indicates flexibility of choice with no implied preference (equivalent to “may or may not”).

**3.3.4 may not:** Keywords that indicates flexibility of choice with no implied preference (equivalent to “may or may not”).

**3.3.5 obsolete:** A keyword indicating that an item was defined in prior standards but has been removed from this standard.

**3.3.6 optional:** A keyword that describes features that are not required to be implemented by this standard. However, if any optional feature defined in this standard is implemented, it shall be implemented as defined in this standard.

**3.3.7 reserved:** A keyword referring to bits, bytes, words, fields and code values that are set aside for future standardization. Their use and interpretation may be specified by future extensions to this or other standards. A reserved bit, byte, word or field shall be set to zero, or in accordance with a future extension to this standard. Recipients are not required to check reserved bits, bytes, words or fields for zero values. Receipt of reserved code values in defined fields shall be reported as an error.

**3.3.8 shall:** A keyword indicating a mandatory requirement (equivalent to “is required”). Designers are required to implement all such mandatory requirements to ensure interoperability with other products that conform to this standard.

**3.3.9 should:** A keyword indicating flexibility of choice with a strongly preferred alternative (equivalent to “is strongly recommended”).

**3.3.10 vendor specific:** Something (e.g., a bit, field, or code value) that is not defined by this standard and may be used differently in various implementations.

Status

relliott Rejected 12/17/2007 6:24:42 PM -06'00'

---

Author: relliott  
Subject: Note  
Date: 12/17/2007 6:24:36 PM -06'00'  
 same as SPC, SBC, and SAS

---

Author: ibm-gop  
Subject: Highlight  
Date: 12/13/2007 8:24:47 PM -06'00'

 3.3.8 shall  
This statement << (equivalent to "is required"). >> is not part of the standard definition for shall and therefore should be deleted.

Status

relliott Accepted 12/17/2007 6:27:46 PM -06'00'

Status

relliott Confirmed 12/17/2007 6:27:51 PM -06'00'

---

Author: ibm-gop  
Subject: Highlight  
Date: 12/13/2007 8:24:47 PM -06'00'

 3.3.9 should  
This << alternative (equivalent to "is strongly recommended"). >> should be << alternative. Equivalent to the phrase "it is strongly recommended". >>

Status

relliott Rejected 12/17/2007 6:26:35 PM -06'00'

---

Author: relliott  
Subject: Note  
Date: 12/17/2007 6:26:37 PM -06'00'  
 Grammatically incorrect. The adverb "should" is not equivalent to a noun "it" + verb

---

### 3.4 Conventions

Certain words and terms used in this standard have a specific meaning beyond the normal English meaning. These words and terms are defined either in clause 3 or in the text where they first appear.

Names of SCSI commands, statuses, sense keys, and additional sense codes are in all uppercase (e.g., SEND DIAGNOSTIC command).

Names of SCSI diagnostic pages, mode pages, log pages, and elements are in mixed case (e.g., Disconnect-Reconnect mode page).

Names of fields are in small uppercase (e.g., DESTINATION SAS ADDRESS). Normal case is used when the contents of a field are being discussed. Fields containing only one bit are usually referred to as the NAME bit instead of the NAME field.

Normal case is used for words having the normal English meaning.

A binary number is represented in this standard by any sequence of digits consisting of only the Western-Arabic numerals 0 and 1 immediately followed by a lower-case b (e.g., 0101b). Underscores or spaces may be included in binary number representations to increase readability or delineate field boundaries (e.g., 0 0101 1010b or 0\_0101\_1010b).

A hexadecimal number is represented in this standard by any sequence of digits consisting of only the Western-Arabic numerals 0 through 9 and/or the upper-case English letters A through F immediately followed by a lower-case h (e.g., FA23h). Underscores or spaces may be included in hexadecimal number representations to increase readability or delineate field boundaries (e.g., B FD8C FA23h or B\_FD8C\_FA23h).

A decimal number is represented in this standard by any sequence of digits consisting of only the Western-Arabic numerals 0 through 9 not immediately followed by a lower-case b or lower-case h (e.g., 25).

This standard uses the ISO convention for representing decimal numbers (e.g., the thousands and higher multiples are separated by a space, and a comma is used as the decimal point). Table 2 shows some examples of decimal numbers using the ISO and American numbering conventions.

**Table 2 — ISO and American numbering conventions**

ISO	American
0,6	0.6
3,141 592 65	3.14159265
1 000	1,000
1 323 462,95	1,323,462.95

A decimal number represented in this standard with an overline over one or more digits following the decimal point is a number where the overlined digits are infinitely repeating (e.g.,  $666,\overline{6}$  means  $666,666\ 666\dots$  or  $666\ 2/3$ , and  $12.142\ \overline{857}$  means  $12.142\ 857\ 142\ 857\dots$  or  $12\ 1/7$ ).

Lists sequenced by letters (e.g., a) red, b) blue, c) green) show no ordering relationship between the listed items. Lists sequenced by numbers (e.g., 1) red, 2) blue, 3) green) show an ordering relationship between the listed items.

In the event of conflicting information the precedence for requirements defined in this standard is:

- 1) text;
- 2) tables; then
- 3) figures.

Notes do not constitute any requirements for implementers.

# Page: 7

---

Author: hpq-relliott  
Subject: Note  
Date: 12/13/2007 8:24:34 PM -06'00'  
 Change to American numbering convention

Status  
relliott Accepted 1/30/2008 7:01:55 PM -06'00'

---

Author: relliott  
Subject: Note  
Date: 1/4/2008 5:32:49 PM -06'00'  
 Changes would be needed only 6 pages (Conventions, Device, Voltage Sensor, Power Supply, Current). Editor's notes added in those locations.

---

Author: relliott  
Subject: Note  
Date: 1/30/2008 7:02:02 PM -06'00'  
 Accepted by T10 plenary in January 2008

---

Author: hpq-relliott  
Subject: Note  
Date: 12/13/2007 8:24:34 PM -06'00'  
 12.142 is using American decimals. Unless overall document changes, switch to commas

Status  
relliott Accepted 12/13/2007 9:00:20 PM -06'00'

Status  
relliott Confirmed 12/13/2007 9:00:24 PM -06'00'

---



## 4 SCSI enclosure services model

### 4.1 Access to the enclosure services process

#### 4.1.1 Access to the enclosure services process overview

SCSI devices reside in enclosures that provide power, cooling, and protection for the devices. In addition, the enclosures provide external indicators about the state of the enclosure and devices. The indicators may identify the enclosure, identify proper operation of the devices and enclosure elements, provide indications of the state of RAID devices in the enclosure, and provide failure and maintenance information. Some of the individual elements of an enclosure may be removable and replaceable while the enclosure continues to operate. An enclosure services process typically manages all these enclosure elements and communicates with the SCSI application client. All these elements managed by the enclosure services process are in the enclosure domain of that process. The enclosure domain may extend outside the actual box containing the enclosure services process. As an example, an Uninterruptible Power Supply element may be located remotely and attached to the enclosure services process by a serial link.

The application client has two mechanisms for accessing the enclosure services process, both using the RECEIVE DIAGNOSTIC RESULTS and SEND DIAGNOSTIC commands (see SPC-4):

- a) directly to a standalone enclosure services process (see 4.1.2); or
- b) indirectly through a logical unit of another peripheral device type (e.g., a block device) to an attached enclosure services process (see 4.1.3).

#### 4.1.2 Standalone enclosure services process

An application client may address the enclosure services process as a logical unit having the peripheral device type of enclosure services (i.e., 0Dh) (see the INQUIRY command in SPC-4). The commands for this peripheral device type are described in clause 5.

Standalone enclosure services processes shall set the ENCSERV (enclosure services) bit to one in the Standard INQUIRY data (see SPC-4).

The application client uses the SEND DIAGNOSTIC command and its control-type diagnostic pages to set various indicators and states within the enclosure domain, allowing the enclosure to provide the most appropriate environment for the other SCSI devices contained within it. Similarly, the application client requests information from the enclosure services process using the RECEIVE DIAGNOSTIC RESULTS command and its status-type diagnostic pages to examine various status and warning information available from the enclosure. The diagnostic pages and page formats are defined in 6.1.

The Enclosure Services Management mode page (see 6.3.2) may be implemented by a standalone enclosure services process.

Author: relliott  
Subject: Highlight  
Date: 5/12/2008 3:36:09 PM

**T** SCSI devices reside in enclosures that provide power, cooling, and protection for the devices.  
s/b  
Enclosures may provide power, cooling, and protection for devices.

Status  
relliott Accepted 12/15/2007 4:36:13 PM -06'00'  
Status  
relliott Confirmed 12/15/2007 4:36:16 PM -06'00'

---

Author: relliott  
Subject: Highlight  
Date: 5/12/2008 3:36:09 PM

**T** the enclosures provide  
s/b  
enclosures may provide

Status  
relliott Accepted 12/15/2007 4:36:34 PM -06'00'  
Status  
relliott Confirmed 12/15/2007 4:36:37 PM -06'00'

---

Author: ibm-gop  
Subject: Note  
Date: 12/13/2007 8:24:47 PM -06'00'

**4.1.1 Access to the enclosure services process overview**

**Global**

**The term << device >> should always me << SCSI device >>.**

Status  
relliott Rejected 12/15/2007 4:35:42 PM -06'00'

---

Author: relliott  
Subject: Note  
Date: 12/15/2007 5:46:04 PM -06'00'

**5** No, power supplies, UPSes, cooling elements, etc. are not SCSI devices. Did review all uses of "device" and changed to device, SCSI device, device server, or enclosure services process as appropriate.

---

Author: ibm-gop  
Subject: Highlight  
Date: 12/13/2007 8:24:47 PM -06'00'

**T** 4.1.1 Access to the enclosure services process overview

**This << enclosure services process. As an example, an Uninterruptible Power Supply element may be located remotely and attached to the enclosure services process by a serial link. >> should be << enclosure services process (e.g., an Uninterruptible Power Supply element may be located remotely and attached to the enclosure services process by a serial link). >>**

Status  
relliott Accepted 12/14/2007 10:47:19 AM -06'00'  
Status  
relliott Confirmed 12/14/2007 10:47:22 AM -06'00'

---

Figure 2 shows an example of an enclosure with a standalone enclosure services process.

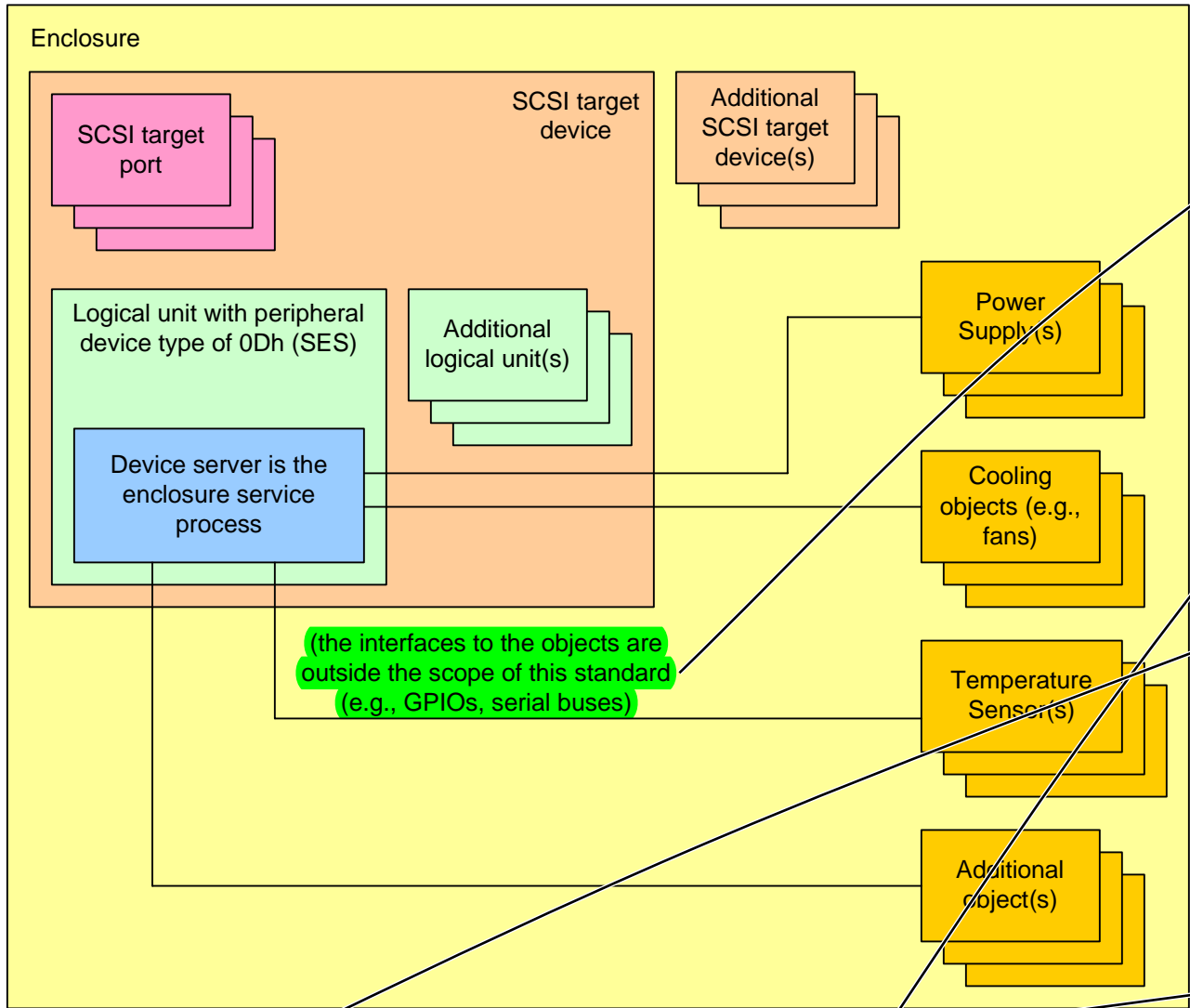

Figure 2 — Standalone enclosure services process

#### 4.1.3 Attached enclosure services process

An application client may also be able to address the enclosure services using a logical unit with some other peripheral device type (e.g., a block device) as a transport for enclosure services information. Such peripheral devices have a communications connection to the attached enclosure services process defined outside this standard (e.g., the ESI interface in SFF-8067). The attached enclosure services process is not accessible as its own logical unit; it transports the standard enclosure services information through the addressed logical unit.

The device server with an attached enclosure services processes shall set the ENCSERV (enclosure services) bit to one in the Standard INQUIRY data (see SPC-4). The attached enclosure services process may or may not be currently attached.

Such devices shall use the same SEND DIAGNOSTIC and RECEIVE DIAGNOSTIC RESULTS commands and page formats used by a standalone enclosure services process, but otherwise support the peripheral device model specified by their peripheral device type value.

An application client determines whether an enclosure services process is actually attached to the device by using the RECEIVE DIAGNOSTIC RESULTS command to request a Configuration diagnostic page (see

## Page: 9

---

Author: ibm-gop  
Subject: Highlight  
Date: 12/13/2007 8:24:47 PM -06'00'

 figure 2  
This << (the interfaces to the objects are outside the scope of this standard (e.g., GPIOs, serial buses) >> should be << (the interface protocols used are outside the scope of this standard (e.g., GPIOs, serial buses)) >> note missing << ) >>

Status  
relliott Accepted 12/13/2007 9:01:40 PM -06'00'  
Status  
relliott Confirmed 12/13/2007 9:01:44 PM -06'00'

---

Author: relliott  
Subject: Highlight  
Date: 5/12/2008 3:36:09 PM

 enclosure services  
s/b  
enclosure services process

Status  
relliott Accepted 12/15/2007 4:37:30 PM -06'00'  
Status  
relliott Confirmed 12/15/2007 4:37:34 PM -06'00'

---

Author: symc-roger  
Subject: Note  
Date: 12/13/2007 9:03:12 PM -06'00'

 SYMANTEC 09  
PDF pg 27, pg 9, 4.1.3 Attached enclosure services process 3rd para 2nd line

Reference back to the previous subclause for the standalone process

Proposed Resolution:

standalone enclosure services process (see 4.1.2)

Status  
relliott Accepted 12/13/2007 9:03:14 PM -06'00'  
Status  
relliott Confirmed 12/13/2007 9:03:17 PM -06'00'

---

Author: symc-roger  
Subject: Note  
Date: 12/13/2007 8:25:13 PM -06'00'

 SYMANTEC 08  
PDF pg 27, pg 9, 4.1.3 Attached enclosure services process 1st para 4th line

Spell out ESI here as it's the first usage, it's currently spelled out in Note 5

Proposed Resolution:

Enclosure Services Interface (ESI)

Status  
relliott Accepted 12/13/2007 10:31:13 PM -06'00'  
Status  
relliott Confirmed 12/13/2007 10:31:17 PM -06'00'

---

Author: relliott  
Subject: Note  
Date: 12/13/2007 10:32:07 PM -06'00'  
 changed here. Not switching the note 5 use to acronym only because it's not an obvious acronym

---

Author: ibm-gop  
Subject: Highlight  
Date: 12/13/2007 8:24:47 PM -06'00'

Comments from page 9 continued on next page

Figure 2 shows an example of an enclosure with a standalone enclosure services process.

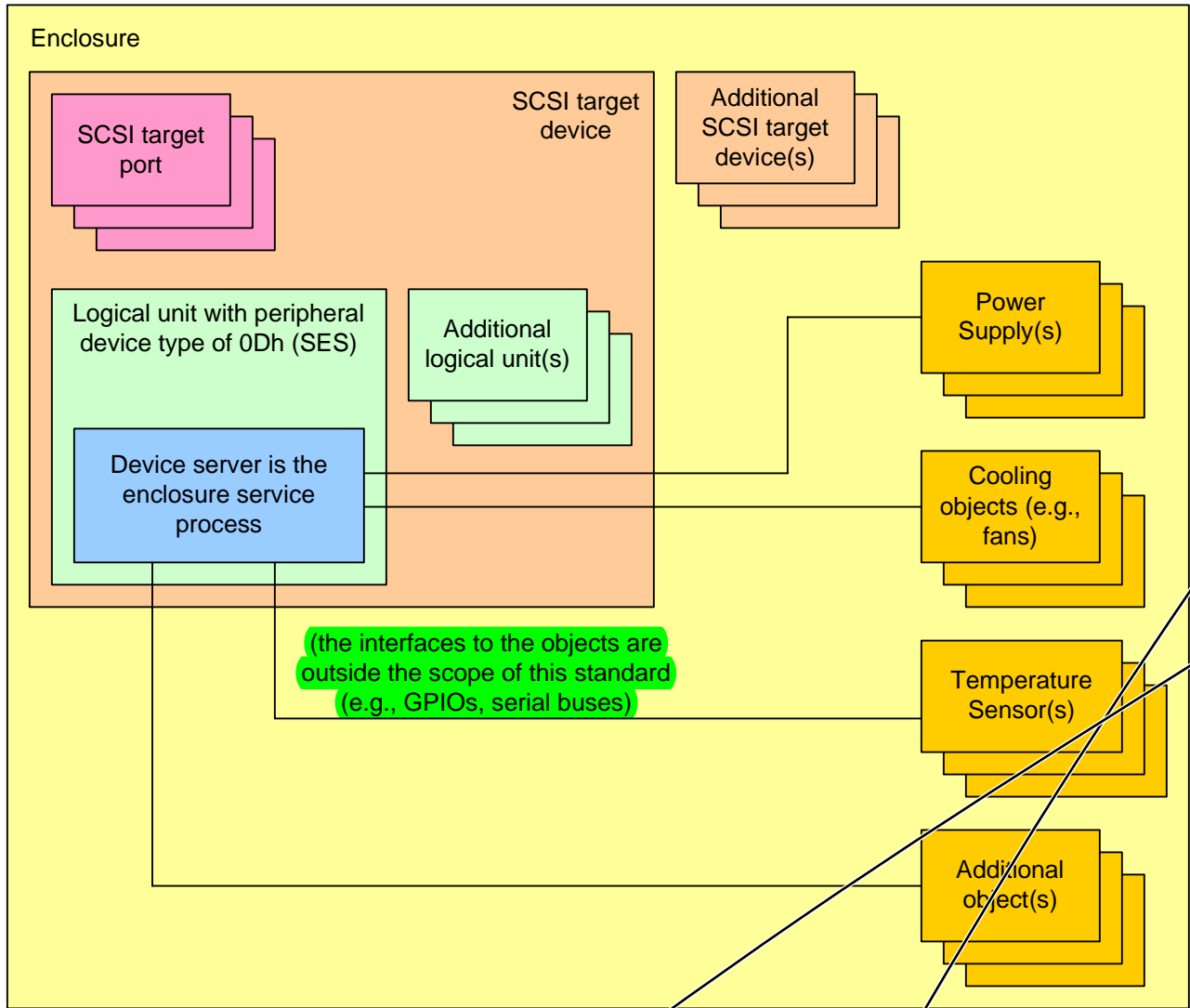

Figure 2 — Standalone enclosure services process

4.1.3 Attached enclosure services process

An application client may also be able to address the enclosure services using a logical unit with some other peripheral device type (e.g., a block device) as a transport for enclosure services information. Such peripheral devices have a communications connection to the attached enclosure services process defined outside this standard (e.g., the ESI interface in SFF-8067). The attached enclosure services process is not accessible as its own logical unit; it transports the standard enclosure services information through the addressed logical unit.

The device server with an attached enclosure services processes shall set the ENCSERV (enclosure services) bit to one in the Standard INQUIRY data (see SPC-4). The attached enclosure services process may or may not be currently attached.

Such devices shall use the same SEND DIAGNOSTIC and RECEIVE DIAGNOSTIC RESULTS commands and page formats used by a standalone enclosure services process, but otherwise support the peripheral device model specified by their peripheral device type value.

An application client determines whether an enclosure services process is actually attached to the device by using the RECEIVE DIAGNOSTIC RESULTS command to request a Configuration diagnostic page (see

**T 4.1.3 Attached enclosure services process (1st paragraph)**

**This << its own logical unit; it transports the standard enclosure services information through the addressed logical >> should be << its own logical unit as the enclosure services process transports the standard enclosure services information through the addressed logical >>**

Status  
relliott Rejected 12/15/2007 5:47:23 PM -06'00'

---

Author: relliott  
Subject: Note  
Date: 3/19/2008 1:43:07 PM  
added "instead" after the ;, but left the ; in place. The sentences are closely related.

---

Author: relliott  
Subject: Highlight  
Date: 5/12/2008 3:36:09 PM  
**T** enclosure services processes  
s/b  
enclosure services process

Status  
relliott Accepted 12/15/2007 5:23:44 PM -06'00'  
Status  
relliott Confirmed 12/15/2007 5:23:52 PM -06'00'

---

Author: relliott  
Subject: Highlight  
Date: 5/12/2008 3:36:09 PM  
**T** The device server  
s/b  
A device server

Status  
relliott Accepted 12/15/2007 5:23:09 PM -06'00'  
Status  
relliott Confirmed 12/15/2007 5:23:12 PM -06'00'

---

Author: ibm-gop  
Subject: Highlight  
Date: 12/13/2007 8:24:47 PM -06'00'  
**T 4.1.3 Attached enclosure services process (2nd paragraph)**

**This << The attached enclosure services process may or may not be currently attached. >> should be << The attached enclosure services process may or may not be attached. >>**

Status  
relliott Rejected 12/15/2007 5:47:38 PM -06'00'

---

Author: relliott  
Subject: Highlight  
Date: 5/12/2008 3:36:09 PM  
**T** devices  
s/b  
device servers

Status  
relliott Accepted 12/15/2007 4:38:46 PM -06'00'  
Status  
relliott Confirmed 12/15/2007 4:38:49 PM -06'00'

---

Author: relliott  
Subject: Underline  
Date: 5/12/2008 3:36:09 PM  
**T** device by  
s/b  
device server by

Status  
relliott Accepted 12/15/2007 4:49:21 PM -06'00'  
Status  
relliott Confirmed 12/15/2007 4:49:24 PM -06'00'

---

Author: ibm-gop

Figure 2 shows an example of an enclosure with a standalone enclosure services process.

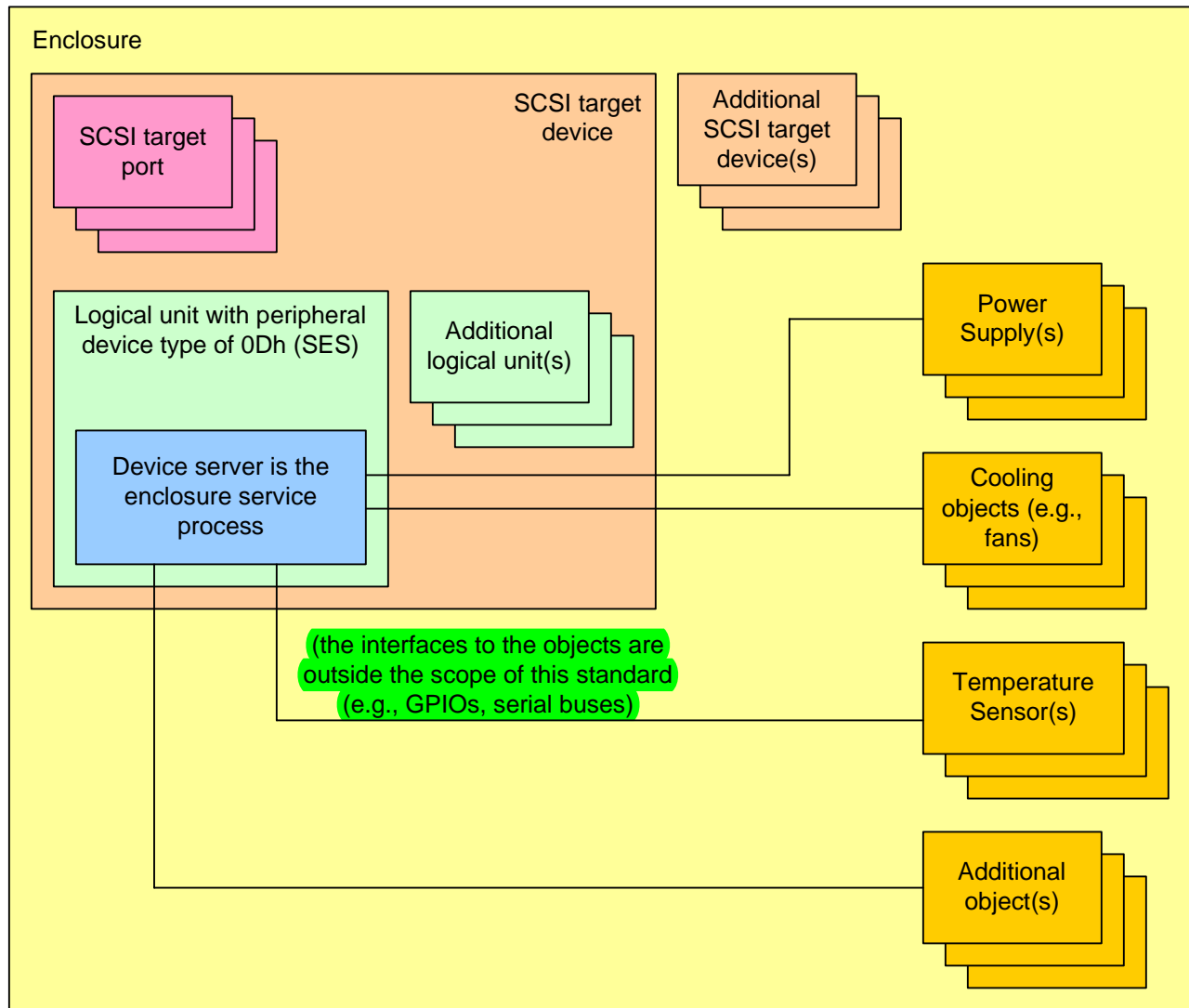

Figure 2 — Standalone enclosure services process

#### 4.1.3 Attached enclosure services process

An application client may also be able to address the enclosure services using a logical unit with some other peripheral device type (e.g., a block device) as a transport for enclosure services information. Such peripheral devices have a communications connection to the attached enclosure services process defined outside this standard (e.g., the ESI interface in SFF-8067). The attached enclosure services process is not accessible as its own logical unit; it transports the standard enclosure services information through the addressed logical unit.

The device server with an attached enclosure services processes shall set the ENCSERV (enclosure services) bit to one in the Standard INQUIRY data (see SPC-4). The attached enclosure services process may or may not be currently attached.

Such devices shall use the same SEND DIAGNOSTIC and RECEIVE DIAGNOSTIC RESULTS commands and page formats used by a standalone enclosure services process, but otherwise support the peripheral device model specified by their peripheral device type value.

An application client determines whether an enclosure services process is actually attached to the device by using the RECEIVE DIAGNOSTIC RESULTS command to request a Configuration diagnostic page (see

Subject: Highlight

Date: 12/13/2007 8:24:47 PM -06'00'

**T 4.1.3 Attached enclosure services process (4th paragraph)**

**This << An application client determines whether an enclosure services process is actually attached to the device by >>  
should be << An application client determines whether an enclosure services process is attached to the device by >>**

Status

relliott Accepted 12/15/2007 4:48:56 PM -06'00'

Status

relliott Confirmed 12/15/2007 4:48:59 PM -06'00'

---



6.1.2). If the device server is not able to communicate with an enclosure services process, the device server shall return CHECK CONDITION status as described in 4.8.

The Enclosure Services Management mode page (see 6.3.2) may be implemented by a logical unit that allows access to an attached enclosure services process.

NOTE 5 - One example using an attached enclosure services process is an enclosure of Fibre Channel disk drives with SCA-2 connectors defined in SFF-8067. The SCA-2 connector include pins for an Enclosure Services Interface (ESI). The backplane connects selected disk drives' ESI interfaces to an enclosure management processor serving as the attached enclosure services process.

Figure 3 shows an example of an enclosure with an attached enclosure services process.

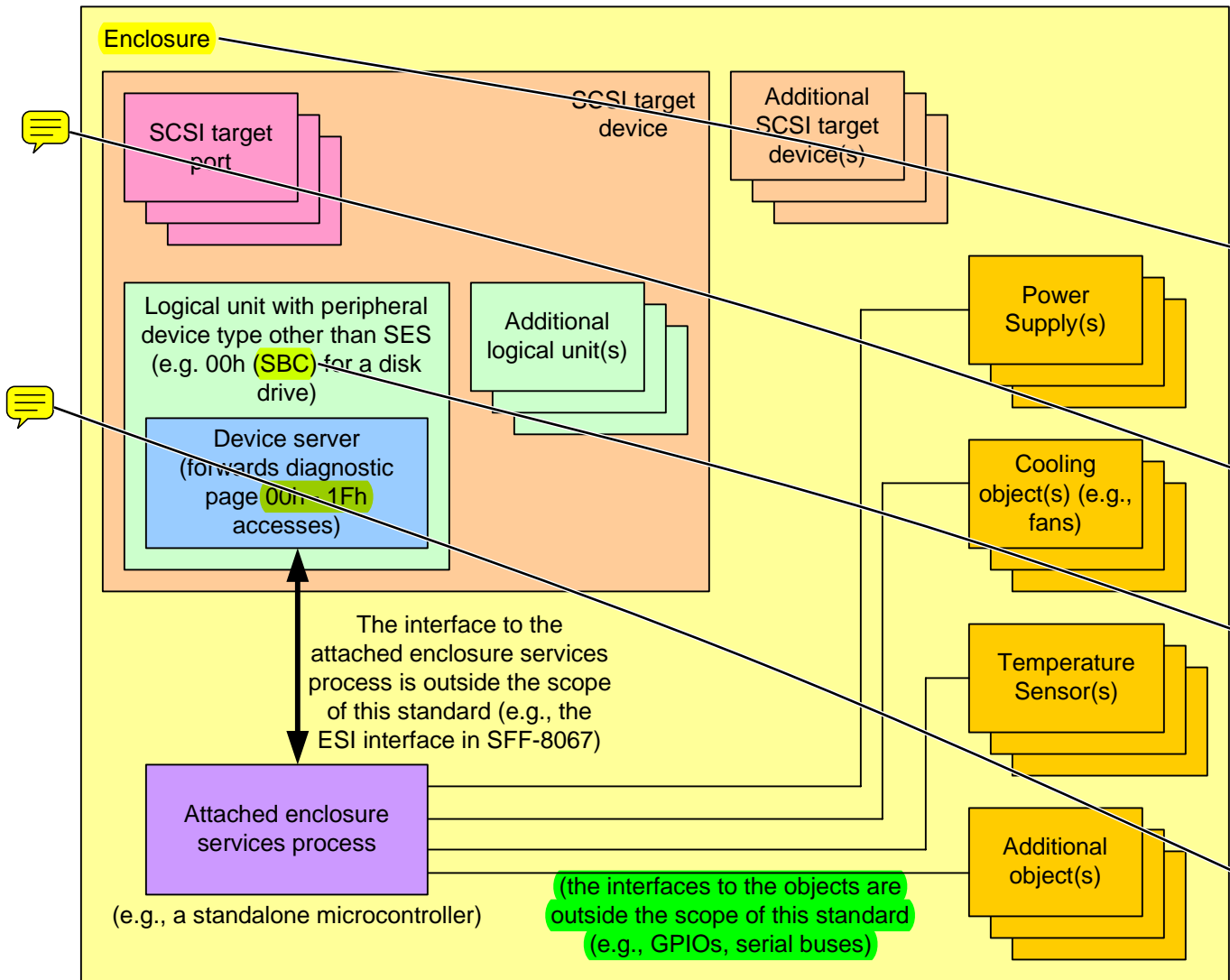

Figure 3 — Attached enclosure services process

The only SCSI device condition (see SAM-4) supported by an attached enclosure services process is power on (see 3.1.23). The logical unit does not communicate hard reset (see 3.1.15), logical unit reset (see 3.1.20), or I\_T nexus loss (see 3.1.16) to the attached enclosure services process.

## 4.2 Management of indicators and controls

An application client uses the SEND DIAGNOSTIC command to transmit control information to the enclosure services process. The control information may include internal and external state indicators as well as instructions to the enclosure to perform certain operations or to modify its operating mode.

# Page: 10

---

● Author: symc-roger  
Subject: Note  
Date: 12/13/2007 8:25:13 PM -06'00'  
 SYMANTEC 10  
PDF pg 28, pg 10, First line

"If the device server is not able to communicate with an enclosure services process, the device server shall return CHECK CONDITION status as described in 4.8." is incorrect. 4.8 contains a "Not ready" sense key that might be returned even when a process is "temporarily busy"

Proposed Resolution:

Identify the specific ASC value(s) to be returned.

Status  
relliott Rejected 12/15/2007 5:49:42 PM -06'00'

Status  
relliott Confirmed 12/15/2007 5:49:45 PM -06'00'

---

Author: relliott  
Subject: Note  
Date: 12/15/2007 5:50:15 PM -06'00'  
 "shall terminate the command as described in 4.8" works better

---

● Author: relliott  
Subject: Highlight  
Date: 5/12/2008 3:36:09 PM  
 Enclosure  
s/b  
Subenclosure

Status  
relliott Accepted 1/2/2008 7:33:03 PM -06'00'

---

● Author: relliott  
Subject: Note  
Date: 5/12/2008 3:36:09 PM  
 Show the enclosure boundary not wholly containing the SCSI target device

Status  
relliott Accepted 1/2/2008 7:32:51 PM -06'00'

---

● Author: relliott  
Subject: Highlight  
Date: 5/12/2008 3:36:09 PM  
 SBC  
s/b  
direct-access block device

to avoid adding the SBC acronym and normative reference

Status  
relliott Accepted 1/2/2008 7:32:19 PM -06'00'

---

● Author: symc-roger  
Subject: Note  
Date: 12/13/2007 8:25:13 PM -06'00'  
 SYMANTEC 11  
PDF pg 28, pg 10, Figure 3

The diagnostic page code range is incorrect.

Proposed Resolution:

Device server (forwards diagnostic page 00h - 2Fh accesses)

Comments from page 10 continued on next page

6.1.2). If the device server is not able to communicate with an enclosure services process, the device server shall return CHECK CONDITION status as described in 4.8.

The Enclosure Services Management mode page (see 6.3.2) may be implemented by a logical unit that allows access to an attached enclosure services process.

NOTE 5 - One example using an attached enclosure services process is an enclosure of Fibre Channel disk drives with SCA-2 connectors defined in SFF-8067. The SCA-2 connector include pins for an Enclosure Services Interface (ESI). The backplane connects selected disk drives' ESI interfaces to an enclosure management processor serving as the attached enclosure services process.

Figure 3 shows an example of an enclosure with an attached enclosure services process.

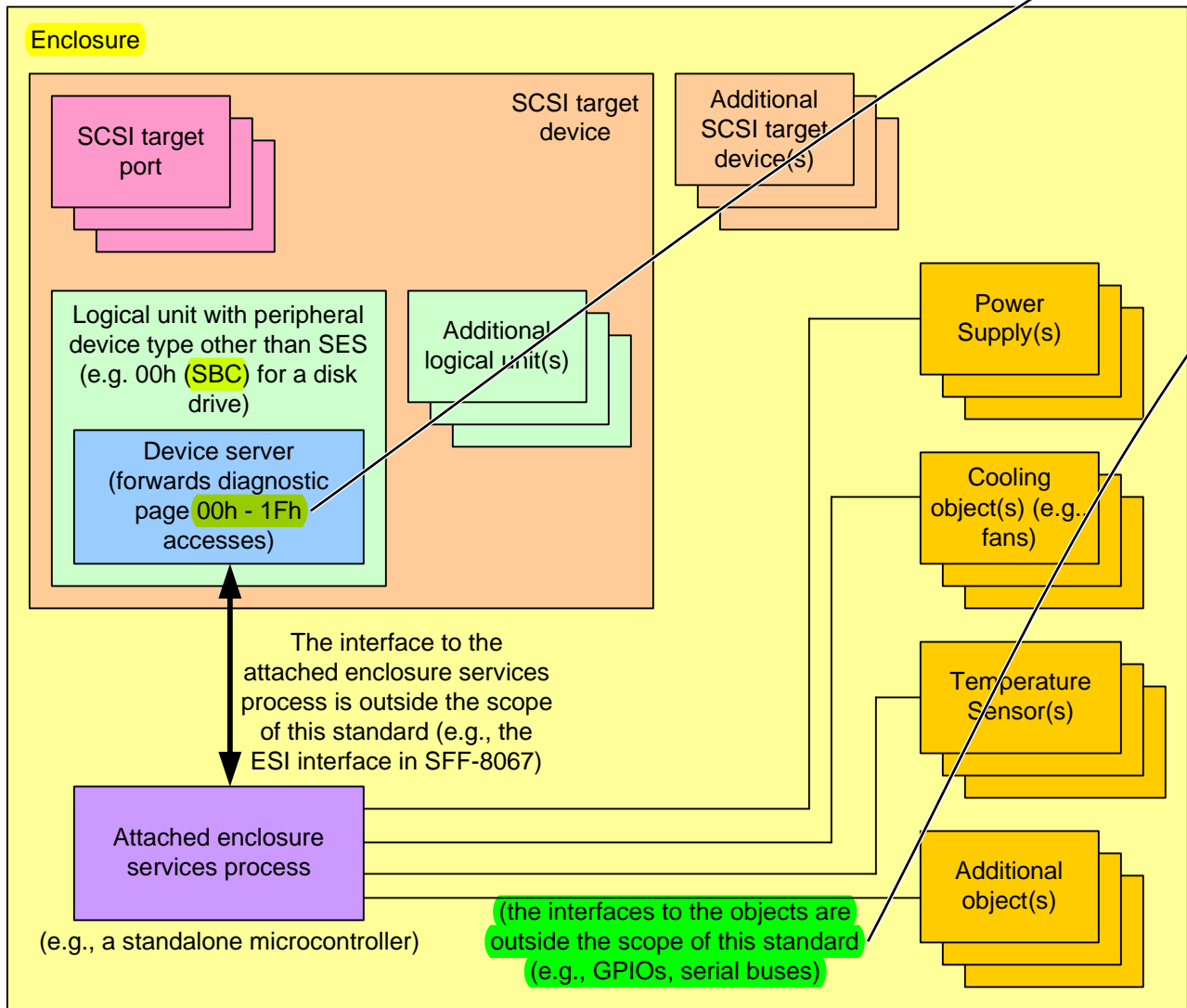

Figure 3 — Attached enclosure services process

The only SCSI device condition (see SAM-4) supported by an attached enclosure services process is power on (see 3.1.23). The logical unit does not communicate hard reset (see 3.1.15), logical unit reset (see 3.1.20), or I\_T nexus loss (see 3.1.16) to the attached enclosure services process.

## 4.2 Management of indicators and controls

An application client uses the SEND DIAGNOSTIC command to transmit control information to the enclosure services process. The control information may include internal and external state indicators as well as instructions to the enclosure to perform certain operations or to modify its operating mode.

Status  
relliott Accepted 12/13/2007 10:32:59 PM -06'00'  
Status  
relliott Confirmed 12/13/2007 10:33:02 PM -06'00'

---

Author: relliott  
Subject: Highlight  
Date: 5/12/2008 3:36:09 PM  
T 00h - 1Fh  
s/b  
01h - 2Fh

(because page 00h is not forwarded. Another comment already caught that 1Fh should be 2Fh.)

Status  
relliott Accepted 1/2/2008 7:31:50 PM -06'00'

---

Author: ibm-gop  
Subject: Highlight  
Date: 12/13/2007 8:24:47 PM -06'00'

T Figure 3  
figure 2

This << (the interfaces to the objects are outside the scope of this standard (e.g., GPIOs, serial buses) >> should be << (the interface protocols used are outside the scope of this standard (e.g., GPIOs, serial buses)) >> note missing << ) >>

Status  
relliott Accepted 12/15/2007 5:51:13 PM -06'00'  
Status  
relliott Confirmed 12/15/2007 5:51:17 PM -06'00'

---

The internal and external state indicators may be set to one or zero by any application client. The instructions of the application client may be ignored or overridden by the enclosure services process to assure that the proper state information is available to any application client that wants to sense an indicator. As an example, an application client may set the CRIT bit to zero in the Enclosure Control diagnostic page (see 6.1.3) to specify that it believes that a critical condition does not exist in the enclosure. The enclosure may choose to ignore the instruction if a critical condition still exists.

The instructions to the enclosure may be ignored by the enclosure services process if the instructions request an operation not implemented by the enclosure. Enclosure services processes may modify the values requested by an application client to the most appropriate value implemented in the enclosure. Instructions may also be ignored if the enclosure services process detects that the instructions would generate undesirable conditions within the enclosure. As an example, an application client may choose to save energy by selecting low fan speeds, but the enclosure services process may ignore the request because high ambient temperatures are present, requiring high fan speeds.

An application client uses the RECEIVE DIAGNOSTIC RESULTS command with the PCV bit set to one to obtain many kinds of enclosure status information. The information shall indicate the actual state of the enclosure. The actual state is a vendor specific combination of the indications set by the instructions from application clients and the indications established by the enclosure services process.

### 4.3 Use of the Short Enclosure Status diagnostic page

Some simple enclosure services processes are not capable of reporting any SES diagnostic page (see 6.1.1) except the Short Enclosure Status diagnostic page (see 6.1.11). Such enclosure services processes shall always provide the Short Enclosure Status diagnostic page, regardless of which SES diagnostic page is requested by a RECEIVE DIAGNOSTIC RESULTS command. Such devices shall terminate any SEND DIAGNOSTIC command using an SES diagnostic page code with CHECK CONDITION status with a sense key set to ILLEGAL REQUEST and an additional sense code set to UNSUPPORTED ENCLOSURE FUNCTION.

### 4.4 Use of the Enclosure Busy diagnostic page

Enclosure services processes may return the Enclosure Busy diagnostic page (see 6.1.12) rather than the requested diagnostic page when they are temporarily unable to provide the requested diagnostic page.

### 4.5 Invalid field errors

For a standalone enclosure services process, any invalid fields included in the CDB or parameters of a SEND DIAGNOSTIC command and any invalid fields in the CDB of a RECEIVE DIAGNOSTIC RESULTS command shall be detected by the device server. The device server shall analyze these parameters before performing the requested operations and, if there is an error, the command shall be terminated with CHECK CONDITION status. The sense key shall be set to ILLEGAL REQUEST and the additional sense code shall identify the location of the invalid fields, CDB, or parameter data.

For an attached enclosure services process, the device server does not have the capability of analyzing the validity of the CDB and the parameters destined to the attached enclosure services process. Instead, the device server shall pass the parameters to the attached enclosure services process without testing the validity of the parameters and shall return GOOD status. For errors in any diagnostic page other than the Threshold In diagnostic page, the enclosure services process shall set the INVOP (invalid operation requested) bit to one in the next Enclosure Status diagnostic page (see 6.1.4) returned to any application client. For errors in the Threshold Out diagnostic page, the enclosure services process shall set the INVOP bit to one in the next Threshold In diagnostic page (see 6.1.9) returned to any application client. The enclosure services process may include an Invalid Operation Reason element (see 7.3.12) in the element list to indicate the reason for the error when returning a status-type diagnostic page that contains an INVOP bit (e.g., the Enclosure Status or Threshold In diagnostic page).

An attached enclosure services process shall process a RECEIVE DIAGNOSTIC RESULTS command requesting an unsupported page code by returning no data. It shall process a SEND DIAGNOSTIC command requesting an unsupported page code by setting the INVOP bit to one in the next Enclosure Status diagnostic page returned to any application client.

Author: ibm-gop  
Subject: Highlight  
Date: 12/13/2007 8:24:47 PM -06'00'

**T 4.2 Management of indicators and controls (2nd paragraph)**

This << an indicator. As an example, an application client may set the CRIT bit to zero in the Enclosure Control diagnostic page (see 6.1.3) to specify that it believes that a critical condition does not exist in the enclosure. The enclosure may choose to ignore the instruction if a critical condition still exists. >> should be << an indicator (e.g., an application client may set the CRIT bit to zero in the Enclosure Control diagnostic page (see 6.1.3) to specify that the application client believes that a critical condition does not exist in the enclosure. The enclosure may choose to ignore the instruction if a critical condition still exists). >>

Status  
relliott Accepted 12/14/2007 10:48:16 AM -06'00'

Status  
relliott Confirmed 12/14/2007 10:48:18 AM -06'00'

Author: ibm-gop  
Subject: Highlight  
Date: 12/13/2007 8:24:47 PM -06'00'

**T 4.2 Management of indicators and controls (3rd paragraph)**

This << services process detects that the instructions would generate undesirable conditions >> should be << services process detects it is possible for the instructions to generate undesirable conditions >>

Status  
relliott Rejected 1/2/2008 4:38:12 PM -06'00'

Author: ibm-gop  
Subject: Highlight  
Date: 12/13/2007 8:24:47 PM -06'00'

**T 4.2 Management of indicators and controls (3rd paragraph)**

This << enclosure. As an example, an application client may choose to save energy by selecting low fan speeds, but the enclosure services process may ignore the request because high ambient temperatures are present, requiring high fan speeds. >> should be << enclosure (e.g., an application client may choose to save energy by selecting low fan speeds, but the enclosure services process may ignore the request because high ambient temperatures are present, requiring high fan speeds). >>

Status  
relliott Accepted 12/14/2007 10:49:10 AM -06'00'

Status  
relliott Confirmed 12/14/2007 10:49:13 AM -06'00'

Author: relliott  
Subject: Highlight  
Date: 5/12/2008 3:36:09 PM

**T** devices  
s/b  
enclosure services processes

Status  
relliott Accepted 12/15/2007 4:50:40 PM -06'00'

Status  
relliott Confirmed 12/15/2007 4:50:42 PM -06'00'

Author: relliott  
Subject: Highlight  
Date: 5/12/2008 3:36:09 PM

**T** Enclosure services processes  
Make this sentence singular

Status  
relliott Accepted 1/3/2008 7:05:05 PM -06'00'

Author: relliott

The internal and external state indicators may be set to one or zero by any application client. The instructions of the application client may be ignored or overridden by the enclosure services process to assure that the proper state information is available to any application client that wants to sense an indicator. As an example, an application client may set the CRIT bit to zero in the Enclosure Control diagnostic page (see 6.1.3) to specify that it believes that a critical condition does not exist in the enclosure. The enclosure may choose to ignore the instruction if a critical condition still exists.

The instructions to the enclosure may be ignored by the enclosure services process if the instructions request an operation not implemented by the enclosure. Enclosure services processes may modify the values requested by an application client to the most appropriate value implemented in the enclosure. Instructions may also be ignored if the enclosure services process detects that the instructions would generate undesirable conditions within the enclosure. As an example, an application client may choose to save energy by selecting low fan speeds, but the enclosure services process may ignore the request because high ambient temperatures are present, requiring high fan speeds.

An application client uses the RECEIVE DIAGNOSTIC RESULTS command with the PCV bit set to one to obtain many kinds of enclosure status information. The information shall indicate the actual state of the enclosure. The actual state is a vendor specific combination of the indications set by the instructions from application clients and the indications established by the enclosure services process.

### 4.3 Use of the Short Enclosure Status diagnostic page

Some simple enclosure services processes are not capable of reporting any SES diagnostic page (see 6.1.1) except the Short Enclosure Status diagnostic page (see 6.1.11). Such enclosure services processes shall always provide the Short Enclosure Status diagnostic page, regardless of which SES diagnostic page is requested by a RECEIVE DIAGNOSTIC RESULTS command. Such devices shall terminate any SEND DIAGNOSTIC command using an SES diagnostic page code with CHECK CONDITION status with a sense key set to ILLEGAL REQUEST and an additional sense code set to UNSUPPORTED ENCLOSURE FUNCTION.

### 4.4 Use of the Enclosure Busy diagnostic page

Enclosure services processes may return the Enclosure Busy diagnostic page (see 6.1.12) rather than the requested diagnostic page when they are temporarily unable to provide the requested diagnostic page.

### 4.5 Invalid field errors

For a standalone enclosure services process, any invalid fields included in the CDB or parameters of a SEND DIAGNOSTIC command and any invalid fields in the CDB of a RECEIVE DIAGNOSTIC RESULTS command shall be detected by the device server. The device server shall analyze these parameters before performing the requested operations and, if there is an error, the command shall be terminated with CHECK CONDITION status. The sense key shall be set to ILLEGAL REQUEST and the additional sense code shall identify the location of the invalid fields, CDB, or parameter data.

For an attached enclosure services process, the device server does not have the capability of analyzing the validity of the CDB and the parameters destined to the attached enclosure services process. Instead, the device server shall pass the parameters to the attached enclosure services process without testing the validity of the parameters and shall return GOOD status. For errors in any diagnostic page other than the Threshold In diagnostic page, the enclosure services process shall set the INVOP (invalid operation requested) bit to one in the next Enclosure Status diagnostic page (see 6.1.4) returned to any application client. For errors in the Threshold Out diagnostic page, the enclosure services process shall set the INVOP bit to one in the next Threshold In diagnostic page (see 6.1.9) returned to any application client. The enclosure services process may include an Invalid Operation Reason element (see 7.3.12) in the element list to indicate the reason for the error when returning a status-type diagnostic page that contains an INVOP bit (e.g., the Enclosure Status or Threshold In diagnostic page).

An attached enclosure services process shall process a RECEIVE DIAGNOSTIC RESULTS command requesting an unsupported page code by returning no data. It shall process a SEND DIAGNOSTIC command requesting an unsupported page code by setting the INVOP bit to one in the next Enclosure Status diagnostic page returned to any application client.

Subject: Note  
Date: 5/12/2008 3:36:09 PM  
 mention the BUSY bit set to one

Status  
relliott Accepted 1/3/2008 7:08:52 PM -06'00'

---

Author: ibm-gop  
Subject: Highlight  
Date: 12/13/2007 8:24:47 PM -06'00'

#### 4.4 Use of the Enclosure Busy diagnostic page

This << diagnostic page when they are temporarily >> should be << diagnostic page if they are temporarily >>

Status  
relliott Accepted 12/14/2007 10:49:49 AM -06'00'

Status  
relliott Confirmed 12/14/2007 10:49:53 AM -06'00'

---

Author: relliott  
Subject: Highlight  
Date: 5/12/2008 3:36:09 PM

 standalone enclosure services process  
s/b  
... (see 4.1.2)

to match symc comment

Status  
relliott Accepted 12/13/2007 9:04:30 PM -06'00'

Status  
relliott Confirmed 12/13/2007 9:04:27 PM -06'00'

---

Author: relliott  
Subject: Highlight  
Date: 5/12/2008 3:36:09 PM

 attached enclosure services process  
s/b  
... (see 4.1.3)

Status  
relliott Accepted 12/13/2007 9:25:48 PM -06'00'

Status  
relliott Confirmed 12/13/2007 9:25:45 PM -06'00'

---

Author: symc-roger  
Subject: Note  
Date: 12/13/2007 8:25:13 PM -06'00'

 SYMANTEC 12  
PDF pg 29, pg 11, 4.5 Invalid Field errors

"destined to" is not normal usage

Proposed Resolution:

"destined for"

Status  
relliott Rejected 1/2/2008 4:59:54 PM -06'00'

---

Author: relliott  
Subject: Note  
Date: 1/2/2008 4:59:54 PM -06'00'

 Google search shows 8,990,000 hits on "destined to" and only 3,720,000 on "destined for."

Author: relliott  
Subject: Highlight  
Date: 5/12/2008 3:36:09 PM

 other than the Threshold In diagnostic page  
s/b

Comments from page 11 continued on next page



The internal and external state indicators may be set to one or zero by any application client. The instructions of the application client may be ignored or overridden by the enclosure services process to assure that the proper state information is available to any application client that wants to sense an indicator. As an example, an application client may set the CRIT bit to zero in the Enclosure Control diagnostic page (see 6.1.3) to specify that it believes that a critical condition does not exist in the enclosure. The enclosure may choose to ignore the instruction if a critical condition still exists.

The instructions to the enclosure may be ignored by the enclosure services process if the instructions request an operation not implemented by the enclosure. Enclosure services processes may modify the values requested by an application client to the most appropriate value implemented in the enclosure. Instructions may also be ignored if the enclosure services process detects that the instructions would generate undesirable conditions within the enclosure. As an example, an application client may choose to save energy by selecting low fan speeds, but the enclosure services process may ignore the request because high ambient temperatures are present, requiring high fan speeds.

An application client uses the RECEIVE DIAGNOSTIC RESULTS command with the PCV bit set to one to obtain many kinds of enclosure status information. The information shall indicate the actual state of the enclosure. The actual state is a vendor specific combination of the indications set by the instructions from application clients and the indications established by the enclosure services process.

### 4.3 Use of the Short Enclosure Status diagnostic page

Some simple enclosure services processes are not capable of reporting any SES diagnostic page (see 6.1.1) except the Short Enclosure Status diagnostic page (see 6.1.11). Such enclosure services processes shall always provide the Short Enclosure Status diagnostic page, regardless of which SES diagnostic page is requested by a RECEIVE DIAGNOSTIC RESULTS command. Such devices shall terminate any SEND DIAGNOSTIC command using an SES diagnostic page code with CHECK CONDITION status with a sense key set to ILLEGAL REQUEST and an additional sense code set to UNSUPPORTED ENCLOSURE FUNCTION.

### 4.4 Use of the Enclosure Busy diagnostic page

 Enclosure services processes may return the Enclosure Busy diagnostic page (see 6.1.12) rather than the requested diagnostic page when they are temporarily unable to provide the requested diagnostic page.

### 4.5 Invalid field errors

For a standalone enclosure services process, any invalid fields included in the CDB or parameters of a SEND DIAGNOSTIC command and any invalid fields in the CDB of a RECEIVE DIAGNOSTIC RESULTS command shall be detected by the device server. The device server shall analyze these parameters before performing the requested operations and, if there is an error, the command shall be terminated with CHECK CONDITION status. The sense key shall be set to ILLEGAL REQUEST and the additional sense code shall identify the location of the invalid fields, CDB, or parameter data.

 For an attached enclosure services process, the device server does not have the capability of analyzing the validity of the CDB and the parameters destined to the attached enclosure services process. Instead, the device server shall pass the parameters to the attached enclosure services process without testing the validity of the parameters and shall return GOOD status. For errors in any diagnostic page other than the Threshold In diagnostic page, the enclosure services process shall set the INVOP (invalid operation requested) bit to one in the next Enclosure Status diagnostic page (see 6.1.4) returned to any application client. For errors in the Threshold Out diagnostic page, the enclosure services process shall set the INVOP bit to one in the next Threshold In diagnostic page (see 6.1.9) returned to any application client. The enclosure services process may include an Invalid Operation Reason element (see 7.3.12) in the element list to indicate the reason for the error when returning a status-type diagnostic page that contains an INVOP bit (e.g., the Enclosure Status or Threshold In diagnostic page).

 An attached enclosure services process shall process a RECEIVE DIAGNOSTIC RESULTS command requesting an unsupported page code by returning no data. It shall process a SEND DIAGNOSTIC command requesting an unsupported page code by setting the INVOP bit to one in the next Enclosure Status diagnostic page returned to any application client.

other than the Threshold Out diagnostic page

Status  
relliott Accepted 12/17/2007 3:04:15 PM -06'00'  
Status  
relliott Confirmed 12/17/2007 3:04:17 PM -06'00'

---

Author: symc-roger  
Subject: Note  
Date: 12/13/2007 8:25:13 PM -06'00'  
 SYMANTEC 13  
PDF pg 29, pg 11, 4.5 Invalid Field errors

The second paragraph is incorrect. If the device server allows a RECEIVE DIAGNOSTIC RESULTS command with PVC set to zero for its non-SES functionality, I think it needs to set ILLEGAL REQUEST if it receives a command with PVC set to zero for an SES page code

Proposed Resolution:

For an attached enclosure services process, for other than the PVC bit the device server does not have the capability of analyzing the validity of the CDB and the parameters destined to the attached enclosure services process.

Status  
relliott Rejected 1/2/2008 6:40:42 PM -06'00'

---

Author: relliott  
Subject: Note  
Date: 1/2/2008 6:40:43 PM -06'00'

 A standalone enclosure services process (see 4.1.2) shall report errors detected while processing the SEND DIAGNOSTIC command and the RECEIVE DIAGNOSTIC RESULTS commands as defined in SPC-4 (e.g., if the page code field in the parameter list for the SEND DIAGNOSTIC command is set to an unsupported value, terminate the command with CHECK CONDITION status with the sense key set to ILLEGAL REQUEST).

For an attached enclosure services process (see 4.1.3), if the page code is in the SES-2 diagnostic page code range (see 6.1.1):

the device server is not capable of completely checking the fields in the CDB and parameter list for the SEND DIAGNOSTIC command. Instead, the device server shall pass the page code and parameter list, if any, to the attached enclosure services process and terminate the command with GOOD status; and

the device server is not capable of completely checking the fields in the CDB in the CDB for the RECEIVE DIAGNOSTIC RESULTS command. Instead, if the page code is in the SES-2 diagnostic page code range (see 6.1.1), the device server shall pass the page code to the attached enclosure services process, retrieve the diagnostic page, if any, from the attached enclosure services process and return it to the application client as parameter data, and terminate the command with GOOD status.

The attached enclosure services process uses the invop bit in the Enclosure Status diagnostic page (see 6.1.4) and the Threshold In diagnostic page (see 6.1.9) to report errors.

To report errors detected in the SEND DIAGNOSTIC command CDB fields or parameter list, the attached enclosure services process shall:

if the page code field is set to an unsupported value, set the invop bit to one in the next Enclosure Status diagnostic page returned to any application client;

if the page code field is set to 05h (i.e., Threshold Out diagnostic page), set the invop bit to one in the next Threshold In diagnostic page (see 6.1.9) returned to any application client; and

if the page code field is set to a supported value other than 05h, set the invop bit to one in the next Enclosure Status diagnostic page (see 6.1.4) returned to any application client.

For an attached enclosure services process (see 4.1.3), the device server is not capable of completely checking the CDB fields for the RECEIVE DIAGNOSTIC RESULTS command (e.g., determining that the page code field is set to a supported value). Instead, the device server shall pass the command to the attached enclosure services process and shall return GOOD status.

To report errors detected in the RECEIVE DIAGNOSTIC RESULTS command CDB fields, the attached enclosure services process shall:

if the page code field is set to an unsupported value, return no data; and

if the page code field is set to a supported value, set the invop (invalid operation requested) bit to one in the next Enclosure Status diagnostic page (see 6.1.4) returned to any application client. If this command is returning the Enclosure Status diagnostic page, report the error in this command.

The attached enclosure services process may include an Invalid Operation Reason element (see 7.3.12) in the element list to indicate the reason for the error.

Comments from page 11 continued on next page

The internal and external state indicators may be set to one or zero by any application client. The instructions of the application client may be ignored or overridden by the enclosure services process to assure that the proper state information is available to any application client that wants to sense an indicator. As an example, an application client may set the CRIT bit to zero in the Enclosure Control diagnostic page (see 6.1.3) to specify that it believes that a critical condition does not exist in the enclosure. The enclosure may choose to ignore the instruction if a critical condition still exists.

The instructions to the enclosure may be ignored by the enclosure services process if the instructions request an operation not implemented by the enclosure. Enclosure services processes may modify the values requested by an application client to the most appropriate value implemented in the enclosure. Instructions may also be ignored if the enclosure services process detects that the instructions would generate undesirable conditions within the enclosure. As an example, an application client may choose to save energy by selecting low fan speeds, but the enclosure services process may ignore the request because high ambient temperatures are present, requiring high fan speeds.

An application client uses the RECEIVE DIAGNOSTIC RESULTS command with the PRV bit set to one to obtain many kinds of enclosure status information. The information shall indicate the actual state of the enclosure. The actual state is a vendor specific combination of the indications set by the instructions from application clients and the indications established by the enclosure services process.

### 4.3 Use of the Short Enclosure Status diagnostic page

Some simple enclosure services processes are not capable of reporting any SES diagnostic page (see 6.1.1) except the Short Enclosure Status diagnostic page (see 6.1.11). Such enclosure services processes shall always provide the Short Enclosure Status diagnostic page, regardless of which SES diagnostic page is requested by a RECEIVE DIAGNOSTIC RESULTS command. Such devices shall terminate any SEND DIAGNOSTIC command using an SES diagnostic page code with CHECK CONDITION status with a sense key set to ILLEGAL REQUEST and an additional sense code set to UNSUPPORTED ENCLOSURE FUNCTION.

### 4.4 Use of the Enclosure Busy diagnostic page

Enclosure services processes may return the Enclosure Busy diagnostic page (see 6.1.12) rather than the requested diagnostic page when they are temporarily unable to provide the requested diagnostic page.

### 4.5 Invalid field errors

For a standalone enclosure services process, any invalid fields included in the CDB or parameters of a SEND DIAGNOSTIC command and any invalid fields in the CDB of a RECEIVE DIAGNOSTIC RESULTS command shall be detected by the device server. The device server shall analyze these parameters before performing the requested operation and, if there is an error, the command shall be terminated with CHECK CONDITION status. The sense key shall be set to ILLEGAL REQUEST and the additional sense code shall identify the location of the invalid fields, CDB, or parameter data.

For an attached enclosure services process, the device server does not have the capability of analyzing the validity of the CDB and the parameters destined to the attached enclosure services process. Instead, the device server shall pass the parameters to the attached enclosure services process without testing the validity of the parameters and shall return GOOD status. For errors in any diagnostic page other than the Threshold In diagnostic page, the enclosure services process shall set the INVOP (invalid operation requested) bit to one in the next Enclosure Status diagnostic page (see 6.1.4) returned to any application client. For errors in the Threshold Out diagnostic page, the enclosure services process shall set the INVOP bit to one in the next Threshold In diagnostic page (see 6.1.9) returned to any application client. The enclosure services process may include an Invalid Operation Reason element (see 7.3.12) in the element list to indicate the reason for the error when returning a status-type diagnostic page that contains an INVOP bit (e.g., the Enclosure Status or Threshold In diagnostic page).

An attached enclosure services process shall process a RECEIVE DIAGNOSTIC RESULTS command requesting an unsupported page code by returning no data. It shall process a SEND DIAGNOSTIC command requesting an unsupported page code by setting the INVOP bit to one in the next Enclosure Status diagnostic page returned to any application client.

---

Author: symc-roger

Subject: Note

Date: 12/13/2007 8:25:13 PM -06'00'

 SYMANTEC 14

PDF pg 29, pg 11, 4.5 Invalid Field errors

The last paragraph is not specific enough - it should refer only to unsupported SES page codes. If the process receives other non-SES page codes it should return "ILLEGAL REQUEST", right?

Proposed Resolution:

An attached enclosure services process shall process a RECEIVE DIAGNOSTIC RESULTS command requesting an unsupported SES-2 page code by returning no data. It shall process a SEND DIAGNOSTIC command requesting an unsupported SES-2 page code by setting the INVOP bit to one in the next Enclosure Status diagnostic page returned to any application

Status

relliott Rejected 1/2/2008 6:41:58 PM -06'00'

---

Author: relliott

Subject: Note

Date: 1/2/2008 6:41:59 PM -06'00'

 See response to SYMANTEC 14, which rewrites the entire section and mentions that this only applies to the SES diagnostic page region.

---

## 4.6 Reporting of enclosure failure information

### 4.6.1 Reporting overview

Many enclosure functions are managed simply by setting controls and testing the status of the elements within an enclosure. However, the enclosure services process also monitors a variety of warning and error conditions. These conditions may be communicated to an application client using any of the following methods:

- a) polling (see 4.6.2);
- b) **timed disconnection polling** (see 4.6.3); or
- c) CHECK CONDITION status (see 4.6.4).

### 4.6.2 Polling

The application client may periodically poll the enclosure by sending a RECEIVE DIAGNOSTIC RESULTS command requesting an Enclosure Status diagnostic page (see 6.1.4) with an allocation length greater than 1. The information returned in byte 1 of the Enclosure Status diagnostic page includes 5 bits that summarize the status of the enclosure and its elements as described in 6.1.4. If one of these bits is set to one, detailed information may then be obtained by the application client by sending a RECEIVE DIAGNOSTIC RESULTS command requesting a complete Enclosure Status diagnostic page, Help Text diagnostic page (see 6.1.5), or Subenclosure Help Text diagnostic page (see 6.1.14).

### 4.6.3 Timed completion function

The application client may enable the optional **disconnect** function using the Enclosure Services Management mode page (see 6.3.2). The application client may then periodically poll the enclosure by sending a RECEIVE DIAGNOSTIC RESULTS command requesting an Enclosure Status diagnostic page (see 6.1.4) with an allocation length greater than 1. The return of the diagnostic page may be delayed until one or more of the bits in byte 1 of the page are set to one. The command shall be completed by the device server before the time specified in the MAXIMUM TASK COMPLETION TIME field is exceeded whether or not one of these bits is set to one. This polling option allows the application client to access warning and error information at a time closer to the detection of the information by the enclosure services process.

### 4.6.4 CHECK CONDITION status

For commands other than RECEIVE DIAGNOSTIC RESULTS and REQUEST SENSE sent to a device server serving as a standalone enclosure services process (see 4.1.2), the device server may indicate invalid operations, warning conditions, and failure conditions by terminating the command with CHECK CONDITION status with the sense key and additional sense code describing the indication. A subsequent RECEIVE DIAGNOSTIC RESULTS command requesting an Enclosure Status diagnostic page (see 6.1.4) may be required to clarify the indication and to identify the element causing the indication. The device server may use the rules defined for informational exception conditions defined in SPC-4 to indicate conditions that do not require any recovery action.

For attached enclosure services processes (see 4.1.3), the device server shall not terminate commands with CHECK CONDITION status to indicate the presence of information from the enclosure services process. Application clients shall use polling to access the enclosure information through such **devices**.

## 4.7 Subenclosures

When a single enclosure is present, the primary subenclosure is the enclosure.

When multiple enclosures are present, the primary subenclosure is the enclosure whose enclosure **service process** provides access to enclosure services information of all the subenclosures. The enclosure services information from multiple subenclosures is **combined together** into a single set of SES diagnostic pages. The information from each subenclosure is **identified** in the Configuration diagnostic page (see 6.1.2) by its subenclosure identifier.

# Page: 12

---

Author: relliott  
Subject: Highlight  
Date: 5/12/2008 3:36:09 PM  
**T** Reporting of enclosure failure information  
s/b  
Reporting methods

since it might be providing notice about events less scary than "enclosure failure"s

Status  
relliott Accepted 1/4/2008 5:06:21 PM -06'00'

---

Author: relliott  
Subject: Highlight  
Date: 5/12/2008 3:36:09 PM  
**T** Reporting overview  
s/b  
Reporting methods overview

(base it on the 4.6 title)

Status  
relliott Accepted 1/4/2008 5:06:49 PM -06'00'

---

Author: relliott  
Subject: Highlight  
Date: 5/12/2008 3:36:09 PM  
**T** timed disconnection polling  
s/b  
polling based on the timed completion function

Status  
relliott Accepted 12/15/2007 5:55:25 PM -06'00'

Status  
relliott Confirmed 12/15/2007 5:55:27 PM -06'00'

---

Author: ibm-gop  
Subject: Highlight  
Date: 12/13/2007 8:24:47 PM -06'00'  
**T** 4.6.2 Polling

**This << length greater than 1. >> should be << length greater than one. >>**

Status  
relliott Accepted 12/13/2007 8:46:57 PM -06'00'

Status  
relliott Confirmed 12/13/2007 8:47:02 PM -06'00'

---

Author: ibm-gop  
Subject: Highlight  
Date: 12/13/2007 8:24:47 PM -06'00'  
**T** 4.6.2 Polling

**This << page includes 5 bits that summarize >> should be << page includes five bits that summarize >>**

Status  
relliott Rejected 12/20/2007 8:26:36 PM -06'00'

Status  
relliott Confirmed 12/13/2007 10:55:29 PM -06'00'

---

Author: relliott  
Subject: Note  
Date: 12/20/2007 8:26:37 PM -06'00'  
 took out 5

---

Author: ibm-gop  
Subject: Highlight

Comments from page 12 continued on next page

## 4.6 Reporting of enclosure failure information

### 4.6.1 Reporting overview

Many enclosure functions are managed simply by setting controls and testing the status of the elements within an enclosure. However, the enclosure services process also monitors a variety of warning and error conditions. These conditions may be communicated to an application client using any of the following methods:

- a) polling (see 4.6.2);
- b) **timed disconnection polling** (see 4.6.3); or
- c) CHECK CONDITION status (see 4.6.4).

### 4.6.2 Polling

The application client may periodically poll the enclosure by sending a RECEIVE DIAGNOSTIC RESULTS command requesting an Enclosure Status diagnostic page (see 6.1.4) with an allocation **length greater than 1**. **The information returned in byte 1 of the Enclosure Status diagnostic page includes 5 bits that summarize** the status of the enclosure and its elements as described in 6.1.4. If one of these bits is set to one, detailed information may then be obtained by the application client by sending a RECEIVE DIAGNOSTIC RESULTS command requesting a complete Enclosure Status diagnostic page, Help Text diagnostic page (see 6.1.5), or Subenclosure Help Text diagnostic page (see 6.1.14).

### 4.6.3 Timed completion function

The application client may enable the optional **disconnect** function using the Enclosure Services Management mode page (see 6.3.2). The application client may then periodically poll the enclosure by sending a RECEIVE DIAGNOSTIC RESULTS command requesting an Enclosure Status diagnostic page (see 6.1.4) with an **allocation length greater than 1**. ~~The return of the diagnostic page may be delayed until one or more of the **bits in byte 1 of the page are set to one**. The command shall be completed by the device server before the time specified in the MAXIMUM TASK COMPLETION TIME field is exceeded whether or not one of these bits is set to one. This polling option allows the application client to access warning and error information at a time closer to the detection of the information by the enclosure services process.~~

### 4.6.4 CHECK CONDITION status

For commands other than RECEIVE DIAGNOSTIC RESULTS and REQUEST SENSE sent to a device server serving as a standalone enclosure services process (see 4.1.2), the device server may indicate invalid operations, warning conditions, and failure conditions by terminating the command with CHECK CONDITION status with the sense key and additional sense code describing the indication. A subsequent RECEIVE DIAGNOSTIC RESULTS command requesting an Enclosure Status diagnostic page (see 6.1.4) may be required to clarify the indication and to identify the element causing the indication. The device server may use the rules defined for informational exception conditions defined in SPC-4 to indicate conditions that do not require any recovery action.

For attached enclosure services processes (see 4.1.3), the device server shall not terminate commands with CHECK CONDITION status to indicate the presence of information from the enclosure services process. Application clients shall use polling to access the enclosure information through such **devices**.

## 4.7 Subenclosures

When a single enclosure is present, the primary subenclosure is the enclosure.

When multiple enclosures are present, the primary subenclosure is the enclosure whose enclosure **service process** provides access to enclosure services information of all the subenclosures. The enclosure services information from multiple subenclosures is **combined together** into a single set of SES diagnostic pages. The information from each subenclosure is **identified** in the Configuration diagnostic page (see 6.1.2) by its subenclosure identifier.

Date: 12/13/2007 8:24:47 PM -06'00'

**T 4.6.2 Polling**

**This << The information returned in byte 1 of the Enclosure >> should be << The information returned in byte one of the Enclosure >>**

Status  
relliott Rejected 12/20/2007 8:27:34 PM -06'00'

Author: relliott  
Subject: Note  
Date: 12/20/2007 8:27:37 PM -06'00'  
 the byte column of the table uses 1, not "one"

Author: relliott  
Subject: Highlight  
Date: 5/12/2008 3:36:09 PM

**T** disconnect  
s/b  
completion

to match the section header

Status  
relliott Accepted 12/15/2007 5:52:20 PM -06'00'

Status  
relliott Confirmed 12/15/2007 5:52:23 PM -06'00'

Author: ibm-gop  
Subject: Highlight  
Date: 12/13/2007 8:24:47 PM -06'00'

**T 4.6.3 Timed completion function**

**This << length greater than 1. >> should be << length greater than one. >>**

Status  
relliott Accepted 12/13/2007 8:47:14 PM -06'00'

Author: relliott  
Subject: Underline  
Date: 5/12/2008 3:36:09 PM

**T** age are set  
s/b  
diagnostic page are set

Status  
relliott Accepted 12/15/2007 5:53:18 PM -06'00'

Status  
relliott Confirmed 12/15/2007 5:53:20 PM -06'00'

Author: ibm-gop  
Subject: Highlight  
Date: 12/13/2007 8:24:47 PM -06'00'

**T 4.6.3 Timed completion function**

**This << bits in byte 1 of the page are >> should be << bits in byte one of the page are >>**

Status  
relliott Rejected 12/20/2007 8:27:40 PM -06'00'

Author: relliott  
Subject: Note  
Date: 12/20/2007 8:29:19 PM -06'00'  
 the table uses 1 not one

Author: symc-roger  
Subject: Note  
Date: 12/13/2007 8:25:13 PM -06'00'

 SYMANTEC 15  
PDF pg 30, pg 12, 4.6.4 CHECK CONDITION status



## 4.6 Reporting of enclosure failure information

### 4.6.1 Reporting overview

Many enclosure functions are managed simply by setting controls and testing the status of the elements within an enclosure. However, the enclosure services process also monitors a variety of warning and error conditions. These conditions may be communicated to an application client using any of the following methods:

- a) polling (see 4.6.2);
- b) **timed disconnection polling** (see 4.6.3); or
- c) CHECK CONDITION status (see 4.6.4).

### 4.6.2 Polling

The application client may periodically poll the enclosure by sending a RECEIVE DIAGNOSTIC RESULTS command requesting an Enclosure Status diagnostic page (see 6.1.4) with an allocation **length greater than 1**. **The information returned in byte 1 of the Enclosure Status diagnostic page includes 5 bits that summarize** the status of the enclosure and its elements as described in 6.1.4. If one of these bits is set to one, detailed information may then be obtained by the application client by sending a RECEIVE DIAGNOSTIC RESULTS command requesting a complete Enclosure Status diagnostic page, Help Text diagnostic page (see 6.1.5), or Subenclosure Help Text diagnostic page (see 6.1.14).

### 4.6.3 Timed completion function

The application client may enable the optional **disconnect** function using the Enclosure Services Management mode page (see 6.3.2). The application client may then periodically poll the enclosure by sending a RECEIVE DIAGNOSTIC RESULTS command requesting an Enclosure Status diagnostic page (see 6.1.4) with an **allocation length greater than 1**. The return of the diagnostic page may be delayed until one or more of the **bits in byte 1 of the page are set** to one. The command shall be completed by the device server before the time specified in the MAXIMUM TASK COMPLETION TIME field is exceeded whether or not one of these bits is set to one. This polling option allows the application client to access warning and error information at a time closer to the detection of the information by the enclosure services process.

### 4.6.4 CHECK CONDITION status

For commands other than RECEIVE DIAGNOSTIC RESULTS and REQUEST SENSE sent to a device server serving as a standalone enclosure services process (see 4.1.2), the device server may indicate invalid operations, warning conditions, and failure conditions by terminating the command with CHECK CONDITION status with the sense key and additional sense code describing the indication. A subsequent RECEIVE DIAGNOSTIC RESULTS command requesting an Enclosure Status diagnostic page (see 6.1.4) may be required to clarify the indication and to identify the element causing the indication. The device server may use the rules defined for informational exception conditions defined in SPC-4 to indicate conditions that do not require any recovery action.

For attached enclosure services processes (see 4.1.3), the device server shall not terminate commands with CHECK CONDITION status to indicate the presence of information from the enclosure services process. Application clients shall use polling to access the enclosure information through such **devices**.

## 4.7 Subenclosures

When a single enclosure is present, the primary subenclosure is the enclosure.

When multiple enclosures are present, the primary subenclosure is the enclosure whose enclosure **service process** provides access to enclosure services information of all the subenclosures. The enclosure services information from multiple subenclosures is **combined together** into a single set of SES diagnostic pages. The information from each subenclosure is **identified** in the Configuration diagnostic page (see 6.1.2) by its subenclosure identifier.

"invalid operations" needs to be clarified here. Is an unsupported SES page an invalid operation? Presumably not, because 4.5 says to return no data, not a check condition.

Proposed Resolution:

Please clarify

Status  
relliott Accepted 1/30/2008 7:29:52 PM -06'00'

---

Author: relliott

Subject: Note

Date: 1/4/2008 6:27:20 PM -06'00'

 This is like a unit attention condition, but only REQUEST SENSE is exempted. Do we really want INQUIRY, REPORT LUNS, and NOTIFY DATA TRANSFER DEVICE bothered by these error reports?

Replacement text:

A standalone enclosure services process may terminate any command other than RECIEVE DIAGNOSTIC RESULTS that is allowed to be used to report unit attention conditions (see SAM-4) with CHECK CONDITION status with the sense key set to HARDWARE ERROR and the additional sense code set to ENCLOSURE FAILURE to indicate a warning or failure. It may report conditions that do not require any recovery action as informational exceptions (see SPC-4).

---

Author: relliott

Subject: Note

Date: 1/30/2008 7:29:48 PM -06'00'

 Per January 2008 CAP WG, replaced paragraph with:

A standalone device server should not terminate a RECEIVE DIAGNOSTIC RESULTS command with CHECK CONDITION status to report warning conditions and failure conditions relating to enclosure services.

The device server may use informational exception conditions (see SPC-4) to indicate conditions that do not require any recovery action.

---

Author: symc-roger

Subject: Note

Date: 12/13/2007 8:25:13 PM -06'00'

 SYMANTEC 16

PDF pg 30, pg 12, 4.6.4 CHECK CONDITION status

The phrase "rules defined for informational exception conditions defined in SPC-4" doesn't parse. As far as I can see, the term "rule" is never used in SPC-4 in relation to informational exception conditions.

Proposed Resolution:

Please clarify

Status  
relliott Accepted 12/15/2007 5:57:46 PM -06'00'

Status  
relliott Confirmed 12/15/2007 5:57:49 PM -06'00'

---

Author: relliott

Subject: Note

Date: 12/15/2007 5:57:50 PM -06'00'

 may use informational exception conditions (see SPC-4)

---

Author: relliott

Subject: Highlight

Date: 5/12/2008 3:36:09 PM

 devices

s/b

device servers

---

Status  
relliott Accepted 12/15/2007 5:56:25 PM -06'00'

Status  
relliott Confirmed 12/15/2007 5:56:28 PM -06'00'

---

Author: hpq-relliott

Comments from page 12 continued on next page

## 4.6 Reporting of enclosure failure information

### 4.6.1 Reporting overview

Many enclosure functions are managed simply by setting controls and testing the status of the elements within an enclosure. However, the enclosure services process also monitors a variety of warning and error conditions. These conditions may be communicated to an application client using any of the following methods:

- a) polling (see 4.6.2);
- b) **timed disconnection polling** (see 4.6.3); or
- c) CHECK CONDITION status (see 4.6.4).

### 4.6.2 Polling

The application client may periodically poll the enclosure by sending a RECEIVE DIAGNOSTIC RESULTS command requesting an Enclosure Status diagnostic page (see 6.1.4) with an allocation **length greater than 1**. **The information returned in byte 1 of the Enclosure Status diagnostic page includes 5 bits that summarize** the status of the enclosure and its elements as described in 6.1.4. If one of these bits is set to one, detailed information may then be obtained by the application client by sending a RECEIVE DIAGNOSTIC RESULTS command requesting a complete Enclosure Status diagnostic page, Help Text diagnostic page (see 6.1.5), or Subenclosure Help Text diagnostic page (see 6.1.14).

### 4.6.3 Timed completion function

The application client may enable the optional **disconnect** function using the Enclosure Services Management mode page (see 6.3.2). The application client may then periodically poll the enclosure by sending a RECEIVE DIAGNOSTIC RESULTS command requesting an Enclosure Status diagnostic page (see 6.1.4) with an **allocation length greater than 1**. The return of the diagnostic page may be delayed until one or more of the **bits in byte 1 of the page are set** to one. The command shall be completed by the device server before the time specified in the MAXIMUM TASK COMPLETION TIME field is exceeded whether or not one of these bits is set to one. This polling option allows the application client to access warning and error information at a time closer to the detection of the information by the enclosure services process.

### 4.6.4 CHECK CONDITION status

For commands other than RECEIVE DIAGNOSTIC RESULTS and REQUEST SENSE sent to a device server serving as a standalone enclosure services process (see 4.1.2), the device server may indicate invalid operations, warning conditions, and failure conditions by terminating the command with CHECK CONDITION status with the sense key and additional sense code describing the indication. A subsequent RECEIVE DIAGNOSTIC RESULTS command requesting an Enclosure Status diagnostic page (see 6.1.4) may be required to clarify the indication and to identify the element causing the indication. ~~The device server may use the rules defined for informational exception conditions defined in SPC-4 to indicate conditions that do not require any recovery action.~~

For attached enclosure services processes (see 4.1.3), the device server shall not terminate commands with CHECK CONDITION status to indicate the presence of information from the enclosure services process. Application clients shall use polling to access the enclosure information through such **devices**.

## 4.7 Subenclosures

When a single enclosure is present, the primary subenclosure is the enclosure.

When multiple enclosures are present, the primary subenclosure is the enclosure whose enclosure **service process** provides access to enclosure services information of all the subenclosures. The enclosure services information from multiple subenclosures is **combined together** into a single set of SES diagnostic pages. The information from each subenclosure is **identified** in the Configuration diagnostic page (see 6.1.2) by its subenclosure identifier.

Subject: Note  
Date: 12/13/2007 8:24:34 PM -06'00'  
Add:

4.xx Asynchronous event notification (or maybe 4.6.xx)

For standalone enclosure services processes with a SCSI target port using a SCSI transport protocol that supports notification of SES asynchronous events (e.g., Broadcast (SES) in SAS-2), the enclosure services process:

[this may be better as a table]

- a) shall report an asynchronous event when the enclosure configuration is modified such that the Configuration diagnostic page changes (see 6.1.2.1); and
- b) shall report an asynchronous event when an element change results in a change to the PRDFAIL bit or the ELEMENT STATUS CODE field in the status element in the Enclosure Status diagnostic page (see 6.1.4);  
NOTE - this includes elements exceeding thresholds.
- c) may report an asynchronous event when an element change does not result in a change to the PRDFAIL bit or the ELEMENT STATUS CODE field in the status element in the Enclosure Status diagnostic page;
- g) should report an asynchronous event when the Element Descriptor diagnostic page (see 6.1.13) changes;
- g) should report an asynchronous event when the Short Enclosure Status diagnostic page (see 6.1.13) changes;
- g) should report an asynchronous event when the Additional Element Status diagnostic page (see 6.1.13) changes;
- f) should report an asynchronous event when the Download Microcode Status diagnostic page (see 6.1.19) changes; and
- g) should report an asynchronous event when the Subenclosure Nickname Status diagnostic page (see 6.1.21) changes.

Status

relliott Rejected 1/3/2008 7:23:38 PM -06'00'

---

Author: relliott

Subject: Note

Date: 12/14/2007 10:52:40 AM -06'00'

Download Microcode Status changes needs more thought, maybe only when microcode is activated

---

Author: relliott

Subject: Note

Date: 1/3/2008 7:23:34 PM -06'00'

only report Download Microcode Status changes for completions

---

Author: symc-roger

Subject: Note

Date: 12/13/2007 8:25:13 PM -06'00'

SYMANTEC 17

PDF pg 30, pg 12, 4.7 Subenclosures

The first sentence "When a single enclosure is present, the primary subenclosure is the enclosure." is extremely confusing with respect to the terminology in the Configuration diagnostic page, and flatly contradicts the last sentence in the third para that states "Subenclosures are those zero or more enclosures that contribute to the contents of the diagnostic pages but do not transmit them to the application client"

Proposed Resolution:

Change the first sentence "When visibility is restricted to the level of an entire enclosure, that enclosure shall be viewed as consisting of a single subenclosure with scope of the entire enclosure." Change the last sentence in the 3rd para to read "Non-primary Subenclosures are those zero or more enclosures that contribute to the contents of the diagnostic pages but do not transmit them to the application client."

Status

relliott Rejected 1/2/2008 7:08:24 PM -06'00'

---

Author: relliott

Subject: Note

Comments from page 12 continued on next page

## 4.6 Reporting of enclosure failure information

### 4.6.1 Reporting overview

Many enclosure functions are managed simply by setting controls and testing the status of the elements within an enclosure. However, the enclosure services process also monitors a variety of warning and error conditions. These conditions may be communicated to an application client using any of the following methods:

- a) polling (see 4.6.2);
- b) **timed disconnection polling** (see 4.6.3); or
- c) CHECK CONDITION status (see 4.6.4).

### 4.6.2 Polling

The application client may periodically poll the enclosure by sending a RECEIVE DIAGNOSTIC RESULTS command requesting an Enclosure Status diagnostic page (see 6.1.4) with an allocation **length greater than 1**. **The information returned in byte 1 of the Enclosure Status diagnostic page includes 5 bits that summarize** the status of the enclosure and its elements as described in 6.1.4. If one of these bits is set to one, detailed information may then be obtained by the application client by sending a RECEIVE DIAGNOSTIC RESULTS command requesting a complete Enclosure Status diagnostic page, Help Text diagnostic page (see 6.1.5), or Subenclosure Help Text diagnostic page (see 6.1.14).

### 4.6.3 Timed completion function

The application client may enable the optional **disconnect** function using the Enclosure Services Management mode page (see 6.3.2). The application client may then periodically poll the enclosure by sending a RECEIVE DIAGNOSTIC RESULTS command requesting an Enclosure Status diagnostic page (see 6.1.4) with an **allocation length greater than 1**. The return of the diagnostic page may be delayed until one or more of the **bits in byte 1 of the page are set** to one. The command shall be completed by the device server before the time specified in the MAXIMUM TASK COMPLETION TIME field is exceeded whether or not one of these bits is set to one. This polling option allows the application client to access warning and error information at a time closer to the detection of the information by the enclosure services process.

### 4.6.4 CHECK CONDITION status

For commands other than RECEIVE DIAGNOSTIC RESULTS and REQUEST SENSE sent to a device server serving as a standalone enclosure services process (see 4.1.2), the device server may indicate invalid operations, warning conditions, and failure conditions by terminating the command with CHECK CONDITION status with the sense key and additional sense code describing the indication. A subsequent RECEIVE DIAGNOSTIC RESULTS command requesting an Enclosure Status diagnostic page (see 6.1.4) may be required to clarify the indication and to identify the element causing the indication. The device server may use the rules defined for informational exception conditions defined in SPC-4 to indicate conditions that do not require any recovery action.

For attached enclosure services processes (see 4.1.3), the device server shall not terminate commands with CHECK CONDITION status to indicate the presence of information from the enclosure services process. Application clients shall use polling to access the enclosure information through such **devices**.

## 4.7 Subenclosures

When a single enclosure is present, the primary subenclosure is the enclosure.

When multiple enclosures are present, the primary subenclosure is the enclosure whose enclosure **service process** provides access to enclosure services information of all the subenclosures. The enclosure services information from multiple subenclosures is **combined together** into a single set of SES diagnostic pages. The information from each subenclosure is **identified** in the Configuration diagnostic page (see 6.1.2) by its subenclosure identifier.

Date: 1/2/2008 7:08:24 PM -06'00'

 An enclosure consists of one subenclosure or multiple subenclosures.

When a single subenclosure is present, it is considered the primary subenclosure. There are no secondary subenclosures.

When multiple subenclosures are present:

the primary subenclosure is the subenclosure whose enclosure services process provides access to enclosure services information of all the subenclosures; and  
all other subenclosures are considered secondary subenclosures.

Also, added a Enclosure box to the figure surrounding all the subenclosures.

---

Author: relliott  
Subject: Highlight  
Date: 5/12/2008 3:36:09 PM  
 service process  
s/b  
services process

Status  
relliott Accepted 12/13/2007 9:18:15 PM -06'00'  
Status  
relliott Confirmed 12/13/2007 9:18:18 PM -06'00'

---

Author: relliott  
Subject: Underline  
Date: 5/12/2008 3:36:09 PM  
 Move this below the figure:

The enclosure services information from multiple subenclosures is combined together into a single set of SES diagnostic pages. The information from each subenclosure is identified in the Configuration diagnostic page (see 6.1.2) by its subenclosure identifier.

Status  
relliott Accepted 12/17/2007 2:32:38 PM -06'00'  
Status  
relliott Confirmed 12/17/2007 2:32:40 PM -06'00'

---

Author: relliott  
Subject: Highlight  
Date: 5/12/2008 3:36:09 PM  
 combined together  
s/b  
... by the primary subenclosure

(explain who does it)

Status  
relliott Accepted 1/2/2008 7:34:17 PM -06'00'

---

Author: relliott  
Subject: Note  
Date: 5/12/2008 3:36:09 PM  
 To address comment on NUMBER OF SUBENCLOSURES field, change to:

When multiple enclosures are present:  
the primary subenclosure is the enclosure whose enclosure services process provides access to enclosure services information of all the subenclosures; and  
all other enclosures are secondary subenclosures.

Status  
relliott Accepted 12/17/2007 2:32:06 PM -06'00'  
Status  
relliott Confirmed 12/17/2007 2:32:10 PM -06'00'

---

Author: relliott  
Subject: Highlight  
Date: 5/12/2008 3:36:09 PM  
 identified

Comments from page 12 continued on next page

## 4.6 Reporting of enclosure failure information

### 4.6.1 Reporting overview

Many enclosure functions are managed simply by setting controls and testing the status of the elements within an enclosure. However, the enclosure services process also monitors a variety of warning and error conditions. These conditions may be communicated to an application client using any of the following methods:

- a) polling (see 4.6.2);
- b) **timed disconnection polling** (see 4.6.3); or
- c) CHECK CONDITION status (see 4.6.4).

### 4.6.2 Polling

The application client may periodically poll the enclosure by sending a RECEIVE DIAGNOSTIC RESULTS command requesting an Enclosure Status diagnostic page (see 6.1.4) with an allocation **length greater than 1**. **The information returned in byte 1 of the Enclosure Status diagnostic page includes 5 bits that summarize** the status of the enclosure and its elements as described in 6.1.4. If one of these bits is set to one, detailed information may then be obtained by the application client by sending a RECEIVE DIAGNOSTIC RESULTS command requesting a complete Enclosure Status diagnostic page, Help Text diagnostic page (see 6.1.5), or Subenclosure Help Text diagnostic page (see 6.1.14).

### 4.6.3 Timed completion function

The application client may enable the optional **disconnect** function using the Enclosure Services Management mode page (see 6.3.2). The application client may then periodically poll the enclosure by sending a RECEIVE DIAGNOSTIC RESULTS command requesting an Enclosure Status diagnostic page (see 6.1.4) with an **allocation length greater than 1**. The return of the diagnostic page may be delayed until one or more of the **bits in byte 1 of the page are set** to one. The command shall be completed by the device server before the time specified in the MAXIMUM TASK COMPLETION TIME field is exceeded whether or not one of these bits is set to one. This polling option allows the application client to access warning and error information at a time closer to the detection of the information by the enclosure services process.

### 4.6.4 CHECK CONDITION status

For commands other than RECEIVE DIAGNOSTIC RESULTS and REQUEST SENSE sent to a device server serving as a standalone enclosure services process (see 4.1.2), the device server may indicate invalid operations, warning conditions, and failure conditions by terminating the command with CHECK CONDITION status with the sense key and additional sense code describing the indication. A subsequent RECEIVE DIAGNOSTIC RESULTS command requesting an Enclosure Status diagnostic page (see 6.1.4) may be required to clarify the indication and to identify the element causing the indication. The device server may use the rules defined for informational exception conditions defined in SPC-4 to indicate conditions that do not require any recovery action.

For attached enclosure services processes (see 4.1.3), the device server shall not terminate commands with CHECK CONDITION status to indicate the presence of information from the enclosure services process. Application clients shall use polling to access the enclosure information through such **devices**.

## 4.7 Subenclosures

When a single enclosure is present, the primary subenclosure is the enclosure.

When multiple enclosures are present, the primary subenclosure is the enclosure whose enclosure **service process** provides access to enclosure services information of all the subenclosures. The enclosure services information from multiple subenclosures is **combined together** into a single set of SES diagnostic pages. The information from each subenclosure is **identified** in the Configuration diagnostic page (see 6.1.2) by its subenclosure identifier.

s/b  
distinguished

(the concept here is "tell them apart")

Status  
relliott Accepted 1/2/2008 7:34:20 PM -06'00'

---



Figure 4 shows an example of subenclosures.

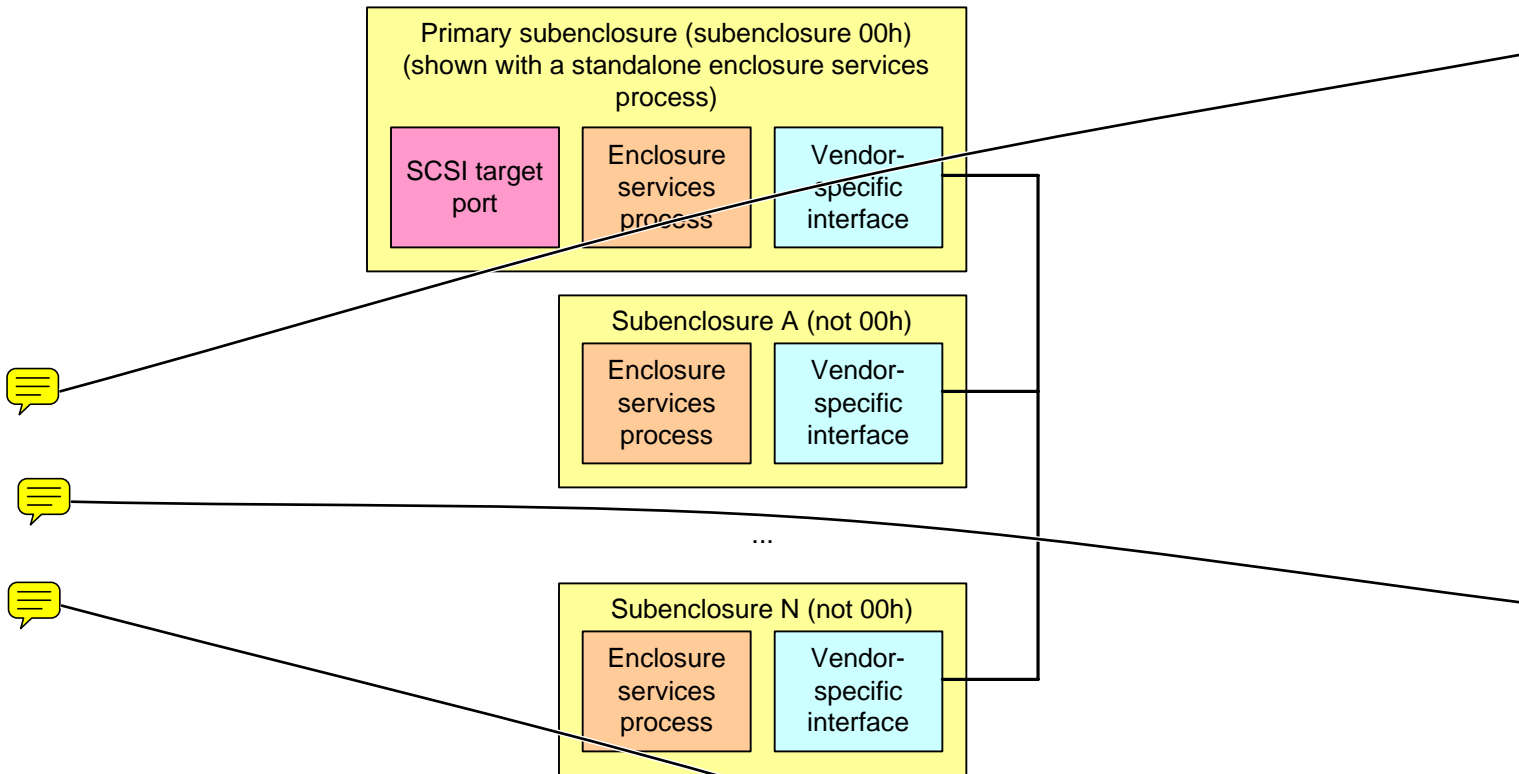

**Figure 4 — Subenclosures**

~~An enclosure may contain one or more devices, together with the associated power supplies, cooling devices, indicators, processor running the enclosure services process, and auxiliary equipment required to support those devices. The primary subenclosure is the enclosure that contains the enclosure services process responsible for transmitting SES diagnostic pages to the application client. Subenclosures are those zero or more enclosures that contribute to the contents of the diagnostic pages but do not transmit them to the application client.~~

The primary subenclosure selects an identifier for each subenclosure. That identifier is used to label the element entries and enclosure header entries associated with the subenclosure. The relationship between the subenclosure identifier and the subenclosure's location is vendor specific.

The relationship between the subenclosure identifier and the subenclosure is fixed for a particular configuration and configuration generation. As subenclosures are added or removed, the configuration and configuration generation shall change. The addition or removal of a subenclosure also may result in a change in the relationship between a physical subenclosure and the corresponding subenclosure identifier.

The primary subenclosure may access enclosure service information in a subenclosure using the SEND DIAGNOSTIC command and RECEIVE DIAGNOSTIC RESULTS commands over a SCSI transport protocol, or may use a vendor-specific interface.

#### 4.8 Additional sense codes

The additional sense code values defined for this standard are described in table 3. The values are assigned in SPC-4.

# Page: 13

---

● Author: symc-roger  
Subject: Note  
Date: 12/13/2007 8:25:13 PM -06'00'  
 SYMANTEC 18  
PDF pg 31, pg 13, Figure 4

The enclosure descriptor of the configuration diagnostic page supports multiple enclosure service processes per subenclosure, and this should be reflected in the figure.

Proposed Resolution:

Enclosure service process(es)

Status  
relliott Rejected 1/3/2008 6:58:42 PM -06'00'

---

Author: relliott  
Subject: Note  
Date: 1/2/2008 7:35:22 PM -06'00'

 added new section and new figure showing that. It's too complicated to overlay that with multiple subenclosures (which would then demand that standalone/attached be included as well).

---

● Author: symc-roger  
Subject: Note  
Date: 12/13/2007 8:25:13 PM -06'00'  
 SYMANTEC 19  
PDF pg 31, pg 13, Figure 4

The figure is the only place that indicates that the subenclosure identifier of the primary subenclosure should be 00h.

Proposed Resolution:

Prepend the following sentence to the second paragraph after the figure: "The subenclosure identifier of the primary subenclosure shall be 00h."

Status  
relliott Accepted 12/17/2007 2:27:01 PM -06'00'

Status  
relliott Confirmed 12/17/2007 2:27:04 PM -06'00'

---

● Author: relliott  
Subject: Note  
Date: 5/12/2008 3:36:09 PM  
 In new section on multiple processes, mention:

Elements may be accessible by one or more of the enclosure services processes. Coordination of access between multiple enclosure services processes is vendor specific.

Status  
relliott Accepted 1/4/2008 11:35:52 AM -06'00'

---

● Author: relliott  
Subject: Cross-Out  
Date: 5/12/2008 3:36:09 PM  
 Delete this, replaced by simpler text and an improved figure:

An enclosure may contain one or more devices, together with the associated power supplies, cooling devices, indicators, processor running the enclosure services process, and auxiliary equipment required to support those devices. The primary subenclosure is the enclosure that contains the enclosure services process responsible for transmitting SES diagnostic pages to the application client. Subenclosures are those zero or more enclosures that contribute to the contents of the diagnostic pages but do not transmit them to the application client.

Status

Comments from page 13 continued on next page

Figure 4 shows an example of subenclosures.

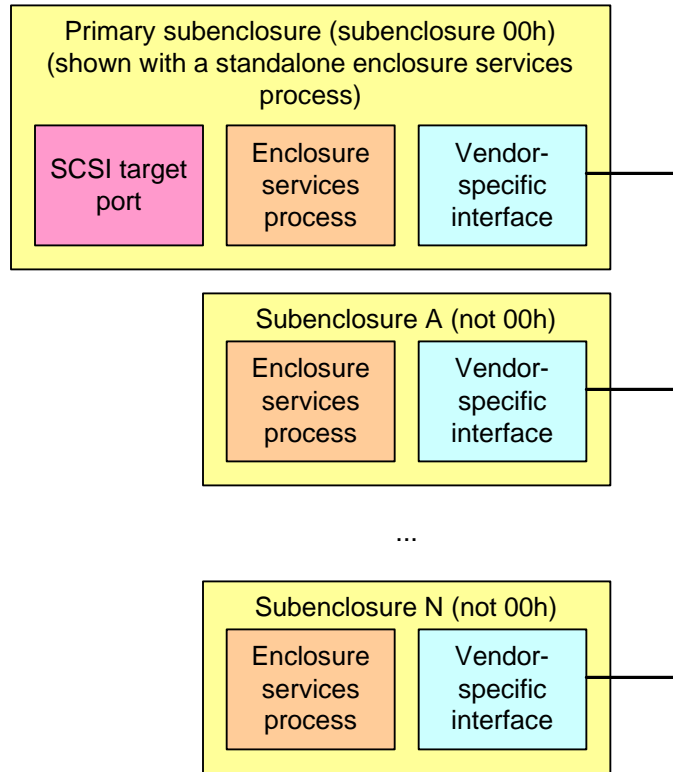

**Figure 4 — Subenclosures**

~~An enclosure may contain one or more devices, together with the associated power supplies, cooling devices, indicators, processor running the enclosure services process, and auxiliary equipment required to support those devices. The primary subenclosure is the enclosure that contains the enclosure services process responsible for transmitting SES diagnostic pages to the application client. Subenclosures are those zero or more enclosures that contribute to the contents of the diagnostic pages but do not transmit them to the application client.~~

The primary subenclosure selects an identifier for each subenclosure. That identifier is used to label the element entries and enclosure header entries associated with the subenclosure. The relationship between the subenclosure identifier and the subenclosure's location is vendor specific.

The relationship between the subenclosure identifier and the subenclosure is fixed for a particular configuration and configuration generation. As subenclosures are added or removed, the configuration and configuration generation shall change. The addition or removal of a subenclosure also may result in a change in the relationship between a physical subenclosure and the corresponding subenclosure identifier.

The primary subenclosure may access enclosure service information in a subenclosure using the SEND DIAGNOSTIC command and RECEIVE DIAGNOSTIC RESULTS commands over a SCSI transport protocol, or may use a vendor-specific interface.

**4.8 Additional sense codes**

The additional sense code values defined for this standard are described in table 3. The values are assigned in SPC-4.

Author: relliott

Subject: Highlight

Date: 5/12/2008 3:36:09 PM

**T** The primary subenclosure selects an identifier for each subenclosure. That identifier is used to label the element entries and enclosure header entries associated with the subenclosure. The relationship between the subenclosure identifier and the subenclosure's location is vendor specific.

The relationship between the subenclosure identifier and the subenclosure is fixed for a particular configuration and configuration generation. As subenclosures are added or removed, the configuration and configuration generation shall change. The addition or removal of a subenclosure also may result in a change in the relationship between a physical subenclosure and the corresponding subenclosure identifier.

s/b this, located immediately after the figure:

Each subenclosure is identified by a one-byte subenclosure identifier. The primary subenclosure has a subenclosure identifier of 00h. The primary subenclosure shall assign a non-zero subenclosure identifier for each secondary subenclosure. The relationship between the subenclosure identifier and the subenclosure's location is vendor specific.

The relationship between the subenclosure identifier and the subenclosure is fixed for a particular configuration and configuration generation. As subenclosures are added or removed, the configuration and configuration generation shall change. The addition or removal of a subenclosure also may result in a change in the relationship between a physical subenclosure and the corresponding subenclosure identifier.

Status

relliott Accepted 12/17/2007 2:26:33 PM -06'00'

Status

relliott Confirmed 12/17/2007 2:26:36 PM -06'00'

---

Table 3 — Sense keys and additional sense codes

Sense key/additional sense code	Reason
HARDWARE ERROR/ENCLOSURE FAILURE <sup>b</sup>	A critical or an unrecoverable enclosure failure has been detected by the enclosure services process (see 6.1.8). Further information may be available using the RECEIVE DIAGNOSTIC RESULTS command and requesting the Enclosure Status diagnostic page (see 6.1.4).
HARDWARE ERROR/ENCLOSURE SERVICES FAILURE <sup>a</sup>	The enclosure services process has failed in an unknown manner (see 6.1.11).
NOT READY/ENCLOSURE SERVICES UNAVAILABLE <sup>a</sup>	The device server or enclosure services process has been asked to invoke an enclosure services function that is temporarily busy or unavailable.
HARDWARE ERROR/ENCLOSURE SERVICES TRANSFER FAILURE <sup>a</sup>	The device server communication with the enclosure services process has failed.
HARDWARE ERROR or ILLEGAL REQUEST/ENCLOSURE SERVICES TRANSFER REFUSED <sup>a</sup>	The device server or the enclosure services process indicated either an error or an invalid format in their communication.
ILLEGAL REQUEST/UNSUPPORTED ENCLOSURE FUNCTION <sup>a</sup>	The enclosure services process has been asked to invoke an enclosure services function that does not exist (see 6.1.11). Also see 4.3.
RECOVERED ERROR/WARNING – ENCLOSURE DEGRADED <sup>b</sup>	An informational condition or a noncritical failure has been detected by the enclosure services process (see 6.1.8). This may be managed by the Informational Exceptions Control mode page (see SPC-4). Further information may be available using the RECEIVE DIAGNOSTIC RESULTS command and requesting the Enclosure Status diagnostic page (see 6.1.4).
<p><sup>a</sup> This additional sense code may be returned by any logical unit that provides access to enclosure services, either standalone or attached.</p> <p><sup>b</sup> This additional sense code should only be returned by a standalone enclosure services process in the sense data for a CHECK CONDITION status returned for a command other than RECEIVE DIAGNOSTIC RESULTS.</p>	

Author: relliott  
Subject: Note  
Date: 5/12/2008 3:36:09 PM

 Split the Sense key and Additional sense code into two columns. The barrage of all caps is hard to read.

Status

relliott Accepted 1/4/2008 11:39:56 AM -06'00'

---

Author: symc-roger  
Subject: Note

Date: 12/13/2007 8:25:13 PM -06'00'

 SYMANTEC 20

PDF pg 32, pg 14, Table 3

The term "enclosure services function" is only used in this table, and is undefined.

Proposed Resolution:

Add a definition - it's a function that is activated by changing the state of a bit in a control type diagnostic page?

Status

relliott Accepted 1/4/2008 5:26:48 PM -06'00'

---

Author: relliott

Subject: Note

Date: 1/4/2008 5:25:59 PM -06'00'

 These codes mostly come from SFF-8067 (ESI), reporting various errors between the disk drive's device server and the enclosure services process over the ESI bus.

#### UNSUPPORTED ENCLOSURE FUNCTION

- trying to use SEND DIAGNOSTIC; device server determines the enclosure services processor is only SFF-8045 compliant
- trying to use RECEIVE DIAGNOSTIC RESULTS; device server determines the enclosure services processor is SFF-8045 compliant but does not seem to support parallel ESI (8045 enclosures always return the Short Enclosure Status page and don't support writes)

#### ENCLOSURE SERVICES UNAVAILABLE

- trying to use SEND DIAGNOSTIC, enclosure seems to be 8067 compliant, but 1 second timeout occurs before an ENCL\_ACK in discovery phase
- trying to use RECEIVE DIAGNOSTIC RESULTS, enclosure seems to be 8067 compliant, but 1 second timeout occurs before an ENCL\_ACK in discovery phase

#### ENCLOSURE SERVICES TRANSFER FAILURE

- trying to use SEND DIAGNOSTIC, enclosure is 8067 compliant, but 100 usec timeout occurs before ENCL\_ACK in setup phase
- trying to use RECEIVE DIAGNOSTIC RESULTS, enclosure is 8067 compliant, but 100 usec timeout occurs before ENCL\_ACK in setup phase
- checksum error during RECEIVE DIAGNOSTIC RESULTS

#### ENCLOSURE SERVICES TRANSFER REFUSED

- trying to use SEND DIAGNOSTIC, enclosure is 8067 compliant, but 1 msec timeout occurs during data phase
- trying to use RECEIVE DIAGNOSTIC RESULTS, enclosure is 8067 compliant, but 1 msec timeout occurs during data phase

To make SES-2 clearer, I'll change the UNSUPPORTED ENCLOSURE FUNCTION description to:

"A SEND DIAGNOSTIC command has been attempted to a simple subenclosure (see 4.3.3)"

and ENCLOSURE SERVICES UNAVAILABLE to:

"The device server communication with the enclosure service process has encountered an error, but may become available again."

which gets rid of the "enclosure services function" phrase.

Table 3 — Sense keys and additional sense codes

Sense key/additional sense code	Reason
HARDWARE ERROR/ENCLOSURE FAILURE <sup>b</sup>	A critical or an unrecoverable enclosure failure has been detected by the enclosure services process (see 6.1.8). Further information may be available using the RECEIVE DIAGNOSTIC RESULTS command and requesting the Enclosure Status diagnostic page (see 6.1.4).
HARDWARE ERROR/ENCLOSURE SERVICES FAILURE <sup>a</sup>	The enclosure services process has failed in an unknown manner (see 6.1.11).
NOT READY/ENCLOSURE SERVICES UNAVAILABLE <sup>a</sup>	The device server or enclosure services process has been asked to invoke an enclosure services function that is temporarily busy or unavailable.
HARDWARE ERROR/ENCLOSURE SERVICES TRANSFER FAILURE <sup>a</sup>	The device server communication with the enclosure services process has failed.
HARDWARE ERROR or ILLEGAL REQUEST/ENCLOSURE SERVICES TRANSFER REFUSED <sup>a</sup>	The device server or the enclosure services process indicated either an error or an invalid format in their communication.
ILLEGAL REQUEST/UNSUPPORTED ENCLOSURE FUNCTION <sup>a</sup>	The enclosure services process has been asked to invoke an enclosure services function that does not exist (see 6.1.11). Also see 4.3.
RECOVERED ERROR/WARNING – ENCLOSURE DEGRADED <sup>b</sup>	An informational condition or a noncritical failure has been detected by the enclosure services process (see 6.1.8). This may be managed by the Informational Exceptions Control mode page (see SPC-4). Further information may be available using the RECEIVE DIAGNOSTIC RESULTS command and requesting the Enclosure Status diagnostic page (see 6.1.4).
<sup>a</sup> This additional sense code may be returned by any logical unit that provides access to enclosure services, either standalone or attached.	
<sup>b</sup> This additional sense code should only be returned by a standalone enclosure services process in the sense data for a CHECK CONDITION status returned for a command other than RECEIVE DIAGNOSTIC RESULTS.	

Status  
relliott None 1/4/2008 5:26:42 PM -06'00'

---

Author: relliott  
Subject: Note  
Date: 5/12/2008 3:36:09 PM  
 change see 6.1.8 to see 4.6 (the threshold model) in the ENCLOSURE FAILURE and WARNING - ENCLOSURE DEGRADED rows.

like this:  
"(e.g., from a threshold exceeding a critical limit (see 4.6))" and  
"(e.g., from a threshold exceeding a warning limit (see 4.6))"

from Morrie Glasser, EMC

Status  
RElliott Accepted 5/12/2008 2:45:32 PM

---

Author: ibm-gop  
Subject: Highlight  
Date: 12/13/2007 8:24:47 PM -06'00'  
 **Table 3 — Sense keys and additional sense codes**

**This << This additional sense code may be returned by any >> should be << may be returned by any >>**

Status  
relliott Accepted 1/4/2008 11:42:08 AM -06'00'

Status  
relliott Confirmed 12/13/2007 8:53:54 PM -06'00'

---

Author: relliott  
Subject: Highlight  
Date: 5/12/2008 3:36:09 PM

 standalone or attached  
s/b

standalone (see 4.1.2) or attached (see 4.1.3)

to match sync comment

Status  
relliott Accepted 12/13/2007 9:05:39 PM -06'00'

Status  
relliott Confirmed 12/13/2007 9:05:42 PM -06'00'

---

Author: ibm-gop  
Subject: Highlight  
Date: 12/13/2007 8:24:47 PM -06'00'

 **Table 3 — Sense keys and additional sense codes**

**This << This additional sense code should only be returned >> should be << Should only be returned >>**

Status  
relliott Accepted 1/4/2008 11:42:16 AM -06'00'

Status  
relliott Confirmed 12/13/2007 8:53:51 PM -06'00'

---



## 5 Commands for enclosure services peripheral devices

The commands for standalone enclosure services processes (i.e., logical units with the peripheral device type of enclosure services (i.e., 0Dh)) (see 4.1.2) are shown in table 4.

**Table 4 — Commands for standalone enclosure services processes** (part 1 of 2)

Command name	Operation code <sup>a</sup>	Type <sup>b</sup>	Reference
ACCESS CONTROL IN	86h	O	SPC-4
ACCESS CONTROL OUT	87h	O	SPC-4
CHANGE ALIASES	A4h/0Bh	O	SPC-4
INQUIRY <sup>f</sup>	12h	M	SPC-4
LOG SELECT	4Ch	O	SPC-4
LOG SENSE	4Dh	O	SPC-4
MAINTENANCE IN	A3h/00h - 04h A3h/06h - 09h	X <sup>e</sup>	SCC-2
MAINTENANCE OUT	A4h/00h - 05h A4h/07h - 09h	X <sup>e</sup>	SCC-2
MODE SELECT (10)	55h	O	SPC-4
MODE SELECT (6)	15h	O	SPC-4
MODE SENSE (10)	5Ah	O	SPC-4
MODE SENSE (6)	1Ah	O	SPC-4
PERSISTENT RESERVE IN	5Eh	O	SPC-4
PERSISTENT RESERVE OUT	5Fh	O	SPC-4
READ BUFFER	3Ch	O	SPC-4
RECEIVE DIAGNOSTIC RESULTS <sup>c</sup>	1Ch	M	SPC-4
REDUNDANCY GROUP IN	BAh	X <sup>e</sup>	SCC-2
REDUNDANCY GROUP OUT	BBh	X <sup>e</sup>	SCC-2
REPORT ALIASES	A3h/0Bh	O	SPC-4
REPORT DEVICE IDENTIFIER	A3h/05h	O	SPC-4
REPORT LUNS	A0h	M	SPC-4
REPORT PRIORITY	A3h/0Eh	O	SPC-4
REPORT SUPPORTED OPERATION CODES	A3h/0Ch	O	SPC-4
REPORT SUPPORTED TASK MANAGEMENT FUNCTIONS	A3h/0Dh	O	SPC-4
REPORT TARGET PORT GROUPS	A3h/0Ah	O	SPC-4
REPORT TIMESTAMP	A3h/0Fh	O	SPC-4
REQUEST SENSE	03h	M	SPC-4
SEND DIAGNOSTIC <sup>d</sup>	1Dh	M	SPC-4
SET DEVICE IDENTIFIER	A4h/06h	O	SPC-4
SET PRIORITY	A4h/0Eh	O	SPC-4
SET TARGET PORT GROUPS	A4h/0Ah	O	SPC-4
SET TIMESTAMP	A4h/0Fh	O	SPC-4

● Author: hpq-relliott

Subject: Note

Date: 12/13/2007 8:24:34 PM -06'00'

 Verify command list agrees with SPC-4

Status

relliott Accepted 12/16/2007 6:03:08 PM -06'00'

Status

relliott Confirmed 12/16/2007 6:03:13 PM -06'00'

---

Author: relliott

Subject: Note

Date: 12/16/2007 6:03:15 PM -06'00'

 REPORT/SET DEVICE IDENTIFIER -> REPORT/SET IDENTIFYING INFORMATION

---

Table 4 — Commands for standalone enclosure services processes (part 2 of 2)

Command name	Operation code <sup>a</sup>	Type <sup>b</sup>	Reference
SPARE IN	BCh	X <sup>e</sup>	SCC-2
SPARE OUT	BDh	X <sup>e</sup>	SCC-2
TEST UNIT READY	00h	M	SPC-4
VOLUME SET IN	BEh	X <sup>e</sup>	SCC-2
VOLUME SET OUT	BFh	X <sup>e</sup>	SCC-2
WRITE BUFFER	3Bh	O	SPC-4
The following operation codes are obsolete: 16h (RESERVE (6)), 17h (RELEASE (6)), 56h (RESERVE (10)), 57h (RELEASE (10))			
All operation codes for enclosure services type peripheral devices not specified in this table are reserved for future standardization.			
<sup>a</sup> Some commands are defined by a combination of operation code and service action. The operation code value is shown preceding the slash and the service action value is shown after the slash. <sup>b</sup> M = command implementation is mandatory. O = command implementation is optional. X = Command implementation requirements detailed in the reference. <sup>c</sup> Enclosure services status-type diagnostic pages are transferred by the RECEIVE DIAGNOSTIC RESULTS command with the PF bit set to one. <sup>d</sup> Enclosure services control-type diagnostic pages are transferred by the SEND DIAGNOSTIC command. Device servers are only required to accept a single diagnostic page in each command. <sup>e</sup> If the sccs bit is set to one in the standard INQUIRY data (see SPC-4), these commands shall be supported as required by SCC-2. If the sccs bit is set to zero, these commands shall not be supported. <sup>f</sup> In the standard INQUIRY data (see SPC-4), the MCHNGR bit shall be set to zero.			



All the commands are described in the referenced standards. The diagnostic pages accessed by the SEND DIAGNOSTIC command and the RECEIVE DIAGNOSTIC RESULTS command are defined in 6.1. The elements accessed by some of the diagnostic pages are defined in clause 7. The format for the mode parameters and mode page accessed by the MODE SELECT commands and the MODE SENSE commands are defined in 6.3.

# Page: 16

---

Author: relliott  
Subject: Highlight  
Date: 5/12/2008 3:36:09 PM  
 Enclosure services  
s/b  
SES

Status  
relliott Accepted 1/3/2008 5:54:31 PM -06'00'

---

Author: symc-roger  
Subject: Note  
Date: 12/13/2007 8:25:13 PM -06'00'  
 SYMANTEC 21  
PDF pg 34, pg 16, Table 4 Footnote c

Question: The PF bit should be the PCV bit, and this should be expressed as a requirement in normative text. Also does it say anywhere that the SES pages SHALL be accessed by the SEND SEND DIAGNOSTIC command and a RECEIVE DIAGNOSTIC RESULTS commands?

Proposed Resolution:

Correct the bit name. Change the second sentence after the table to read "The diagnostic pages associated with an enclosure service process that shall be accessed by a SEND DIAGNOSTIC command and a RECEIVE DIAGNOSTIC RESULTS command with the PCV bit set to one are defined in 6.1."

Status  
relliott Rejected 1/3/2008 6:10:58 PM -06'00'

---

Author: relliott  
Subject: Note  
Date: 1/3/2008 6:11:00 PM -06'00'

 fixed PCV acronym.

Added "PF bit set to one" to the SEND DIAGNOSTIC footnote to match.

Didn't add "shall" in the sentence after the table, and deleted reference to the PCV bit in that sentence.

---

Author: relliott  
Subject: Highlight  
Date: 5/12/2008 3:36:09 PM  
 by the SEND DIAGNOSTIC command.  
s/b  
... with the PF bit set to one

Status  
relliott Accepted 1/3/2008 5:54:09 PM -06'00'

---

Author: relliott  
Subject: Highlight  
Date: 5/12/2008 3:36:09 PM  
 Enclosure services  
s/b  
SES

Status  
relliott Accepted 1/3/2008 5:54:40 PM -06'00'

---

## 6 Parameters for enclosure services devices

### 6.1 Diagnostic parameters

#### 6.1.1 Diagnostic parameters overview

This clause defines the diagnostic page structure and the diagnostic pages that are applicable to enclosure services devices and other device types that provide communications access to an enclosure services process. Control pages are accessed with the SEND DIAGNOSTIC command; status pages are accessed with the RECEIVE DIAGNOSTIC RESULTS command.

The diagnostic page format is specified in SPC-4. All diagnostic pages have the diagnostic page header defined in SPC-4, including the PAGE CODE and PAGE LENGTH fields.



● Author: ibm-gop  
Subject: Highlight  
Date: 12/13/2007 8:24:47 PM -06'00'

**T 6.1.1 Diagnostic parameters overview (1st paragraph)**

**This << with the SEND DIAGNOSTIC command; status pages are accessed >> should be << with the SEND DIAGNOSTIC command and status pages are accessed >>**

Status  
relliott Accepted 1/2/2008 7:36:06 PM -06'00'

---

● Author: hpq-relliott  
Subject: Note  
Date: 12/13/2007 8:24:34 PM -06'00'

 Incorporate 08-026 SES-2 Element control and status nomenclature

Status  
relliott Accepted 12/20/2007 7:44:07 PM -06'00'

---

Author: relliott  
Subject: Note  
Date: 12/20/2007 7:44:05 PM -06'00'

 caused a few additional related changes to agree with new text that are not specifically in 08-026r0. Marked significant ones with unique comments, but lost a few of them when Acrobat crashed.

---

The PAGE CODE field identifies the diagnostic page being sent or requested. The page codes are defined in table 5.

**Table 5 — Diagnostic page codes for enclosure service devices**

Page code	Description	Control or status	Reference
00h	Supported Diagnostic Pages diagnostic page	Status	SPC-4
01h	Configuration diagnostic page	Status	6.1.2
02h	Enclosure Control diagnostic page	Control	6.1.3
	Enclosure Status diagnostic page	Status	6.1.4
03h	Help Text diagnostic page	Status	6.1.5
04h	String Out diagnostic page	Control	6.1.6
	String In diagnostic page	Status	6.1.7
05h	Threshold Out diagnostic page	Control	6.1.8
	Threshold In diagnostic page	Status	6.1.9
06h	Obsolete		
07h	Element Descriptor diagnostic page	Status	6.1.10
08h	Short Enclosure Status diagnostic page	Status	6.1.11
09h	Enclosure Busy diagnostic page	Status	6.1.12
0Ah	Additional Element Status diagnostic page	Status	6.1.13
0Bh	Subenclosure Help Text diagnostic page	Status	6.1.14
0Ch	Subenclosure String Out diagnostic page	Control	6.1.15
	Subenclosure String In diagnostic page	Status	6.1.16
0Dh	Supported SES Diagnostic Pages diagnostic page	Status	6.1.17
0Eh	Download Microcode Control diagnostic page	Control	6.1.18
	Download Microcode Status diagnostic page	Status	6.1.19
0Fh	Subenclosure Nickname Control diagnostic page	Control	6.1.20
	Subenclosure Nickname Status diagnostic page	Status	6.1.21
10h - 1Fh	Vendor-specific SES diagnostic pages		
20h - 2Fh	Reserved for this standard		
30h - 3Fh	Reserved for all peripheral device types		SPC-4
40h - 7Fh	See specific peripheral device type for definition. Reserved for the SES peripheral device type		SPC-4
80h - FFh	Vendor-specific pages		SPC-4

The Supported Diagnostic Pages diagnostic page specified in SPC-4 contains a list of all diagnostic page codes implemented by the device server in ascending order beginning with page code 00h. If the device is capable of accessing a diagnostic function or enclosure function that may temporarily or permanently be unavailable to the device, the PAGE CODE associated with that information shall be included in the list. The unavailability of the resources necessary to transfer a page shall not result in an error until a command attempts to access that diagnostic page. Device servers supporting access to an attached enclosure services process (see 4.1.3) shall direct diagnostic pages 10h through 2Fh to the attached enclosure services process and shall include page codes 00h through 2Fh in the Supported Diagnostic Pages list.

# Page: 18

---

Author: hpq-relliott  
Subject: Note  
Date: 12/13/2007 8:24:34 PM -06'00'  
 Verify diagnostic page list matches SPC-4

Status  
relliott Accepted 12/16/2007 6:18:14 PM -06'00'  
Status  
relliott Confirmed 12/16/2007 6:18:19 PM -06'00'

---

Author: relliott  
Subject: Note  
Date: 12/16/2007 6:18:21 PM -06'00'  
 Add 3Fh Transport protocol specific diagnostic page  
Notify SPC-4 that Device Element Status s/b Additional Element Status  
Notify SPC-4 that Sub-enclosure s/b Subenclosure  
Notify SPC-4 of 0Eh and 0Fh

---

Author: relliott  
Subject: Note  
Date: 5/12/2008 3:36:09 PM  
 Add visual indication in the table about which page codes are in the SES region

Status  
relliott Accepted 1/2/2008 7:40:50 PM -06'00'

---

Author: relliott  
Subject: Highlight  
Date: 5/12/2008 3:36:09 PM  
 pages  
s/b  
diagnostic pages

Status  
relliott Accepted 12/19/2007 7:26:00 PM -06'00'  
Status  
relliott Confirmed 12/17/2007 12:15:48 PM -06'00'

---

Author: relliott  
Subject: Highlight  
Date: 5/12/2008 3:36:09 PM  
 specified  
s/b  
defined

Status  
relliott Accepted 12/16/2007 6:19:00 PM -06'00'  
Status  
relliott Confirmed 12/16/2007 6:19:05 PM -06'00'

---

Author: relliott  
Subject: Highlight  
Date: 5/12/2008 3:36:09 PM  
 device  
s/b  
device server

Status  
relliott Accepted 12/15/2007 5:34:03 PM -06'00'  
Status  
relliott Confirmed 12/15/2007 5:34:06 PM -06'00'

---

Author: relliott  
Subject: Highlight  
Date: 5/12/2008 3:36:09 PM  
 page code  
s/b

Comments from page 18 continued on next page



The PAGE CODE field identifies the diagnostic page being sent or requested. The page codes are defined in table 5.

**Table 5 — Diagnostic page codes for enclosure service devices**

Page code	Description	Control or status	Reference
00h	Supported Diagnostic Pages diagnostic page	Status	SPC-4
01h	Configuration diagnostic page	Status	6.1.2
02h	Enclosure Control diagnostic page	Control	6.1.3
	Enclosure Status diagnostic page	Status	6.1.4
03h	Help Text diagnostic page	Status	6.1.5
04h	String Out diagnostic page	Control	6.1.6
	String In diagnostic page	Status	6.1.7
05h	Threshold Out diagnostic page	Control	6.1.8
	Threshold In diagnostic page	Status	6.1.9
06h	Obsolete		
07h	Element Descriptor diagnostic page	Status	6.1.10
08h	Short Enclosure Status diagnostic page	Status	6.1.11
09h	Enclosure Busy diagnostic page	Status	6.1.12
0Ah	Additional Element Status diagnostic page	Status	6.1.13
0Bh	Subenclosure Help Text diagnostic page	Status	6.1.14
0Ch	Subenclosure String Out diagnostic page	Control	6.1.15
	Subenclosure String In diagnostic page	Status	6.1.16
0Dh	Supported SES Diagnostic Pages diagnostic page	Status	6.1.17
0Eh	Download Microcode Control diagnostic page	Control	6.1.18
	Download Microcode Status diagnostic page	Status	6.1.19
0Fh	Subenclosure Nickname Control diagnostic page	Control	6.1.20
	Subenclosure Nickname Status diagnostic page	Status	6.1.21
10h - 1Fh	Vendor-specific SES diagnostic pages		
20h - 2Fh	Reserved for this standard		
30h - 3Fh	Reserved for all peripheral device types		SPC-4
40h - 7Fh	See specific peripheral device type for definition. Reserved for the SES peripheral device type		SPC-4
80h - FFh	Vendor-specific pages		SPC-4

The Supported Diagnostic Pages diagnostic page specified in SPC-4 contains a list of all diagnostic page codes implemented by the device server in ascending order beginning with page code 00h. If the device is capable of accessing a diagnostic function or enclosure function that may temporarily or permanently be unavailable to the device, the PAGE CODE associated with that information shall be included in the list. The unavailability of the resources necessary to transfer a page shall not result in an error until a command attempts to access that diagnostic page. Device servers supporting access to an attached enclosure services process (see 4.1.3) shall direct diagnostic pages 10h through 2Fh to the attached enclosure services process and shall include page codes 00h through 2Fh in the Supported Diagnostic Pages list.

diagnostic page code

Status  
relliott Accepted 12/17/2007 12:16:02 PM -06'00'  
Status  
relliott Confirmed 12/17/2007 12:16:05 PM -06'00'

---

Author: relliott  
Subject: Highlight  
Date: 5/12/2008 3:36:09 PM  
**T** capable of accessing a diagnostic function or enclosure function that may temporarily or permanently be unavailable to the device, the PAGE CODE associated with that information shall be included  
s/b  
capable of accessing a diagnostic page that may ..., its diagnostic page code shall be included

Status  
relliott Accepted 12/17/2007 12:16:47 PM -06'00'  
Status  
relliott Confirmed 12/17/2007 12:16:50 PM -06'00'

---

Author: relliott  
Subject: Cross-Out  
Date: 5/12/2008 3:36:09 PM  
**T** to the device

Status  
relliott Accepted 12/15/2007 5:33:59 PM -06'00'  
Status  
relliott Confirmed 12/15/2007 5:33:57 PM -06'00'

---

Author: relliott  
Subject: Highlight  
Date: 5/12/2008 3:36:09 PM  
**T** page  
s/b  
diagnostic page

Status  
relliott Accepted 12/15/2007 5:34:15 PM -06'00'  
Status  
relliott Confirmed 12/15/2007 5:34:18 PM -06'00'

---

Author: relliott  
Subject: Note  
Date: 5/12/2008 3:36:09 PM  
 Paragraph break before discussing the ranges

Status  
relliott Accepted 12/15/2007 5:33:38 PM -06'00'  
Status  
relliott Confirmed 12/15/2007 5:33:40 PM -06'00'

---

Author: relliott  
Subject: Highlight  
Date: 5/12/2008 3:36:09 PM  
**T** 10h  
s/b  
01h

because pages 01h-0Fh are also passed to the attached enclosure services process

Status  
relliott Accepted 1/2/2008 7:40:18 PM -06'00'

---

Author: relliott  
Subject: Highlight  
Date: 5/12/2008 3:36:09 PM  
**T** shall include page codes 00h through 2Fh in the Supported Diagnostic Pages list.  
s/b

shall report all diagnostic page codes 00h through 2Fh in the Supported Diagnostic Pages diagnostic page.

Status  
relliott Accepted 12/17/2007 12:17:10 PM -06'00'  
Status  
relliott Confirmed 12/17/2007 12:17:14 PM -06'00'

Comments from page 18 continued on next page

---

## 6.1.2 Configuration diagnostic page

### 6.1.2.1 Configuration diagnostic page overview

The Configuration diagnostic page returns a list of elements in an enclosure. ~~This page shall be implemented if the device supports enclosure services and does not use the Short Enclosure Status diagnostic page (see 6.1.11).~~ The element list shall include all elements with defined element status or controls and may list any other elements in the enclosure. The Configuration diagnostic page provides enclosure descriptor information and parameters. The Configuration diagnostic page optionally provides descriptive text identifying element types in more detail.

The Configuration diagnostic page is read by the RECEIVE DIAGNOSTIC RESULTS command with a PCV bit set to one and a PAGE CODE field set to 01h. If the parameter list for a SEND DIAGNOSTIC command contains a PAGE CODE field set to 01h, the command shall be treated as having an invalid field error (see 4.5).

Table 6 provides an overview of the components of the Configuration diagnostic page.

**Table 6 — Layout of Configuration diagnostic page**

Component name	Description	Reference
Diagnostic page header	Describes diagnostic page	SPC-4
Generation code	Generation code	this subclause
Enclosure descriptor list	Describes subenclosure(s)	6.1.2.2
Type descriptor header list for Device elements and Array Device elements	Contains type descriptor headers for Device elements and Array Device elements (see 7.3.2 and 7.3.3) in the enclosure	6.1.2.3
Type descriptor header list for other elements	Identifies all other element types included in the enclosure	6.1.2.3
Type descriptor text list	Provides optional text descriptions for each element type in the enclosure	6.1.2.4

Author: relliott  
Subject: Cross-Out  
Date: 5/12/2008 3:36:09 PM

 This page shall be implemented if the device supports enclosure services and does not use the Short Enclosure Status diagnostic page (see 6.1.11).

Status  
relliott Accepted 12/17/2007 3:25:11 PM -06'00'

Status  
relliott Confirmed 12/17/2007 3:25:15 PM -06'00'

---

Author: hpq-relliott  
Subject: Highlight  
Date: 12/13/2007 8:24:34 PM -06'00'

 returns a list of elements in an enclosure  
s/b  
returns information about the enclosure, including the list of elements in the enclosure.

Status  
relliott Accepted 12/17/2007 12:19:42 PM -06'00'

Status  
relliott Confirmed 12/17/2007 12:19:46 PM -06'00'

---

Author: relliott  
Subject: Highlight  
Date: 5/12/2008 3:36:09 PM

 device supports enclosure services  
s/b  
device server is an enclosure services process (see 4.1.2)

Status  
relliott Accepted 12/15/2007 4:56:14 PM -06'00'

Status  
relliott Confirmed 12/15/2007 4:56:23 PM -06'00'

---

Author: symc-roger  
Subject: Note  
Date: 12/13/2007 8:25:13 PM -06'00'

 SYMANTEC 22  
PDF pg 37, pg 19, 6.1.2.1 Configuration diagnostic page overview

Use of the term device in "if the device supports enclosure services and does not use the Short Enclosure Status diagnostic page" is extremely problematic. Section 4.7 states "an enclosure may contain one or more devices". When combined with the requirements in 6.1.11, its not clear if the Short Enclosure Status page can ever be reported.



Proposed Resolution:

Please clarify - I have no good suggestions.

Status  
relliott Accepted 12/21/2007 6:26:23 PM -06'00'

---

Author: relliott  
Subject: Note  
Date: 12/21/2007 6:26:23 PM -06'00'

 Added definitions for simple, primary, secondary subenclosure  
 Changed 4.3 into a second on simple subenclosures  
Fixed conflicting rules

---

Author: ibm-gop  
Subject: Highlight  
Date: 12/13/2007 8:24:47 PM -06'00'

 **6.1.2.1 Configuration diagnostic page overview (1st paragraph)**

This << The Configuration diagnostic page optionally provides descriptive text identifying element >> should be << The

6.1.2 Configuration diagnostic page

6.1.2.1 Configuration diagnostic page overview



The Configuration diagnostic page returns a list of elements in an enclosure. ~~This page shall be implemented if the device supports enclosure services and does not use the Short Enclosure Status diagnostic page (see 6.1.11).~~ The element list shall include all elements with defined element status or controls and may list any other elements in the enclosure. The Configuration diagnostic page provides enclosure descriptor information and parameters. The Configuration diagnostic page optionally provides descriptive text identifying element types in more detail.

The Configuration diagnostic page is read by the RECEIVE DIAGNOSTIC RESULTS command with a PCV bit set to one and a PAGE CODE field set to 01h. If the parameter list for a SEND DIAGNOSTIC command contains a PAGE CODE field set to 01h, the command shall be treated as having an invalid field error (see 4.5).

Table 6 provides an overview of the components of the Configuration diagnostic page.

Table 6 — Layout of Configuration diagnostic page

Component name	Description	Reference
Diagnostic page header	Describes diagnostic page	SPC-4
Generation code	Generation code	this subclause
Enclosure descriptor list	Describes subenclosure(s)	6.1.2.2
Type descriptor header list for Device elements and Array Device elements	Contains type descriptor headers for Device elements and Array Device elements (see 7.3.2 and 7.3.3) in the enclosure	6.1.2.3
Type descriptor header list for other elements	Identifies all other element types included in the enclosure	6.1.2.3
Type descriptor text list	Provides optional text descriptions for each element type in the enclosure	6.1.2.4

**Configuration diagnostic page may provide descriptive text identifying element >>**

Status  
relliott Accepted 12/17/2007 3:32:57 PM -06'00'  
Status  
relliott Confirmed 12/17/2007 3:33:00 PM -06'00'

---

Author: ibm-gop  
Subject: Highlight  
Date: 12/13/2007 8:24:47 PM -06'00'  
**T** 6.1.2.1 Configuration diagnostic page overview (2nd paragraph)

This << command shall be treated as having an invalid field error >> should be << command shall fail with an invalid field error >>

Status  
relliott Accepted 3/19/2008 1:53:34 PM

---

Author: relliott  
Subject: Note  
Date: 3/19/2008 1:53:36 PM  
 it doesn't always fail. With attached enclosure services, it still returns GOOD status. Reworded as  
"A page code field set to NNh in the parameter list for a SEND DIAGNOSTIC command is an invalid field error"

---

Author: ibm-gop  
Subject: Highlight  
Date: 12/13/2007 8:24:47 PM -06'00'  
**T** 6.1.2.1 Configuration diagnostic page overview (3rd paragraph)

This << Table 6 provides an overview of the components of the >> should be << Table 6 indicates the components of the >>

Status  
relliott Rejected 12/21/2007 6:26:48 PM -06'00'

---

Author: relliott  
Subject: Note  
Date: 12/21/2007 6:26:48 PM -06'00'  
 table wiped out per other comment

---

Table 7 defines the Configuration diagnostic page.

**Table 7 — Configuration diagnostic page**

Byte/Bit	7	6	5	4	3	2	1	0	
Diagnostic page header									
0	PAGE CODE (01h)								
1	NUMBER OF SUBENCLOSURES								
2	(MSB)	PAGE LENGTH (n - 3)						(LSB)	
3									
Generation code									
4	(MSB)	GENERATION CODE						(LSB)	
7									
Enclosure descriptor list									
Enclosure descriptor(s) (one per subenclosure)(see table 8 in 6.1.2.2)									
Type descriptor header list									
Type descriptor header(s)(see table 9 in 6.1.2.3)									
Type descriptor text list									
Type descriptor text(s) (one per type descriptor header)(see 6.1.2.4)									
n									

The PAGE CODE field is set to 01h.

The NUMBER OF SUBENCLOSURES field indicates the number of separate subenclosures included in the enclosure descriptor list, not including the primary subenclosure (i.e., a NUMBER OF SUBENCLOSURES field set to zero indicates there is only a primary subenclosure). The primary subenclosure shall be described by the first enclosure descriptor. Additional subenclosures shall be described in subsequent enclosure descriptors, and may be included in any order.

The PAGE LENGTH field contains the length in bytes of the diagnostic parameters that follow.

The GENERATION CODE field is a four-byte counter that shall be incremented by one by the primary enclosure services process every time the enclosure configuration is modified such that the Configuration diagnostic page changes. The counter shall not be changed by status changes for elements already described by the Configuration diagnostic page. Changes in the Configuration diagnostic page may be caused by changes in the number or configuration of subenclosures. Enclosures that do not change in configuration may use a fixed value of zero for the GENERATION CODE field.

Standalone enclosure services processes shall establish a unit attention condition (see SAM-4 and SPC-4) for all I\_T nexuses when there is a change in value of the GENERATION CODE field. The additional sense code for the unit attention condition shall be TARGET OPERATING CONDITIONS HAVE CHANGED. The unit attention condition shall be cleared for all I\_T nexuses without being reported if a RECEIVE DIAGNOSTIC RESULTS command is processed that requests a Configuration diagnostic page (i.e., the PAGE CODE field set to 01h).

Application clients accessing an attached enclosure services process should verify that the value of the GENERATION CODE field has not unexpectedly changed, since no unit attention condition is established by the device server.



## Page: 20

---

● Author: symc-roger  
Subject: Note  
Date: 12/13/2007 8:25:13 PM -06'00'  
 SYMANTEC 23  
PDF pg 38, pg 20, Table 7

Remove the "diagnostic page header" line as it seems to appear in no other Tables.

Proposed Resolution:

Please delete

Status  
relliott Accepted 12/21/2007 6:25:23 PM -06'00'

---

● Author: symc-roger  
Subject: Note  
Date: 12/13/2007 8:25:13 PM -06'00'  
 SYMANTEC 24  
PDF pg 39, pg 21, 6.1.2.1 Configuration diagnostic page overview

The description of "NUMBER OF SUBENCLOSURES" field, while correct, is decidedly counterintuitive.

Proposed Resolution:

Can the field be renamed "NUMBER OF NON-PRIMARY SUBENCLOSURES"?

Status  
relliott Accepted 12/17/2007 12:21:50 PM -06'00'

Status  
relliott Confirmed 12/17/2007 12:21:53 PM -06'00'

---

Author: relliott  
Subject: Note  
Date: 12/15/2007 6:00:31 PM -06'00'  
 Changed to NUMBER OF SECONDARY SUBENCLOSURES (with appropriate definition added)

---

● Author: relliott  
Subject: Highlight  
Date: 5/12/2008 3:36:09 PM  
 separate subenclosures  
to  
secondary subenclosures

Status  
relliott Accepted 12/15/2007 6:01:05 PM -06'00'

Status  
relliott Confirmed 12/15/2007 6:01:07 PM -06'00'

---

● Author: relliott  
Subject: Highlight  
Date: 5/12/2008 3:36:09 PM  
 NUMBER OF SUBENCLOSURES  
to  
NUMBER OF SECONDARY SUBENCLOSURES

Status  
relliott Accepted 12/15/2007 6:00:48 PM -06'00'

Status  
relliott Confirmed 12/15/2007 6:00:50 PM -06'00'

---

● Author: relliott  
Subject: Highlight  
Date: 5/12/2008 3:36:09 PM  
 Additional subenclosures  
to  
Secondary subenclosures

Comments from page 20 continued on next page

Table 7 defines the Configuration diagnostic page.

**Table 7 — Configuration diagnostic page**

Byte/Bit	7	6	5	4	3	2	1	0
Diagnostic page header								
0	PAGE CODE (01h)							
1	NUMBER OF SUBENCLOSURES							
2	(MSB)	PAGE LENGTH (n - 3)						(LSB)
3								
Generation code								
4	(MSB)	GENERATION CODE						(LSB)
7								
Enclosure descriptor list								
Enclosure descriptor(s) (one per subenclosure)(see table 8 in 6.1.2.2)								
Type descriptor header list								
Type descriptor header(s)(see table 9 in 6.1.2.3)								
Type descriptor text list								
Type descriptor text(s) (one per type descriptor header)(see 6.1.2.4)								
n								

The PAGE CODE field is set to 01h.

The NUMBER OF SUBENCLOSURES field indicates the number of separate subenclosures included in the enclosure descriptor list, not including the primary subenclosure (i.e., a NUMBER OF SUBENCLOSURES field set to zero indicates there is only a primary subenclosure). The primary subenclosure shall be described by the first enclosure descriptor. Additional subenclosures shall be described in subsequent enclosure descriptors, and may be included in any order.

The PAGE LENGTH field contains the length in bytes of the diagnostic parameters that follow.

The GENERATION CODE field is a four-byte counter that shall be incremented by one by the primary enclosure services process every time the enclosure configuration is modified such that the Configuration diagnostic page changes. ~~The counter shall not be changed by status changes for elements already described by the Configuration diagnostic page.~~ Changes in the Configuration diagnostic page may be caused by changes in the number or configuration of subenclosures. Enclosures that do not change in configuration may use a fixed value of zero for the GENERATION CODE field.

Standalone enclosure services processes shall establish a unit attention condition (see SAM-4 and SPC-4) for all I\_T nexuses when there is a change in value of the GENERATION CODE field. The additional sense code for the unit attention condition shall be TARGET OPERATING CONDITIONS HAVE CHANGED. The unit attention condition shall be cleared for all I\_T nexuses without being reported if a RECEIVE DIAGNOSTIC RESULTS command is processed that requests a Configuration diagnostic page (i.e., the PAGE CODE field set to 01h).

Application clients accessing an attached enclosure services process should verify that the value of the GENERATION CODE field has not unexpectedly changed, since no unit attention condition is established by the device server.

Status  
relliott Accepted 12/15/2007 6:01:22 PM -06'00'  
Status  
relliott Confirmed 12/15/2007 6:01:28 PM -06'00'

---

Author: hpq-relliott  
Subject: Highlight  
Date: 12/13/2007 8:24:34 PM -06'00'  
 contains the length in bytes of the diagnostic parameters that follow.  
s/b  
indicates the number of bytes that follow in the diagnostic page.

Status  
relliott Accepted 12/16/2007 6:30:17 PM -06'00'  
Status  
relliott Confirmed 12/16/2007 6:30:21 PM -06'00'

---

Author: relliott  
Subject: Note  
Date: 5/12/2008 3:36:09 PM  
 Move the generation code details into a new section in the subenclosure clause 4.nn. The code operates even while this diagnostic page is not being fetched, so the descriptions need to be in a more generic area. Word it as "generation code" not "GENERATION CODE field" in that location.

Just leave here:  
The generation code field indicates the value of the generation code (see 4.6.2).

Status  
relliott Accepted 1/3/2008 12:34:26 PM -06'00'

---

Author: ibm-gop  
Subject: Highlight  
Date: 1/3/2008 11:04:39 AM -06'00'  
 **6.1.2.1 Configuration diagnostic page overview (3rd paragraph from end)**

**This**  
**<< enclosure configuration is modified such that the Configuration diagnostic page changes. The counter shall not be changed by status changes for elements already described by the Configuration diagnostic page. Changes in the Configuration diagnostic page may be caused by changes in the number or configuration of subenclosures. Enclosures**  
**>> should be**  
**<< enclosure configuration is modified resulting in any Configuration diagnostic page change (e.g., changes in the number or configuration of subenclosures). The counter shall not be changed by status changes for elements already described by the Configuration diagnostic page. Enclosures>>**

Status  
relliott Rejected 1/3/2008 4:50:58 PM -06'00'

---

Author: relliott  
Subject: Note  
Date: 1/3/2008 4:50:59 PM -06'00'  
 Created a new 4.6.2 Generation code model section and moved all the rules to that section. Converted the may into an e.g. as suggested. Kept the phrase "such that".

Author: relliott  
Subject: Cross-Out  
Date: 5/12/2008 3:36:09 PM  
 This is unnecessary, and the other wording seems clear enough:

The counter shall not be changed by status changes for elements already described by the Configuration diagnostic page.

Status  
relliott Accepted 12/20/2007 4:41:14 PM -06'00'

---

Author: hpq-relliott  
Subject: Highlight  
Date: 12/13/2007 8:24:34 PM -06'00'  
 may use a fixed value of zero for the GENERATION CODE field  
s/b  
should set the GENERATION CODE field to zero

Comments from page 20 continued on next page

Table 7 defines the Configuration diagnostic page.

**Table 7 — Configuration diagnostic page**

Byte/Bit	7	6	5	4	3	2	1	0	
Diagnostic page header									
0	PAGE CODE (01h)								
1	NUMBER OF SUBENCLOSURES								
2	(MSB)	PAGE LENGTH (n - 3)							
3							(LSB)		
Generation code									
4	(MSB)	GENERATION CODE							
7							(LSB)		
Enclosure descriptor list									
Enclosure descriptor(s) (one per subenclosure)(see table 8 in 6.1.2.2)									
Type descriptor header list									
Type descriptor header(s)(see table 9 in 6.1.2.3)									
Type descriptor text list									
Type descriptor text(s) (one per type descriptor header)(see 6.1.2.4)									
n									

The PAGE CODE field is set to 01h.

The NUMBER OF SUBENCLOSURES field indicates the number of separate subenclosures included in the enclosure descriptor list, not including the primary subenclosure (i.e., a NUMBER OF SUBENCLOSURES field set to zero indicates there is only a primary subenclosure). The primary subenclosure shall be described by the first enclosure descriptor. Additional subenclosures shall be described in subsequent enclosure descriptors, and may be included in any order.

The PAGE LENGTH field contains the length in bytes of the diagnostic parameters that follow.

The GENERATION CODE field is a four-byte counter that shall be incremented by one by the primary enclosure services process every time the enclosure configuration is modified such that the Configuration diagnostic page changes. The counter shall not be changed by status changes for elements already described by the Configuration diagnostic page. Changes in the Configuration diagnostic page may be caused by changes in the number or configuration of subenclosures. Enclosures that do not change in configuration may use a fixed value of zero for the GENERATION CODE field.

Standalone enclosure services processes shall establish a unit attention condition (see SAM-4 and SPC-4) for all I\_T nexuses when there is a change in value of the GENERATION CODE field. The additional sense code for the unit attention condition shall be TARGET OPERATING CONDITIONS HAVE CHANGED. The unit attention condition shall be cleared for all I\_T nexuses without being reported if a RECEIVE DIAGNOSTIC RESULTS command is processed that requests a Configuration diagnostic page (i.e., the PAGE CODE field set to 01h).

Application clients accessing an attached enclosure services process should verify that the value of the GENERATION CODE field has not unexpectedly changed, since no unit attention condition is established by the device server.

Status  
relliott Accepted 12/13/2007 8:55:06 PM -06'00'  
Status  
relliott Confirmed 12/13/2007 8:55:10 PM -06'00'

---

Author: relliott  
Subject: Note  
Date: 5/12/2008 3:36:09 PM

 Add:  
If the generation code is at its maximum value (i.e., FFFFFFFFh), it shall wrap to zero.

Status  
relliott Accepted 1/3/2008 3:00:06 PM -06'00'

---

Author: relliott  
Subject: Highlight  
Date: 5/12/2008 3:36:09 PM

 Standalone enclosure services processes  
s/b  
... (see 4.1.2)

to match symc comment

Status  
relliott Accepted 12/13/2007 9:07:23 PM -06'00'  
Status  
relliott Confirmed 12/13/2007 9:07:32 PM -06'00'

---

Author: relliott  
Subject: Note  
Date: 5/12/2008 3:36:09 PM

 In the new section, add:  
The generation code is reported in most status-type diagnostic pages. The expected generation code is used in most control-type diagnostic pages.

Status  
relliott Accepted 1/3/2008 3:00:52 PM -06'00'

---

Author: relliott  
Subject: Note  
Date: 5/12/2008 3:36:09 PM

 Add:  
The generation code should be set to 00000000h on power on.

based on email comment from Morrie Gasser, EMC

Status  
relliott Accepted 3/9/2008 10:05:00 AM

---

Author: relliott  
Subject: Highlight  
Date: 5/12/2008 3:36:09 PM

 attached enclosure services process  
s/b  
... (see 4.1.3)

Status  
relliott Accepted 12/13/2007 9:27:16 PM -06'00'  
Status  
relliott Confirmed 12/13/2007 9:27:13 PM -06'00'

---

6.1.2.2 Enclosure descriptor list

Table 8 defines the enclosure descriptor.

Table 8 — Enclosure descriptor

Byte/Bit	7	6	5	4	3	2	1	0
Enclosure descriptor header								
0	Reserved	RELATIVE ENCLOSURE SERVICE PROCESS IDENTIFIER			Reserved	NUMBER OF ENCLOSURE SERVICE PROCESSES		
1	SUBENCLOSURE IDENTIFIER							
2	NUMBER OF ELEMENT TYPE DESCRIPTOR HEADERS							
3	ENCLOSURE DESCRIPTOR LENGTH (m - 3)							
Enclosure descriptor								
4	ENCLOSURE LOGICAL IDENTIFIER							
11								
12	ENCLOSURE VENDOR IDENTIFICATION							
19								
20	PRODUCT IDENTIFICATION							
35								
36	PRODUCT REVISION LEVEL							
39								
40	Vendor-specific enclosure information							
m								

The RELATIVE ENCLOSURE SERVICE PROCESS IDENTIFIER field identifies the enclosure service process relative to other enclosure service processes in the enclosure. A value of 0h is reserved.

The NUMBER OF ENCLOSURE SERVICE PROCESSES field indicates the number of enclosure service processes supported by the enclosure. A value of 0h means the number is not known.

The SUBENCLOSURE IDENTIFIER indicates which subenclosure is being described by this enclosure descriptor. The primary subenclosure shall assign, in a vendor-specific manner, a fixed value for each subenclosure for all SES diagnostic pages associated with a given configuration. The subenclosure identifier assignments may change if the configuration changes.

The NUMBER OF ELEMENT TYPE DESCRIPTOR HEADERS field indicates the number of type descriptor headers in the Configuration diagnostic page with this subenclosure identifier. The total number of type descriptor headers is equal to the sum of the contents of the NUMBER OF ELEMENT TYPE DESCRIPTOR HEADERS fields for the primary subenclosure and all of the subenclosures.

The ENCLOSURE DESCRIPTOR LENGTH field indicates the number of bytes contained in the enclosure descriptor. The value shall be a multiple of four, having allowed values between 36 and 252. The ENCLOSURE DESCRIPTOR LENGTH includes the length of the ENCLOSURE LOGICAL IDENTIFIER field, the ENCLOSURE VENDOR IDENTIFICATION field, the PRODUCT IDENTIFICATION field, the PRODUCT REVISION LEVEL field, and any vendor specific enclosure information.

The ENCLOSURE LOGICAL IDENTIFIER field contains a unique logical identifier for the subenclosure. It shall use an 8-byte NAA identifier, the format of which is defined in SPC-4 vital product data (see SPC-4). The ENCLOSURE LOGICAL IDENTIFIER field shall be unique to the enclosure and may be different from the world wide name of the logical unit providing the enclosure services.

Author: relliott  
Subject: Highlight  
Date: 5/12/2008 3:36:09 PM  
**T** NUMBER OF ENCLOSURE SERVICE  
PROCESSES

add S after SERVICE

Status  
relliott Accepted 12/13/2007 9:19:35 PM -06'00'  
Status  
relliott Confirmed 12/13/2007 9:19:40 PM -06'00'

---

Author: relliott  
Subject: Highlight  
Date: 5/12/2008 3:36:09 PM  
**T** RELATIVE ENCLOSURE SERVICE PROCESS IDENTIFIER

add S after SERVICE

Status  
relliott Accepted 12/13/2007 9:19:23 PM -06'00'  
Status  
relliott Confirmed 12/13/2007 9:19:27 PM -06'00'

---

Author: relliott  
Subject: Highlight  
Date: 5/12/2008 3:36:09 PM  
**T** service process  
s/b  
services process

Status  
relliott Accepted 12/13/2007 9:21:23 PM -06'00'

---

Author: relliott  
Subject: Highlight  
Date: 5/12/2008 3:36:09 PM  
**T** SERVICE PROCESS  
s/b  
SERVICES PROCESS

Status  
relliott Accepted 12/13/2007 9:20:03 PM -06'00'  
Status  
relliott Confirmed 12/13/2007 9:20:06 PM -06'00'

---

Author: ibm-gop  
Subject: Highlight  
Date: 12/13/2007 8:24:47 PM -06'00'  
**T** 6.1.2.2 Enclosure descriptor list (2nd paragraph)

**This << A value of 0h is reserved. >> should be << A value of zero is reserved. >>**

Status  
relliott Rejected 12/13/2007 10:56:37 PM -06'00'

---

Author: relliott  
Subject: Highlight  
Date: 5/12/2008 3:36:09 PM  
**T** enclosure  
s/b  
subenclosure

Morrie Glasser, EMC

Status  
RElliott Accepted 5/12/2008 2:46:22 PM

6.1.2.2 Enclosure descriptor list

Table 8 defines the enclosure descriptor.

Table 8 — Enclosure descriptor

Byte/Bit	7	6	5	4	3	2	1	0
Enclosure descriptor header								
0	Reserved	RELATIVE ENCLOSURE SERVICE PROCESS IDENTIFIER			Reserved	NUMBER OF ENCLOSURE SERVICE PROCESSES		
1	SUBENCLOSURE IDENTIFIER							
2	NUMBER OF ELEMENT TYPE DESCRIPTOR HEADERS							
3	ENCLOSURE DESCRIPTOR LENGTH (m - 3)							
Enclosure descriptor								
4	ENCLOSURE LOGICAL IDENTIFIER							
11								
12	ENCLOSURE VENDOR IDENTIFICATION							
19								
20	PRODUCT IDENTIFICATION							
35								
36	PRODUCT REVISION LEVEL							
39								
40	Vendor-specific enclosure information							
m								

The RELATIVE ENCLOSURE SERVICE PROCESS IDENTIFIER field identifies the enclosure service process relative to other enclosure service processes in the enclosure. A value of 0h is reserved.

The NUMBER OF ENCLOSURE SERVICE PROCESSES field indicates the number of enclosure service processes supported by the enclosure. A value of 0h means the number is not known.

The SUBENCLOSURE IDENTIFIER indicates which subenclosure is being described by this enclosure descriptor. The primary subenclosure shall assign, in a vendor-specific manner, a fixed value for each subenclosure for all SES diagnostic pages associated with a given configuration. The subenclosure identifier assignments may change if the configuration changes.

The NUMBER OF ELEMENT TYPE DESCRIPTOR HEADERS field indicates the number of type descriptor headers in the Configuration diagnostic page with this subenclosure identifier. The total number of type descriptor headers is equal to the sum of the contents of the NUMBER OF ELEMENT TYPE DESCRIPTOR HEADERS fields for the primary subenclosure and all of the subenclosures.

The ENCLOSURE DESCRIPTOR LENGTH field indicates the number of bytes contained in the enclosure descriptor. The value shall be a multiple of four, having allowed values between 36 and 252. The ENCLOSURE DESCRIPTOR LENGTH includes the length of the ENCLOSURE LOGICAL IDENTIFIER field, the ENCLOSURE VENDOR IDENTIFICATION field, the PRODUCT IDENTIFICATION field, the PRODUCT REVISION LEVEL field, and any vendor specific enclosure information.

The ENCLOSURE LOGICAL IDENTIFIER field contains a unique logical identifier for the subenclosure. It shall use an 8-byte NAA identifier, the format of which is defined in SPC-4 vital product data (see SPC-4). The ENCLOSURE LOGICAL IDENTIFIER field shall be unique to the enclosure and may be different from the world wide name of the logical unit providing the enclosure services.



---

Author: relliott  
Subject: Highlight  
Date: 5/12/2008 3:36:09 PM  
 service processes  
s/b  
services processes

Status  
relliott Accepted 12/13/2007 9:21:56 PM -06'00'  
Status  
relliott Confirmed 12/13/2007 9:21:59 PM -06'00'

---

Author: symc-roger  
Subject: Note  
Date: 12/13/2007 8:25:13 PM -06'00'  
 SYMANTEC 25  
PDF pg 39, pg 21, 6.1.2.1 Configuration diagnostic page overview

For the present definitions of the RELATIVE ENCLOSURE SERVICE PROCESS IDENTIFIER and NUMBER OF ENCLOSURE SERVICE PROCESSES fields to make sense, the relationship between "the enclosure" and "this subenclosure" has to be defined. Intuition would say that there's a containment relationship with an enclosure containing 1 or more subenclosures, but that's not stated anywhere, and it's a bit orthogonal to Table 7 which defines one enclosure descriptor per subenclosure. Are the relative process identifier or the number measured across a scope of the entire enclosure or just the subenclosure covered by this enclosure descriptor? The terms are so mashed that its impossible to say.

Proposed Resolution:

The easiest solution might be to remove "enclosure" from Figures 2 and 3 and to make everything in Table 7 and 6.1.2.2 reference subenclosures.

Status  
relliott Rejected 1/3/2008 7:25:38 PM -06'00'

---

Author: relliott  
Subject: Note  
Date: 1/3/2008 7:25:36 PM -06'00'  
 Secondary subenclosure term defined. Subenclosure figure improved in the model. Figure added to model showing multiple enclosure services processes in a subenclosure. Those changes should address these issues.

---

Author: relliott  
Subject: Highlight  
Date: 5/12/2008 3:36:09 PM  
 service processes  
s/b  
services processes

Status  
relliott Accepted 12/13/2007 9:21:41 PM -06'00'  
Status  
relliott Confirmed 12/13/2007 9:21:44 PM -06'00'

---

Author: relliott  
Subject: Highlight  
Date: 5/12/2008 3:36:09 PM  
 SERVICE PROCESSES  
s/b  
SERVICES PROCESSES

Status  
relliott Accepted 12/13/2007 9:20:22 PM -06'00'  
Status  
relliott Confirmed 12/13/2007 9:20:25 PM -06'00'

---

Author: ibm-gop  
Subject: Highlight  
Date: 12/13/2007 8:24:47 PM -06'00'  
 6.1.2.2 Enclosure descriptor list (3rd paragraph)

This << A value of 0h means the number is not known. >> should be << A value of zero indicates the number is not known. >>

Comments from page 21 continued on next page

6.1.2.2 Enclosure descriptor list

Table 8 defines the enclosure descriptor.

Table 8 — Enclosure descriptor

Byte/Bit	7	6	5	4	3	2	1	0
Enclosure descriptor header								
0	Reserved	RELATIVE ENCLOSURE SERVICE PROCESS IDENTIFIER			Reserved	NUMBER OF ENCLOSURE SERVICE PROCESSES		
1	SUBENCLOSURE IDENTIFIER							
2	NUMBER OF ELEMENT TYPE DESCRIPTOR HEADERS							
3	ENCLOSURE DESCRIPTOR LENGTH (m - 3)							
Enclosure descriptor								
4	ENCLOSURE LOGICAL IDENTIFIER							
11								
12	ENCLOSURE VENDOR IDENTIFICATION							
19								
20	PRODUCT IDENTIFICATION							
35								
36	PRODUCT REVISION LEVEL							
39								
40	Vendor-specific enclosure information							
m								

The RELATIVE ENCLOSURE SERVICE PROCESS IDENTIFIER field identifies the enclosure service process relative to other enclosure service processes in the enclosure. A value of 0h is reserved.

The NUMBER OF ENCLOSURE SERVICE PROCESSES field indicates the number of enclosure service processes supported by the enclosure. A value of 0h means the number is not known.

The SUBENCLOSURE IDENTIFIER indicates which subenclosure is being described by this enclosure descriptor. The primary subenclosure shall assign, in a vendor-specific manner, a fixed value for each subenclosure for all SES diagnostic pages associated with a given configuration. The subenclosure identifier assignments may change if the configuration changes.

The NUMBER OF ELEMENT TYPE DESCRIPTOR HEADERS field indicates the number of type descriptor headers in the Configuration diagnostic page with this subenclosure identifier. The total number of type descriptor headers is equal to the sum of the contents of the NUMBER OF ELEMENT TYPE DESCRIPTOR HEADERS fields for the primary subenclosure and all of the subenclosures.

The ENCLOSURE DESCRIPTOR LENGTH field indicates the number of bytes contained in the enclosure descriptor. The value shall be a multiple of four, having allowed values between 36 and 252. The ENCLOSURE DESCRIPTOR LENGTH includes the length of the ENCLOSURE LOGICAL IDENTIFIER field, the ENCLOSURE VENDOR IDENTIFICATION field, the PRODUCT IDENTIFICATION field, the PRODUCT REVISION LEVEL field, and any vendor specific enclosure information.

The ENCLOSURE LOGICAL IDENTIFIER field contains a unique logical identifier for the subenclosure. It shall use an 8-byte NAA identifier, the format of which is defined in SPC-4 vital product data (see SPC-4). The ENCLOSURE LOGICAL IDENTIFIER field shall be unique to the enclosure and may be different from the world wide name of the logical unit providing the enclosure services.

Status  
relliott Accepted 12/17/2007 1:45:48 PM -06'00'  
Status  
relliott Confirmed 12/17/2007 1:45:52 PM -06'00'

---

Author: relliott  
Subject: Highlight  
Date: 5/12/2008 3:36:09 PM  
 enclosure  
s/b  
subenclosure

Morrie Glasser, EMC

Status  
RElliott Accepted 5/12/2008 2:46:33 PM

---

Author: hpq-relliott  
Subject: Highlight  
Date: 12/13/2007 8:24:34 PM -06'00'  
 supported by  
s/b  
in

Status  
relliott Accepted 12/17/2007 1:45:19 PM -06'00'  
Status  
relliott Confirmed 12/17/2007 1:45:24 PM -06'00'

---

Author: relliott  
Subject: Highlight  
Date: 5/12/2008 3:36:09 PM  
 indicates which subenclosure is being described  
s/b  
field indicates the subenclosure described

Status  
relliott Accepted 12/17/2007 1:48:30 PM -06'00'  
Status  
relliott Confirmed 12/17/2007 1:48:26 PM -06'00'

---

Author: symc-roger  
Subject: Note  
Date: 12/13/2007 8:25:13 PM -06'00'  
 SYMANTEC 26  
PDF pg 39, pg 21, 6.1.2.1 Configuration diagnostic page overview

The paragraph defining the SUBENCLOSURE IDENTIFIER duplicates and contradicts other text, and needs to reference the GENERATION CODE field.

Proposed Resolution:

"The SUBENCLOSURE IDENTIFIER is a value assigned by the Primary Subenclosure (see 4.7), and when the value in the GENERATION CODE field changes this value may be reassigned.

Status  
relliott Rejected 12/17/2007 2:20:21 PM -06'00'  
Status  
relliott Confirmed 12/17/2007 2:20:24 PM -06'00'

---

Author: relliott  
Subject: Note  
Date: 12/17/2007 2:20:25 PM -06'00'  
 simplified this paragraph to just the first sentence. Moved all rules about subenclosure identifier assignment into 4.7.

---

Author: relliott  
Subject: Highlight  
Date: 5/12/2008 3:36:09 PM  
 Move these rules into 4.7:

Comments from page 21 continued on next page

6.1.2.2 Enclosure descriptor list

Table 8 defines the enclosure descriptor.

Table 8 — Enclosure descriptor

Byte/Bit	7	6	5	4	3	2	1	0
Enclosure descriptor header								
0	Reserved	RELATIVE ENCLOSURE SERVICE PROCESS IDENTIFIER			Reserved	NUMBER OF ENCLOSURE SERVICE PROCESSES		
1	SUBENCLOSURE IDENTIFIER							
2	NUMBER OF ELEMENT TYPE DESCRIPTOR HEADERS							
3	ENCLOSURE DESCRIPTOR LENGTH (m - 3)							
Enclosure descriptor								
4	ENCLOSURE LOGICAL IDENTIFIER							
11								
12	ENCLOSURE VENDOR IDENTIFICATION							
19								
20	PRODUCT IDENTIFICATION							
35								
36	PRODUCT REVISION LEVEL							
39								
40	Vendor-specific enclosure information							
m								

The RELATIVE ENCLOSURE SERVICE PROCESS IDENTIFIER field identifies the enclosure service process relative to other enclosure service processes in the enclosure. A value of 0h is reserved.

The NUMBER OF ENCLOSURE SERVICE PROCESSES field indicates the number of enclosure service processes supported by the enclosure. A value of 0h means the number is not known.

The SUBENCLOSURE IDENTIFIER indicates which subenclosure is being described by this enclosure descriptor. The primary subenclosure shall assign, in a vendor-specific manner, a fixed value for each subenclosure for all SES diagnostic pages associated with a given configuration. The subenclosure identifier assignments may change if the configuration changes.

The NUMBER OF ELEMENT TYPE DESCRIPTOR HEADERS field indicates the number of type descriptor headers in the Configuration diagnostic page with this subenclosure identifier. The total number of type descriptor headers is equal to the sum of the contents of the NUMBER OF ELEMENT TYPE DESCRIPTOR HEADERS fields for the primary subenclosure and all of the subenclosures.

The ENCLOSURE DESCRIPTOR LENGTH field indicates the number of bytes contained in the enclosure descriptor. The value shall be a multiple of four, having allowed values between 36 and 252. The ENCLOSURE DESCRIPTOR LENGTH includes the length of the ENCLOSURE LOGICAL IDENTIFIER field, the ENCLOSURE VENDOR IDENTIFICATION field, the PRODUCT IDENTIFICATION field, the PRODUCT REVISION LEVEL field, and any vendor specific enclosure information.

The ENCLOSURE LOGICAL IDENTIFIER field contains a unique logical identifier for the subenclosure. It shall use an 8-byte NAA identifier, the format of which is defined in SPC-4 vital product data (see SPC-4). The ENCLOSURE LOGICAL IDENTIFIER field shall be unique to the enclosure and may be different from the world wide name of the logical unit providing the enclosure services.

The primary subenclosure shall assign, in a vendor-specific manner, a fixed value for each subenclosure for all SES diagnostic pages associated with a given configuration. The subenclosure identifier assignments may change if the configuration changes.

Status  
relliott Accepted 12/17/2007 2:19:26 PM -06'00'  
Status  
relliott Confirmed 12/17/2007 2:19:23 PM -06'00'

---

Author: relliott  
Subject: Highlight  
Date: 5/12/2008 3:36:09 PM  
**T** type descriptor headers  
s/b  
type descriptor headers (see 6.1.2.3)

Status  
relliott Accepted 12/17/2007 1:58:14 PM -06'00'  
Status  
relliott Confirmed 12/17/2007 1:58:17 PM -06'00'

---

Author: ibm-gop  
Subject: Highlight  
Date: 12/13/2007 8:24:47 PM -06'00'  
**T** 6.1.2.2 Enclosure descriptor list (5th paragraph)

**This << to the sum of the contents of the NUMBER OF ELEMENT TYPE DESCRIPTOR HEADERS fields >> should be << to the sum of the contents of all the NUMBER OF ELEMENT TYPE DESCRIPTOR HEADERS fields >>**

Status  
relliott Rejected 12/18/2007 9:03:19 PM -06'00'  
Status  
relliott Confirmed 12/18/2007 9:03:15 PM -06'00'

---

Author: relliott  
Subject: Note  
Date: 12/18/2007 9:02:52 PM -06'00'  
 there is only one primary subenclosure, so "all" only applies to the secondary enclosures. Adding the word "secondary"

---

Author: hpq-relliott  
Subject: Highlight  
Date: 12/13/2007 8:24:34 PM -06'00'  
**T** contained  
s/b  
that follow

Status  
relliott Accepted 12/17/2007 3:45:05 PM -06'00'  
Status  
relliott Confirmed 12/17/2007 3:45:02 PM -06'00'

---

Author: relliott  
Subject: Highlight  
Date: 5/12/2008 3:36:09 PM  
**T** enclosure  
s/b  
subenclosure

Morrie Glasser, EMC

Status  
RElliott Accepted 5/12/2008 2:47:08 PM

---

The ENCLOSURE VENDOR IDENTIFICATION field contains the identification string for the vendor of the subenclosure in the same format as specified for the VENDOR IDENTIFICATION field of the standard INQUIRY data (see SPC-4). The ENCLOSURE VENDOR IDENTIFICATION field may contain a different value than the vendor identification of the logical unit providing the enclosure services.

The PRODUCT IDENTIFICATION field contains the product identification string for the subenclosure in the same format as specified for the PRODUCT IDENTIFICATION field of the standard INQUIRY data (see SPC-4). The PRODUCT IDENTIFICATION field may contain a different value than the product identification of the device providing the enclosure services.

The PRODUCT REVISION LEVEL field shall contain the product revision level string for the subenclosure in the same format as specified for the PRODUCT REVISION LEVEL field of the standard INQUIRY data (see SPC-4).

The PRODUCT REVISION LEVEL field may contain a different value than the product revision level of the device providing the enclosure services.

The VENDOR-SPECIFIC ENCLOSURE INFORMATION field is optional.

### 6.1.2.3 Type descriptor header list

The TYPE DESCRIPTOR HEADER field indicates the element type being described, the number of such elements, the subenclosure where the elements are located, and the length of an optional text string (see 3.1.31) describing the element type. The format of the TYPE DESCRIPTOR HEADER field is shown in table 9. The elements of an enclosure shall be listed in the same order in:

- a) the type descriptor header list and type descriptor text list of the Configuration diagnostic page;
- b) the Enclosure Control diagnostic page (see 6.1.3);
- c) the Enclosure Status diagnostic page (see 6.1.4);
- d) the Threshold Out diagnostic page (see 6.1.8); and
- e) the Threshold In diagnostic page (see 6.1.9).

Elements shall be listed in this order, regardless of their subenclosure identifiers:

- 1) Device elements and Array Device elements (i.e., all those elements defining SCSI devices); and
- 2) elements of other types.

Type descriptor headers for elements other than Device elements and Array Device elements may be listed in any order in the Configuration diagnostic page. The type descriptor text list shall be placed after the type descriptor header list (i.e., after all type descriptor headers).

**Table 9 — Type descriptor header format**

Byte\Bit	7	6	5	4	3	2	1	0
0	ELEMENT TYPE							
1	NUMBER OF POSSIBLE ELEMENTS							
2	SUBENCLOSURE IDENTIFIER							
3	TYPE DESCRIPTOR TEXT LENGTH							

The ELEMENT TYPE field in the type descriptor header indicates the element type being described in the header. The list of element types is shown in table 59.

More than one type descriptor header may contain a given ELEMENT TYPE value. As an example, there may be two power supplies that provide +12 volts, and five power supplies that provide +5 volts. In this case, a separate TYPE DESCRIPTOR HEADER may be used for the +12 volt power supplies and for the +5 volt power supplies.

The NUMBER OF POSSIBLE ELEMENTS field in the type descriptor header indicates the number of elements of the indicated type that it is possible to install in the enclosure. The actual number of elements installed may be smaller than the number that the configuration is capable of accepting. The NUMBER OF POSSIBLE ELEMENTS field may be zero, indicating that only the OVERALL CONTROL, OVERALL STATUS, or OVERALL THRESHOLD field is present in the applicable control, status, or threshold page, but that individual ELEMENT CONTROL, ELEMENT

Author: relliott  
Subject: Highlight  
Date: 5/12/2008 3:36:09 PM

**T** device  
s/b  
logical unit

Status  
relliott Accepted 12/15/2007 4:57:41 PM -06'00'

Author: ibm-gop  
Subject: Highlight  
Date: 12/13/2007 8:24:47 PM -06'00'

**T** 6.1.2.2 Enclosure descriptor list (2nd to last paragraph)

This << The PRODUCT REVISION LEVEL field shall contain the product revision level string for the subenclosure in the >> should be << The PRODUCT REVISION LEVEL field contains the product revision level string for the subenclosure in the >>. There are no shalls in any other field so I see no reason for one being in this one.

Status  
relliott Accepted 1/2/2008 7:43:25 PM -06'00'

Author: relliott  
Subject: Highlight  
Date: 5/12/2008 3:36:09 PM

**T** device

Status  
relliott Accepted 12/15/2007 4:57:48 PM -06'00'

Status  
relliott Confirmed 12/15/2007 4:57:51 PM -06'00'

Author: ibm-gop  
Subject: Highlight  
Date: 12/13/2007 8:24:47 PM -06'00'

**T** 6.1.2.2 Enclosure descriptor list (2nd to last paragraph)

This << The VENDOR-SPECIFIC ENCLOSURE INFORMATION field is optional. >> should be << The VENDOR-SPECIFIC ENCLOSURE INFORMATION field may contain vendor specific information. >>

Status  
relliott Rejected 1/3/2008 5:45:05 PM -06'00'

Author: relliott  
Subject: Note  
Date: 1/3/2008 5:45:05 PM -06'00'



with contains rather than may contain

Author: ibm-gop  
Subject: Highlight  
Date: 12/13/2007 8:24:47 PM -06'00'

**T** This << and the length of an optional text string (see 3.1.31) >> should be << and, if implemented, the length of a text string (see 3.1.31) >>

Status  
relliott Rejected 1/3/2008 5:44:04 PM -06'00'

Author: relliott  
Subject: Note  
Date: 1/2/2008 7:45:24 PM -06'00'



paragraph deleted since it just restates what is defined later, not all that succinctly.

Status  
relliott Rejected 1/2/2008 7:45:26 PM -06'00'

Author: ibm-gop  
Subject: Highlight  
Date: 12/13/2007 8:24:47 PM -06'00'

**T** 6.1.2.3 Type descriptor header list (2nd paragraph after table 9)

The ENCLOSURE VENDOR IDENTIFICATION field contains the identification string for the vendor of the subenclosure in the same format as specified for the VENDOR IDENTIFICATION field of the standard INQUIRY data (see SPC-4). The ENCLOSURE VENDOR IDENTIFICATION field may contain a different value than the vendor identification of the logical unit providing the enclosure services.

The PRODUCT IDENTIFICATION field contains the product identification string for the subenclosure in the same format as specified for the PRODUCT IDENTIFICATION field of the standard INQUIRY data (see SPC-4). The PRODUCT IDENTIFICATION field may contain a different value than the product identification of the device providing the enclosure services.

The PRODUCT REVISION LEVEL field shall contain the product revision level string for the subenclosure in the same format as specified for the PRODUCT REVISION LEVEL field of the standard INQUIRY data (see SPC-4). The PRODUCT REVISION LEVEL field may contain a different value than the product revision level of the device providing the enclosure services.

The VENDOR-SPECIFIC ENCLOSURE INFORMATION field is optional.

**6.1.2.3 Type descriptor header list**

The TYPE DESCRIPTOR HEADER field indicates the element type being described, the number of such elements, the subenclosure where the elements are located, and the length of an optional text string (see 3.1.31) describing the element type. The format of the TYPE DESCRIPTOR HEADER field is shown in table 9. The elements of an enclosure shall be listed in the same order in:

- a) the type descriptor header list and type descriptor text list of the Configuration diagnostic page;
- b) the Enclosure Control diagnostic page (see 6.1.3);
- c) the Enclosure Status diagnostic page (see 6.1.4);
- d) the Threshold Out diagnostic page (see 6.1.8); and
- e) the Threshold In diagnostic page (see 6.1.9).

Elements shall be listed in this order, regardless of their subenclosure identifiers:

- 1) Device elements and Array Device elements (i.e., all those elements defining SCSI devices); and
- 2) elements of other types.

Type descriptor headers for elements other than Device elements and Array Device elements may be listed in any order in the Configuration diagnostic page. The type descriptor text list shall be placed after the type descriptor header list (i.e., after all type descriptor headers).

**Table 9 — Type descriptor header format**

Byte\Bit	7	6	5	4	3	2	1	0
0	ELEMENT TYPE							
1	NUMBER OF POSSIBLE ELEMENTS							
2	SUBENCLOSURE IDENTIFIER							
3	TYPE DESCRIPTOR TEXT LENGTH							

The ELEMENT TYPE field in the type descriptor header indicates the element type being described in the header. The list of element types is shown in table 59.

More than one type descriptor header may contain a given ELEMENT TYPE value. As an example, there may be two power supplies that provide +12 volts, and five power supplies that provide +5 volts. In this case, a separate TYPE DESCRIPTOR HEADER may be used for the +12 volt power supplies and for the +5 volt power supplies.

The NUMBER OF POSSIBLE ELEMENTS field in the type descriptor header indicates the number of elements of the indicated type that it is possible to install in the enclosure. The actual number of elements installed may be smaller than the number that the configuration is capable of accepting. The NUMBER OF POSSIBLE ELEMENTS field may be zero, indicating that only the OVERALL CONTROL, OVERALL STATUS, or OVERALL THRESHOLD field is present in the applicable control, status, or threshold page, but that individual ELEMENT CONTROL, ELEMENT



This << given ELEMENT TYPE value. As an example, there may be two power supplies that provide +12 volts, and five power supplies that provide +5 volts. In this case, a separate TYPE DESCRIPTOR HEADER may be used for the +12 volt power supplies and for the +5 volt power supplies. >> should be << given ELEMENT TYPE value (e.g., there may be two power supplies that provide +12 volts, and five power supplies that provide +5 volts. In this case, a separate TYPE DESCRIPTOR HEADER may be used for the +12 volt power supplies and for the +5 volt power supplies). >>

Status  
relliott Accepted 12/20/2007 5:47:47 PM -06'00'

---

Author: relliott  
Subject: Highlight  
Date: 5/12/2008 3:36:09 PM

 enclosure  
s/b  
subenclosure

Morrie Glasser, EMC

Status  
RElliott Accepted 5/12/2008 2:47:48 PM

---

Author: ibm-gop  
Subject: Highlight  
Date: 12/13/2007 8:24:47 PM -06'00'

 6.1.2.3 Type descriptor header list (3rd paragraph after table 9)

This << indicating that only the OVERALL CONTROL, OVERALL STATUS, or OVERALL THRESHOLD field is present in the applicable control, status, or threshold page, but that individual ELEMENT CONTROL, ELEMENT STATUS, or ELEMENT THRESHOLD fields are absent >> should be << indicating that only the OVERALL CONTROL field, OVERALL STATUS field, or OVERALL THRESHOLD field is present in the applicable control, status, or threshold page, but that individual ELEMENT CONTROL field, ELEMENT STATUS field, or ELEMENT THRESHOLD field are absent >>

Status  
relliott Rejected 1/2/2008 7:47:30 PM -06'00'

---

Author: relliott  
Subject: Note  
Date: 12/20/2007 5:54:29 PM -06'00'

 totally rewritten by 08-026

---

STATUS, or ELEMENT THRESHOLD fields are absent (see 6.1.3, 6.1.4, 6.1.8, and 6.1.9). The maximum number of elements referenced by a single type descriptor header shall be 255.

The SUBENCLOSURE IDENTIFIER field in the type descriptor header contains a vendor specific identifier for the enclosure where the elements described by this type descriptor reside. Type descriptors describing elements in a subenclosure shall have the subenclosure identifier value contained in the enclosure descriptor for that subenclosure. ~~For an enclosure services process that is directly accessed by an application client, the SUBENCLOSURE IDENTIFIER field shall be set to 00h. Such an enclosure is defined as a primary subenclosure.~~

The TYPE DESCRIPTOR TEXT LENGTH field in the type descriptor header contains the length in bytes of the type descriptor text string for the corresponding element. Each vendor specific element type shall have a TYPE DESCRIPTOR TEXT LENGTH field that is set to a nonzero value and shall have type descriptor text adequate to identify the element to an application client. Other element types may have a TYPE DESCRIPTOR TEXT LENGTH field set to zero.

#### 6.1.2.4 Type descriptor text list

The type descriptor text is an ~~optional~~ text string (see 3.1.31) from zero to 255 bytes for each type descriptor header. The text string, if it has a length greater than zero, may contain any descriptive information about the element type that may be useful to an application client that is displaying the configuration of the enclosure. The type descriptor texts shall be placed in the same order as the type descriptor headers, except that type descriptor texts of zero length shall be omitted.

Examples of information that may be included in the type descriptor text include the manufacturer's part number for a replacement element, a brief description of the element and its properties, or instructions about configuration limitations and redundancy requirements of the elements of that type.

The type descriptor text uses the character encoding and language specified by the Language element (see 7.3.18).

#### 6.1.3 Enclosure Control diagnostic page

The Enclosure Control diagnostic page provides control information to each of the elements identified by the Configuration diagnostic page. In addition, a separate control field is provided for the collection of elements of the same type as defined by each type descriptor header. The data allows the application client to control many functions within the addressed enclosure.

The Enclosure Control diagnostic page contains an OVERALL CONTROL field for each element type described by a type descriptor header in the Configuration diagnostic page (see 6.1.2), and an ELEMENT CONTROL field for each of the elements of that type that have been allowed for by the NUMBER OF POSSIBLE ELEMENTS field of the Configuration diagnostic page. The list of fields shall be in the order defined by the Configuration diagnostic page. The relationship between the order of the ELEMENT CONTROL fields and the physical location of the element within the enclosure is vendor specific. The relationship may be described by the descriptor fields of the Configuration diagnostic page, by the descriptors in the Element Descriptor diagnostic page (see 6.1.10), or by external references. The relationship shall not change unless the generation code is incremented (see 6.1.2).

~~The Enclosure Control diagnostic page shall be implemented if the device supports enclosure services and does not use the Short Enclosure Status diagnostic page (see 6.1.11).~~ The Enclosure Control diagnostic page is written by the SEND DIAGNOSTIC command. A RECEIVE DIAGNOSTIC RESULTS command with a PCV bit set to one and a PAGE CODE field set to 02h is defined as the request to read the Enclosure Status diagnostic page (see 6.1.4).

● Author: symc-roger  
Subject: Note  
Date: 12/13/2007 8:25:13 PM -06'00'  
 SYMANTEC 27  
PDF pg 41, pg 23, 6.1.2.3 Type Descriptor Header List

The paragraph defining the SUBENCLOSURE IDENTIFIER duplicates and contradicts other text.

Proposed Resolution:

"The SUBENCLOSURE IDENTIFIER is a value assigned by the Primary Subenclosure (see 4.7), and identifies the subenclosure for the enclosure containing the element described by this type descriptor."

Status  
relliott Rejected 12/17/2007 2:06:24 PM -06'00'

Status  
relliott Confirmed 12/17/2007 2:06:28 PM -06'00'

---

Author: relliott

Subject: Note

Date: 12/17/2007 2:06:29 PM -06'00'

 The subenclosure identifier field in the type descriptor header indicates the subenclosure in which the elements described by this type descriptor reside.

---

● Author: relliott  
Subject: Cross-Out  
Date: 5/12/2008 3:36:09 PM

 Delete:

For an enclosure services process that is directly accessed by an application client, the SUBENCLOSURE IDENTIFIER field shall be set to 00h. Such an enclosure is defined as a primary subenclosure.

and add similar definitions into the enclosure descriptor section. This doesn't belong in the type descriptor section.

Status  
relliott Accepted 12/17/2007 2:04:57 PM -06'00'

Status  
relliott Confirmed 12/17/2007 2:05:00 PM -06'00'

---

● Author: ibm-gop  
Subject: Highlight  
Date: 12/13/2007 8:24:47 PM -06'00'

 6.1.2.3 Type descriptor header list (2nd to last 3rd paragraph)

**This << SUBENCLOSURE IDENTIFIER field shall be set to 00h. >> should be << SUBENCLOSURE IDENTIFIER field shall be set to zero. >>**

Status  
relliott Rejected 12/17/2007 2:03:38 PM -06'00'

---

● Author: hpq-relliott  
Subject: Highlight  
Date: 12/13/2007 8:24:34 PM -06'00'

 contains the length in bytes of the type descriptor text string  
s/b  
indicates the number of bytes in the type descriptor text string

Status  
relliott Accepted 1/2/2008 7:48:15 PM -06'00'

---

● Author: relliott  
Subject: Highlight  
Date: 5/12/2008 3:36:09 PM

 Each vendor specific element type shall have a TYPE

STATUS, or ELEMENT THRESHOLD fields are absent (see 6.1.3, 6.1.4, 6.1.8, and 6.1.9). The maximum number of elements referenced by a single type descriptor header shall be 255.

The SUBENCLOSURE IDENTIFIER field in the type descriptor header contains a vendor specific identifier for the enclosure where the elements described by this type descriptor reside. Type descriptors describing elements in a subenclosure shall have the subenclosure identifier value contained in the enclosure descriptor for that subenclosure. ~~For an enclosure services process that is directly accessed by an application client, the SUBENCLOSURE IDENTIFIER field shall be set to 00h. Such an enclosure is defined as a primary subenclosure.~~

The TYPE DESCRIPTOR TEXT LENGTH field in the type descriptor header contains the length in bytes of the type descriptor text string for the corresponding element. Each vendor specific element type shall have a TYPE DESCRIPTOR TEXT LENGTH field that is set to a nonzero value and shall have type descriptor text adequate to identify the element to an application client. Other element types may have a TYPE DESCRIPTOR TEXT LENGTH field set to zero.

#### 6.1.2.4 Type descriptor text list

The type descriptor text is an ~~optional~~ text string (see 3.1.31) from zero to 255 bytes for each type descriptor header. The text string, if it has a length greater than zero, may contain any descriptive information about the element type that may be useful to an application client that is displaying the configuration of the enclosure. The type descriptor texts shall be placed in the same order as the type descriptor headers, except that type descriptor texts of zero length shall be omitted.

Examples of information that may be included in the type descriptor text include the manufacturer's part number for a replacement element, a brief description of the element and its properties, or instructions about configuration limitations and redundancy requirements of the elements of that type.

The type descriptor text uses the character encoding and language specified by the Language element (see 7.3.18).

#### 6.1.3 Enclosure Control diagnostic page

The Enclosure Control diagnostic page provides control information to each of the elements identified by the Configuration diagnostic page. In addition, a separate control field is provided for the collection of elements of the same type as defined by each type descriptor header. The data allows the application client to control many functions within the addressed enclosure.

The Enclosure Control diagnostic page contains an OVERALL CONTROL field for each element type described by a type descriptor header in the Configuration diagnostic page (see 6.1.2), and an ELEMENT CONTROL field for each of the elements of that type that have been allowed for by the NUMBER OF POSSIBLE ELEMENTS field of the Configuration diagnostic page. The list of fields shall be in the order defined by the Configuration diagnostic page. The relationship between the order of the ELEMENT CONTROL fields and the physical location of the element within the enclosure is vendor specific. The relationship may be described by the descriptor fields of the Configuration diagnostic page, by the descriptors in the Element Descriptor diagnostic page (see 6.1.10), or by external references. The relationship shall not change unless the generation code is incremented (see 6.1.2).

~~The Enclosure Control diagnostic page shall be implemented if the device supports enclosure services and does not use the Short Enclosure Status diagnostic page (see 6.1.11).~~ The Enclosure Control diagnostic page is written by the SEND DIAGNOSTIC command. A RECEIVE DIAGNOSTIC RESULTS command with a PCV bit set to one and a PAGE CODE field set to 02h is defined as the request to read the Enclosure Status diagnostic page (see 6.1.4).

DESCRIPTOR TEXT LENGTH field that is set to a nonzero value

s/b

If the element type field is set to a vendor specific value, the type descriptor text length field shall be set to a nonzero value

Status

relliott Accepted 12/20/2007 5:53:26 PM -06'00'

---

Author: relliott

Subject: Highlight

Date: 5/12/2008 3:36:09 PM

**T** zero

s/b

00h

Status

relliott Accepted 12/20/2007 5:52:25 PM -06'00'

---

Author: ibm-gop

Subject: Cross-Out

Date: 12/13/2007 8:24:47 PM -06'00'

**T** 6.1.2.4 Type descriptor text list (1st paragraph)

**This << optional >> should be deleted as everything is optional unless otherwise stated.**

Status

relliott Accepted 12/17/2007 3:33:33 PM -06'00'

Status

relliott Confirmed 12/17/2007 3:33:36 PM -06'00'

---

Author: ibm-gop

Subject: Highlight

Date: 12/13/2007 8:24:47 PM -06'00'

**T** 6.1.2.4 Type descriptor text list

**This << displaying the configuration of the enclosure. The type descriptor texts shall be placed in the same order as the type descriptor headers, except that type descriptor texts of zero length shall be omitted.**

**Examples of information that may be included in the type descriptor text include the manufacturer's part number for a replacement element, a brief description of the element and its properties, or instructions about configuration limitations and redundancy requirements of the elements of that type. >> should be**

**<< displaying the configuration of the enclosure (e.g., the manufacturer's part number for a replacement element, a brief description of the element and its properties, or instructions about configuration limitations and redundancy requirements of the elements of that type). The type descriptor texts shall be placed in the same order as the type descriptor headers, except that type descriptor texts of zero length shall be omitted.**

Status

relliott Accepted 12/20/2007 5:48:00 PM -06'00'

---

Author: hpq-relliott

Subject: Highlight

Date: 12/13/2007 8:24:34 PM -06'00'

**T** specified

s/b

indicated

Status

relliott Accepted 12/13/2007 10:52:20 PM -06'00'

Status

relliott Confirmed 12/13/2007 10:52:23 PM -06'00'

---

Author: relliott

Subject: Cross-Out

Date: 5/12/2008 3:36:09 PM

**T** The Enclosure Control diagnostic page shall be implemented if the device supports enclosure services and does not use the Short Enclosure Status diagnostic page (see 6.1.11).

Status

relliott Accepted 12/17/2007 3:25:55 PM -06'00'

Status

relliott Confirmed 12/17/2007 3:26:02 PM -06'00'

---

Author: relliott

Comments from page 23 continued on next page

STATUS, or ELEMENT THRESHOLD fields are absent (see 6.1.3, 6.1.4, 6.1.8, and 6.1.9). The maximum number of elements referenced by a single type descriptor header shall be 255.

The SUBENCLOSURE IDENTIFIER field in the type descriptor header contains a vendor specific identifier for the enclosure where the elements described by this type descriptor reside. Type descriptors describing elements in a subenclosure shall have the subenclosure identifier value contained in the enclosure descriptor for that subenclosure. ~~For an enclosure services process that is directly accessed by an application client, the SUBENCLOSURE IDENTIFIER field shall be set to 00h. Such an enclosure is defined as a primary subenclosure.~~

The TYPE DESCRIPTOR TEXT LENGTH field in the type descriptor header contains the length in bytes of the type descriptor text string for the corresponding element. Each vendor specific element type shall have a TYPE DESCRIPTOR TEXT LENGTH field that is set to a nonzero value and shall have type descriptor text adequate to identify the element to an application client. Other element types may have a TYPE DESCRIPTOR TEXT LENGTH field set to zero.

#### 6.1.2.4 Type descriptor text list

The type descriptor text is an ~~optional~~ text string (see 3.1.31) from zero to 255 bytes for each type descriptor header. The text string, if it has a length greater than zero, may contain any descriptive information about the element type that may be useful to an application client that is displaying the configuration of the enclosure. The type descriptor texts shall be placed in the same order as the type descriptor headers, except that type descriptor texts of zero length shall be omitted.

Examples of information that may be included in the type descriptor text include the manufacturer's part number for a replacement element, a brief description of the element and its properties, or instructions about configuration limitations and redundancy requirements of the elements of that type.

The type descriptor text uses the character encoding and language specified by the Language element (see 7.3.18).

#### 6.1.3 Enclosure Control diagnostic page

The Enclosure Control diagnostic page provides control information to each of the elements identified by the Configuration diagnostic page. In addition, a separate control field is provided for the collection of elements of the same type as defined by each type descriptor header. The data allows the application client to control many functions within the addressed enclosure.

The Enclosure Control diagnostic page contains an OVERALL CONTROL field for each element type described by a type descriptor header in the Configuration diagnostic page (see 6.1.2), and an ELEMENT CONTROL field for each of the elements of that type that have been allowed for by the NUMBER OF POSSIBLE ELEMENTS field of the Configuration diagnostic page. The list of fields shall be in the order defined by the Configuration diagnostic page. The relationship between the order of the ELEMENT CONTROL fields and the physical location of the element within the enclosure is vendor specific. The relationship may be described by the descriptor fields of the Configuration diagnostic page, by the descriptors in the Element Descriptor diagnostic page (see 6.1.10), or by external references. The relationship shall not change unless the generation code is incremented (see 6.1.2).

~~The Enclosure Control diagnostic page shall be implemented if the device supports enclosure services and does not use the Short Enclosure Status diagnostic page (see 6.1.11).~~ The Enclosure Control diagnostic page is written by the SEND DIAGNOSTIC command. A RECEIVE DIAGNOSTIC RESULTS command with a PCV bit set to one and a PAGE CODE field set to 02h is defined as the request to read the Enclosure Status diagnostic page (see 6.1.4).

Subject: Highlight

Date: 5/12/2008 3:36:09 PM

**T** if the device supports enclosure services and  
does not use the Short Enclosure Status diagnostic page  
s/b

if the enclosure services process does not use the Short Enclosure Status diagnostic page

Status

relliott Accepted 12/15/2007 4:59:20 PM -06'00'

Status

relliott Confirmed 12/15/2007 4:59:23 PM -06'00'

---

Table 10 defines the Enclosure Control diagnostic page.

**Table 10 — Enclosure Control diagnostic page**

Byte\Bit	7	6	5	4	3	2	1	0
0	PAGE CODE (02h)							
1	Reserved			INFO	NON-CRIT	CRIT	UNRECOV	
2	(MSB)	PAGE LENGTH (n - 3)						(LSB)
3								
4	(MSB)	GENERATION CODE						(LSB)
7								
Overall and element control by type list								
8	OVERALL CONTROL (first element type)							
11								
12	ELEMENT CONTROL (first element of first element type)							
15								
...								
(4 bytes)	ELEMENT CONTROL (last element of first element type)							
...								
(4 bytes)	OVERALL CONTROL (last element type)							
(4 bytes)	ELEMENT CONTROL (first element of last element type)							
...								
n - 3	ELEMENT CONTROL (last element of last element type)							
n								

The PAGE CODE field is set to 02h.

The INFO bit, the NON-CRIT bit, the CRIT bit, and the UNRECOV bit are each mandatory and may be set to one in the enclosure by the application client when the application client has detected that one or more of the elements in the enclosure are not operating normally.

An INFO (informational condition) bit set to one specifies that the application client is detecting an informational condition (see 3.1.17). An INFO bit set to zero has no effect.

A NON-CRIT (noncritical condition) bit set to one specifies that the application client is detecting a noncritical condition (see 3.1.21). A NON-CRIT bit set to zero specifies that the application client is not detecting a noncritical condition. If the enclosure services process has independently determined that a noncritical condition is present, a request from the application client to set the NON-CRIT bit to zero shall be ignored by the enclosure services process.

A CRIT (critical condition) bit set to one specifies that the application client is detecting a critical condition (see 3.1.7). A CRIT bit set to zero specifies that the application client is not detecting a critical condition. If the enclosure services process has independently determined that a critical condition is present, a request from the application client to set the CRIT bit to zero shall be ignored by the enclosure services process.

An UNRECOV (unrecoverable condition) bit set to one specifies that the application client is detecting an unrecoverable condition (see 3.1.32). An UNRECOV bit set to zero specifies that the application client is not



This page contains no comments

detecting an unrecoverable condition. If the enclosure services process has independently determined that an unrecoverable condition is present, a request from the application client to set the UNRECOV bit to zero shall be ignored by the enclosure services process.

The PAGE LENGTH field specifies the length in bytes of the diagnostic parameters that follow.



The GENERATION CODE field shall have the value expected to be found in the GENERATION CODE field of the Configuration diagnostic page (see 6.1.2). ~~To prevent the misinterpretation of the OVERALL CONTROL and ELEMENT CONTROL fields,~~ the enclosure services process shall verify that the value of the GENERATION CODE field matches the generation code value known by the enclosure services process. If there is a mismatch, the application client shall be notified of an invalid field error (see 4.5) and the enclosure services process shall ignore the remainder of the Enclosure Control diagnostic page.

The OVERALL CONTROL field for each element type has the same format as the corresponding ELEMENT CONTROL field. There is exactly one OVERALL CONTROL field for each type descriptor header in the Configuration diagnostic page (see table 7). The OVERALL CONTROL field provides control for all elements described in the ELEMENT CONTROL fields. Control values may be applied using either the OVERALL CONTROL field or the ELEMENT CONTROL field.

Following the OVERALL CONTROL field, there shall be one ELEMENT CONTROL field for each of the possible elements identified by the NUMBER OF POSSIBLE ELEMENTS field in the corresponding TYPE DESCRIPTOR HEADER. Each ELEMENT CONTROL field optionally contains control information for the element. Each element type has a standard fixed format for its control field. The general format for an ELEMENT CONTROL field is defined by table 60 of 7.2.1.

The ELEMENT CONTROL fields override the OVERALL CONTROL field as defined in table 11.

**Table 11 — ELEMENT CONTROL and OVERALL CONTROL field processing**

ELEMENT CONTROL field SELECT bit	OVERALL CONTROL field SELECT bit	Description
0	0	The enclosure services process shall not change the element based on this SEND DIAGNOSTIC command
	1	The enclosure services process should change the element based on the OVERALL CONTROL field
1	0 or 1	The enclosure services process should change the element based on the ELEMENT CONTROL field

**6.1.4 Enclosure Status diagnostic page**

The Enclosure Status diagnostic page returns status information for each of the elements identified by the Configuration diagnostic page (see 6.1.2). In addition, an OVERALL STATUS field is provided to collect information about the collection of elements of the same type defined by each TYPE DESCRIPTOR HEADER. The information provides the status about many functions within the addressed enclosure.

The Enclosure Status diagnostic page returns an OVERALL STATUS field for each element type described by a TYPE DESCRIPTOR HEADER in the Configuration diagnostic page and an ELEMENT STATUS field for each of the elements of that type that have been allowed for by the NUMBER OF POSSIBLE ELEMENTS field in the Configuration diagnostic page. The fields shall be in the order defined by the Configuration diagnostic page. The relationship between the order of the ELEMENT STATUS fields and the physical location of the element within the enclosure is vendor specific. The relationship may be described by the descriptor fields of the Configuration diagnostic page, by the descriptors in the Element Descriptor diagnostic page, or by external references. The relationship shall not change unless the GENERATION CODE field is incremented.

~~This page shall be implemented if the device supports enclosure services and does not use the Short Enclosure Status diagnostic page (see 6.1.11).~~ The Enclosure Status diagnostic page is read by the RECEIVE DIAGNOSTIC RESULTS command with a PCV bit set to one and a PAGE CODE field set to 02h. The

Author: relliott  
Subject: Highlight  
Date: 5/12/2008 3:36:09 PM

**T** that follow  
s/b  
that follow in the diagnostic page

Status  
relliott Accepted 12/19/2007 1:53:04 PM -06'00'  
Status  
relliott Confirmed 12/19/2007 1:53:01 PM -06'00'

---

Author: relliott  
Subject: Highlight  
Date: 5/12/2008 3:36:09 PM

**T** length in bytes of the diagnostic parameters that follow.  
s/b  
number of bytes that follow in the diagnostic page.

Status  
relliott Accepted 12/16/2007 6:31:38 PM -06'00'  
Status  
relliott Confirmed 12/16/2007 6:31:42 PM -06'00'

---

Author: relliott  
Subject: Note  
Date: 5/12/2008 3:36:09 PM

 Change GENERATION CODE to EXPECTED GENERATION CODE and change paragraph to:  
The expected generation code field specifies the expected value of the generation code (see 4.6.2). If the expected generation code field contains the current generation code (i.e., the value of the generation code field that would be returned by a Configuration diagnostic page at this time), the enclosure services process shall process the diagnostic page. If the generation code field does not contain the current generation code, the application client shall be notified of an invalid field error (see 4.4) and the enclosure services process shall ignore the remainder of the Enclosure Control diagnostic page.

Status  
relliott Accepted 1/3/2008 2:56:36 PM -06'00'

---

Author: ibm-gop  
Subject: Cross-Out  
Date: 12/13/2007 8:24:47 PM -06'00'

**T** 6.1.3 Enclosure Control diagnostic page (4th paragraph before table 11)

**This << To prevent the misinterpretation of the OVERALL CONTROL and ELEMENT CONTROL fields, >> should be deleted as it contains a justification for the required action. Standards should not justify requirements.**

Status  
relliott Accepted 12/20/2007 8:18:30 PM -06'00'

---

Author: ibm-gop  
Subject: Highlight  
Date: 12/13/2007 8:24:47 PM -06'00'

**T** 6.1.3 Enclosure Control diagnostic page (3rd paragraph before table 11)

**This << There is exactly one OVERALL CONTROL field for each >> should be << There is one OVERALL CONTROL field for each >>. There is no difference between 'exactly one' and 'one'.**

Status  
relliott Accepted 12/21/2007 6:25:01 PM -06'00'

---

Author: ibm-gop  
Subject: Highlight  
Date: 12/13/2007 8:24:47 PM -06'00'

**T** 6.1.3 Enclosure Control diagnostic page (2nd paragraph before table 11)

**This << Each ELEMENT CONTROL field optionally contains control information for >> should be << Each ELEMENT CONTROL field may contain control information for >>**

detecting an unrecoverable condition. If the enclosure services process has independently determined that an unrecoverable condition is present, a request from the application client to set the UNRECOV bit to zero shall be ignored by the enclosure services process.

The PAGE LENGTH field specifies the length in bytes of the diagnostic parameters that follow.



The GENERATION CODE field shall have the value expected to be found in the GENERATION CODE field of the Configuration diagnostic page (see 6.1.2). ~~To prevent the misinterpretation of the OVERALL CONTROL and ELEMENT CONTROL fields,~~ the enclosure services process shall verify that the value of the GENERATION CODE field matches the generation code value known by the enclosure services process. If there is a mismatch, the application client shall be notified of an invalid field error (see 4.5) and the enclosure services process shall ignore the remainder of the Enclosure Control diagnostic page.

The OVERALL CONTROL field for each element type has the same format as the corresponding ELEMENT CONTROL field. There is exactly one OVERALL CONTROL field for each type descriptor header in the Configuration diagnostic page (see table 7). The OVERALL CONTROL field provides control for all elements described in the ELEMENT CONTROL fields. Control values may be applied using either the OVERALL CONTROL field or the ELEMENT CONTROL field.

Following the OVERALL CONTROL field, there shall be one ELEMENT CONTROL field for each of the possible elements identified by the NUMBER OF POSSIBLE ELEMENTS field in the corresponding TYPE DESCRIPTOR HEADER. Each ELEMENT CONTROL field optionally contains control information for the element. Each element type has a standard fixed format for its control field. The general format for an ELEMENT CONTROL field is defined by table 60 of 7.2.1.

The ELEMENT CONTROL fields override the OVERALL CONTROL field as defined in table 11.

**Table 11 — ELEMENT CONTROL and OVERALL CONTROL field processing**

ELEMENT CONTROL field SELECT bit	OVERALL CONTROL field SELECT bit	Description
0	0	The enclosure services process shall not change the element based on this SEND DIAGNOSTIC command
	1	The enclosure services process should change the element based on the OVERALL CONTROL field
1	0 or 1	The enclosure services process should change the element based on the ELEMENT CONTROL field

**6.1.4 Enclosure Status diagnostic page**

The Enclosure Status diagnostic page returns status information for each of the elements identified by the Configuration diagnostic page (see 6.1.2). In addition, an OVERALL STATUS field is provided to collect information about the collection of elements of the same type defined by each TYPE DESCRIPTOR HEADER. The information provides the status about many functions within the addressed enclosure.

The Enclosure Status diagnostic page returns an OVERALL STATUS field for each element type described by a TYPE DESCRIPTOR HEADER in the Configuration diagnostic page and an ELEMENT STATUS field for each of the elements of that type that have been allowed for by the NUMBER OF POSSIBLE ELEMENTS field in the Configuration diagnostic page. The fields shall be in the order defined by the Configuration diagnostic page. The relationship between the order of the ELEMENT STATUS fields and the physical location of the element within the enclosure is vendor specific. The relationship may be described by the descriptor fields of the Configuration diagnostic page, by the descriptors in the Element Descriptor diagnostic page, or by external references. The relationship shall not change unless the GENERATION CODE field is incremented.

~~This page shall be implemented if the device supports enclosure services and does not use the Short Enclosure Status diagnostic page (see 6.1.11).~~ The Enclosure Status diagnostic page is read by the RECEIVE DIAGNOSTIC RESULTS command with a PCV bit set to one and a PAGE CODE field set to 02h. The

Status  
relliott Rejected 12/20/2007 7:53:21 PM -06'00'

---

Author: relliott  
Subject: Note  
Date: 12/20/2007 7:53:19 PM -06'00'  
 just deleted optionally - "contains" alone is enough

---

Author: ibm-gop  
Subject: Highlight  
Date: 12/13/2007 8:24:47 PM -06'00'

**T 6.1.4 Enclosure Status diagnostic page (1st paragraph)**

**This << provides the status about many functions within the addressed enclosure. >> should be << provides the status about functions within the addressed enclosure. >>**

Status  
relliott Rejected 1/3/2008 5:19:16 PM -06'00'

---

Author: relliott  
Subject: Note  
Date: 1/3/2008 5:19:12 PM -06'00'  
 paragraph rewritten and sentence is gone

---

Author: relliott  
Subject: Cross-Out  
Date: 5/12/2008 3:36:09 PM

**T** This page shall be implemented if the device supports enclosure services and does not use the Short Enclosure Status diagnostic page (see 6.1.11).

Status  
relliott Accepted 12/17/2007 3:26:21 PM -06'00'

Status  
relliott Confirmed 12/17/2007 3:26:24 PM -06'00'

---

Author: relliott  
Subject: Highlight  
Date: 5/12/2008 3:36:09 PM

**T** if the device supports enclosure services and does not use the Short Enclosure Status diagnostic page  
s/b  
if the enclosure services process does not use the Short Enclosure Status diagnostic page

Status  
relliott Accepted 12/15/2007 5:00:25 PM -06'00'

Status  
relliott Confirmed 12/15/2007 5:00:29 PM -06'00'

---

transmission of a page using the SEND DIAGNOSTIC command with a page code field set to 02h is defined as the transmission of an Enclosure Control diagnostic page (see 6.1.3).

Table 12 defines the Enclosure Status diagnostic page.

**Table 12 — Enclosure Status diagnostic page**

Byte\Bit	7	6	5	4	3	2	1	0
0	PAGE CODE (02h)							
1	Reserved			INVOP	INFO	NON-CRIT	CRIT	UNRECOV
2	(MSB)	PAGE LENGTH (n - 3)						(LSB)
3								
4	(MSB)	GENERATION CODE						(LSB)
7								
Overall and element status by type list								
8	OVERALL STATUS (first element type)							
11								
12	ELEMENT STATUS (first element of first element type)							
15								
...								
(4 bytes)	ELEMENT STATUS (last element of first element type)							
...								
(4 bytes)	OVERALL STATUS (last element type)							
(4 bytes)	ELEMENT STATUS (first element of last element type)							
...								
n - 3	ELEMENT STATUS (last element of last element type)							
n								

The PAGE CODE field is set to 02h.

The INVOP bit, the INFO bit, the NON-CRIT bit, the CRIT bit, and the UNRECOV bit are each mandatory. The bits may be read with an allocation length greater than 1 and may be examined by an enclosure polling procedure to determine if events have occurred that require reading the complete page. The bits are set independently and may be set in any combination. The bits may be set by either the enclosure services process or with the Enclosure Control diagnostic page.

The INVOP (Invalid operation requested) bit shall be set to one if an invalid field error has occurred (e.g., an Enclosure Control diagnostic page with an invalid format has previously been transmitted to the enclosure services process and an application client has not already been informed of the error) and the SEND DIAGNOSTIC command was not terminated with CHECK CONDITION status to notify the application client of the error.

Each time the INVOP bit is set to one:

- a) standalone enclosure service processes shall set the INVOP bit to one the first time they return the Enclosure Status diagnostic page to the same L\_T nexus that transmitted the invalid control page and shall set the INVOP bit to zero for subsequent requests; and

## Page: 26

---

Author: relliott  
Subject: Highlight  
Date: 5/12/2008 3:36:09 PM

**T** page code field  
s/b  
smallcaps

Status  
relliott Accepted 12/13/2007 9:44:19 PM -06'00'  
Status  
relliott Confirmed 12/13/2007 9:44:22 PM -06'00'

---

Author: ibm-gop  
Subject: Highlight  
Date: 12/13/2007 8:24:47 PM -06'00'

**T** 6.1.4 Enclosure Status diagnostic page (2nd paragraph after table 12)

**This << allocation length greater than 1 and >> should be << allocation length greater than one and >>**

Status  
relliott Accepted 12/13/2007 8:47:45 PM -06'00'  
Status  
relliott Confirmed 12/13/2007 8:47:48 PM -06'00'

---

Author: relliott  
Subject: Highlight  
Date: 5/12/2008 3:36:09 PM

**T** error  
s/b  
invalid field error

to match ibm-gop comment

Status  
relliott Accepted 12/13/2007 8:49:37 PM -06'00'  
Status  
relliott Confirmed 12/13/2007 8:49:41 PM -06'00'

---

Author: ibm-gop  
Subject: Highlight  
Date: 12/13/2007 8:24:47 PM -06'00'

**T** 6.1.4 Enclosure Status diagnostic page (3rd paragraph after table 12)

**This << the application client of the error. >> should be << the application client of the invalid field error. >>**

Status  
relliott Accepted 12/13/2007 8:48:08 PM -06'00'  
Status  
relliott Confirmed 12/13/2007 8:48:12 PM -06'00'

---

Author: ibm-gop  
Subject: Highlight  
Date: 12/13/2007 8:24:47 PM -06'00'

**T** 6.1.4 Enclosure Status diagnostic page (4th paragraph after table 12)

**This << Each time the INVOP bit is set to one: >> should be << Each time the INVOP bit is set to one the: >>**

Status  
relliott Rejected 12/13/2007 10:58:35 PM -06'00'

---

Author: relliott  
Subject: Highlight  
Date: 5/12/2008 3:36:09 PM

**T** standalone enclosure service processes  
s/b  
standalone enclosure services processes (see 4.1.2)

add xref and make plural

Comments from page 26 continued on next page

transmission of a page using the SEND DIAGNOSTIC command with a **page code field** set to 02h is defined as the transmission of an Enclosure Control diagnostic page (see 6.1.3).

Table 12 defines the Enclosure Status diagnostic page.

**Table 12 — Enclosure Status diagnostic page**

Byte\Bit	7	6	5	4	3	2	1	0
0	PAGE CODE (02h)							
1	Reserved			INVOP	INFO	NON-CRIT	CRIT	UNRECOV
2	(MSB)	PAGE LENGTH (n - 3)						(LSB)
3								
4	(MSB)	GENERATION CODE						(LSB)
7								
Overall and element status by type list								
8	OVERALL STATUS (first element type)							
11								
12	ELEMENT STATUS (first element of first element type)							
15								
...								
(4 bytes)	ELEMENT STATUS (last element of first element type)							
...								
(4 bytes)	OVERALL STATUS (last element type)							
(4 bytes)	ELEMENT STATUS (first element of last element type)							
...								
n - 3	ELEMENT STATUS (last element of last element type)							
n								

The PAGE CODE field is set to 02h.

The INVOP bit, the INFO bit, the NON-CRIT bit, the CRIT bit, and the UNRECOV bit are each mandatory. The bits may be read with an **allocation length greater than 1 and** may be examined by an enclosure polling procedure to determine if events have occurred that require reading the complete page. The bits are set independently and may be set in any combination. The bits may be set by either the enclosure services process or with the Enclosure Control diagnostic page.

The INVOP (Invalid operation requested) bit shall be set to one if an invalid field error has occurred (e.g., an Enclosure Control diagnostic page with an invalid format has previously been transmitted to the enclosure services process and an application client has not already been informed of the **error**) and the SEND DIAGNOSTIC command was not terminated with CHECK CONDITION status to notify **the application client of the error.**

**Each time the INVOP bit is set to one:**

- a) **standalone enclosure service processes** shall set the INVOP bit to one the first time they return the Enclosure Status diagnostic page to the same I\_T nexus that transmitted the **invalid control page** and shall set the INVOP bit to zero for subsequent requests; and



to match symc comment

Status  
relliott Accepted 12/13/2007 9:09:20 PM -06'00'

Status  
relliott Confirmed 12/13/2007 9:09:23 PM -06'00'

---

Author: relliott

Subject: Highlight

Date: 5/12/2008 3:36:09 PM

**T** invalid control page

s/b

invalid control-type diagnostic page

Status  
relliott Accepted 1/4/2008 12:07:09 PM -06'00'

---

- b) attached enclosure services processes shall set the INVOP bit to one the first time they return the Enclosure Status diagnostic page to any application client and shall set the INVOP bit to zero for subsequent requests.

An Invalid Operation Reason element may be included in the element list. If the INVOP bit is set to zero and an Invalid Operation Reason element (see 7.3.12) is included, the Invalid Operation Reason element shall be ignored.

An INFO (information) bit set to one indicates that one or more information conditions (see 3.1.17) have been detected by the enclosure services process or specified by an application client with the Enclosure Control diagnostic page. Each time the INFO bit is set to one by any mechanism:

- a) standalone enclosure services processes (see 4.1.2) shall set the INFO bit set to one the first time they return the Enclosure Status diagnostic page to each I\_T nexus and shall set the INFO bit to zero for subsequent requests; and
- b) attached enclosure services processes (see 4.1.3) shall set the INFO bit set to one the first time they return the Enclosure Status diagnostic page to any application client and may set the INFO bit to zero for subsequent requests.

An INFO bit shall be set to one once as an indication to the application client that an information condition is available and not set to one again until a new information condition occurs.

A NON-CRIT (noncritical condition) bit set to one indicates that one or more noncritical conditions (see 3.1.21) have been detected by the enclosure services process or specified by an application client with the Enclosure Control diagnostic page. A NON-CRIT bit set to zero indicates that both the following conditions are met:

- a) all noncritical conditions have been corrected in the enclosure; and
- b) an application client has set the NON-CRIT bit to zero in the Enclosure Control diagnostic page.

A CRIT (critical condition) bit set to one indicates that one or more critical conditions (see 3.1.7) have been detected by the enclosure services process or specified by an application client with the Enclosure Control diagnostic page. A CRIT bit set to zero indicates that both the following conditions are met:

- a) all critical conditions have been corrected in the enclosure; and
- b) an application client has set the CRIT bit to zero in the Enclosure Control diagnostic page.

An UNRECOV (unrecoverable condition) bit set to one indicates that one or more unrecoverable conditions (see 3.1.32) have been detected by the enclosure services process or specified by an application client with the Enclosure Control diagnostic page. An UNRECOV bit set to zero indicates that both the following conditions are met:

- a) all unrecoverable conditions have been corrected in the enclosure; and
- b) an application client has set the UNRECOV bit to zero in the Enclosure Control diagnostic page.

The PAGE LENGTH field indicates the length in bytes of the diagnostic parameters that follow.

The GENERATION CODE field contains the same value as the GENERATION CODE field in the Configuration diagnostic page (see 6.1.2).

The OVERALL STATUS field for each element type has the same format as the corresponding ELEMENT STATUS field. There is exactly one OVERALL STATUS field for each TYPE DESCRIPTOR HEADER in the Configuration diagnostic page. The OVERALL STATUS optionally indicates a summary of the status for all of the elements of that type and may provide status for elements that do not report individual status. The OVERALL STATUS also may be used to indicate the status of those elements whose individual status is not available, but that do have a measurable overall status.

An example of an enclosure that uses the OVERALL STATUS field is an enclosure with three temperature sensors. If the enclosure only reports the average of the three sensors, the OVERALL STATUS field contains the temperature information. If the enclosure reports the output of each sensor separately, the ELEMENT STATUS fields contain the information. Both the OVERALL STATUS field and the ELEMENT STATUS field may contain information.

Zero or more ELEMENT STATUS fields are provided immediately after the OVERALL STATUS field for that element type. The number of ELEMENT STATUS fields shall be equal to the NUMBER OF POSSIBLE ELEMENTS specified by

## Page: 27

---

Author: relliott  
Subject: Highlight  
Date: 5/12/2008 3:36:09 PM  
**T** attached enclosure services processes  
s/b  
... (see 4.1.3)

Status  
relliott Accepted 12/13/2007 9:28:02 PM -06'00'  
Status  
relliott Confirmed 12/13/2007 9:28:05 PM -06'00'

---

Author: relliott  
Subject: Highlight  
Date: 5/12/2008 3:36:09 PM  
**T** may be included in the element list.

sounds like it may be added whenever wanted. Really, it must appear in the Configuration diagnostic page like all the other elements (since the element lists are not self-describing).

expand to:  
may be included in the element list as reported by the Configuration diagnostic page (see 6.1.2)

Status  
relliott Accepted 1/4/2008 12:14:16 PM -06'00'

---

Author: ibm-gop  
Subject: Highlight  
Date: 12/13/2007 8:24:47 PM -06'00'  
**T** 6.1.4 Enclosure Status diagnostic page (paragraph above 2nd a,b list)

**This << bit is set to one by any mechanism: >> should be << bit is set to one by any mechanism the: >>**

Status  
relliott Rejected 12/13/2007 10:58:46 PM -06'00'

---

Author: relliott  
Subject: Highlight  
Date: 5/12/2008 3:36:09 PM  
**T** the length in bytes of the diagnostic parameters that follow.  
s/b  
the number of bytes that follow in the diagnostic page

Status  
relliott Accepted 12/19/2007 1:54:06 PM -06'00'  
Status  
relliott Confirmed 12/19/2007 1:54:03 PM -06'00'

---

Author: relliott  
Subject: Note  
Date: 5/12/2008 3:36:09 PM  
**T** Change generation code paragraph to:  
The generation code field indicates the value of the generation code (see 4.6.2).

Status  
relliott Accepted 1/3/2008 12:35:00 PM -06'00'

---

Author: ibm-gop  
Subject: Highlight  
Date: 12/13/2007 8:24:47 PM -06'00'  
**T** 6.1.4 Enclosure Status diagnostic page (3rd paragraph from end)

**This << There is exactly one OVERALL CONTROL field for each >> should be << There is one OVERALL CONTROL field for each >>. There is no difference between 'exactly one' and 'one'.**

Comments from page 27 continued on next page

- b) attached enclosure services processes shall set the INVOP bit to one the first time they return the Enclosure Status diagnostic page to any application client and shall set the INVOP bit to zero for subsequent requests.

An Invalid Operation Reason element may be included in the element list. If the INVOP bit is set to zero and an Invalid Operation Reason element (see 7.3.12) is included, the Invalid Operation Reason element shall be ignored.

An INFO (information) bit set to one indicates that one or more information conditions (see 3.1.17) have been detected by the enclosure services process or specified by an application client with the Enclosure Control diagnostic page. Each time the INFO bit is set to one by any mechanism:

- a) standalone enclosure services processes (see 4.1.2) shall set the INFO bit set to one the first time they return the Enclosure Status diagnostic page to each I\_T nexus and shall set the INFO bit to zero for subsequent requests; and
- b) attached enclosure services processes (see 4.1.3) shall set the INFO bit set to one the first time they return the Enclosure Status diagnostic page to any application client and may set the INFO bit to zero for subsequent requests.

An INFO bit shall be set to one once as an indication to the application client that an information condition is available and not set to one again until a new information condition occurs.

A NON-CRIT (noncritical condition) bit set to one indicates that one or more noncritical conditions (see 3.1.21) have been detected by the enclosure services process or specified by an application client with the Enclosure Control diagnostic page. A NON-CRIT bit set to zero indicates that both the following conditions are met:

- a) all noncritical conditions have been corrected in the enclosure; and
- b) an application client has set the NON-CRIT bit to zero in the Enclosure Control diagnostic page.

A CRIT (critical condition) bit set to one indicates that one or more critical conditions (see 3.1.7) have been detected by the enclosure services process or specified by an application client with the Enclosure Control diagnostic page. A CRIT bit set to zero indicates that both the following conditions are met:

- a) all critical conditions have been corrected in the enclosure; and
- b) an application client has set the CRIT bit to zero in the Enclosure Control diagnostic page.

An UNRECOV (unrecoverable condition) bit set to one indicates that one or more unrecoverable conditions (see 3.1.32) have been detected by the enclosure services process or specified by an application client with the Enclosure Control diagnostic page. An UNRECOV bit set to zero indicates that both the following conditions are met:

- a) all unrecoverable conditions have been corrected in the enclosure; and
- b) an application client has set the UNRECOV bit to zero in the Enclosure Control diagnostic page.

The PAGE LENGTH field indicates the length in bytes of the diagnostic parameters that follow.

The GENERATION CODE field contains the same value as the GENERATION CODE field in the Configuration diagnostic page (see 6.1.2).

The OVERALL STATUS field for each element type has the same format as the corresponding ELEMENT STATUS field. There is exactly one OVERALL STATUS field for each TYPE DESCRIPTOR HEADER in the Configuration diagnostic page. The OVERALL STATUS optionally indicates a summary of the status for all of the elements of that type and may provide status for elements that do not report individual status. The OVERALL STATUS also may be used to indicate the status of those elements whose individual status is not available, but that do have a measurable overall status.

An example of an enclosure that uses the OVERALL STATUS field is an enclosure with three temperature sensors. If the enclosure only reports the average of the three sensors, the OVERALL STATUS field contains the temperature information. If the enclosure reports the output of each sensor separately, the ELEMENT STATUS fields contain the information. Both the OVERALL STATUS field and the ELEMENT STATUS field may contain information.

Zero or more ELEMENT STATUS fields are provided immediately after the OVERALL STATUS field for that element type. The number of ELEMENT STATUS fields shall be equal to the NUMBER OF POSSIBLE ELEMENTS specified by

Status  
relliott Accepted 12/21/2007 6:23:51 PM -06'00'

---

Author: ibm-gop  
Subject: Highlight  
Date: 12/13/2007 8:24:47 PM -06'00'

**T** 6.1.4 Enclosure Status diagnostic page (3rd paragraph from end)

**This << The OVERALL STATUS optionally indicates a summary >> should be << The OVERALL STATUS may indicate a summary >>**

Status  
relliott Rejected 12/21/2007 6:24:48 PM -06'00'

---

Author: relliott  
Subject: Note  
Date: 12/21/2007 6:24:48 PM -06'00'

 indicates

---

Author: ibm-gop  
Subject: Highlight  
Date: 12/13/2007 8:24:47 PM -06'00'

**T** 6.1.4 Enclosure Status diagnostic page (3rd paragraph from end)

**This << overall status.**

**An example of an enclosure that uses the OVERALL STATUS field is an enclosure with three temperature sensors. If the enclosure only reports the average of the three sensors, the OVERALL STATUS field contains the temperature information. If the enclosure reports the output of each sensor separately, the ELEMENT STATUS fields contain the information. Both the OVERALL STATUS field and the ELEMENT STATUS field may contain information. >> should be << overall status (e.g., an enclosure that uses the OVERALL STATUS field with three temperature sensors. If the enclosure only reports the average of the three sensors, the OVERALL STATUS field contains the temperature information. If the enclosure reports the output of each sensor separately, the ELEMENT STATUS fields contain the information. Both the OVERALL STATUS field and the ELEMENT STATUS field may contain information). >>**

Status  
relliott Accepted 12/21/2007 6:24:19 PM -06'00'

---

the corresponding TYPE DESCRIPTOR HEADER in the Configuration diagnostic page. Each ELEMENT STATUS field optionally indicates the status for the particular element. The general format for an ELEMENT STATUS field is defined by table 61 and by 7.3.

**6.1.5 Help Text diagnostic page**

The Help Text diagnostic page contains a text string (see 3.1.31) from the primary subenclosure that describes the present state of the enclosure and indicates what corrective actions, if any, are desirable to bring the enclosure to its fully operational state. The Help Text diagnostic page is intended to allow the writing of enclosure independent application clients that return enclosure specific text describing the state of the enclosure and explaining enclosure dependent corrective actions that may be required. ~~The page is optional.~~ This page does not support subenclosures; the Subenclosure Help Text diagnostic page (see 6.1.14) does.

The Help Text diagnostic page is read by the RECEIVE DIAGNOSTIC RESULTS command with a PCV bit set to one and a PAGE CODE field set to 03h. If the parameter list for a SEND DIAGNOSTIC command contains a PAGE CODE field set to 03h, the command shall be treated as having an invalid field error (see 4.5).

Table 13 defines the Help Text diagnostic page.

**Table 13 — Help Text diagnostic page**

Byte\Bit	7	6	5	4	3	2	1	0
0	PAGE CODE (03h)							
1	Obsolete							
2	(MSB)	PAGE LENGTH (n - 3)						(LSB)
3								
4								
n	PRIMARY SUBENCLOSURE HELP TEXT							

The PAGE CODE field is set to 03h.

The PAGE LENGTH field indicates the length in bytes of the diagnostic parameters that follow.

The PRIMARY SUBENCLOSURE HELP TEXT field contains a text string (see 3.1.31) describing what corrective actions should be performed on the primary subenclosure to change it from its present state to a fully operational state. The text string shall use the language and character set specified by the Language element (see 7.3.18).

**6.1.6 String Out diagnostic page**

The String Out diagnostic page transmits an enclosure dependent binary string from the application client to the enclosure services process of the primary subenclosure. The binary string may contain bits describing indicator states, text or graphic display information, or control information outside the context of the enclosure elements defined in the Configuration diagnostic page (see 6.1.2).

This page does not support subenclosures; the Subenclosure String Out diagnostic page (see 6.1.15) does.

The format is vendor specific. For standalone enclosure services processes (see 4.1.2), an application client may select the format of the binary string using the manufacturer name and mode from the standard INQUIRY data (see SPC-4) or using the enclosure header information in the Configuration diagnostic page. For attached enclosure services processes (see 4.1.3), an application client should select the format of the binary string using the enclosure header information in the Configuration diagnostic page.

The String Out diagnostic page is written by the SEND DIAGNOSTIC command. A RECEIVE DIAGNOSTIC RESULTS command with a PCV bit set to one and a PAGE CODE field set to 04h is defined as the request to read the String In diagnostic page (see 6.1.7).

Author: ibm-gop  
Subject: Highlight  
Date: 12/13/2007 8:24:47 PM -06'00'

**T 6.1.4 Enclosure Status diagnostic page (last paragraph)**

**This << Each ELEMENT STATUS field optionally indicates >> should be << Each ELEMENT STATUS field may indicate >>**

Status  
relliott Rejected 12/20/2007 7:53:45 PM -06'00'

Author: relliott  
Subject: Note  
Date: 12/20/2007 7:53:42 PM -06'00'  
 just deleted optionally - "indicates" alone is enough

Author: ibm-gop  
Subject: Highlight  
Date: 12/13/2007 8:24:47 PM -06'00'

**T 6.1.5 Help Text diagnostic page (1st paragraph)**

**This << actions, if any, are desirable to bring the enclosure to its fully operational state. >> should be << actions, if any, should occur to bring the enclosure to its operational state. >>**

Status  
relliott Accepted 12/21/2007 6:22:20 PM -06'00'

Author: relliott  
Subject: Note  
Date: 3/19/2008 3:34:50 PM  
 delete the whole phrase, just end with "actions, if any, should be taken."

Author: relliott  
Subject: Highlight  
Date: 5/12/2008 3:36:09 PM

**T** is intended to allow the writing of enclosure independent application clients that return enclosure specific text describing s/b allows enclosure-independent application clients to return enclosure-specific text describing...

to match ibm-gop comment on 6.1.14

Status  
relliott Accepted 12/13/2007 9:36:57 PM -06'00'

Status  
relliott Confirmed 12/13/2007 9:36:54 PM -06'00'

Author: ibm-gop  
Subject: Cross-Out  
Date: 12/13/2007 8:24:47 PM -06'00'

**T 6.1.5 Help Text diagnostic page (1st paragraph)**

**This << The page is optional.>> should be deleted as everything is optional unless otherwise stated.**

Status  
relliott Accepted 12/17/2007 3:26:51 PM -06'00'

Status  
relliott Confirmed 12/17/2007 3:26:59 PM -06'00'

Author: ibm-gop  
Subject: Highlight  
Date: 12/13/2007 8:24:47 PM -06'00'

**T 6.1.5 Help Text diagnostic page (1st paragraph)**

**This << This page does not support subenclosures; the Subenclosure Help Text diagnostic page (see 6.1.14) does. >>**

the corresponding TYPE DESCRIPTOR HEADER in the Configuration diagnostic page. Each ELEMENT STATUS field optionally indicates the status for the particular element. The general format for an ELEMENT STATUS field is defined by table 61 and by 7.3.

**6.1.5 Help Text diagnostic page**

The Help Text diagnostic page contains a text string (see 3.1.31) from the primary subenclosure that describes the present state of the enclosure and indicates what corrective actions, if any, are desirable to bring the enclosure to its fully operational state. The Help Text diagnostic page is intended to allow the writing of enclosure independent application clients that return enclosure specific text describing the state of the enclosure and explaining enclosure dependent corrective actions that may be required. ~~The page is optional.~~ This page does not support subenclosures; the Subenclosure Help Text diagnostic page (see 6.1.14) does.

The Help Text diagnostic page is read by the RECEIVE DIAGNOSTIC RESULTS command with a PCV bit set to one and a PAGE CODE field set to 03h. If the parameter list for a SEND DIAGNOSTIC command contains a PAGE CODE field set to 03h, the command shall be treated as having an invalid field error (see 4.5).

Table 13 defines the Help Text diagnostic page.

**Table 13 — Help Text diagnostic page**

Byte\Bit	7	6	5	4	3	2	1	0	
0	PAGE CODE (03h)								
1	Obsolete								
2	(MSB)	PAGE LENGTH (n - 3)							
3								(LSB)	
4	PRIMARY SUBENCLOSURE HELP TEXT								
n									

The PAGE CODE field is set to 03h.

The PAGE LENGTH field indicates the length in bytes of the diagnostic parameters that follow.

The PRIMARY SUBENCLOSURE HELP TEXT field contains a text string (see 3.1.31) describing what corrective actions should be performed on the primary subenclosure to change it from its present state to a fully operational state. The text string shall use the language and character set specified by the Language element (see 7.3.18).

**6.1.6 String Out diagnostic page**

The String Out diagnostic page transmits an enclosure dependent binary string from the application client to the enclosure services process of the primary subenclosure. The binary string may contain bits describing indicator states, text or graphic display information, or control information outside the context of the enclosure elements defined in the Configuration diagnostic page (see 6.1.2).

This page does not support subenclosures; the Subenclosure String Out diagnostic page (see 6.1.15) does.

The format is vendor specific. For standalone enclosure services processes (see 4.1.2), an application client may select the format of the binary string using the manufacturer name and mode from the standard INQUIRY data (see SPC-4) or using the enclosure header information in the Configuration diagnostic page. For attached enclosure services processes (see 4.1.3), an application client should select the format of the binary string using the enclosure header information in the Configuration diagnostic page.

The String Out diagnostic page is written by the SEND DIAGNOSTIC command. A RECEIVE DIAGNOSTIC RESULTS command with a PCV bit set to one and a PAGE CODE field set to 04h is defined as the request to read the String In diagnostic page (see 6.1.7).



should be << This page does not support subenclosures for subenclosures see the Help Text diagnostic page (see 6.1.14). >>

Status  
relliott Accepted 3/19/2008 1:57:06 PM

---

Author: ibm-gop  
Subject: Highlight  
Date: 12/13/2007 8:24:47 PM -06'00'  
**T** 6.1.5 Help Text diagnostic page (2nd paragraph)

This << command shall be treated as having an invalid field error >> should be << command shall fail with an invalid field error >>

Status  
relliott Accepted 3/19/2008 1:53:56 PM

---

Author: relliott  
Subject: Highlight  
Date: 5/12/2008 3:36:09 PM  
**T** the length in bytes of the diagnostic parameters that follow.  
s/b  
the number of bytes that follow in the diagnostic page

Status  
relliott Accepted 12/19/2007 1:54:34 PM -06'00'  
Status  
relliott Confirmed 12/19/2007 1:54:30 PM -06'00'

---

Author: ibm-gop  
Subject: Cross-Out  
Date: 12/13/2007 8:24:47 PM -06'00'  
**T** 6.1.5 Help Text diagnostic page (last paragraph)

The term << fully >> should be deleted as there is no difference between << fully operation state >> and << operation state >> defined anywhere.

Status  
relliott Accepted 3/19/2008 3:38:26 PM

---

Author: relliott  
Subject: Note  
Date: 1/3/2008 6:59:51 PM -06'00'  
 fully vs. partially operational seem plausible. Leaving in the 4 places used.

---

Author: relliott  
Subject: Highlight  
Date: 5/12/2008 3:36:09 PM  
**T** specified by the Language element  
s/b  
indicated by the Language element

Status  
relliott Accepted 1/4/2008 12:36:28 PM -06'00'

---

Author: relliott  
Subject: Highlight  
Date: 5/12/2008 3:36:09 PM  
**T** enclosure elements  
s/b  
elements

Status  
relliott Accepted 1/4/2008 12:37:02 PM -06'00'

---

Author: ibm-gop  
Subject: Highlight  
Date: 12/13/2007 8:24:47 PM -06'00'  
**T** 6.1.6 String Out diagnostic page (1st paragraph)

This << This page does not support subenclosures; the Subenclosure String Out diagnostic page (see 6.1.15) does. >>

Comments from page 28 continued on next page

the corresponding TYPE DESCRIPTOR HEADER in the Configuration diagnostic page. Each ELEMENT STATUS field optionally indicates the status for the particular element. The general format for an ELEMENT STATUS field is defined by table 61 and by 7.3.

### 6.1.5 Help Text diagnostic page

The Help Text diagnostic page contains a text string (see 3.1.31) from the primary subenclosure that describes the present state of the enclosure and indicates what corrective actions, if any, are desirable to bring the enclosure to its fully operational state. The Help Text diagnostic page is intended to allow the writing of enclosure independent application clients that return enclosure specific text describing the state of the enclosure and explaining enclosure dependent corrective actions that may be required. ~~The page is optional.~~ This page does not support subenclosures; the Subenclosure Help Text diagnostic page (see 6.1.14) does.

The Help Text diagnostic page is read by the RECEIVE DIAGNOSTIC RESULTS command with a PCV bit set to one and a PAGE CODE field set to 03h. If the parameter list for a SEND DIAGNOSTIC command contains a PAGE CODE field set to 03h, the command shall be treated as having an invalid field error (see 4.5).

Table 13 defines the Help Text diagnostic page.

Table 13 — Help Text diagnostic page

Byte\Bit	7	6	5	4	3	2	1	0	
0	PAGE CODE (03h)								
1	Obsolete								
2	(MSB)	PAGE LENGTH (n - 3)							
3								(LSB)	
4	PRIMARY SUBENCLOSURE HELP TEXT								
n									

The PAGE CODE field is set to 03h.

The PAGE LENGTH field indicates the length in bytes of the diagnostic parameters that follow.

The PRIMARY SUBENCLOSURE HELP TEXT field contains a text string (see 3.1.31) describing what corrective actions should be performed on the primary subenclosure to change it from its present state to a fully operational state. The text string shall use the language and character set specified by the Language element (see 7.3.18).

### 6.1.6 String Out diagnostic page

The String Out diagnostic page transmits an enclosure dependent binary string from the application client to the enclosure services process of the primary subenclosure. The binary string may contain bits describing indicator states, text or graphic display information, or control information outside the context of the enclosure elements defined in the Configuration diagnostic page (see 6.1.2).

This page does not support subenclosures; the Subenclosure String Out diagnostic page (see 6.1.15) does.

The format is vendor specific. For standalone enclosure services processes (see 4.1.2), an application client may select the format of the binary string using the manufacturer name and mode from the standard INQUIRY data (see SPC-4) or using the enclosure header information in the Configuration diagnostic page. For attached enclosure services processes (see 4.1.3), an application client should select the format of the binary string using the enclosure header information in the Configuration diagnostic page.

The String Out diagnostic page is written by the SEND DIAGNOSTIC command. A RECEIVE DIAGNOSTIC RESULTS command with a PCV bit set to one and a PAGE CODE field set to 04h is defined as the request to read the String In diagnostic page (see 6.1.7).

should be << This page does not support subenclosures, for subenclosures see the Subenclosure String Out diagnostic page (see 6.1.15). >>

Status  
relliott Accepted 3/19/2008 1:57:19 PM

---

Author: ibm-gop  
Subject: Highlight  
Date: 12/13/2007 8:24:47 PM -06'00'

**T** 6.1.6 String Out diagnostic page (1st paragaph)

This << The format is vendor specific. >> should be << The format of the binary string is vendor specific. >>

Status  
relliott Accepted 12/13/2007 10:25:14 PM -06'00'

Status  
relliott Confirmed 12/13/2007 10:25:17 PM -06'00'

---

Table 14 defines the String Out diagnostic page.

**Table 14 — String Out diagnostic page**

Byte\Bit	7	6	5	4	3	2	1	0	
0	PAGE CODE (04h)								
1	Obsolete								
2	(MSB)	PAGE LENGTH (n - 3)						(LSB)	
3									
4	PRIMARY SUBENCLOSURE STRING OUT DATA								
n									

The PAGE CODE field is set to 04h.

The PAGE LENGTH field specifies the **length in bytes of the diagnostic parameters that follow.**

The PRIMARY SUBENCLOSURE STRING OUT DATA field shall contain the vendor-specific information to be transferred from the application client to the enclosure services process of the primary subenclosure.

### 6.1.7 String In diagnostic page

The String In diagnostic page transmits a subenclosure dependent binary string from the enclosure services process of the primary subenclosure to the application client. The binary string may contain bits describing keyboard states, switch states, or the content of other information provided by the primary subenclosure to the application client.

**This page does not support subenclosures; the Subenclosure String In diagnostic page (see 6.1.16) does.**

The format of the binary string is vendor specific. For standalone enclosure services processes (see 4.1.2), an application client may determine the format of the binary string using the manufacturer name and mode from the standard INQUIRY data (see SPC-4) or using the enclosure header information in the Configuration diagnostic page (see 6.1.2). For attached enclosure services processes (see 4.1.3), an application client should select the format of the binary string using the enclosure header information in the Configuration diagnostic page.

The String In diagnostic page is read by the RECEIVE DIAGNOSTIC RESULTS command with a PCV bit set to one and a PAGE CODE field set to 04h. The transmission of a page using the SEND DIAGNOSTIC command with a PAGE CODE field set to 04h is defined as the transmission of a String Out diagnostic page (see 6.1.6).

Table 15 defines the String In diagnostic page.

**Table 15 — String In diagnostic page**

Byte\Bit	7	6	5	4	3	2	1	0	
0	PAGE CODE (04h)								
1	Obsolete								
2	(MSB)	PAGE LENGTH (n - 3)						(LSB)	
3									
4	PRIMARY SUBENCLOSURE STRING IN DATA								
n									

The PAGE CODE field is set to 04h.

The PAGE LENGTH field indicates **the length in bytes of the diagnostic parameters that follow.**

## Page: 29

---

Author: relliott

Subject: Highlight

Date: 5/12/2008 3:36:09 PM

**T** length in bytes of the diagnostic parameters that follow  
s/b

the number of bytes that follow in the diagnostic page

Status

relliott Accepted 12/19/2007 1:55:08 PM -06'00'

Status

relliott Confirmed 12/19/2007 1:55:05 PM -06'00'

---

Author: ibm-gop

Subject: Highlight

Date: 12/13/2007 8:24:47 PM -06'00'

**T** 6.1.7 String In diagnostic page (2nd paragraph)

**This << This page does not support subenclosures; the Subenclosure String In diagnostic page (see 6.1.16) does. >> should be << This page does not support subenclosures, for subenclosures see the Subenclosure String In diagnostic page (see 6.1.16). >>**

Status

relliott Accepted 3/19/2008 1:57:28 PM

---

Author: relliott

Subject: Highlight

Date: 5/12/2008 3:36:09 PM

**T** the length in bytes of the diagnostic parameters that follow  
s/b

the number of bytes that follow in the diagnostic page

Status

relliott Accepted 12/19/2007 1:55:31 PM -06'00'

Status

relliott Confirmed 12/19/2007 1:55:22 PM -06'00'

---

The PRIMARY SUBENCLOSURE STRING IN DATA field shall contain the vendor specific information to be transferred **from the enclosure services process** to the application client.

**6.1.8 Threshold Out diagnostic page**

The Threshold Out diagnostic page is transmitted to the enclosure services process to establish threshold values for those elements that have limited sensing capability **(e.g., voltage sensors, current sensors, and temperature sensors)**.

The Threshold Out diagnostic page is written by the SEND DIAGNOSTIC command. A RECEIVE DIAGNOSTIC RESULTS command with a PCV bit set to one and a PAGE CODE field set to 05h is defined as the request to read the Threshold In diagnostic page (see 6.1.9).

Table 16 defines the Threshold Out diagnostic page. ~~Implementation of this page is optional.~~

**Table 16 — Threshold Out diagnostic page**

Byte\Bit	7	6	5	4	3	2	1	0
0	PAGE CODE (05h)							
1	Reserved							
2	(MSB)	PAGE LENGTH (n - 3)						(LSB)
3								
4	(MSB)	GENERATION CODE						(LSB)
7								
Overall and element threshold by type list								
8	OVERALL THRESHOLD (first element type)							
11								
12	ELEMENT THRESHOLD (first element of first element type)							
15								
...								
(4 bytes)	ELEMENT THRESHOLD (last element of first element type)							
...								
(4 bytes)	OVERALL THRESHOLD (last element type)							
(4 bytes)	ELEMENT THRESHOLD (first element of last element type)							
...								
n - 3	ELEMENT THRESHOLD (last element of last element type)							
n								

The PAGE CODE field is set to 05h.

The PAGE LENGTH field specifies **the length in bytes of the diagnostic parameters that follow.**



The GENERATION CODE field shall have the value expected to be found in the GENERATION CODE field of the Configuration diagnostic page (see 6.1.2). ~~To prevent the misinterpretation of the OVERALL THRESHOLD and ELEMENT THRESHOLD fields,~~ the enclosure services process shall verify that the value of the GENERATION CODE field matches the generation code value known by the enclosure services process. If there is a mismatch, the

## Page: 30

---

Author: relliott  
Subject: Highlight  
Date: 5/12/2008 3:36:09 PM  
**T** from the enclosure services process  
s/b  
... of the primary subenclosure

Status  
relliott Accepted 1/3/2008 6:51:15 PM -06'00'

---

Author: relliott  
Subject: Highlight  
Date: 5/12/2008 3:36:09 PM  
**T** (e.g., voltage sensors, current sensors, and temperature sensors)  
s/b  
(e.g., temperature sensors, uninterruptable power supplies, voltage sensors, and current sensors)  
  
to list all four of them, in the same order as their element type codes

Status  
relliott Accepted 12/17/2007 3:06:53 PM -06'00'

Status  
relliott Confirmed 12/17/2007 3:06:56 PM -06'00'

---

Author: ibm-gop  
Subject: Cross-Out  
Date: 12/13/2007 8:24:47 PM -06'00'  
**T** 6.1.8 Threshold Out diagnostic page (3rd paragraph)

**This << Implementation of this page is optional.>> should be deleted as everything is optional unless otherwise stated.**

Status  
relliott Accepted 12/17/2007 3:27:50 PM -06'00'

Status  
relliott Confirmed 12/17/2007 3:27:55 PM -06'00'

---

Author: relliott  
Subject: Highlight  
Date: 5/12/2008 3:36:09 PM  
**T** the length in bytes of the diagnostic parameters that follow.  
s/b  
the number of bytes that follow in the diagnostic page

Status  
relliott Accepted 12/19/2007 1:56:20 PM -06'00'

Status  
relliott Confirmed 12/19/2007 1:56:03 PM -06'00'

---

Author: relliott  
Subject: Note  
Date: 5/12/2008 3:36:09 PM  
**T** Change GENERATION CODE to EXPECTED GENERATION CODE and change paragraph to:  
The expected generation code field is defined in the Enclosure Control diagnostic page (see 6.1.3).

Status  
relliott Accepted 1/3/2008 2:57:11 PM -06'00'

---

Author: ibm-gop  
Subject: Cross-Out  
Date: 12/13/2007 8:24:47 PM -06'00'  
**T** 6.1.8 Threshold Out diagnostic page (3rd paragraph after table 16)

**This << To prevent the misinterpretation of the OVERALL THRESHOLD and ELEMENT THRESHOLD fields, >> should be deleted as it contains a justification for the required action. Standards should not justify requirements.**

Comments from page 30 continued on next page

The PRIMARY SUBENCLOSURE STRING IN DATA field shall contain the vendor specific information to be transferred **from the enclosure services process** to the application client.

**6.1.8 Threshold Out diagnostic page**

The Threshold Out diagnostic page is transmitted to the enclosure services process to establish threshold values for those elements that have limited sensing capability **(e.g., voltage sensors, current sensors, and temperature sensors)**.

The Threshold Out diagnostic page is written by the SEND DIAGNOSTIC command. A RECEIVE DIAGNOSTIC RESULTS command with a PCV bit set to one and a PAGE CODE field set to 05h is defined as the request to read the Threshold In diagnostic page (see 6.1.9).

Table 16 defines the Threshold Out diagnostic page. ~~Implementation of this page is optional.~~

**Table 16 — Threshold Out diagnostic page**

Byte\Bit	7	6	5	4	3	2	1	0
0	PAGE CODE (05h)							
1	Reserved							
2	(MSB)	PAGE LENGTH (n - 3)						(LSB)
3								
4	(MSB)	GENERATION CODE						(LSB)
7								
Overall and element threshold by type list								
8	OVERALL THRESHOLD (first element type)							
11								
12	ELEMENT THRESHOLD (first element of first element type)							
15								
...								
(4 bytes)	ELEMENT THRESHOLD (last element of first element type)							
...								
(4 bytes)	OVERALL THRESHOLD (last element type)							
(4 bytes)	ELEMENT THRESHOLD (first element of last element type)							
...								
n - 3	ELEMENT THRESHOLD (last element of last element type)							
n								

The PAGE CODE field is set to 05h.

The PAGE LENGTH field specifies **the length in bytes of the diagnostic parameters that follow.**



The GENERATION CODE field shall have the value expected to be found in the GENERATION CODE field of the Configuration diagnostic page (see 6.1.2). ~~To prevent the misinterpretation of the OVERALL THRESHOLD and ELEMENT THRESHOLD fields,~~ the enclosure services process shall verify that the value of the GENERATION CODE field matches the generation code value known by the enclosure services process. If there is a mismatch, the





application client shall be notified of an invalid field error (see 4.5) and the enclosure services process shall ignore the remainder of the Threshold Out diagnostic page.

The OVERALL THRESHOLD field for each element type has the same format as the corresponding ELEMENT THRESHOLD field. There is exactly one OVERALL THRESHOLD field for each TYPE DESCRIPTOR HEADER in the Configuration diagnostic page (see table 7). The OVERALL THRESHOLD field provides threshold control for all elements described in the ELEMENT THRESHOLD fields. Threshold values may be applied using either the OVERALL THRESHOLD field or the ELEMENT THRESHOLD field. Except as required by the enclosure services process, requests in the ELEMENT THRESHOLD field should override requests in the OVERALL THRESHOLD field.

Following the OVERALL THRESHOLD field, there shall be one ELEMENT THRESHOLD field for each of the possible elements identified by the NUMBER OF POSSIBLE ELEMENTS field in the corresponding TYPE DESCRIPTOR HEADER. The ELEMENT THRESHOLD field shall contain threshold information for the element.

The OVERALL THRESHOLD field and the ELEMENT THRESHOLD field have the format specified in table 17.

**Table 17 — OVERALL THRESHOLD and the ELEMENT THRESHOLD fields for Threshold Out diagnostic page**

Byte\Bit	7	6	5	4	3	2	1	0
0	HIGH CRITICAL THRESHOLD							
1	HIGH WARNING THRESHOLD							
2	LOW WARNING THRESHOLD							
3	LOW CRITICAL THRESHOLD							

The HIGH CRITICAL THRESHOLD field recommends a value for the actual high critical threshold.

The HIGH WARNING THRESHOLD field recommends a value for the actual high warning threshold.

The LOW WARNING THRESHOLD field recommends a value for the actual low warning threshold.

The LOW CRITICAL THRESHOLD field recommends a value for the actual low critical threshold.

All threshold fields are advisory. The enclosure services process shall ignore the contents of the threshold field for those elements that have no value to be compared with a threshold and for those elements that do not implement the threshold function. For those elements that have a sensor value to compare with a threshold, the enclosure services process may accept the fields transmitted in the overall threshold or the element threshold, may set the actual thresholds to a more appropriate value, or may ignore the contents of any or all of the threshold fields. ~~An OVERALL THRESHOLD field or ELEMENT THRESHOLD field with all four thresholds having a value of zero shall be ignored. Any zero value in a field in an OVERALL THRESHOLD field or ELEMENT THRESHOLD field shall be ignored.~~

Table 59 of clause 7 lists those element fields that contain fields subject to thresholds and provides references to the clauses that specify the units and meanings of the thresholds. As an example, voltage sensor elements provide a threshold based on the allowable percentage variation in the sensed voltage. The threshold value is defined in 7.3.20 as a percentage of the nominal voltage in units of 0,5 %. A HIGH CRITICAL THRESHOLD field value of 14 specifies that a critical condition shall be indicated when the voltage is 7 % over the nominal maximum supply voltage, while a LOW WARNING THRESHOLD field value of 10 specifies that a noncritical condition shall be indicated when the voltage is 5 % under the nominal minimum supply voltage.

When the value of a sensed parameter increases above the actual high critical threshold value or falls below the actual low critical threshold value, a critical condition is indicated to the application client by one of the mechanisms defined in 4.6. For those devices that use CHECK CONDITION to indicate enclosure failures (see 4.6.4), the command shall be terminated and the sense key shall be set to HARDWARE ERROR and the additional sense code shall be set to ENCLOSURE FAILURE.

When the value of a sensed parameter increases above the actual high warning threshold value or falls below the actual low warning threshold value, a noncritical condition is indicated to the application client by one of the mechanisms defined in 4.6. For those devices that use CHECK CONDITION to indicate enclosure failures (see 4.6.4), the command shall be completed and the sense key shall be set to RECOVERED ERROR and the additional sense code shall be set to WARNING – ENCLOSURE DEGRADED.

Author: ibm-gop  
Subject: Highlight  
Date: 12/13/2007 8:24:47 PM -06'00'

**T** 6.1.8 Threshold Out diagnostic page (4th paragraph after table 16)

**This << There is exactly one OVERALL THRESHOLD field for each >> should be << There is one OVERALL THRESHOLD field for each >>. There is no difference between 'exactly one' and 'one'.**

Status  
relliott Accepted 12/21/2007 6:20:22 PM -06'00'

---

Author: relliott  
Subject: Note  
Date: 5/12/2008 3:36:09 PM

 Move the threshold control element definition into 7.2.

Add table in each 7.3 that supports a threshold control element defining the four threshold fields.

Move the e.g. about voltage sensor fields representing a percentage into 7.3.20, and copy into 7.3.21 for current sensors.

Status  
relliott Accepted 12/21/2007 3:04:58 PM -06'00'

---

Author: relliott  
Subject: Note  
Date: 5/12/2008 3:36:09 PM

 Change the names of the fields in the threshold control element to start with REQUESTED. This better describes the fields and avoids the field name overlap with the threshold status element (whose fields are the ones actually used). This lets the "actual" term be deleted, allowing acceptance of numerous gop-ibm comments.

Status  
relliott Accepted 12/21/2007 5:17:06 PM -06'00'

---

Author: relliott  
Subject: Highlight  
Date: 5/12/2008 3:36:09 PM

**T** threshold fields  
s/b  
fields in the threshold control element

Status  
relliott Accepted 12/21/2007 5:10:28 PM -06'00'

---

Author: relliott  
Subject: Highlight  
Date: 5/12/2008 3:36:09 PM

**T** threshold field  
s/b  
threshold control element

Status  
relliott Accepted 12/21/2007 5:11:53 PM -06'00'

---

Author: ibm-gop  
Subject: Highlight  
Date: 12/13/2007 8:24:47 PM -06'00'

**T** 6.1.8 Threshold Out diagnostic page (5th paragraph after table 17)

**This should be an a,b,c list <<For those elements that have a sensor value to compare with a threshold, the enclosure services process may accept the fields transmitted in the overall threshold or the element threshold, may set the actual thresholds to a more appropriate value, or may ignore the contents of any or all of the threshold fields >>**

application client shall be notified of an invalid field error (see 4.5) and the enclosure services process shall ignore the remainder of the Threshold Out diagnostic page.

The OVERALL THRESHOLD field for each element type has the same format as the corresponding ELEMENT THRESHOLD field. **There is exactly one OVERALL THRESHOLD field for each** TYPE DESCRIPTOR HEADER in the Configuration diagnostic page (see table 7). The OVERALL THRESHOLD field provides threshold control for all elements described in the ELEMENT THRESHOLD fields. Threshold values may be applied using either the OVERALL THRESHOLD field or the ELEMENT THRESHOLD field. Except as required by the enclosure services process, requests in the ELEMENT THRESHOLD field should override requests in the OVERALL THRESHOLD field.

Following the OVERALL THRESHOLD field, there shall be one ELEMENT THRESHOLD field for each of the possible elements identified by the NUMBER OF POSSIBLE ELEMENTS field in the corresponding TYPE DESCRIPTOR HEADER. The ELEMENT THRESHOLD field shall contain threshold information for the element.

The OVERALL THRESHOLD field and the ELEMENT THRESHOLD field have the format specified in table 17.

**Table 17 — OVERALL THRESHOLD and the ELEMENT THRESHOLD fields for Threshold Out diagnostic page**

Byte\Bit	7	6	5	4	3	2	1	0
0	HIGH CRITICAL THRESHOLD							
1	HIGH WARNING THRESHOLD							
2	LOW WARNING THRESHOLD							
3	LOW CRITICAL THRESHOLD							

The HIGH CRITICAL THRESHOLD field recommends a value for the actual high critical threshold.

The HIGH WARNING THRESHOLD field recommends a value for the actual high warning threshold.

The LOW WARNING THRESHOLD field recommends a value for the actual low warning threshold.

The LOW CRITICAL THRESHOLD field recommends a value for the actual low critical threshold.

All **threshold fields** are advisory. The enclosure services process shall ignore the contents of the **threshold field** for those elements that have no value to be compared with a threshold and for those elements that do not implement the threshold function. **For those elements that have a sensor value to compare with a threshold, the enclosure services process may accept the fields transmitted in the overall threshold or the element threshold, may set the actual thresholds to a more appropriate value, or may ignore the contents of any or all of the threshold fields.** ~~An OVERALL THRESHOLD field or ELEMENT THRESHOLD field with all four thresholds having a value of zero shall be ignored. Any zero value in a field in an OVERALL THRESHOLD field or ELEMENT THRESHOLD field shall be ignored.~~

**Table 59 of clause 7 lists those element fields that contain fields subject to thresholds and provides references to the clauses that specify the units and meanings of the thresholds. As an example, voltage sensor elements provide a threshold based on the allowable percentage variation in the sensed voltage. The threshold value is defined in 7.3.20 as a percentage of the nominal voltage in units of 0,5 %. A HIGH CRITICAL THRESHOLD field value of 14 specifies that a critical condition shall be indicated when the voltage is 7 % over the nominal maximum supply voltage, while a LOW WARNING THRESHOLD field value of 10 specifies that a noncritical condition shall be indicated when the voltage is 5 % under the nominal minimum supply voltage.**

When the value of a sensed parameter increases above the actual high critical threshold value or falls below the actual low critical threshold value, a critical condition is indicated to the application client by one of the mechanisms defined in 4.6. For those **devices that use CHECK CONDITION** to indicate enclosure failures (see 4.6.4), the command shall be terminated and the sense key shall be set to HARDWARE ERROR and the additional sense code shall be set to ENCLOSURE FAILURE.

When the value of a sensed parameter increases above the actual high warning threshold value or falls below the actual low warning threshold value, a noncritical condition is indicated to the application client by one of the mechanisms defined in 4.6. For those **devices that use CHECK CONDITION** to indicate enclosure failures (see 4.6.4), the command shall be completed and the sense key shall be set to RECOVERED ERROR and the additional sense code shall be set to WARNING – ENCLOSURE DEGRADED.

Status  
relliott Accepted 12/20/2007 8:15:57 PM -06'00'

---

Author: relliott  
Subject: Cross-Out  
Date: 5/12/2008 3:36:09 PM  
**T** An OVERALL THRESHOLD field or ELEMENT THRESHOLD field with all four thresholds having a value of zero shall be ignored. Any zero value in a field in an OVERALL THRESHOLD field or ELEMENT THRESHOLD field shall be ignored.

Later definition of the Uninterruptable Power Supplier fields say 00h means vendor-specific, not ignored. Delete this statement.

Status  
relliott Accepted 12/21/2007 5:15:03 PM -06'00'

---

Author: relliott  
Subject: Highlight  
Date: 5/12/2008 3:36:09 PM  
**T** Table 59 of clause 7 lists  
s/b  
Table 59 (see 7.1)

Status  
relliott Accepted 12/13/2007 9:39:28 PM -06'00'

Status  
relliott Confirmed 12/13/2007 9:39:32 PM -06'00'

---

Author: ibm-gop  
Subject: Highlight  
Date: 12/13/2007 8:24:47 PM -06'00'  
**T** 6.1.8 Threshold Out diagnostic page (6th paragraph after table 17)

**This << clauses that specify the >> should be << subclauses that specify the >>**

Status  
relliott Accepted 12/13/2007 9:39:09 PM -06'00'

Status  
relliott Confirmed 12/13/2007 9:39:12 PM -06'00'

---

Author: ibm-gop  
Subject: Highlight  
Date: 12/13/2007 8:24:47 PM -06'00'  
**T** 6.1.8 Threshold Out diagnostic page (6th paragraph after table 17)

**This << of the thresholds. As an example, voltage sensor elements provide a threshold based on the allowable percentage variation in the sensed voltage. The threshold value is defined in 7.3.20 as a percentage of the nominal voltage in units of 0,5 %. A HIGH CRITICAL THRESHOLD field value of 14 specifies that a critical condition shall be indicated when the voltage is 7 % over the nominal maximum supply voltage, while a LOW WARNING THRESHOLD field value of 10 specifies that a noncritical condition shall be indicated when the voltage is 5 % under the nominal minimum supply voltage. >> should be**

**<< of the thresholds (e.g., voltage sensor elements provide a threshold based on the allowable percentage variation in the sensed voltage. The threshold value is defined in 7.3.20 as a percentage of the nominal voltage in units of 0,5 %. A HIGH CRITICAL THRESHOLD field value of 14 specifies that a critical condition shall be indicated when the voltage is 7 % over the nominal maximum supply voltage, while a LOW WARNING THRESHOLD field value of 10 specifies that a noncritical condition shall be indicated when the voltage is 5 % under the nominal minimum supply voltage). >>**

Status  
relliott Accepted 12/20/2007 8:15:46 PM -06'00'

---

Author: relliott  
Subject: Note  
Date: 5/12/2008 3:36:09 PM  
**M** Move the two paragraphs about how the enclosure services process uses thresholds (e.g. generating CHECK CONDITION) into a new 4.xx model section, since they don't belong in the diagnostic page field descriptions or in the element section.

Introduce the section with this text:

For elements that have limited sensing capability (e.g., temperature sensors, uninterruptable power supplies, voltage sensors, and current sensors), an enclosure services process may support reporting when the element crosses certain threshold values: a high critical threshold;

Comments from page 31 continued on next page

application client shall be notified of an invalid field error (see 4.5) and the enclosure services process shall ignore the remainder of the Threshold Out diagnostic page.

The OVERALL THRESHOLD field for each element type has the same format as the corresponding ELEMENT THRESHOLD field. **There is exactly one OVERALL THRESHOLD field for each** TYPE DESCRIPTOR HEADER in the Configuration diagnostic page (see table 7). The OVERALL THRESHOLD field provides threshold control for all elements described in the ELEMENT THRESHOLD fields. Threshold values may be applied using either the OVERALL THRESHOLD field or the ELEMENT THRESHOLD field. Except as required by the enclosure services process, requests in the ELEMENT THRESHOLD field should override requests in the OVERALL THRESHOLD field.

Following the OVERALL THRESHOLD field, there shall be one ELEMENT THRESHOLD field for each of the possible elements identified by the NUMBER OF POSSIBLE ELEMENTS field in the corresponding TYPE DESCRIPTOR HEADER. The ELEMENT THRESHOLD field shall contain threshold information for the element.

The OVERALL THRESHOLD field and the ELEMENT THRESHOLD field have the format specified in table 17.

**Table 17 — OVERALL THRESHOLD and the ELEMENT THRESHOLD fields for Threshold Out diagnostic page**

Byte\Bit	7	6	5	4	3	2	1	0
0	HIGH CRITICAL THRESHOLD							
1	HIGH WARNING THRESHOLD							
2	LOW WARNING THRESHOLD							
3	LOW CRITICAL THRESHOLD							

The HIGH CRITICAL THRESHOLD field recommends a value for the actual high critical threshold.

The HIGH WARNING THRESHOLD field recommends a value for the actual high warning threshold.

The LOW WARNING THRESHOLD field recommends a value for the actual low warning threshold.

The LOW CRITICAL THRESHOLD field recommends a value for the actual low critical threshold.

All **threshold fields** are advisory. The enclosure services process shall ignore the contents of the **threshold field** for those elements that have no value to be compared with a threshold and for those elements that do not implement the threshold function. **For those elements that have a sensor value to compare with a threshold, the enclosure services process may accept the fields transmitted in the overall threshold or the element threshold, may set the actual thresholds to a more appropriate value, or may ignore the contents of any or all of the threshold fields.** ~~An OVERALL THRESHOLD field or ELEMENT THRESHOLD field with all four thresholds having a value of zero shall be ignored. Any zero value in a field in an OVERALL THRESHOLD field or ELEMENT THRESHOLD field shall be ignored.~~

Table 59 of clause 7 lists those element fields that contain fields subject to thresholds and provides references to the clauses that specify the units and meanings of the thresholds. As an example, voltage sensor elements provide a threshold based on the allowable percentage variation in the sensed voltage. The threshold value is defined in 7.3.20 as a percentage of the nominal voltage in units of 0,5 %. A HIGH CRITICAL THRESHOLD field value of 14 specifies that a critical condition shall be indicated when the voltage is 7 % over the nominal maximum supply voltage, while a LOW WARNING THRESHOLD field value of 10 specifies that a noncritical condition shall be indicated when the voltage is 5 % under the nominal minimum supply voltage.

When the value of a sensed parameter increases above the actual high critical threshold value or falls below the actual low critical threshold value, a critical condition is indicated to the application client by one of the mechanisms defined in 4.6. For those **devices that use CHECK CONDITION** to indicate enclosure failures (see 4.6.4), the command shall be terminated and the sense key shall be set to HARDWARE ERROR and the additional sense code shall be set to ENCLOSURE FAILURE.

When the value of a sensed parameter increases above the actual high warning threshold value or falls below the actual low warning threshold value, a noncritical condition is indicated to the application client by one of the mechanisms defined in 4.6. For those **devices that use CHECK CONDITION** to indicate enclosure failures (see 4.6.4), the command shall be completed and the sense key shall be set to RECOVERED ERROR and the additional sense code shall be set to WARNING – ENCLOSURE DEGRADED.

a high warning threshold;  
a low warning threshold; and  
a low critical threshold.

Thresholds are supported using the Threshold Out diagnostic page (see 6.1.8), the Threshold In diagnostic page (see 6.1.9), the threshold control element (see 7.2.4), and the threshold status element (see 7.2.4).

Point to it from the threshold control and threshold status sections.

Status  
relliott Accepted 1/3/2008 7:56:41 PM -06'00'

---

Author: relliott  
Subject: Highlight  
Date: 5/12/2008 3:36:09 PM  
**T** devices that use CHECK CONDITION  
s/b  
device servers that use CHECK CONDITION status

Status  
relliott Accepted 12/15/2007 5:02:07 PM -06'00'

Status  
relliott Confirmed 12/15/2007 5:02:10 PM -06'00'

---

Author: relliott  
Subject: Highlight  
Date: 5/12/2008 3:36:09 PM  
**T** devices that use CHECK CONDITION  
s/b  
device servers that use CHECK CONDITION status

Status  
relliott Accepted 12/15/2007 5:02:27 PM -06'00'

Status  
relliott Confirmed 12/15/2007 5:02:30 PM -06'00'

---

**6.1.9 Threshold In diagnostic page**

The Threshold In diagnostic page is transmitted from the enclosure services process to the application client to report the actual threshold values for those elements that have limited sensing capability, for example voltage sensors, current sensors, and temperature sensors.

The Threshold In diagnostic page is read by the RECEIVE DIAGNOSTIC RESULTS command with a PCV bit set to one and a PAGE CODE field set to 05h. The transmission of a page using the SEND DIAGNOSTIC command with a PAGE CODE field set to 05h is defined as the transmission of a Threshold Out diagnostic page (see 6.1.8).

Table 18 defines the Threshold In diagnostic page. ~~Implementation of this page is optional.~~

**Table 18 — Threshold In diagnostic page**

Byte\Bit	7	6	5	4	3	2	1	0
0	PAGE CODE (05h)							
1	Reserved			INVOP	Reserved			
2	(MSB)	PAGE LENGTH (n - 3)						(LSB)
3								
4	(MSB)	GENERATION CODE						(LSB)
7								
Overall and element threshold by type list								
8	OVERALL THRESHOLD (first element type)							
11								
12	ELEMENT THRESHOLD (first element of first element type)							
15								
...								
(4 bytes)	ELEMENT THRESHOLD (last element of first element type)							
...								
(4 bytes)	OVERALL THRESHOLD (last element type)							
(4 bytes)	ELEMENT THRESHOLD (first element of last element type)							
...								
n - 3	ELEMENT THRESHOLD (last element of last element type)							
n								

The PAGE CODE field is set to 05h.

The INVOP (invalid operation requested) bit shall be set to one if a Threshold Out diagnostic page with an invalid format has previously been transmitted to the enclosure services process and an application client has not already been informed of the error if the SEND DIAGNOSTIC command sending the invalid Threshold Out diagnostic page was not terminated with CHECK CONDITION status to notify the application client of the error.



Author: ibm-gop  
Subject: Highlight  
Date: 12/13/2007 8:24:47 PM -06'00'

## **T** 6.1.9 Threshold In diagnostic page

**This << limited sensing capability, for example voltage sensors, current sensors, and temperature sensors. >> should be << limited sensing capability, (e.g., voltage sensors, current sensors, and temperature sensors). >>**

Status  
RElliott Accepted 5/12/2008 3:58:41 PM  
relliott Accepted 12/13/2007 10:59:57 PM -06'00'

Status  
relliott Confirmed 12/13/2007 11:00:01 PM -06'00'

---

Author: relliott  
Subject: Note  
Date: 12/17/2007 3:09:33 PM -06'00'



(e.g., temperature sensors, uninterruptable power supplies, voltage sensors, and current sensors)

to list all four of them, in the same order as their element type codes. Same change made to 6.1.8

---

Author: ibm-gop  
Subject: Cross-Out  
Date: 12/13/2007 8:24:47 PM -06'00'

## **T** 6.1.9 Threshold In diagnostic page (3rd paragraph)

**This << Implementation of this page is optional.>> should be deleted as everything is optional unless otherwise stated.**

Status  
RElliott Accepted 5/12/2008 3:59:25 PM  
relliott Accepted 12/17/2007 3:28:17 PM -06'00'

Status  
relliott Confirmed 12/17/2007 3:28:20 PM -06'00'

---

Author: relliott  
Subject: Highlight  
Date: 5/12/2008 3:36:09 PM

**T** and an application client has not already been informed of the error if the SEND DIAGNOSTIC command sending the invalid Threshold Out diagnostic page was not terminated with CHECK CONDITION status to notify the application client of the error.

needs an i.e. inserted

and an application client has not already been informed of the error (i.e., if the SEND DIAGNOSTIC command sending the invalid Threshold Out diagnostic page was not terminated with CHECK CONDITION status to notify the application client of the error).

Status  
RElliott Accepted 5/12/2008 3:53:30 PM  
relliott Accepted 1/4/2008 12:10:53 PM -06'00'

---

Each time the INVOP bit is set to one:

- a) standalone enclosure service processes shall set the INVOP bit to one the first time they return the Threshold In diagnostic page to the same I\_T nexus that transmitted the invalid control page and shall set the INVOP bit to zero for subsequent requests; and
- b) attached enclosure services processes shall set the INVOP bit to one the first time they return the Threshold In diagnostic page to any application client and shall set the INVOP bit to zero for subsequent requests.

An Invalid Operation Reason element may be included in the element list. If the INVOP bit is set to zero and an Invalid Operation Reason element (see 7.3.12) is included, the Invalid Operation Reason element shall be ignored.

The PAGE LENGTH field indicates the length in bytes of the diagnostic parameters that follow.

The GENERATION CODE contains the same value as the GENERATION CODE field in the Configuration diagnostic page (see 6.1.2).

The OVERALL THRESHOLD field for each element type has the same format as the corresponding ELEMENT THRESHOLD field. There is exactly one OVERALL THRESHOLD field for each TYPE DESCRIPTOR HEADER in the Configuration diagnostic page (see table 7). The OVERALL THRESHOLD optionally contains a summary of the threshold values for all of the elements of that type. The OVERALL THRESHOLD also may be used to contain the threshold values for those elements whose individual threshold values are not available, but that do have threshold values.

Following the OVERALL THRESHOLD field, there shall be one ELEMENT THRESHOLD field for each of the possible elements identified by the NUMBER OF POSSIBLE ELEMENTS field in the corresponding TYPE DESCRIPTOR HEADER. Each ELEMENT THRESHOLD field optionally contains the actual threshold information for the element.

The OVERALL THRESHOLD field and the ELEMENT THRESHOLD field have the format specified in table 19.

**Table 19 — OVERALL THRESHOLD and ELEMENT THRESHOLD fields for Threshold In diagnostic page**

Byte/Bit	7	6	5	4	3	2	1	0
0	HIGH CRITICAL THRESHOLD							
1	HIGH WARNING THRESHOLD							
2	LOW WARNING THRESHOLD							
3	LOW CRITICAL THRESHOLD							

The HIGH CRITICAL THRESHOLD field indicates the value at which the enclosure indicates a critical condition if a higher value is detected by the sensor element. A value of zero indicates that the sensor element does not test a high critical threshold.

The HIGH WARNING THRESHOLD field indicates the value at which the enclosure indicates a noncritical condition if the sensor element detects a value higher than the specified threshold value. A value of zero indicates that the sensor element does not test a high warning threshold.

The LOW WARNING THRESHOLD field indicates the value at which the enclosure indicates a noncritical condition if the sensor element detects a value lower than the specified threshold value. A value of zero indicates that the sensor element does not test a low warning threshold.

The LOW CRITICAL THRESHOLD field indicates the value at which the enclosure indicates a critical condition if the sensor element detects a value lower than the specified threshold value. A value of zero indicates that the sensor element does not test a low critical threshold.

The threshold values represent the values that the enclosure is using at the time the Threshold In diagnostic page is returned.

Each 8-bit threshold value shall have the definition specified by the text describing the corresponding element field. As an example, voltage sensor elements measure voltage in units of 10 millivolts. The threshold value is defined by 7.3.20 as a percentage of the nominal voltage in units of 0,5 %. A HIGH CRITICAL THRESHOLD field

## Page: 33

---

Author: relliott  
Subject: Highlight  
Date: 5/12/2008 3:36:09 PM  
**T** standalone enclosure service processes  
s/b  
... services ... (see 4.1.2)

to match symc comment

Status  
relliott Accepted 12/13/2007 9:10:23 PM -06'00'  
Status  
relliott Confirmed 12/13/2007 9:10:27 PM -06'00'

---

Author: relliott  
Subject: Highlight  
Date: 5/12/2008 3:36:09 PM  
**T** attached enclosure services processes  
s/b  
... (see 4.1.3)

Status  
relliott Accepted 12/13/2007 9:29:16 PM -06'00'  
Status  
relliott Confirmed 12/13/2007 9:29:19 PM -06'00'

---

Author: relliott  
Subject: Highlight  
Date: 5/12/2008 3:36:09 PM  
**T** may be included in the element list.

sounds like it may be added whenever wanted. Really, it must appear in the Configuration diagnostic page like all the other elements (since the element lists are not self-describing).

expand to:  
may be included in the element list as reported by the Configuration diagnostic page (see 6.1.2)

Status  
relliott Accepted 1/4/2008 12:14:30 PM -06'00'

---

Author: relliott  
Subject: Highlight  
Date: 5/12/2008 3:36:09 PM  
**T** the length in bytes of the diagnostic parameters that follow  
s/b  
the number of bytes that follow in the diagnostic page

Status  
relliott Accepted 12/19/2007 1:56:38 PM -06'00'  
Status  
relliott Confirmed 12/19/2007 1:56:34 PM -06'00'

---

Author: relliott  
Subject: Highlight  
Date: 5/12/2008 3:36:09 PM  
**T** GENERATION CODE contains  
s/b  
GENERATION CODE field contains

Status  
relliott Accepted 1/3/2008 11:52:06 AM -06'00'

---

Author: relliott  
Subject: Note

Comments from page 33 continued on next page

Each time the INVOP bit is set to one:

- a) **standalone enclosure service processes** shall set the INVOP bit to one the first time they return the Threshold In diagnostic page to the same I\_T nexus that transmitted the invalid control page and shall set the INVOP bit to zero for subsequent requests; and
- b) **attached enclosure services processes** shall set the INVOP bit to one the first time they return the Threshold In diagnostic page to any application client and shall set the INVOP bit to zero for subsequent requests.

An Invalid Operation Reason element **may be included in the element list**. If the INVOP bit is set to zero and an Invalid Operation Reason element (see 7.3.12) is included, the Invalid Operation Reason element shall be ignored.

The PAGE LENGTH field indicates **the length in bytes of the diagnostic parameters that follow**.

The **GENERATION CODE** contains the same value as the GENERATION CODE field in the Configuration diagnostic page (see 6.1.2).

The OVERALL THRESHOLD field for each element type has the same format as the corresponding ELEMENT THRESHOLD field. **There is exactly one OVERALL THRESHOLD field for each TYPE DESCRIPTOR HEADER** in the Configuration diagnostic page (see table 7). **The OVERALL THRESHOLD optionally contains a summary** of the threshold values for all of the elements of that type. The OVERALL THRESHOLD also may be used to contain the threshold values for those elements whose individual threshold values are not available, but that do have threshold values.

Following the OVERALL THRESHOLD field, there shall be one ELEMENT THRESHOLD field for each of the possible elements identified by the NUMBER OF POSSIBLE ELEMENTS field in the corresponding TYPE DESCRIPTOR HEADER. **Each ELEMENT THRESHOLD field optionally contains the actual threshold** information for the element.

The OVERALL THRESHOLD field and the ELEMENT THRESHOLD field have the format specified in table 19.

**Table 19 — OVERALL THRESHOLD and ELEMENT THRESHOLD fields for Threshold In diagnostic page**

Byte\Bit	7	6	5	4	3	2	1	0
0	HIGH CRITICAL THRESHOLD							
1	HIGH WARNING THRESHOLD							
2	LOW WARNING THRESHOLD							
3	LOW CRITICAL THRESHOLD							

The HIGH CRITICAL THRESHOLD field indicates the value at which the enclosure indicates a critical condition if a higher value is detected by the **sensor element**. A value of zero indicates that the sensor element does not test a high critical threshold.

The HIGH WARNING THRESHOLD field indicates the value at which the enclosure indicates a noncritical condition if the sensor element detects a value higher than the specified threshold value. A value of zero indicates that the sensor element does not test a high warning threshold.

The LOW WARNING THRESHOLD field indicates the value at which the enclosure indicates a noncritical condition if the sensor element detects a value lower than the specified threshold value. A value of zero indicates that the sensor element does not test a low warning threshold.

The LOW CRITICAL THRESHOLD field indicates the value at which the enclosure indicates a critical condition if the sensor element detects a value lower than the specified threshold value. A value of zero indicates that the sensor element does not test a low critical threshold.

The threshold values represent the values that the enclosure is using at the time the Threshold In diagnostic page is returned.

Each 8-bit threshold value shall have the definition specified by the text describing the corresponding element field. **As an example**, voltage sensor elements measure voltage in units of 10 millivolts. The threshold value is defined by 7.3.20 as a percentage of the nominal voltage in units of 0,5 %. A HIGH CRITICAL THRESHOLD field

Date: 5/12/2008 3:36:09 PM

 Change generation code paragraph to:

The generation code field indicates the value of the generation code (see 4.6.2).

Status

relliott Accepted 1/3/2008 12:35:19 PM -06'00'

---

Author: ibm-gop

Subject: Highlight

Date: 12/20/2007 7:54:36 PM -06'00'

 **6.1.9 Threshold In diagnostic page (3rd paragraph before table 19)**

**This << There is exactly one OVERALL THRESHOLD field for each >> should be << There is one OVERALL THRESHOLD field for each >>. There is no difference between 'exactly one' and 'one'.**

Status

relliott Accepted 12/21/2007 6:20:16 PM -06'00'

---

Author: ibm-gop

Subject: Highlight

Date: 12/13/2007 8:24:47 PM -06'00'

 **6.1.9 Threshold In diagnostic page (3rd paragraph before table 19)**

**This << The OVERALL THRESHOLD optionally contains a summary >> should be << The OVERALL THRESHOLD may contain a summary >>**

Status

relliott Rejected 12/20/2007 7:55:40 PM -06'00'

---

Author: relliott

Subject: Note

Date: 12/20/2007 7:55:38 PM -06'00'

 just deleted optionally. Reworded to parallel control element, status element, and threshold control element sections as well

Author: ibm-gop

Subject: Highlight

Date: 12/13/2007 8:24:47 PM -06'00'

 **6.1.9 Threshold In diagnostic page (2nd paragraph before table 19)**

**This << Each ELEMENT THRESHOLD field optionally contains the actual threshold >> should be << Each ELEMENT THRESHOLD field may contain the actual threshold >>**

Status

relliott Rejected 12/20/2007 7:54:09 PM -06'00'

---

Author: relliott

Subject: Note

Date: 12/20/2007 7:54:07 PM -06'00'

 just deleted optionally - "contains" alone is enough

Author: relliott

Subject: Note

Date: 5/12/2008 3:36:09 PM

 Move the threshold status element definition into 7.2.

Add table in each 7.3 that supports a threshold control element defining the four threshold fields.

Move the e.g. about voltage sensor fields representing a percentage into 7.3.20, and copy into 7.3.21 for current sensors.

Status

relliott Accepted 12/21/2007 3:05:16 PM -06'00'

---

Comments from page 33 continued on next page

Each time the INVOP bit is set to one:

- a) **standalone enclosure service processes** shall set the INVOP bit to one the first time they return the Threshold In diagnostic page to the same I\_T nexus that transmitted the invalid control page and shall set the INVOP bit to zero for subsequent requests; and
- b) **attached enclosure services processes** shall set the INVOP bit to one the first time they return the Threshold In diagnostic page to any application client and shall set the INVOP bit to zero for subsequent requests.

An Invalid Operation Reason element **may be included in the element list**. If the INVOP bit is set to zero and an Invalid Operation Reason element (see 7.3.12) is included, the Invalid Operation Reason element shall be ignored.

The PAGE LENGTH field indicates **the length in bytes of the diagnostic parameters that follow**.

The **GENERATION CODE** contains the same value as the GENERATION CODE field in the Configuration diagnostic page (see 6.1.2).

The OVERALL THRESHOLD field for each element type has the same format as the corresponding ELEMENT THRESHOLD field. **There is exactly one OVERALL THRESHOLD field for each TYPE DESCRIPTOR HEADER** in the Configuration diagnostic page (see table 7). **The OVERALL THRESHOLD optionally contains a summary** of the threshold values for all of the elements of that type. The OVERALL THRESHOLD also may be used to contain the threshold values for those elements whose individual threshold values are not available, but that do have threshold values.

Following the OVERALL THRESHOLD field, there shall be one ELEMENT THRESHOLD field for each of the possible elements identified by the NUMBER OF POSSIBLE ELEMENTS field in the corresponding TYPE DESCRIPTOR HEADER. **Each ELEMENT THRESHOLD field optionally contains the actual threshold** information for the element.

The OVERALL THRESHOLD field and the ELEMENT THRESHOLD field have the format specified in table 19.

**Table 19 — OVERALL THRESHOLD and ELEMENT THRESHOLD fields for Threshold In diagnostic page**

Byte\Bit	7	6	5	4	3	2	1	0
0	HIGH CRITICAL THRESHOLD							
1	HIGH WARNING THRESHOLD							
2	LOW WARNING THRESHOLD							
3	LOW CRITICAL THRESHOLD							

The HIGH CRITICAL THRESHOLD field indicates the value at which the enclosure indicates a critical condition if a higher value is detected by the **sensor element**. A value of zero indicates that the sensor element does not test a high critical threshold.

The HIGH WARNING THRESHOLD field indicates the value at which the enclosure indicates a noncritical condition if the sensor element detects a value higher than the specified threshold value. A value of zero indicates that the sensor element does not test a high warning threshold.

The LOW WARNING THRESHOLD field indicates the value at which the enclosure indicates a noncritical condition if the sensor element detects a value lower than the specified threshold value. A value of zero indicates that the sensor element does not test a low warning threshold.

The LOW CRITICAL THRESHOLD field indicates the value at which the enclosure indicates a critical condition if the sensor element detects a value lower than the specified threshold value. A value of zero indicates that the sensor element does not test a low critical threshold.

The threshold values represent the values that the enclosure is using at the time the Threshold In diagnostic page is returned.

Each 8-bit threshold value shall have the definition specified by the text describing the corresponding element field. **As an example,** voltage sensor elements measure voltage in units of 10 millivolts. The threshold value is defined by 7.3.20 as a percentage of the nominal voltage in units of 0,5 %. A HIGH CRITICAL THRESHOLD field

● Author: relliott  
Subject: Highlight  
Date: 5/12/2008 3:36:09 PM  
T sensor element  
s/b  
sensor

twice in each of these 4 paragraphs

Status  
relliott Accepted 12/21/2007 3:19:11 PM -06'00'

---

● Author: relliott  
Subject: Highlight  
Date: 5/12/2008 3:36:09 PM  
T As an example

convert into an e.g.,

Status  
relliott Accepted 12/20/2007 8:12:41 PM -06'00'

---

value of 14 indicates that a critical condition is indicated when the voltage is 7 % over the nominal maximum supply voltage, while a LOW WARNING THRESHOLD field value of 10 indicates that a noncritical condition is indicated when the voltage is 5 % under the nominal minimum supply voltage.

**6.1.10 Element Descriptor diagnostic page**

The Element Descriptor diagnostic page returns a list of vendor-specific, variable-length ASCII strings (see 3.1.2), one for each element in the Enclosure Status diagnostic page (see 6.1.4).

The Element Descriptor diagnostic page is read by the RECEIVE DIAGNOSTIC RESULTS command with a PCV bit set to one and a PAGE CODE field set to 07h. If the parameter list for a SEND DIAGNOSTIC command contains a PAGE CODE field set to 07h, the command shall be treated as having an invalid field error (see 4.5).

~~The Element Descriptor diagnostic page is optional.~~

Table 20 defines the Element Descriptor diagnostic page.

**Table 20 — Element Descriptor diagnostic page**

Byte\Bit	7	6	5	4	3	2	1	0
0	PAGE CODE (07h)							
1	Reserved							
2	(MSB)	PAGE LENGTH (n - 3)						(LSB)
3								
4	(MSB)	GENERATION CODE						(LSB)
7								
Element descriptor by type list								
variable	Element descriptor by type descriptor (first element type)(see table 21)							
...								
	Element descriptor by type descriptor (last element type)(see table 21)							
n								

The PAGE CODE field is set to 07h.

The PAGE LENGTH field indicates the length in bytes of the diagnostic parameters that follow.



The GENERATION CODE contains the same value as the GENERATION CODE field in the Configuration diagnostic page (see 6.1.2).

The element type descriptor list contains an element descriptor by type descriptor for each element type.



Author: ibm-gop  
Subject: Cross-Out  
Date: 12/13/2007 8:24:47 PM -06'00'

## 6.1.10 Element Descriptor diagnostic page (3rd paragraph)

**This << The Element Descriptor diagnostic page is optional. >> should be deleted as everything is optional unless otherwise stated.**

Status  
relliott Accepted 12/17/2007 3:28:37 PM -06'00'  
Status  
relliott Confirmed 12/17/2007 3:28:42 PM -06'00'

---

Author: relliott  
Subject: Highlight  
Date: 5/12/2008 3:36:09 PM

 variable  
s/b  
8 and blank

since the first byte number is known

Status  
relliott Accepted 1/5/2008 7:00:30 PM -06'00'

---

Author: relliott  
Subject: Highlight  
Date: 5/12/2008 3:36:09 PM

 the length in bytes of the diagnostic parameters that follow.  
s/b  
the number of bytes that follow in the diagnostic page

Status  
relliott Accepted 12/19/2007 1:56:56 PM -06'00'  
Status  
relliott Confirmed 12/19/2007 1:56:53 PM -06'00'

---

Author: relliott  
Subject: Note  
Date: 5/12/2008 3:36:09 PM

 Change generation code paragraph to:  
The generation code field indicates the value of the generation code (see 4.6.2).

Status  
relliott Accepted 1/3/2008 12:35:32 PM -06'00'

---

Author: relliott  
Subject: Highlight  
Date: 5/12/2008 3:36:09 PM

 GENERATION CODE contains  
s/b  
GENERATION CODE field contains

Status  
relliott Accepted 1/3/2008 12:17:51 PM -06'00'

---

Table 21 defines the element descriptor by type descriptor.

**Table 21 — Element descriptor by type descriptor**

Byte\Bit	7	6	5	4	3	2	1	0
0	Overall descriptor (see table 22)							
variable	Element descriptor (first element)(see table 22)							
	...							
n	Element descriptor (last element)(see table 22)							

The overall descriptor contains any descriptor information applying to all elements of the type or describing elements that have no individual descriptor information. The format of the overall descriptor is defined in table 22.

Following the overall descriptor, there shall be one element descriptor for each of the possible elements identified by the NUMBER OF POSSIBLE ELEMENTS field in the corresponding type descriptor header in the Configuration diagnostic page (see 6.1.2). Each element descriptor contains the descriptive information for the element. The format of the element descriptor is defined in table 22.

Table 22 defines the overall descriptor and the element descriptor.

**Table 22 — Overall descriptor format and element descriptor format**

Byte\Bit	7	6	5	4	3	2	1	0
0	Reserved							
1	Reserved							
2	(MSB)	DESCRIPTOR LENGTH (m - 3)						(LSB)
3	DESCRIPTOR							
4	DESCRIPTOR							
m	DESCRIPTOR							

The DESCRIPTOR LENGTH field indicates the length in bytes of the DESCRIPTOR field. A DESCRIPTOR LENGTH of zero indicates that no DESCRIPTOR field is contained in the overall descriptor or element descriptor.

The DESCRIPTOR field indicates an ASCII string (see 3.1.2) reporting vendor-specific information about the element. The DESCRIPTOR field shall not be modified by the Language element (see 7.3.18).

**6.1.11 Short Enclosure Status diagnostic page**



Some enclosure services processes are not capable of reporting any SES diagnostic page except the Short Enclosure Status diagnostic page. Such enclosure services processes shall return only the Short Enclosure Status diagnostic page, regardless of the SES diagnostic page requested. It is not an error to respond with a Short Enclosure Status diagnostic page when another diagnostic page has been requested by a RECEIVE DIAGNOSTIC RESULTS command. See 4.3.

Enclosures reporting the Short Enclosure Status diagnostic page shall not be primary subenclosures. If an enclosure providing the Short Enclosure Status diagnostic page is used as a subenclosure attached to a primary subenclosure, the enclosure shall be represented as a Simple Subenclosure element (see 7.3.24).

Author: relliott  
Subject: Highlight  
Date: 5/12/2008 3:36:09 PM

 n  
s/b  
x

since table 20 already uses n (and includes table 21 as a substructure)

Status  
relliott Accepted 1/5/2008 7:01:53 PM -06'00'

---

Author: symc-roger  
Subject: Note  
Date: 12/13/2007 8:25:13 PM -06'00'

 SYMANTEC 28  
PDF pg 53, pg 35, 6.1.11 Short Enclosure Status diagnostic page

The first sentence in the second paragraph "Enclosures reporting the Short Enclosure Status diagnostic page shall not be primary subenclosures" is a major change from SES, a brand new requirement, and we believe breaks a lot of equipment in the field. It also leads to a contradiction with various definitions in the Configuration diagnostic page

Proposed Resolution:

"Where a primary subenclosure supports multiple other subenclosures, enclosure services processes within the primary Subenclosure shall not use the Short Enclosure Status diagnostic page."

Status  
relliott Rejected 12/21/2007 6:01:26 PM -06'00'

---

Author: relliott  
Subject: Note  
Date: 1/17/2008 9:36:19 PM -06'00'

 If a simple subenclosure is a primary subenclosure, no secondary subenclosures exist.

Renamed 4.3 Use of Short Enclosure Status diagnostic page to new 4.3.3 Simple subenclosures  
Moved this sentence and some other text from this section into 4.3.3.  
Added definitions for simple subenclosure, primary subenclosure, secondary subenclosure.

Key replacement sentence is: "If a simple subenclosure is a primary subenclosure,  
no secondary subenclosures exist."

---

A SEND DIAGNOSTIC command transmitting an Enclosure Control, String Out, or Threshold Out diagnostic page to an enclosure services process that reports the Short Enclosure Status diagnostic page shall be terminated with a CHECK CONDITION status with either:

- a) the sense key set to NOT READY and the additional sense code set to ENCLOSURE SERVICES FAILURE; or
- b) the sense key set to ILLEGAL REQUEST and the additional sense code set to UNSUPPORTED ENCLOSURE FUNCTION.

Table 23 defines the Short Enclosure Status diagnostic page.

**Table 23 — Short Enclosure Status diagnostic page**

Byte\Bit	7	6	5	4	3	2	1	0	
0	PAGE CODE (08h)								
1	SHORT ENCLOSURE STATUS								
2	(MSB)	PAGE LENGTH (0000h)							
3								(LSB)	

The PAGE CODE field is set to 08h.

The SHORT ENCLOSURE STATUS field shall contain the vendor-specific status to be transferred from the enclosure services process to the application client.

The PAGE LENGTH field is 0000h.

**6.1.12 Enclosure Busy diagnostic page**

The Enclosure Busy diagnostic page indicates the enclosure services process is busy and is unable to return the requested page. See 4.4.

Table 24 defines the Enclosure Busy diagnostic page.

**Table 24 — Enclosure Busy diagnostic page**

Byte\Bit	7	6	5	4	3	2	1	0	
0	PAGE CODE (09h)								
1	Vendor specific							BUSY	
2	(MSB)	PAGE LENGTH (0000h)							
3								(LSB)	

The PAGE CODE field is set to 09h.

A BUSY bit set to one indicates that the enclosure services process is busy and the application client should retry the RECEIVE DIAGNOSTIC RESULTS command. A BUSY bit set to zero indicates that the enclosure services process is not busy and is capable of responding to a RECEIVE DIAGNOSTIC RESULTS command requesting an SES diagnostic page.

The BUSY bit shall be set to one whenever this diagnostic page is returned in place of another diagnostic page (i.e., the requested diagnostic page).

The PAGE LENGTH field is 0000h.

## Page: 36

---

Author: symc-roger  
Subject: Note  
Date: 12/13/2007 8:25:13 PM -06'00'

 SYMANTEC 29  
PDF pg 54, pg 35, 6.1.11 Short Enclosure Status diagnostic page

The alpha list contradicts the text in 4.3, where on item b is allowed.

Proposed Resolution:

Make this text and 4.3 agree.

Status  
relliott Accepted 12/21/2007 6:13:06 PM -06'00'

---

Author: relliott  
Subject: Note  
Date: 12/21/2007 6:13:06 PM -06'00'

 This also only mentions 3 page names, while 4.3 mentions "all SES diagnostic pages." Deleting this altogether, so 4.3's rule that UNSUPPORTED ENCLOSURE FUNCTION be returned is the surviving rule.

---

Author: relliott  
Subject: Highlight  
Date: 5/12/2008 3:36:09 PM

 shall contain the vendor-specific status to be transferred from the enclosure services process to the application client.  
s/b  
indicates vendor-specific status about the simple subenclosure.

Status  
relliott Accepted 12/21/2007 6:15:00 PM -06'00'

---

Author: relliott  
Subject: Highlight  
Date: 5/12/2008 3:36:09 PM

 is 0000h  
s/b  
indicates the number of bytes that follow in the diagnostic page and is set to 0000h

Status  
relliott Accepted 12/19/2007 1:57:31 PM -06'00'

Status  
relliott Confirmed 12/19/2007 1:57:28 PM -06'00'

---

Author: ibm-gop  
Subject: Highlight  
Date: 12/13/2007 8:24:47 PM -06'00'

 **6.1.11 Short Enclosure Status diagnostic page (last paragraph)**

**This << The PAGE LENGTH field is 0000h. >> should be << The PAGE LENGTH field is set to 0000h. >>**

Status  
relliott Accepted 12/13/2007 9:31:33 PM -06'00'

Status  
relliott Confirmed 12/13/2007 9:31:36 PM -06'00'

---

Author: relliott  
Subject: Highlight  
Date: 5/12/2008 3:36:09 PM

 indicates the  
s/b  
indicates that the

Status  
relliott Accepted 12/21/2007 6:13:44 PM -06'00'

---

Author: relliott

Comments from page 36 continued on next page

A SEND DIAGNOSTIC command transmitting an Enclosure Control, String Out, or Threshold Out diagnostic page to an enclosure services process that reports the Short Enclosure Status diagnostic page shall be terminated with a CHECK CONDITION status with either:



- a) the sense key set to NOT READY and the additional sense code set to ENCLOSURE SERVICES FAILURE; or
- b) the sense key set to ILLEGAL REQUEST and the additional sense code set to UNSUPPORTED ENCLOSURE FUNCTION.

Table 23 defines the Short Enclosure Status diagnostic page.

**Table 23 — Short Enclosure Status diagnostic page**

Byte\Bit	7	6	5	4	3	2	1	0	
0	PAGE CODE (08h)								
1	SHORT ENCLOSURE STATUS								
2	(MSB)	PAGE LENGTH (0000h)							
3								(LSB)	

The PAGE CODE field is set to 08h.

The SHORT ENCLOSURE STATUS field shall contain the vendor-specific status to be transferred from the enclosure services process to the application client.

The PAGE LENGTH field is 0000h.

**6.1.12 Enclosure Busy diagnostic page**

The Enclosure Busy diagnostic page indicates the enclosure services process is busy and is unable to return the requested page. See 4.4.

Table 24 defines the Enclosure Busy diagnostic page.

**Table 24 — Enclosure Busy diagnostic page**

Byte\Bit	7	6	5	4	3	2	1	0	
0	PAGE CODE (09h)								
1	Vendor specific							BUSY	
2	(MSB)	PAGE LENGTH (0000h)							
3								(LSB)	

The PAGE CODE field is set to 09h.

A BUSY bit set to one indicates that the enclosure services process is busy and the application client should retry the RECEIVE DIAGNOSTIC RESULTS command. A BUSY bit set to zero indicates that the enclosure services process is not busy and is capable of responding to a RECEIVE DIAGNOSTIC RESULTS command requesting an SES diagnostic page.

The BUSY bit shall be set to one whenever this diagnostic page is returned in place of another diagnostic page (i.e., the requested diagnostic page).

The PAGE LENGTH field is 0000h.

Subject: Highlight  
Date: 5/12/2008 3:36:09 PM

**T** is 0000h.  
s/b

indicates the number of bytes that follow in the diagnostic page and is set to 0000h.

Status  
relliott Accepted 12/19/2007 1:57:47 PM -06'00'

Status  
relliott Confirmed 12/19/2007 1:57:44 PM -06'00'

---

Author: ibm-gop  
Subject: Highlight  
Date: 12/13/2007 8:24:47 PM -06'00'

**T** 6.1.12 Enclosure Busy diagnostic page (last paragraph)

**This << The PAGE LENGTH field is 0000h. >> should be << The PAGE LENGTH field is set to 0000h. >>**

Status  
relliott Accepted 12/13/2007 9:31:55 PM -06'00'

Status  
relliott Confirmed 12/13/2007 9:31:59 PM -06'00'

---

6.1.13 Additional Element Status diagnostic page

6.1.13.1 Additional Element Status diagnostic page overview

The optional Additional Element Status diagnostic page provides additional information about:

- a) Device elements (see 7.3.2);
- b) Array Device elements (see 7.3.3);
- c) SAS Expander elements (see 7.3.25);
- d) SCSI Initiator Port elements (see 7.3.23) containing SAS phys;
- e) SCSI Target Port elements (see 7.3.22) containing SAS phys; and
- f) Enclosure Services Controller Electronics elements (see 7.3.9).

The Additional Element Status diagnostic page returns an Additional Element Status descriptor for each of the following elements that have been allowed for by the NUMBER OF POSSIBLE ELEMENTS field in the corresponding type descriptor header in the Configuration diagnostic page (see 6.1.2):

- a) Device elements;
- b) Array Device elements; and
- c) SAS Expander elements;

It may include Additional Element Status descriptors for:

- a) SCSI Initiator Port elements;
- b) SCSI Target Port elements; and
- c) Enclosure Services Controller Electronics elements.

The Additional Element Status descriptors shall be in the same order as the ELEMENT STATUS fields in the Enclosure Status diagnostic page (see 6.1.4).

The Additional Element Status diagnostic page is read by the RECEIVE DIAGNOSTIC RESULTS command with a PCV bit set to one and a PAGE CODE field set to 0Ah. If the parameter list for a SEND DIAGNOSTIC command contains a PAGE CODE field set to 0Ah, the command shall be treated as having an invalid field error (see 4.5).

Table 25 defines the Additional Element Status diagnostic page.

Table 25 — Additional Element Status diagnostic page

Byte\Bit	7	6	5	4	3	2	1	0
0	PAGE CODE (0Ah)							
1	Reserved							
2	(MSB)	PAGE LENGTH (n - 3)						(LSB)
3								
4	(MSB)	GENERATION CODE						(LSB)
7								
Additional Element Status descriptor list								
8	Additional Element Status descriptor (first)(see table 26 and table 27)							
...								
n	Additional Element Status descriptor (last)(see table 26 and table 27)							

The PAGE LENGTH field indicates the length in bytes of the diagnostic parameters that follow.





Author: ibm-gop  
Subject: Cross-Out  
Date: 12/13/2007 8:24:47 PM -06'00'

## 6.1.13.1 Additional Element Status diagnostic page overview (1st paragaph)

**This << optional >> should be deleted as everything is optional unless otherwise stated.**

Status  
relliott Accepted 12/17/2007 3:29:19 PM -06'00'  
Status  
relliott Confirmed 12/17/2007 3:29:22 PM -06'00'

---

Author: ibm-gop  
Subject: Highlight  
Date: 12/13/2007 8:24:47 PM -06'00'

## 6.1.13.1 Additional Element Status diagnostic page overview (2nd paragraph before table 25)

**This << command contains a PAGE CODE field set to 0Ah, the command shall be treated as having an invalid field error >> should be << command contains a PAGE CODE field set to 0Ah, then the command shall be treated as having an invalid field error >>**

Status  
relliott Accepted 12/21/2007 5:38:10 PM -06'00'

---

Author: relliott  
Subject: Highlight  
Date: 5/12/2008 3:36:09 PM

 the length in bytes of the diagnostic parameters that follow.  
s/b  
the number of bytes that follow in the diagnostic page.

Status  
relliott Accepted 12/19/2007 1:58:18 PM -06'00'  
Status  
relliott Confirmed 12/19/2007 1:58:15 PM -06'00'

---

Author: relliott  
Subject: Note  
Date: 5/12/2008 3:36:09 PM

 Add missing generation code paragraph:  
The generation code field indicates the value of the generation code (see 4.6.2).

Status  
relliott Accepted 1/3/2008 5:19:23 PM -06'00'

---

The format of the Additional Element Status descriptor with the EIP bit set to one is shown in table 26.

**Table 26 — Additional Element Status descriptor with the EIP bit set to one**

Byte/Bit	7	6	5	4	3	2	1	0
0	INVALID	Reserved		EIP (1b)	PROTOCOL IDENTIFIER			
1	ADDITIONAL ELEMENT STATUS DESCRIPTOR LENGTH (x - 1)							
2	Reserved							
3	ELEMENT INDEX							
4	Protocol-specific information							
x								

The format of the Additional Element Status descriptor with the EIP bit set to zero is shown in table 27.

**Table 27 — Additional Element Status descriptor with the EIP bit set to zero**

Byte/Bit	7	6	5	4	3	2	1	0
0	INVALID	Reserved		EIP (0b)	PROTOCOL IDENTIFIER			
1	ADDITIONAL ELEMENT STATUS DESCRIPTOR LENGTH (x - 1)							
2	Protocol-specific information							
x								

An INVALID bit set to one indicates that the contents of the protocol-specific information are invalid. An INVALID bit set to zero indicates that the contents of the protocol-specific information are valid. The enclosure services process may set the INVALID bit to one when the ELEMENT STATUS CODE field in the element status for the associated element (see table 62 in 7.2.3) is set to 5h (i.e., not installed), 6h (i.e., unknown), or 7h (not available).

An EIP (element index present) bit set to one indicates that the Additional Element Status descriptor has the format described in table 26. An EIP bit set to zero indicates that the Additional Element Status descriptor has the format described in table 27 (i.e., does not include the two extra bytes including the ELEMENT INDEX field that are defined in table 26). The EIP bit should be set to one.

The PROTOCOL IDENTIFIER field is defined in SPC-4 and identifies the protocol of the device being described by the Additional Element Status descriptor.

The ADDITIONAL ELEMENT STATUS DESCRIPTOR LENGTH field indicates the number of bytes that follow in the Additional Element Status descriptor.

The ELEMENT INDEX field indicates the index of the element that this descriptor is describing. The index is based on the position of the ELEMENT STATUS field in the Enclosure Status diagnostic pages (see 6.1.4) relative to all other ELEMENT STATUS fields. It does not include the OVERALL STATUS fields.

The protocol-specific information bytes contain information defined based on the PROTOCOL IDENTIFIER field. If the PROTOCOL IDENTIFIER field is set to 0h (i.e., Fibre Channel), the protocol-specific information is defined in table 28 (see 6.1.13.2). If the PROTOCOL IDENTIFIER field is set to 6h (i.e., SAS), the protocol-specific information is defined in table 32 (see 6.1.13.3).

**6.1.13.2 Additional Element Status descriptor protocol-specific information for Fibre Channel**

The Additional Element Status descriptor is used to describe a Device element or an Array Device element that may contain a Fibre Channel device, or a SCSI Initiator Port, SCSI Target Port, or Enclosure Services Controller Electronics element that is a Fibre Channel device.

Author: relliott  
Subject: Highlight  
Date: 5/12/2008 3:36:09 PM

**T** is shown in  
s/b  
is defined in

Status  
relliott Accepted 1/5/2008 6:42:14 PM -06'00'

Author: relliott  
Subject: Highlight  
Date: 5/12/2008 3:36:09 PM

**T** is shown in  
s/b  
is defined in

Status  
relliott Accepted 1/5/2008 6:42:24 PM -06'00'

Author: ibm-gop  
Subject: Highlight  
Date: 12/13/2007 8:24:47 PM -06'00'

**T** 6.1.13.1 Additional Element Status diagnostic page overview (1st paragraph after table 27)

This << or 7h (not available). >> should be << or 7h (i.e., not available). >>

Status  
relliott Accepted 12/13/2007 9:32:27 PM -06'00'

Status  
relliott Confirmed 12/13/2007 9:32:29 PM -06'00'

Author: relliott  
Subject: Highlight  
Date: 5/12/2008 3:36:09 PM

**T** described in  
s/b  
defined in

Status  
relliott Accepted 1/5/2008 6:42:37 PM -06'00'

Author: relliott  
Subject: Highlight  
Date: 5/12/2008 3:36:09 PM

**T** described in  
s/b  
defined in

Status  
relliott Accepted 1/5/2008 6:42:46 PM -06'00'

Author: ibm-gop  
Subject: Highlight  
Date: 12/13/2007 8:24:47 PM -06'00'

**T** 6.1.13.1 Additional Element Status diagnostic page overview (2nd paragraph after table 27)

This << The PROTOCOL IDENTIFIER field is defined in SPC-4 and identifies the protocol of the device being described by the Additional Element Status descriptor. >> should be << The PROTOCOL IDENTIFIER field identifies the protocol of the device being described by the Additional Element Status descriptor (see SPC-4). >>

Status  
relliott Rejected 12/15/2007 5:03:24 PM -06'00'

Author: ibm-gop  
Subject: Highlight  
Date: 12/13/2007 8:24:47 PM -06'00'

**T** 6.1.13.2 Additional Element Status descriptor protocol-specific information for Fibre Channel (1st paragraph)

The format of the Additional Element Status descriptor with the EIP bit set to one is shown in table 26.

**Table 26 — Additional Element Status descriptor with the EIP bit set to one**

Byte\Bit	7	6	5	4	3	2	1	0
0	INVALID	Reserved		EIP (1b)	PROTOCOL IDENTIFIER			
1	ADDITIONAL ELEMENT STATUS DESCRIPTOR LENGTH (x - 1)							
2	Reserved							
3	ELEMENT INDEX							
4	Protocol-specific information							
x	Protocol-specific information							

The format of the Additional Element Status descriptor with the EIP bit set to zero is shown in table 27.

**Table 27 — Additional Element Status descriptor with the EIP bit set to zero**

Byte\Bit	7	6	5	4	3	2	1	0
0	INVALID	Reserved		EIP (0b)	PROTOCOL IDENTIFIER			
1	ADDITIONAL ELEMENT STATUS DESCRIPTOR LENGTH (x - 1)							
2	Protocol-specific information							
x	Protocol-specific information							

An INVALID bit set to one indicates that the contents of the protocol-specific information are invalid. An INVALID bit set to zero indicates that the contents of the protocol-specific information are valid. The enclosure services process may set the INVALID bit to one when the ELEMENT STATUS CODE field in the element status for the associated element (see table 62 in 7.2.3) is set to 5h (i.e., not installed), 6h (i.e., unknown), or 7h (not available).

An EIP (element index present) bit set to one indicates that the Additional Element Status descriptor has the format described in table 26. An EIP bit set to zero indicates that the Additional Element Status descriptor has the format described in table 27 (i.e., does not include the two extra bytes including the ELEMENT INDEX field that are defined in table 26). The EIP bit should be set to one.

The PROTOCOL IDENTIFIER field is defined in SPC-4 and identifies the protocol of the device being described by the Additional Element Status descriptor.

The ADDITIONAL ELEMENT STATUS DESCRIPTOR LENGTH field indicates the number of bytes that follow in the Additional Element Status descriptor.

The ELEMENT INDEX field indicates the index of the element that this descriptor is describing. The index is based on the position of the ELEMENT STATUS field in the Enclosure Status diagnostic pages (see 6.1.4) relative to all other ELEMENT STATUS fields. It does not include the OVERALL STATUS fields.

The protocol-specific information bytes contain information defined based on the PROTOCOL IDENTIFIER field. If the PROTOCOL IDENTIFIER field is set to 0h (i.e., Fibre Channel), the protocol-specific information is defined in table 28 (see 6.1.13.2). If the PROTOCOL IDENTIFIER field is set to 6h (i.e., SAS), the protocol-specific information is defined in table 32 (see 6.1.13.3).

#### 6.1.13.2 Additional Element Status descriptor protocol-specific information for Fibre Channel

The Additional Element Status descriptor is used to describe a Device element or an Array Device element that may contain a Fibre Channel device, or a SCSI Initiator Port, SCSI Target Port, or Enclosure Services Controller Electronics element that is a Fibre Channel device.

This << that may contain a Fibre Channel device, or a SCSI Initiator Port, SCSI Target Port, or Enclosure Services Controller Electronics element that is a Fibre Channel device. >> would be clearer if it was an a,b list << that may contain:  
a) a Fibre Channel device; or  
b) a SCSI Initiator Port, SCSI Target Port, or Enclosure Services Controller Electronics element that is a Fibre Channel device. >>

Status  
relliott Accepted 12/15/2007 5:04:19 PM -06'00'  
Status  
relliott Confirmed 12/15/2007 5:04:21 PM -06'00'

---

Table 28 defines the Additional Element Status descriptor protocol-specific information for Fibre Channel devices (see FCP-4) with the EIP bit set to one.

**Table 28 — Additional Element Status descriptor protocol-specific information for Fibre Channel with the EIP bit set to one**

Byte\Bit	7	6	5	4	3	2	1	0
0	NUMBER OF PORTS							
1	Reserved							
2	Reserved							
3	BAY NUMBER							
4	(MSB)	NODE NAME						(LSB)
11								
Port descriptor list								
12	Port descriptor (first)(see table 30)							
27	...							
y - 15	Port descriptor (last)(see table 30)							
y								

Table 29 defines the Additional Element Status descriptor protocol-specific information for Fibre Channel devices (see FCP-4) with the EIP bit set to zero. This format does not include the two extra bytes that are in table 28

**Table 29 — Additional Element Status descriptor protocol-specific information for Fibre Channel with the EIP bit set to zero**

Byte\Bit	7	6	5	4	3	2	1	0
0	NUMBER OF PORTS							
1	Reserved							
2	(MSB)	NODE NAME						(LSB)
9								
Port descriptor list								
10	Port descriptor (first)(see table 30)							
25	...							
y - 15	Port descriptor (last)(see table 30)							
y								

The NUMBER OF PORTS field indicates how many Fibre Channel ports are in the port descriptor list. There is one port descriptor for each port.

The BAY NUMBER field indicates the number of the bay (i.e., the device slot for a Device or Array Device element) represented by the element.

The NODE NAME field contains the node Name\_Identifier of the corresponding Fibre Channel node.

Author: relliott  
Subject: Highlight  
Date: 5/12/2008 3:36:09 PM  
 Rename BAY NUMBER to DEVICE SLOT NUMBER (global)

Status  
relliott Accepted 4/9/2008 6:40:59 PM

---

Author: ibm-gop  
Subject: Highlight  
Date: 12/13/2007 8:24:47 PM -06'00'  
 **6.1.13.2 Additional Element Status descriptor protocol-specific information for Fibre Channel (3rd paragraph after table 29)**  
This << The NODE NAME field contains the node Name\_Identifier of the corresponding Fibre Channel node. >> should be << The NODE NAME field contains the node Name\_Identifier (see FC-FS-2) of the corresponding Fibre Channel node. >>.  
**Note: This will require a new reference be added to section 2.**

Status  
relliott Rejected 1/3/2008 5:23:51 PM -06'00'

---

Author: relliott  
Subject: Note  
Date: 1/3/2008 5:23:51 PM -06'00'  
 changed to "...contains the Node\_Name (see FCP-4)..."

That term is defined in FCP-4, and it points to FC-FS-nn. FCP-4 is already a normative reference in this standard.

---

Table 30 defines the port descriptor.

**Table 30 — Port descriptor**

Byte\Bit	7	6	5	4	3	2	1	0
0	PORT LOOP POSITION							
1	BYPASS REASON							
2	Reserved							
3								
4	PORT REQUESTED HARD ADDRESS							
5	(MSB)	N_PORT IDENTIFIER						(LSB)
7								(LSB)
8	(MSB)	N_PORT_NAME						(LSB)
15								(LSB)

The PORT LOOP POSITION field indicates the position of the corresponding Fibre Channel port on a Fibre Channel Arbitrated Loop.



Author: relliott  
Subject: Highlight  
Date: 5/12/2008 3:36:09 PM

**T** N\_PORT\_NAME  
s/b  
N\_PORT NAME

since N\_Port is considered one word, but N\_PORT\_NAME is not. We don't separate words in field names with underscores - NODE NAME doesn't have an underscore.

Status  
relliott Accepted 1/3/2008 5:28:03 PM -06'00'

---

Author: ibm-gop  
Subject: Highlight  
Date: 12/13/2007 8:24:47 PM -06'00'

**T** **6.1.13.2 Additional Element Status descriptor protocol-specific information for Fibre Channel (1st paragraph after table 30)**  
**This << The PORT LOOP POSITION field indicates the position of the corresponding Fibre Channel port on a Fibre Channel Arbitrated Loop. >> should be << The PORT LOOP POSITION field indicates the position of the corresponding Fibre Channel port on a Fibre Channel Arbitrated Loop (see FC-AL-2). >> Note: This will require a new reference be added to section 2.**

Status  
relliott Accepted 1/3/2008 5:41:01 PM -06'00'

---

Author: relliott  
Subject: Note  
Date: 1/3/2008 5:41:29 PM -06'00'

 The port loop position field indicates the relative position of the corresponding Fibre Channel port on a Fibre Channel Arbitrated Loop (see FC-AL-2).

and added FC-AL-2 reference

---

The BYPASS REASON field indicates the reason the corresponding Fibre Channel port is being bypassed, if it is being bypassed, and is defined in table 31.

**Table 31 — BYPASS REASON field**

Code	Description
00h	Either: a) the port is not being bypassed; or b) the port is being bypassed and no reason is available (e.g., it is being bypassed by request of an application client or the device).
01h - 0Fh	Reserved
10h	Link failure rate is too high
11h	Loss-of-synchronization rate is too high
12h	Loss-of-signal rate is too high
13h	Primitive sequence protocol error rate is too high
14h	Invalid transmission word rate is too high
15h	CRC error rate is too high
16h - 1Fh	Reserved for error rate reasons
20h	Link failure count is too high
21h	Loss-of-synchronization count is too high
22h	Loss-of-signal count is too high
23h	Primitive sequence protocol error count is too high
24h	Invalid transmission word count is too high
25h	CRC error count is too high
26h - 2Fh	Reserved for count reasons
30h - BFh	Reserved
C0h - FFh	Vendor specific

The PORT REQUESTED HARD ADDRESS field contains the Fibre Channel Arbitrated Loop requested hard address of the corresponding Fibre Channel port.

The N\_PORT IDENTIFIER field contains the address identifier of the corresponding Fibre Channel port. Applications may compare the lower 8 bits of this field with the PORT REQUESTED HARD ADDRESS field to determine whether the port was assigned its requested address.

The N\_PORT\_NAME field contains the Name\_Identifier of the corresponding Fibre Channel port.

### 6.1.13.3 Additional Element Status descriptor protocol-specific information for SAS

#### 6.1.13.3.1 Additional Element Status descriptor protocol-specific information for SAS overview

Table 32 defines the Additional Element Status descriptor for SAS devices and expander devices (see SAS-2). This is used to describe:

- a) a Device element or an Array Device element that may contain a SAS device or a SATA device;
- b) a SAS Expander element;
- c) a SCSI Initiator Port element containing SAS phys;
- d) a SCSI Target Port element containing SAS phys; or

Author: ibm-gop  
Subject: Highlight  
Date: 12/13/2007 8:24:47 PM -06'00'

**T** 6.1.13.2 Additional Element Status descriptor protocol-specific information for Fibre Channel (1st paragraph after table 31)  
This << The PORT REQUESTED HARD ADDRESS field contains the Fibre Channel Arbitrated Loop requested hard address of the corresponding Fibre Channel port. >> should be << The PORT REQUESTED HARD ADDRESS field contains the Fibre Channel Arbitrated Loop requested hard address of the corresponding Fibre Channel port (see FC-AL-2). >>  
Note: This will require a new reference be added to section 2.

Status  
relliott Accepted 1/3/2008 5:40:29 PM -06'00'

---

Author: relliott  
Subject: Note  
Date: 1/3/2008 5:40:29 PM -06'00'

 The port requested hard address field contains the Preferred Hard Address of the corresponding Fibre Channel port on a Fibre Channel Arbitrated Loop (see FC-AL-2).  
and added FC-AL-2 reference

---

Author: relliott  
Subject: Highlight  
Date: 5/12/2008 3:36:09 PM

**T** address identifier  
s/b  
Port Identifier (see FCP-4)

as that is a defined term in FCP-4. This matches terminology for the N\_PORT\_NAME and NODE NAME fields.

Status  
relliott Accepted 1/3/2008 5:40:01 PM -06'00'

---

Author: ibm-gop  
Subject: Highlight  
Date: 12/13/2007 8:24:47 PM -06'00'

**T** 6.1.13.2 Additional Element Status descriptor protocol-specific information for Fibre Channel (last paragraph)  
This << The N\_PORT\_NAME field contains the Name\_Identifier of the corresponding Fibre Channel port. >> should be << The N\_PORT\_NAME field contains the Name\_Identifier (see FC-FS-2) of the corresponding Fibre Channel port. >>. Note: This will require a new reference be added to section 2.

Status  
relliott Rejected 1/3/2008 5:25:34 PM -06'00'

---

Author: relliott  
Subject: Note  
Date: 1/3/2008 5:25:34 PM -06'00'

 changed to "...Port\_Name (see FCP-4)..."  
That term is defined in FCP-4, which points to FC-FS-nn as needed.  
FCP-4 is already a normative reference in this standard.

---

- e) an Enclosure Services Controller Electronics element containing SAS phys.

**Table 32 — Additional Element Status descriptor protocol-specific information for SAS**

Byte\Bit	7	6	5	4	3	2	1	0
0	Descriptor-type specific							
1	DESCRIPTOR TYPE		Descriptor-type specific					
2	Descriptor-type specific							
y	Descriptor-type specific							

The DESCRIPTOR TYPE field is defined in table 33.

**Table 33 — DESCRIPTOR TYPE field**

Code	Description
00b	Used for Device elements and Array Device elements (see 6.1.13.3.2)
01b	Used for: a) SAS Expander elements (see 6.1.13.3.3); b) SCSI Initiator Port element (see 6.1.13.3.4); c) SCSI Target Port element (see 6.1.13.3.4); and d) Enclosure Services Controller Electronics elements (see 6.1.13.3.4).
All others	Reserved

### 6.1.13.3.2 Additional Element Status descriptor protocol-specific information for Device and Array Device elements for SAS

Table 34 defines the Additional Element Status descriptor protocol-specific information for Device elements and Array Device elements with the EIP bit (see 6.1.13.1) set to one.

**Table 34 — Additional Element Status descriptor protocol-specific information for Device and Array Device elements for SAS with the EIP bit set to one**

Byte\Bit	7	6	5	4	3	2	1	0
0	NUMBER OF PHY DESCRIPTORS							
1	DESCRIPTOR TYPE (00b)		Reserved				NOT ALL PHYS	
2	Reserved							
3	BAY NUMBER							
Phy descriptor list								
4	Phy descriptor (first)(see table 36)							
31	...							
z - 27	Phy descriptor (last)(see table 36)							
z								

This page contains no comments

Table 35 defines the Additional Element Status descriptor protocol-specific information for Device elements and Array Device elements with the EIP bit (see 6.1.13.1) set to zero. This format does not include the two extra bytes including the BAY NUMBER field that are in table 34.

**Table 35 — Additional Element Status descriptor protocol-specific information for Device and Array Device elements for SAS with the EIP bit set to zero**

Byte\Bit	7	6	5	4	3	2	1	0
0	NUMBER OF PHY DESCRIPTORS							
1	DESCRIPTOR TYPE (00b)		Reserved					NOT ALL PHYS
Phy descriptor list								
2	Phy descriptor (first)(see table 36)							
29	...							
z - 27	Phy descriptor (last)(see table 36)							
z								

The DESCRIPTOR TYPE field is set to 00b.

The NUMBER OF PHY DESCRIPTORS field indicates how many phy descriptors are in the phy descriptor list.

A NOT ALL PHYS bit set to one indicates that all phys in the SAS device or SATA device may or may not be described. A NOT ALL PHYS bit set to zero indicates that all phys in the SAS device or SATA device are described.

NOTE 6 - The NOT ALL PHYS bit may be set to one for SAS devices with multiple ports, where the enclosure services process only has access to information about the phys in one of the ports (e.g., in the same SAS domain as the enclosure services process).

The BAY NUMBER field, if any, indicates the number of the bay (i.e., the device slot for a Device or Array Device element) represented by the element.

This page contains no comments

Table 36 defines the phy descriptor.

Table 36 — Phy descriptor

Byte\Bit	7	6	5	4	3	2	1	0
0	Reserved	DEVICE TYPE			Reserved			
1	Reserved							
2	Reserved				SSP INITIATOR PORT	STP INITIATOR PORT	SMP INITIATOR PORT	Reserved
3	SATA PORT SELECTOR	Reserved			SSP TARGET PORT	STP TARGET PORT	SMP TARGET PORT	SATA DEVICE
4	ATTACHED SAS ADDRESS							
11	SAS ADDRESS							
12	PHY IDENTIFIER							
19	Reserved							
20	Reserved							
21	Reserved							
27	Reserved							

If the device currently associated with the element is a SAS device:

- the DEVICE TYPE field, SSP INITIATOR PORT bit, STP INITIATOR PORT bit, SMP INITIATOR PORT bit, SSP TARGET PORT bit, STP TARGET PORT bit, SMP TARGET PORT bit, SAS ADDRESS field, and PHY IDENTIFIER field contain the values of the fields in the IDENTIFY address frame transmitted by the phy;
- the SATA PORT SELECTOR bit shall be set to zero; and
- the SATA DEVICE bit shall be set to zero.

NOTE 7 - The phy transmits these fields in the IDENTIFY address frame to the attached phy (usually an expander phy in an expander device). The enclosure services process may retrieve the values from the attached phy (e.g., an enclosure process built into an expander device has direct access to the values received by the expander phy).

If the device currently associated with the element is a SATA device:

- the DEVICE TYPE field shall be set to 000b;
- the SSP INITIATOR PORT bit shall be set to zero;
- the STP INITIATOR PORT bit shall be set to zero;
- the SMP INITIATOR PORT bit shall be set to zero;
- the SSP TARGET PORT bit shall be set to zero;
- the STP TARGET PORT bit shall be set to zero;
- the SMP TARGET PORT bit shall be set to zero;
- the SATA PORT SELECTOR bit shall be set to one if the SATA device is attached to a SATA port selector and the SATA PORT SELECTOR bit shall be set to zero if it is not;
- the SATA DEVICE bit shall be set to one;
- the SAS ADDRESS field shall be set to the SAS address of the STP target port of the STP/SATA bridge, and
- the PHY IDENTIFIER field shall be set to 00h.

The ATTACHED SAS ADDRESS field contains the SAS address of the attached phy (e.g., the SAS address of the expander phy to which the SAS device or SATA device is attached).



Author: relliott  
Subject: Note  
Date: 5/12/2008 3:36:09 PM

 something like:  
"device attached to the device slot associated with the element is a SAS device"

Status  
relliott Accepted 1/30/2008 8:22:50 PM -06'00'

---

Author: ibm-gop  
Subject: Highlight  
Date: 12/13/2007 8:24:47 PM -06'00'

**T** 6.1.13.3.2 Additional Element Status descriptor protocol-specific information for Device and Array  
Device elements for SAS (1st paragraph after table 36)

This << If the device currently associated with the element is a SAS device: >> should be << If the device associated with the element is a SAS device: >>

Status  
relliott Accepted 1/30/2008 7:52:52 PM -06'00'

---

Author: relliott  
Subject: Note  
Date: 12/20/2007 7:56:41 PM -06'00'

 current is important because devices can be hotplugged, and it might change to a SATA device

Author: relliott  
Subject: Note  
Date: 1/30/2008 7:52:54 PM -06'00'

 Based on discussion in the January 2008 letter ballot resolution meeting, agreed to change Device element to Device Slot element and change Array Device element to Array Device Slot element. This more accurately reflects what the element represents. Then, this text changes to "If the device in the device slot", getting rid of the "currently" term.

Author: ibm-gop  
Subject: Highlight  
Date: 12/13/2007 8:24:47 PM -06'00'

**T** 6.1.13.3.2 Additional Element Status descriptor protocol-specific information for Device and Array  
Device elements for SAS (note 7)

This << attached phy (usually an expander phy in an expander device). >> should be << attached phy (e.g., an expander phy in an expander device). >>

Status  
relliott Accepted 12/20/2007 7:58:41 PM -06'00'

---

Author: ibm-gop  
Subject: Highlight  
Date: 12/13/2007 8:24:47 PM -06'00'

**T** 6.1.13.3.2 Additional Element Status descriptor protocol-specific information for Device and Array  
Device elements for SAS (1st paragraph after note 7)

This << If the device currently associated with the element is a SATA device: >> should be << If the device associated with the element is a SATA device: >>

Status  
relliott Accepted 1/30/2008 7:53:06 PM -06'00'

---

Author: ibm-gop  
Subject: Highlight  
Date: 12/13/2007 8:24:47 PM -06'00'

**T** 6.1.13.3.2 Additional Element Status descriptor protocol-specific information for Device and Array Device elements for  
SAS (item h after note 7)

This << h) the SATA PORT SELECTOR bit shall be set to one if the SATA device is attached to a SATA port selector and

Table 36 defines the phy descriptor.

**Table 36 — Phy descriptor**

Byte\Bit	7	6	5	4	3	2	1	0
0	Reserved	DEVICE TYPE			Reserved			
1	Reserved							
2	Reserved				SSP INITIATOR PORT	STP INITIATOR PORT	SMP INITIATOR PORT	Reserved
3	SATA PORT SELECTOR	Reserved			SSP TARGET PORT	STP TARGET PORT	SMP TARGET PORT	SATA DEVICE
4	ATTACHED SAS ADDRESS							
11	SAS ADDRESS							
12	PHY IDENTIFIER							
19	Reserved							
20	Reserved							
21	Reserved							
27	Reserved							

If the device currently associated with the element is a SAS device:

- the DEVICE TYPE field, SSP INITIATOR PORT bit, STP INITIATOR PORT bit, SMP INITIATOR PORT bit, SSP TARGET PORT bit, STP TARGET PORT bit, SMP TARGET PORT bit, SAS ADDRESS field, and PHY IDENTIFIER field contain the values of the fields in the IDENTIFY address frame transmitted by the phy;
- the SATA PORT SELECTOR bit shall be set to zero; and
- the SATA DEVICE bit shall be set to zero.

NOTE 7 - The phy transmits these fields in the IDENTIFY address frame to the attached phy (usually an expander phy in an expander device). The enclosure services process may retrieve the values from the attached phy (e.g., an enclosure process built into an expander device has direct access to the values received by the expander phy).

If the device currently associated with the element is a SATA device:

- the DEVICE TYPE field shall be set to 000b;
- the SSP INITIATOR PORT bit shall be set to zero;
- the STP INITIATOR PORT bit shall be set to zero;
- the SMP INITIATOR PORT bit shall be set to zero;
- the SSP TARGET PORT bit shall be set to zero;
- the STP TARGET PORT bit shall be set to zero;
- the SMP TARGET PORT bit shall be set to zero;
- the SATA PORT SELECTOR bit shall be set to one if the SATA device is attached to a SATA port selector and the SATA PORT SELECTOR bit shall be set to zero if it is not;
- the SATA DEVICE bit shall be set to one;
- the SAS ADDRESS field shall be set to the SAS address of the STP target port of the STP/SATA bridge, and
- the PHY IDENTIFIER field shall be set to 00h.

The ATTACHED SAS ADDRESS field contains the SAS address of the attached phy (e.g., the SAS address of the expander phy to which the SAS device or SATA device is attached).

**the SATA PORT SELECTOR bit shall be set to zero if it is not; >> should be << h) the SATA PORT SELECTOR bit shall be set to one if the SATA device is attached to a SATA port selector;**  
**i) the SATA PORT SELECTOR bit shall be set to zero if the SATA device is not attached to a SATA port selector; >>**

Status

relliott Accepted 12/20/2007 7:58:07 PM -06'00'

---

NOTE 8 - All the fields are from the perspective of the SAS device or SATA device associated with the element (e.g., the disk drive), not the device (e.g., the expander device) which receives the IDENTIFY address frame. The ATTACHED SAS ADDRESS fields for multiple phys in the same SAS device or SATA device differ if it is attached to more than one SAS domain.

NOTE 9 - A SATA device may be attached to more than one SAS domain using a SATA port selector.

### 6.1.13.3.3 Additional Element Status descriptor protocol-specific information for SAS Expander elements

Table 37 defines the Additional Element Status descriptor protocol-specific information for SAS Expander elements (see SAS-2).

**Table 37 — Additional Element Status descriptor protocol-specific information for SAS Expander elements**

Byte\Bit	7	6	5	4	3	2	1	0
0	NUMBER OF EXPANDER PHY DESCRIPTORS							
1	DESCRIPTOR TYPE (01b)		Reserved					
2	Reserved							
3	Reserved							
4	SAS ADDRESS							
11	SAS ADDRESS							
Expander phy descriptor list								
12	Expander phy descriptor (first)(see table 38)							
13	Expander phy descriptor (first)(see table 38)							
	...							
y - 1	Expander phy descriptor (last)(see table 38)							
y	Expander phy descriptor (last)(see table 38)							

The DESCRIPTOR TYPE field is set to 01b.

The NUMBER OF EXPANDER PHY DESCRIPTORS field indicates how many expander phy descriptors are in the expander phy descriptor list.

The SAS ADDRESS field indicates the SAS address of the expander device.

Table 38 defines the expander phy descriptor.

**Table 38 — Expander phy descriptor**

Byte\Bit	7	6	5	4	3	2	1	0
0	CONNECTOR ELEMENT INDEX							
1	OTHER ELEMENT INDEX							

The CONNECTOR ELEMENT INDEX field indicates the index of a SAS Connector element (see 7.3.26) to which the expander phy is attached. If the expander phy is not attached to a connector represented by a SAS Connector element, this field shall be set to FFh.

The OTHER ELEMENT INDEX field indicates the index of a Device element (see 7.3.2), Array Device element (see 7.3.3), SAS Expander element (see 7.3.25), SCSI Initiator Port element (see 7.3.23), SCSI Target Port element (see 7.3.22), or Enclosure Services Controller Electronics element (see 7.3.9) to which the expander phy is attached. If the expander phy is not attached to one of those elements, this field shall be set to FFh.

Author: ibm-gop  
Subject: Highlight

Date: 12/13/2007 8:24:47 PM -06'00'

**T** 6.1.13.3.3 Additional Element Status descriptor protocol-specific information for SAS Expander elements (1st paragraph after table 38)

**This << If the expander phy is not attached to a connector represented by a SAS Connector element, this field shall be set to FFh. >> should be << If the expander phy is not attached to a connector represented by a SAS Connector element, then this field shall be set to FFh. >>**

Status

relliott Accepted 12/21/2007 5:37:14 PM -06'00'

---

Author: ibm-gop  
Subject: Highlight

Date: 12/13/2007 8:24:47 PM -06'00'

**T** 6.1.13.3.3 Additional Element Status descriptor protocol-specific information for SAS Expander elements (2nd paragraph after table 38)

**This << If the expander phy is not attached to one of those elements, this field shall be set to FFh. >> should be << If the expander phy is not attached to one of those elements, then this field shall be set to FFh. >>**

Status

relliott Accepted 12/21/2007 5:37:10 PM -06'00'

---

**6.1.13.3.4 Additional Element Status descriptor protocol-specific information for SCSI Initiator Port, SCSI Target Port, and Enclosure Services Controller Electronics elements for SAS**

Table 39 defines the Additional Element Status descriptor protocol-specific information for SCSI Initiator Port and SCSI Target Port elements representing SCSI initiator ports and SCSI target ports with SAS phys.

**Table 39 — Additional Element Status descriptor protocol-specific information for SCSI Initiator Port, SCSI Target Port, and Enclosure Services Controller Electronics elements for SAS**

Byte\Bit	7	6	5	4	3	2	1	0
0	NUMBER OF PHY DESCRIPTORS							
1	DESCRIPTOR TYPE (01b)		Reserved					
2	Reserved							
3	Reserved							
Phy descriptor list								
4	Phy descriptor (first)(see table 40)							
15	...							
y - 1	Phy descriptor (last)(see table 40)							
y								

The DESCRIPTOR TYPE field is set to 01b.

The NUMBER OF PHY DESCRIPTORS field indicates how many phy descriptors are in the phy descriptor list.

Table 40 defines the phy descriptor.

**Table 40 — Phy descriptor**

Byte\Bit	7	6	5	4	3	2	1	0
0	PHY IDENTIFIER							
1	Reserved							
2	CONNECTOR ELEMENT INDEX							
3	OTHER ELEMENT INDEX							
4								
11	SAS ADDRESS							

The PHY IDENTIFIER field indicates the phy identifier (see SAS-2) of the phy.

The CONNECTOR ELEMENT INDEX field indicates the index of a SAS Connector element (see 7.3.26) to which the phy is attached. **If the phy is not attached to a connector represented by a SAS Connector element, this field shall be set to FFh.**

The OTHER ELEMENT INDEX field indicates the index of a Device element (see 7.3.2), Array Device element (see 7.3.3), SAS Expander element (see 7.3.25), SCSI Initiator Port element (see 7.3.23), SCSI Target Port element (see 7.3.22), or Enclosure Services Controller Electronics element (see 7.3.9) to which the phy is attached. If the phy is not attached to one of those elements, this field shall be set to FFh.

The SAS ADDRESS field indicates the SAS address of the phy. If the enclosure services process does not know the SAS address (e.g., the enclosure services process is in an expander on the back-side of an SCC controller, and this is a phy in a SCSI target port on the front-side of the SCC controller), this field shall be set to zero.

Author: relliott  
Subject: Highlight  
Date: 5/12/2008 3:36:09 PM

**T**y - 1  
s/b  
y - 11

since the phy descriptor is 12 bytes long

Status  
relliott Accepted 1/5/2008 7:04:21 PM -06'00'

---

Author: ibm-gop  
Subject: Highlight  
Date: 12/13/2007 8:24:47 PM -06'00'

**T**6.1.13.3.4 Additional Element Status descriptor protocol-specific information for SCSI Initiator Port, SCSI Target Port, and Enclosure Services Controller Electronics elements for SAS (3rd from last paragraph)  
This << If the phy is not attached to a connector represented by a SAS Connector element, this field shall be set to FFh. >> should be << If the phy is not attached to a connector represented by a SAS Connector element, then this field shall be set to FFh. >>

Status  
relliott Accepted 12/21/2007 5:36:45 PM -06'00'

---

**6.1.14 Subenclosure Help Text diagnostic page**

The Subenclosure Help Text diagnostic page contains a text string (see 3.1.31) from an enclosure that describes the present state of the enclosure and provides text indicating what corrective actions, if any, are desirable to bring the enclosure to its fully operational state. The Subenclosure Help Text diagnostic page is intended to allow the writing of enclosure independent application clients that return enclosure specific text describing the state of the enclosure and explaining enclosure dependent corrective actions that may be required. ~~The page is optional.~~

The Subenclosure Help Text diagnostic page is read by the RECEIVE DIAGNOSTIC RESULTS command with a PCV bit set to one and a PAGE CODE field set to 0Bh. If the parameter list for a SEND DIAGNOSTIC command contains a PAGE CODE field set to 0Bh, the command shall be treated as having an invalid field error (see 4.5).

Table 41 defines the Subenclosure Help Text diagnostic page.

**Table 41 — Subenclosure Help Text diagnostic page**

Byte\Bit	7	6	5	4	3	2	1	0
0	PAGE CODE (0Bh)							
1	NUMBER OF SUBENCLOSURES							
2	(MSB)	PAGE LENGTH (n - 3)						(LSB)
3								
4	(MSB)	GENERATION CODE						(LSB)
7								
Subenclosure help text list								
8	Subenclosure help text (primary subenclosure)(see table 42)							
...								
n	Subenclosure help text (last subenclosure)(see table 42)							

The PAGE CODE field is set to 0Bh.

 The NUMBER OF SUBENCLOSURES field specifies the number of separate subenclosure help texts that are included, not including the primary subenclosure. The NUMBER OF SUBENCLOSURES value shall be the same as the number of subenclosures value in the Configuration diagnostic page.

The PAGE LENGTH field indicates the length in bytes of the diagnostic parameters that follow.

 The GENERATION CODE field contains the same value as the GENERATION CODE field in the Configuration diagnostic page (see 6.1.2).



Author: relliott  
Subject: Highlight  
Date: 5/12/2008 3:36:09 PM

 are  
desirable  
s/b  
should be taken

Status  
relliott Accepted 12/21/2007 6:22:55 PM -06'00'

Author: ibm-gop  
Subject: Highlight  
Date: 12/13/2007 8:24:47 PM -06'00'

 6.1.14 Subenclosure Help Text diagnostic page (1st paragraph)

**This << The Subenclosure Help Text diagnostic page is intended to allow the writing of enclosure independent application clients that return enclosure specific text >> should be << The Subenclosure Help Text diagnostic page allows the writing of enclosure independent application clients that return enclosure specific text >>**

Status  
relliott Rejected 12/13/2007 9:35:26 PM -06'00'

Status  
relliott Confirmed 12/13/2007 9:35:30 PM -06'00'

Author: relliott  
Subject: Note  
Date: 12/13/2007 9:35:20 PM -06'00'

 ...allows enclosure-independent application clients to return enclosure-specific text describing the state of the enclosure and explain...

Author: ibm-gop  
Subject: Cross-Out  
Date: 12/13/2007 8:24:47 PM -06'00'

 6.1.14 Subenclosure Help Text diagnostic page (1st paragraph)

**This << The page is optional. >> should be deleted as everything is optional unless otherwise stated.**

Status  
relliott Accepted 12/17/2007 3:29:56 PM -06'00'

Status  
relliott Confirmed 12/17/2007 3:29:59 PM -06'00'

Author: relliott  
Subject: Highlight  
Date: 5/12/2008 3:36:09 PM

 NUMBER OF SUBENCLOSURES  
to  
NUMBER OF SECONDARY SUBENCLOSURES

Status  
relliott Accepted 12/15/2007 6:03:15 PM -06'00'

Status  
relliott Confirmed 12/15/2007 6:03:18 PM -06'00'

Author: relliott  
Subject: Note  
Date: 5/12/2008 3:36:09 PM

 NUMBER OF SUBENCLOSURES  
to  
NUMBER OF SECONDARY SUBENCLOSURES  
in this paragraph and 3 later

Status

**6.1.14 Subenclosure Help Text diagnostic page**

The Subenclosure Help Text diagnostic page contains a text string (see 3.1.31) from an enclosure that describes the present state of the enclosure and provides text indicating what corrective actions, if any, are desirable to bring the enclosure to its fully operational state. The Subenclosure Help Text diagnostic page is intended to allow the writing of enclosure independent application clients that return enclosure specific text describing the state of the enclosure and explaining enclosure dependent corrective actions that may be required. ~~The page is optional.~~

The Subenclosure Help Text diagnostic page is read by the RECEIVE DIAGNOSTIC RESULTS command with a PCV bit set to one and a PAGE CODE field set to 0Bh. If the parameter list for a SEND DIAGNOSTIC command contains a PAGE CODE field set to 0Bh, the command shall be treated as having an invalid field error (see 4.5).

Table 41 defines the Subenclosure Help Text diagnostic page.

**Table 41 — Subenclosure Help Text diagnostic page**

Byte\Bit	7	6	5	4	3	2	1	0
0	PAGE CODE (0Bh)							
1	NUMBER OF SUBENCLOSURES							
2	(MSB)	PAGE LENGTH (n - 3)						(LSB)
3								
4	(MSB)	GENERATION CODE						(LSB)
7								
Subenclosure help text list								
8	Subenclosure help text (primary subenclosure)(see table 42)							
...								
n	Subenclosure help text (last subenclosure)(see table 42)							

The PAGE CODE field is set to 0Bh.

 The NUMBER OF SUBENCLOSURES field specifies the number of separate subenclosure help texts that are included, not including the primary subenclosure. The NUMBER OF SUBENCLOSURES value shall be the same as the number of subenclosures value in the Configuration diagnostic page.

The PAGE LENGTH field indicates the length in bytes of the diagnostic parameters that follow.

 The GENERATION CODE field contains the same value as the GENERATION CODE field in the Configuration diagnostic page (see 6.1.2).

reliott Accepted 12/15/2007 6:03:46 PM -06'00'  
Status  
reliott Confirmed 12/15/2007 6:03:49 PM -06'00'

---

Author: reliott  
Subject: Highlight  
Date: 5/12/2008 3:36:09 PM  
 the length in bytes of the diagnostic parameters that follow  
s/b  
the number of bytes that follow in the diagnostic page

Status  
reliott Accepted 12/19/2007 1:58:37 PM -06'00'  
Status  
reliott Confirmed 12/19/2007 1:58:35 PM -06'00'

---

Author: reliott  
Subject: Note  
Date: 5/12/2008 3:36:09 PM  
 Change generation code paragraph to:  
The generation code field indicates the value of the generation code (see 4.6.2).

Status  
reliott Accepted 1/3/2008 12:37:11 PM -06'00'

---

Table 42 defines the format of each subenclosure help text. The first subenclosure help text shall be for the primary subenclosure; subenclosure help text for the remaining subenclosures may follow in any order.

**Table 42 — Subenclosure help text format**

Byte\Bit	7	6	5	4	3	2	1	0	
0	Reserved								
1	SUBENCLOSURE IDENTIFIER								
2	(MSB)	SUBENCLOSURE HELP TEXT LENGTH (m - 3)							
3								(LSB)	
4	SUBENCLOSURE HELP TEXT								
m									

The SUBENCLOSURE IDENTIFIER field indicates the subenclosure identifier to which the help text applies.

The SUBENCLOSURE HELP TEXT LENGTH field indicates the number of bytes in the SUBENCLOSURE HELP TEXT field. If a subenclosure has no help text, the SUBENCLOSURE HELP TEXT LENGTH field shall contain 0000h.

The SUBENCLOSURE HELP TEXT field contains a text string (see 3.1.31) describing what corrective actions should be performed on the subenclosure to change it from its present state to a fully operational state. The text string shall use the language and character set specified by the Language element (see 7.3.18).

**6.1.15 Subenclosure String Out diagnostic page**

The Subenclosure String Out diagnostic page transmits an enclosure dependent binary string from the application client to the enclosure services process of the specified subenclosure. The binary string may contain bits describing indicator states, text or graphic display information, or control information outside the context of the enclosure elements defined in the Configuration diagnostic page (see 6.1.2).

The format is vendor specific. For standalone enclosure services processes (see 4.1.2), an application client may select the format of the binary string using the manufacturer name and mode from the standard INQUIRY data (see SPC-4) or using the enclosure header information in the Configuration diagnostic page. For attached enclosure services processes (see 4.1.3), an application client should select the format of the binary string using the enclosure header information in the Configuration diagnostic page.

The Subenclosure String Out diagnostic page is written by the SEND DIAGNOSTIC command. A RECEIVE DIAGNOSTIC RESULTS command with a PCV bit set to one and a page code field set to 0Ch is defined as the request to read the Subenclosure String In diagnostic page (see 6.1.16).

Table 14 defines the Subenclosure String Out diagnostic page.

**Table 43 — Subenclosure String Out diagnostic page**

Byte\Bit	7	6	5	4	3	2	1	0	
0	PAGE CODE (0Ch)								
1	SUBENCLOSURE IDENTIFIER								
2	(MSB)	PAGE LENGTH (n - 3)							
3								(LSB)	
4	(MSB)	GENERATION CODE							
7								(LSB)	
8	SUBENCLOSURE STRING OUT DATA								
n									

The PAGE CODE field is set to 0Ch.

Author: ibm-gop  
Subject: Highlight  
Date: 12/13/2007 8:24:47 PM -06'00'

**T** 6.1.14 Subenclosure Help Text diagnostic page (1st paragraph above table 42)

This << Table 42 defines the format of each subenclosure help text. The first subenclosure help text shall be for the primary subenclosure; subenclosure help text for the remaining subenclosures may follow in any order. >> should be << Table 42 defines the format of each subenclosure help text. The first subenclosure help text shall be for the primary subenclosure. Subenclosure help text for the remaining subenclosures may follow in any order. >>

Status  
relliott Accepted 12/21/2007 5:36:04 PM -06'00'

Author: relliott  
Subject: Highlight  
Date: 5/12/2008 3:36:09 PM

**T** help text  
s/b  
subenclosure help text

Status  
relliott Accepted 12/17/2007 1:53:11 PM -06'00'

Status  
relliott Confirmed 12/17/2007 1:53:14 PM -06'00'

Author: relliott  
Subject: Highlight  
Date: 5/12/2008 3:36:09 PM

**T** indicates the subenclosure identifier  
s/b  
indicates the subenclosure

Status  
relliott Accepted 12/17/2007 1:50:32 PM -06'00'

Status  
relliott Confirmed 12/17/2007 1:50:35 PM -06'00'

Author: ibm-gop  
Subject: Highlight  
Date: 12/13/2007 8:24:47 PM -06'00'

**T** 6.1.14 Subenclosure Help Text diagnostic page (2nd to last paragraph)  
This << the SUBENCLOSURE HELP TEXT LENGTH field shall contain 0000h. >> should be << the SUBENCLOSURE HELP TEXT LENGTH field shall be set to 0000h. >>

Status  
relliott Accepted 12/13/2007 9:41:20 PM -06'00'

Status  
relliott Confirmed 12/13/2007 9:41:23 PM -06'00'

Author: relliott  
Subject: Highlight  
Date: 5/12/2008 3:36:09 PM

**T** specified by the Language element  
s/b  
indicated by the Language element

Status  
relliott Accepted 1/4/2008 12:39:38 PM -06'00'

Author: relliott  
Subject: Highlight  
Date: 5/12/2008 3:36:09 PM

**T** enclosure elements  
s/b  
elements

Status  
relliott Accepted 1/4/2008 12:40:26 PM -06'00'

Table 42 defines the format of each subenclosure help text. The first subenclosure help text shall be for the primary subenclosure; subenclosure help text for the remaining subenclosures may follow in any order.

**Table 42 — Subenclosure help text format**

Byte\Bit	7	6	5	4	3	2	1	0	
0	Reserved								
1	SUBENCLOSURE IDENTIFIER								
2	(MSB)	SUBENCLOSURE HELP TEXT LENGTH (m - 3)							
3								(LSB)	
4	SUBENCLOSURE HELP TEXT								
m									

The SUBENCLOSURE IDENTIFIER field indicates the subenclosure identifier to which the help text applies.

The SUBENCLOSURE HELP TEXT LENGTH field indicates the number of bytes in the SUBENCLOSURE HELP TEXT field. If a subenclosure has no help text, the SUBENCLOSURE HELP TEXT LENGTH field shall contain 0000h.

The SUBENCLOSURE HELP TEXT field contains a text string (see 3.1.31) describing what corrective actions should be performed on the subenclosure to change it from its present state to a fully operational state. The text string shall use the language and character set specified by the Language element (see 7.3.18).

**6.1.15 Subenclosure String Out diagnostic page**

The Subenclosure String Out diagnostic page transmits an enclosure dependent binary string from the application client to the enclosure services process of the specified subenclosure. The binary string may contain bits describing indicator states, text or graphic display information, or control information outside the context of the enclosure elements defined in the Configuration diagnostic page (see 6.1.2).

The format is vendor specific. For standalone enclosure services processes (see 4.1.2), an application client may select the format of the binary string using the manufacturer name and mode from the standard INQUIRY data (see SPC-4) or using the enclosure header information in the Configuration diagnostic page. For attached enclosure services processes (see 4.1.3), an application client should select the format of the binary string using the enclosure header information in the Configuration diagnostic page.

The Subenclosure String Out diagnostic page is written by the SEND DIAGNOSTIC command. A RECEIVE DIAGNOSTIC RESULTS command with a PCV bit set to one and a page code field set to 0Ch is defined as the request to read the Subenclosure String In diagnostic page (see 6.1.16).

Table 14 defines the Subenclosure String Out diagnostic page.

**Table 43 — Subenclosure String Out diagnostic page**

Byte\Bit	7	6	5	4	3	2	1	0	
0	PAGE CODE (0Ch)								
1	SUBENCLOSURE IDENTIFIER								
2	(MSB)	PAGE LENGTH (n - 3)							
3								(LSB)	
4	(MSB)	GENERATION CODE							
7								(LSB)	
8	SUBENCLOSURE STRING OUT DATA								
n									

The PAGE CODE field is set to 0Ch.

Author: relliott  
Subject: Highlight  
Date: 5/12/2008 3:36:09 PM

**T** format is vendor specific  
s/b

format of the binary string is vendor specific

to match ibm-gop comment in 6.1.6

Status

relliott Accepted 12/13/2007 10:25:55 PM -06'00'

Status

relliott Confirmed 12/13/2007 10:25:58 PM -06'00'

---

Author: relliott  
Subject: Highlight  
Date: 5/12/2008 3:36:09 PM

**T** page code field  
s/b

smallcaps

Status

relliott Accepted 12/13/2007 9:45:13 PM -06'00'

Status

relliott Confirmed 12/13/2007 9:45:11 PM -06'00'

---

Author: relliott  
Subject: Highlight  
Date: 5/12/2008 3:36:09 PM

**T** Table 14 defines  
s/b

Table 43 defines

Status

relliott Accepted 1/5/2008 6:16:48 PM -06'00'

---

The SUBENCLOSURE IDENTIFIER field specifies the vendor-specific identifier for the subenclosure to which the application client wants the vendor specific bytes String Out data sent. The SUBENCLOSURE IDENTIFIER value shall match a SUBENCLOSURE IDENTIFIER value found in the Configuration diagnostic page, or the enclosure services process shall report an invalid field error (see 4.5).

The PAGE LENGTH field specifies the length in bytes of the diagnostic parameters that follow.

The GENERATION CODE field shall have the value expected to be found in the GENERATION CODE field of the Configuration diagnostic page (see 6.1.2). ~~To prevent the misinterpretation of the String Out data,~~ the enclosure services process shall verify that the value of the GENERATION CODE field matches the generation code value known by the enclosure services process. If there is a mismatch, the application client shall be notified of an invalid field error (see 4.5) and the enclosure services process shall ignore the remainder of the diagnostic page.

The SUBENCLOSURE STRING OUT DATA field shall contain the vendor-specific information to be transferred from the application client to the enclosure services process of the specified subenclosure.

**6.1.16 Subenclosure String In diagnostic page**

The Subenclosure String In diagnostic page transmits enclosure dependent binary string(s) from the enclosure services process of the subenclosures to the application client. The binary strings may contain bits describing keyboard states, switch states, or the content of other information provided by the primary subenclosure to the application client.

The format of each binary string is vendor specific. For standalone enclosure services processes (see 4.1.2), an application client may determine the format of the binary string using the manufacturer name and mode from the standard INQUIRY data (see SPC-4) or using the enclosure header information in the Configuration diagnostic page (see 6.1.2). For attached enclosure services processes (see 4.1.3), an application client should select the format of the binary string using the enclosure header information in the Configuration diagnostic page.

The transmission of a page using the SEND DIAGNOSTIC command with a PAGE CODE field set to 0Ch is defined as the transmission of a Subenclosure String Out diagnostic page (see 6.1.15).

Table 44 defines the Subenclosure String In diagnostic page.

**Table 44 — Subenclosure String In diagnostic page**

Byte\Bit	7	6	5	4	3	2	1	0
0	PAGE CODE (0Ch)							
1	NUMBER OF SUBENCLOSURES							
2	(MSB)	PAGE LENGTH (n - 3)						(LSB)
3								
4	(MSB)	GENERATION CODE						(LSB)
7								
Subenclosure string in data list								
8	Subenclosure string in data (primary subenclosure)(see table 45)							
...								
n	Subenclosure string in data (last subenclosure)(see table 45)							

The PAGE CODE field is set to 0Ch.



Author: relliott  
Subject: Highlight  
Date: 5/12/2008 3:36:09 PM

**T** specifies the vendor-specific identifier for the subenclosure to which the application client wants the vendor specific bytes String Out data sent.

s/b

specifies the subenclosure to which the application client is sending the subenclosure string out data.

Status  
relliott Accepted 12/17/2007 1:56:05 PM -06'00'

Status  
relliott Confirmed 12/17/2007 1:56:09 PM -06'00'

Author: relliott  
Subject: Highlight  
Date: 5/12/2008 3:36:09 PM

**T** The SUBENCLOSURE IDENTIFIER value

shall match a SUBENCLOSURE IDENTIFIER value found in the Configuration diagnostic page, or the enclosure services process shall report an invalid field error (see 4.5).

s/b

If the subenclosure identifier field does not match a subenclosure identifier field value indicated in the Configuration diagnostic page, the enclosure services process shall report an invalid field error (see 4.5).

Status  
relliott Accepted 12/17/2007 2:08:32 PM -06'00'

Status  
relliott Confirmed 12/17/2007 2:08:35 PM -06'00'

Author: relliott  
Subject: Highlight  
Date: 5/12/2008 3:36:09 PM

**T** the length in bytes of the diagnostic parameters that follow.

s/b

the number of bytes that follow in the diagnostic page

Status  
relliott Accepted 12/20/2007 7:59:28 PM -06'00'

Author: ibm-gop  
Subject: Cross-Out  
Date: 12/13/2007 8:24:47 PM -06'00'

**T** **6.1.15 Subenclosure String Out diagnostic page (2nd to the last paragraph)**

**This << To prevent the misinterpretation of the String Out data, >> should be deleted as it contains a justification for the required action. Standards should not justify requirements.**

Status  
relliott Accepted 12/20/2007 8:18:42 PM -06'00'

Author: relliott  
Subject: Note  
Date: 5/12/2008 3:36:09 PM

**T** Change GENERATION CODE to EXPECTED GENERATION CODE and change paragraph to:

The expected generation code field is defined in the Enclosure Control diagnostic page (see 6.1.3).

Status  
relliott Accepted 1/3/2008 5:45:16 PM -06'00'

Author: relliott  
Subject: Highlight  
Date: 5/12/2008 3:36:09 PM

**T** NUMBER OF SUBENCLOSURES

to

NUMBER OF SECONDARY SUBENCLOSURES

The SUBENCLOSURE IDENTIFIER field specifies the vendor-specific identifier for the subenclosure to which the application client wants the vendor specific bytes String Out data sent. The SUBENCLOSURE IDENTIFIER value shall match a SUBENCLOSURE IDENTIFIER value found in the Configuration diagnostic page, or the enclosure services process shall report an invalid field error (see 4.5).

The PAGE LENGTH field specifies the length in bytes of the diagnostic parameters that follow.



The GENERATION CODE field shall have the value expected to be found in the GENERATION CODE field of the Configuration diagnostic page (see 6.1.2). ~~To prevent the misinterpretation of the String Out data,~~ the enclosure services process shall verify that the value of the GENERATION CODE field matches the generation code value known by the enclosure services process. If there is a mismatch, the application client shall be notified of an invalid field error (see 4.5) and the enclosure services process shall ignore the remainder of the diagnostic page.

The SUBENCLOSURE STRING OUT DATA field shall contain the vendor-specific information to be transferred from the application client to the enclosure services process of the specified subenclosure.

**6.1.16 Subenclosure String In diagnostic page**

The Subenclosure String In diagnostic page transmits enclosure dependent binary string(s) from the enclosure services process of the subenclosures to the application client. The binary strings may contain bits describing keyboard states, switch states, or the content of other information provided by the primary subenclosure to the application client.

The format of each binary string is vendor specific. For standalone enclosure services processes (see 4.1.2), an application client may determine the format of the binary string using the manufacturer name and mode from the standard INQUIRY data (see SPC-4) or using the enclosure header information in the Configuration diagnostic page (see 6.1.2). For attached enclosure services processes (see 4.1.3), an application client should select the format of the binary string using the enclosure header information in the Configuration diagnostic page.

The transmission of a page using the SEND DIAGNOSTIC command with a PAGE CODE field set to 0Ch is defined as the transmission of a Subenclosure String Out diagnostic page (see 6.1.15).

Table 44 defines the Subenclosure String In diagnostic page.

**Table 44 — Subenclosure String In diagnostic page**

Byte\Bit	7	6	5	4	3	2	1	0
0	PAGE CODE (0Ch)							
1	NUMBER OF SUBENCLOSURES							
2	(MSB)	PAGE LENGTH (n - 3)						(LSB)
3								
4	(MSB)	GENERATION CODE						(LSB)
7								
Subenclosure string in data list								
8	Subenclosure string in data (primary subenclosure)(see table 45)							
...								
n	Subenclosure string in data (last subenclosure)(see table 45)							

The PAGE CODE field is set to 0Ch.

Status  
relliott Accepted 12/15/2007 6:06:13 PM -06'00'

Status  
relliott Confirmed 12/15/2007 6:06:16 PM -06'00'

---

The NUMBER OF SUBENCLOSURES field indicates the number of separate subenclosure string in data values that are included, not including the primary subenclosure. The NUMBER OF SUBENCLOSURES value shall be the same as the number of subenclosures value in the Configuration diagnostic page.

The PAGE LENGTH field indicates the length in bytes of the diagnostic parameters that follow.

The GENERATION CODE field contains the same value as the GENERATION CODE field in the Configuration diagnostic page (see 6.1.2).

Table 45 defines the format of each subenclosure string in data. The first subenclosure string in data shall be for the primary subenclosure; subenclosure string in data for the remaining subenclosures may follow in any order.

**Table 45 — Subenclosure string in data format**

Byte\Bit	7	6	5	4	3	2	1	0
0	Reserved							
1	SUBENCLOSURE IDENTIFIER							
2	(MSB)	SUBENCLOSURE STRING IN DATA LENGTH (m - 3)						(LSB)
3								
4	SUBENCLOSURE STRING IN DATA							
m								

The SUBENCLOSURE IDENTIFIER field indicates the subenclosure identifier to which the subenclosure string in data applies.

The SUBENCLOSURE STRING IN DATA LENGTH field indicates the number of bytes in the SUBENCLOSURE STRING IN DATA field. If a subenclosure has no subenclosure string in data, the SUBENCLOSURE STRING IN DATA LENGTH field shall contain 0000h.

The SUBENCLOSURE STRING IN DATA field shall contain the vendor specific information to be transferred from the enclosure services process to the application client.

**6.1.17 Supported SES Diagnostic Pages diagnostic page**

The Supported SES Diagnostic Pages diagnostic subpage returns the list of diagnostic pages in the range of 01h to 2Fh implemented by the enclosure services process.

The Supported SES Diagnostic Pages diagnostic page is read by the RECEIVE DIAGNOSTIC RESULTS command with a PCV bit set to one and a PAGE CODE field set to 0Dh. If the parameter list for a SEND DIAGNOSTIC command contains a PAGE CODE field set to 0Dh, the command shall be treated as having an invalid field error (see 4.5). ~~The Supported SES Diagnostic Pages diagnostic page indicates the enclosure services process is busy and is unable to return the requested page.~~

Author: relliott  
Subject: Note  
Date: 5/12/2008 3:36:09 PM  
 NUMBER OF SUBENCLOSURES  
to  
NUMBER OF SECONDARY SUBENCLOSURES

in this paragraph and 3 later

Status  
relliott Accepted 12/15/2007 6:06:42 PM -06'00'  
Status  
relliott Confirmed 12/15/2007 6:06:45 PM -06'00'

---

Author: relliott  
Subject: Highlight  
Date: 5/12/2008 3:36:09 PM  
 the length in bytes of the diagnostic parameters that follow.  
s/b  
the number of bytes that follow in the diagnostic page.

Status  
relliott Accepted 12/20/2007 8:00:19 PM -06'00'

---

Author: relliott  
Subject: Note  
Date: 5/12/2008 3:36:09 PM  
 Change generation code paragraph to:  
The generation code field indicates the value of the generation code (see 4.6.2).

Status  
relliott Accepted 1/3/2008 12:37:35 PM -06'00'

---

Author: relliott  
Subject: Highlight  
Date: 5/12/2008 3:36:09 PM  
 indicates the subenclosure identifier  
s/b  
indicates the subenclosure

Status  
relliott Accepted 12/17/2007 1:53:29 PM -06'00'  
Status  
relliott Confirmed 12/17/2007 1:53:32 PM -06'00'



---

Author: ibm-gop  
Subject: Highlight  
Date: 12/13/2007 8:24:47 PM -06'00'  
 **6.1.16 Subenclosure String In diagnostic page (2nd to last paragraph)**

**This << the SUBENCLOSURE STRING IN DATA LENGTH field shall contain 0000h >> should be << the SUBENCLOSURE STRING IN DATA LENGTH field shall be set to 0000h >>**

Status  
relliott Accepted 12/13/2007 9:41:42 PM -06'00'  
Status  
relliott Confirmed 12/13/2007 9:41:46 PM -06'00'

---

Author: relliott  
Subject: Cross-Out  
Date: 5/12/2008 3:36:09 PM  
 The Supported SES Diagnostic Pages diagnostic page indicates the enclosure  
 services process is busy and is unable to return the requested page.

Status  
relliott Accepted 12/17/2007 3:31:10 PM -06'00'

---

Table 24 defines the Supported SES Diagnostic Pages diagnostic page

**Table 46 — Supported SES Diagnostic Pages diagnostic page**

Byte\Bit	7	6	5	4	3	2	1	0
0	PAGE CODE (0Dh)							
1	Reserved							
2	(MSB)	PAGE LENGTH (n - 3)						(LSB)
3								
4	SUPPORTED SES PAGE LIST							
n	PAD (if needed)							

The PAGE CODE field is set to 0Dh.

The PAGE LENGTH field indicates the length in bytes of the rest of the diagnostic page.

The SUPPORTED SES PAGE LIST field contains a list of all diagnostic page codes, one per byte, in the range of 01h to 2Fh that are implemented by the enclosure services process. It shall be sorted in ascending order beginning with page code 01h. The Supported SES Diagnostic Pages page code (i.e., 0Dh) shall be included in the list.

The PAD field contains zero, one, two, or three bytes set to 00h such that the total length of the diagnostic page is a multiple of four.

**6.1.18 Download Microcode Control diagnostic page**

The Download Microcode Control diagnostic page transmits a vendor-specific microcode (i.e., firmware) image to the control memory space of the enclosure services process. The image may optionally be saved to non-volatile storage (e.g., a flash ROM).

The Download Microcode Control diagnostic page is written by the SEND DIAGNOSTIC command. A RECEIVE DIAGNOSTIC RESULTS command with a PCV bit set to one and a page code field set to 0Eh is defined as the request to read the Download Microcode Status diagnostic page (see 6.1.19).

The microcode image may be sent using one or more SEND DIAGNOSTIC commands. If the complete set of SEND DIAGNOSTIC commands required to deliver the microcode image are not received before:

- a) for attached enclosure services processes (see 4.1.2), power off, or
- b) for standalone enclosure services processes (see 4.1.3), a logical unit reset, hard reset, power on, or I\_T nexus loss,

the incomplete microcode image shall not be used.

If an error is detected, the enclosure services process shall abort the download microcode operation and set the SUBENCLOSURE DOWNLOAD MICROCODE STATUS field to the appropriate value in the Download Microcode Status diagnostic page.

# Page: 51

---

Author: relliott  
Subject: Highlight  
Date: 5/12/2008 3:36:09 PM

**T** Table 24 defines  
s/b  
Table 46 defines

Status  
relliott Accepted 1/5/2008 6:16:26 PM -06'00'

---

Author: relliott  
Subject: Highlight  
Date: 5/12/2008 3:36:09 PM

**T** the length in bytes of the rest of the diagnostic page.  
s/b  
the number of bytes that follow in the diagnostic page.

Status  
relliott Accepted 12/19/2007 1:59:45 PM -06'00'

Status  
relliott Confirmed 12/19/2007 1:59:42 PM -06'00'

---

Author: ibm-gop  
Subject: Cross-Out  
Date: 12/13/2007 8:24:47 PM -06'00'

**T** 6.1.18 Download Microcode Control diagnostic page (1st paragraph)

**This << optionally >> should be deleted as everything is optional unless otherwise stated.**

Status  
relliott Accepted 12/17/2007 3:31:45 PM -06'00'

Status  
relliott Confirmed 12/17/2007 3:31:50 PM -06'00'

---

Author: relliott  
Subject: Highlight  
Date: 5/12/2008 3:36:09 PM

**T** page code field  
s/b  
smallcaps

Status  
relliott Accepted 12/13/2007 9:45:51 PM -06'00'

Status  
relliott Confirmed 12/13/2007 9:45:49 PM -06'00'

---

Author: relliott  
Subject: Highlight  
Date: 5/12/2008 3:36:09 PM

**T** attached enclosure services processes (see 4.1.2)  
s/b  
... (see 4.1.3)

Status  
relliott Accepted 12/13/2007 9:12:17 PM -06'00'

Status  
relliott Confirmed 12/13/2007 9:12:19 PM -06'00'

---

Author: relliott  
Subject: Note  
Date: 5/12/2008 3:36:09 PM

**T** reorder a) and b) so standalone goes first

Status  
relliott Accepted 12/13/2007 9:12:53 PM -06'00'

---

Comments from page 51 continued on next page



Table 24 defines the Supported SES Diagnostic Pages diagnostic page.

**Table 46 — Supported SES Diagnostic Pages diagnostic page**

Byte\Bit	7	6	5	4	3	2	1	0
0	PAGE CODE (0Dh)							
1	Reserved							
2	(MSB)	PAGE LENGTH (n - 3)						(LSB)
3								
4	SUPPORTED SES PAGE LIST							
n	PAD (if needed)							

The PAGE CODE field is set to 0Dh.

The PAGE LENGTH field indicates the length in bytes of the rest of the diagnostic page.

The SUPPORTED SES PAGE LIST field contains a list of all diagnostic page codes, one per byte, in the range of 01h to 2Fh that are implemented by the enclosure services process. It shall be sorted in ascending order beginning with page code 01h. The Supported SES Diagnostic Pages page code (i.e., 0Dh) shall be included in the list.

The PAD field contains zero, one, two, or three bytes set to 00h such that the total length of the diagnostic page is a multiple of four.

**6.1.18 Download Microcode Control diagnostic page**

The Download Microcode Control diagnostic page transmits a vendor-specific microcode (i.e., firmware) image to the control memory space of the enclosure services process. The image may optionally be saved to non-volatile storage (e.g., a flash ROM).

The Download Microcode Control diagnostic page is written by the SEND DIAGNOSTIC command. A RECEIVE DIAGNOSTIC RESULTS command with a PCV bit set to one and a page code field set to 0Eh is defined as the request to read the Download Microcode Status diagnostic page (see 6.1.19).

The microcode image may be sent using one or more SEND DIAGNOSTIC commands. If the complete set of SEND DIAGNOSTIC commands required to deliver the microcode image are not received before:



- a) for attached enclosure services processes (see 4.1.2), power on; or
- b) for standalone enclosure services processes (see 4.1.3), a logical unit reset, hard reset, power on, or I\_T nexus loss,

the incomplete microcode image shall not be used.

If an error is detected, the enclosure services process shall abort the download microcode operation and set the SUBENCLOSURE DOWNLOAD MICROCODE STATUS field to the appropriate value in the Download Microcode Status diagnostic page.

Status  
relliott Confirmed 12/13/2007 9:12:56 PM -06'00'

---

Author: relliott  
Subject: Highlight  
Date: 5/12/2008 3:36:09 PM  
**T** standalone enclosure services processes (see 4.1.3)  
s/b  
... (see 4.1.2)

Status  
relliott Accepted 12/13/2007 9:12:38 PM -06'00'

Status  
relliott Confirmed 12/13/2007 9:12:35 PM -06'00'

---

Author: hpq-relliott  
Subject: Highlight  
Date: 12/13/2007 8:24:34 PM -06'00'  
**T** the  
s/b  
then the

Status  
relliott Accepted 12/13/2007 10:52:01 PM -06'00'

Status  
relliott Confirmed 12/13/2007 10:51:58 PM -06'00'

---

Author: ibm-gop  
Subject: Highlight  
Date: 12/13/2007 8:24:47 PM -06'00'  
**T** 6.1.18 Download Microcode Control diagnostic page (3rd paragraph before table 47)

**This << the incomplete microcode image shall not be used. >> should be << then, the incomplete microcode image shall not be used. >>**

Status  
relliott Accepted 12/13/2007 9:11:45 PM -06'00'

Status  
relliott Confirmed 12/13/2007 9:11:50 PM -06'00'

---

Author: relliott  
Subject: Note  
Date: 12/13/2007 9:12:04 PM -06'00'  
 without , after then

---

Table 47 defines the Download Microcode Control diagnostic page.

**Table 47 — Download Microcode Control diagnostic page**

Byte\Bit	7	6	5	4	3	2	1	0
0	PAGE CODE (0Eh)							
1	SUBENCLOSURE IDENTIFIER							
2	(MSB)	PAGE LENGTH (n - 3)						(LSB)
3								
4	(MSB)	GENERATION CODE						(LSB)
7								
8	DOWNLOAD MICROCODE MODE							
9	Reserved							
10								
11	BUFFER ID							
12	(MSB)	BUFFER OFFSET						(LSB)
15								
16	(MSB)	MICROCODE IMAGE LENGTH						(LSB)
19								
20	(MSB)	MICROCODE DATA LENGTH (m - 23)						(LSB)
23								
24	MICROCODE DATA							
m								
m + 1	PAD (if needed)							
n								

The PAGE CODE field is set to 0Eh.

The SUBENCLOSURE IDENTIFIER field specifies the vendor-specific identifier for the subenclosure to which the application client is sending the microcode image. If the SUBENCLOSURE IDENTIFIER value does not match a SUBENCLOSURE IDENTIFIER value found in the Configuration diagnostic page (see 6.1.2), the enclosure services process shall abort the download microcode operation and set the SUBENCLOSURE DOWNLOAD MICROCODE STATUS field to 80h in the Download Microcode Status diagnostic page.

The PAGE LENGTH field specifies the length in bytes of the remainder of the diagnostic page. If the PAGE LENGTH field value does not match the length of the page, the enclosure services process shall abort the download microcode operation and set the SUBENCLOSURE DOWNLOAD MICROCODE STATUS field to 80h in the Download Microcode Status diagnostic page.

 The GENERATION CODE field specifies the value expected to be found in the GENERATION CODE field of the Configuration diagnostic page (see 6.1.2). ~~To prevent the misinterpretation of the microcode data,~~ the enclosure services process shall verify that the value of the GENERATION CODE field matches the generation code value known by the enclosure services process. If there is a mismatch, the enclosure services process shall abort the download microcode operation and set the SUBENCLOSURE DOWNLOAD MICROCODE STATUS field to 80h in the Download Microcode Status diagnostic page.

Author: relliott  
Subject: Highlight  
Date: 5/12/2008 3:36:09 PM  
**T** specifies the vendor-specific identifier for the subenclosure  
s/b  
specifies the subenclosure

Status  
relliott Accepted 12/17/2007 1:56:30 PM -06'00'  
Status  
relliott Confirmed 12/17/2007 1:56:32 PM -06'00'

---

Author: ibm-gop  
Subject: Highlight  
Date: 12/17/2007 2:09:55 PM -06'00'  
**T** 6.1.18 Download Microcode Control diagnostic page (2nd paragraph after table 47)

**This**  
<< If the SUBENCLOSURE IDENTIFIER value does not match a SUBENCLOSURE IDENTIFIER value found in the Configuration diagnostic page (see 6.1.2), the enclosure services process shall abort the download microcode operation and set the SUBENCLOSURE DOWNLOAD MICROCODE STATUS field to 80h in the Download Microcode Status diagnostic page. >> should be  
<< If the SUBENCLOSURE IDENTIFIER value does not match a SUBENCLOSURE IDENTIFIER value found in the Configuration diagnostic page (see 6.1.2) then, the enclosure services process shall abort the download microcode operation and set the SUBENCLOSURE DOWNLOAD MICROCODE STATUS field to 80h in the Download Microcode Status diagnostic page. >>

Status  
relliott Rejected 12/17/2007 2:09:53 PM -06'00'

---

Author: relliott  
Subject: Highlight  
Date: 5/12/2008 3:36:09 PM  
**T** the length in bytes of the remainder of the diagnostic page.  
s/b  
the number of bytes that follow in the diagnostic page.

Status  
relliott Accepted 12/19/2007 2:00:07 PM -06'00'  
Status  
relliott Confirmed 12/19/2007 2:00:03 PM -06'00'

---

Author: ibm-gop  
Subject: Highlight  
Date: 12/19/2007 7:20:35 PM -06'00'  
**T** 6.1.18 Download Microcode Control diagnostic page (3rd paragraph after table 47)

**This**  
<< If the PAGE length of the page, the enclosure services process shall abort the >> should be  
<< If the PAGE length of the page then, the enclosure services process shall abort the >>

Status  
relliott Rejected 12/19/2007 7:20:34 PM -06'00'

---

Author: relliott  
Subject: Note  
Date: 5/12/2008 3:36:09 PM  
**T** Change GENERATION CODE to EXPECTED GENERATION CODE and change paragraph to:  
The expected generation code field is defined in the Enclosure Control diagnostic page (see 6.1.3).

keeping the additional mismatch sentence

Status  
relliott Accepted 1/3/2008 2:57:59 PM -06'00'

---

Author: ibm-gop  
Subject: Cross-Out  
Date: 12/13/2007 8:24:47 PM -06'00'

Table 47 defines the Download Microcode Control diagnostic page.

**Table 47 — Download Microcode Control diagnostic page**

Byte\Bit	7	6	5	4	3	2	1	0
0	PAGE CODE (0Eh)							
1	SUBENCLOSURE IDENTIFIER							
2	(MSB)	PAGE LENGTH (n - 3)						(LSB)
3								
4	(MSB)	GENERATION CODE						(LSB)
7								
8	DOWNLOAD MICROCODE MODE							
9	Reserved							
10								
11	BUFFER ID							
12	(MSB)	BUFFER OFFSET						(LSB)
15								
16	(MSB)	MICROCODE IMAGE LENGTH						(LSB)
19								
20	(MSB)	MICROCODE DATA LENGTH (m - 23)						(LSB)
23								
24	MICROCODE DATA							
m								
m + 1	PAD (if needed)							
n								

The PAGE CODE field is set to 0Eh.

The SUBENCLOSURE IDENTIFIER field specifies the vendor-specific identifier for the subenclosure to which the application client is sending the microcode image. If the SUBENCLOSURE IDENTIFIER value does not match a SUBENCLOSURE IDENTIFIER value found in the Configuration diagnostic page (see 6.1.2), the enclosure services process shall abort the download microcode operation and set the SUBENCLOSURE DOWNLOAD MICROCODE STATUS field to 80h in the Download Microcode Status diagnostic page.

The PAGE LENGTH field specifies the length in bytes of the remainder of the diagnostic page. If the PAGE LENGTH field value does not match the length of the page, the enclosure services process shall abort the download microcode operation and set the SUBENCLOSURE DOWNLOAD MICROCODE STATUS field to 80h in the Download Microcode Status diagnostic page.



The GENERATION CODE field specifies the value expected to be found in the GENERATION CODE field of the Configuration diagnostic page (see 6.1.2). ~~To prevent the misinterpretation of the microcode data,~~ the enclosure services process shall verify that the value of the GENERATION CODE field matches the generation code value known by the enclosure services process. If there is a mismatch, the enclosure services process shall abort the download microcode operation and set the SUBENCLOSURE DOWNLOAD MICROCODE STATUS field to 80h in the Download Microcode Status diagnostic page.

 6.1.18 Download Microcode Control diagnostic page (4th paragraph after table 47)

This << To prevent the misinterpretation of the microcode data, >> should be deleted as it contains a justification for the required action. Standards should not justify requirements.

Status  
relliott Accepted 12/20/2007 8:18:47 PM -06'00'

---

The DOWNLOAD MICROCODE MODE field is defined in table 48.

**Table 48 — DOWNLOAD MICROCODE MODE field**

Code	Name	Description
06h	Download microcode with offsets	<p>After the last SEND DIAGNOSTIC command delivering a Download Microcode Control diagnostic page to the subenclosure completes, the enclosure services process shall:</p> <ol style="list-style-type: none"> <li>1) verify the complete microcode image (e.g., perform a vendor-specific checksum);</li> <li>2) provided there are no errors in the microcode image, set the SUBENCLOSURE DOWNLOAD MICROCODE STATUS field to 10h in the Download Microcode Status diagnostic page;</li> <li>3) wait for a RECEIVE DIAGNOSTIC RESULTS command requesting the Download Microcode Status diagnostic page; and</li> <li>4) begin using the new microcode image (i.e., reboot).</li> </ol> <p>The downloaded microcode shall be used until:</p> <ol style="list-style-type: none"> <li>a) it is supplanted by another download microcode operation;</li> <li>b) for attached enclosure services processes, power on; or</li> <li>c) for standalone enclosure services processes, hard reset or power on.</li> </ol>
07h	Download microcode with offsets and save	<p>After the last SEND DIAGNOSTIC command delivering a Download Microcode Control diagnostic page to the subenclosure completes, the enclosure services process shall verify the complete microcode image (e.g., perform a vendor-specific checksum) and save the new microcode image into non-volatile storage (e.g., flash ROM).</p> <p>If there are no errors in the microcode image or in the save operation, it shall return the SUBENCLOSURE DOWNLOAD MICROCODE STATUS field set to one of the following values in the Download Microcode Status diagnostic page, if requested, and start using the new microcode when specified:</p> <ol style="list-style-type: none"> <li>a) 10h: begin using the new microcode image after:             <ol style="list-style-type: none"> <li>A) returning the Download Microcode Status diagnostic page;</li> <li>B) power on; or</li> <li>C) for standalone enclosure services processes, hard reset;</li> </ol> </li> <li>b) 11h: for standalone enclosure services processes only. Begin using the new microcode image after:             <ol style="list-style-type: none"> <li>A) power on; or</li> <li>B) hard reset;</li> </ol> </li> <li>c) 12h: begin using the new microcode image after power on.</li> </ol> <p>The application client may determine the microcode revision level currently in use by retrieving the PRODUCT REVISION LEVEL field in the Enclosure descriptor in the Configuration diagnostic page.</p>
All others	Reserved	Reserved. The enclosure services process shall abort the download microcode operation and set the SUBENCLOSURE DOWNLOAD MICROCODE STATUS field to 80h in the Download Microcode Status diagnostic page.

Once a download microcode operation has begun, if the DOWNLOAD MICROCODE MODE field value changes while specifying the same buffer ID, the enclosure services process shall abort the download microcode operation and set the SUBENCLOSURE DOWNLOAD MICROCODE STATUS field to 80h in the Download Microcode Status diagnostic page.

The BUFFER ID field specifies a specific buffer within the enclosure services process to receive the microcode image. The enclosure services process assigns vendor-specific buffer ID codes to buffers (e.g., the main

Author: ibm-gop

Subject: Note

Date: 12/13/2007 8:24:47 PM -06'00'

 6.1.18 Download Microcode Control diagnostic page (table 48)

**Download modes Eh and Fh should be added to this table.**

Status

relliott Accepted 1/4/2008 7:25:40 PM -06'00'

---

Author: relliott

Subject: Note

Date: 1/4/2008 7:25:40 PM -06'00'

 Text for modes Eh and Fh:

0Eh: After the last SEND DIAGNOSTIC command delivering a Download Microcode Control diagnostic page to the subenclosure completes, the enclosure services process shall verify the complete microcode image (e.g., perform a vendor-specific checksum), save the new microcode image into non-volatile storage (e.g., flash ROM), and defer activation of the new microcode.

If there are no errors in the microcode image or in the save operation, it shall return the subenclosure download microcode status field set to the following value in the Download Microcode Status diagnostic page, if requested, and activate the new microcode when specified:

13h: activate the new microcode image after:

a SEND DIAGNOSTIC command delivers a Download Microcode Control diagnostic page with the download microcode mode field set to 0Fh to the subenclosure completes;

power on; or

hard reset.

The application client may determine the microcode revision level currently in use by retrieving the product revision level field in the Enclosure descriptor in the Configuration diagnostic page.

0Fh: After the SEND DIAGNOSTIC command specifying this mode completes, the enclosure services process shall activate the new microcode image.

The application client may determine the microcode revision level currently in use by retrieving the product revision level field in the Enclosure descriptor in the Configuration diagnostic page.

George's suggested status values (reworded a bit):

03h - The enclosure services process is currently updating non-volatile storage with deferred microcode. 13h - Download microcode operation data transfer complete with no error. The enclosure services process (e.g., an standalone enclosure services process) begins using the new microcode after a DOWNLOAD MICROCODE MODE field of 0Fh (active deferred microcode) is received, after the next hard reset, or a power on. 85h - There is no deferred microcode that has been saved using a DOWNLOAD MICROCODE MODE field of 0Eh (download microcode with offsets, save, and defer activate).

---

Author: relliott

Subject: Note

Date: 5/12/2008 3:36:09 PM

 reorder b) and c) so standalone goes first

Status

relliott Accepted 12/13/2007 9:13:53 PM -06'00'

Status

relliott Confirmed 12/13/2007 9:13:57 PM -06'00'



The DOWNLOAD MICROCODE MODE field is defined in table 48.

**Table 48 — DOWNLOAD MICROCODE MODE field**

Code	Name	Description
06h	Download microcode with offsets	<p>After the last SEND DIAGNOSTIC command delivering a Download Microcode Control diagnostic page to the subenclosure completes, the enclosure services process shall:</p> <ol style="list-style-type: none"> <li>1) verify the complete microcode image (e.g., perform a vendor-specific checksum);</li> <li>2) provided there are no errors in the microcode image, set the SUBENCLOSURE DOWNLOAD MICROCODE STATUS field to 10h in the Download Microcode Status diagnostic page;</li> <li>3) wait for a RECEIVE DIAGNOSTIC RESULTS command requesting the Download Microcode Status diagnostic page; and</li> <li>4) begin using the new microcode image (i.e., reboot).</li> </ol> <p>The downloaded microcode shall be used until:</p> <ol style="list-style-type: none"> <li>a) it is supplanted by another download microcode operation;</li> <li>b) for attached enclosure services processes, power on; or</li> <li>c) for standalone enclosure services processes, hard reset or power on.</li> </ol>
07h	Download microcode with offsets and save	<p>After the last SEND DIAGNOSTIC command delivering a Download Microcode Control diagnostic page to the subenclosure completes, the enclosure services process shall verify the complete microcode image (e.g., perform a vendor-specific checksum) and save the new microcode image into non-volatile storage (e.g., flash ROM).</p> <p>If there are no errors in the microcode image or in the save operation, it shall return the SUBENCLOSURE DOWNLOAD MICROCODE STATUS field set to one of the following values in the Download Microcode Status diagnostic page, if requested, and start using the new microcode when specified:</p> <ol style="list-style-type: none"> <li>a) 10h: begin using the new microcode image after:             <ol style="list-style-type: none"> <li>A) returning the Download Microcode Status diagnostic page;</li> <li>B) power on; or</li> <li>C) for standalone enclosure services processes, hard reset;</li> </ol> </li> <li>b) 11h: for standalone enclosure services processes only. Begin using the new microcode image after:             <ol style="list-style-type: none"> <li>A) power on; or</li> <li>B) hard reset;</li> </ol> </li> <li>c) 12h: begin using the new microcode image after power on.</li> </ol> <p>The application client may determine the microcode revision level currently in use by retrieving the PRODUCT REVISION LEVEL field in the Enclosure descriptor in the Configuration diagnostic page.</p>
All others	Reserved	Reserved. The enclosure services process shall abort the download microcode operation and set the SUBENCLOSURE DOWNLOAD MICROCODE STATUS field to 80h in the Download Microcode Status diagnostic page.

Once a download microcode operation has begun, if the DOWNLOAD MICROCODE MODE field value changes while specifying the same buffer ID, the enclosure services process shall abort the download microcode operation and set the SUBENCLOSURE DOWNLOAD MICROCODE STATUS field to 80h in the Download Microcode Status diagnostic page.

The BUFFER ID field specifies a specific buffer within the enclosure services process to receive the microcode image. The enclosure services process assigns vendor-specific buffer ID codes to buffers (e.g., the main

---

Author: ibm-gop

Subject: Highlight

Date: 12/13/2007 8:24:47 PM -06'00'

**T** 6.1.18 Download Microcode Control diagnostic page (1st paragraph after table 48)

**This << begun, if the DOWNLOAD MICROCODE MODE field value changes while specifying the same buffer ID, the enclosure services process shall >> should be << begun, if the DOWNLOAD MICROCODE MODE field value changes while specifying the same buffer ID, then the enclosure services process shall >>**

Status

relliott Rejected 12/21/2007 5:40:23 PM -06'00'

---

firmware image may be stored in buffer 0 and a backup firmware image may be stored in buffer 1). The enclosure services process shall support a buffer ID value of zero. If more than one buffer is supported, then it shall assign additional buffer ID codes contiguously, beginning with 1. If it receives an unsupported buffer ID code, the enclosure services process shall abort the download microcode operation and set the SUBENCLOSURE DOWNLOAD MICROCODE STATUS field to 80h in the Download Microcode Status diagnostic page.

The enclosure services process may require that only one subenclosure download microcode operation be processed at a time, and/or may require that only one buffer ID be used at a time. If the enclosure services process does not accept the specified combination of subenclosure identifier and buffer ID, it shall abort the download microcode operation and set the SUBENCLOSURE DOWNLOAD MICROCODE STATUS field to 80h in the Download Microcode Status diagnostic page.

The BUFFER OFFSET field specifies the offset in bytes within the buffer to which the microcode data is written. The BUFFER OFFSET field shall be set to a multiple of 4. The enclosure services process may require that the BUFFER OFFSET field be contiguously increasing in consecutive SEND DIAGNOSTIC commands. If the enclosure services process does not accept the specified buffer offset, it shall abort the download microcode operation and set the SUBENCLOSURE DOWNLOAD MICROCODE STATUS field to 80h in the Download Microcode Status diagnostic page.

The MICROCODE IMAGE LENGTH field specifies the total number of bytes in the microcode image the application intends to send to the specified buffer ID. The microcode image may be sent using one or more SEND DIAGNOSTIC commands.

The MICROCODE DATA LENGTH field specifies the number of bytes in the MICROCODE DATA field.

The MICROCODE DATA field contains part of the vendor-specific microcode image.

The PAD field contains zero, one, two, or three bytes set to 00h such that the total length of the diagnostic page is a multiple of four.

**6.1.19 Download Microcode Status diagnostic page**

The Download Microcode Status diagnostic page transmits information about the status of one or more download microcode operations to the application client.

The transmission of a page using the SEND DIAGNOSTIC command with a PAGE CODE field set to 0Eh is defined as the transmission of a Download Microcode Control diagnostic page (see 6.1.18).

Table 49 defines the Download Microcode Status diagnostic page.

**Table 49 — Download Microcode Status diagnostic page**

Byte\Bit	7	6	5	4	3	2	1	0	
0	PAGE CODE (0Eh)								
1	NUMBER OF SUBENCLOSURES								
2	(MSB)	PAGE LENGTH (n - 3)							
3								(LSB)	
4	(MSB)	GENERATION CODE							
7								(LSB)	
Download microcode status descriptor list									
8	Download microcode status descriptor (primary subenclosure)(see table 50)								
23									
	...								
n - 23	Download microcode status descriptor (last subenclosure)(see table 50)								
n									

Author: ibm-gop  
Subject: Highlight  
Date: 12/13/2007 8:24:47 PM -06'00'

**T** 6.1.18 Download Microcode Control diagnostic page (2nd paragraph after table 48)

**This << shall assign additional buffer ID codes contiguously, beginning with 1. If it receives an >> should be << shall assign additional buffer ID codes contiguously, beginning with one. If it receives an >>**

Status  
relliott Rejected 12/20/2007 8:01:52 PM -06'00'

---

Author: relliott  
Subject: Note  
Date: 12/20/2007 8:01:49 PM -06'00'  
 changed to 01h instead. Changed all other reference to buffer ID values to hex numbers.

---

Author: ibm-gop  
Subject: Highlight  
Date: 12/13/2007 8:24:47 PM -06'00'

**T** 6.1.18 Download Microcode Control diagnostic page (4th paragraph after table 48)

**This << The BUFFER OFFSET field shall be set to a multiple of 4. The enclosure services >> should be << The BUFFER OFFSET field shall be set to a multiple of four. The enclosure services >>**

Status  
relliott Accepted 12/20/2007 8:02:16 PM -06'00'

---

Author: relliott  
Subject: Highlight  
Date: 5/12/2008 3:36:09 PM

**T** NUMBER OF SUBENCLOSURES  
to  
NUMBER OF SECONDARY SUBENCLOSURES

Status  
relliott Accepted 12/15/2007 6:08:46 PM -06'00'

Status  
relliott Confirmed 12/15/2007 6:08:49 PM -06'00'

---

Author: relliott  
Subject: Highlight  
Date: 5/12/2008 3:36:09 PM

**T** n - 23  
s/b  
n - 15

The descriptor is 16 bytes long, so if n were 15, the first byte would be n-15=0

Status  
relliott Accepted 1/5/2008 7:10:59 PM -06'00'

---

The PAGE CODE field is set to 0Eh.

The NUMBER OF SUBENCLOSURES field indicates the number of separate subenclosure download microcode status descriptors that are included, not including the primary subenclosure. The NUMBER OF SUBENCLOSURES value shall be the same as the number of subenclosures value in the Configuration diagnostic page (see 6.1.2).

The PAGE LENGTH field indicates the length in bytes of the remainder of the diagnostic page.

The GENERATION CODE field contains the same value as the GENERATION CODE field in the Configuration diagnostic page (see 6.1.2).

Table 50 defines the format of each subenclosure's download microcode status descriptor. The first download microcode status descriptor shall be for the primary subenclosure; download microcode status descriptors for the remaining subenclosures may follow in any order.

**Table 50 — Download microcode status descriptor format**

Byte\Bit	7	6	5	4	3	2	1	0
0	Reserved							
1	SUBENCLOSURE IDENTIFIER							
2	SUBENCLOSURE DOWNLOAD MICROCODE STATUS							
3	SUBENCLOSURE DOWNLOAD MICROCODE ADDITIONAL STATUS							
4	(MSB)	SUBENCLOSURE DOWNLOAD MICROCODE MAXIMUM SIZE						(LSB)
7								
8	Reserved							
10								
11	SUBENCLOSURE DOWNLOAD MICROCODE EXPECTED BUFFER ID							
12	(MSB)	SUBENCLOSURE DOWNLOAD MICROCODE EXPECTED BUFFER OFFSET						(LSB)
15								

The SUBENCLOSURE IDENTIFIER field indicates the subenclosure identifier to which the download microcode status descriptor applies.

The SUBENCLOSURE DOWNLOAD MICROCODE STATUS field indicates the status of download microcode operations for the subenclosure and is defined in table 51. After reporting a non-zero value, the enclosure

Author: relliott  
Subject: Note  
Date: 5/12/2008 3:36:09 PM  
NUMBER OF SUBENCLOSURES  
to  
NUMBER OF SECONDARY SUBENCLOSURES

in this paragraph and 3 later

Status  
relliott Accepted 12/15/2007 6:09:15 PM -06'00'  
Status  
relliott Confirmed 12/15/2007 6:09:18 PM -06'00'

---

Author: relliott  
Subject: Highlight  
Date: 5/12/2008 3:36:09 PM  
T the length in bytes of the remainder of the diagnostic page.  
s/b  
the number of bytes that follow in the diagnostic page

Status  
relliott Accepted 12/19/2007 7:14:34 PM -06'00'  
Status  
relliott Confirmed 12/19/2007 7:14:29 PM -06'00'

---

Author: relliott  
Subject: Note  
Date: 5/12/2008 3:36:09 PM  
Change generation code paragraph to:  
The generation code field indicates the value of the generation code (see 4.6.2).

Status  
relliott Accepted 1/3/2008 12:37:55 PM -06'00'

---

Author: ibm-gop  
Subject: Highlight  
Date: 12/13/2007 8:24:47 PM -06'00'  
T **6.1.19 Download Microcode Status diagnostic page (1st paragraph before table 50)**

**This << shall be for the primary subenclosure; download microcode status descriptors for the remaining subenclosures may follow in any order. >> should be << shall be for the primary subenclosure. Download microcode status descriptors for the remaining subenclosures may follow in any order. >>**

Status  
relliott Rejected 12/15/2007 6:09:49 PM -06'00'

---

Author: relliott  
Subject: Highlight  
Date: 5/12/2008 3:36:09 PM  
T indicates the subenclosure identifier  
s/b  
indicates the subenclosure

Status  
relliott Accepted 12/17/2007 1:52:17 PM -06'00'  
Status  
relliott Confirmed 12/17/2007 1:52:22 PM -06'00'

---

Author: hpq-relliott  
Subject: Highlight  
Date: 12/13/2007 8:24:34 PM -06'00'  
T After reporting a non-zero value

It should be allowed to return non-zero several times. This seems to say it only gets one shot.

The PAGE CODE field is set to 0Eh.

The NUMBER OF SUBENCLOSURES field indicates the number of separate subenclosure download microcode status descriptors that are included, not including the primary subenclosure. The NUMBER OF SUBENCLOSURES value shall be the same as the number of subenclosures value in the Configuration diagnostic page (see 6.1.2).

The PAGE LENGTH field indicates the length in bytes of the remainder of the diagnostic page.

The GENERATION CODE field contains the same value as the GENERATION CODE field in the Configuration diagnostic page (see 6.1.2).

Table 50 defines the format of each subenclosure's download microcode status descriptor. The first download microcode status descriptor shall be for the primary subenclosure; download microcode status descriptors for the remaining subenclosures may follow in any order.

**Table 50 — Download microcode status descriptor format**

Byte\Bit	7	6	5	4	3	2	1	0
0	Reserved							
1	SUBENCLOSURE IDENTIFIER							
2	SUBENCLOSURE DOWNLOAD MICROCODE STATUS							
3	SUBENCLOSURE DOWNLOAD MICROCODE ADDITIONAL STATUS							
4	(MSB)	SUBENCLOSURE DOWNLOAD MICROCODE MAXIMUM SIZE						(LSB)
7								
8	Reserved							
10								
11	SUBENCLOSURE DOWNLOAD MICROCODE EXPECTED BUFFER ID							
12	(MSB)	SUBENCLOSURE DOWNLOAD MICROCODE EXPECTED BUFFER OFFSET						(LSB)
15								

The SUBENCLOSURE IDENTIFIER field indicates the subenclosure identifier to which the download microcode status descriptor applies.

The SUBENCLOSURE DOWNLOAD MICROCODE STATUS field indicates the status of download microcode operations for the subenclosure and is defined in table 51. After reporting a non-zero value, the enclosure

Status

relliott Accepted 1/4/2008 12:58:57 PM -06'00'

---

Author: relliott

Subject: Note

Date: 1/4/2008 12:58:57 PM -06'00'

 change to "after reporting a code indicating completion". Adding "Code indicating completion" header rows to the table around 10h-EFh.

---



services process shall set the SUBENCLOSURE DOWNLOAD MICROCODE STATUS field to 00h and shall set the SUBENCLOSURE DOWNLOAD MICROCODE ADDITIONAL STATUS field to 00h

**Table 51 — SUBENCLOSURE DOWNLOAD MICROCODE STATUS field**

Code	Description
00h	No download microcode operation in progress.
01h	Download microcode operation in progress. The enclosure services process has received one or more Download Microcode Control diagnostic pages and is awaiting additional microcode data.
02h	Download microcode operation data transfer complete, currently updating non-volatile storage
03h - 0Fh	Reserved for codes indicating interim status
10h	Download microcode operation complete with no error. The enclosure services process begins using the new microcode after returning this status.
11h	Download microcode operation complete with no error. The enclosure services process (e.g., a standalone enclosure services process) begins using the new microcode after the next hard reset or power on.
12h	Download microcode operation complete with no error. The enclosure services process (e.g., an attached enclosure services process) begins using the new microcode after the next power on.
13h - 6Fh	Reserved for codes indicating no error
70h - 7Fh	Vendor-specific
80h	Error in one or more of the Download Microcode Control diagnostic page fields, new microcode discarded. The SUBENCLOSURE DOWNLOAD MICROCODE ADDITIONAL STATUS field shall be set to the offset of the lowest byte of whichever field in the Download Microcode Control diagnostic page which is in error.
81h	Microcode image error (e.g., a problem detected from a vendor-specific check of the microcode image such as a checksum), new microcode discarded
82h	Download microcode timeout, new microcode discarded. The enclosure services process may discard microcode data after a vendor-specific amount of time if it does not receive the entire microcode image.
83h	Internal error in the download microcode operation; new microcode image is needed before a hard reset or power on (e.g., a flash ROM write failed and no backup ROM image is available).
84h	Internal error in the download microcode operation; hard reset and power on safe (e.g., the enclosure services process will use a backup ROM image on hard reset or power on).
85h - EFh	Reserved for codes indicating errors
F0h - FFh	Vendor-specific error in the download microcode operation; microcode image status is vendor-specific.

The SUBENCLOSURE DOWNLOAD MICROCODE ADDITIONAL STATUS field provides additional status for certain values of the SUBENCLOSURE DOWNLOAD MICROCODE STATUS field as described in table 51.

The SUBENCLOSURE DOWNLOAD MICROCODE MAXIMUM SIZE field indicates the maximum size in bytes of the microcode image that the enclosure services process accepts. The image may be delivered using one or more Download Microcode Control diagnostic pages.

The SUBENCLOSURE DOWNLOAD MICROCODE EXPECTED BUFFER ID field indicates the next value that the enclosure services process expects in the BUFFER ID field in the Download Microcode Control diagnostic page.

Author: hpq-relliott  
Subject: Highlight  
Date: 12/13/2007 8:24:34 PM -06'00'

**T** 00h  
s/b  
00h.

Status  
relliott Accepted 12/13/2007 9:42:55 PM -06'00'

Status  
relliott Confirmed 12/13/2007 9:42:52 PM -06'00'

---

Author: relliott  
Subject: Note  
Date: 5/12/2008 3:36:09 PM

 Add horizontal separators (tan shaded) for:  
Codes indicating interim status  
00 - 0Fh  
Codes indicating completion with no errors  
10 - 7Fh  
Codes indication completion with errors  
80 - EFh  
Other  
F0 - FFh

This is useful for the Asynchronous Event Notification section, which can say that the notification is done when Download Microcode status reports completion (don't want to notify on each interim status change)

Status  
relliott Accepted 1/3/2008 7:23:07 PM -06'00'

---

Author: relliott  
Subject: Highlight  
Date: 5/12/2008 3:36:09 PM

**T** whichever field in the Download Microcode  
Control diagnostic page which  
s/b  
the field...that

Status  
relliott Accepted 12/21/2007 5:33:29 PM -06'00'

---

If the enclosure services process accepts multiple BUFFER ID field values concurrently, it shall set the SUBENCLOSURE DOWNLOAD MICROCODE EXPECTED BUFFER ID field to FFh.

The SUBENCLOSURE DOWNLOAD MICROCODE EXPECTED BUFFER OFFSET field indicates the next value that the enclosure services process expects in the BUFFER OFFSET field in the Download Microcode Control diagnostic page. If the enclosure services process accepts arbitrary BUFFER OFFSET field values, it shall set the SUBENCLOSURE DOWNLOAD MICROCODE EXPECTED BUFFER OFFSET field to FFFFFFFFh.

**6.1.20 Subenclosure Nickname Control diagnostic page**

The Subenclosure Nickname Control diagnostic page transmits a text string (see 3.1.31) to the enclosure services process to serve as the nickname for the specified subenclosure. The nickname is saved to non-volatile storage (e.g., a flash ROM) so it may be retrieved after future hard resets.

The Subenclosure Nickname Control diagnostic page is written by the SEND DIAGNOSTIC command. A RECEIVE DIAGNOSTIC RESULTS command with a PCV bit set to one and a page code field set to 0Fh is defined as the request to read the Subenclosure Nickname Status diagnostic page (see 6.1.21).

Table 52 describes the Subenclosure Nickname Control diagnostic page.

**Table 52 — Subenclosure Nickname Control diagnostic page**

Byte\Bit	7	6	5	4	3	2	1	0
0	PAGE CODE (0Fh)							
1	SUBENCLOSURE IDENTIFIER							
2	(MSB)	PAGE LENGTH (24h)						(LSB)
3								
4	(MSB)	GENERATION CODE						(LSB)
7								
8	SUBENCLOSURE NICKNAME							
39								

The PAGE CODE field is set to 0Fh.

The SUBENCLOSURE IDENTIFIER field specifies the vendor-specific identifier for the subenclosure to which the application client is sending the subenclosure nickname. If the SUBENCLOSURE IDENTIFIER value does not match a SUBENCLOSURE IDENTIFIER value found in the Configuration diagnostic page (see 6.1.2), the enclosure services process shall set the SUBENCLOSURE NICKNAME STATUS field to 80h in the Subenclosure Nickname Status diagnostic page.

The PAGE LENGTH field specifies the length in bytes of the remainder of the diagnostic page. If the PAGE LENGTH field value does not match the length of the page, the enclosure services process shall not change the subenclosure nickname and set the SUBENCLOSURE NICKNAME MICROCODE STATUS field to 80h in the Subenclosure Nickname Status diagnostic page.



The GENERATION CODE field specifies the value expected to be found in the GENERATION CODE field of the Configuration diagnostic page (see 6.1.2). ~~To prevent the misinterpretation of the microcode data,~~ the enclosure services process shall verify that the value of the GENERATION CODE field matches the generation code value known by the enclosure services process. If there is a mismatch, the enclosure services process shall not change the subenclosure nickname and set the SUBENCLOSURE NICKNAME MICROCODE STATUS field to 80h in the Subenclosure Nickname Status diagnostic page.

The SUBENCLOSURE NICKNAME field specifies the subenclosure nickname. If a Language element (see 7.3.18) is present, the SUBENCLOSURE NICKNAME field shall contain a text string (see 3.1.31) with characters using the language and character set indicated by the Language element and the enclosure services process shall store the language code value indicated by the Language element along with the subenclosure nickname. If a Language element is not available, the SUBENCLOSURE NICKNAME field shall contain an ASCII string (see 3.1.2)

Author: ibm-gop  
Subject: Highlight  
Date: 12/13/2007 8:24:47 PM -06'00'

**T 6.1.19 Download Microcode Status diagnostic page (last paragraph)**

This << it shall set the SUBENCLOSURE DOWNLOAD MICROCODE EXPECTED BUFFER OFFSET field to FFFFFFFFh. >> should be << it shall set the SUBENCLOSURE DOWNLOAD MICROCODE EXPECTED BUFFER OFFSET field to FFFF\_FFFFh. >>

Status  
relliott Rejected 12/20/2007 8:20:28 PM -06'00'

Author: relliott  
Subject: Note  
Date: 12/20/2007 8:02:57 PM -06'00'  
eight Fs is still readable; I prefer to break between 8.

Author: ibm-gop  
Subject: Highlight  
Date: 12/13/2007 8:24:47 PM -06'00'

**T 6.1.20 Subenclosure Nickname Control diagnostic page (2nd paragraph)**

The term << page code >> should be in small caps as it is a field name.

Status  
relliott Accepted 12/13/2007 9:43:35 PM -06'00'

Status  
relliott Confirmed 12/13/2007 9:43:38 PM -06'00'

Author: relliott  
Subject: Highlight  
Date: 5/12/2008 3:36:09 PM

**T** describes the  
s/b  
defines the

Status  
relliott Accepted 1/5/2008 6:18:05 PM -06'00'

Author: relliott  
Subject: Highlight  
Date: 5/12/2008 3:36:09 PM

**T** 24h  
s/b  
0024h

Status  
relliott Accepted 12/16/2007 6:28:53 PM -06'00'

Status  
relliott Confirmed 12/16/2007 6:28:49 PM -06'00'

Author: relliott  
Subject: Highlight  
Date: 5/12/2008 3:36:09 PM

**T** specifies the vendor-specific identifier for the subenclosure  
s/b  
specifies the subenclosure

Status  
relliott Accepted 12/17/2007 1:55:32 PM -06'00'

Status  
relliott Confirmed 12/17/2007 1:55:35 PM -06'00'

Author: relliott  
Subject: Highlight  
Date: 5/12/2008 3:36:09 PM

**T** the length in bytes of the remainder of the diagnostic page.  
s/b  
the number of bytes that follow in the diagnostic page

If the enclosure services process accepts multiple BUFFER ID field values concurrently, it shall set the SUBENCLOSURE DOWNLOAD MICROCODE EXPECTED BUFFER ID field to FFh.

The SUBENCLOSURE DOWNLOAD MICROCODE EXPECTED BUFFER OFFSET field indicates the next value that the enclosure services process expects in the BUFFER OFFSET field in the Download Microcode Control diagnostic page. If the enclosure services process accepts arbitrary BUFFER OFFSET field values, it shall set the SUBENCLOSURE DOWNLOAD MICROCODE EXPECTED BUFFER OFFSET field to FFFFFFFFh.

**6.1.20 Subenclosure Nickname Control diagnostic page**

The Subenclosure Nickname Control diagnostic page transmits a text string (see 3.1.31) to the enclosure services process to serve as the nickname for the specified subenclosure. The nickname is saved to non-volatile storage (e.g., a flash ROM) so it may be retrieved after future hard resets.

The Subenclosure Nickname Control diagnostic page is written by the SEND DIAGNOSTIC command. A RECEIVE DIAGNOSTIC RESULTS command with a PCV bit set to one and a page code field set to 0Fh is defined as the request to read the Subenclosure Nickname Status diagnostic page (see 6.1.21).

Table 52 describes the Subenclosure Nickname Control diagnostic page.

**Table 52 — Subenclosure Nickname Control diagnostic page**

Byte\Bit	7	6	5	4	3	2	1	0
0	PAGE CODE (0Fh)							
1	SUBENCLOSURE IDENTIFIER							
2	(MSB)	PAGE LENGTH (24h)						(LSB)
3								
4	(MSB)	GENERATION CODE						(LSB)
7								
8	SUBENCLOSURE NICKNAME							
39								

The PAGE CODE field is set to 0Fh.

The SUBENCLOSURE IDENTIFIER field specifies the vendor-specific identifier for the subenclosure to which the application client is sending the subenclosure nickname. If the SUBENCLOSURE IDENTIFIER value does not match a SUBENCLOSURE IDENTIFIER value found in the Configuration diagnostic page (see 6.1.2), the enclosure services process shall set the SUBENCLOSURE NICKNAME STATUS field to 80h in the Subenclosure Nickname Status diagnostic page.

The PAGE LENGTH field specifies the length in bytes of the remainder of the diagnostic page. If the PAGE LENGTH field value does not match the length of the page, the enclosure services process shall not change the subenclosure nickname and set the SUBENCLOSURE NICKNAME MICROCODE STATUS field to 80h in the Subenclosure Nickname Status diagnostic page.

The GENERATION CODE field specifies the value expected to be found in the GENERATION CODE field of the Configuration diagnostic page (see 6.1.2). ~~To prevent the misinterpretation of the microcode data,~~ the enclosure services process shall verify that the value of the GENERATION CODE field matches the generation code value known by the enclosure services process. If there is a mismatch, the enclosure services process shall not change the subenclosure nickname and set the SUBENCLOSURE NICKNAME MICROCODE STATUS field to 80h in the Subenclosure Nickname Status diagnostic page.

The SUBENCLOSURE NICKNAME field specifies the subenclosure nickname. If a Language element (see 7.3.18) is present, the SUBENCLOSURE NICKNAME field shall contain a text string (see 3.1.31) with characters using the language and character set indicated by the Language element and the enclosure services process shall store the language code value indicated by the Language element along with the subenclosure nickname. If a Language element is not available, the SUBENCLOSURE NICKNAME field shall contain an ASCII string (see 3.1.2)

Status  
relliott Accepted 12/19/2007 7:16:03 PM -06'00'  
Status  
relliott Confirmed 12/19/2007 7:15:31 PM -06'00'

---

Author: relliott  
Subject: Note  
Date: 5/12/2008 3:36:09 PM

 Change GENERATION CODE to EXPECTED GENERATION CODE and change paragraph to:  
The expected generation code field is defined in the Enclosure Control diagnostic page (see 6.1.3).

keeping the additional mismatch sentence

Status  
relliott Accepted 1/3/2008 2:58:15 PM -06'00'

---

Author: ibm-gop  
Subject: Cross-Out  
Date: 12/13/2007 8:24:47 PM -06'00'

 **6.1.20 Subenclosure Nickname Control diagnostic page (4th paragraph after table 52)**

**This << To prevent the misinterpretation of the microcode data, >> should be deleted as it contains a justification for the required action. Standards should not justify requirements.**

Status  
relliott Accepted 12/20/2007 8:18:52 PM -06'00'

---

and the enclosure services process shall store the language code value of 0000h along with the subenclosure nickname.

**6.1.21 Subenclosure Nickname Status diagnostic page**

The Subenclosure Nickname Status diagnostic page transmits the nickname of each subenclosure to the application client.

The transmission of a page using the SEND DIAGNOSTIC command with a PAGE CODE field set to 0Fh is defined as the transmission of a Subenclosure Nickname Control diagnostic page (see 6.1.20).

Table 53 describes the Subenclosure Nickname Status diagnostic page.

**Table 53 — Subenclosure Nickname Status diagnostic page**

Byte\Bit	7	6	5	4	3	2	1	0
0	PAGE CODE (0Fh)							
1	NUMBER OF SUBENCLOSURES							
2	(MSB)	PAGE LENGTH (n - 3)						(LSB)
3								
4	(MSB)	GENERATION CODE						(LSB)
7								
Subenclosure nickname status descriptor list								
8	Subenclosure nickname status descriptor (primary subenclosure)(see table 54)							
47								
...								
n - 39	Subenclosure nickname status descriptor (last subenclosure)(see table 54)							
n								

The PAGE CODE field is set to 0Fh.

The NUMBER OF SUBENCLOSURES field indicates the number of separate subenclosure nickname status descriptor values that are included, not including the primary subenclosure. The NUMBER OF SUBENCLOSURES value shall be the same as the number of subenclosures value in the Configuration diagnostic page.

The PAGE LENGTH field indicates the length in bytes of the remainder of the diagnostic page.

The GENERATION CODE field contains the same value as the GENERATION CODE field in the Configuration diagnostic page (see 6.1.2).



● Author: relliott  
Subject: Highlight  
Date: 5/12/2008 3:36:09 PM

 describes the  
s/b  
defines the

Status  
relliott Accepted 1/5/2008 6:18:29 PM -06'00'

---

● Author: relliott  
Subject: Highlight  
Date: 5/12/2008 3:36:09 PM

 the length in bytes of the remainder of the diagnostic page  
s/b  
the number of bytes that follow in the diagnostic page

Status  
relliott Accepted 12/19/2007 7:16:36 PM -06'00'  
Status  
relliott Confirmed 12/19/2007 7:16:30 PM -06'00'

---

● Author: relliott  
Subject: Note  
Date: 5/12/2008 3:36:09 PM

 Change generation code paragraph to:  
The generation code field indicates the value of the generation code (see 4.6.2).

Status  
relliott Accepted 1/3/2008 12:38:30 PM -06'00'

---



Table 54 describes the format of each subenclosure's enclosure nickname status descriptor. The first subenclosure nickname status descriptor shall be for the primary subenclosure; subenclosure nickname status descriptors for the remaining subenclosures may follow in any order

**Table 54 — Subenclosure nickname status descriptor format**

Byte\Bit	7	6	5	4	3	2	1	0	
0	Reserved								
1	SUBENCLOSURE IDENTIFIER								
2	SUBENCLOSURE ENCLOSURE NICKNAME STATUS								
3	SUBENCLOSURE ENCLOSURE NICKNAME ADDITIONAL STATUS								
4	Reserved								
5	Reserved								
6	(MSB)	SUBENCLOSURE NICKNAME LANGUAGE CODE						(LSB)	
7	SUBENCLOSURE NICKNAME LANGUAGE CODE								
8	SUBENCLOSURE NICKNAME								
39	SUBENCLOSURE NICKNAME								

The SUBENCLOSURE IDENTIFIER field indicates the subenclosure identifier to which the subenclosure nickname status descriptor applies.

The SUBENCLOSURE NICKNAME STATUS field indicates the status of nickname operations for the subenclosure and is defined in table 55. After reporting a non-zero value, the enclosure services process shall set the SUBENCLOSURE NICKNAME STATUS field to 00h and shall set the SUBENCLOSURE NICKNAME ADDITIONAL STATUS field to 00h.

**Table 55 — SUBENCLOSURE NICKNAME STATUS field**

Code	Description
00h	No errors
80h	Error in one or more of the Subenclosure Nickname Control diagnostic page fields. The SUBENCLOSURE NICKNAME ADDITIONAL STATUS field shall be set to the offset of the lowest byte of whichever field in the Subenclosure Nickname Control diagnostic page which is in error.
81h	Internal error; nickname is lost.
82h	Internal error; previous nickname preserved.
All others	Reserved

The SUBENCLOSURE NICKNAME ADDITIONAL STATUS field provides additional status for certain values of the SUBENCLOSURE NICKNAME STATUS field as described in table 55.

The SUBENCLOSURE NICKNAME LANGUAGE CODE field indicates the language and character set of the subenclosure nickname, as defined by the LANGUAGE CODE field in the Language element (see 7.3.18).

The SUBENCLOSURE NICKNAME field indicates the subenclosure nickname.

## 6.2 Log parameters for enclosure services devices

This subclause describes descriptors and pages for log parameters used with enclosure services devices.

Author: relliott  
Subject: Highlight  
Date: 5/12/2008 3:36:09 PM

 describes the  
s/b  
defines the

Status  
relliott Accepted 1/5/2008 6:18:57 PM -06'00'

Author: ibm-gop  
Subject: Highlight  
Date: 12/13/2007 8:24:47 PM -06'00'

 6.1.21 Subenclosure Nickname Status diagnostic page (1st paragraph before table 54)

**This << shall be for the primary subenclosure; subenclosure nickname status descriptors for the remaining subenclosures may follow in any order >> should be << shall be for the primary subenclosure. Subenclosure nickname status descriptors for the remaining subenclosures may follow in any order >> should be. >> Note that there is also a missing period at the end of this sentence.**

Status  
relliott Accepted 12/21/2007 5:34:29 PM -06'00'

Author: relliott  
Subject: Highlight  
Date: 5/12/2008 3:36:09 PM

 indicates the subenclosure identifier  
s/b  
indicates the subenclosure

Status  
relliott Accepted 12/17/2007 1:52:48 PM -06'00'

Status  
relliott Confirmed 12/17/2007 1:52:50 PM -06'00'

Author: relliott  
Subject: Note  
Date: 5/12/2008 3:36:09 PM

 fix formatting (indent) of this paragraph

Status  
relliott Accepted 12/21/2007 5:39:40 PM -06'00'

Author: ibm-gop  
Subject: Highlight  
Date: 12/13/2007 8:24:47 PM -06'00'

 6.1.21 Subenclosure Nickname Status diagnostic page (2nd row in table 55)

**This << of whichever field in the Subenclosure Nickname Control diagnostic page which is in error. >> should be << of the field in the Subenclosure Nickname Control diagnostic page which is in error. >>**

Status  
relliott Accepted 12/21/2007 5:33:51 PM -06'00'

Author: relliott  
Subject: Note  
Date: 12/21/2007 5:33:52 PM -06'00'

 the field...that has an error

Author: ibm-gop  
Subject: Highlight  
Date: 12/13/2007 8:24:47 PM -06'00'

 6.1.21 Subenclosure Nickname Status diagnostic page (3rd row in table 55)

**This << Internal error; nickname is lost. >> should be << Nickname is lost internal error. >>**

Status  
relliott Accepted 12/21/2007 5:39:31 PM -06'00'

Table 54 describes the format of each subenclosure's enclosure nickname status descriptor. The first subenclosure nickname status descriptor shall be for the primary subenclosure; subenclosure nickname status descriptors for the remaining subenclosures may follow in any order

**Table 54 — Subenclosure nickname status descriptor format**

Byte\Bit	7	6	5	4	3	2	1	0	
0	Reserved								
1	SUBENCLOSURE IDENTIFIER								
2	SUBENCLOSURE ENCLOSURE NICKNAME STATUS								
3	SUBENCLOSURE ENCLOSURE NICKNAME ADDITIONAL STATUS								
4	Reserved								
5	Reserved								
6	(MSB)	SUBENCLOSURE NICKNAME LANGUAGE CODE						(LSB)	
7	SUBENCLOSURE NICKNAME LANGUAGE CODE								
8	SUBENCLOSURE NICKNAME								
39	SUBENCLOSURE NICKNAME								

The SUBENCLOSURE IDENTIFIER field indicates the subenclosure identifier to which the subenclosure nickname status descriptor applies.

The SUBENCLOSURE NICKNAME STATUS field indicates the status of nickname operations for the subenclosure and is defined in table 55. After reporting a non-zero value, the enclosure services process shall set the SUBENCLOSURE NICKNAME STATUS field to 00h and shall set the SUBENCLOSURE NICKNAME ADDITIONAL STATUS field to 00h.

**Table 55 — SUBENCLOSURE NICKNAME STATUS field**

Code	Description
00h	No errors
80h	Error in one or more of the Subenclosure Nickname Control diagnostic page fields. The SUBENCLOSURE NICKNAME ADDITIONAL STATUS field shall be set to the offset of the lowest byte of whichever field in the Subenclosure Nickname Control diagnostic page which is in error.
81h	Internal error; nickname is lost.
82h	Internal error; previous nickname preserved.
All others	Reserved

The SUBENCLOSURE NICKNAME ADDITIONAL STATUS field provides additional status for certain values of the SUBENCLOSURE NICKNAME STATUS field as described in table 55.

The SUBENCLOSURE NICKNAME LANGUAGE CODE field indicates the language and character set of the subenclosure nickname, as defined by the LANGUAGE CODE field in the Language element (see 7.3.18).

The SUBENCLOSURE NICKNAME field indicates the subenclosure nickname.

## 6.2 Log parameters for enclosure services devices

This subclause describes descriptors and pages for log parameters used with enclosure services devices.

Author: ibm-gop  
Subject: Highlight

Date: 12/13/2007 8:24:47 PM -06'00'

**T** 6.1.21 Subenclosure Nickname Status diagnostic page (4th row in table 55)

This << Internal error; previous nickname preserved. >> should be << Previous nickname preserved internal error. >>

Status

relliott Accepted 12/21/2007 5:39:36 PM -06'00'

---

Table 56 defines the log page codes for enclosure services devices.

**Table 56 — Log page codes for enclosure services devices**

Page code	Description	Reference
00h	Supported Log Pages log page	SPC-4
06h	Non-Medium Error log page	SPC-4
07h	Last n Error Events log page	SPC-4
0Bh	Last n Deferred Error Events log page	SPC-4
0Dh	Temperature log page	SPC-4
0Eh	Start-Stop Cycles log page	SPC-4
0Fh	Application Client log page	SPC-4
10h	Self-Test Results log page	SPC-4
2Fh	Informational Exceptions log page	SPC-4
30h - 3Fh	Vendor specific	
All others	Reserved	

## 6.3 Mode parameters for enclosure services devices

### 6.3.1 Mode parameters overview

This subclause describes descriptors and pages for mode parameters used with enclosure services devices.

The mode parameter list, including the mode parameter header and mode block descriptor are described in SPC-4.

The MEDIUM TYPE field is contained in the mode parameter header (see SPC-4). For enclosure services devices, the MEDIUM TYPE field is reserved.

The DEVICE SPECIFIC PARAMETER field is contained in the mode parameter header (see SPC-4). For enclosure services devices, the DEVICE SPECIFIC PARAMETER field is reserved.

The BLOCK DESCRIPTOR LENGTH field is contained in the mode parameter header (see SPC-4). Enclosure services devices have no BLOCK DESCRIPTOR field. For enclosure services devices, the BLOCK DESCRIPTOR LENGTH shall be zero.

Table 57 defines the mode page codes for enclosure services devices

**Table 57 — Mode page codes for enclosure services devices**

Page code	Description	Reference
00h	Vendor specific	
02h	Disconnect-Reconnect mode page	SPC-4
09h	Obsolete	
0Ah	Control mode page	SPC-4
14h	Enclosure Services Management mode page	6.3.2
18h	Protocol Specific LUN mode page	SPC-4
19h	Protocol Specific Port mode page	SPC-4
1Ch	Informational Exceptions Control mode page	SPC-4
20h - 3Eh	Vendor specific	
All others	Reserved	



# Page: 60

---

Author: hpq-relliott  
Subject: Note  
Date: 12/13/2007 8:24:34 PM -06'00'  
 Update log page list to match SPC-4 (include log page subpage codes)

Status  
relliott Accepted 12/17/2007 8:03:39 PM -06'00'  
Status  
relliott Confirmed 12/17/2007 8:03:42 PM -06'00'

---

Author: relliott  
Subject: Note  
Date: 1/3/2008 7:39:50 PM -06'00'  
 Deferred Error Events s/b Deferred Error or Asynchronous Events  
 Stop Cycles s/b Stop Cycle Count

add subpage code column with 00h for each existing row

Add:  
00h/FFh is Supported Log Pages and Subpages  
01h-3Eh/FFh is Supported Subpages (SPC-4 is conflicted about 30h-3Eh/FFh; this assumes that the standardized definition wins)  
18h/00h - 3Eh Protocol Specific Port log pages (based on 07-215r0, accepted into SPC-4 but waiting for spc4r12)

---

Author: ibm-gop  
Subject: Highlight  
Date: 12/13/2007 8:24:47 PM -06'00'  
 **6.3.1 Mode parameters overview (5th paragraph)**

**This << the BLOCK DESCRIPTOR  
LENGTH shall be zero. >> should be << the BLOCK DESCRIPTOR  
LENGTH shall be set to zero. >>**

Status  
relliott Accepted 12/13/2007 11:02:51 PM -06'00'  
Status  
relliott Confirmed 12/13/2007 11:02:54 PM -06'00'

---



Author: relliott  
Subject: Note  
Date: 12/13/2007 11:02:49 PM -06'00'  
 included field too

---

Author: hpq-relliott  
Subject: Note  
Date: 12/13/2007 8:24:34 PM -06'00'  
 Update mode page list to match SPC-4 (include subpages)

Status  
relliott Accepted 12/17/2007 8:45:13 PM -06'00'  
Status  
relliott Confirmed 12/17/2007 8:45:16 PM -06'00'

---

Author: relliott  
Subject: Note  
Date: 12/17/2007 8:45:01 PM -06'00'  
 Add 0Ah/01h Control Extension  
 Change Specific LUN to Specific Logical Unit  
Add 18h/01h - FEh See SCSI transport protocol standard  
Add 19h/01h - FEh See SCSI transport protocol standard  
Add 3Fh/00h Return all pages (MODE SENSE footnote)  
Add 3Fh/FFh Return all pages and subpages (MODE SENSE footnote)  
Add 00h-3Fh/FFh Return all subpages (MODE SENSE footnote)  
Add 1,3-8,A, B-14, 1B,1D-1F, 20-3E Reserved for this standard

Comments from page 60 continued on next page

Table 56 defines the log page codes for enclosure services devices.

**Table 56 — Log page codes for enclosure services devices**

Page code	Description	Reference
00h	Supported Log Pages log page	SPC-4
06h	Non-Medium Error log page	SPC-4
07h	Last n Error Events log page	SPC-4
0Bh	Last n Deferred Error Events log page	SPC-4
0Dh	Temperature log page	SPC-4
0Eh	Start-Stop Cycles log page	SPC-4
0Fh	Application Client log page	SPC-4
10h	Self-Test Results log page	SPC-4
2Fh	Informational Exceptions log page	SPC-4
30h - 3Fh	Vendor specific	
All others	Reserved	

## 6.3 Mode parameters for enclosure services devices

### 6.3.1 Mode parameters overview

This subclause describes descriptors and pages for mode parameters used with enclosure services devices.

The mode parameter list, including the mode parameter header and mode block descriptor are described in SPC-4.

The MEDIUM TYPE field is contained in the mode parameter header (see SPC-4). For enclosure services devices, the MEDIUM TYPE field is reserved.

The DEVICE SPECIFIC PARAMETER field is contained in the mode parameter header (see SPC-4). For enclosure services devices, the DEVICE SPECIFIC PARAMETER field is reserved.

The BLOCK DESCRIPTOR LENGTH field is contained in the mode parameter header (see SPC-4). Enclosure services devices have no BLOCK DESCRIPTOR field. For enclosure services devices, the BLOCK DESCRIPTOR LENGTH shall be zero.

Table 57 defines the mode page codes for enclosure services devices.

**Table 57 — Mode page codes for enclosure services devices**

Page code	Description	Reference
00h	Vendor specific	
02h	Disconnect-Reconnect mode page	SPC-4
09h	Obsolete	
0Ah	Control mode page	SPC-4
14h	Enclosure Services Management mode page	6.3.2
18h	Protocol Specific LUN mode page	SPC-4
19h	Protocol Specific Port mode page	SPC-4
1Ch	Informational Exceptions Control mode page	SPC-4
20h - 3Eh	Vendor specific	
All others	Reserved	

Change "Reserved" to "Reserved for SPC-4" (could be "Restricted for SPC-4" too)

---



### 6.3.2 Enclosure Services Management mode page

The optional Enclosure Services Management mode page provides controls over those features involving communication with an enclosure services process. If the Enclosure Services Management mode page is not implemented, the device server shall not implement the timed completion function.

When a RECEIVE DIAGNOSTIC RESULTS command is received by a device server that supports enclosure services and the ENBLTC bit has been set to one, the device server may wait up to the time contained in the MAXIMUM TASK COMPLETION TIME field before returning the requested diagnostic page. The device server shall only perform this delay operation for Enclosure Status diagnostic pages (see 6.1.4). If a noncritical, critical, or unrecoverable condition exists or occurs during the waiting period, the device server shall report the event by returning the requested status page as soon as possible.

Table 58 defines the Enclosure Services Management mode page.

**Table 58 — Enclosure Services Management mode page**

Byte/Bit	7	6	5	4	3	2	1	0	
0	PS	Reserved	PAGE CODE (14h)						
1	PAGE LENGTH (06h)								
2	Reserved								
4	Reserved								
5	Reserved							ENBLTC	
6	(MSB)	MAXIMUM TASK COMPLETION TIME							
7								(LSB)	

The PS (parameters savable) bit is defined in SPC-4. For enclosure services devices, the PS bit is not restricted.

The PAGE CODE field is defined in SPC-4. The PAGE CODE field shall have a value of 14h for this mode page.

The PAGE LENGTH field is defined in SPC-4. The PAGE LENGTH field shall have a value of 06h for this mode page.

The ENBLTC (enable timed completion) bit specifies whether the timed completion function (see 4.6.3) shall be enabled or disabled. An ENBLTC bit set to one specifies that the device server shall enable the timed completion function. An ENBLTC bit set to zero specifies that the device server shall disable the timed completion function.

The MAXIMUM TASK COMPLETION TIME field specifies the maximum time that a device server may choose to wait before returning a diagnostic page. The timing of the wait period shall begin when the transmission of RECEIVE DIAGNOSTIC RESULTS command to the device server is complete and end with the transfer of the Enclosure Status diagnostic page and the transfer of completion status. In establishing the value for the MAXIMUM TASK COMPLETION TIME field, the application client should consider any time periods that are not controlled by the device server, including reconnection overheads, congestion latency, and protocol timeouts. The value is specified in 100 ms units. A value of zero specifies a vendor-specific maximum time, which may be infinite.



Author: ibm-gop  
Subject: Cross-Out  
Date: 12/13/2007 8:24:47 PM -06'00'

## 6.3.2 Enclosure Services Management mode page (1st paragraph)

This << optional >> should be deleted as everything is optional unless otherwise stated.

Status  
relliott Accepted 12/17/2007 3:35:23 PM -06'00'  
Status  
relliott Confirmed 12/17/2007 3:35:26 PM -06'00'

---

Author: ibm-gop  
Subject: Highlight  
Date: 12/13/2007 8:24:47 PM -06'00'

## 6.3.2 Enclosure Services Management mode page (1st paragraph)

This << the device server shall not implement the timed completion function. >> should be << the device server shall not implement the timed completion function (see x.x.x). >>

Status  
relliott Accepted 12/15/2007 5:28:11 PM -06'00'  
Status  
relliott Confirmed 12/15/2007 5:28:09 PM -06'00'

---

Author: ibm-gop  
Subject: Highlight  
Date: 12/13/2007 8:24:47 PM -06'00'

## 6.3.2 Enclosure Services Management mode page (2nd paragraph)

This << shall report the event by returning the requested status page as soon as possible >> should be << shall report the event by returning the requested status page. >> The statement << as soon as possible >> is not valid as it is not a quantifiable amount of time.

Status  
relliott Rejected 1/3/2008 5:46:34 PM -06'00'

---

Author: relliott  
Subject: Note  
Date: 1/3/2008 5:46:31 PM -06'00'

 the point is that it not wait at all, not even up to the Maximum Task Completion Time.

"device server shall stop waiting and return the requested diagnostic page."

---

Author: hpq-relliott  
Subject: Note  
Date: 12/13/2007 8:24:34 PM -06'00'

 Add SPF bit

Status  
relliott Accepted 12/13/2007 10:50:48 PM -06'00'  
Status  
relliott Confirmed 12/13/2007 10:50:52 PM -06'00'

---

Author: relliott  
Subject: Highlight  
Date: 5/12/2008 3:36:09 PM

 shall have a value of 14h  
s/b  
is set to 14h

and join the two sentences

Status  
relliott Accepted 12/13/2007 10:51:10 PM -06'00'  
Status  
relliott Confirmed 12/13/2007 10:51:07 PM -06'00'

### 6.3.2 Enclosure Services Management mode page

The ~~optional~~ Enclosure Services Management mode page provides controls over those features involving communication with an enclosure services process. If the Enclosure Services Management mode page is not implemented, **the device server shall not implement the timed completion function.**

When a RECEIVE DIAGNOSTIC RESULTS command is received by a device server that supports enclosure services and the ENBLTC bit has been set to one, the device server may wait up to the time contained in the MAXIMUM TASK COMPLETION TIME field before returning the requested diagnostic page. The device server shall only perform this delay operation for Enclosure Status diagnostic pages (see 6.1.4). If a noncritical, critical, or unrecoverable condition exists or occurs during the waiting period, the device server **shall report the event by returning the requested status page as soon as possible.**

Table 58 defines the Enclosure Services Management mode page.

**Table 58 — Enclosure Services Management mode page**

Byte\Bit	7	6	5	4	3	2	1	0	
0	PS	Reserved	PAGE CODE (14h)						
1	PAGE LENGTH (06h)								
2	Reserved								
4	Reserved								
5	Reserved							ENBLTC	
6	(MSB)	MAXIMUM TASK COMPLETION TIME							
7								(LSB)	

The PS (parameters savable) bit is defined in SPC-4. For enclosure services devices, the PS bit is not restricted.

The PAGE CODE field is defined in SPC-4. The PAGE CODE field **shall have a value of 14h** for this mode page.

The PAGE LENGTH field is defined in SPC-4. The PAGE LENGTH field **shall have a value of 06h** for this mode page.

The ENBLTC (enable timed completion) bit specifies whether the timed completion function (see 4.6.3) shall be enabled or disabled. An ENBLTC bit set to one specifies that the **device server shall enable the timed completion function.** An ENBLTC bit set to zero specifies that the device server shall disable the timed completion function.

The MAXIMUM TASK COMPLETION TIME field specifies the maximum time that **a device server** may choose to wait before returning a diagnostic page. The timing of the wait period shall begin when the transmission of RECEIVE DIAGNOSTIC RESULTS command to the device server is complete and end with the transfer of the Enclosure Status diagnostic page and the transfer of completion status. In establishing the value for the MAXIMUM TASK COMPLETION TIME field, **the application client should consider any time periods that are not controlled by the device server, including reconnection overheads, congestion latency, and protocol timeouts.** The value is specified in **100 ms units.** A value of zero specifies a vendor-specific maximum time, which may be infinite.



---

Author: relliott  
Subject: Highlight  
Date: 5/12/2008 3:36:09 PM  
T shall have a value of 06h  
s/b  
is set to 06h

and join the two sentences

Status  
relliott Accepted 12/13/2007 10:51:21 PM -06'00'  
Status  
relliott Confirmed 12/13/2007 10:51:37 PM -06'00'

---

Author: ibm-gop  
Subject: Highlight  
Date: 12/13/2007 8:24:47 PM -06'00'  
T 6.3.2 Enclosure Services Management mode page (4th paragraph after table 58)

**This << device server shall enable the timed completion function. >> should be << device server shall enable the timed completion function (see x.x.x). >>**

Status  
relliott Accepted 12/15/2007 5:30:44 PM -06'00'

---

Author: relliott  
Subject: Note  
Date: 12/15/2007 5:31:11 PM -06'00'  
that cross-reference is in the previous sentence. Deleting the previous sentence altogether, and moving (enable timed completion) into this sentence.

---

Author: relliott  
Subject: Highlight  
Date: 5/12/2008 3:36:09 PM  
T a device server  
s/b  
the device server

Status  
relliott Accepted 12/15/2007 5:07:39 PM -06'00'  
Status  
relliott Confirmed 12/15/2007 5:07:42 PM -06'00'

---

Author: ibm-gop  
Subject: Highlight  
Date: 12/13/2007 8:24:47 PM -06'00'  
T 6.3.2 Enclosure Services Management mode page (5th paragraph after table 58)

**This << the application client should consider any time periods that are not controlled by the device server, including reconnection overheads, congestion latency, and protocol timeouts. >> should be << the application client should consider any time periods that are not controlled by the device server (e.g., reconnection overheads, congestion latency, and protocol timeouts). >>**

Status  
relliott Accepted 12/15/2007 5:31:48 PM -06'00'  
Status  
relliott Confirmed 12/15/2007 5:31:53 PM -06'00'

---

Author: relliott  
Subject: Highlight  
Date: 5/12/2008 3:36:09 PM  
T 100 ms  
s/b  
100 millisecond

to avoid adding the abbreviation to chapter 3

Status  
relliott Accepted 12/17/2007 8:50:28 PM -06'00'  
Status  
relliott Confirmed 12/17/2007 8:50:32 PM -06'00'

---

Comments from page 61 continued on next page

### 6.3.2 Enclosure Services Management mode page

The ~~optional~~ Enclosure Services Management mode page provides controls over those features involving communication with an enclosure services process. If the Enclosure Services Management mode page is not implemented, **the device server shall not implement the timed completion function.**

When a RECEIVE DIAGNOSTIC RESULTS command is received by a device server that supports enclosure services and the ENBLTC bit has been set to one, the device server may wait up to the time contained in the MAXIMUM TASK COMPLETION TIME field before returning the requested diagnostic page. The device server shall only perform this delay operation for Enclosure Status diagnostic pages (see 6.1.4). If a noncritical, critical, or unrecoverable condition exists or occurs during the waiting period, the device server **shall report the event by returning the requested status page as soon as possible.**

Table 58 defines the Enclosure Services Management mode page.

**Table 58 — Enclosure Services Management mode page**

Byte/Bit	7	6	5	4	3	2	1	0	
0	PS	Reserved	PAGE CODE (14h)						
1	PAGE LENGTH (06h)								
2	Reserved								
4	Reserved								
5	Reserved							ENBLTC	
6	(MSB)	MAXIMUM TASK COMPLETION TIME							
7								(LSB)	

The PS (parameters savable) bit is defined in SPC-4. For enclosure services devices, the PS bit is not restricted.

The PAGE CODE field is defined in SPC-4. The PAGE CODE field **shall have a value of 14h** for this mode page.

The PAGE LENGTH field is defined in SPC-4. The PAGE LENGTH field **shall have a value of 06h** for this mode page.

The ENBLTC (enable timed completion) bit specifies whether the timed completion function (see 4.6.3) shall be enabled or disabled. An ENBLTC bit set to one specifies that the **device server shall enable the timed completion function.** An ENBLTC bit set to zero specifies that the device server shall disable the timed completion function.

The MAXIMUM TASK COMPLETION TIME field specifies the maximum time that **a device server** may choose to wait before returning a diagnostic page. The timing of the wait period shall begin when the transmission of RECEIVE DIAGNOSTIC RESULTS command to the device server is complete and end with the transfer of the Enclosure Status diagnostic page and the transfer of completion status. In establishing the value for the MAXIMUM TASK COMPLETION TIME field, **the application client should consider any time periods that are not controlled by the device server, including reconnection overheads, congestion latency, and protocol timeouts.** The value is specified in **100 ms** units. **A value of zero specifies a vendor-specific maximum time, which may be infinite.**

Author: ibm-gop  
Subject: Highlight  
Date: 12/13/2007 8:24:47 PM -06'00'

 6.3.2 Enclosure Services Management mode page (5th paragraph after table 58)

**This << A value of zero specifies a vendor-specific maximum time, which may >> should be << A value of zero specifies a vendor-specific maximum time. >>**

Status  
relliott Rejected 12/13/2007 9:48:50 PM -06'00'

Status  
relliott Confirmed 12/13/2007 9:48:54 PM -06'00'

---

Author: relliott  
Subject: Note  
Date: 12/13/2007 9:48:55 PM -06'00'

 (e.g., infinite)

---

Author: relliott  
Subject: Note  
Date: 5/12/2008 3:36:09 PM

 zero s/b 0000h

Status  
relliott Accepted 4/9/2008 6:41:29 PM

---

## 7 Element definitions

### 7.1 Element definitions overview

This clause contains the format definitions for the OVERALL CONTROL and ELEMENT CONTROL fields in the Enclosure Control diagnostic page (see 6.1.3) and the OVERALL STATUS and ELEMENT STATUS fields in Enclosure Status diagnostic page (see 6.1.4). **The field formats generally are different for different element** types and are described in 7.3. Field format definitions common to all element types and specific to different element types are described in 7.2.2 and 7.2.3.

The definition of the OVERALL THRESHOLD and ELEMENT THRESHOLD fields for the Threshold Out diagnostic page (see 6.1.8) and Threshold In diagnostic page (see 6.1.9) are defined in 7.3 for those elements supporting threshold values.

Author: ibm-gop  
Subject: Highlight  
Date: 12/13/2007 8:24:47 PM -06'00'

## **T 7.1 Element definitions overview (1st paragraph)**

**This << The field formats generally are different for different element >> should be << The field formats are different for different element >>**

Status  
relliott Rejected 12/19/2007 9:05:34 PM -06'00'

---

Author: relliott  
Subject: Note  
Date: 12/19/2007 9:05:34 PM -06'00'

 Field format definitions common to all element types are described in 7.2. Field format definitions that differ for different element types are described in 7.3.

---



Table 59 lists the elements and their ELEMENT TYPE codes, and indicates which elements accept the DISABLE bit in their COMMON CONTROL field (see 7.2.2) and may support the DISABLED bit in their COMMON STATUS field (see 7.2.3), and which elements contain a value subject to comparison with a threshold.

Table 59 — Element type codes

Type code	Type of element	Disable support	Threshold	Reference
00h	Unspecified	no	none	7.3.1
01h	Device	no	none	7.3.2
02h	Power Supply	no	none	7.3.4
03h	Cooling	no	none	7.3.5
04h	Temperature Sensor	yes	temperature	7.3.6
05h	Door Lock	no	none	7.3.7
06h	Audible Alarm	yes	none	7.3.8
07h	Enclosure Services Controller Electronics	no	none	7.3.9
08h	SCC Controller Electronics	no	none	7.3.10
09h	Nonvolatile Cache	no	none	7.3.11
0Ah	Invalid Operation Reason	no	none	7.3.12
0Bh	Uninterruptible Power Supply	no	battery status	7.3.13
0Ch	Display	no	none	7.3.14
0Dh	Key Pad Entry	no	none	7.3.15
0Eh	Enclosure	no	none	7.3.16
0Fh	SCSI Port/Transceiver	no	none	7.3.17
10h	Language	no	none	7.3.18
11h	Communication Port	no	none	7.3.19
12h	Voltage Sensor	yes	% voltage	7.3.20
13h	Current Sensor	yes	% current	7.3.21
14h	SCSI Target Port	no	none	7.3.22
15h	SCSI Initiator Port	no	none	7.3.23
16h	Simple Subenclosure	no	none	7.3.24
17h	Array Device	no	none	7.3.3
18h	SAS Expander	no	none	7.3.25
19h	SAS Connector	no	none	7.3.26
1Ah - 7Fh	Reserved			
80h - FFh	Vendor-specific			

## 7.2 Formats for status and control fields

### 7.2.1 Formats for status and control fields overview

~~7.2.2 and 7.2.3 specify the general format for the ELEMENT CONTROL and OVERALL CONTROL fields (i.e., control fields) in the Enclosure Control diagnostic page (see 6.1.3) and for the ELEMENT STATUS and OVERALL STATUS fields (i.e., status fields) in the Enclosure Status diagnostic page (see 6.1.4).~~

Author: ibm-gop  
Subject: Highlight  
Date: 12/13/2007 8:24:47 PM -06'00'

**T 7.1 Element definitions overview (1st paragraph before table 59)**

This << Table 59 lists the elements and their ELEMENT TYPE codes, and indicates which elements accept the DISABLE bit in their COMMON CONTROL field (see 7.2.2) and may support the DISABLED bit in their COMMON STATUS field (see 7.2.3), and which elements contain a value subject to comparison with a threshold. >> is nearly impossible to parse as it has 4 ands. It should be converted into an a,b,c list.

Status  
relliott Accepted 12/19/2007 9:01:58 PM -06'00'

---

Author: relliott  
Subject: Highlight  
Date: 5/12/2008 3:36:09 PM

**T** Disable  
support  
s/b  
DISABLE bit support

Status  
relliott Accepted 12/19/2007 9:02:09 PM -06'00'

---

Author: relliott  
Subject: Highlight  
Date: 5/12/2008 3:36:09 PM

**T** Type of element  
should be left justified

Status  
relliott Accepted 12/19/2007 9:02:53 PM -06'00'

---

Author: relliott  
Subject: Cross-Out  
Date: 5/12/2008 3:36:09 PM

**T** This is unnecessary

7.2.2 and 7.2.3 specify the general format for the ELEMENT CONTROL and OVERALL CONTROL fields (i.e., control fields) in the Enclosure Control diagnostic page (see 6.1.3) and for the ELEMENT STATUS and OVERALL STATUS fields (i.e., status fields) in the Enclosure Status diagnostic page (see 6.1.4).

Status  
relliott Accepted 12/21/2007 5:25:23 PM -06'00'

---

~~Unless otherwise specified, all status and control bits are optional. The enclosure is not required to return any optional status bit to the application client. The enclosure is not required to act on any optional control bit. All control bits are advisory and may be ignored or overridden to maintain a proper operating environment in the enclosure.~~

**7.2.2 Format for all control fields**

The format for the ELEMENT CONTROL and OVERALL CONTROL fields (i.e., control field) for all element types is shown in table 60.

**Table 60 — ELEMENT CONTROL and OVERALL CONTROL fields**

Byte\Bit	7	6	5	4	3	2	1	0
0	COMMON CONTROL							
	SELECT	PRDFAIL	DISABLE	RST SWAP	Reserved			
1	Element-type-specific control information							
3								

The COMMON CONTROL field contains those bits that may be used by any OVERALL CONTROL or ELEMENT CONTROL field. The bits of the COMMON CONTROL field (i.e., the SELECT bit, the PRDFAIL bit, the DISABLE bit, and the RST SWAP bit) are defined below.

A SELECT bit set to one specifies that the enclosure services process should perform the control functions defined by the other bits in the OVERALL CONTROL or ELEMENT CONTROL field. A SELECT bit set to zero specifies that the enclosure services process shall ignore all other bits in the OVERALL CONTROL or ELEMENT CONTROL field. The SELECT bit allows specific individual elements to be selected for control operations.

A PRDFAIL (predicted failure) bit set to one specifies that the enclosure services process turn on the “predicted failure state” indicator for the element. A PRDFAIL bit set to zero specifies that the enclosure services process turn off the “predicted failure state” indicator for the element. The element is not required to implement the PRDFAIL bit or the “predicted failure state” indicator.

A DISABLE bit set to one specifies that the enclosure services process disable the element. A DISABLE bit set to zero specifies that the enclosure services shall allow normal operation of the element to resume. The interpretation of the disabled state is specific to the element. The DISABLE bit is defined for each element listed with disable support in table 59 (see 7.1).

A RST SWAP (reset swap) bit set to one specifies that the enclosure services process set the SWAP bit to zero in the status field one time, if the SWAP bit is set to one. A RST SWAP bit set to zero specifies that the enclosure services process shall not change the SWAP bit.

NOTE 10 - The DISABLE bit and the RST SWAP bit are not intended to be accessed as part of a read-modify-write procedure with the corresponding bits in the status field (see 7.2.3).

The element-type-specific control information is defined separately for each element type in 7.3. Control information containing conflicting bits may cause unpredictable behavior or may cause the enclosure services process to report an invalid field error (see 4.5).

Author: ibm-gop  
Subject: Cross-Out  
Date: 12/13/2007 8:24:47 PM -06'00'

**T** 7.2.1 Formats for status and control fields overview (2nd paragraph)

This << Unless otherwise specified, all status and control bits are optional. >> should be deleted as everything is optional unless otherwise stated.

Status  
relliott Rejected 12/17/2007 3:35:56 PM -06'00'

Author: relliott  
Subject: Note  
Date: 3/19/2008 3:32:04 PM

it is helpful to restate the SCSI editorial assumption here, since it covers the whole clause. Deleted the 2nd and 3rd sentence, since they just restate the first. Kept the 4th sentence since it means a bit that is implemented can be ignored if needed.

Author: ibm-gop  
Subject: Cross-Out  
Date: 12/13/2007 8:24:47 PM -06'00'

**T** 7.2.1 Formats for status and control fields overview (2nd paragraph)

This << optional. >> should be deleted as everything is optional unless otherwise stated.

Status  
relliott Rejected 12/17/2007 3:36:32 PM -06'00'

Author: ibm-gop  
Subject: Cross-Out  
Date: 12/13/2007 8:24:47 PM -06'00'

**T** 7.2.1 Formats for status and control fields overview (2nd paragraph)

This << optional. >> should be deleted as everything is optional unless otherwise stated.

Status  
relliott Rejected 12/17/2007 3:36:28 PM -06'00'

Author: relliott  
Subject: Highlight  
Date: 5/12/2008 3:36:09 PM

**T** Element-type-specific  
s/b  
element type specific

Status  
relliott Accepted 12/21/2007 5:24:22 PM -06'00'

Author: ibm-gop  
Subject: Highlight  
Date: 12/13/2007 8:24:47 PM -06'00'

**T** 7.2.2 Format for all control fields (1st paragraph after table 60)

This << the RST SWAP bit) are defined below. >> should be << the RST SWAP bit) are defined in this subclause. >>

Status  
relliott Accepted 12/13/2007 9:50:06 PM -06'00'

Status  
relliott Confirmed 12/13/2007 9:50:09 PM -06'00'

Author: ibm-gop  
Subject: Highlight  
Date: 12/13/2007 8:24:47 PM -06'00'

**T** 7.2.2 Format for all control fields (3rd paragraph after table 60)

The quotes around the term << "predicted failure state" >> should be removed in all instances of the term.

~~Unless otherwise specified, all status and control bits are optional.~~ The enclosure is not required to return any ~~optional~~ status bit to the application client. The enclosure is not required to act on any ~~optional~~ control bit. All control bits are advisory and may be ignored or overridden to maintain a proper operating environment in the enclosure.

**7.2.2 Format for all control fields**

The format for the ELEMENT CONTROL and OVERALL CONTROL fields (i.e., control field) for all element types is shown in table 60.

**Table 60 — ELEMENT CONTROL and OVERALL CONTROL fields**

Byte\Bit	7	6	5	4	3	2	1	0
0	COMMON CONTROL							
	SELECT	PRDFAIL	DISABLE	RST SWAP	Reserved			
1	Element-type-specific control information							
3								

The COMMON CONTROL field contains those bits that may be used by any OVERALL CONTROL or ELEMENT CONTROL field. The bits of the COMMON CONTROL field (i.e., the SELECT bit, the PRDFAIL bit, the DISABLE bit, and the RST SWAP bit) are defined below.

A SELECT bit set to one specifies that the enclosure services process should perform the control functions defined by the other bits in the OVERALL CONTROL or ELEMENT CONTROL field. A SELECT bit set to zero specifies that the enclosure services process shall ignore all other bits in the OVERALL CONTROL or ELEMENT CONTROL field. The SELECT bit allows specific individual elements to be selected for control operations.

A PRDFAIL (predicted failure) bit set to one specifies that the enclosure services process turn on the “predicted failure state” indicator for the element. A PRDFAIL bit set to zero specifies that the enclosure services process turn off the “predicted failure state” indicator for the element. The element is not required to implement the PRDFAIL bit or the “predicted failure state” indicator.

A DISABLE bit set to one specifies that the enclosure services process disable the element. A DISABLE bit set to zero specifies that the enclosure services shall allow normal operation of the element to resume. The interpretation of the disabled state is specific to the element. The DISABLE bit is defined for each element listed with disable support in table 59 (see 7.1).

A RST SWAP (reset swap) bit set to one specifies that the enclosure services process set the SWAP bit to zero in the status field one time, if the SWAP bit is set to one. A RST SWAP bit set to zero specifies that the enclosure services process shall not change the SWAP bit.

NOTE 10 - The DISABLE bit and the RST SWAP bit are not intended to be accessed as part of a read-modify-write procedure with the corresponding bits in the status field (see 7.2.3).

The element-type-specific control information is defined separately for each element type in 7.3. Control information containing conflicting bits may cause unpredictable behavior or may cause the enclosure services process to report an invalid field error (see 4.5).

Status

relliott Rejected 12/17/2007 8:52:04 PM -06'00'

---

Author: ibm-gop

Subject: Highlight

Date: 12/13/2007 8:24:47 PM -06'00'

**T 7.2.2 Format for all control fields (last paragraph)**

This << The element-type-specific control information is defined separately for each element type in 7.3. >> should be << The element type specific control information is defined separately for each element type in 7.3. >>

Status

relliott Accepted 12/21/2007 5:24:05 PM -06'00'

---

7.2.3 Format for all status fields

The format for the ELEMENT STATUS and OVERALL STATUS fields (i.e., status fields) for all element types is shown in table 61.

Table 61 — ELEMENT STATUS and OVERALL STATUS fields

Byte\Bit	7	6	5	4	3	2	1	0
0	COMMON STATUS							
	Reserved	PRDFAIL	DISABLED	SWAP	ELEMENT STATUS CODE			
1	Element-type-specific status information							
3								

The COMMON STATUS field contains those bits that may be returned by any OVERALL STATUS field or ELEMENT STATUS field. The bits of the COMMON STATUS field (i.e., the PRDFAIL, DISABLED, SWAP, and ELEMENT STATUS CODE fields) are defined below.

A PRDFAIL (predicted failure) bit set to one indicates that the element has the capability of predicting failure and that a failure has been predicted. The “predicted failure state” indicator may additionally be set by the PRDFAIL bit in the corresponding control field. A PRDFAIL bit set to zero indicates that the “predicted failure state” indicator is turned off or is not implemented.

A DISABLED bit set to one indicates that the element has been disabled because the DISABLE bit was set to one in the control field (see 7.2.2). A DISABLED bit set to zero indicates that the element has not been disabled or that the disable function is not implemented. The DISABLED bit is defined for each element listed with disable support in table 59 (see 7.1).

A SWAP bit set to one indicates that an element has been removed and the same or another element has been inserted in the same location since the last time the RST SWAP control bit was set to one in the corresponding COMMON CONTROL field (see 7.2.2). The SWAP bit is set to zero when the RST SWAP control bit is set in the control field and remains set to zero until a device has been both removed and inserted in the device slot. The SWAP bit provides an indication that an element’s properties may have been changed without any change of configuration.

The ELEMENT STATUS CODE field is defined in table 62.

Table 62 — ELEMENT STATUS CODE field

Code	Name	Condition
0h	Unsupported	Status detection is not implemented for this element.
1h	OK	Element is installed and no error conditions are known.
2h	Critical	Critical condition is detected.
3h	Noncritical	Noncritical condition is detected.
4h	Unrecoverable	Unrecoverable condition is detected.
5h	Not Installed	Element is not installed in enclosure.
6h	Unknown	Sensor has failed or element status is not available.
7h	Not Available	Element installed, no known errors, but the element has not been turned on or set into operation.
8h	No Access Allowed	No status available because the initiator port from which the RECEIVE DIAGNOSTIC RESULT command was received does not have access to this element
9h-Fh	Reserved	

Author: relliott  
Subject: Highlight  
Date: 5/12/2008 3:36:09 PM

**T** Element-type-specific  
s/b  
Element type specific

Status  
relliott Accepted 12/21/2007 5:24:43 PM -06'00'

---

Author: ibm-gop  
Subject: Highlight  
Date: 12/13/2007 8:24:47 PM -06'00'

**T** 7.2.3 Format for all status fields (1st paragraph after table 61)

This << CODE fields) are defined below. >> should be << CODE fields) are defined in this subcluse. >>

Status  
relliott Accepted 12/13/2007 9:50:37 PM -06'00'

Status  
relliott Confirmed 12/13/2007 9:50:40 PM -06'00'

---

Author: ibm-gop  
Subject: Highlight  
Date: 12/13/2007 8:24:47 PM -06'00'

**T** 7.2.3 Format for all status fields (2nd paragraph after table 61)

The quotes around the term << "predicted failure state" >> should be removed in all instances of the term.

Status  
relliott Rejected 12/17/2007 8:52:26 PM -06'00'

---

Author: ibm-gop  
Subject: Highlight  
Date: 12/13/2007 8:24:47 PM -06'00'

**T** 7.2.3 Format for all status fields (3rd paragraph after table 61)

This << A DISABLED bit set to one indicates that the element has been disabled because the DISABLE bit was set to one >> should be << A DISABLED bit set to one indicates that the element has been disabled as a result of the DISABLE bit being set to one >>

Status  
relliott Rejected 12/17/2007 2:38:34 PM -06'00'

---

Author: relliott  
Subject: Cross-Out  
Date: 5/12/2008 3:36:09 PM

**T** control

Status  
relliott Accepted 3/9/2008 10:07:39 AM

---

Author: relliott  
Subject: Cross-Out  
Date: 5/12/2008 3:36:09 PM

**T** control

Status  
relliott Accepted 3/9/2008 10:07:52 AM

---

Author: relliott  
Subject: Note  
Date: 5/12/2008 3:36:09 PM  
**T** Make swap bit per-I\_T nexus (comment on T10 reflector from Morrie Gasser, EMC)

Rewording:

A rst swap (reset swap) bit set to one specifies that the enclosure services process shall set the swap bit to zero in the status element for the I\_T nexus accessing the control element. A rst swap bit set to zero specifies that the enclosure services process shall not change the swap bit in the status element for the I\_T nexus accessing the control element.



7.2.3 Format for all status fields

The format for the ELEMENT STATUS and OVERALL STATUS fields (i.e., status fields) for all element types is shown in table 61.

Table 61 — ELEMENT STATUS and OVERALL STATUS fields

Byte\Bit	7	6	5	4	3	2	1	0
0	COMMON STATUS							
	Reserved	PRDFAIL	DISABLED	SWAP	ELEMENT STATUS CODE			
1	Element-type-specific status information							
3	Element-type-specific status information							

The COMMON STATUS field contains those bits that may be returned by any OVERALL STATUS field or ELEMENT STATUS field. The bits of the COMMON STATUS field (i.e., the PRDFAIL, DISABLED, SWAP, and ELEMENT STATUS CODE fields) are defined below.

A PRDFAIL (predicted failure) bit set to one indicates that the element has the capability of predicting failure and that a failure has been predicted. The “predicted failure state” indicator may additionally be set by the PRDFAIL bit in the corresponding control field. A PRDFAIL bit set to zero indicates that the “predicted failure state” indicator is turned off or is not implemented.

A DISABLED bit set to one indicates that the element has been disabled because the DISABLE bit was set to one in the control field (see 7.2.2). A DISABLED bit set to zero indicates that the element has not been disabled or that the disable function is not implemented. The DISABLED bit is defined for each element listed with disable support in table 59 (see 7.1).

A SWAP bit set to one indicates that an element has been removed and the same or another element has been inserted in the same location since the last time the RST SWAP control bit was set to one in the corresponding COMMON CONTROL field (see 7.2.2). The SWAP bit is set to zero when the RST SWAP control bit is set in the control field and remains set to zero until a device has been both removed and inserted in the device slot. The SWAP bit provides an indication that an element’s properties may have been changed without any change of configuration.

The ELEMENT STATUS CODE field is defined in table 62.

Table 62 — ELEMENT STATUS CODE field

Code	Name	Condition
0h	Unsupported	Status detection is not implemented for this element.
1h	OK	Element is installed and no error conditions are known.
2h	Critical	Critical condition is detected.
3h	Noncritical	Noncritical condition is detected.
4h	Unrecoverable	Unrecoverable condition is detected.
5h	Not Installed	Element is not installed in enclosure.
6h	Unknown	Sensor has failed or element status is not available.
7h	Not Available	Element installed, no known errors, but the element has not been turned on or set into operation.
8h	No Access Allowed	No status available because the initiator port from which the RECEIVE DIAGNOSTIC RESULT command was received does not have access to this element
9h-Fh	Reserved	

A swap bit set to one indicates that an element has been swapped (i.e., removed and inserted) (e.g., for a Device element, the device been removed and the same or another device has been inserted in the same device slot) since the last time the rst swap bit was set to one in the control element for the I\_T nexus being used to access the status element (see 7.2.2). A swap bit set to zero indicates that the element has not been swapped. The swap bit is set to zero when the rst swap bit is set to one in the control element and remains set to zero until another swap occurs. The swap bit provides an indication that an element's properties may have been changed without any change of configuration. A standalone enclosure services process shall maintain one swap bit for each I\_T nexus. An attached enclosure services process shall maintain one swap bit shared by all I\_T nexuses.

Status  
relliott Accepted 3/19/2008 4:16:17 PM

---

Author: ibm-gop  
Subject: Highlight  
Date: 12/13/2007 8:24:47 PM -06'00'

**T** 7.2.3 Format for all status fields (las row in table 62)

**This << No status available because the initiator port from which the RECEIVE DIAGNOSTIC RESULT command was received does not have access to this element >> should be << No status available as a result of the initiator port from which the RECEIVE DIAGNOSTIC RESULT command was received not having access to this element >>**

Status  
relliott Rejected 12/17/2007 2:38:44 PM -06'00'

---

Author: hpq-relliott  
Subject: Highlight  
Date: 12/13/2007 8:24:34 PM -06'00'

**T**element  
s/b  
element.

Status  
relliott Accepted 12/13/2007 10:48:24 PM -06'00'

Status  
relliott Confirmed 12/13/2007 10:48:26 PM -06'00'

---

In an OVERALL STATUS field, the enclosure services process shall set the ELEMENT STATUS CODE field to 0h if it does not implement overall status detection, or it shall set the ELEMENT STATUS CODE field to:

- a) if there are no ELEMENT STATUS fields, any value representing the overall status;
- b) if there are one or more ELEMENT STATUS fields and, in each of them, the ELEMENT STATUS CODE field is set to 0h (i.e., Unsupported), any value representing the overall status; and
- c) if there are one or more ELEMENT STATUS fields and, in each of them, the ELEMENT STATUS CODE field is not set to 0h (i.e., Unsupported), 0h (i.e., Unsupported) or any value representing the overall status.

The element-type-specific status information is defined separately for each element type in 7.3.

### 7.3 Field definitions for all element types

#### 7.3.1 Unspecified element

The Unspecified element manages an unspecified part of the enclosure.

The format of the control field for the Unspecified element type is shown in table 63.

**Table 63 — Unspecified element for control-type diagnostic pages**

Byte\Bit	7	6	5	4	3	2	1	0
0	COMMON CONTROL							
1	Reserved							
3	Reserved							

The COMMON CONTROL field is specified in 7.2.2.

The format of the status field for an Unspecified element type is shown in table 64.

**Table 64 — Unspecified element for status-type diagnostic pages**

Byte\Bit	7	6	5	4	3	2	1	0
0	COMMON STATUS							
1	Reserved							
3	Reserved							

The COMMON STATUS field is specified in 7.2.3.

#### 7.3.2 Device element

The Device element manages a SCSI device (e.g., a disk drive) in the enclosure.

Additional information about a Device element may be reported in the Additional Element Status diagnostic page (see 6.1.13).

Author: ibm-gop  
Subject: Highlight  
Date: 12/13/2007 8:24:47 PM -06'00'

**T 7.2.3 Format for all status fields (last a,b,c list)**

This << c) if there are one or more ELEMENT STATUS fields and, in each of them, the ELEMENT STATUS CODE field is not set to 0h (i.e., Unsupported), 0h (i.e., Unsupported) or any value representing the overall status. >> cannot be parsed. I have no idea when the then is supposed to be nor do I have any idea why << 0h (i.e., Unsupported) >> is listed twice in a row. This needs to be fixed.

Status  
relliott Accepted 12/19/2007 8:59:26 PM -06'00'

Author: relliott  
Subject: Note  
Date: 12/19/2007 8:59:26 PM -06'00'

It is correct as written, but admittedly confusion. Converted whole mess into a table

Author: relliott  
Subject: Highlight  
Date: 5/12/2008 3:36:09 PM

**T**element-type-specific  
s/b  
element type specific

Status  
relliott Accepted 12/21/2007 5:24:58 PM -06'00'

Author: ibm-gop  
Subject: Highlight  
Date: 12/13/2007 8:24:47 PM -06'00'

**T 7.2.3 Format for all status fields (last paragraph)**

This << defined separately for each element type in 7.3. >> should be << defined separately for each element type (see 7.3). >>

Status  
relliott Rejected 12/13/2007 9:51:27 PM -06'00'

Author: relliott  
Subject: Highlight  
Date: 5/12/2008 3:36:09 PM

**T**Global in each 7.3.xx (twice per)

is specified in  
s/b  
is defined in

Status  
relliott Accepted 12/20/2007 7:36:27 PM -06'00'

Author: relliott  
Subject: Highlight  
Date: 5/12/2008 3:36:09 PM

**T**manages a SCSI device (e.g., a disk drive)  
s/b

manages a device (e.g., a SCSI device such as a disk drive)

because SATA devices are not SCSI devices, yet are managed with this element

Status  
relliott Accepted 12/19/2007 8:51:41 PM -06'00'

Status  
relliott Confirmed 12/17/2007 3:43:17 PM -06'00'

Author: relliott  
Subject: Note  
Date: 5/12/2008 3:36:09 PM

In an OVERALL STATUS field, the enclosure services process shall set the ELEMENT STATUS CODE field to 0h if it does not implement overall status detection, or it shall set the ELEMENT STATUS CODE field to:

- a) if there are no ELEMENT STATUS fields, any value representing the overall status;
- b) if there are one or more ELEMENT STATUS fields and, in each of them, the ELEMENT STATUS CODE field is set to 0h (i.e., Unsupported), any value representing the overall status; and
- c) if there are one or more ELEMENT STATUS fields and, in each of them, the ELEMENT STATUS CODE field is not set to 0h (i.e., Unsupported), 0h (i.e., Unsupported) or any value representing the overall status.

The element-type-specific status information is defined separately for each element type in 7.3.

### 7.3 Field definitions for all element types

#### 7.3.1 Unspecified element

The Unspecified element manages an unspecified part of the enclosure.

The format of the control field for the Unspecified element type is shown in table 63.

**Table 63 — Unspecified element for control-type diagnostic pages**

Byte\Bit	7	6	5	4	3	2	1	0
0	COMMON CONTROL							
1	Reserved							
3	Reserved							

The COMMON CONTROL field is specified in 7.2.2.

The format of the status field for an Unspecified element type is shown in table 64.

**Table 64 — Unspecified element for status-type diagnostic pages**

Byte\Bit	7	6	5	4	3	2	1	0
0	COMMON STATUS							
1	Reserved							
3	Reserved							

The COMMON STATUS field is specified in 7.2.3.

#### 7.3.2 Device element

The Device element manages a SCSI device (e.g., a disk drive) in the enclosure.

 Additional information about a Device element may be reported in the Additional Element Status diagnostic page (see 6.1.13).

 To resolve an IBM comment on the word "currently", change Device element to Device Slot element globally

Status

relliott Accepted 1/30/2008 7:53:46 PM -06'00'

---

The format of the control field for a Device element in the Enclosure Control diagnostic page (see 6.1.3) is defined in table 65.

**Table 65 — Device element for the Enclosure Control diagnostic page**

Byte\Bit	7	6	5	4	3	2	1	0
0	COMMON CONTROL							
1	Reserved							
2	RQST ACTIVE	DO NOT REMOVE	Reserved	RQST MISSING	RQST INSERT	RQST REMOVE	RQST IDENT	Reserved
3	Reserved		RQST FAULT	DEVICE OFF	ENABLE BYP A	ENABLE BYP B	Reserved	

The RQST ACTIVE (request device activity indication) bit has no effect if the enclosure provides no visual activity indication. The RQST ACTIVE bit may be set to one by the application client to cause a visual indication that the device is active. The enclosure services process shall sustain the active condition of the visual indicator for at least 0,5 seconds.

NOTE 11 - To maintain the active indication asserted (if present), the application client sets the bit to one at least once every 0,5 seconds.

A DO NOT REMOVE bit set to one specifies that the device not be removed. A DO NOT REMOVE bit set to zero specifies that the device may be removed. The DO NOT REMOVE bit may control mechanical interlocks or visual indications that the device should not be removed.

A RQST MISSING (request device missing indication) bit set to one specifies that the device slot be identified by a visual indication that a previously present device is missing (e.g., has been removed). A RQST MISSING bit set to zero specifies that the device missing indication shall be cleared.

A RQST INSERT (request insert) bit set to one specifies that the device slot be prepared for the insertion of a device. A RQST INSERT bit set to zero specifies that the device slot take no action to prepare for the insertion of a device. The bit may control mechanical interlocks or visual indications that a device may be inserted in the device slot.

A RQST REMOVE (request removal) bit set to one specifies that the device slot be prepared for the removal of a device. A RQST REMOVE bit set to zero specifies that the device slot take no action to prepare for the removal of a device. The bit may control mechanical interlocks or visual indications that a device may be removed from the device slot.

A RQST IDENT (request identify) bit set to one specifies that the enclosure services process identify the element (i.e., the device slot) by a visual indication. A RQST IDENT bit set to zero specifies that the enclosure services process not identify the element by a visual indication.

A RQST FAULT (request fault indication) bit set to one specifies that the device slot be identified by a visual indication that a fault is present in the device. A RQST FAULT bit set to zero specifies that the fault indication shall be cleared if the indication is not also being set by the device or the enclosure services process.

A DEVICE OFF bit set to one specifies that the device be turned off. A DEVICE OFF bit set to zero specifies that the device may be turned on if all other prerequisites are met.

An ENABLE BYP A (enable bypass Port A) bit set to one specifies that port A for the device be bypassed. An ENABLE BYP A bit set to zero specifies that, if there is no other cause for the port to be bypassed, the port bypass shall be disabled and the device shall be included on the device interface.

An ENABLE BYP B (enable bypass Port B) bit set to one specifies that port B for the device be bypassed. An ENABLE BYP B bit set to zero specifies that, if there is no other cause for the port to be bypassed, the port bypass shall be disabled and the device shall be included on the device interface.

This page contains no comments



The format of the status field for a Device element in the Enclosure Status diagnostic page (see 6.1.4) is defined in table 66.

**Table 66 — Device element for the Enclosure Status diagnostic page**

Byte\Bit	7	6	5	4	3	2	1	0
0	COMMON STATUS							
1	SLOT ADDRESS							
2	APP CLIENT BYPASSED A	DO NOT REMOVE	ENCLOSURE BYPASSED A	ENCLOSURE BYPASSED B	READY TO INSERT	RMV	IDENT	REPORT
3	APP CLIENT BYPASSED B	FAULT SENSED	FAULT REQSTD	DEVICE OFF	BYPASSED A	BYPASSED B	DEVICE BYPASSED A	DEVICE BYPASSED B

The COMMON STATUS field is specified in 7.2.3.

For the ELEMENT STATUS field, the SLOT ADDRESS field is set to the value of the SCSI address of the primary parallel SCSI target port of the SCSI target device if one exists, and is vendor specific for SCSI target devices without parallel SCSI target ports.

For the OVERALL STATUS field, the SLOT ADDRESS field is vendor specific.

A DO NOT REMOVE bit set to one indicates that the corresponding control bit has been set to one. A DO NOT REMOVE bit set to zero indicates that the corresponding control bit has been set to zero or has not been implemented. If the DO NOT REMOVE bit is set to one, it indicates that mechanical interlocks or visual signals are present and activated to indicate that a device should not be removed. If the DO NOT REMOVE bit is set to zero, it indicates that mechanical interlocks or visual signals are not present or not activated, indicating that a device may be removed.

A READY TO INSERT bit set to one indicates that the device slot has been prepared for the insertion of a device. A READY TO INSERT bit set to zero indicates that the device slot is unable to accept the insertion of a device or that the RQST INSERT control bit is not implemented.

A RMV (remove) bit set to one indicates that the device slot has been prepared for the removal of a device. A RMV bit set to zero indicates that the device cannot be removed from the device slot or that the RQST REMOVE control bit is not implemented.

An IDENT (identify) bit set to one indicates that the enclosure services process is currently identifying the element by a visual indication because the RQST IDENT bit was set to one in the control-type diagnostic page. An IDENT bit set to zero indicates that the enclosure services process is not currently identifying the element by a visual indication based on the RQST IDENT bit in the control-type diagnostic page, or a visual indication is not implemented.

A REPORT bit set to one indicates that the Enclosure Status diagnostic page is being transferred through the device described by this ELEMENT STATUS field. A REPORT bit set to zero if the Enclosure Status diagnostic page is not being transferred through that device.

A FAULT SENSED bit set to one indicates that the enclosure or device has detected a fault condition and may be displaying a visual indication of the fault condition. A FAULT SENSED bit set to zero indicates that there is no fault condition detected by the device or enclosure.

A FAULT REQSTD (fault requested) bit set to one indicates that the RQST FAULT control bit has set to one, specifying that the device slot be identified by a visual fault indication. A FAULT REQSTD bit set to zero indicates that the RQST FAULT control bit has been set to zero or that the RQST FAULT control bit is not implemented.

A DEVICE OFF bit set to one indicates that the device is turned off. A DEVICE OFF bit set to zero indicates that the device is turned on.

Author: ibm-gop  
Subject: Highlight  
Date: 12/13/2007 8:24:47 PM -06'00'

**T** 7.3.2 Device element (2nd paragraph after table 66)

This << parallel SCSI target port of the SCSI target device if one exists, and is vendor >> should be << parallel SCSI target port of the SCSI target device, if any, and is vendor >>

Status  
relliott Rejected 12/15/2007 5:11:43 PM -06'00'

Status  
relliott Confirmed 12/15/2007 5:11:47 PM -06'00'

---

Author: relliott  
Subject: Note  
Date: 12/15/2007 5:12:04 PM -06'00'

 Replaced whole paragraph with:

If the device is a parallel SCSI device, the slot address field indicates the SCSI address of the primary parallel SCSI target port of the SCSI target device. If the device is not a parallel SCSI device, the slot address field is vendor specific.

---

Author: relliott  
Subject: Highlight  
Date: 5/12/2008 3:36:09 PM

**T** a device  
s/b  
the device

Status  
relliott Accepted 12/15/2007 5:12:46 PM -06'00'

Status  
relliott Confirmed 12/15/2007 5:12:49 PM -06'00'

---

Author: relliott  
Subject: Highlight  
Date: 5/12/2008 3:36:09 PM

**T** a device  
s/b  
the device

Status  
relliott Accepted 12/15/2007 5:13:15 PM -06'00'

Status  
relliott Confirmed 12/15/2007 5:13:17 PM -06'00'

---

Author: relliott  
Subject: Highlight  
Date: 5/12/2008 3:36:09 PM

**T** a device  
s/b  
the device

Status  
relliott Accepted 12/15/2007 5:13:43 PM -06'00'

Status  
relliott Confirmed 12/15/2007 5:13:46 PM -06'00'

---

Author: relliott  
Subject: Highlight  
Date: 5/12/2008 3:36:09 PM

**T** control-type diagnostic page  
s/b  
control element

Status  
relliott Accepted 1/3/2008 5:59:15 PM -06'00'

---

The format of the status field for a Device element in the Enclosure Status diagnostic page (see 6.1.4) is defined in table 66.

**Table 66 — Device element for the Enclosure Status diagnostic page**

Byte\Bit	7	6	5	4	3	2	1	0
0	COMMON STATUS							
1	SLOT ADDRESS							
2	APP CLIENT BYPASSED A	DO NOT REMOVE	ENCLOSURE BYPASSED A	ENCLOSURE BYPASSED B	READY TO INSERT	RMV	IDENT	REPORT
3	APP CLIENT BYPASSED B	FAULT SENSED	FAULT REQSTD	DEVICE OFF	BYPASSED A	BYPASSED B	DEVICE BYPASSED A	DEVICE BYPASSED B

The COMMON STATUS field is specified in 7.2.3.

For the ELEMENT STATUS field, the SLOT ADDRESS field is set to the value of the SCSI address of the primary parallel SCSI target port of the SCSI target device if one exists, and is vendor specific for SCSI target devices without parallel SCSI target ports.

For the OVERALL STATUS field, the SLOT ADDRESS field is vendor specific.

A DO NOT REMOVE bit set to one indicates that the corresponding control bit has been set to one. A DO NOT REMOVE bit set to zero indicates that the corresponding control bit has been set to zero or has not been implemented. If the DO NOT REMOVE bit is set to one, it indicates that mechanical interlocks or visual signals are present and activated to indicate that a device should not be removed. If the DO NOT REMOVE bit is set to zero, it indicates that mechanical interlocks or visual signals are not present or not activated, indicating that a device may be removed.

A READY TO INSERT bit set to one indicates that the device slot has been prepared for the insertion of a device. A READY TO INSERT bit set to zero indicates that the device slot is unable to accept the insertion of a device or that the RQST INSERT control bit is not implemented.

A RMV (remove) bit set to one indicates that the device slot has been prepared for the removal of a device. A RMV bit set to zero indicates that the device cannot be removed from the device slot or that the RQST REMOVE control bit is not implemented.

An IDENT (identify) bit set to one indicates that the enclosure services process is currently identifying the element by a visual indication because the RQST IDENT bit was set to one in the control-type diagnostic page. An IDENT bit set to zero indicates that the enclosure services process is not currently identifying the element by a visual indication based on the RQST IDENT bit in the control-type diagnostic page, or a visual indication is not implemented.

A REPORT bit set to one indicates that the Enclosure Status diagnostic page is being transferred through the device described by this ELEMENT STATUS field. A REPORT bit set to zero if the Enclosure Status diagnostic page is not being transferred through that device.

A FAULT SENSED bit set to one indicates that the enclosure or device has detected a fault condition and may be displaying a visual indication of the fault condition. A FAULT SENSED bit set to zero indicates that there is no fault condition detected by the device or enclosure.

A FAULT REQSTD (fault requested) bit set to one indicates that the RQST FAULT control bit has set to one, specifying that the device slot be identified by a visual fault indication. A FAULT REQSTD bit set to zero indicates that the RQST FAULT control bit has been set to zero or that the RQST FAULT control bit is not implemented.

A DEVICE OFF bit set to one indicates that the device is turned off. A DEVICE OFF bit set to zero indicates that the device is turned on.

Author: ibm-gop  
Subject: Highlight  
Date: 12/13/2007 8:24:47 PM -06'00'

**T** 7.3.2 Device element (7th paragraph after table 66)

This << element by a visual indication because the RQST IDENT bit was set to one in the control-type diagnostic page. >> should be << element by a visual indication as a result of the RQST IDENT bit being set to one in the control-type diagnostic page. >>

Status  
relliott Rejected 12/17/2007 2:41:23 PM -06'00'

---

Author: relliott  
Subject: Highlight  
Date: 5/12/2008 3:36:09 PM  
**T** control-type diagnostic page  
s/b  
control element

Status  
relliott Accepted 1/3/2008 5:59:28 PM -06'00'

---

Author: relliott  
Subject: Highlight  
Date: 5/12/2008 3:36:09 PM  
**T** Enclosure Status diagnostic page is being transferred through the device  
s/b  
the enclosure services process is using this device to report the Enclosure Status diagnostic page

Status  
relliott Accepted 1/4/2008 6:43:27 PM -06'00'

---

Author: relliott  
Subject: Highlight  
Date: 5/12/2008 3:36:09 PM  
**T** the Enclosure Status diagnostic page is not being transferred through that device.  
s/b  
the enclosure services process is not using this device to report the Enclosure Status diagnostic page

Status  
relliott Accepted 1/4/2008 6:43:52 PM -06'00'

---

A BYPASSED A bit set to one indicates that Port A has been bypassed by request of the application client, the device, or the enclosure. A BYPASSED A bit set to zero indicates that the port bypass is disabled and the device is included on the device interface.

A BYPASSED B bit set to one indicates that Port B has been bypassed by request of the application client, the device, or the enclosure. A BYPASSED B bit set to zero indicates that the port bypass is disabled and the device is included on the device interface.

An ENCLOSURE BYPASSED A bit set to one indicates that Port A has been bypassed by request of the enclosure services process. An ENCLOSURE BYPASSED A bit set to zero indicates that Port A is not being bypassed under control of the enclosure services process. The device may still be bypassed under control of the application client or the device.

An ENCLOSURE BYPASSED B bit set to one indicates that Port B has been bypassed by request of the enclosure services process. An ENCLOSURE BYPASSED B bit set to zero indicates that Port B is not being bypassed under control of the enclosure services process. The device may still be bypassed under control of the application client or the device.

An APP CLIENT BYPASSED A (application client bypassed Port A) bit set to one indicates that Port A has been bypassed by request of an application client. An APP CLIENT BYPASSED A bit indicates that Port A is not being bypassed under control of an application client. The device may still be bypassed under control of the enclosure services process or the device.

An APP CLIENT BYPASSED B (application client bypassed Port B) bit set to one indicates that Port B has been bypassed by request of an application client. An APP CLIENT BYPASSED B bit indicates that Port B is not being bypassed under control of an application client. The device may still be bypassed under control of the enclosure services process or the device.

A DEVICE BYPASSED A bit set to one indicates that Port A has been bypassed by request of the device. A DEVICE BYPASSED A bit indicates that Port A is not being bypassed by request of the device. When set to one, the device may be removed, turned off, not operational, or controlling the bypass signals under control of the **device server**. When set to zero, the device may still be bypassed under control of the enclosure services process or the application client.

A DEVICE BYPASSED B bit set to one indicates that Port B has been bypassed by request of the device. A DEVICE BYPASSED B bit indicates Port B is not being bypassed by request of the device. When set to one, the device may be removed, turned off, not operational, or controlling the bypass signals under control of the **device server**. When set to zero, the device may still be bypassed under control of the enclosure services process or the application client.

### 7.3.3 Array Device element

The Array Device element **manages a SCSI device (e.g., a disk drive) in an enclosure that is being used in a storage array (e.g., a RAID controller)**. The mapping between the visual indicators associated with the Array Device element and the requests to set those indicators is vendor specific.

Additional information about an Array Device element may be reported in the Additional Element Status diagnostic page (see 6.1.13).

Author: relliott  
Subject: Highlight  
Date: 5/12/2008 3:36:09 PM

**T** device server  
s/b  
device

Status  
relliott Accepted 12/15/2007 5:21:41 PM -06'00'  
Status  
relliott Confirmed 12/15/2007 5:21:44 PM -06'00'

---

Author: relliott  
Subject: Highlight  
Date: 5/12/2008 3:36:09 PM

**T** device server  
s/b  
device

Status  
relliott Accepted 12/15/2007 5:21:59 PM -06'00'  
Status  
relliott Confirmed 12/15/2007 5:22:01 PM -06'00'

---

Author: relliott  
Subject: Note  
Date: 5/12/2008 3:36:09 PM

 To resolve an IBM comment on the word "currently", change Array Device element to Array Device Slot element globally

Status  
relliott Accepted 1/30/2008 7:54:05 PM -06'00'

---

Author: relliott  
Subject: Highlight  
Date: 5/12/2008 3:36:09 PM

**T** manages a SCSI device (e.g., a disk drive) in an enclosure that is being used in a storage array (e.g., a RAID controller).  
s/b

manages an array device (e.g., a SCSI device such as a disk drive that is being used in a storage array (e.g., by a RAID controller)) in an enclosure

This defines the term "array device" which is used at least one other place, and allows SATA devices to qualify by making SCSI just an e.g.

Status  
relliott Accepted 12/15/2007 5:20:16 PM -06'00'  
Status  
relliott Confirmed 12/15/2007 5:20:19 PM -06'00'

---

The format of the control field for an Array Device element in the Enclosure Control diagnostic page (see 6.1.3) is defined in table 67.

**Table 67 — Array Device element for the Enclosure Control diagnostic page**

Byte\Bit	7	6	5	4	3	2	1	0
0	COMMON CONTROL							
1	RQST OK	RQST RSVD DEVICE	RQST HOT SPARE	RQST CONS CHECK	RQST IN CRIT ARRAY	RQST IN FAILED ARRAY	RQST REBUILD/REMAP	RQST R/R ABORT
2	RQST ACTIVE	DO NOT REMOVE	Reserved	RQST MISSING	RQST INSERT	RQST REMOVE	RQST IDENT	Reserved
3	Reserved		RQST FAULT	DEVICE OFF	ENABLE BYP A	ENABLE BYP B	Reserved	

The COMMON CONTROL field is specified in 7.2.2.

A RQST OK (request OK) bit set to one specifies that the “device okay” indicator be turned on. A RQST OK bit set to zero specifies that the “device okay” indicator be turned off.

A RQST RSVD DEVICE (request reserved device) bit set to one specifies that the “reserved device” indicator be turned on. A RQST RSVD DEVICE bit set to zero specifies that the “reserved device” indicator be turned off.

A RQST HOT SPARE (request hot spare) bit set to one specifies that the “hot spare” indicator be turned on. A RQST HOT SPARE bit set to zero specifies that the “hot spare” indicator be turned off.

A RQST CONS CHECK (request consistency check in progress) bit set to one specifies that the “consistency check in progress” indicator be turned on. A RQST CONS CHECK bit set to zero specifies that the “consistency check in progress” indicator be turned off.

A RQST IN CRIT ARRAY (request in critical array) bit set to one specifies that the “in critical array” indicator be turned on. A RQST IN CRIT ARRAY bit set to zero specifies that the “in critical array” indicator be turned off.

A RQST IN FAILED ARRAY (request in failed array) bit set to one specifies that the “in failed array” indicator be turned on. A RQST IN FAILED ARRAY bit set to zero specifies that the “in failed array” indicator be turned off.

A RQST REBUILD/REMAP (request rebuild/remap) bit set to one specifies that the “rebuild/remap” indicator be turned on. A RQST REBUILD/REMAP bit set to zero specifies that the “rebuild/remap” indicator be turned off.

A RQST R/R ABORT (request rebuild/remap aborted) bit set to one specifies that the “rebuild/remap abort” indicator be turned on. A RQST R/R ABORT bit set to zero specifies that the “rebuild/remap abort” indicator be turned off.

The RQST ACTIVE (request device activity indication) bit, DO NOT REMOVE bit, RQST INSERT (request insert) bit, RQST REMOVE (request removal) bit, RQST MISSING (request device missing indication) bit, RQST IDENT (request identify) bit, RQST FAULT (request fault indication) bit, DEVICE OFF bit, ENABLE BYP A (enable bypass A) bit, and ENABLE BYP B (enable bypass B) bit are defined in the Device element for the Enclosure Control diagnostic page (see 7.3.2).

● Author: ibm-gop

Subject: Note

Date: 12/13/2007 8:24:47 PM -06'00'

 7.3.3 Array Device element (several paragraphs after table 67)

**All the terms that are quoted should have the quotes removed.**

Status

relliott Rejected 12/17/2007 3:42:33 PM -06'00'

---

● Author: hpq-relliott

Subject: Highlight

Date: 12/13/2007 8:24:34 PM -06'00'

 enable bypass A

s/b

enable bypass Port A

Status

relliott Accepted 12/13/2007 9:52:30 PM -06'00'

Status

relliott Confirmed 12/13/2007 9:52:33 PM -06'00'

---

● Author: hpq-relliott

Subject: Highlight

Date: 12/13/2007 8:24:34 PM -06'00'

 (enable bypass B)

s/b

(enable bypass port B)

Status

relliott Accepted 12/13/2007 9:52:37 PM -06'00'

Status

relliott Confirmed 12/13/2007 9:52:40 PM -06'00'

---



The format of the status field for an Array Device element in the Enclosure Status diagnostic page (see 6.1.4) is defined in table 68.

**Table 68 — Array Device element for the Enclosure Status diagnostic page**

Byte/Bit	7	6	5	4	3	2	1	0
0	COMMON STATUS							
1	OK	RSVD DEVICE	HOT SPARE	CONS CHK	IN CRIT ARRAY	IN FAILED ARRAY	REBUILD/REMAP	R/R ABORT
2	APP CLIENT BYPASSED A	DO NOT REMOVE	ENCLOSURE BYPASSED A	ENCLOSURE BYPASSED B	READY TO INSERT	RMV	IDENT	REPORT
3	APP CLIENT BYPASSED B	FAULT SENSED	FAULT REQSTD	DEVICE OFF	BYPASSED A	BYPASSED B	DEVICE BYPASSED A	DEVICE BYPASSED B

The COMMON STATUS field is specified in 7.2.3.

An OK bit set to one indicates that the “device okay” indicator is turned on. An OK bit set to zero indicates that the “device okay” indicator is turned off.

A RSVD DEVICE (reserved device) bit set to one indicates that the “reserved device” indicator is turned on. A RSVD DEVICE bit set to zero indicates that the “reserved device” indicator is turned off.

A HOT SPARE bit set to one indicates that the “hot spare” indicator is turned on. A HOT SPARE bit set to zero indicates that the “hot spare” indicator is turned off.

A CONS CHECK (consistency check in progress) bit set to one indicates that the “consistency check in progress” indicator is turned on, showing that the device is participating in an array consistency check activity. A CONS CHECK bit set to zero indicates that the “consistency check in progress” indicator is turned off.

An IN CRIT ARRAY (in critical array) bit set to one indicates that the “in critical array” indicator is turned on, showing that the device is participating in an array which would be degraded or become unavailable if the device were removed. An IN CRIT ARRAY bit set to zero indicates that the “in critical array” indicator is turned off.

An IN FAILED ARRAY bit set to one indicates that the “in failed array” indicator is turned on, showing that the device is a member of an array that has failed. The IN FAILED ARRAY bit set to zero indicates that the “in failed array” indicator is turned off.

A REBUILD/REMAP bit set to one indicates that the “rebuild/remap” indicator is turned on, showing that the device is participating in a rebuild or remap of the array contents. A REBUILD/REMAP bit set to zero indicates that the “rebuild/remap” indicator is turned off.

An R/R ABORT (rebuild/remap abort) bit set to one indicates that the “rebuild/remap abort” indicator is on, showing that a rebuild or remap of the array contents has been unsuccessfully terminated. An R/R ABORT bit set to zero indicates that the “rebuild/remap abort” indicator is turned off.

The DO NOT REMOVE bit, READY TO INSERT bit, RMV (remove) bit, IDENT (identify) bit, and REPORT bit are defined in the Device element for the Enclosure Status diagnostic page (see 7.3.2).

The FAULT SENSED bit, FAULT REQSTD bit, and DEVICE OFF bit are defined in the Device element for the Enclosure Status diagnostic page (see 7.3.2).

The APP CLIENT BYPASSED A bit, APP CLIENT BYPASSED B bit, ENCLOSURE BYPASSED A bit, ENCLOSURE BYPASSED B bit, BYPASSED A bit, BYPASSED B bit, DEVICE BYPASSED A bit, and DEVICE BYPASSED B bit are defined in the Device element for the Enclosure Status diagnostic page (see 7.3.2).

Author: ibm-gop

Subject: Note

Date: 12/13/2007 8:24:47 PM -06'00'

 **7.3.3 Array Device element (several paragraphs after table 68)**

**All the terms that are quoted should have the quotes removed.**

Status

relliott Rejected 12/17/2007 3:42:28 PM -06'00'

---

**7.3.4 Power Supply element**

The Power Supply element manages a power supply (e.g., providing power to devices (see 7.3.2), array devices (see 7.3.3), enclosure services process electronics (see 7.3.9), and/or SCC controller electronics (see 7.3.10)).

The format of the control field for a Power Supply element is defined in table 69.

**Table 69 — Power Supply element for control-type diagnostic pages**

Byte\Bit	7	6	5	4	3	2	1	0
0	COMMON CONTROL							
1	RQST IDENT	Reserved						
2	Reserved							
3	Reserved	RQST FAIL	RQST ON	Reserved				

The COMMON CONTROL field is specified in 7.2.2.

A RQST IDENT (request identify) bit set to one specifies that the enclosure services process identify the element by a visual indication. A RQST IDENT bit set to zero specifies that the enclosure services process not identify the element by a visual indication.

A RQST FAIL (request failure indication) bit set to one specifies that the enclosure services process shall enable a visual indication that a failure is present in the element. A RQST FAIL bit set to zero specifies that the enclosure services process shall disable a visual indication that a failure is present in the element, unless the enclosure services process is itself detecting a failure in the element. Some failure indications in the STATUS INFORMATION field are latched. **Setting the RQST FAIL bit to one and then setting it to zero shall reset any latched failure indications.**

A RQST ON (request power supply on) bit set to one specifies that the power supply be turned on or remain on. When the RQST ON bit is set to zero, the power supply is requested to turn off or remain off.

The format of the status field for a Power Supply element is defined in table 70.

**Table 70 — Power Supply element for status-type diagnostic pages**

Byte\Bit	7	6	5	4	3	2	1	0	
0	COMMON STATUS								
1	IDENT	Reserved							
2	Reserved				DC OVER VOLTAGE	DC UNDER VOLTAGE	DC OVER CURRENT	Reserved	
3	HOT SWAP	FAIL	RQSTED ON	OFF	OVERTMP FAIL	TEMP WARN	AC FAIL	DC FAIL	

The COMMON STATUS field is specified in 7.2.3.

An IDENT (identify) bit set to one indicates that the enclosure services process is currently identifying the element by a visual indication because the RQST IDENT bit was set to one in the control-type diagnostic page. An IDENT bit set to zero indicates that the enclosure services process is not currently identifying the element by a visual indication based on the RQST IDENT bit in the control-type diagnostic page, or a visual indication is not implemented.

A DC OVERVOLTAGE bit set to one indicates an overvoltage condition has been detected at the power supply output. A DC OVERVOLTAGE bit set to zero indicates that the RQST FAIL control bit has been set to one and then set to zero, or that a power on has occurred.

Author: ibm-gop  
Subject: Highlight  
Date: 12/13/2007 8:24:47 PM -06'00'

**T** 7.3.4 Power Supply element (3rd paragraph after table 69)

**This << Setting the RQST FAIL bit to one and then setting it to zero shall reset any latched failure indications. >> should be << Setting the RQST FAIL bit to one and then setting it to zero shall reset all failure indications. >>**

Status  
relliott Rejected 12/21/2007 5:22:52 PM -06'00'

---

Author: relliott  
Subject: Note  
Date: 12/21/2007 5:22:33 PM -06'00'



Author: relliott  
Subject: Highlight  
Date: 5/12/2008 3:36:09 PM

**T** control-type diagnostic page.  
s/b  
control element

Status  
relliott Accepted 1/3/2008 6:00:10 PM -06'00'

---

Author: ibm-gop  
Subject: Highlight  
Date: 12/13/2007 8:24:47 PM -06'00'

**T** 7.3.4 Power Supply element (2nd paragraph after table 70)

**This << element by a visual indication because the RQST IDENT bit was set to one in the control-type diagnostic page. >> should be << element by a visual indication as a result of the RQST IDENT bit being set to one in the control-type diagnostic page. >>**

Status  
relliott Rejected 12/17/2007 2:41:34 PM -06'00'

---

Author: ibm-gop  
Subject: Highlight  
Date: 12/13/2007 8:24:47 PM -06'00'

**T** 7.3.4 Power Supply element (2nd paragraph after table 70)

**This << indicates that the enclosure services process is not currently identifying the element by >> should be << indicates that the enclosure services process is not identifying the element by >>**

Status  
relliott Rejected 1/3/2008 5:47:10 PM -06'00'

---

Author: relliott  
Subject: Highlight  
Date: 5/12/2008 3:36:09 PM

**T** control-type diagnostic page  
s/b  
control element

Status  
relliott Accepted 1/3/2008 6:00:36 PM -06'00'

---

A DC UNDERVOLTAGE bit set to one indicates an undervoltage condition has been detected at the power supply output. A DC UNDERVOLTAGE bit set to zero indicates that the RQST FAIL control bit has been set to one and then set to zero, or that a power on has occurred.

A DC OVERCURRENT bit set to one indicates an overcurrent condition has been detected at the power supply output. The DC OVERCURRENT bit set to zero indicates that the RQST FAIL control bit has been set to to one and then set to zero, or that a power on has occurred.

A HOT SWAP bit set to one indicates that the element may be replaced without removing power from the subenclosure that contains the element. A HOT SWAP bit set to zero may or may not indicate that the element is not a replaceable element or power is required to be removed from the subenclosure before the element is replaced.

A FAIL bit set to one indicates that the enclosure services process is currently identifying the element with a visual failure indication based on the RQST FAIL bit in the control-type diagnostic page or its own detection of a failure. A FAIL bit set to zero indicates that:

- a) the enclosure services process is not currently identifying the element with a visual failure indication based on the RQST FAIL bit in the control-type diagnostic page or its own detection of a failure (e.g., the ELEMENT STATUS CODE field is not set to 1h (i.e., OK)); or
- b) a visual failure indication is not implemented.

A RQSTED ON (requested on) bit set to one indicates that the power supply has been manually turned on or has been requested to turn on by setting the RQST ON control bit to one. A RQSTED ON bit set to zero indicates that the RQST ON control bit has been set to zero.

An OFF bit set to one indicates the power supply is not providing power. The OFF bit shall be set to one if:

- a) the RQST ON control bit is set to zero to request the power supply be turned off;
- b) the power supply is turned off manually; or
- c) a failure has caused the power supply to stop providing power.

An OFF bit set to zero indicates the power supply is providing its specified output.

An OVERTMP FAIL (overtemperature failure) bit set to one indicates the power supply has detected a temperature higher than a safe operating temperature. The power supply may shut down. An OVERTMP FAIL bit set to zero indicates that the RQST FAIL control bit has been set to one then set to zero, or that a power on has occurred.

A TEMP WARN (overtemperature warning) bit set to one indicates the power supply has detected a temperature that is safe, but higher than normal operating temperature. A TEMP WARN bit set to zero indicates that normal operating temperature is again detected.

An AC FAIL bit set to one indicates that the power supply is not receiving the specified AC power. An AC FAIL bit set to zero indicates that normal AC power is being received.

A DC FAIL bit set to one indicates that the power supply is unable to supply the specified DC power. A DC FAIL bit set to zero indicates that normal DC power is being provided.

### 7.3.5 Cooling element

The Cooling element manages a fan, blower, or other cooling mechanism.

Author: ibm-gop  
Subject: Highlight  
Date: 12/13/2007 8:24:47 PM -06'00'

**T** 7.3.4 Power Supply element (7th paragraph after table 70)

**This << A FAIL bit set to one indicates that the enclosure services process is currently identifying the element with a >> should be << A FAIL bit set to one indicates that the enclosure services process is identifying the element with a >>**

Status  
relliott Rejected 1/3/2008 5:47:18 PM -06'00'

---

Author: relliott  
Subject: Highlight  
Date: 5/12/2008 3:36:09 PM  
**T** control-type diagnostic page  
s/b  
control element

Status  
relliott Accepted 1/3/2008 6:00:54 PM -06'00'

---

Author: ibm-gop  
Subject: Highlight  
Date: 12/13/2007 8:24:47 PM -06'00'

**T** 7.3.4 Power Supply element (1st a,b,c list after table 70)

**This << the enclosure services process is not currently identifying the element with a visual failure indication >> should be << the enclosure services process is not identifying the element with a visual failure indication >>**

Status  
relliott Rejected 1/3/2008 5:47:24 PM -06'00'

---

Author: relliott  
Subject: Highlight  
Date: 5/12/2008 3:36:09 PM  
**T** control-type diagnostic page  
s/b  
control element

Status  
relliott Accepted 1/3/2008 6:01:08 PM -06'00'

---

Author: relliott  
Subject: Highlight  
Date: 5/12/2008 3:36:09 PM  
**T** overtemperature  
s/b

over temperature

twice on the page

Status  
relliott Accepted 12/19/2007 8:39:03 PM -06'00'

---

Author: relliott  
Subject: Highlight  
Date: 5/12/2008 3:36:09 PM  
**T** power supply has detected a  
temperature higher than a safe operating temperature.  
s/b

power supply has detected a temperature above the safe operating temperature range

to match wording in Temperature Sensor element

Status  
relliott Accepted 12/19/2007 8:38:01 PM -06'00'

---

Author: relliott  
Subject: Highlight  
Date: 5/12/2008 3:36:09 PM

A DC UNDERVOLTAGE bit set to one indicates an undervoltage condition has been detected at the power supply output. A DC UNDERVOLTAGE bit set to zero indicates that the RQST FAIL control bit has been set to one and then set to zero, or that a power on has occurred.

A DC OVERCURRENT bit set to one indicates an overcurrent condition has been detected at the power supply output. The DC OVERCURRENT bit set to zero indicates that the RQST FAIL control bit has been set to to one and then set to zero, or that a power on has occurred.

A HOT SWAP bit set to one indicates that the element may be replaced without removing power from the subenclosure that contains the element. A HOT SWAP bit set to zero may or may not indicate that the element is not a replaceable element or power is required to be removed from the subenclosure before the element is replaced.

A FAIL bit set to one indicates that the enclosure services process is currently identifying the element with a visual failure indication based on the RQST FAIL bit in the control-type diagnostic page or its own detection of a failure. A FAIL bit set to zero indicates that:

- a) the enclosure services process is not currently identifying the element with a visual failure indication based on the RQST FAIL bit in the control-type diagnostic page or its own detection of a failure (e.g., the ELEMENT STATUS CODE field is not set to 1h (i.e., OK)); or
- b) a visual failure indication is not implemented.

A RQSTED ON (requested on) bit set to one indicates that the power supply has been manually turned on or has been requested to turn on by setting the RQST ON control bit to one. A RQSTED ON bit set to zero indicates that the RQST ON control bit has been set to zero.

An OFF bit set to one indicates the power supply is not providing power. The OFF bit shall be set to one if:

- a) the RQST ON control bit is set to zero to request the power supply be turned off;
- b) the power supply is turned off manually; or
- c) a failure has caused the power supply to stop providing power.

An OFF bit set to zero indicates the power supply is providing its specified output.

An OVERTMP FAIL (overtemperature failure) bit set to one indicates the power supply has detected a temperature higher than a safe operating temperature. The power supply may shut down. An OVERTMP FAIL bit set to zero indicates that the RQST FAIL control bit has been set to one then set to zero, or that a power on has occurred.

A TEMP WARN (overtemperature warning) bit set to one indicates the power supply has detected a temperature that is safe, but higher than normal operating temperature. A TEMP WARN bit set to zero indicates that normal operating temperature is again detected.

An AC FAIL bit set to one indicates that the power supply is not receiving the specified AC power. An AC FAIL bit set to zero indicates that normal AC power is being received.

A DC FAIL bit set to one indicates that the power supply is unable to supply the specified DC power. A DC FAIL bit set to zero indicates that normal DC power is being provided.

### 7.3.5 Cooling element

The Cooling element manages a fan, blower, or other cooling mechanism.

**T**A TEMP WARN (overtemperature warning) bit set to one indicates the power supply has detected a temperature that is safe, but higher than normal operating temperature. A TEMP WARN bit set to zero indicates that normal operating temperature is again detected.

s/b

A temp warn (overtemperature warning) bit set to one indicates the power supply has detected a temperature within the safe operating temperature range, but above the normal operating temperature range. A temp warn bit set to zero indicates that the temperature is within the normal operating temperature range.

to match wording in the Temperature Sensor element

Status

relliott Accepted 12/19/2007 8:37:24 PM -06'00'

---



The format of the control field for a Cooling element is defined in table 71.

**Table 71 — Cooling element for control-type diagnostic pages**

Byte\Bit	7	6	5	4	3	2	1	0
0	COMMON CONTROL							
1	RQST IDENT	Reserved						
2	Reserved							
3	Reserved	RQST FAIL	RQST ON	Reserved		REQUESTED SPEED CODE		

The COMMON CONTROL field is specified in 7.2.2.

A RQST IDENT (request identify) bit set to one specifies that the enclosure services process identify the element by a visual indication. A RQST IDENT bit set to zero specifies that the enclosure services process not identify the element by a visual indication.

A RQST FAIL (request failure indication) bit set to one specifies that the enclosure services process shall enable a visual indication that a failure is present in the element. A RQST FAIL bit set to zero specifies that the enclosure services process shall disable a visual indication that a failure is present in the element, unless the enclosure services process is itself detecting a failure in the element.

A RQST ON (request Cooling element on) bit set to one specifies that the Cooling element be turned on or remain on. When the RQST ON bit is set to zero, the cooling element is requested to turn off or remain off.

The REQUESTED SPEED CODE field is set to specify the requested speed or rate of cooling of the fan or cooling device, as specified in table 72.

**Table 72 — REQUESTED SPEED CODE field**

Code	Description
000b	Leave fan at current speed
001b	Set fan to at lowest speed
010b	Set fan to second lowest speed
011b	Set fan to third lowest speed
100b	Set fan to intermediate speed
101b	Set fan to third highest speed
110b	Set fan to second highest speed
111b	Set fan to highest speed

The format of the status field for a cooling element is defined in table 73.

**Table 73 — Cooling element for status-type diagnostic pages**

Byte\Bit	7	6	5	4	3	2	1	0
0	COMMON STATUS							
1	IDENT	Reserved				(MSB)		
2	ACTUAL FAN SPEED (LSB)							
3	HOT SWAP	FAIL	RQSTED ON	OFF	Reserved	ACTUAL SPEED CODE		

The COMMON STATUS field is specified in 7.2.3.

Author: relliott  
Subject: Highlight  
Date: 5/12/2008 3:36:09 PM

**T** Cooling element  
s/b  
cooling mechanism

Status  
relliott Accepted 1/5/2008 6:28:35 PM -06'00'

---

Author: relliott  
Subject: Highlight  
Date: 5/12/2008 3:36:09 PM

**T** Cooling element  
s/b  
cooling mechanism

Status  
relliott Accepted 1/5/2008 6:28:24 PM -06'00'

---

Author: relliott  
Subject: Highlight  
Date: 5/12/2008 3:36:09 PM

**T** cooling element  
s/b  
cooling mechanism

Status  
relliott Accepted 1/5/2008 6:28:52 PM -06'00'

---

Author: relliott  
Subject: Highlight  
Date: 5/12/2008 3:36:09 PM

**T** is set to specify  
s/b  
specifies

Status  
relliott Accepted 1/5/2008 6:21:35 PM -06'00'

---

Author: relliott  
Subject: Highlight  
Date: 5/12/2008 3:36:09 PM

**T** fan or cooling  
device  
s/b  
cooling mechanism

Status  
relliott Accepted 1/5/2008 6:24:00 PM -06'00'

---

Author: relliott  
Subject: Highlight  
Date: 5/12/2008 3:36:09 PM

**T** as specified in  
s/b  
and is defined in

Status  
relliott Accepted 1/5/2008 6:21:45 PM -06'00'

---

The IDENT bit, the HOT SWAP bit, and the FAIL bit are defined in the Power Supply element (see 7.3.4).

The ACTUAL FAN SPEED field indicates the actual fan speed in revolutions per minute (RPM) when multiplied by a factor of 10 (e.g., 000h indicates 0 rpm and 7FFh indicates 20 470 rpm).

A RQSTED ON (requested on) bit set to one indicates that the cooling element has been manually turned on or has been requested to be turned on by setting the RQST ON control bit to one. The RQSTED ON bit is set to zero when the RQST ON control bit is set to zero.

An OFF bit set to one indicates the cooling element is not providing cooling. The OFF bit shall be set to one if the RQST ON control bit is set to zero to request the cooling element be turned off. The OFF bit shall be set to one if the cooling element is turned off manually. The OFF bit shall be set to one if a failure has caused the cooling element to stop operating. An OFF bit set to zero indicates the cooling element is operating.

The ACTUAL SPEED CODE field indicates the actual speed or rate of cooling of the fan or cooling device, as defined in table 74.

**Table 74 — ACTUAL SPEED CODE field**

Code	Description
000b	Fan stopped
001b	Fan at lowest speed
010b	Fan at second lowest speed
011b	Fan at third lowest speed
100b	Fan at intermediate speed
101b	Fan at third highest speed
110b	Fan at second highest speed
111b	Fan at highest speed

### 7.3.6 Temperature Sensor element

The Temperature Sensor element provides temperature indications to the application client. The temperature values may be compared with values that correspond to over temperature and under temperature failures and warnings.

If variable threshold values are implemented, the optional Threshold Out diagnostic page (see 6.1.8) may be used to override default temperature threshold values. The threshold field for Temperature Sensor elements shall have the same format and units as the TEMPERATURE field.

When the DISABLE bit (see 7.2.2) is set to one, the temperature sensor's output is not tested against any threshold values and no noncritical, critical, or unrecoverable conditions are indicated because of the temperature values sensed. When the DISABLE bit is set to zero, the temperature sensor's output is accepted normally by the enclosure services process.

The format of the control field for a Temperature Sensor element is defined in table 75.

**Table 75 — Temperature Sensor element for control-type diagnostic pages**

Byte\Bit	7	6	5	4	3	2	1	0
0	COMMON CONTROL							
1	RQST IDENT	RQST FAIL	Reserved					
2	Reserved							
3	Reserved							

The COMMON CONTROL field is specified in 7.2.2.

Author: relliott  
Subject: Highlight  
Date: 5/12/2008 3:36:09 PM  
**T** (RPM)  
s/b  
(rpm)

Status  
relliott Accepted 1/5/2008 7:11:04 PM -06'00'

---

Author: relliott  
Subject: Highlight  
Date: 5/12/2008 3:36:09 PM  
**T** cooling element  
s/b  
cooling mechanism

Status  
relliott Accepted 1/5/2008 6:25:49 PM -06'00'

---

Author: relliott  
Subject: Highlight  
Date: 5/12/2008 3:36:09 PM  
**T** cooling element  
s/b  
cooling mechanism

Status  
relliott Accepted 1/5/2008 6:26:00 PM -06'00'

---

Author: relliott  
Subject: Highlight  
Date: 5/12/2008 3:36:09 PM  
**T** cooling element  
s/b  
cooling mechanism

Status  
relliott Accepted 1/5/2008 6:26:12 PM -06'00'

---

Author: relliott  
Subject: Highlight  
Date: 5/12/2008 3:36:09 PM  
**T** cooling element  
s/b  
cooling mechanism

Status  
relliott Accepted 1/5/2008 6:26:35 PM -06'00'

---

Author: relliott  
Subject: Highlight  
Date: 5/12/2008 3:36:09 PM  
**T** cooling element  
s/b  
cooling mechanism

Status  
relliott Accepted 1/5/2008 6:26:24 PM -06'00'

---

Author: relliott  
Subject: Highlight  
Date: 5/12/2008 3:36:09 PM  
**T** fan or cooling device  
s/b  
cooling mechanism

Status

The IDENT bit, the HOT SWAP bit, and the FAIL bit are defined in the Power Supply element (see 7.3.4).

The ACTUAL FAN SPEED field indicates the actual fan speed in revolutions per minute (RPM) when multiplied by a factor of 10 (e.g., 000h indicates 0 rpm and 7FFh indicates 20 470 rpm).

A RQSTED ON (requested on) bit set to one indicates that the cooling element has been manually turned on or has been requested to be turned on by setting the RQST ON control bit to one. The RQSTED ON bit is set to zero when the RQST ON control bit is set to zero.

An OFF bit set to one indicates the cooling element is not providing cooling. The OFF bit shall be set to one if the RQST ON control bit is set to zero to request the cooling element be turned off. The OFF bit shall be set to one if the cooling element is turned off manually. The OFF bit shall be set to one if a failure has caused the cooling element to stop operating. An OFF bit set to zero indicates the cooling element is operating.

The ACTUAL SPEED CODE field indicates the actual speed or rate of cooling of the fan or cooling device, as defined in table 74.

**Table 74 — ACTUAL SPEED CODE field**

Code	Description
000b	Fan stopped
001b	Fan at lowest speed
010b	Fan at second lowest speed
011b	Fan at third lowest speed
100b	Fan at intermediate speed
101b	Fan at third highest speed
110b	Fan at second highest speed
111b	Fan at highest speed

**7.3.6 Temperature Sensor element**

The Temperature Sensor element provides temperature indications to the application client. The temperature values may be compared with values that correspond to over temperature and under temperature failures and warnings.

If variable threshold values are implemented, the optional Threshold Out diagnostic page (see 6.1.8) may be used to override default temperature threshold values. The threshold field for Temperature Sensor elements shall have the same format and units as the TEMPERATURE field.

When the DISABLE bit (see 7.2.2) is set to one, the temperature sensor's output is not tested against any threshold values and no noncritical, critical, or unrecoverable conditions are indicated because of the temperature values sensed. When the DISABLE bit is set to zero, the temperature sensor's output is accepted normally by the enclosure services process.

The format of the control field for a Temperature Sensor element is defined in table 75.

**Table 75 — Temperature Sensor element for control-type diagnostic pages**

Byte\Bit	7	6	5	4	3	2	1	0
0	COMMON CONTROL							
1	RQST IDENT	RQST FAIL	Reserved					
2	Reserved							
3	Reserved							

The COMMON CONTROL field is specified in 7.2.2.

relliott Accepted 1/5/2008 6:26:47 PM -06'00'

---

Author: relliott  
Subject: Cross-Out  
Date: 5/12/2008 3:36:09 PM  
 to the application client

Status  
relliott Accepted 12/17/2007 3:01:21 PM -06'00'  
Status  
relliott Confirmed 12/17/2007 3:01:24 PM -06'00'

---

Author: relliott  
Subject: Highlight  
Date: 5/12/2008 3:36:09 PM  
 provides temperature indications  
s/b  
manages a temperature sensor

Status  
relliott Accepted 12/21/2007 5:21:59 PM -06'00'

---

Author: relliott  
Subject: Highlight  
Date: 5/12/2008 3:36:09 PM  
 over temperature and under temperature failures and warnings  
s/b  
temperature failure and warnings

Status  
relliott Accepted 12/19/2007 8:42:12 PM -06'00'

---

Author: relliott  
Subject: Note  
Date: 5/12/2008 3:36:09 PM  
 Move the second sentence of the first paragraph into the second paragraph, so all the threshold rules are together

Status  
relliott Accepted 12/17/2007 3:01:42 PM -06'00'  
Status  
relliott Confirmed 12/17/2007 3:01:44 PM -06'00'

---

Author: ibm-gop  
Subject: Cross-Out  
Date: 12/13/2007 8:24:47 PM -06'00'  
 **7.3.6 Temperature Sensor element (2nd paragraph)**

**This << optional. >> should be deleted as everything is optional unless otherwise stated.**

Status  
relliott Accepted 12/17/2007 3:37:09 PM -06'00'  
Status  
relliott Confirmed 12/17/2007 3:37:13 PM -06'00'

---

Author: relliott  
Subject: Highlight  
Date: 5/12/2008 3:36:09 PM  
 The threshold field  
s/b  
Each threshold field

Status  
relliott Accepted 12/17/2007 2:52:12 PM -06'00'  
Status  
relliott Confirmed 12/17/2007 2:52:15 PM -06'00'

---

Author: relliott  
Subject: Highlight  
Date: 5/12/2008 3:36:09 PM  
 DISABLE bit (see 7.2.2)  
s/b  
DISABLE bit in the COMMON CONTROL field

The IDENT bit, the HOT SWAP bit, and the FAIL bit are defined in the Power Supply element (see 7.3.4).

The ACTUAL FAN SPEED field indicates the actual fan speed in revolutions per minute (RPM) when multiplied by a factor of 10 (e.g., 000h indicates 0 rpm and 7FFh indicates 20 470 rpm).

A RQSTED ON (requested on) bit set to one indicates that the cooling element has been manually turned on or has been requested to be turned on by setting the RQST ON control bit to one. The RQSTED ON bit is set to zero when the RQST ON control bit is set to zero.

An OFF bit set to one indicates the cooling element is not providing cooling. The OFF bit shall be set to one if the RQST ON control bit is set to zero to request the cooling element be turned off. The OFF bit shall be set to one if the cooling element is turned off manually. The OFF bit shall be set to one if a failure has caused the cooling element to stop operating. An OFF bit set to zero indicates the cooling element is operating.

The ACTUAL SPEED CODE field indicates the actual speed or rate of cooling of the fan or cooling device, as defined in table 74.

**Table 74 — ACTUAL SPEED CODE field**

Code	Description
000b	Fan stopped
001b	Fan at lowest speed
010b	Fan at second lowest speed
011b	Fan at third lowest speed
100b	Fan at intermediate speed
101b	Fan at third highest speed
110b	Fan at second highest speed
111b	Fan at highest speed

**7.3.6 Temperature Sensor element**

The Temperature Sensor element provides temperature indications to the application client. The temperature values may be compared with values that correspond to over temperature and under temperature failures and warnings.

If variable threshold values are implemented, the optional Threshold Out diagnostic page (see 6.1.8) may be used to override default temperature threshold values. The threshold field for Temperature Sensor elements shall have the same format and units as the TEMPERATURE field.

When the DISABLE bit (see 7.2.2) is set to one, the temperature sensor's output is not tested against any threshold values and no noncritical, critical, or unrecoverable conditions are indicated because of the temperature values sensed. When the DISABLE bit is set to zero, the temperature sensor's output is accepted normally by the enclosure services process.

The format of the control field for a Temperature Sensor element is defined in table 75.

**Table 75 — Temperature Sensor element for control-type diagnostic pages**

Byte\Bit	7	6	5	4	3	2	1	0
0	COMMON CONTROL							
1	RQST IDENT	RQST FAIL	Reserved					
2	Reserved							
3	Reserved							

The COMMON CONTROL field is specified in 7.2.2.

to match other paragraphs like this

Status  
relliott Accepted 12/21/2007 3:13:45 PM -06'00'

---

Author: relliott  
Subject: Note  
Date: 5/12/2008 3:36:09 PM

 Move the "When the DISABLE bit" paragraph into the COMMON CONTROL field paragraph for the control element, since it's a bit in that field

Status  
relliott Accepted 12/21/2007 3:14:22 PM -06'00'

---

Author: ibm-gop  
Subject: Highlight  
Date: 12/13/2007 8:24:47 PM -06'00'

### **T 7.3.6 Temperature Sensor element (3rd paragraph)**

**This << are indicated because of the temperature values sensed >> should be << are indicated as a result of the temperature values being sensed >>**

Status  
relliott Rejected 12/19/2007 8:19:03 PM -06'00'

---

Author: relliott  
Subject: Highlight  
Date: 5/12/2008 3:36:09 PM

**T** accepted normally

replace paragraph by:

When the disable bit (see 7.2.2) is set to one, the temperature sensor's output is ignored (i.e., not tested against any threshold values. No noncritical, critical, or unrecoverable conditions are indicated because of the temperature values sensed). When the disable bit is set to zero, the temperature sensor's output is not ignored.

to match IBM comments on current sensor, voltage sensor

Status  
relliott Accepted 12/19/2007 8:19:37 PM -06'00'

---

Author: hpq-relliott  
Subject: Note  
Date: 12/13/2007 8:24:34 PM -06'00'

 Join Reserved rows in table 75

Status  
relliott Accepted 12/13/2007 10:47:58 PM -06'00'

Status  
relliott Confirmed 12/13/2007 10:48:02 PM -06'00'

---



The RQST IDENT bit and the RQST FAIL bit are defined in the Cooling element (see 7.3.5).

The format of the status field for a Temperature Sensor element is defined in table 76.

**Table 76 — Temperature Sensor element for status-type diagnostic pages**

Byte\Bit	7	6	5	4	3	2	1	0
0	COMMON STATUS							
1	IDENT	FAIL	Reserved					
2	TEMPERATURE							
3	Reserved				OT FAILURE	OT WARNING	UT FAILURE	UT WARNING

The COMMON STATUS field is specified in 7.2.3.

The IDENT bit and the FAIL bit are defined in the Power Supply element (see 7.3.4).

The value in the TEMPERATURE field shall indicate the temperature at the sensor in degrees Celsius, offset by +20 degrees. The range of the value expresses a temperature between -19 and +235 degrees Celsius. The value of 0 is reserved. Thresholds may be set for the temperature element. The threshold value uses the same units and format.

An OT FAILURE (overtemperature failure) bit set to one indicates that the enclosure services process has detected a temperature higher than a safe operating temperature or higher than the value indicated by the HIGH CRITICAL THRESHOLD field in the Threshold In diagnostic page (see 6.1.9). An OT FAILURE bit set to zero indicates that the temperature has fallen to a safe operating temperature or below the value specified by the HIGH CRITICAL THRESHOLD field.

An OT WARNING (overtemperature warning) bit set to one indicates that the enclosure services process has detected a temperature higher than a normal operating temperature or higher than the value indicated by the HIGH WARNING THRESHOLD field in the Threshold In diagnostic page. An OT WARNING bit set to zero indicates that the temperature has fallen within the normal operating limits or below the value specified by the HIGH WARNING THRESHOLD field.

A UT FAILURE (undertemperature failure) bit set to one indicates that the enclosure services process has detected a temperature lower than a safe operating temperature or lower than the value indicated by the LOW CRITICAL THRESHOLD field in the Threshold In diagnostic page. A UT FAILURE bit set to zero indicates that the temperature has risen to a safe operating temperature or the above the value specified by the LOW CRITICAL THRESHOLD field.

A UT WARNING (undertemperature warning) bit set to one indicates that the enclosure services process has detected a temperature lower than a normal operating temperature or lower than the value indicated by the LOW WARNING THRESHOLD field in the Threshold In diagnostic page. A UT WARNING bit set to zero indicates that the temperature has risen within the normal operating limits or above the value specified by the LOW WARNING THRESHOLD field.

### 7.3.7 Door Lock element

The Audible Alarm element manages a door lock.

Author: relliott  
Subject: Highlight  
Date: 5/12/2008 3:36:09 PM  
 value in the TEMPERATURE field shall indicate  
s/b  
TEMPERATURE field indicates

Status  
relliott Accepted 4/9/2008 6:42:00 PM

Author: ibm-gop  
Subject: Highlight  
Date: 12/13/2007 8:24:47 PM -06'00'  
 **7.3.6 Temperature Sensor element (3rd paragraph after table 76)**  
This << The value of 0 is reserved. >> should be << The value of zero is reserved. >>

Status  
relliott Rejected 12/13/2007 9:53:44 PM -06'00'  
Status  
relliott Confirmed 12/13/2007 9:53:47 PM -06'00'

Author: relliott  
Subject: Note  
Date: 12/13/2007 9:53:41 PM -06'00'  
 00h

Author: relliott  
Subject: Highlight  
Date: 5/12/2008 3:36:09 PM  
 overtemperature  
s/b  
over temperature

Status  
relliott Accepted 12/19/2007 8:39:39 PM -06'00'

Author: relliott  
Subject: Note  
Date: 5/12/2008 3:36:09 PM  
 make these 4 paragraphs consistent with others:

An ot failure (overtemperature failure) bit set to one indicates that the temperature is above the safe operating temperature range or higher than the value indicated by the high critical threshold field in the Threshold In diagnostic page (see 6.1.9). An ot failure bit set to zero indicates that the temperature is within the safe operating temperature range or below the value specified by the high critical threshold field.

An ot warning (overtemperature warning) bit set to one indicates that the temperature is above the normal operating temperature range or higher than the value indicated by the high warning threshold field in the Threshold In diagnostic page. An ot warning bit set to zero indicates that the temperature is within the normal operating temperature range or below the value specified by the high warning threshold field.

A ut failure (undertemperature failure) bit set to one indicates that the temperature is below the safe operating temperature range or lower than the value indicated by the low critical threshold field in the Threshold In diagnostic page. A ut failure bit set to zero indicates that the temperature is within the safe operating temperature range or above the value specified by the low critical threshold field.

A ut warning (undertemperature warning) bit set to one indicates that the temperature is below the normal operating temperature range or lower than the value indicated by the low warning threshold field in the Threshold In diagnostic page. A ut warning bit set to zero indicates that the temperature is within the normal operating temperature range or above the value specified by the low warning threshold field.

Status  
relliott Accepted 12/19/2007 8:34:15 PM -06'00'

Author: relliott  
Subject: Highlight  
Date: 5/12/2008 3:36:09 PM

The RQST IDENT bit and the RQST FAIL bit are defined in the Cooling element (see 7.3.5).

The format of the status field for a Temperature Sensor element is defined in table 76.

**Table 76 — Temperature Sensor element for status-type diagnostic pages**

Byte/Bit	7	6	5	4	3	2	1	0
0	COMMON STATUS							
1	IDENT	FAIL	Reserved					
2	TEMPERATURE							
3	Reserved				OT FAILURE	OT WARNING	UT FAILURE	UT WARNING

The COMMON STATUS field is specified in 7.2.3.

The IDENT bit and the FAIL bit are defined in the Power Supply element (see 7.3.4).

The value in the TEMPERATURE field shall indicate the temperature at the sensor in degrees Celsius, offset by +20 degrees. The range of the value expresses a temperature between -19 and +235 degrees Celsius. The value of 0 is reserved. Thresholds may be set for the temperature element. The threshold value uses the same units and format.

An OT FAILURE (overtemperature failure) bit set to one indicates that the enclosure services process has detected a temperature higher than a safe operating temperature or higher than the value indicated by the HIGH CRITICAL THRESHOLD field in the Threshold In diagnostic page (see 6.1.9). An OT FAILURE bit set to zero indicates that the temperature has fallen to a safe operating temperature or below the value specified by the HIGH CRITICAL THRESHOLD field.

An OT WARNING (overtemperature warning) bit set to one indicates that the enclosure services process has detected a temperature higher than a normal operating temperature or higher than the value indicated by the HIGH WARNING THRESHOLD field in the Threshold In diagnostic page. An OT WARNING bit set to zero indicates that the temperature has fallen within the normal operating limits or below the value specified by the HIGH WARNING THRESHOLD field.

A UT FAILURE (undertemperature failure) bit set to one indicates that the enclosure services process has detected a temperature lower than a safe operating temperature or lower than the value indicated by the LOW CRITICAL THRESHOLD field in the Threshold In diagnostic page. A UT FAILURE bit set to zero indicates that the temperature has risen to a safe operating temperature or above the value specified by the LOW CRITICAL THRESHOLD field.

A UT WARNING (undertemperature warning) bit set to one indicates that the enclosure services process has detected a temperature lower than a normal operating temperature or lower than the value indicated by the LOW WARNING THRESHOLD field in the Threshold In diagnostic page. A UT WARNING bit set to zero indicates that the temperature has risen within the normal operating limits or above the value specified by the LOW WARNING THRESHOLD field.

### 7.3.7 Door Lock element

The Audible Alarm element manages a door lock.

**T** the temperature has fallen to a safe operating temperature or below the value specified by the HIGH CRITICAL THRESHOLD field  
s/b  
the temperature is a safe operating temperature or below the value specified by the high critical threshold field

Status  
relliott Accepted 12/19/2007 8:28:19 PM -06'00'

---

Author: relliott  
Subject: Highlight  
Date: 5/12/2008 3:36:09 PM  
**T** overtemperature  
s/b  
over temperature

Status  
relliott Accepted 12/19/2007 8:39:50 PM -06'00'

---

Author: relliott  
Subject: Highlight  
Date: 5/12/2008 3:36:09 PM  
**T** the temperature has fallen within the normal operating limits or below the value specified by the HIGH WARNING THRESHOLD field.  
s/b  
the temperature is within the normal operating limits or below the value specified by the high warning threshold field

Status  
relliott Accepted 12/19/2007 8:28:16 PM -06'00'

---

Author: relliott  
Subject: Highlight  
Date: 5/12/2008 3:36:09 PM  
**T** undertemperature  
s/b  
under temperature

Status  
relliott Accepted 12/19/2007 8:40:05 PM -06'00'

---

Author: relliott  
Subject: Highlight  
Date: 5/12/2008 3:36:09 PM  
**T** has risen to  
s/b  
is

Status  
relliott Accepted 12/19/2007 8:29:22 PM -06'00'

---

Author: relliott  
Subject: Highlight  
Date: 5/12/2008 3:36:09 PM  
**T** undertemperature  
s/b  
under temperature

Status  
relliott Accepted 12/19/2007 8:40:16 PM -06'00'

---

Author: relliott  
Subject: Highlight  
Date: 5/12/2008 3:36:09 PM  
**T** normal operating limits  
s/b  
normal operating temperature range

Status  
relliott Accepted 12/19/2007 8:33:46 PM -06'00'

---

Author: relliott  
Subject: Highlight

Comments from page 76 continued on next page

The RQST IDENT bit and the RQST FAIL bit are defined in the Cooling element (see 7.3.5).

The format of the status field for a Temperature Sensor element is defined in table 76.

**Table 76 — Temperature Sensor element for status-type diagnostic pages**

Byte\Bit	7	6	5	4	3	2	1	0
0	COMMON STATUS							
1	IDENT	FAIL	Reserved					
2	TEMPERATURE							
3	Reserved				OT FAILURE	OT WARNING	UT FAILURE	UT WARNING

The COMMON STATUS field is specified in 7.2.3.

The IDENT bit and the FAIL bit are defined in the Power Supply element (see 7.3.4).

The value in the TEMPERATURE field shall indicate the temperature at the sensor in degrees Celsius, offset by +20 degrees. The range of the value expresses a temperature between -19 and +235 degrees Celsius. The value of 0 is reserved. Thresholds may be set for the temperature element. The threshold value uses the same units and format.



An OT FAILURE (overtemperature failure) bit set to one indicates that the enclosure services process has detected a temperature higher than a safe operating temperature or higher than the value indicated by the HIGH CRITICAL THRESHOLD field in the Threshold In diagnostic page (see 6.1.9). An OT FAILURE bit set to zero indicates that the temperature has fallen to a safe operating temperature or below the value specified by the HIGH CRITICAL THRESHOLD field.

An OT WARNING (overtemperature warning) bit set to one indicates that the enclosure services process has detected a temperature higher than a normal operating temperature or higher than the value indicated by the HIGH WARNING THRESHOLD field in the Threshold In diagnostic page. An OT WARNING bit set to zero indicates that the temperature has fallen within the normal operating limits or below the value specified by the HIGH WARNING THRESHOLD field.

A UT FAILURE (undertemperature failure) bit set to one indicates that the enclosure services process has detected a temperature lower than a safe operating temperature or lower than the value indicated by the LOW CRITICAL THRESHOLD field in the Threshold In diagnostic page. A UT FAILURE bit set to zero indicates that the temperature has risen to a safe operating temperature or above the value specified by the LOW CRITICAL THRESHOLD field.

A UT WARNING (undertemperature warning) bit set to one indicates that the enclosure services process has detected a temperature lower than a normal operating temperature or lower than the value indicated by the LOW WARNING THRESHOLD field in the Threshold In diagnostic page. A UT WARNING bit set to zero indicates that the temperature has risen within the normal operating limits or above the value specified by the LOW WARNING THRESHOLD field.

**7.3.7 Door Lock element**

The Audible Alarm element manages a door lock.

Date: 5/12/2008 3:36:09 PM

**T** has risen within  
s/b  
is within

Status

relliott Accepted 12/19/2007 8:29:37 PM -06'00'

---

Author: relliott

Subject: Highlight

Date: 5/12/2008 3:36:09 PM

**T** Audible Alarm

s/b  
Door Lock

Status

relliott Accepted 12/21/2007 5:21:44 PM -06'00'

---

The format of the control field for a Door Lock element is defined in table 77.

**Table 77 — Door Lock element for control-type diagnostic pages**

Byte\Bit	7	6	5	4	3	2	1	0
0	COMMON CONTROL							
1	RQST IDENT	RQST FAIL	Reserved					
2	Reserved							
3	Reserved							UNLOCK

The COMMON CONTROL field is specified in 7.2.2.

The RQST IDENT bit and the RQST FAIL bit are defined in the Cooling element (see 7.3.5).

An UNLOCK bit set to one specifies that the door latch be unlocked or remain unlocked. An UNLOCK bit set to zero specifies that the door latch be locked or remain locked.

The format of the status field for a Door Lock element is defined in table 78.

**Table 78 — Door Lock element for status-type diagnostic pages**

Byte\Bit	7	6	5	4	3	2	1	0
0	COMMON STATUS							
1	IDENT	FAIL	Reserved					
2	Reserved							
3	Reserved							UNLOCKED

The COMMON STATUS field is specified in 7.2.3.

The IDENT bit and the FAIL bit are defined in the Power Supply element (see 7.3.4).

An UNLOCKED bit set to one indicates that the door latch is unlocked. An UNLOCKED bit set to zero indicates that the door latch is locked or in its normal operating state.

### 7.3.8 Audible Alarm element

The Audible Alarm element manages an audible alarm.

When the DISABLE bit in the COMMON CONTROL field (see 7.2.2) is set to one, the audible alarm shall be disabled and emit no sound regardless of the error condition that exists. When the DISABLE bit is set to zero, the audible alarm is enabled and may emit sound when an error condition exist.

The format of the control field for an Audible Alarm element is defined in table 79.

**Table 79 — Audible Alarm element for control-type diagnostic pages**

Byte\Bit	7	6	5	4	3	2	1	0
0	COMMON CONTROL							
1	RQST IDENT	RQST FAIL	Reserved					
2	Reserved							
3	Reserved	SET MUTE	Reserved	SET REMIND	TONE URGENCY CONTROL			
					INFO	NON-CRIT	CRIT	UNRECOV

Author: relliott

Subject: Note

Date: 5/12/2008 3:36:09 PM



Move the "When the DISABLE bit" paragraph into the COMMON CONTROL field paragraph for the control element, since it's a bit in that field

Status

relliott Accepted 12/21/2007 3:14:32 PM -06'00'

---



The COMMON CONTROL field is specified in 7.2.2.

The RQST IDENT bit and the RQST FAIL bit are defined in the Cooling element (see 7.3.5).

A SET MUTE bit set to one specifies that the alarm be placed in the muted state. The alarm shall emit no sound when in the muted state. When the SET MUTE bit is set to zero, the alarm is set to the un-muted state and the tone appropriate to the most urgent condition present shall be generated. When the SET MUTE bit is set to one, the reminding tone is also muted.

A SET REMIND bit set to one specifies that the alarm emit a tone suitable for reminding the user that other tones are active. When the SET REMIND bit is set to zero, the alarm emits the tone appropriate to the most urgent condition that is present.

Each of the TONE URGENCY CONTROL bits requests that the audible alarm emit a tone of increasing urgency (bit 3, least urgent). If more than one bit is set to one, the tone that signals the most urgent of the selected conditions is activated.

The quality of each tone and the use of separate tones is vendor specific. The bits and tones may be set either by the TONE URGENCY CONTROL bits or by the enclosure services process. The TONE URGENCY CONTROL bits set by the enclosure are not affected by the SET MUTE bit or the SET REMIND bit, although the tone emitted by the alarm is modified by the bits.

If a new error condition occurs while the audible alarm is set in the remind or muted state, the state is cleared and the normal alarm conditions occur for that error condition, but not the previous error condition.

If all bits are set to zero, the audible alarm is silent until a new error condition occurs.

An INFO (informational condition tone urgency control) bit set to one specifies that the audible alarm emit a tone suitable to warn of an information condition. The INFO bit is set to zero to stop requesting the audible alarm to emit the tone.

A NON-CRIT (noncritical condition tone urgency control) bit set to one specifies that the audible alarm emit a tone suitable to warn of a noncritical condition. The NON-CRIT bit is set to zero to stop requesting the audible alarm to emit the tone.

A CRIT (critical condition tone urgency control) bit set to one specifies that the audible alarm emit a tone suitable to warn of a critical condition. The CRIT bit is set to zero to stop requesting the audible alarm to emit the tone.

An UNRECOV (unrecoverable condition tone urgency control) bit set to one specifies that the audible alarm emit a tone suitable to warn of an unrecoverable condition. The UNRECOV bit is set to zero to stop requesting the audible alarm to emit the tone.

The format of the status field for an Audible Alarm element is defined in table 80.

**Table 80 — Audible Alarm element for status-type diagnostic pages**

Byte\Bit	7	6	5	4	3	2	1	0
0	COMMON STATUS							
1	IDENT	FAIL	Reserved					
2	Reserved							
3	RQST MUTE	MUTED	Reserved	REMIND	TONE URGENCY INDICATOR			
					INFO	NON-CRIT	CRIT	UNRECOV

The COMMON STATUS field is specified in 7.2.3.

The IDENT bit and the FAIL bit are defined in the Power Supply element (see 7.3.4).

A RQST MUTE (request mute) bit set to one indicates that a panel control has been manipulated to request that the audible alarm be muted. A RQST MUTE bit set to zero indicates that the the SET MUTE control bit has been set to one.

This page contains no comments

A MUTED bit set to one indicates that the audible alarm is in the muted state. A MUTED bit set to zero indicates that the audible alarm is in the un-muted state. No sound is emitted by the audible alarm when it is in the muted state.

A REMIND bit set to one indicates that the audible alarm is in the remind state. A REMIND bit set to zero indicates that the audible alarm is not in the remind state.

Each bit indicates a tone of increasing urgency (bit 3 is least urgent). If more than one bit is set to one, the tone that signals the most urgent of the indicated conditions is active.

If all bits are set to zero or if the MUTED bit is set to one, the audible alarm is silent. If the REMIND bit is set to one, the audible alarm tone is modified to the remind tone.

An INFO (information condition tone urgency indicator) bit set to one indicates that the audible alarm is emitting a tone suitable to warn of an information condition unless a more urgent tone is also indicated. An INFO bit set to zero indicates that the audible alarm is not emitting the corresponding tone.

A NON-CRIT (noncritical condition tone urgency indicator) bit set to one indicates that the audible alarm is emitting a tone suitable to warn of a noncritical condition unless a more urgent tone is also indicated. A NON-CRIT bit set to zero indicates that the audible alarm is not emitting the corresponding tone.

A CRIT (critical condition tone urgency indicator) bit set to one indicates that the audible alarm is emitting a tone suitable to warn of a critical condition unless a more urgent tone is also indicated. A CRIT bit set to zero indicates that the audible alarm is not emitting the corresponding tone.

An UNRECOV (unrecoverable condition tone urgency indicator) bit set to one indicates that the audible alarm is emitting a tone suitable to warn of an unrecoverable condition. An UNRECOV bit set to zero indicates that the audible alarm is not emitting the corresponding tone.

**7.3.9 Enclosure Services Controller Electronics element**

The Enclosure Services Controller Electronics element manages the processor circuitry used by the enclosure services process.

The format of the control field for an Enclosure Services Controller Electronics element is defined in table 81.

**Table 81 — Enclosure Services Controller Electronics element for control-type diagnostic pages**

Byte\Bit	7	6	5	4	3	2	1	0
0	COMMON CONTROL							
1	RQST IDENT	RQST FAIL	Reserved					
2	Reserved							SELECT ELEMENT
3	Reserved							

The COMMON CONTROL field is specified in 7.2.2.

The RQST IDENT bit and the RQST FAIL bit are defined in the Cooling element (see 7.3.5).

A SELECT ELEMENT bit set to one specifies that the enclosure services process represented by the specified Enclosure Services Controller Electronics element be assigned to be the active enclosure services process. The active enclosure services process prepares all the status-type diagnostic pages and interprets all control-type diagnostic pages. It may make use of or operate in parallel with other Enclosure Services Controller Electronics elements. The selection may be overridden by vendor specific conventions among multiple Enclosure Services Controller Electronics elements. A SELECT ELEMENT bit set to zero specifies that the specified Enclosure Services Controller Electronics element shall not be the active enclosure services process. If no element has been selected as the active enclosure services process or if multiple elements have been selected, the choice of the active element is vendor specific.

This page contains no comments

The format of the status field for an Enclosure Services Controller Electronics element is defined in table 82.

**Table 82 — Enclosure Services Controller Electronics element for status-type diagnostic pages**

Byte\Bit	7	6	5	4	3	2	1	0
0	COMMON STATUS							
1	IDENT	FAIL	Reserved					
2	Reserved							REPORT
3	HOT SWAP	Reserved						

The COMMON STATUS field is specified in 7.2.3.

The IDENT bit, the FAIL bit, and the HOT SWAP bit are defined in the Power Supply element (see 7.3.4).

A REPORT bit set to one indicates that the Enclosure Services Controller Electronics element described by this ELEMENT STATUS field is the active enclosure services process for the subenclosure. A REPORT bit set to zero indicates the Enclosure Services Controller Electronics element described by this ELEMENT STATUS field is not the active enclosure services process for the subenclosure.

**7.3.10 SCC Controller Electronics element**

The SCC Controller Electronics element manages the processor circuitry used by a SCSI Controller Commands (SCC) device server (e.g., in a RAID controller, the RAID controller processor).

The format of the control field for an SCC Controller Electronics element is defined in table 83.

**Table 83 — SCC Controller Electronics element for control-type diagnostic pages**

Byte\Bit	7	6	5	4	3	2	1	0
0	COMMON CONTROL							
1	RQST IDENT	RQST FAIL	Reserved					
2	Reserved							
3	Reserved							

The COMMON CONTROL field is specified in 7.2.2.

The RQST IDENT bit and the RQST FAIL bit are defined in the Cooling element (see 7.3.5).

The format of the status field for an SCC Controller Electronics element is defined in table 84.

**Table 84 — SCC Controller Electronics element for status-type diagnostic pages**

Byte\Bit	7	6	5	4	3	2	1	0
0	COMMON STATUS							
1	IDENT	FAIL	Reserved					
2	Reserved							REPORT
3	Reserved							

The COMMON STATUS field is specified in 7.2.3.

The IDENT bit and the FAIL bit are defined in the Power Supply element (see 7.3.4).

A REPORT is set to one indicates that this SCC Controller Electronics element provided the physical path for the transmission of the status-type diagnostic page. This relates the SCSI target port and logical unit

● Author: relliott  
Subject: Highlight  
Date: 5/12/2008 3:36:09 PM  
 Enclosure Services Controller Electronics element  
s/b  
processor circuitry

Status  
relliott Accepted 1/4/2008 6:41:37 PM -06'00'

---

● Author: relliott  
Subject: Highlight  
Date: 5/12/2008 3:36:09 PM  
 Enclosure Services Controller Electronics element  
s/b  
processor circuitry

Status  
relliott Accepted 1/4/2008 6:41:48 PM -06'00'

---

● Author: hpq-relliott  
Subject: Note  
Date: 12/13/2007 8:24:34 PM -06'00'  
 Join Reserved rows in table 83

Status  
relliott Accepted 12/13/2007 9:55:33 PM -06'00'  
Status  
relliott Confirmed 12/13/2007 9:55:36 PM -06'00'

---

● Author: relliott  
Subject: Highlight  
Date: 5/12/2008 3:36:09 PM  
 this SCC Controller Electronics element provided the physical path for  
the transmission of  
s/b  
the enclosure services process is using this processor circuitry to return

Status  
relliott Accepted 1/4/2008 6:38:53 PM -06'00'

---

● Author: relliott  
Subject: Highlight  
Date: 5/12/2008 3:36:09 PM  
 status-type diagnostic page  
s/b  
Enclosure Status diagnostic page

Status  
relliott Accepted 1/3/2008 6:03:33 PM -06'00'

---

addressed by the RECEIVE DIAGNOSTIC RESULTS command to the SCC Controller Electronics element. A REPORT bit set to zero indicates that this SCC Controller Electronics element did not participate in the transmission of the status-type diagnostic page.

**7.3.11 Nonvolatile Cache element**

The Nonvolatile Cache element manages a nonvolatile cache (e.g., in a RAID controller, a battery-backed write cache).

The format of the control field for Nonvolatile Cache element is defined in table 85.

**Table 85 — Nonvolatile Cache element for control-type diagnostic pages**

Byte\Bit	7	6	5	4	3	2	1	0
0	COMMON CONTROL							
1	RQST IDENT	RQST FAIL	Reserved					
2	Reserved							
3	Reserved							

The COMMON CONTROL field is specified in 7.2.2.

The RQST IDENT bit and the RQST FAIL bit are defined in the Cooling element (see 7.3.5).

The format of the status field for a Nonvolatile Cache element is defined in table 86.

**Table 86 — Nonvolatile Cache element for status-type diagnostic pages**

Byte\Bit	7	6	5	4	3	2	1	0
0	COMMON STATUS							
1	IDENT	FAIL	Reserved				SIZE MULTIPLIER	
2	(MSB) NONVOLATILE CACHE SIZE							
3	(LSB)							

The COMMON STATUS field is specified in 7.2.3.

The IDENT bit and the FAIL bit are defined in the Power Supply element (see 7.3.4).

The NONVOLATILE CACHE SIZE field and the SIZE MULTIPLIER indicate the approximate size of the nonvolatile cache. The SIZE MULTIPLIER field defines the units of the NONVOLATILE CACHE SIZE field as shown in table 87.

**Table 87 — SIZE MULTIPLIER field and NONVOLATILE CACHE SIZE field**

Code	Units of NONVOLATILE CACHE SIZE
00b	Bytes
01b	Kibibytes <sup>a</sup> (2 <sup>10</sup> bytes)
10b	Mebibytes <sup>a</sup> (2 <sup>20</sup> bytes)
11b	Gibibytes <sup>a</sup> (2 <sup>30</sup> bytes)

<sup>a</sup> This nomenclature is defined in IEC 60027-2:2000, *Letter symbols to be used in electrical technology - Part 2: Telecommunications and electronics.*

Failures of the Nonvolatile Cache may require immediate changes in the operating mode of elements in the enclosure. Information in the cache may be corrupted after such a failure.

Author: relliott  
Subject: Highlight  
Date: 5/12/2008 3:36:09 PM  
**T** this SCC Controller Electronics element did not participate in the transmission of s/b it is not using this processor circuitry to return

Status  
relliott Accepted 1/4/2008 6:39:15 PM -06'00'

---

Author: relliott  
Subject: Highlight  
Date: 5/12/2008 3:36:09 PM  
**T** status-type diagnostic page s/b Enclosure Status diagnostic page

Status  
relliott Accepted 1/3/2008 7:00:06 PM -06'00'

---

Author: hpq-relliott  
Subject: Note  
Date: 12/13/2007 8:24:34 PM -06'00'  
 Join Reserved rows in table 85

Status  
relliott Accepted 12/13/2007 9:56:36 PM -06'00'  
Status  
relliott Confirmed 12/13/2007 9:56:40 PM -06'00'

---

Author: ibm-gop  
Subject: Highlight  
Date: 12/13/2007 8:24:47 PM -06'00'  
**T** 7.3.11 Nonvolatile Cache element (3rd paragraph after table 86)

**This << and the SIZE MULTIPLIER indicate the approximate size >> should be << and the SIZE MULTIPLIER field indicate the approximate size >>**

Status  
relliott Accepted 12/13/2007 9:57:11 PM -06'00'  
Status  
relliott Confirmed 12/13/2007 9:57:20 PM -06'00'

---

Author: relliott  
Subject: Highlight  
Date: 5/12/2008 3:36:09 PM  
**T** defines the units of the NONVOLATILE CACHE SIZE field as shown in s/b indicates the units ... as defined in

Status  
relliott Accepted 1/5/2008 6:34:07 PM -06'00'

---



7.3.12 Invalid Operation Reason element

An Invalid Operation Reason element is used to report information about why an INVOP bit is set to one. It is only meaningful in the pages which define INVOP bits (e.g., the Enclosure Status and Threshold In diagnostic pages).

The format of the control field for an Invalid Operation Reason element is shown in table 88.

Table 88 — Invalid Operation Reason element for control-type diagnostic pages

Byte\Bit	7	6	5	4	3	2	1	0
0	COMMON CONTROL							
1	Reserved							
2	Reserved							
3	Reserved							

The COMMON CONTROL field is specified in 7.2.2.

The format of the status field for an Invalid Operation Reason element is defined in table 89.

Table 89 — Invalid Operation Reason element for status-type diagnostic pages

Byte\Bit	7	6	5	4	3	2	1	0
0	COMMON STATUS							
1	INVOP TYPE							
2			INVOP-TYPE SPECIFIC					
3								

The COMMON STATUS field is specified in 7.2.3.

Table 90 defines the INVOP TYPE field, which defines the format of the INVOP TYPE-SPECIFIC bytes.

Table 90 — INVOP TYPE field

Code	Description	Reference
00b	SEND DIAGNOSTIC page code error	Table 91
01b	SEND DIAGNOSTIC page format error	Table 92
10b	Reserved	
11b	Vendor-specific error	Table 93

The format of the status field when INVOP TYPE is 00b is defined in table 91.

Table 91 — Invalid Operation Reason element for status-type diagnostic pages with INVOP TYPE of 00b

Byte\Bit	7	6	5	4	3	2	1	0
0	COMMON STATUS							
1	INVOP TYPE (00b)		Reserved					PAGE NOT SUPPORTED
2			Reserved					
3								

The COMMON STATUS field is specified in 7.2.3.

## Page: 82

---

Author: relliott  
Subject: Highlight  
Date: 5/12/2008 3:36:09 PM

 An Invalid  
s/b  
The Invalid

Status  
relliott Accepted 1/4/2008 11:51:50 AM -06'00'

---

Author: ibm-gop  
Subject: Highlight  
Date: 12/13/2007 8:24:47 PM -06'00'

 **7.3.12 Invalid Operation Reason element (1st paragraph)**

**This << It is only meaningful in the pages which define INVOP >> should be << It is only valid in the pages which define INVOP >>**

Status  
relliott Rejected 12/19/2007 8:44:15 PM -06'00'

---

Author: relliott  
Subject: Note  
Date: 1/4/2008 11:52:31 AM -06'00'

 sentence deleted. First sentence rewritten as:  
The Invalid Operation Reason element is used to report information about why the invop bit is set to one in the Enclosure Status diagnostic page (see 6.1.4) or the Threshold In Status diagnostic page (see 6.1.9).

---

Author: hpq-relliott  
Subject: Note  
Date: 12/13/2007 8:24:34 PM -06'00'

 Join Reserved rows in table 88 (maybe keep all three rows though)

Status  
relliott Accepted 12/13/2007 9:57:33 PM -06'00'

Status  
relliott Confirmed 12/13/2007 9:57:36 PM -06'00'

---

Author: ibm-gop  
Subject: Highlight  
Date: 12/13/2007 8:24:47 PM -06'00'

 **7.3.12 Invalid Operation Reason element (table 89)**  
**This << INVOP-TYPE SPECIFIC >> should be << invop-type specific descriptor >>**

Status  
relliott Rejected 12/17/2007 2:46:27 PM -06'00'

Status  
relliott Confirmed 12/17/2007 2:46:30 PM -06'00'

---

Author: relliott  
Subject: Note  
Date: 12/17/2007 2:46:31 PM -06'00'

 invalid operation type specific bytes

---

Author: relliott  
Subject: Note  
Date: 5/12/2008 3:36:09 PM

 Define the Invalid Operation Reason threshold control element field usage (all Ignored)

Status  
relliott Accepted 1/4/2008 11:54:19 AM -06'00'

---

Author: ibm-gop  
Subject: Highlight  
Date: 12/13/2007 8:24:47 PM -06'00'

Comments from page 82 continued on next page

7.3.12 Invalid Operation Reason element

An Invalid Operation Reason element is used to report information about why an INVOP bit is set to one. It is only meaningful in the pages which define INVOP bits (e.g., the Enclosure Status and Threshold In diagnostic pages).

The format of the control field for an Invalid Operation Reason element is shown in table 88.

Table 88 — Invalid Operation Reason element for control-type diagnostic pages

Byte\Bit	7	6	5	4	3	2	1	0
0	COMMON CONTROL							
1	Reserved							
2	Reserved							
3	Reserved							

The COMMON CONTROL field is specified in 7.2.2.

The format of the status field for an Invalid Operation Reason element is defined in table 89.

Table 89 — Invalid Operation Reason element for status-type diagnostic pages

Byte\Bit	7	6	5	4	3	2	1	0
0	COMMON STATUS							
1	INVOP TYPE							
2	INVOP-TYPE SPECIFIC							
3								

The COMMON STATUS field is specified in 7.2.3.

Table 90 defines the INVOP TYPE field, which defines the format of the INVOP TYPE-SPECIFIC bytes.

Table 90 — INVOP TYPE field

Code	Description	Reference
00b	SEND DIAGNOSTIC page code error	Table 91
01b	SEND DIAGNOSTIC page format error	Table 92
10b	Reserved	
11b	Vendor-specific error	Table 93

The format of the status field when INVOP TYPE is 00b is defined in table 91.

Table 91 — Invalid Operation Reason element for status-type diagnostic pages with INVOP TYPE of 00b

Byte\Bit	7	6	5	4	3	2	1	0
0	COMMON STATUS							
1	INVOP TYPE (00b)		Reserved				PAGE NOT SUPPORTED	
2	Reserved							
3								

The COMMON STATUS field is specified in 7.2.3.

**T 7.3.12 Invalid Operation Reason element (2nd paragraph after table 89)**

This << INVOP TYPE-SPECIFIC bytes. >> should be << should be << invop-type specific descriptor >>

Status  
relliott Rejected 12/17/2007 2:46:55 PM -06'00'  
Status  
relliott Confirmed 12/17/2007 2:46:58 PM -06'00'

---

Author: relliott  
Subject: Note  
Date: 12/17/2007 2:47:00 PM -06'00'  
 format of the invalid operation type specific bytes

---

Author: relliott  
Subject: Note  
Date: 5/12/2008 3:36:09 PM  
 Define the Invalid Operation Reason threshold status element field usage  
Byte 0: Reserved  
Byte 1: Same as byte 1 of the status element  
Byte 2: Same as byte 2 of the status element  
Byte 3: Same as byte 3 of the status element

---

Status  
relliott Accepted 1/4/2008 11:55:05 AM -06'00'

---

Author: hpq-relliott  
Subject: Highlight  
Date: 12/13/2007 8:24:34 PM -06'00'  
**T** INVOP TYPE is  
s/b  
the INVOP TYPE field is set to

---

Status  
relliott Accepted 12/13/2007 10:46:04 PM -06'00'  
Status  
relliott Confirmed 12/13/2007 10:46:08 PM -06'00'

---

Author: ibm-gop  
Subject: Highlight  
Date: 12/13/2007 8:24:47 PM -06'00'  
**T** 7.3.12 Invalid Operation Reason element (1st paragraph after table 90)  
This << The format of the status field when INVOP TYPE is 00b is defined in table 91. >> should be << The format of the status field when INVOP TYPE field is set to 00b is defined in table 91. >>

---

Status  
relliott Accepted 12/19/2007 8:45:06 PM -06'00'

---

Author: ibm-gop  
Subject: Highlight  
Date: 12/13/2007 8:24:47 PM -06'00'  
**T** 7.3.12 Invalid Operation Reason element (table 91 title)  
This << status-type diagnostic pages with INVOP TYPE of 00b >> should be << status-type diagnostic pages with INVOP TYPE field set to 00b >>

---

Status  
relliott Accepted 12/19/2007 8:44:43 PM -06'00'

---

Author: hpq-relliott  
Subject: Highlight  
Date: 12/13/2007 10:45:52 PM -06'00'  
**T** INVOP TYPE of  
s/b  
the INVOP TYPE field set to

---

Status  
relliott Accepted 12/13/2007 10:45:55 PM -06'00'  
Status  
relliott Confirmed 12/13/2007 10:45:57 PM -06'00'

---

The PAGE NOT SUPPORTED bit indicates that a SEND DIAGNOSTIC command requested a diagnostic page not supported by the enclosure service process. This bit is only set to one when this element is returned by the Enclosure Status diagnostic page (see 6.1.4).

The format of the status field when INVOP TYPE is 01b is defined in table 92.

**Table 92 — Invalid Operation Reason element for status-type diagnostic pages with INVOP TYPE of 01b**

Byte\Bit	7	6	5	4	3	2	1	0
0	COMMON STATUS							
1	INVOP TYPE (01b)		Reserved			BIT NUMBER		
2	(MSB)							
3	BYTE OFFSET							(LSB)

The COMMON STATUS field is specified in 7.2.3.

The BIT NUMBER field contains the bit number of the most significant bit of the field responsible for the INVOP bit being set to one.

The BYTE OFFSET field contains the byte offset of the most significant byte of the field responsible for the INVOP bit being set to one.

The format of the status field when INVOP TYPE is 11b is defined in table 93.

**Table 93 — Invalid Operation Reason element for status-type diagnostic pages with INVOP TYPE of 11b**

Byte\Bit	7	6	5	4	3	2	1	0
0	COMMON STATUS							
1	INVOP TYPE (11b)							
2	Vendor-specific							
3								

The COMMON STATUS field is specified in 7.2.3.

### 7.3.13 Uninterruptible Power Supply element

The Uninterruptible Power Supply element manages an uninterruptible power supply (e.g., providing power to a power supply (see 7.3.4)).

The format of the control field for an Uninterruptible Power Supply element is defined in table 94.

**Table 94 — Uninterruptible Power Supply element for control-type diagnostic pages**

Byte\Bit	7	6	5	4	3	2	1	0
0	COMMON CONTROL							
1	Reserved							
2	Reserved							
3	RQST IDENT	RQST FAIL	Reserved					

The COMMON CONTROL field is specified in 7.2.2.

The RQST IDENT bit and the RQST FAIL bit are defined in the Cooling element (see 7.3.5).



Author: ibm-gop  
Subject: Highlight  
Date: 12/13/2007 8:24:47 PM -06'00'

**T 7.3.12 Invalid Operation Reason element (2nd paragraph after table 91)**

This << This bit is only set to one when this element is returned by the >> should be << The PAGE NOT SUPPORTED bit is only set to one when this element is returned by the >>

Status  
relliott Rejected 1/4/2008 12:01:36 PM -06'00'

Author: relliott  
Subject: Note  
Date: 1/4/2008 7:36:53 PM -06'00'

 This points to a major problem. The Threshold In diagnostic page doesn't return the status element as defined in table 92 (with the common status field in byte 1) - it always returns threshold status elements with 4 critical/warning fields (as defined in the diagnostic page section in ses2r19... moving into chapter 7 by letter ballot resolution). This is being fixed per numerous other comments.

The rule that this bit shall be zero will be included in the threshold status element definition for this element. This sentence will be deleted from this location.

Author: relliott  
Subject: Highlight  
Date: 5/12/2008 3:36:09 PM

**T** service process  
s/b  
services process

Status  
relliott Accepted 12/13/2007 9:23:03 PM -06'00'

Status  
relliott Confirmed 12/13/2007 9:22:59 PM -06'00'

Author: hpq-relliott  
Subject: Highlight  
Date: 12/13/2007 8:24:34 PM -06'00'

**T** INVOP TYPE is  
s/b  
the INVOP TYPE field is set to

Status  
relliott Accepted 12/13/2007 10:46:21 PM -06'00'

Status  
relliott Confirmed 12/13/2007 10:46:24 PM -06'00'

Author: ibm-gop  
Subject: Highlight  
Date: 12/13/2007 8:24:47 PM -06'00'

**T 7.3.12 Invalid Operation Reason element (3rd paragraph after table 91)**

This << The format of the status field when INVOP TYPE is 01b is defined in table 92. >> should be << The format of the status field when INVOP TYPE field is set to 01b is defined in table 92. >>

Status  
relliott Accepted 12/19/2007 7:33:38 PM -06'00'

Author: ibm-gop  
Subject: Highlight  
Date: 12/13/2007 8:24:47 PM -06'00'

**T 7.3.12 Invalid Operation Reason element (table 92 title)**

This << status-type diagnostic pages with INVOP TYPE of 01b >> should be << status-type diagnostic pages with INVOP TYPE field set to 01b >>

Status

The PAGE NOT SUPPORTED bit indicates that a SEND DIAGNOSTIC command requested a diagnostic page not supported by the enclosure service process. This bit is only set to one when this element is returned by the Enclosure Status diagnostic page (see 6.1.4).

The format of the status field when INVOP TYPE is 01b is defined in table 92.

**Table 92 — Invalid Operation Reason element for status-type diagnostic pages with INVOP TYPE of 01b**

Byte\Bit	7	6	5	4	3	2	1	0
0	COMMON STATUS							
1	INVOP TYPE (01b)		Reserved			BIT NUMBER		
2	(MSB)							
3	BYTE OFFSET (LSB)							

The COMMON STATUS field is specified in 7.2.3.

The BIT NUMBER field contains the bit number of the most significant bit of the field responsible for the INVOP bit being set to one.

The BYTE OFFSET field contains the byte offset of the most significant byte of the field responsible for the INVOP bit being set to one.

The format of the status field when INVOP TYPE is 11b is defined in table 93.

**Table 93 — Invalid Operation Reason element for status-type diagnostic pages with INVOP TYPE of 11b**

Byte\Bit	7	6	5	4	3	2	1	0
0	COMMON STATUS							
1	INVOP TYPE (11b)							
2	Vendor-specific							
3								

The COMMON STATUS field is specified in 7.2.3.

### 7.3.13 Uninterruptible Power Supply element

The Uninterruptible Power Supply element manages an uninterruptible power supply (e.g., providing power to a power supply (see 7.3.4)).

The format of the control field for an Uninterruptible Power Supply element is defined in table 94.

**Table 94 — Uninterruptible Power Supply element for control-type diagnostic pages**

Byte\Bit	7	6	5	4	3	2	1	0
0	COMMON CONTROL							
1	Reserved							
2	Reserved							
3	RQST IDENT	RQST FAIL	Reserved					

The COMMON CONTROL field is specified in 7.2.2.

The RQST IDENT bit and the RQST FAIL bit are defined in the Cooling element (see 7.3.5).



reliott Accepted 12/19/2007 7:34:03 PM -06'00'

---

Author: hpq-reliott  
Subject: Highlight  
Date: 12/13/2007 10:46:40 PM -06'00'  
**T** INVOP TYPE of  
s/b  
the INVOP TYPE field set to

Status  
reliott Accepted 12/13/2007 10:46:32 PM -06'00'  
Status  
reliott Confirmed 12/13/2007 10:46:35 PM -06'00'

---

Author: reliott  
Subject: Highlight  
Date: 5/12/2008 3:36:09 PM  
**T** contains  
s/b  
indicates

Status  
reliott Accepted 1/4/2008 12:04:23 PM -06'00'

---

Author: reliott  
Subject: Highlight  
Date: 5/12/2008 3:36:09 PM  
**T** contains  
s/b  
indicates

Status  
reliott Accepted 1/4/2008 12:04:34 PM -06'00'

---

Author: hpq-reliott  
Subject: Highlight  
Date: 12/13/2007 8:24:34 PM -06'00'  
**T** INVOP TYPE is  
s/b  
the INVOP TYPE field is set to

Status  
reliott Accepted 12/13/2007 10:46:54 PM -06'00'  
Status  
reliott Confirmed 12/13/2007 10:46:57 PM -06'00'

---

Author: ibm-gop  
Subject: Highlight  
Date: 12/13/2007 8:24:47 PM -06'00'  
**T** 7.3.12 Invalid Operation Reason element (3rd paragraph after table 92)  
This << The format of the status field when INVOP TYPE is 11b is defined in table 93. >> should be << The format of the status field when INVOP TYPE field is set to 11b is defined in table 93. >>

Status  
reliott Accepted 12/19/2007 7:34:20 PM -06'00'

---

Author: ibm-gop  
Subject: Highlight  
Date: 12/13/2007 8:24:47 PM -06'00'  
**T** 7.3.12 Invalid Operation Reason element (table 93 title)  
This << status-type diagnostic pages with INVOP TYPE of 11b >> should be << status-type diagnostic pages with INVOP TYPE field set to 11b >>

Status  
reliott Accepted 12/19/2007 7:34:34 PM -06'00'

---

Author: hpq-reliott  
Subject: Highlight  
Date: 12/13/2007 10:47:08 PM -06'00'  
**T** INVOP TYPE of  
s/b

Comments from page 83 continued on next page



The PAGE NOT SUPPORTED bit indicates that a SEND DIAGNOSTIC command requested a diagnostic page not supported by the enclosure service process. This bit is only set to one when this element is returned by the Enclosure Status diagnostic page (see 6.1.4).

The format of the status field when INVOP TYPE is 01b is defined in table 92.

**Table 92 — Invalid Operation Reason element for status-type diagnostic pages with INVOP TYPE of 01b**

Byte\Bit	7	6	5	4	3	2	1	0
0	COMMON STATUS							
1	INVOP TYPE (01b)		Reserved			BIT NUMBER		
2	(MSB) _____							
3	_____ (LSB)							

The COMMON STATUS field is specified in 7.2.3.

The BIT NUMBER field contains the bit number of the most significant bit of the field responsible for the INVOP bit being set to one.

The BYTE OFFSET field contains the byte offset of the most significant byte of the field responsible for the INVOP bit being set to one.

The format of the status field when INVOP TYPE is 11b is defined in table 93.

**Table 93 — Invalid Operation Reason element for status-type diagnostic pages with INVOP TYPE of 11b**

Byte\Bit	7	6	5	4	3	2	1	0
0	COMMON STATUS							
1	INVOP TYPE (11b)							
2								
3	Vendor-specific							

The COMMON STATUS field is specified in 7.2.3.

### 7.3.13 Uninterruptible Power Supply element

The Uninterruptible Power Supply element manages an uninterruptible power supply (e.g., providing power to a power supply (see 7.3.4)).

The format of the control field for an Uninterruptible Power Supply element is defined in table 94.

**Table 94 — Uninterruptible Power Supply element for control-type diagnostic pages**

Byte\Bit	7	6	5	4	3	2	1	0
0	COMMON CONTROL							
1	Reserved							
2	Reserved							
3	RQST IDENT	RQST FAIL	Reserved					

The COMMON CONTROL field is specified in 7.2.2.

The RQST IDENT bit and the RQST FAIL bit are defined in the Cooling element (see 7.3.5).

the INVOP TYPE field set to

Status  
relliott Accepted 12/13/2007 10:47:00 PM -06'00'

Status  
relliott Confirmed 12/13/2007 10:47:04 PM -06'00'

---

Author: relliott  
Subject: Highlight  
Date: 5/12/2008 3:36:09 PM  
**T** manages an uninterruptible power supply  
s/b  
... and its battery

(this lets the paragraph on the top of the next page about thresholds be eliminated in favor of a threshold element table)

Status  
relliott Accepted 12/21/2007 5:19:59 PM -06'00'

---

Author: relliott  
Subject: Highlight  
Date: 5/12/2008 3:36:09 PM  
**T** e.g., providing power to a power supply (see 7.3.4)  
s/b  
e.g., a device inputting AC power and outputting DC power to a power supply represented by a Power Supply element (see 7.3.4)

Status  
relliott Accepted 12/19/2007 8:04:33 PM -06'00'

---

Author: hpq-relliott  
Subject: Note  
Date: 12/13/2007 8:24:34 PM -06'00'  
 Join Reserved rows in table 94

Status  
relliott Accepted 12/13/2007 9:58:40 PM -06'00'

Status  
relliott Confirmed 12/13/2007 9:58:43 PM -06'00'

---

The Uninterruptible Power Supply element reports the status of the uninterruptible power supply and its battery. The value in the BATTERY STATUS field may be compared against the threshold fields as defined in 6.1.9. Only the LOW WARNING THRESHOLD and the LOW CRITICAL THRESHOLD fields are used for comparisons against the battery status field. A value of zero in the threshold fields specifies that a vendor-specific threshold shall be used. A value between 1 and 255 in the threshold field specifies that the corresponding number of minutes of remaining battery capacity shall be used as a threshold. The HIGH WARNING THRESHOLD and the HIGH CRITICAL THRESHOLD fields shall be ignored.

The format of the status field for an Uninterruptible Power Supply element is defined in table 95.

**Table 95 — Uninterruptible Power Supply element for status-type diagnostic pages**

Byte/Bit	7	6	5	4	3	2	1	0
0	COMMON STATUS							
1	BATTERY STATUS							
2	AC LO	AC HI	AC QUAL	AC FAIL	DC FAIL	UPS FAIL	WARN	INTF FAIL
3	IDENT	FAIL	Reserved				BATT FAIL	BPF

The COMMON STATUS field is specified in 7.2.3.

The value of the BATTERY STATUS field indicates the time the battery could provide power in the event of an AC supply failure. The value in the BATTERY STATUS field is indicated in minutes of capability from 1 to 254 minutes. An indication of 255 minutes indicates that the battery has more capacity than 254 minutes remaining. An indication of 0 minutes indicates that the battery is discharged or that the battery's status is unknown.

An AC LO bit set to one indicates that the AC line voltage is lower than its specified range. An AC LO bit set to zero indicates that the AC line voltage has risen into its specified range.

An AC HI bit set to one indicates that the AC line voltage is higher than its specified range. An AC HI bit set to zero indicates that the AC line voltage has fallen into its specified range.

An AC QUAL (AC quality) bit set to one indicates that the quality of the AC line voltage is outside its specified value. The definition of the quality parameters and specification is vendor specific. An AC QUAL bit indicates that the AC line voltage quality has returned to its specified value.

An AC FAIL (AC failure) bit set to one indicates that the AC line voltage has failed. The definition of a line voltage failure is vendor specific. An AC FAIL bit set to zero indicates that the AC line voltage is provided.

A DC FAIL (DC failure) bit set to one indicates that the DC line voltage has failed. The definition of a line voltage failure is vendor specific. A DC FAIL bit set to zero indicates that the DC line voltage is provided.

A UPS FAIL (uninterruptible power supply failure) bit set to one indicates that the uninterruptible power supply has failed and cannot provide power. A UPS FAIL bit set to zero indicates that the uninterruptible power supply failure is corrected.

A WARN (warning) bit set to one indicates that the output power will be available for less than the number of minutes specified by the LOW WARNING THRESHOLD field or less than the vendor-specific default time. A WARN bit set to zero indicates that output power will be available for at least the time specified by the LOW WARNING THRESHOLD field.

An INTF FAIL (interface failure) bit set to one indicates that the enclosure services interface to the uninterruptible power supply has failed. An INTF FAIL bit set to zero indicates that the enclosure services interface to the UPS is operational.

The IDENT bit and the FAIL bit are defined in the Power Supply element (see 7.3.4).

A BATT FAIL (battery failure) bit set to one indicates that the battery has failed. The definition of battery failure is vendor specific. A BATT FAIL bit set to zero indicates that the battery is operating correctly.

Author: ibm-gop  
Subject: Highlight  
Date: 12/13/2007 8:24:47 PM -06'00'

**T 7.3.13 Uninterruptible Power Supply element (3rd paragraph after table 94)**

This << compared against the threshold fields as defined in 6.1.8 >> should be << compared against the thresholds as defined in 6.1.8 >>

Status  
relliott Rejected 12/17/2007 2:53:57 PM -06'00'  
Status  
relliott None 12/17/2007 2:53:53 PM -06'00'

Author: relliott  
Subject: Note  
Date: 5/12/2008 3:36:09 PM

 Move the threshold paragraph above the control element

Status  
relliott Accepted 12/17/2007 2:57:20 PM -06'00'  
Status  
relliott Confirmed 12/17/2007 2:57:22 PM -06'00'

Author: ibm-gop  
Subject: Highlight  
Date: 12/13/2007 8:24:47 PM -06'00'

**T 7.3.13 Uninterruptible Power Supply element (3rd paragraph after table 94)**

This << are used for comparisons against the battery status field. A >> should be << are used for comparisons against the BATTERY STATUS field. A >>

Status  
relliott Accepted 12/17/2007 2:48:09 PM -06'00'  
Status  
relliott Confirmed 12/17/2007 2:48:12 PM -06'00'

Author: ibm-gop  
Subject: Highlight  
Date: 12/13/2007 8:24:47 PM -06'00'

**T 7.3.13 Uninterruptible Power Supply element (3rd paragraph after table 94)**

This << A value between 1 and 255 in the threshold field specifies that the corresponding number of >> should be << A threshold value between 1 and 255 specifies that the corresponding number of >>

Status  
relliott Accepted 12/19/2007 7:42:41 PM -06'00'

Author: relliott  
Subject: Note  
Date: 12/19/2007 7:42:37 PM -06'00'  
 threshold rather than threshold value

Author: ibm-gop  
Subject: Highlight  
Date: 12/13/2007 8:24:47 PM -06'00'

**T 7.3.13 Uninterruptible Power Supply element (3rd paragraph after table 94)**

This << The HIGH WARNING THRESHOLD and the HIGH CRITICAL THRESHOLD fields shall be ignored. >> should be << The HIGH WARNING THRESHOLD field and the HIGH CRITICAL THRESHOLD field shall be ignored. >>

Status  
relliott Accepted 12/19/2007 7:43:54 PM -06'00'

Author: relliott  
Subject: Note  
Date: 12/19/2007 7:43:51 PM -06'00'  
 OK, but with "shall both be ignored" too

Author: ibm-gop  
Subject: Highlight  
Date: 12/13/2007 8:24:47 PM -06'00'

**T 7.3.13 Uninterruptible Power Supply element (2nd paragraph after table 95)**

This << The value of the BATTERY STATUS field indicates the time the battery could provide power in the event of an AC

The Uninterruptible Power Supply element reports the status of the uninterruptible power supply and its battery. The value in the BATTERY STATUS field may be compared against the threshold fields as defined in 6.1.8. Only the LOW WARNING THRESHOLD and the LOW CRITICAL THRESHOLD fields are used for comparisons against the battery status field. A value of zero in the threshold fields specifies that a vendor-specific threshold shall be used. A value between 1 and 255 in the threshold field specifies that the corresponding number of minutes of remaining battery capacity shall be used as a threshold. The HIGH WARNING THRESHOLD and the HIGH CRITICAL THRESHOLD fields shall be ignored.

The format of the status field for an Uninterruptible Power Supply element is defined in table 95.

**Table 95 — Uninterruptible Power Supply element for status-type diagnostic pages**

Byte/Bit	7	6	5	4	3	2	1	0
0	COMMON STATUS							
1	BATTERY STATUS							
2	AC LO	AC HI	AC QUAL	AC FAIL	DC FAIL	UPS FAIL	WARN	INTF FAIL
3	IDENT	FAIL	Reserved				BATT FAIL	BPF

The COMMON STATUS field is specified in 7.2.3.

The value of the BATTERY STATUS field indicates the time the battery could provide power in the event of an AC supply failure. The value in the BATTERY STATUS field is indicated in minutes of capability from 1 to 254 minutes. An indication of 255 minutes indicates that the battery has more capacity than 254 minutes remaining. An indication of 0 minutes indicates that the battery is discharged or that the battery's status is unknown.

An AC LO bit set to one indicates that the AC line voltage is lower than its specified range. An AC LO bit set to zero indicates that the AC line voltage has risen into its specified range.

An AC HI bit set to one indicates that the AC line voltage is higher than its specified range. An AC HI bit set to zero indicates that the AC line voltage has fallen into its specified range.

An AC QUAL (AC quality) bit set to one indicates that the quality of the AC line voltage is outside its specified value. The definition of the quality parameters and specification is vendor specific. An AC QUAL bit indicates that the AC line voltage quality has returned to its specified value.

An AC FAIL (AC failure) bit set to one indicates that the AC line voltage has failed. The definition of a line voltage failure is vendor specific. An AC FAIL bit set to zero indicates that the AC line voltage is provided.

A DC FAIL (DC failure) bit set to one indicates that the DC line voltage has failed. The definition of a line voltage failure is vendor specific. A DC FAIL bit set to zero indicates that the DC line voltage is provided.

A UPS FAIL (uninterruptible power supply failure) bit set to one indicates that the uninterruptible power supply has failed and cannot provide power. A UPS FAIL bit set to zero indicates that the uninterruptible power supply failure is corrected.

A WARN (warning) bit set to one indicates that the output power will be available for less than the number of minutes specified by the LOW WARNING THRESHOLD field or less than the vendor-specific default time. A WARN bit set to zero indicates that output power will be available for at least the time specified by the LOW WARNING THRESHOLD field.

An INTF FAIL (interface failure) bit set to one indicates that the enclosure services interface to the uninterruptible power supply has failed. An INTF FAIL bit set to zero indicates that the enclosure services interface to the UPS is operational.

The IDENT bit and the FAIL bit are defined in the Power Supply element (see 7.3.4).

A BATT FAIL (battery failure) bit set to one indicates that the battery has failed. The definition of battery failure is vendor specific. A BATT FAIL bit set to zero indicates that the battery is operating correctly.

>> should be << The value of the BATTERY STATUS field indicates the time the battery is able to provide power in the event of an AC >>

Status  
relliott Accepted 12/19/2007 7:49:08 PM -06'00'

---

Author: relliott  
Subject: Note  
Date: 12/19/2007 7:49:08 PM -06'00'  
 rewording into table

---

Author: relliott  
Subject: Note  
Date: 5/12/2008 3:36:09 PM

 Change the battery status paragraph to:

The battery status field indicates the amount of time in minutes for which the battery is capable of providing power in the event of an AC supply failure and is defined in table 96

00h The battery is discharged or the battery's status is unknown

01h - FFh The battery has at least the indicated number of minutes of capacity remaining

Status  
relliott Accepted 12/19/2007 7:50:36 PM -06'00'

---

Author: ibm-gop  
Subject: Highlight  
Date: 12/13/2007 8:24:47 PM -06'00'

 7.3.13 Uninterruptible Power Supply element (2nd paragraph after table 95)

This << An indication of 0 minutes indicates that the battery is discharged >> should be << An indication of zero minutes indicates that the battery is discharged >>

Status  
relliott Rejected 12/19/2007 7:49:36 PM -06'00'

---

Author: relliott  
Subject: Note  
Date: 12/19/2007 7:49:36 PM -06'00'  
 rewording into table

---

Author: ibm-gop  
Subject: Highlight  
Date: 12/13/2007 8:24:47 PM -06'00'

 7.3.13 Uninterruptible Power Supply element (3rd paragraph after table 95)

This << zero indicates that the AC line voltage has risen into its specified range. >> should be << zero indicates that the AC line voltage is within its specified range. >>

Status  
relliott Accepted 12/19/2007 7:51:16 PM -06'00'

---

Author: ibm-gop  
Subject: Highlight  
Date: 12/13/2007 8:24:47 PM -06'00'

 7.3.13 Uninterruptible Power Supply element (4th paragraph after table 95)

This << zero indicates that the AC line voltage has fallen into its specified range. >> should be << zero indicates that the AC line voltage is within its specified range. >>

Status  
relliott Accepted 12/19/2007 7:51:19 PM -06'00'

---

Author: ibm-gop  
Subject: Highlight  
Date: 12/13/2007 8:24:47 PM -06'00'

 7.3.13 Uninterruptible Power Supply element (5th paragraph after table 95)

This << that the AC line voltage quality has returned to its specified value. >> should be << that the AC line voltage quality is within its specified value. >>

Status  
relliott Accepted 12/19/2007 7:54:54 PM -06'00'

---

Author: relliott  
Subject: Note

Comments from page 84 continued on next page



The Uninterruptible Power Supply element reports the status of the uninterruptible power supply and its battery. The value in the BATTERY STATUS field may be compared against the threshold fields as defined in 6.1.8. Only the LOW WARNING THRESHOLD and the LOW CRITICAL THRESHOLD fields are used for comparisons against the battery status field. A value of zero in the threshold fields specifies that a vendor-specific threshold shall be used. A value between 1 and 255 in the threshold field specifies that the corresponding number of minutes of remaining battery capacity shall be used as a threshold. The HIGH WARNING THRESHOLD and the HIGH CRITICAL THRESHOLD fields shall be ignored.

The format of the status field for an Uninterruptible Power Supply element is defined in table 95.

**Table 95 — Uninterruptible Power Supply element for status-type diagnostic pages**

Byte/Bit	7	6	5	4	3	2	1	0
0	COMMON STATUS							
1	BATTERY STATUS							
2	AC LO	AC HI	AC QUAL	AC FAIL	DC FAIL	UPS FAIL	WARN	INTF FAIL
3	IDENT	FAIL	Reserved				BATT FAIL	BPF

The COMMON STATUS field is specified in 7.2.3.



The value of the BATTERY STATUS field indicates the time the battery could provide power in the event of an AC supply failure. The value in the BATTERY STATUS field is indicated in minutes of capability from 1 to 254 minutes. An indication of 255 minutes indicates that the battery has more capacity than 254 minutes remaining. An indication of 0 minutes indicates that the battery is discharged or that the battery's status is unknown.

An AC LO bit set to one indicates that the AC line voltage is lower than its specified range. An AC LO bit set to zero indicates that the AC line voltage has risen into its specified range.

An AC HI bit set to one indicates that the AC line voltage is higher than its specified range. An AC HI bit set to zero indicates that the AC line voltage has fallen into its specified range.

An AC QUAL (AC quality) bit set to one indicates that the quality of the AC line voltage is outside its specified value. The definition of the quality parameters and specification is vendor specific. An AC QUAL bit indicates that the AC line voltage quality has returned to its specified value.

An AC FAIL (AC failure) bit set to one indicates that the AC line voltage has failed. The definition of a line voltage failure is vendor specific. An AC FAIL bit set to zero indicates that the AC line voltage is provided.

A DC FAIL (DC failure) bit set to one indicates that the DC line voltage has failed. The definition of a line voltage failure is vendor specific. A DC FAIL bit set to zero indicates that the DC line voltage is provided.

A UPS FAIL (uninterruptible power supply failure) bit set to one indicates that the uninterruptible power supply has failed and cannot provide power. A UPS FAIL bit set to zero indicates that the uninterruptible power supply failure is corrected.

A WARN (warning) bit set to one indicates that the output power will be available for less than the number of minutes specified by the LOW WARNING THRESHOLD field or less than the vendor-specific default time. A WARN bit set to zero indicates that output power will be available for at least the time specified by the LOW WARNING THRESHOLD field.

An INTF FAIL (interface failure) bit set to one indicates that the enclosure services interface to the uninterruptible power supply has failed. An INTF FAIL bit set to zero indicates that the enclosure services interface to the UPS is operational.

The IDENT bit and the FAIL bit are defined in the Power Supply element (see 7.3.4).

A BATT FAIL (battery failure) bit set to one indicates that the battery has failed. The definition of battery failure is vendor specific. A BATT FAIL bit set to zero indicates that the battery is operating correctly.

Date: 12/19/2007 7:54:54 PM -06'00'

changed value to range throughout the paragraph too

---

Author: relliott  
Subject: Highlight  
Date: 5/12/2008 3:36:09 PM  
**T**a line voltage failure  
s/b  
AC line voltage failure

Status  
relliott Accepted 12/19/2007 7:53:15 PM -06'00'

---

Author: relliott  
Subject: Highlight  
Date: 5/12/2008 3:36:09 PM  
**T**a line voltage failure  
s/b  
DC line voltage failure

Status  
relliott Accepted 12/19/2007 7:53:39 PM -06'00'

---

Author: ibm-gop  
Subject: Highlight  
Date: 12/13/2007 8:24:47 PM -06'00'  
**T**7.3.13 Uninterruptible Power Supply element (8th paragraph after table 95)

**This << indicates that the uninterruptible power supply has failed and cannot provide power. A UPS FAIL bit set to zero >> should be << indicates that the uninterruptible power supply has failed and is not able to provide power. A UPS FAIL bit set to zero >>**

Status  
relliott Accepted 12/19/2007 7:54:11 PM -06'00'

---

Author: ibm-gop  
Subject: Highlight  
Date: 12/19/2007 7:58:03 PM -06'00'  
**T**7.3.13 Uninterruptible Power Supply element (9th paragraph after table 95)

**This << A WARN (warning) bit set to one indicates that the output power will be available for less than the number of minutes specified by the LOW WARNING THRESHOLD field or less than the vendor-specific default time.>> should be << A WARN (warning) bit set to one indicates that there is not enough output power to operate the enclosure for the number of minutes specified by the LOW WARNING THRESHOLD field or the vendor-specific default time.>>**

Status  
relliott Accepted 12/19/2007 8:47:33 PM -06'00'

---

Author: ibm-gop  
Subject: Highlight  
Date: 12/13/2007 8:24:47 PM -06'00'  
**T**7.3.13 Uninterruptible Power Supply element (9th paragraph after table 95)

**This << A WARN bit set to zero indicates that output power will be available for at least the time specified by the LOW WARNING THRESHOLD field >> should be << A WARN bit set to zero indicates that there is enough output power to operate the enclosure for at least the number of minutes specified by the LOW WARNING THRESHOLD field or the vendor-specific default time.>>**

Status  
relliott Accepted 12/19/2007 8:47:38 PM -06'00'

---

Author: relliott  
Subject: Highlight  
Date: 5/12/2008 3:36:09 PM  
**T**enclosure services interface to the  
s/b  
interface from the enclosure services process to the

Status  
relliott Accepted 12/19/2007 8:00:27 PM -06'00'

---

Author: relliott

Comments from page 84 continued on next page



The Uninterruptible Power Supply element reports the status of the uninterruptible power supply and its battery. The value in the BATTERY STATUS field may be compared against the threshold fields as defined in 6.1.8. Only the LOW WARNING THRESHOLD and the LOW CRITICAL THRESHOLD fields are used for comparisons against the battery status field. A value of zero in the threshold fields specifies that a vendor-specific threshold shall be used. A value between 1 and 255 in the threshold field specifies that the corresponding number of minutes of remaining battery capacity shall be used as a threshold. The HIGH WARNING THRESHOLD and the HIGH CRITICAL THRESHOLD fields shall be ignored.

The format of the status field for an Uninterruptible Power Supply element is defined in table 95.

**Table 95 — Uninterruptible Power Supply element for status-type diagnostic pages**

Byte/Bit	7	6	5	4	3	2	1	0
0	COMMON STATUS							
1	BATTERY STATUS							
2	AC LO	AC HI	AC QUAL	AC FAIL	DC FAIL	UPS FAIL	WARN	INTF FAIL
3	IDENT	FAIL	Reserved				BATT FAIL	BTF

The COMMON STATUS field is specified in 7.2.3.

The value of the BATTERY STATUS field indicates the time the battery could provide power in the event of an AC supply failure. The value in the BATTERY STATUS field is indicated in minutes of capability from 1 to 254 minutes. An indication of 255 minutes indicates that the battery has more capacity than 254 minutes remaining. An indication of 0 minutes indicates that the battery is discharged or that the battery's status is unknown.

An AC LO bit set to one indicates that the AC line voltage is lower than its specified range. An AC LO bit set to zero indicates that the AC line voltage has risen into its specified range.

An AC HI bit set to one indicates that the AC line voltage is higher than its specified range. An AC HI bit set to zero indicates that the AC line voltage has fallen into its specified range.

An AC QUAL (AC quality) bit set to one indicates that the quality of the AC line voltage is outside its specified value. The definition of the quality parameters and specification is vendor specific. An AC QUAL bit indicates that the AC line voltage quality has returned to its specified value.

An AC FAIL (AC failure) bit set to one indicates that the AC line voltage has failed. The definition of a line voltage failure is vendor specific. An AC FAIL bit set to zero indicates that the AC line voltage is provided.

A DC FAIL (DC failure) bit set to one indicates that the DC line voltage has failed. The definition of a line voltage failure is vendor specific. A DC FAIL bit set to zero indicates that the DC line voltage is provided.

A UPS FAIL (uninterruptible power supply failure) bit set to one indicates that the uninterruptible power supply has failed and cannot provide power. A UPS FAIL bit set to zero indicates that the uninterruptible power supply failure is corrected.

A WARN (warning) bit set to one indicates that the output power will be available for less than the number of minutes specified by the LOW WARNING THRESHOLD field or less than the vendor-specific default time. A WARN bit set to zero indicates that output power will be available for at least the time specified by the LOW WARNING THRESHOLD field.

An INTF FAIL (interface failure) bit set to one indicates that the enclosure services interface to the uninterruptible power supply has failed. An INTF FAIL bit set to zero indicates that the enclosure services interface to the UPS is operational.

The IDENT bit and the FAIL bit are defined in the Power Supply element (see 7.3.4).

A BATT FAIL (battery failure) bit set to one indicates that the battery has failed. The definition of battery failure is vendor specific. A BATT FAIL bit set to zero indicates that the battery is operating correctly.

Subject: Highlight

Date: 5/12/2008 3:36:09 PM

**T** enclosure services interface to the  
s/b

interface from the enclosure services process to the

Status

relliott Accepted 12/19/2007 8:00:40 PM -06'00'

---

Author: relliott

Subject: Highlight

Date: 5/12/2008 3:36:09 PM

**T** UPS  
s/b

uninterruptable power supply

Status

relliott Accepted 12/19/2007 8:00:03 PM -06'00'

---

A BPF (battery predicted failure) bit set to one indicates that the battery is approaching a failure condition. The definition of the prediction mechanism is vendor specific. Predicted failures of the Uninterruptible Power Supply element are indicated by the PRDFAIL bit (see 7.2.2 and 7.2.3). A BPF bit set to zero indicates that the battery is operating correctly.

**7.3.14 Display element**

The Display element manages a visible display (e.g., seven-segment LED) represents a part of a display device or a whole display device in the enclosure (e.g., an LCD panel or a seven-segment LED). For Display elements that support the DISPLAY CHARACTER field, if more than one Display elements share the same type descriptor header in the Configuration diagnostic page (see 6.1.2), the order of the Display elements shall match the order for displaying a string of characters in the appropriate language (e.g., to display "45" on two LEDs each represented by a Display element, the first Display element displays '4' and the second Display element displays '5'). The format of the control field for a Display element is defined in table 96.

**Table 96 — Display element for control-type diagnostic pages**

Byte\Bit	7	6	5	4	3	2	1	0
0	COMMON CONTROL							
1	RQST IDENT	RQST FAIL	Reserved				DISPLAY MODE	
2	DISPLAY CHARACTER							
3								

The COMMON CONTROL field is specified in 7.2.2.

The RQST IDENT bit and the RQST FAIL bit are defined in the Cooling element (see 7.3.5).

The DISPLAY MODE field is defined in table 97.

**Table 97 — DISPLAY MODE field**

Code	Description
00b	No change to the display.
01b	Allow the enclosure services process to control the display and ignore the DISPLAY CHARACTER field.
10b	Display the character specified in the DISPLAY CHARACTER field.
11b	Reserved

The DISPLAY CHARACTER field specifies the character to display. If a Language element (see 7.3.18) is present, the DISPLAY CHARACTER field shall contain a character using the language and character set indicated by the Language element. If a Language element is not available, the first byte of the DISPLAY CHARACTER field (i.e., byte 2 of the Display element) contains a US-ASCII character encoded in 8 bits per ISO/IEC 8859-1 and the device server shall ignore the second byte (i.e., byte 3 of the Display element).

Author: relliott  
Subject: Highlight  
Date: 5/12/2008 3:36:09 PM  
T the prediction mechanism  
s/b  
battery predicted failure

Status  
relliott Accepted 12/19/2007 8:02:39 PM -06'00'

---

Author: relliott  
Subject: Highlight  
Date: 5/12/2008 3:36:09 PM  
T Uninterruptible Power Supply element  
s/b  
uninterruptable power supply

Status  
relliott Accepted 12/19/2007 8:01:41 PM -06'00'

---

Author: ibm-gop  
Subject: Highlight  
Date: 12/13/2007 8:24:47 PM -06'00'  
T 7.3.14 Display element (1st paragraph)

**This << if more than one Display elements share the same type descriptor header in the Configuration diagnostic page (see 6.1.2), the order of the Display elements shall >> should be << if more than one Display elements share the same type descriptor header in the Configuration diagnostic page (see 6.1.2), then the order of the Display elements shall >>**

Status  
relliott Accepted 12/19/2007 8:08:05 PM -06'00'

---

Author: ibm-gop  
Subject: Highlight  
Date: 12/13/2007 8:24:47 PM -06'00'  
T 7.3.14 Display element (1st paragraph)

**This << (e.g., to display "45" on two LEDs each represented by a Display element, the first Display element displays '4' and the second Display element displays '5') >> should be << (e.g., to display 45 on two LEDs each represented by a Display element, the first Display element displays 4 and the second Display element displays 5) >>**

Status  
relliott Rejected 12/19/2007 8:08:14 PM -06'00'

---

Author: relliott  
Subject: Highlight  
Date: 5/12/2008 3:36:09 PM  
T device server  
s/b  
enclosure services process

Status  
relliott Accepted 12/15/2007 5:17:51 PM -06'00'

Status  
relliott Confirmed 12/15/2007 5:17:49 PM -06'00'

---

The format of the status field for a Display element is defined in table 98.

**Table 98 — Display element for status-type diagnostic pages**

Byte\Bit	7	6	5	4	3	2	1	0
0	COMMON STATUS							
1	IDENT	FAIL	Reserved				DISPLAY MODE STATUS	
2	DISPLAY CHARACTER STATUS							
3	DISPLAY CHARACTER STATUS							

The COMMON STATUS field is specified in 7.2.3.

The IDENT bit and the FAIL bit are defined in the Power Supply element (see 7.3.4).

The DISPLAY MODE STATUS field is defined in table 99.

**Table 99 — DISPLAY MODE STATUS field**

Code	Description
00b	The enclosure services process is controlling the display; Display element control of the display is not supported.
01b	The enclosure services process is controlling the display; Display element control of the display is supported.
10b	The display is being controlled based on the Display element.
11b	Reserved

If the DISPLAY MODE STATUS field is set to 01b or 10b and a Language element (see 7.3.18) is present, the DISPLAY CHARACTER STATUS field indicates the character currently being displayed in the language and character set indicated by the Language element. If the DISPLAY MODE STATUS field is set to 01b or 10b and a Language element is not available, the first byte of the DISPLAY CHARACTER STATUS field (i.e., byte 2 of the Display element) indicates the US-ASCII character encoded in 8 bits per ISO/IEC 8859-1 and the second byte (i.e., byte 3 of the Display element) is reserved. If the DISPLAY MODE STATUS field is set to 00b or 11b, the DISPLAY CHARACTER STATUS field is reserved.

**7.3.15 Key Pad Entry element**

The Key Pad element manages a key pad.

The format of the control field for Key Pad Entry element is defined in table 100.

**Table 100 — Key Pad Entry element for control-type diagnostic pages**

Byte\Bit	7	6	5	4	3	2	1	0
0	COMMON CONTROL							
1	RQST IDENT	RQST FAIL	Reserved					
2	Reserved							
3	Reserved							

The COMMON CONTROL field is specified in 7.2.2.

The RQST IDENT bit and the RQST FAIL bit are defined in the Cooling element (see 7.3.5).

Author: ibm-gop  
Subject: Highlight  
Date: 12/13/2007 8:24:47 PM -06'00'  
**T** 7.3.14 Display element (table 99 1st row)

This << The enclosure services process is controlling the display; Display element control of the display is not supported. >> should be << The enclosure services process is controlling the display and the display element control of the display is not supported. >>

Status  
relliott Accepted 12/19/2007 8:48:08 PM -06'00'

---

Author: ibm-gop  
Subject: Highlight  
Date: 12/13/2007 8:24:47 PM -06'00'  
**T** 7.3.14 Display element (table 99 2nd row)

This << The enclosure services process is controlling the display; Display element control of the display is supported. >> should be << The enclosure services process is controlling the display and the display element control of the display is supported. >>

Status  
relliott Accepted 12/19/2007 8:48:13 PM -06'00'

---

Author: ibm-gop  
Subject: Highlight  
Date: 12/13/2007 8:24:47 PM -06'00'  
**T** 7.3.14 Display element (last paragraph)

This << If the DISPLAY MODE STATUS field is set to 01b or 10b and a Language element (see 7.3.18) is present, the >> should be << If the DISPLAY MODE STATUS field is set to 01b or 10b and a Language element (see 7.3.18) is present, then the >>

Status  
relliott Accepted 12/19/2007 8:09:57 PM -06'00'

---

Author: ibm-gop  
Subject: Highlight  
Date: 12/13/2007 8:24:47 PM -06'00'  
**T** 7.3.14 Display element (last paragraph)

This << If the DISPLAY MODE STATUS field is set to 01b or 10b and a Language element is not available, the first byte of the >> should be << If the DISPLAY MODE STATUS field is set to 01b or 10b and a Language element is not available, then the first byte of the >>

Status  
relliott Accepted 12/19/2007 8:10:01 PM -06'00'

---

Author: ibm-gop  
Subject: Highlight  
Date: 12/13/2007 8:24:47 PM -06'00'  
**T** 7.3.14 Display element (last paragraph)

This << If the DISPLAY MODE STATUS field is set to 00b or 11b, the DISPLAY CHARACTER STATUS field >> should be << If the DISPLAY MODE STATUS field is set to 00b or 11b, then the DISPLAY CHARACTER STATUS field >>

Status  
relliott Accepted 12/19/2007 8:09:40 PM -06'00'

---

Author: hpq-relliott  
Subject: Note  
Date: 12/13/2007 8:24:34 PM -06'00'  
 Join Reserved rows in table 100

Status  
relliott Accepted 12/13/2007 9:59:13 PM -06'00'

Status  
relliott Confirmed 12/13/2007 9:59:16 PM -06'00'

---

The format of the status field for a Key Pad Entry element is defined in table 101.

**Table 101 — Key Pad Entry element for status-type diagnostic pages**

Byte\Bit	7	6	5	4	3	2	1	0
0	COMMON STATUS							
1	IDENT	FAIL	Reserved					
2	Reserved							
3	Reserved							

The COMMON STATUS field is specified in 7.2.3.

The IDENT bit and the FAIL bit are defined in the Power Supply element (see 7.3.4).

**7.3.16 Enclosure element**

The Enclosure element manages the enclosure itself.

The format of the control field for an Enclosure element is defined in table 102.

**Table 102 — Enclosure element for control-type diagnostic pages**

Byte\Bit	7	6	5	4	3	2	1	0
0	COMMON CONTROL							
1	RQST IDENT	Reserved						
2	POWER CYCLE REQUEST		POWER CYCLE DELAY					
3	POWER OFF DURATION						REQUEST FAILURE	REQUEST WARNING

The COMMON CONTROL field is specified in 7.2.2.

The RQST IDENT bit is defined in the Cooling element (see 7.3.5).

The POWER CYCLE REQUEST field is defined in table 103. A request to begin a power cycle while a previous request is still active shall override the previous request.

**Table 103 — POWER CYCLE REQUEST field**

Code	Description
00b	No power cycle request.
01b	The enclosure shall begin a power cycle beginning when specified in the DELAY TO POWER CYCLE field for the duration specified in the the POWER OFF DURATION field.
10b	The enclosure shall cancel any scheduled power cycle.
11b	Reserved

● Author: hpq-relliott

Subject: Note

Date: 12/13/2007 8:24:34 PM -06'00'

 Join Reserved rows in table 101

Status

relliott Accepted 12/13/2007 9:59:07 PM -06'00'

Status

relliott Confirmed 12/13/2007 9:59:10 PM -06'00'

---



The POWER CYCLE DELAY field is defined in table 104.

**Table 104 — POWER CYCLE DELAY field**

Code	Description
0	The enclosure shall begin a power cycle immediately after completing the SEND DIAGNOSTIC command.
1 to 60	The enclosure shall begin a power cycle after the specified number of minutes after completing the SEND DIAGNOSTIC command.
61 to 63	Reserved

The POWER OFF DURATION field is defined in table 105.

**Table 105 — POWER OFF DURATION field**

Code	Description
0	The enclosure shall keep power off for a minimal amount of time.
1 to 60	The enclosure shall keep power off for at least the specified number of minutes. Manual restoration shall override this value.
61 to 62	Reserved
63	The enclosure shall keep power off until it is manually restored.

If the REQUEST FAILURE bit is set to one, the enclosure shall enable a visual indication of enclosure failure (e.g., a failure LED). If the REQUEST FAILURE bit is set to zero, the enclosure may enable a visual indication of enclosure failure if the failure is self-detected.

If the REQUEST WARNING bit is set to one, the enclosure shall enable a visual indication of enclosure warning (e.g., a flashing LED or a second LED in addition to a failure LED). If the REQUEST WARNING bit is set to zero, the enclosure may enable a visual indication of enclosure warning if the warning is self-detected.

The format of the status field for an Enclosure element is defined in table 106.

**Table 106 — Enclosure element for status-type diagnostic pages**

Byte\Bit	7	6	5	4	3	2	1	0
0	COMMON STATUS							
1	IDENT	Reserved						
2	TIME UNTIL POWER CYCLE						FAILURE INDICATION	WARNING INDICATION
3	REQUESTED POWER OFF DURATION						FAILURE REQUESTED	WARNING REQUESTED

The COMMON STATUS field is specified in 7.2.3.

The IDENT bit is defined in the Power Supply element (see 7.3.4).

Author: ibm-gop  
Subject: Highlight  
Date: 12/13/2007 8:24:47 PM -06'00'

**T** 7.3.16 Enclosure element (table 104 1st row)

This << The enclosure shall begin a power cycle immediately after completing the SEND DIAGNOSTIC command. >> should be << The enclosure shall begin a power cycle after completing the SEND DIAGNOSTIC command. >>

Status  
relliott Accepted 12/19/2007 8:10:38 PM -06'00'

---

Author: ibm-gop  
Subject: Highlight  
Date: 12/13/2007 8:24:47 PM -06'00'

**T** 7.3.16 Enclosure element (table 105 1st row)

The term << minimal >> is not a specific time interval. The amount of time needs to be made more specific.

Status  
relliott Accepted 4/9/2008 6:44:23 PM

---

Author: relliott  
Subject: Note  
Date: 4/9/2008 6:44:24 PM  
 shall at least 0, should no more than 0  
merged with 1 to 60

---

The TIME UNTIL POWER CYCLE field indicates the amount of time until the enclosure's power is scheduled to be removed and is defined in table 107.

**Table 107 — TIME UNTIL POWER CYCLE field**

Code	Description
0	No power cycle is scheduled.
1 to 60	The enclosure is scheduled to begin a power cycle after the indicated number of minutes.
61 to 62	Reserved
63	The enclosure is scheduled to begin a power cycle immediately.

The REQUESTED POWER OFF DURATION field indicates the amount of time that power shall remain off when power is cycled and is defined in table 108.

**Table 108 — REQUESTED POWER OFF DURATION field**

Code	Description
0	Either: a) no power cycle is scheduled; or b) power is scheduled to be kept off for a minimal amount of time.
1 to 60	Power is scheduled to be kept off for at least the indicated number of minutes.
61 to 62	Reserved
63	Power is scheduled to be kept off until manually restored.

A FAILURE INDICATION bit set to one indicates that a failed condition was detected by the enclosure and that the visual indication of enclosure failure is enabled. A FAILURE INDICATION bit set to zero indicates that a failed condition was not detected by the enclosure.

A WARNING INDICATION bit set to one indicates that a warning condition was detected by the enclosure and that the visual indication of enclosure warning is enabled. A WARNING INDICATION bit set to zero indicates that a warning condition was not detected by the enclosure.

A FAILURE REQUESTED bit set to one indicates that a failed condition has been requested by an application client with the Enclosure Control diagnostic page (see 6.1.3) and that the visual indication of enclosure failure is enabled. A FAILURE REQUESTED bit set to zero indicates that a failed condition has not been requested by an application client.

A WARNING REQUESTED bit set to one indicates that a warning condition has been requested by an application client with the Enclosure Control diagnostic page and that the visual indication of enclosure warning is enabled. A WARNING REQUESTED bit set to zero indicates that a warning condition has not been requested by an application client.

### 7.3.17 SCSI Port/Transceiver element

The SCSI Port/Transceiver element manages standalone electronics used by one or more SCSI ports.

Author: ibm-gop  
Subject: Highlight  
Date: 12/13/2007 8:24:47 PM -06'00'

**T 7.3.16 Enclosure element (table 107 last row)**

This << The enclosure is scheduled to begin a power cycle immediately. >> should be << The enclosure is scheduled to begin a power cycle after completing the SEND DIAGNOSTIC command. >>

Status  
relliott Accepted 4/9/2008 6:44:35 PM

---

Author: relliott  
Subject: Note  
Date: 4/9/2008 6:45:04 PM  
 reworted to match changes getting rid of "minimal"

---

Author: ibm-gop  
Subject: Highlight  
Date: 12/13/2007 8:24:47 PM -06'00'

**T 7.3.16 Enclosure element (table 108 1st row)**

The term << minimal >> is not a specific time interval. The amount of time needs to be made more specific.

Status  
relliott Accepted 4/9/2008 6:45:13 PM

---

The format of the control field for a SCSI Port/Transceiver element is defined in table 109.

**Table 109 — SCSI Port/Transceiver element for control-type diagnostic pages**

Byte\Bit	7	6	5	4	3	2	1	0
0	COMMON CONTROL							
1	RQST IDENT	RQST FAIL	Reserved					
2	Reserved							
3	Reserved			DISABLE	Reserved			

The COMMON CONTROL field is specified in 7.2.2.

The RQST IDENT bit and the RQST FAIL bit are defined in the Cooling element (see 7.3.5).

A DISABLE bit set to one specifies that the SCSI port/transceiver be disabled. A DISABLE bit set to zero specifies that the SCSI port/transceiver be enabled.

The format of the status field for a SCSI Port/Transceiver element is defined in table 110.

**Table 110 — SCSI Port/Transceiver element for status-type diagnostic pages**

Byte\Bit	7	6	5	4	3	2	1	0
0	COMMON STATUS							
1	IDENT	FAIL	Reserved					
2	Reserved							REPORT
3	Reserved			DISABLED	Reserved		LOL	XMIT FAIL

The COMMON STATUS field is specified in 7.2.3.

The IDENT bit and the FAIL bit are defined in the Power Supply element (see 7.3.4).

A REPORT bit set to one indicates that the enclosure services process is using this SCSI port/transceiver as part of the path for transmitting the status-type diagnostic page. A REPORT bit set to zero indicates that this SCSI port/transceiver did not participate in the transmission of the status-type diagnostic page.

A DISABLED bit set to one indicates that the SCSI port/transceiver has been disabled. A DISABLED bit set to zero indicates that the SCSI port/transceiver is enabled.

An LOL (loss of link) bit set to one indicates that the SCSI port/transceiver is not receiving any input signals at its receiver. An LOL bit set to zero indicates that the SCSI port/transceiver is receiving normal signals.

An XMIT FAIL (transmitter failure) bit set to one indicates that the SCSI port/transceiver transmitter has failed or is operating outside its specification. An XMIT FAIL bit set to zero indicates that the SCSI port/transceiver transmitter is operating within its specification.

### 7.3.18 Language element

The Language element manages the language used for visual displays.

● Author: relliott  
Subject: Highlight  
Date: 5/12/2008 3:36:09 PM

**T**as  
part of the path for transmitting  
s/b  
to return

Status  
relliott Accepted 1/4/2008 6:36:51 PM -06'00'

---

● Author: relliott  
Subject: Highlight  
Date: 5/12/2008 3:36:09 PM

**T**status-type diagnostic page  
s/b

Enclosure Status diagnostic page

Status  
relliott Accepted 1/3/2008 6:04:51 PM -06'00'

---

● Author: relliott  
Subject: Highlight  
Date: 5/12/2008 3:36:09 PM

**T**this  
SCSI port/transceiver did not participate in the transmission  
s/b  
it is not using this SCSI port/transceiver to return

Status  
relliott Accepted 1/4/2008 7:32:45 PM -06'00'

---

● Author: relliott  
Subject: Highlight  
Date: 5/12/2008 3:36:09 PM

**T**status-type diagnostic page  
s/b

Enclosure Status diagnostic page

Status  
relliott Accepted 1/3/2008 6:04:48 PM -06'00'

---

The format of the control field for a Language element is defined in table 111.

**Table 111 — Language element for control-type diagnostic pages**

Byte\Bit	7	6	5	4	3	2	1	0	
0	COMMON CONTROL								
1	RQST IDENT	Reserved							
2	(MSB)	LANGUAGE CODE							
3								(LSB)	

The COMMON CONTROL field is specified in 7.2.2.

The RQST IDENT bit is defined in the Power Supply element (see 7.3.4).

The LANGUAGE CODE field specifies the language and character encoding to be used in all fields that are defined as being modified by the Language element. The enclosure should provide external indications in the requested language.

If the LANGUAGE CODE field contains:

- a) 0000h: the enclosure services process shall use the default language of English with the US-ASCII character set encoding as defined by ISO/IEC 8859-1 (i.e., encoded as 8-bit characters with each MSB set to zero);
- b) two characters containing the ISO 639-1 two-letter code for a language that is supported by the enclosure services process (e.g., “en” for English, “fr” for French, “de” for German, or “jp” for Japanese) expressed as US-ASCII characters as defined by ISO/IEC 8859-1 (i.e., encoded as 8-bit characters each with its MSB set to zero): the enclosure services process shall use UCS-2 as defined by ISO 10646-1 (i.e., encode using 16-bit characters); or
- c) a value other than 0000h or the two-letter code of a language that is supported by the enclosure services process: the enclosure services process shall use the default language of English with the US-ASCII character set encoded as defined by ISO/IEC 8859-1 (i.e., encoded as 8-bit characters with each MSB set to zero) and shall report an invalid field error (see 4.5).

The format of the status field for a Language element is defined in table 112.

**Table 112 — Language element for status-type diagnostic pages**

Byte\Bit	7	6	5	4	3	2	1	0	
0	COMMON STATUS								
1	IDENT	Reserved							
2	(MSB)	LANGUAGE CODE							
3								(LSB)	

The COMMON STATUS field is specified in 7.2.3.

The IDENT bit is defined in the Power Supply element (see 7.3.4). Since the Language element may not represent a physical element, the visual indication may be an indication of the language being used.

The LANGUAGE CODE field indicates the language and character encoding that the enclosure services process uses for those fields that have the capability of being modified by the Language element. A LANGUAGE CODE field set to 0000h indicates the enclosure services process is using the default language of English and the US-ASCII character set encoded as defined by ISO/IEC 8859-1 (i.e., encoded as 8-bit characters with each MSB set to zero). A LANGUAGE CODE field set to an ISO 639-1 two-letter code (e.g., “en” for English, “fr” for French, “de” for German, or “jp” for Japanese) expressed as US-ASCII characters as defined by ISO/IEC 8859-1 (i.e., encoded as 8-bit characters each with its MSB set to zero) indicates the enclosure

Author: ibm-gop  
Subject: Highlight  
Date: 12/13/2007 8:24:47 PM -06'00'

**T 7.3.18 Language element (item a in a,b,c list after table 111)**

**This << 0000h: the enclosure services process shall use the default >> should be << 0000h, then the enclosure services process shall use the default >>**

Status  
relliott Rejected 12/13/2007 10:05:59 PM -06'00'  
Status  
relliott Confirmed 12/13/2007 10:06:02 PM -06'00'

---

Author: relliott  
Subject: Note  
Date: 12/13/2007 10:05:20 PM -06'00'  
 converted into table

Author: relliott  
Subject: Note  
Date: 5/12/2008 3:36:09 PM  
 convert the LANGUAGE CODE field list into a table to eliminate the : construction

Status  
relliott Accepted 12/13/2007 10:11:29 PM -06'00'  
Status  
relliott Confirmed 12/13/2007 10:11:32 PM -06'00'

Author: ibm-gop  
Subject: Highlight  
Date: 12/13/2007 8:24:47 PM -06'00'

**T 7.3.18 Language element (item b in a,b,c list after table 111)**

**This << characters each with its MSB set to zero): the enclosure services process shall use UCS-2 as defined >> should be << characters each with its MSB set to zero), then the enclosure services process shall use UCS-2 as defined >>**

Status  
relliott Rejected 12/13/2007 10:05:52 PM -06'00'  
Status  
relliott Confirmed 12/13/2007 10:05:55 PM -06'00'

---

Author: relliott  
Subject: Note  
Date: 12/13/2007 10:05:32 PM -06'00'  
 converted into table

Author: ibm-gop  
Subject: Highlight  
Date: 12/13/2007 8:24:47 PM -06'00'

**T 7.3.18 Language element (item c in a,b,c list after table 111)**

**This << a value other than 0000h or the two-letter code of a language that is supported by the enclosure services process: the enclosure services process shall >> should be << a value other than 0000h or the two-letter code of a language that is supported by the enclosure services process, then the enclosure services process shall >>**

Status  
relliott Rejected 12/13/2007 10:05:46 PM -06'00'  
Status  
relliott Confirmed 12/13/2007 10:05:49 PM -06'00'

---

Author: relliott  
Subject: Note  
Date: 12/13/2007 10:05:50 PM -06'00'  
 converted into table

Author: relliott  
Subject: Note  
Date: 5/12/2008 3:36:09 PM



The format of the control field for a Language element is defined in table 111.

**Table 111 — Language element for control-type diagnostic pages**

Byte\Bit	7	6	5	4	3	2	1	0	
0	COMMON CONTROL								
1	RQST IDENT	Reserved							
2	(MSB)	LANGUAGE CODE							
3								(LSB)	

The COMMON CONTROL field is specified in 7.2.2.

The RQST IDENT bit is defined in the Power Supply element (see 7.3.4).

The LANGUAGE CODE field specifies the language and character encoding to be used in all fields that are defined as being modified by the Language element. The enclosure should provide external indications in the requested language.

If the LANGUAGE CODE field contains:

- a) 0000h: the enclosure services process shall use the default language of English with the US-ASCII character set encoding as defined by ISO/IEC 8859-1 (i.e., encoded as 8-bit characters with each MSB set to zero);
- b) two characters containing the ISO 639-1 two-letter code for a language that is supported by the enclosure services process (e.g., “en” for English, “fr” for French, “de” for German, or “jp” for Japanese) expressed as US-ASCII characters as defined by ISO/IEC 8859-1 (i.e., encoded as 8-bit characters each with its MSB set to zero): the enclosure services process shall use UCS-2 as defined by ISO 10646-1 (i.e., encode using 16-bit characters); or
- c) a value other than 0000h or the two-letter code of a language that is supported by the enclosure services process: the enclosure services process shall use the default language of English with the US-ASCII character set encoded as defined by ISO/IEC 8859-1 (i.e., encoded as 8-bit characters with each MSB set to zero) and shall report an invalid field error (see 4.5).



The format of the status field for a Language element is defined in table 112.

**Table 112 — Language element for status-type diagnostic pages**

Byte\Bit	7	6	5	4	3	2	1	0	
0	COMMON STATUS								
1	IDENT	Reserved							
2	(MSB)	LANGUAGE CODE							
3								(LSB)	

The COMMON STATUS field is specified in 7.2.3.

The IDENT bit is defined in the Power Supply element (see 7.3.4). Since the Language element may not represent a physical element, the visual indication may be an indication of the language being used.

The LANGUAGE CODE field indicates the language and character encoding that the enclosure services process uses for those fields that have the capability of being modified by the Language element. A LANGUAGE CODE field set to 0000h indicates the enclosure services process is using the default language of English and the US-ASCII character set encoded as defined by ISO/IEC 8859-1 (i.e., encoded as 8-bit characters with each MSB set to zero). A LANGUAGE CODE field set to an ISO 639-1 two-letter code (e.g., “en” for English, “fr” for French, “de” for German, or “jp” for Japanese) expressed as US-ASCII characters as defined by ISO/IEC 8859-1 (i.e., encoded as 8-bit characters each with its MSB set to zero) indicates the enclosure



 convert to a table like in the control element

Status  
relliott Accepted 12/13/2007 10:10:52 PM -06'00'

Status  
relliott Confirmed 12/13/2007 10:10:55 PM -06'00'

---

services process is using the indicated language and is using UCS-2 as defined by ISO/IEC 10646-1 (i.e., encoding using 16-bit characters).

**7.3.19 Communication Port element**

The Communications Port element manages a communications port (e.g., serial port).

The format of the control field for a Communication Port element is defined in table 113.

**Table 113 — Communication Port element for control-type diagnostic pages**

Byte\Bit	7	6	5	4	3	2	1	0
0	COMMON CONTROL							
1	RQST IDENT	RQST FAIL	Reserved					
2	Reserved							
3	Reserved							DISABLE

The COMMON CONTROL field is specified in 7.2.2.

The RQST IDENT bit and the RQST FAIL bit are defined in the Cooling element (see 7.3.5).

A DISABLE bit set to one specifies that the communication port be disabled. A DISABLE bit set to zero specifies that the communication port be enabled.

The format of the status field for a Communication Port element is defined in table 114.

**Table 114 — Communication Port element for status-type diagnostic pages**

Byte\Bit	7	6	5	4	3	2	1	0
0	COMMON STATUS							
1	IDENT	FAIL	Reserved					
2	Reserved							
3	Reserved							DISABLED

The COMMON STATUS field is specified in 7.2.3.

The IDENT bit and the FAIL bit are defined in the Power Supply element (see 7.3.4).

A DISABLED bit set to one indicates that the communication port has been disabled. A DISABLED bit set to zero indicates that the communication port is enabled.

**7.3.20 Voltage Sensor element**

The Voltage Sensor element provides voltage indications in the VOLTAGE field of the ELEMENT STATUS field. The voltage indications may be compared with threshold values. The threshold values may be vendor-specific defaults or they may be set by the Threshold Out diagnostic page (see 6.1.8).

The threshold fields are defined as tolerances, specified in units of 0,5 % from a vendor-specific nominal voltage or nominal voltage range (see 6.1.8).

When the DISABLE bit in the COMMON CONTROL field (see 7.2.2) is set to one, the voltage sensor's output is not tested against any threshold values and no noncritical, critical, or unrecoverable conditions are indicated because of the voltage values sensed. When the DISABLE bit is set to zero, the voltage sensor's output is accepted normally by the enclosure services process.

Author: relliott  
Subject: Cross-Out  
Date: 5/12/2008 3:36:09 PM  
 in the VOLTAGE field of the ELEMENT STATUS field

Status  
relliott Accepted 12/17/2007 3:00:23 PM -06'00'  
Status  
relliott Confirmed 12/17/2007 3:00:26 PM -06'00'

Author: relliott  
Subject: Highlight  
Date: 5/12/2008 3:36:09 PM  
 provides voltage indications  
s/b  
manages a voltage sensor

Status  
relliott Accepted 12/21/2007 5:20:44 PM -06'00'

Author: relliott  
Subject: Note  
Date: 5/12/2008 3:36:09 PM  
 Move the second and third sentences of the first paragraph into the second paragraph, so all the threshold rules are together

Status  
relliott Accepted 12/17/2007 2:59:25 PM -06'00'  
Status  
relliott Confirmed 12/17/2007 2:59:28 PM -06'00'

Author: relliott  
Subject: Cross-Out  
Date: 5/12/2008 3:36:09 PM  
 they

Status  
relliott Accepted 12/13/2007 8:43:47 PM -06'00'  
Status  
relliott Confirmed 12/13/2007 8:43:54 PM -06'00'

Author: relliott  
Subject: Note  
Date: 5/12/2008 3:36:09 PM  
 Move the "When the DISABLE bit" paragraph into the COMMON CONTROL field paragraph for the control element, since it's a bit in that field

Status  
relliott Accepted 12/21/2007 3:14:42 PM -06'00'

Author: ibm-gop  
Subject: Highlight  
Date: 12/13/2007 8:24:47 PM -06'00'  
 7.3.20 Voltage Sensor element (3rd paragraph)

**This << conditions are indicated because of the voltage values sensed. >> should be << conditions are indicated as a result of the voltage values being sensed. >>**

Status  
relliott Rejected 12/18/2007 8:50:28 PM -06'00'

Author: ibm-gop  
Subject: Highlight  
Date: 12/13/2007 8:24:47 PM -06'00'  
 7.3.20 Voltage Sensor element (3rd paragraph)

**This << When the DISABLE bit is set to zero, the voltage sensor's output is accepted normally by the enclosure services process. >> should be << When the DISABLE bit is set to zero, the voltage sensor's output is accepted by the enclosure services process. >>**

Status

services process is using the indicated language and is using UCS-2 as defined by ISO/IEC 10646-1 (i.e., encoding using 16-bit characters).

### 7.3.19 Communication Port element

The Communications Port element manages a communications port (e.g., serial port).

The format of the control field for a Communication Port element is defined in table 113.

**Table 113 — Communication Port element for control-type diagnostic pages**

Byte\Bit	7	6	5	4	3	2	1	0
0	COMMON CONTROL							
1	RQST IDENT	RQST FAIL	Reserved					
2	Reserved							
3	Reserved							DISABLE

The COMMON CONTROL field is specified in 7.2.2.

The RQST IDENT bit and the RQST FAIL bit are defined in the Cooling element (see 7.3.5).

A DISABLE bit set to one specifies that the communication port be disabled. A DISABLE bit set to zero specifies that the communication port be enabled.

The format of the status field for a Communication Port element is defined in table 114.

**Table 114 — Communication Port element for status-type diagnostic pages**

Byte\Bit	7	6	5	4	3	2	1	0
0	COMMON STATUS							
1	IDENT	FAIL	Reserved					
2	Reserved							
3	Reserved							DISABLED

The COMMON STATUS field is specified in 7.2.3.

The IDENT bit and the FAIL bit are defined in the Power Supply element (see 7.3.4).

A DISABLED bit set to one indicates that the communication port has been disabled. A DISABLED bit set to zero indicates that the communication port is enabled.

### 7.3.20 Voltage Sensor element

The Voltage Sensor element provides voltage indications in the VOLTAGE field of the ELEMENT STATUS field. The voltage indications may be compared with threshold values. The threshold values may be vendor-specific defaults or they may be set by the Threshold Out diagnostic page (see 6.1.8).

The threshold fields are defined as tolerances, specified in units of 0,5 % from a vendor-specific nominal voltage or nominal voltage range (see 6.1.8).

When the DISABLE bit in the COMMON CONTROL field (see 7.2.2) is set to one, the voltage sensor's output is not tested against any threshold values and no noncritical, critical, or unrecoverable conditions are indicated because of the voltage values sensed. When the DISABLE bit is set to zero, the voltage sensor's output is accepted normally by the enclosure services process.

Author: relliott

Subject: Note

Date: 12/19/2007 8:16:44 PM -06'00'

 When the disable bit in the common control field (see 7.2.2) is set to one, the voltage sensor's output is ignored (i.e., not tested against any threshold values. No noncritical, critical, or unrecoverable conditions are indicated because of the voltage values sensed). When the disable bit is set to zero, the voltage sensor's output is not ignored.

---

The format of the control field for a Voltage Sensor element is defined in table 115.

**Table 115 — Voltage Sensor element for control-type diagnostic pages**

Byte\Bit	7	6	5	4	3	2	1	0
0	COMMON CONTROL							
1	RQST IDENT	RQST FAIL	Reserved					
2	Reserved							
3	Reserved							

The COMMON CONTROL field is specified in 7.2.2.

The RQST IDENT bit and the RQST FAIL bit are defined in the Cooling element (see 7.3.5).

The format of the status field for a Voltage Sensor element is defined in table 116.

**Table 116 — Voltage Sensor element for status-type diagnostic pages**

Byte\Bit	7	6	5	4	3	2	1	0
0	COMMON STATUS							
1	IDENT	FAIL	Reserved		WARN OVER	WARN UNDER	CRIT OVER	CRIT UNDER
2	(MSB)							
3	VOLTAGE (LSB)							

The COMMON STATUS field is specified in 7.2.3.

The IDENT bit and the FAIL bit are defined in the Power Supply element (see 7.3.4).

A WARN OVER (over voltage warning) bit set to one indicates that the voltage indicated by the VOLTAGE field has exceeded the actual high warning threshold value (see 6.1.8). A WARN OVER bit set to zero indicates that the voltage indicated by the VOLTAGE field has fallen below the actual high warning threshold.

A WARN UNDER (under voltage warning) bit set to one indicates that the voltage indicated by the VOLTAGE field has fallen below the actual low warning threshold value (see 6.1.8). A WARN UNDER bit set to zero indicates that the voltage indicated by the VOLTAGE field has risen above the actual low warning threshold.

A CRIT OVER (critical over voltage) bit set to one indicates that the voltage indicated by the VOLTAGE field has exceeded the actual high critical threshold value (see 6.1.8). A CRIT OVER bit set to zero indicates that the voltage indicated by the VOLTAGE field has fallen below the actual high critical threshold.

A CRIT UNDER (critical under voltage) bit set to one indicates that the voltage indicated by the VOLTAGE field has fallen below the actual low critical threshold value (see 6.1.8). A CRIT UNDER bit set to zero indicates that the voltage indicated by the VOLTAGE field has risen above the actual low critical threshold.

The VOLTAGE field indicates the voltage detected by the voltage sensor, measured in units of 10 millivolts. AC voltages are measured in volts AC, RMS. The value is expressed as a 16-bit number using 2's complement notation to indicate negative numbers. The largest positive voltage that can be expressed is 327,67 volts and the largest negative voltage that can be expressed is -327,67 volts.

### 7.3.21 Current Sensor element

The Current Sensor element provides current indications in the CURRENT field of the ELEMENT STATUS field.

The current indications may be compared with threshold values. The threshold values may be vendor specific defaults or they may be set by the Threshold Out diagnostic page (see 6.1.8).

Author: hpq-relliott  
Subject: Note  
Date: 12/13/2007 8:24:34 PM -06'00'  
 Join Reserved rows in table 115

Status  
relliott Accepted 12/13/2007 10:13:07 PM -06'00'  
Status  
relliott Confirmed 12/13/2007 10:13:10 PM -06'00'

---

Author: relliott  
Subject: Highlight  
Date: 5/12/2008 3:36:09 PM  
 has exceeded  
s/b  
is above

Status  
relliott Accepted 12/19/2007 8:22:25 PM -06'00'

---

Author: ibm-gop  
Subject: Highlight  
Date: 12/13/2007 8:24:47 PM -06'00'  
 **7.3.20 Voltage Sensor element (3rd paragraph after table 116)**  
This << voltage indicated by the VOLTAGE field has fallen below the actual high warning threshold. >> should be << voltage indicated by the VOLTAGE field is below the high warning threshold. >>

Status  
relliott Accepted 12/19/2007 8:21:07 PM -06'00'

---

Author: relliott  
Subject: Highlight  
Date: 5/12/2008 3:36:09 PM  
 has fallen below  
s/b  
is below

Status  
relliott Accepted 12/19/2007 8:23:13 PM -06'00'

---

Author: ibm-gop  
Subject: Highlight  
Date: 12/13/2007 8:24:47 PM -06'00'  
 **7.3.20 Voltage Sensor element (4th paragraph after table 116)**  
This << that the voltage indicated by the VOLTAGE field has risen above the actual low warning threshold >> should be << that the voltage indicated by the VOLTAGE field is above the low warning threshold >>

Status  
relliott Accepted 12/19/2007 8:21:13 PM -06'00'

---

Author: relliott  
Subject: Highlight  
Date: 5/12/2008 3:36:09 PM  
 has exceeded  
s/b  
is above

Status  
relliott Accepted 12/19/2007 8:22:42 PM -06'00'

---

Author: ibm-gop  
Subject: Note  
Date: 12/13/2007 8:24:47 PM -06'00'  
 **7.3.20 Voltage Sensor element (3rd - 6th paragraphs after table 116)**  
Delete the term << actual >> in all cases in these paragraphs. It has no apparent value.

Status  
relliott Accepted 12/21/2007 5:18:31 PM -06'00'

---

Author: ibm-gop



The format of the control field for a Voltage Sensor element is defined in table 115.

**Table 115 — Voltage Sensor element for control-type diagnostic pages**

Byte\Bit	7	6	5	4	3	2	1	0
0	COMMON CONTROL							
1	RQST IDENT	RQST FAIL	Reserved					
2	Reserved							
3	Reserved							

The COMMON CONTROL field is specified in 7.2.2.

The RQST IDENT bit and the RQST FAIL bit are defined in the Cooling element (see 7.3.5).

The format of the status field for a Voltage Sensor element is defined in table 116.

**Table 116 — Voltage Sensor element for status-type diagnostic pages**

Byte\Bit	7	6	5	4	3	2	1	0
0	COMMON STATUS							
1	IDENT	FAIL	Reserved		WARN OVER	WARN UNDER	CRIT OVER	CRIT UNDER
2	(MSB)							
3	VOLTAGE (LSB)							

The COMMON STATUS field is specified in 7.2.3.

The IDENT bit and the FAIL bit are defined in the Power Supply element (see 7.3.4).

A WARN OVER (over voltage warning) bit set to one indicates that the voltage indicated by the VOLTAGE field has exceeded the actual high warning threshold value (see 6.1.8). A WARN OVER bit set to zero indicates that the voltage indicated by the VOLTAGE field has fallen below the actual high warning threshold.

A WARN UNDER (under voltage warning) bit set to one indicates that the voltage indicated by the VOLTAGE field has fallen below the actual low warning threshold value (see 6.1.8). A WARN UNDER bit set to zero indicates that the voltage indicated by the VOLTAGE field has risen above the actual low warning threshold.

A CRIT OVER (critical over voltage) bit set to one indicates that the voltage indicated by the VOLTAGE field has exceeded the actual high critical threshold value (see 6.1.8). A CRIT OVER bit set to zero indicates that the voltage indicated by the VOLTAGE field has fallen below the actual high critical threshold.

A CRIT UNDER (critical under voltage) bit set to one indicates that the voltage indicated by the VOLTAGE field has fallen below the actual low critical threshold value (see 6.1.8). A CRIT UNDER bit set to zero indicates that the voltage indicated by the VOLTAGE field has risen above the actual low critical threshold.

The VOLTAGE field indicates the voltage detected by the voltage sensor, measured in units of 10 millivolts. AC voltages are measured in volts AC, RMS. The value is expressed as a 16-bit number using 2's complement notation to indicate negative numbers. The largest positive voltage that can be expressed is 327,67 volts and the largest negative voltage that can be expressed is -327,67 volts.

**7.3.21 Current Sensor element**

The Current Sensor element provides current indications in the CURRENT field of the ELEMENT STATUS field.

The current indications may be compared with threshold values. The threshold values may be vendor specific defaults or they may be set by the Threshold Out diagnostic page (see 6.1.8).

Subject: Highlight

Date: 12/13/2007 8:24:47 PM -06'00'

**T** 7.3.20 Voltage Sensor element (5th paragraph after table 116)

This << voltage indicated by the VOLTAGE field has fallen below the actual high critical threshold. >> should be << voltage indicated by the VOLTAGE field is below the high critical threshold. >>

Status

relliott Accepted 12/19/2007 8:21:20 PM -06'00'

---

Author: relliott

Subject: Highlight

Date: 5/12/2008 3:36:09 PM

**T** has fallen below

s/b

is below

Status

relliott Accepted 12/19/2007 8:22:57 PM -06'00'

---

Author: ibm-gop

Subject: Highlight

Date: 12/13/2007 8:24:47 PM -06'00'

**T** 7.3.20 Voltage Sensor element (6th paragraph after table 116)

This << voltage indicated by the VOLTAGE field has risen above the actual low critical threshold. >> should be << voltage indicated by the VOLTAGE field is above the low critical threshold. >>

Status

relliott Accepted 12/19/2007 8:21:24 PM -06'00'

---

Author: ibm-gop

Subject: Highlight

Date: 12/13/2007 8:24:47 PM -06'00'

**T** 7.3.20 Voltage Sensor element (last paragraph after table 116)

This << The largest positive voltage that can be expressed is 327,67 volts and the largest negative voltage that can be expressed is -327,67 volts. >> should be << The largest positive voltage that is able to be expressed is 327,67 volts and the largest negative voltage that is able to be expressed is -327,67 volts. >>

Status

relliott Accepted 12/13/2007 10:16:25 PM -06'00'

Status

relliott Confirmed 12/13/2007 10:16:29 PM -06'00'

---

Author: relliott

Subject: Cross-Out

Date: 5/12/2008 3:36:09 PM

**T** in the CURRENT field of the ELEMENT STATUS field

Status

relliott Accepted 12/17/2007 3:00:08 PM -06'00'

Status

relliott Confirmed 12/17/2007 3:00:11 PM -06'00'

---

Author: relliott

Subject: Highlight

Date: 5/12/2008 3:36:09 PM

**T** provides current indications

s/b

manages a current sensor

Status

relliott Accepted 12/21/2007 2:55:44 PM -06'00'

---

Author: relliott

Subject: Note

Date: 5/12/2008 3:36:09 PM

**T** Move the second and third sentences of the first paragraph into the second paragraph, so all the threshold rules are together

Status

relliott Accepted 12/19/2007 8:49:08 PM -06'00'

---

Author: relliott

Subject: Cross-Out

Date: 5/12/2008 3:36:09 PM

**T** they

Comments from page 93 continued on next page

The format of the control field for a Voltage Sensor element is defined in table 115.

**Table 115 — Voltage Sensor element for control-type diagnostic pages**

Byte\Bit	7	6	5	4	3	2	1	0
0	COMMON CONTROL							
1	RQST IDENT	RQST FAIL	Reserved					
2	Reserved							
3	Reserved							

The COMMON CONTROL field is specified in 7.2.2.

The RQST IDENT bit and the RQST FAIL bit are defined in the Cooling element (see 7.3.5).

The format of the status field for a Voltage Sensor element is defined in table 116.

**Table 116 — Voltage Sensor element for status-type diagnostic pages**

Byte\Bit	7	6	5	4	3	2	1	0
0	COMMON STATUS							
1	IDENT	FAIL	Reserved		WARN OVER	WARN UNDER	CRIT OVER	CRIT UNDER
2	(MSB) _____							
3	_____ (LSB)							

The COMMON STATUS field is specified in 7.2.3.

The IDENT bit and the FAIL bit are defined in the Power Supply element (see 7.3.4).

A WARN OVER (over voltage warning) bit set to one indicates that the voltage indicated by the VOLTAGE field has exceeded the actual high warning threshold value (see 6.1.8). A WARN OVER bit set to zero indicates that the voltage indicated by the VOLTAGE field has fallen below the actual high warning threshold.

A WARN UNDER (under voltage warning) bit set to one indicates that the voltage indicated by the VOLTAGE field has fallen below the actual low warning threshold value (see 6.1.8). A WARN UNDER bit set to zero indicates that the voltage indicated by the VOLTAGE field has risen above the actual low warning threshold.

A CRIT OVER (critical over voltage) bit set to one indicates that the voltage indicated by the VOLTAGE field has exceeded the actual high critical threshold value (see 6.1.8). A CRIT OVER bit set to zero indicates that the voltage indicated by the VOLTAGE field has fallen below the actual high critical threshold.

A CRIT UNDER (critical under voltage) bit set to one indicates that the voltage indicated by the VOLTAGE field has fallen below the actual low critical threshold value (see 6.1.8). A CRIT UNDER bit set to zero indicates that the voltage indicated by the VOLTAGE field has risen above the actual low critical threshold.

The VOLTAGE field indicates the voltage detected by the voltage sensor, measured in units of 10 millivolts. AC voltages are measured in volts AC, RMS. The value is expressed as a 16-bit number using 2's complement notation to indicate negative numbers. The largest positive voltage that can be expressed is 327,67 volts and the largest negative voltage that can be expressed is -327,67 volts.

### 7.3.21 Current Sensor element

The Current Sensor element provides current indications in the CURRENT field of the ELEMENT STATUS field.

The current indications may be compared with threshold values. The threshold values may be vendor specific defaults or they may be set by the Threshold Out diagnostic page (see 6.1.8).

Status  
relliott Accepted 12/13/2007 8:44:32 PM -06'00'  
Status  
relliott Confirmed 12/13/2007 8:44:36 PM -06'00'

---

The threshold fields are defined as tolerances, specified in units of 0,5 % from a vendor specific maximum normal operation current. The low threshold fields are ignored (see 6.1.8).

When the **DISABLE bit** in the COMMON CONTROL field (see 7.2.2) is set to one, the current sensor's output is not tested against any threshold values and no noncritical, critical, or unrecoverable conditions are indicated because of the current values sensed. When the **DISABLE bit** is set to zero, the current sensor's output is accepted normally by the enclosure services process.

The format of the control field for a Current Sensor element is defined in table 117.

**Table 117 — Current Sensor element for control-type diagnostic pages**

Byte\Bit	7	6	5	4	3	2	1	0
0	COMMON CONTROL							
1	RQST IDENT	RQST FAIL	Reserved					
2	Reserved							
3	Reserved							

The COMMON CONTROL field is specified in 7.2.2.

The RQST IDENT bit and the RQST FAIL bit are defined in the Cooling element (see 7.3.5).

The format of the status field for a Current Sensor element is defined in table 118.

**Table 118 — Current Sensor element for status-type diagnostic pages**

Byte\Bit	7	6	5	4	3	2	1	0
0	COMMON STATUS							
1	IDENT	FAIL	Reserved		WARN OVER	Reserved	CRIT OVER	Reserved
2	(MSB)							
3	CURRENT (LSB)							

The COMMON STATUS field is specified in 7.2.3.

The IDENT bit and the FAIL bit are defined in the Power Supply element (see 7.3.4).

A **WARN OVER** (over current warning) bit set to one indicates that the current indicated by the **CURRENT** field has exceeded the actual high warning threshold value (see 6.1.8). A **WARN OVER** bit set to zero indicates that the current indicated by the **CURRENT** field has fallen below the actual high warning threshold.

A **CRIT OVER** (critical over current bit) is set to one indicates that the current indicated by the **CURRENT** field has exceeded the actual high critical threshold value (see 6.1.8). A **CRIT OVER** bit set to zero indicates that the current indicated by the **CURRENT** field has fallen below the actual high critical threshold.

The **CURRENT** field indicates the current detected by the current sensor, measured in units of 10 milliamps. AC currents are measured in amps AC, RMS. The value is expressed as a 16-bit number using 2's complement notation to indicate negative numbers. The largest positive current that can be expressed is 327,67 amps and the largest negative current that can be expressed is -327,67 amps.

**7.3.22 SCSI Target Port element**

The SCSI Target Port element manages a SCSI target port (e.g., the target port providing for external access to a RAID controller).

If a SCSI target/initiator port is represented by a SCSI Target Port element or a SCSI Initiator Port element, it shall be represented by only one of those elements. It should be represented by the element that most reflects

Author: relliott  
Subject: Note  
Date: 5/12/2008 3:36:09 PM

 Move the "When the DISABLE bit" paragraph into the COMMON CONTROL field paragraph for the control element, since it's a bit in that field

Status  
relliott Accepted 12/21/2007 3:14:52 PM -06'00'

Author: ibm-gop  
Subject: Highlight  
Date: 12/13/2007 8:24:47 PM -06'00'

 7.3.21 Current Sensor element (3rd paragraph)

**This << unrecoverable conditions are indicated because of the current values sensed. >> should be << unrecoverable conditions are indicated as a result of the current values being sensed. >>**

Status  
relliott Rejected 12/19/2007 8:17:59 PM -06'00'

Author: ibm-gop  
Subject: Highlight  
Date: 12/13/2007 8:24:47 PM -06'00'

 7.3.21 Current Sensor element (3rd paragraph)

**This << bit is set to zero, the current sensor's output is accepted normally by the enclosure services process. >> should be << bit is set to zero, the current sensor's output is accepted by the enclosure services process. >>**

Status  
relliott Rejected 12/19/2007 8:17:51 PM -06'00'

Author: relliott  
Subject: Note  
Date: 12/19/2007 8:17:51 PM -06'00'

 When the disable bit in the common control field (see 7.2.2) is set to one, the current sensor's output is ignored (i.e., not tested against any threshold values. No noncritical, critical, or unrecoverable conditions are indicated because of the current values sensed). When the disable bit is set to zero, the current sensor's output is not ignored.

Author: hpq-relliott  
Subject: Note  
Date: 12/13/2007 8:24:34 PM -06'00'

 Join Reserved rows in table 117

Status  
relliott Accepted 12/13/2007 10:13:25 PM -06'00'

Status  
relliott Confirmed 12/13/2007 10:13:21 PM -06'00'

Author: relliott  
Subject: Highlight  
Date: 5/12/2008 3:36:09 PM

 has exceeded  
s/b  
is above

Status  
relliott Accepted 12/19/2007 8:24:50 PM -06'00'

Author: ibm-gop  
Subject: Highlight  
Date: 12/13/2007 8:24:47 PM -06'00'

 7.3.21 Current Sensor element (3rd paragraph after table 118)

**This << current indicated by the CURRENT field has fallen below the actual high warning threshold. >> should be << current indicated by the CURRENT field is below the high warning threshold. >>**

Status

The threshold fields are defined as tolerances, specified in units of 0,5 % from a vendor specific maximum normal operation current. The low threshold fields are ignored (see 6.1.8).

When the DISABLE bit in the COMMON CONTROL field (see 7.2.2) is set to one, the current sensor's output is not tested against any threshold values and no noncritical, critical, or unrecoverable conditions are indicated because of the current values sensed. When the DISABLE bit is set to zero, the current sensor's output is accepted normally by the enclosure services process.

The format of the control field for a Current Sensor element is defined in table 117.

**Table 117 — Current Sensor element for control-type diagnostic pages**

Byte\Bit	7	6	5	4	3	2	1	0
0	COMMON CONTROL							
1	RQST IDENT	RQST FAIL	Reserved					
2	Reserved							
3	Reserved							

The COMMON CONTROL field is specified in 7.2.2.

The RQST IDENT bit and the RQST FAIL bit are defined in the Cooling element (see 7.3.5).

The format of the status field for a Current Sensor element is defined in table 118.

**Table 118 — Current Sensor element for status-type diagnostic pages**

Byte\Bit	7	6	5	4	3	2	1	0
0	COMMON STATUS							
1	IDENT	FAIL	Reserved		WARN OVER	Reserved	CRIT OVER	Reserved
2	(MSB)							
3	CURRENT (LSB)							

The COMMON STATUS field is specified in 7.2.3.

The IDENT bit and the FAIL bit are defined in the Power Supply element (see 7.3.4).

A WARN OVER (over current warning) bit set to one indicates that the current indicated by the CURRENT field has exceeded the actual high warning threshold value (see 6.1.8). A WARN OVER bit set to zero indicates that the current indicated by the CURRENT field has fallen below the actual high warning threshold.

A CRIT OVER (critical over current bit) set to one indicates that the current indicated by the CURRENT field has exceeded the actual high critical threshold value (see 6.1.8). A CRIT OVER bit set to zero indicates that the current indicated by the CURRENT field has fallen below the actual high critical threshold.

The CURRENT field indicates the current detected by the current sensor, measured in units of 10 milliamps. AC currents are measured in amps AC, RMS. The value is expressed as a 16-bit number using 2's complement notation to indicate negative numbers. The largest positive current that can be expressed is 327,67 amps and the largest negative current that can be expressed is -327,67 amps.

**7.3.22 SCSI Target Port element**

The SCSI Target Port element manages a SCSI target port (e.g., the target port providing for external access to a RAID controller).

If a SCSI target/initiator port is represented by a SCSI Target Port element or a SCSI Initiator Port element, it shall be represented by only one of those elements. It should be represented by the element that most reflects

relliott Accepted 12/19/2007 8:25:01 PM -06'00'

---

Author: relliott  
Subject: Highlight  
Date: 5/12/2008 3:36:09 PM  
**T** has exceeded  
s/b  
is above

Status  
relliott Accepted 12/19/2007 8:49:26 PM -06'00'

---

Author: ibm-gop  
Subject: Note  
Date: 12/13/2007 8:24:47 PM -06'00'  
 **7.3.21 Current Sensor element (3rd - 4th paragraphs after table 118)**  
Delete the term << actual >> in all cases in these paragraphs. It has no apparent value.

Status  
relliott Accepted 12/21/2007 5:18:18 PM -06'00'

---

Author: ibm-gop  
Subject: Highlight  
Date: 12/13/2007 8:24:47 PM -06'00'  
**T** **7.3.21 Current Sensor element (4th paragraph after table 118)**  
This << current indicated by the CURRENT field has fallen below the actual high critical threshold. >> should be << current indicated by the CURRENT field is below the high critical threshold. >>

Status  
relliott Accepted 12/19/2007 8:25:09 PM -06'00'

---

Author: ibm-gop  
Subject: Highlight  
Date: 12/13/2007 8:24:47 PM -06'00'  
**T** **7.3.21 Current Sensor element (last paragraph)**  
This << The largest positive current that can be expressed is 327,67 amps and the largest negative current that can be expressed is -327,67 amps. >> should be << The largest positive current that is able to be expressed is 327,67 amps and the largest negative current that is able to be expressed is -327,67 amps. >>

Status  
relliott Accepted 12/13/2007 10:15:54 PM -06'00'

Status  
relliott Confirmed 12/13/2007 10:15:57 PM -06'00'

---

Author: ibm-gop  
Subject: Highlight  
Date: 12/13/2007 8:24:47 PM -06'00'  
**T** **7.3.22 SCSI Target Port element (2nd paragraph)**

This << If a SCSI target/initiator port is represented by a SCSI Target Port element or a SCSI Initiator Port element, it shall be >> should be << If an enclosure contains SCSI ports that contain both a target port and an initiator port, then the enclosure may represent the SCSI port as a SCSI Target Port element or a SCSI Initiator Port element, however the SCSI port shall be >>

Status  
relliott Rejected 1/2/2008 7:51:15 PM -06'00'

---

Author: relliott  
Subject: Note  
Date: 1/2/2008 7:51:16 PM -06'00'

 If a SCSI port contains both a SCSI target port and a SCSI initiator port (see SAM-4), it may be represented by either a SCSI Target Port element or a SCSI Initiator Port element but not both

---



its functionality (e.g., in an SCC controller, a front-side SCSI port should be represented by a SCSI Target Port element even if the SCSI port also has SCSI initiator port functionality and a back-side SCSI port should be represented by a SCSI Initiator Port element even if the SCSI port also has SCSI target port functionality).

Additional information about a SCSI Target Port element may be reported in the Additional Element Status diagnostic page (see 6.1.13).

The format of the control field for a SCSI Target Port element is defined in table 119.

**Table 119 — SCSI Target Port element for control-type diagnostic pages**

Byte\Bit	7	6	5	4	3	2	1	0
0	COMMON CONTROL							
1	RQST IDENT	RQST FAIL	Reserved					
2	Reserved							
3	Reserved							ENABLE

The COMMON CONTROL field is specified in 7.2.2.

The RQST IDENT bit and the RQST FAIL bit are defined in the Cooling element (see 7.3.5).

An ENABLE bit set to one specifies that the SCSI target port be enabled. An ENABLE bit set to zero specifies that the SCSI target port be disabled.

The format of the status field for a SCSI Target Port element is defined in table 120.

**Table 120 — SCSI Target Port element for status-type diagnostic pages**

Byte\Bit	7	6	5	4	3	2	1	0
0	COMMON STATUS							
1	IDENT	FAIL	Reserved					
2	Reserved							REPORT
3	Reserved							ENABLED

The COMMON STATUS field is specified in 7.2.3.

The IDENT bit and the FAIL bit are defined in the Power Supply element (see 7.3.4).

A REPORT bit set to one indicates that the enclosure services process is using this SCSI target port as part of the path for transmitting the status-type diagnostic page. A REPORT bit set to zero indicates that this SCSI target port did not participate in the transmission of the status-type diagnostic page.

An ENABLED bit set to one indicates that the SCSI target port is enabled. An ENABLED bit set to zero indicates that the SCSI target port is disabled.

### 7.3.23 SCSI Initiator Port element

The SCSI Initiator Port element manages a SCSI initiator port (e.g., the initiator port used by a RAID controller to access disk drives).

See 7.3.22 for requirements for SCSI target/initiator ports.

Additional information about a SCSI Initiator Port element may be reported in the Additional Element Status diagnostic page (see 6.1.13).

Author: relliott  
Subject: Highlight  
Date: 5/12/2008 3:36:09 PM

**T** as part of  
the path for transmitting  
s/b  
to return

Status  
relliott Accepted 1/4/2008 6:35:41 PM -06'00'

---

Author: relliott  
Subject: Highlight  
Date: 5/12/2008 3:36:09 PM

**T** status-type diagnostic page  
s/b

Enclosure Status diagnostic page

Status  
relliott Accepted 1/3/2008 6:05:10 PM -06'00'

---

Author: relliott  
Subject: Highlight  
Date: 5/12/2008 3:36:09 PM

**T** status-type diagnostic page  
s/b

Enclosure Status diagnostic page

Status  
relliott Accepted 1/3/2008 6:05:19 PM -06'00'

---

Author: relliott  
Subject: Highlight  
Date: 5/12/2008 3:36:09 PM

**T** this SCSI target port did not participate in the transmission  
s/b

it is not using this SCSI target port to return

Status  
relliott Accepted 1/4/2008 6:36:08 PM -06'00'

---

The format of the control field for a SCSI Initiator Port element is defined in table 121.

**Table 121 — SCSI Initiator Port element for control-type diagnostic pages**

Byte\Bit	7	6	5	4	3	2	1	0
0	COMMON CONTROL							
1	RQST IDENT	RQST FAIL	Reserved					
2	Reserved							
3	Reserved							ENABLE

The COMMON CONTROL field is specified in 7.2.2.

The RQST IDENT bit and the RQST FAIL bit are defined in the Cooling element (see 7.3.5).

An ENABLE bit set to one specifies that the SCSI initiator port be enabled. An ENABLE bit set to zero specifies that the SCSI initiator port be disabled.

The format of the status field for a SCSI Initiator Port element is defined in table 122.

**Table 122 — SCSI Initiator Port element for status-type diagnostic pages**

Byte\Bit	7	6	5	4	3	2	1	0
0	COMMON STATUS							
1	IDENT	FAIL	Reserved					
2	Reserved							REPORT
3	Reserved							ENABLED

The COMMON STATUS field is specified in 7.2.3.

The IDENT bit and the FAIL bit are defined in the Power Supply element (see 7.3.4).

A REPORT bit set to one indicates that the enclosure services process is using this SCSI initiator port as part of the path for transmitting the status-type diagnostic page. A REPORT bit set to zero indicates that this SCSI initiator port did not participate in the transmission of the status-type diagnostic page.

An ENABLED bit set to one indicates that the SCSI initiator port is enabled. An ENABLED bit is set to zero indicates that the SCSI initiator port is disabled.

**7.3.24 Simple Subenclosure element**

The Simple Subenclosure element manages a subenclosure that only provides the Short Enclosure Status diagnostic page (see 6.1.11).

The format of the control field for a Simple Subenclosure element is defined in table 123.

**Table 123 — Simple Subenclosure element for control-type diagnostic pages**

Byte\Bit	7	6	5	4	3	2	1	0
0	COMMON CONTROL							
1	RQST IDENT	RQST FAIL	Reserved					
2	Reserved							
3	Reserved							

Author: relliott  
Subject: Highlight  
Date: 5/12/2008 3:36:09 PM  
**T** is using this SCSI initiator port as part of  
the path for transmitting  
s/b  
is using this SCSI initiator port to return

Status  
relliott Accepted 1/4/2008 6:34:14 PM -06'00'

---

Author: relliott  
Subject: Highlight  
Date: 5/12/2008 3:36:09 PM  
**T** status-type diagnostic page  
s/b  
Enclosure Status diagnostic page

Status  
relliott Accepted 1/3/2008 6:05:31 PM -06'00'

---

Author: relliott  
Subject: Highlight  
Date: 5/12/2008 3:36:09 PM  
**T** this SCSI  
initiator port did not participate in the transmission  
s/b  
it is not using this SCSI initiator port to return

Status  
relliott Accepted 1/4/2008 6:34:44 PM -06'00'

---

Author: relliott  
Subject: Highlight  
Date: 5/12/2008 3:36:09 PM  
**T** status-type diagnostic page  
s/b  
Enclosure Status diagnostic page

Status  
relliott Accepted 1/3/2008 6:05:38 PM -06'00'

---

Author: relliott  
Subject: Highlight  
Date: 5/12/2008 3:36:09 PM  
**T** manages a subenclosure that only provides the Short Enclosure Status  
diagnostic page (see 6.1.11).  
s/b  
manages a secondary subenclosure that is a simple subenclosure (see 4.7)

Status  
relliott Accepted 12/21/2007 6:03:23 PM -06'00'

---

Author: hpq-relliott  
Subject: Note  
Date: 12/13/2007 8:24:34 PM -06'00'  
 Join Reserved rows in table 123

Status  
relliott Accepted 12/13/2007 10:13:48 PM -06'00'

Status  
relliott Confirmed 12/13/2007 10:13:51 PM -06'00'

---

The COMMON CONTROL field is specified in 7.2.2.

The RQST IDENT bit and the RQST FAIL bit are defined in the Cooling element (see 7.3.5).

The format of the status field for a Simple Subenclosure element is defined in table 124.

**Table 124 — Simple Subenclosure element for status-type diagnostic pages**

Byte\Bit	7	6	5	4	3	2	1	0
0	COMMON STATUS							
1	IDENT	FAIL	Reserved					
2	Reserved							
3	SHORT ENCLOSURE STATUS							

The COMMON STATUS field is specified in 7.2.3.

The IDENT bit and the FAIL bit are defined in the Power Supply element (see 7.3.4).

The SHORT ENCLOSURE STATUS field contains the contents of the SHORT ENCLOSURE STATUS field of the Short Enclosure Status diagnostic page (see 6.1.11) from the specified subenclosure.

**7.3.25 SAS Expander element**

The SAS Expander element manages a SAS expander device.

Additional information about a SAS Expander element may be reported in the Additional Element Status diagnostic page (see 6.1.13).

The format of the control field for a SAS Expander element is defined in table 125.

**Table 125 — SAS Expander element for control-type diagnostic pages**

Byte\Bit	7	6	5	4	3	2	1	0
0	COMMON CONTROL							
1	RQST IDENT	RQST FAIL	Reserved					
2	Reserved							
3	Reserved							

The COMMON CONTROL field is specified in 7.2.2.

The RQST IDENT bit and the RQST FAIL bit are defined in the Cooling element (see 7.3.5).

The format of the status field for a SAS Expander element is defined in table 126.

**Table 126 — SAS Expander element for status-type diagnostic pages**

Byte\Bit	7	6	5	4	3	2	1	0
0	COMMON STATUS							
1	IDENT	FAIL	Reserved					
2	Reserved							
3	Reserved							

The COMMON STATUS field is specified in 7.2.3.

The IDENT bit and the FAIL bit are defined in the Power Supply element (see 7.3.4).

● Author: relliott  
Subject: Highlight  
Date: 5/12/2008 3:36:09 PM

 specified  
s/b  
secondary

Status  
relliott Accepted 12/21/2007 6:04:38 PM -06'00'

---

● Author: hpq-relliott  
Subject: Note  
Date: 12/13/2007 8:24:34 PM -06'00'

 Join Reserved rows in table 125

Status  
relliott Accepted 12/13/2007 10:14:45 PM -06'00'

Status  
relliott Confirmed 12/13/2007 10:14:48 PM -06'00'

---

● Author: hpq-relliott  
Subject: Note  
Date: 12/13/2007 8:24:34 PM -06'00'

 Join Reserved rows in table 126

Status  
relliott Accepted 12/13/2007 10:14:52 PM -06'00'

Status  
relliott Confirmed 12/13/2007 10:14:55 PM -06'00'

---

### 7.3.26 SAS Connector element

The SAS Connector element manages a SAS connector or a portion of a SAS connector.

The format of the control field for a SAS Connector element is defined in table 127.

**Table 127 — SAS Connector element for control-type diagnostic pages**

Byte\Bit	7	6	5	4	3	2	1	0
0	COMMON CONTROL							
1	RQST IDENT	Reserved						
2	Reserved							
3	Reserved	RQST FAIL	Reserved					

The COMMON CONTROL field is specified in 7.2.2.

The RQST IDENT bit and the RQST FAIL bit are defined in the Cooling element (see 7.3.5).

The format of the status field for a SAS Connector element is defined in table 128.

**Table 128 — SAS Connector element for status-type diagnostic pages**

Byte\Bit	7	6	5	4	3	2	1	0
0	COMMON STATUS							
1	IDENT	CONNECTOR TYPE						
2	CONNECTOR PHYSICAL LINK							
3	Reserved	FAIL	Reserved					

The COMMON STATUS field is specified in 7.2.3.

The IDENT bit and the FAIL bit are defined in the Power Supply element (see 7.3.4).

This page contains no comments



The CONNECTOR TYPE field indicates the type of connector and is defined in table 129.

**Table 129 — CONNECTOR TYPE field**

Code	Description	Maximum number of physical links (informative)
00h	No information	unknown
External connectors		
01h	SAS 4x receptacle (see SAS-2 and SFF-8470)	4
02h	Mini SAS 4x receptacle (see SAS-2 and SFF-8088)	4
03h to 0Eh	Reserved for external connectors	
0Fh	Vendor-specific external connector	unknown
Internal wide connectors		
10h	SAS 4i plug (see SAS-2 and SFF-8484)	4
11h	Mini SAS 4i receptacle (see SAS-2 and SFF-8087)	4
12h to 1Fh	Reserved for internal wide connectors	
Internal connectors to end devices		
20h	SAS Drive receptacle (see SAS-2 and SFF-8482)	2
21h	SATA host plug (see SAS-2 and SATA-2)	1
22h	SAS Drive plug (see SAS-2 and SFF-8482)	2
23h	SATA device plug (see SAS-2 and SATA-2)	1
24h to 2Eh	Reserved for internal connectors to end devices	
2Fh	SAS virtual connector	1
Internal connectors		
30h to 3Eh	Reserved for internal connectors	
3Fh	Vendor-specific internal connector	unknown
Other		
40h to 6Fh	Reserved	
70h to 7Fh	Vendor specific	

The CONNECTOR PHYSICAL LINK field indicates the physical link in the connector represented by this element. A CONNECTOR PHYSICAL LINK field set to FFh indicates that the element represents the entire connector, not just one physical link in the connector. Physical links in a connector shall be numbered starting with zero. If a connector has only one physical link, the CONNECTOR PHYSICAL LINK field should be set to 00h rather than FFh.

This page contains no comments