



Working Draft American National Standard



Project

T10/1711-D

Comment Resolution Tally	
Integrated into SAT-r08d:	1404
Rejected:	96
Cancelled (e.g., withdrawn):	118

Total comments submitted:	1618

Revision 08
17 January 2006

Information technology - SCSI / ATA Translation (SAT)



This is an internal working document of T10, an International Technical Committee of Accredited Standards Committee INCITS (International Committee for Information Technology Standards). As such this is not a completed standard and has not been approved. The contents may be modified by the T10 Technical Committee. The contents are actively being modified by T10. This document is made available for review and comment only.

Permission is granted to members of INCITS, its technical committees, and their associated task groups to reproduce this document for the purposes of INCITS standardization activities without further permission, provided this notice is included. All other rights are reserved. Any duplication of this document for commercial or for-profit use is strictly prohibited.

T10 Technical Editor:

Robert L. Sheffield
Intel Corporation
CH6-333
5000 W. Chandler Blvd.
Chandler, AZ
85226
USA

Telephone: 480-554-8597
Facsimile: 480-554-7347
Email: robert.l.sheffield@intel.com



Reference number
ISO/IEC XXXXX-XXX : 200x
ANSI NCITS.***:200x

Summary of Comments on SCSI / ATA Translation Standard

Page: 1

Sequence number: 1
Author: IBM[GPenokie]
Subject: Note
Date: 2/14/2006 3:55:07 PM

 IBM

Status
rlsheffi Cancelled 3/2/2006 7:50:26 PM

Sequence number: 2
Author: IBM[GPenokie]
Subject: Note
Date: 2/24/2006 12:39:28 PM

 ACCEPT:
Comment: i

Status
rlsheffi Cancelled 3/2/2006 7:50:40 PM

Sequence number: 3
Author: EDITOR[rlsheffi]
Subject: Note
Date: 5/26/2006 8:41:34 AM
 Change all references to ATA/ATAPI-7 to ATA8-ACS, ATA8-APT, ATA8-AST, or ATA8-AAM.
DONE: Create notes for each change and record in LB comment resolution.
Per SAT LB meeting 3/20/06
Will set completed on individual instances as they are done.

Status
rlsheffi Completed 5/26/2006 8:41:54 AM

Sequence number: 4
Author: DELL[KMarks]
Subject: Note
Date: 7/23/2006 11:05:06 AM

 CONFIRM: with Kevin marks after completing changes. Need clarification. SAT does address block-storage devices. Don't want to preclude other device types in future versions of the standard though.
Curtis [WD] echoes this thought and suggests deleting clause-13. AR: Confirm with Kevin Marks.

Comment: Global:

5. The standard, in parts, seem to imply (with shall) that only direct-access block devices are supported, but other areas leave it open. Example is the mode page block descriptor section.

Suggested resolution: Global - find everywhere in main clauses allowing flexibility for non block devices and restrict it to block devices (i.e., specify field values that have to apply for block devices).

Done: create comments and review with SAT WG.

RESOLUTION: See 06-216

Status
rlsheffi Completed 7/23/2006 11:04:13 AM

Sequence number: 5
Author: DELL[KMarks]
Subject: Note
Date: 2/24/2006 12:43:23 PM

 Global
6. Remove change bars

Status
rlsheffi Completed 5/26/2006 11:31:45 AM

Comments from page 1 continued on next page



Working Draft American National Standard



Project T10/1711-D

Revision 08
17 January 2006

Information technology - SCSI / ATA Translation (SAT)



This is an internal working document of T10, an International Technical Committee of Accredited Standards Committee INCITS (International Committee for Information Technology Standards). As such this is not a completed standard and has not been approved. The contents may be modified by the T10 Technical Committee. The contents are actively being modified by T10. This document is made available for review and comment only.

Permission is granted to members of INCITS, its technical committees, and their associated task groups to reproduce this document for the purposes of INCITS standardization activities without further permission, provided this notice is included. All other rights are reserved. Any duplication of this document for commercial or for-profit use is strictly prohibited.

T10 Technical Editor:

Robert L. Sheffield
Intel Corporation
CH6-333
5000 W. Chandler Blvd.
Chandler, AZ
85226
USA

Telephone: 480-554-8597
Facsimile: 480-554-7347
Email: robert.l.sheffield@intel.com



Reference number
ISO/IEC XXXXX-XXX : 200x
ANSI NCITS.***:200x

Sequence number: 6
Author: DELL[KMarks]
Subject: Note
Date: 2/28/2006 11:35:10 AM

 Need clarification. Feb 28 WG recommended deletion.

Comment: Global

7. The word "attached" is not used regularly. Search for ATA device and remove form one's present or add "attached" where applicable.

Status
risheffi Completed 5/26/2006 11:37:27 AM

Sequence number: 7
Author: DELL[KMarks]
Subject: Note
Date: 3/9/2006 1:48:22 PM

 REASON: "Terminate the command" is consistent with other SCSI standards.

Comment: Global

8. Through out standard, the words "terminate the command is use" Shouldn't this be task, and not command.
CONFIRMED

Status
risheffi Rejected 2/24/2006 12:44:04 PM

Sequence number: 8
Author: DELL[KMarks]
Subject: Note
Date: 2/24/2006 12:44:42 PM

 Comment: Global

4. Search for IDENTIFY DEVICE data, and add ATA in front. Same for IDENTIFY PACKET DEVICE data.

Status
risheffi Completed 5/26/2006 11:54:59 AM

Sequence number: 9
Author: DELL[KMarks]
Subject: Note
Date: 2/24/2006 12:42:44 PM

 Global

3. Since this is a SCSI spec, remove SCSI from in front of SCSI commands.

Status
risheffi Completed 5/26/2006 12:26:25 PM

Sequence number: 10
Author: DELL[KMarks]
Subject: Note
Date: 2/24/2006 12:45:01 PM

 Global:

2. Sometimes ATA commands have ATA in front, like ATA IDENTIFY DEVICE some times they don't. Recommend that all ATA commands have ATA in front, unless in table when the column header says ATA command.

Status
risheffi Completed 6/24/2006 8:59:47 AM

Sequence number: 11
Author: DELL[KMarks]
Subject: Note
Date: 2/24/2006 12:45:31 PM

 Global:

1. Both "SCSI/ATA translation" and "SCSI/ATA Translation" are used. Need to make all capital T or lower case. Prefer lower case, unless referring to this standard specifically.

Resolution: Will always capitalize the 'T' in Translation, as I believe all usages refer to the standard.

Status
risheffi Completed 5/26/2006 12:30:17 PM

Sequence number: 12
Author: HPQ[RElliott]
Subject: Note
Date: 1/19/2006 9:44:11 AM

Comments from page 1 continued on next page



Working Draft American National Standard



Project
T10/1711-D

Revision 08
17 January 2006

Information technology - SCSI / ATA Translation (SAT)



This is an internal working document of T10, an International Technical Committee of Accredited Standards Committee INCITS (International Committee for Information Technology Standards). As such this is not a completed standard and has not been approved. The contents may be modified by the T10 Technical Committee. The contents are actively being modified by T10. This document is made available for review and comment only.

Permission is granted to members of INCITS, its technical committees, and their associated task groups to reproduce this document for the purposes of INCITS standardization activities without further permission, provided this notice is included. All other rights are reserved. Any duplication of this document for commercial or for-profit use is strictly prohibited.

T10 Technical Editor:

Robert L. Sheffield
Intel Corporation
CH6-333
5000 W. Chandler Blvd.
Chandler, AZ
85226
USA

Telephone: 480-554-8597
Facsimile: 480-554-7347
Email: robert.l.sheffield@intel.com



Reference number
ISO/IEC XXXXX-XXX : 200x
ANSI NCITS.*:200x**

 General

Adjust the PDF page numbers to match the printed page numbers

Status

risheffi Completed

7/23/2006 12:06:04 PM

1 **Points of Contact:**

International Committee for Information Technology Standards (INCITS) T10 Technical Committee

T10 Chair

John B. Lohmeyer
LSI Logic
4420 Arrows West Drive
Colorado Springs, CO 80907-3444
USA

Tel: (719) 533-7560
Fax: (719) 533-7183
Email: lohmeyer@t10.org

T10 Vice-Chair

George O. Penokie
IBM Corporation
MS: **3C6**
3605 Highway 52 N
Rochester, MN 55901
USA



Tel: (507) 253-5208
Fax: (507) 253-2880
Email: gop@us.ibm.com

INCITS Secretariat

INCITS Secretariat
1250 Eye Street, NW Suite 200
Washington, DC 20005

Telephone: 202-737-8888
Facsimile: 202-638-4922
Email: incits@itic.org

Information Technology Industry Council

Web site: <http://www.itic.org>

T10 Web Site www.t10.org

T10 Reflector To subscribe send e-mail to majordomo@T10.org with 'subscribe' in message body
To unsubscribe send e-mail to majordomo@T10.org with 'unsubscribe' in message body
Internet address for distribution via T10 reflector: T10@T10.org

Document Distribution

INCITS Online Store
managed by Techstreet
1327 Jones Drive
Ann Arbor, MI 48105
USA

Web site: <http://www.techstreet.com/incits.html>
Telephone: (734) 302-7801 or (800) 699-9277

Global Engineering Documents, an IHS Company Telephone: 303-792-2181 or
15 Inverness Way East 800-854-7179
Englewood, CO 80112-5704 Facsimile: 303-792-2192

Web site: <http://global.ihs.com>
Telephone: (303) 397-7956 or (303) 792-2181 or (800) 854-7179

Page: 2

Sequence number: 1
Author: IBM[GPenokie]
Subject: Underline
Date: 3/7/2006 6:48:59 AM

T Points of Contact:

Status

rsheffi Cancelled 3/7/2006 6:48:56 AM

Sequence number: 2
Author: LSI[JLohmeyer]
Subject: Note
Date: 2/28/2006 11:40:09 AM

 Consider using the Draft watermark that George Penokie created for SBC-3 on all pages after the cover page.

Status

rsheffi Completed 6/24/2006 8:32:55 AM

Sequence number: 3
Author: IBM[GPenokie]
Subject: Highlight
Date: 2/14/2006 4:05:09 PM

T Change to 49C

Status

rsheffi Completed 5/26/2006 12:32:06 PM

Draft

**American National Standards
for Information Systems -**

SCSI / ATA Translation (SAT)

Secretariat
National Committee for Information Technology Standards

Approved mm dd yy

American National Standards Institute, Inc.

Abstract

²This standard specifies elements of translation between SCSI and ATA protocol for storage controllers that emulate SCSI capabilities using ATA/ATAPI devices, and a translation layer to provide capabilities defined by other SCSI standards, particularly those defined in SCSI Block Commands (SBC-2) and SCSI Primary Commands (SPC-3). For the purposes of this standard, ATA/ATAPI device capabilities are defined by ATA/ATAPI-7.

Draft

Page: 3

Sequence number: 1
Author: MXO[MEvans]
Subject: Highlight
Date: 2/28/2006 11:53:12 AM

T Delete "ANSI (r) NCITS.***:200x" from the upper right corner.

Status
rlsheffi Completed 5/26/2006 12:32:52 PM

Sequence number: 2
Author: MXO[MEvans]
Subject: Highlight
Date: 5/22/2006 10:49:13 AM

T Accepted per Feb 28 WG

This standard specifies a translation layer between SCSI and ATA protocols. This translation layer is used by storage controllers to emulate objects in a SCSI logical unit using an ATA device, providing capabilities defined by SCSI standards (e.g., the SCSI Block Commands (SBC-2) and SCSI Primary Commands (SPC-3) standards). For the purposes of this standard, ATA/ATAPI device capabilities are defined by ATA/ATAPI-7.

RESOLUTION: change to

"This standard specifies a translation layer between SCSI and ATA protocols. This translation layer is used by storage controllers to emulate objects in a SCSI logical unit using an ATA device, providing capabilities defined by SCSI standards (e.g., the SCSI Block Commands (SBC-2) and SCSI Primary Commands (SPC-3) standards). For the purposes of this standard, ATA device capabilities are defined by ATA8-AAM, ATA8-ACS, ATA8-AST, and ATA8-APT."

Status
rlsheffi Completed 5/26/2006 12:34:09 PM

American National Standard

Approval of an American National Standard requires verification by ANSI that the requirements for due process, consensus, and other criteria for approval have been met by the standards developer. Consensus is established when, in the judgment of the ANSI Board of Standards Review, substantial agreement has been reached by directly and materially affected interests. Substantial agreement means much more than a simple majority, but not necessarily unanimity. Consensus requires that all views and objections be considered and that effort be made toward their resolution.

The use of American National Standards is completely voluntary; their existence does not in any respect preclude anyone, whether he or she has approved the standards or not, from manufacturing, marketing, purchasing, or using products, processes, or procedures not confirming to the standards.

The American National Standards Institute does not develop standards and shall in no circumstances give interpretation on any American National Standard in the name of the American National Standards Institute. Requests for interpretations should be addressed to the secretariat or sponsor whose name appears on the title page of this standard.

CAUTION NOTICE: This American National Standard may be revised or withdrawn at any time. The procedures of the American National Standards Institute require that action be taken periodically to reaffirm, revise, or withdraw this standard. Purchasers of American National Standards may receive current information on all standards by calling or writing the American National Standards Institute.

CAUTION: The developers of this standard have requested that holders of patents that may be required for the implementation of the standard, disclose such patents to the publisher. However, neither the developers nor the publisher have undertaken a patent search in order to identify which, if any, patents may apply to this standard. As of the date of publication of this standard, following calls for the identification of patents that may be required for the implementation of the standard, notice of one or more claims has been received. By publication of this standard, no position is taken with respect to the validity of this claim or of any rights in connection therewith. The known patent holder(s) has (have), however, filed a statement of willingness to grant a license under these rights on reasonable and nondiscriminatory terms and conditions to applicants desiring to obtain such a license. Details may be obtained from the publisher. No further patent search is conducted by the developer or the publisher in respect to any standard it processes. No representation is made or implied that licenses are not required to avoid infringement in the use of this standard.

Published by
American National Standards Institute
11 West 42nd Street, New York, NY 10036

Copyright © 200x by American National Standards Institute
All rights reserved.

No part of this publication may be reproduced in any form, in an electronic retrieval system or otherwise, without prior written permission of ITI, 1250 Eye Street NW, Suite 200, Washington, DC 20005.

Printed in the United States of America

Draft



Sequence number: 1
Author: WDC[CStevens]
Subject: Replacement Text
Date: 2/10/2006 3:09:11 PM
 S/B 2006?

Status
risheffi Completed 5/26/2006 12:34:59 PM

Contents

	Page
1 Scope	1
2 Normative References	4
2.1 Normative references	4
2.2 Approved references	4
2.3 References under development	4
2.4 Other references	4
3 Definitions, symbols, abbreviations, and conventions	5
3.1 Definitions	5
3.2 Symbols and abbreviations	9
3.3 Keywords	10
3.4 Command description specific terminology	11
3.5 Conventions	11
3.5.1 Overview	11
3.5.2 Bit and byte ordering	12
3.5.3 Notation for byte encoded character strings	12
3.5.4 Notation for command descriptions	13
3.5.4.1 Description	13
3.5.4.2 Recursive descent	13
3.5.4.2.1 Overview	13
3.5.4.2.2 Detailed field description	14
3.5.5 Use of field names defined in ATA standards and specifications	14
4 General	15
5 SCSI Architectural Elements	17
5.1 Overview	17
5.2 Unit attention condition	17
5.3 Handling errors in ATA commands	18
6 Task Management Model	19
6.1 Overview	19
6.2 Queued commands	19
6.2.1 Comparison of SCSI and ATA queuing	19
6.2.2 Mapping of SCSI queued commands to ATA queued commands	19
6.2.3 Commands the SATL queues internally	20
6.2.4 Multi-initiator and multi-port command queuing	20
6.3 Task management functions	20
6.3.1 Task management functions overview	20
6.3.2 ABORT TASK	21
6.3.3 ABORT TASK SET	21
6.3.4 CLEAR ACA	21
6.3.5 CLEAR TASK SET	21
6.3.6 LOGICAL UNIT RESET	22
6.3.7 QUERY TASK	22
6.4 SCSI Control Byte	22
6.4.1 CONTROL byte overview	22
6.5 SAM-3 I_T nexus loss	23
7 Summary of SCSI / ATA command mappings	24
7.1 Translated and emulated commands	24
8 SCSI Primary Commands (SPC) Mapping	26

This page contains no comments

8.1 INQUIRY command	26
8.1.1 INQUIRY command overview	26
8.1.2 Standard INQUIRY data	26
8.2 LOG SENSE command	29
8.2.1 LOG SENSE command overview	29
8.2.2 PC (page control) field	30
8.2.3 PAGE CODE field	30
8.3 MODE SELECT (6) command	31
8.3.1 MODE SELECT (6) command overview	31
8.3.2 MODE SELECT (6) CDB fields	31
8.3.3 Mode parameter header	31
8.3.3.1 Mode parameter block descriptor fields	32
8.4 MODE SELECT (10) command	32
8.4.1 MODE SELECT (10) command overview	32
8.4.2 Mode parameter header (10)	32
8.5 MODE SENSE (6) command	33
8.5.1 MODE SENSE (6) command overview	33
8.5.2 MODE SENSE (6) CDB fields	33
8.5.3 PC (Page Control)	33
8.5.4 Mode parameter header (6)	33
8.5.5 General mode parameter block descriptor fields	34
8.5.6 Mode Sense Block Descriptor (8 byte format)	34
8.6 MODE SENSE (10) command	35
8.6.1 MODE SENSE (10) command overview	35
8.6.2 Mode parameter header (10)	35
8.7 READ BUFFER command	36
8.7.1 READ BUFFER command overview	36
8.7.2 MODE field	36
8.7.3 Data Only mode (02h)  1	36
8.7.4 Descriptor mode (03h) 	36
8.8 READ MEDIA SERIAL NUMBER command	37
8.8.1 READ MEDIA SERIAL NUMBER command overview	37
8.8.2 READ MEDIAL SERIAL NUMBER emulation	37
8.9 REQUEST SENSE command	37
8.9.1 REQUEST SENSE command overview	37
8.9.2 FORMAT UNIT In Progress	38
8.9.3 SMART Threshold Exceeded Condition	38
8.9.4 ATA Device in Low Power State	38
8.10 SEND DIAGNOSTIC command	39
8.10.1 SEND DIAGNOSTIC command overview	39
8.10.2 SELF-TEST CODE field	39
8.10.3 SELFTEST bit	41
8.11 TEST UNIT READY command	42
8.11.1 TEST UNIT READY command overview	42
8.11.2 TEST UNIT READY OPERATION CODE	42
8.12 WRITE BUFFER command	43
8.12.1 WRITE BUFFER command overview	43
8.12.2 MODE field	43
8.12.3 Data Only mode (02h)  2	44
8.12.4 Download microcode mode (5h)	44
9 SCSI Block Commands (SBC) Mapping	45
9.1 Translating LBA and transfer length and ATA command use constraints	45
9.2 FORMAT UNIT command	47
9.2.1 FORMAT UNIT command overview	47
9.2.2 FORMAT UNIT parameter list	47
9.2.3 SATL defect list header field combinations	48

Page: 6

Sequence number: 1
Author: HPQ[WBellamy]
Subject: Note
Date: 3/7/2006 1:15:51 PM

 Should this hex content be here? I don't believe identification codes are supposed to be here.
RESOLUTION: Remove hex values

Also, remember for SPC-4 letter-ballot (or ask SPC-4 editor to change it).

Status
risheffi Completed 5/26/2006 12:36:53 PM



Sequence number: 2
Author: HPQ[WBellamy]
Subject: Note
Date: 3/7/2006 1:16:44 PM

 Should this hex content be here? I don't believe identification codes are supposed to be here.
RESOLUTOIN: Delete hex content (and fix SPC-4 too).

Status
risheffi Completed 5/26/2006 12:37:09 PM

9.2.4 FOV bit	48
9.2.5 DCRT bit	48
9.2.6 IP bit	49
9.3 READ commands overview	49
9.3.1 READ commands operation code translation	49
9.3.2 READ commands with FUA	49
9.4 READ (6) command	50
9.5 READ (10) command	50
9.6 READ (12) command	51
9.7 READ (16) command	51
9.8 READ CAPACITY (10) command	52
9.8.1 READ CAPACITY command overview	52
9.8.2 READ CAPACITY data	52
9.9 READ CAPACITY (16) command	52
9.9.1 READ CAPACITY (16) command overview	52
9.9.2 READ CAPACITY data	53
9.10 REASSIGN BLOCKS command	53
9.10.1 REASSIGN BLOCKS command overview	53
9.10.2 REASSIGN BLOCKS operation code	53
9.11 START STOP UNIT command	54
9.11.1 START STOP UNIT command overview	54
9.11.2 IMMED bit processing for the START STOP UNIT command	54
9.11.2.1 Before processing the START STOP UNIT command	54
9.11.2.2 After START STOP UNIT completes with no error	54
9.11.2.3 After START STOP UNIT completes with an error	54
9.11.3 START STOP UNIT START bit LOEJ bit combinations	55
9.12 SYNCHRONIZE CACHE (10) command	56
9.12.1 SYNCHRONIZE CACHE (10) command overview	56
9.13 SYNCHRONIZE CACHE (16) command	57
9.13.1 SYNCHRONIZE CACHE (16) command overview	57
9.14 VERIFY (10) command	57
9.15 VERIFY (12) command	58
9.16 VERIFY (16) command	58
9.17 WRITE commands overview	58
9.17.1 WRITE commands OPERATION CODE translation	58
9.17.2 WRITE commands with FUA	59
9.18 WRITE (6) command	59
9.19 WRITE (10) command	59
9.20 WRITE (12) command	60
9.21 WRITE (16) command	61
9.22 WRITE AND VERIFY commands overview	61
9.23 WRITE AND VERIFY (10) command	62
9.24 WRITE AND VERIFY (12) command	62
9.25 WRITE AND VERIFY (16) command	63
9.26 WRITE SAME (10) command	64
9.26.1 WRITE SAME (10) command overview	64
9.26.2 LBDATA bit and PBDATA bit	64
9.27 WRITE SAME (16) command	65
10 Parameters for SAT implementations	66
10.1 Mode parameters	66
10.1.1 General information	66
10.1.2 Changeable parameters	66
10.1.3 Commonly used SCSI mode pages overview	66
10.1.4 Control mode page	66
10.1.4.1 General Translation	66
10.1.4.2 Extended self-test completion time	67

This page contains no comments

- 10.1.5 Read-Write Error Recovery mode page 68
- 10.1.6 Caching mode page (08h)  69
- 10.1.7 Informational Exceptions Control mode page 71
 - 10.1.7.1 Informational Exceptions Control mode page overview 71
 - 10.1.7.2 Method of reporting informational exceptions (MRIE) 72
- 10.2 Log Pages 72
 - 10.2.1 Log pages overview 72
 - 10.2.2 Retrieving SMART data from targets 72
 - 10.2.3 Informational Exceptions log page 72
 - 10.2.3.1 Additional sense code and additional sense code qualifier translations 73
 - 10.2.3.2 Most recent temperature reading translation 73
 - 10.2.4 Self-Test Results log page 74
 - 10.2.4.1 Self-Test Results log page overview 74
 - 10.2.4.2 A method of determining ATA command selection for field translations 75
 - 10.2.4.3 Sense key and additional sense code 75
 - 10.2.5 Supported Log Pages log page 76
- 10.3 Vital product data parameters 77
 - 10.3.1 Vital product data parameters overview 77
 - 10.3.2 Supported VPD pages VPD page 77
 - 10.3.3 Unit Serial Number VPD page 77
 - 10.3.4 Device Identification VPD page 78
 - 10.3.4.1 Device Identification VPD page overview 78
 - 10.3.4.2 Logical unit name 79
 - 10.3.4.2.1 Logical unit name overview 79
 - 10.3.4.2.2 Logical unit name derived from the world wide name 79
 - 10.3.4.2.3 Logical unit name derived from the model number and serial number 80
 - 10.3.4.3 Examples of additional identification descriptors 81
 - 10.3.4.3.1 Identification descriptors included by a SATL in an ATA host 81
 - 10.3.4.3.2 Identification descriptors included by a SATL in a SAS initiator device 82
 - 10.3.4.3.3 Identification descriptors included by a SATL in a SCSI to ATA protocol bridge 83
 - 10.3.5 ATA Information VPD page 83
- 11 Error Handling and Sense Reporting 87
 - 11.1 Error Translation – ATA device error to SCSI error map 87
- 12 SAT-Specific SCSI Extensions 88
 - 12.1 SAT-Specific SCSI Extensions Overview 88
 - 12.2 ATA PASS-THROUGH commands 88
 - 12.2.1 ATA PASS-THROUGH commands overview 88
 - 12.2.2 ATA PASS-THROUGH (12) command 88
 - 12.2.3 ATA PASS-THROUGH (16) command 91
 - 12.2.4 ATA PASS-THROUGH status return 93
 - 12.2.5 ATA Status Return Descriptor 94
 - 12.3 SAT-specific mode pages 94
 - 12.3.1 SAT-specific mode pages overview 94
 - 12.3.2 PATA Control Mode Page (Page 0Ah, Sub Page F1h)  95
- 13 Translation for ATAPI devices 100
 - 13.1 Overview 100
 - 13.2 Commands 100
 - 13.2.1 INQUIRY command 100
 - 13.2.1.1 INQUIRY command overview 100
 - 13.2.1.2 Supported VPD Pages VPD page 100
 - 13.2.1.3 ATA Information VPD page 100

Page: 8

Sequence number: 1
Author: HPQ[WBellamy]
Subject: Note
Date: 2/24/2006 1:04:09 PM

 Why only certain pages have this hex content and not others?
Resolution: Delete hex encoding from mode-page paragraph headings for consistency with SBC-2 and SPC-3

Status
risheffi Completed 5/26/2006 12:38:35 PM

Sequence number: 2
Author: HPQ[WBellamy]
Subject: Note
Date: 2/24/2006 1:04:41 PM

 Why only certain pages have this page hex context and not others?
Resolution: Delete hex encoding from mode-page paragraph headings for consistency with SBC-2 and SPC-3

Status
risheffi Completed 5/26/2006 12:40:31 PM

Tables

	Page
1 ISO and American numbering conventions examples	12
2 Format for translated command field descriptions	13
3 Format for summary field expanded descriptions	13
4 Comparison of SCSI and ATA queuing methods	19
5 Control byte fields	22
6 Summary of SCSI / ATA Command Mapping	24
7 INQUIRY command CDB fields	26
8 Standard INQUIRY data fields	27
9 LOG SENSE command CDB fields	29
10 PC field values	30
11 PAGE CODE field values	30
12 MODE SELECT (6) command CDB fields	31
13 Mode parameter header (6) fields	31
14 Mode parameter block descriptor fields	32
15 Mode parameter header (10) fields	32
16 MODE SENSE (6) CDB fields	33
17 PC values and their descriptions	33
18 Mode parameter header (6) fields	34
19 General mode parameter block descriptor fields	34
20 Mode parameter block descriptor fields	35
21 Mode parameter header (10) fields	35
22 READ BUFFER command CDB fields	36
23 MODE field	36
24 READ MEDIA SERIAL NUMBER command CDB fields	37
25 Special Request Sense behavior reference	38
26 REQUEST SENSE command CDB fields	38
27 SEND DIAGNOSTIC command CDB fields	39
28 SELF-TEST CODE field decode	40
29 SELFTEST bit	41
30 TEST UNIT READY command CDB fields	42
31 WRITE BUFFER command CDB fields	43
32 MODE field	43
33 Constraints for fields in the WRITE BUFFER command CDB	44
34 Read and write type command translation selection	46
35 FORMAT UNIT command CDB fields	47
36 SATL defect list header	48
37 SATL defect list header field combinations	48
38 READ (6) command CDB fields	50
39 READ (10) command CDB fields	50
40 READ (12) command CDB fields	51
41 READ (16) command CDB fields	51
42 READ CAPACITY(10) command CDB fields	52
43 READ CAPACITY (10) data	52
44 READ CAPACITY(16) command CDB fields	52
45 READ CAPACITY (16) data	53
46 REASSIGN BLOCKS command CDB fields	53
47 START/STOP UNIT command CDB fields	54
48 Definition of IMMED, LOEJ, and START bits in the START STOP UNIT CDB	55
49 SYNCHRONIZE CACHE (10) command CDB fields	56
50 SYNCHRONIZE CACHE(10) command CDB fields	57
51 VERIFY (10) command CDB fields	57
52 VERIFY (12) command CDB fields	58
53 VERIFY (16) command CDB fields	58
54 WRITE (6) command CDB fields	59
55 WRITE (10) command CDB fields	59

This page contains no comments

56 WRITE (12) command CDB fields 60

57 WRITE (16) command CDB fields 61

58 WRITE AND VERIFY (10) command CDB fields 62

59 WRITE AND VERIFY (12) command CDB fields 62

60 WRITE AND VERIFY (16) command CDB fields 63

61 WRITE SAME (10) command CDB fields 64

62 LBADATA and PBDATA fields 64

63 WRITE SAME (16) command CDB fields 65

64 Summary of SCSI / ATA mode page mapping 66

65 Control mode page fields 67

66 Read-write error recovery mode page fields 68

67 Caching mode page fields 69

68 Informational Exceptions Control mode page fields 71

69 Summary of SCSI / ATA log page mapping 72

70 Informational Exceptions log page header fields 72

71 Informational Exceptions general parameter data 73

72 ATA SMART RETURN STATUS translations 73

73 Self-Test Results log page fields 74

74 Self-Test Results log parameters 74

75 ATA Self-test execution status values translated to SCSI sense keys and sense codes 76

76 Supported Log pages log page fields 76

77 Summary of SCSI / ATA VPD page mapping 77

78 Supported VPD pages VPD page fields 77

79 Unit Serial Number VPD page for SAT 77

80 PRODUCT SERIAL NUMBER field 78

81 Device Identification VPD page for SAT 78

82 Logical unit name derived from the world wide name 79

83 Fields in the logical unit name 80

84 Logical unit name derived from the model number and serial number 80

85 VENDOR SPECIFIC IDENTIFIER field for logical unit name 81

86 Target port identifier for SAS 82

87 ATA Information VPD page 84

88 SIGNATURE field 85

89 Common signature values (informative) 85

90 IDENTIFY DEVICE OR IDENTIFY PACKET DEVICE DATA field 86

91 Translation of ATA errors to SCSI errors 87

92 ATA PASS-THROUGH (12) command 88

93 PROTOCOL field 89

94 ATA PASS-THROUGH (12) command and ATA PASS-THROUGH (16) command DEVICE field 90

95 T_LENGTH field 91

96 ATA PASS-THROUGH (16) command 92

97 EXTEND bit and T_LENGTH field 93

98 ATA command results 93

99 Extended ATA Status Return Descriptor 94

100 SCSI - ATA Translation specific mode pages 95

101 PATA Control mode page 95

102 PIO modes 96

103 MWDMA modes reported by MODE SENSE 97

104 UDMA Field Requirements for changeable MODE SENSE 98

105 UDMA for current MODE SENSE settings 98

This page contains no comments

Figures

	Page
1 SCSI document relationships	2
2 ATA document structure	2
3 SCSI/ATA translation document role	2
4 SAT functional protocol reference model	17
5 Identification descriptors included by a SATL in an ATA host	81
6 Identification descriptors included by a SATL in a SAS initiator device	82
7 Identification descriptors included by a SATL in a SCSI to ATA protocol bridge	83

This page contains no comments



Revision Information

R.x T10/04-136r0 (27 June 2004)

First prerelease of SAT. Substantive content copied from T10/04-136r0, "SCSI to ATA Command Translations", written by Samantha Ranaweera and Stephen Johnson of LSI Logic Corporation.

R.0 SAT-r00 (26 August 2004)



Incorporated feedback from previous SAT SG and WG meetings regarding scope, elements covered, command queuing and task management.

R.1 SAT-r01 (22 September 2004)

Incorporated changes per the August 2004 SAT WG (04-276r0), the September 2004 SAT WG (04-286r0), and the September 2004 T10 plenary (04-289r0):

- a) 04-260r2 SAT Command Mapping Format (Curtis Stevens, WD),
- b) 04-219r3 SAT SPC-3 ATA Information VPD page (Rob Elliott and Wayne Bellamy, HP).

Incorporated miscellaneous changes identified during review of the SAT working draft at the August and September SAT working groups.

R.1a SAT-r01a (28 November 2004)

Incorporated changes identified during review of the draft from the October 14, 2004 SAT WG Teleconference, the October 22 SAT WG meeting, and the November 9 SAT WG meeting.

- a) Changed the DESC bit in the REQUEST SENSE CDB from "U" to "E" specifying that it is implemented according to SAM-3.
- b) Allowed for READ CAPACITY command to return less than the maximum ATA medium capacity.
- c) Added optional support for PERSISTENT RESERVE IN and PERSISTENT RESERVE OUT.
- d) Allowed the SATL to support the descriptor format sense data.
- e) Extended WRITE BUFFER to support download microcode and download microcode and save modes.
- f) Various changes to FORMAT UNIT including referencing SBC-2 for FMTPINFO, added optional support for device certification (DCRT = 0 caused READ VERIFY / WRITE of media), and added optional support for initialization pattern (IP = 1 causes WRITE commands to establish media initialization per SBC-2). Clarified conditions for returning immediate completion status.
- g) Referred to SBC-2 for the handling of commands received while a FORMAT UNIT is in progress.
- h) Added SATA documents to normative references: "Serial ATA 1.0 Design Guides", "Serial ATA II: Extensions to Serial ATA 1.0a. Revision 1.2", and "Serial ATA II: Port Selector. Revision 1.0. 28 July 2003".
- i) Added the terms, "SATA IIe" and "SATA IIps" to the glossary.
- j) Added criteria for and use of READ DMA QUEUED, READ DMA QUEUED EXTENDED, and READ FPDMA QUEUED commands in the translation of SCSI READ commands.
- k) Added support of FUA for READ(10,12) commands using either READ FPDMA QUEUED or READ VERIFY followed by read.
- l) Added subclause 5.2 to explain UNIT ATTENTION handling.
- m) Removed references to Data Protection from READ (10) and READ (12) and added reference to SBC-2 in place.
- n) Modified READ CAPACITY to accommodate ATA logical sector sizes other than 512-bytes in a vendor-specific manner, and to allow reporting a SCSI returned logical block address less than the capacity of the attached ATA device.
- o) Added a subclause for REASSIGN BLOCKS with an editor's note that a proposal is needed to detail the translation. The note suggests using a READ VERIFY READ, WRITE, READ VERIFY type sequence to force the ATA disk to assign an alternate block.
- p) Modified START STOP UNIT translation to use STANDBY, IDLE, and READ VERIFY commands, and to define use of the ATA Standby timer to emulate the SCSI STANDBY CONDITION TIMER.
- q) Added criteria for and use of WRITE DMA QUEUED, WRITE DMA QUEUED EXTENDED, and WRITE FPDMA QUEUED commands in the translation of SCSI WRITE commands.

Page: 12

Sequence number: 1
Author: ENDL[RWeber]
Date: 2/14/2006 7:21:57 PM
 Remove revision history

Status
risheffi Completed 5/26/2006 12:41:25 PM

Sequence number: 2
Author: IBM[GPenokie]
Subject: Underline
Date: 2/16/2006 1:38:55 PM
 Revision Information

Status
risheffi Cancelled 5/26/2006 12:41:58 PM

Sequence number: 3
Author: LSI[JLohmeyer]
Subject: Cross-Out
Date: 2/14/2006 4:18:43 PM
 Revision Information (pages xii - xvii)

Delete the Revision Information section.

Status
risheffi Completed 5/26/2006 12:42:27 PM

Sequence number: 4
Author: IBM[GPenokie]
Subject: Note
Date: 2/15/2006 7:11:27 AM
 All change bars need to be removed.

Status
risheffi Completed 5/26/2006 12:42:46 PM

Sequence number: 5
Author: IBM[GPenokie]
Subject: Note
Date: 2/14/2006 4:04:44 PM
 Remove all revision information.

Status
risheffi Completed 5/26/2006 12:42:57 PM

R.2 SAT-r02 (18 February 2005)

Incorporated changes identified during review of the draft from SAT WG meetings and teleconferences December 2, 2004; December 16-17, 2004; January 18, 2004; and February 8, 2004; and integrated proposals as follows:

- a) Integrated 04-218r8: SAT Inquiry contents
- b) Added notation conventions to represent non-printable and white space ASCII characters in strings.
- c) Added FPDMA and NCQ to the acronyms list, added corresponding glossary entries.
- d) Moved “ATA” and “ATAPI” to the acronym list and replaced the glossary entries with the spelled-out versions.
- e) Added SATL to the acronyms list and replaced the glossary entry with “SCSI / ATA translation layer”.
- f) Added the definition of “one” to the glossary.
- g) Changed the definition of ATA domain to refer to “an ATA host” rather than multiple ATA hosts. Added an editor’s note to highlight that final resolution to the issue is still pending.
- h) Changed all occurrences of “ATA device” to “non-packet device” to be consistent with the definition and usage throughout the document.
- i) Modified the definition of hard reset to use the definition in SAM-3.
- j) Added a paragraph to the “General” clause (clause-4) to say anything optional in SPC-3 or SBC-2 is optional in SAT, and any optional behaviors implemented shall be implemented per SAT.
- k) In FORMAT UNIT, specified that DEFECT LIST FORMATS of 000b (mandatory) and 110b (vendor-specific) mean the DEFECT LIST LENGTH is zero, and other values terminate the command with error.
- l) Fixed the OPERATION CODE description in the FORMAT CDB to specify no commands are issued with no defect header or DCRT = 1, and referred to a sub-clause if DCRT = 0.
- m) Added an editor’s note regarding use of PIO commands in READ translation (reminder for the WG to discuss the issue again).
- n) Changed “Overlapped” features to “Queued” features in the READ command summary (table 40) because Overlapped commands are being obsoleted.
- o) Added an editor’s note in REASSIGN BLOCKS that there is a proposal in process (listed in 04-391) to formally define the REASSIGN BLOCKS command.
- p) In the Start Stop Unit command operation code description, replaced the list of ATA commands issued with a paragraph reference.
- q) In the START STOP UNIT command, added a parenthetical statement that the need to issue an ATA READ VERIFY command is only needed if the device is configured to startup in STANDBY mode, and otherwise the device goes to the ACTIVE state.
- r) Made miscellaneous editorial changes and added editor’s comments where more clarification may be needed.
- s) Corrected the sense of the IMMED bit in the description of START STOP UNIT when POWER CONDITION, LOEJ and START are all zero.

R.3 SAT-r03 (8 April 2005)

Incorporated changes identified during review of the draft from SAT WG meetings and teleconferences February 24-25 2005,... as follows:

- a) Incorporated 04-262r8: ATA Command Pass-Through [Stevens];
- b) Incorporated 04-397r3: Control Mode Page Proposal [Overby];
- c) Added several terms to the definitions;
- d) Added several items to the acronyms list which already had corresponding definitions in the glossary;
- e) Deleted the placeholder subclause 7.2 SCSI ATA Passthrough command as subclause 13.2 has already been added for this command;
- f) Deleted text in the subclause defining conventions for character strings (3.4.3) that describes the representation of non-printable ASCII characters; and replaced it with a statement on using the ‘~’ character to represent a space in a string;
- g) Replace the word “execute” (and variants) with the word “process” (or appropriate variant) wherever it refers to the processing of a command or task;
- h) Qualified text in the clause 7.1, Translated and emulated commands, to clarify that optional commands in SPC-3 and SBC-2 are optional in SAT, and that the translation for unlisted commands is vendor-specific;

This page contains no comments

- i) Added Table-4 commands summary entries for 16-byte block access commands, READ (16), READ CAPACITY (16), SYNCHRONIZE CACHE (16), VERIFY (16), WRITE (16), WRITE AND VERIFY (16), and WRITE SAME (16) - appropriate clauses will be entered when proposals are submitted;
- j) Added Table-4 commands summary entries for VERIFY (12), WRITE AND VERIFY (12), and WRITE SAME (10) commands - appropriate clauses will be entered when proposals are submitted;
- k) Added the FLUSH CACHE EXT command as one of the ATA commands used to implement the SCSI SYNCHRONIZE CACHE command;
- l) Modified the description of the DEXCPT field in the Informational Exceptions Control Mode Page (table 68);
- m) Clarified the description of the REQUEST SENSE command; and
- n) Made miscellaneous editorial changes.

R.4 SAT-r04 (12 May 2005)

Incorporated SAT WG proposals approved in the May plenary as follows:

- a) 05-109r0 REQUEST SENSE Correction Proposal [Overby] (with notes from draft review 3 May 2005); and
- b) 05-137r1 Standard INQUIRY - PRODUCT REVISION LEVEL [Bellamy].

Incorporated changes identified during review of the draft from SAT WG meetings and teleconferences in April and May 2005 as follows:

- a) deleted template text from clause 10;
- b) added autosense to definitions;
- c) made “should” and “shall” keyword definitions consistent with SAS;
- d) clarified definition of the “unspecified” keyword;
- e) simplified Table-1 to better show the use of the “implemented”, “emulated”, and “unspecified” keywords;
- f) deleted text and editor’s note in 8.3.1 MODE SELECT (6) command overview that discussed sharing mode page header and block descriptor;
- g) made significant changes to WRITE BUFFER download microcode modes - supporting modes 5h, 6h, and 7h, and specifying that the SATL issues MICROCODE DOWNLOAD only on the first WRITE BUFFER, and continues the data transfer with subsequent WRITE BUFFER commands;
- h) Removed the “Is NCQ enabled”, “Is Queuing enabled”, and “and SCSI OP Codes” columns in the write command summary table 58, modified the last two rows and table footnotes to clarify the use of NCQ and the non-packet device Overlapped feature set;
- i) Clarified the transfer length for the WRITE (12) command, adding that multiple ATA commands may be sent to satisfy the specified transfer length;
- j) Deleted the Format Device and Rigid Disk Geometry pages from the list of commonly used SCSI mode pages in Table 62 (because SBC-2 made them obsolete);
- k) Moved the INQUIRY VPD pages subclause from the primary commands clause (8) to the device parameters clause (10), and modified the heading levels to match;
- l) Added a glossary entry for ATA queued commands and used it in the commands overview clause (7) in the description of the requirement for a SATL to queue internally any commands that are not ATA queued commands;
- m) Miscellaneous editorial changes; and
- n) Added table-50 listing the mode page translations defined in the SAT standard.

R.5 SAT-r05 (8 August 2005)

Incorporated SAT WG proposals approved in the July 2005 plenary as follows:

- a) 05-136r2 SAT - REASSIGN BLOCKS command [Bellamy]
- b) 05-177r2 Write Same Translation [Stevens]
- c) 05-239r1 Caching mode page [Bellamy]
- d) 05-229r0 Remove Persistent Reservation Commands [Lohmeyer]
- e) 05-227r2 READ MEDIA SERIAL NUMBER proposal [Overby]
- f) 05-233r3 ATA to SCSI Errors [Bellamy]
- g) 05-238r2 Informational Exceptions Mode Page [Bellamy]
- h) 05-241r2 Read-Write Error Recovery Page [Bellamy]

This page contains no comments

- i) 05-280r1 SAT: COMRESET Notification [Overby]
- j) 05-253r1 PACKET / non-PACKET Device Definition [Overby]

Made the following changes based on notes taken during review of the working draft:

- a) Clarified text in subclause 11.3 discussing host notification of SMART conditions, and in particular, changed the returned additional sense code from GENERAL HARDWARE FAILURE (specified as 05h/10h which isn't defined in SPC-3), to HARDWARE IMPENDING FAILURE GENERAL HARD DRIVE FAILURE.
- b) Added a "Changeable" column to the table describing the Caching mode page for consistency with 05-238r2.
- c) Added a "mantra" statement to the Scope stating that SAT is, as much as possible, consistent with SAM-3, SPC-3, and SBC-2.
- d) Added the T13 technical report, 1701DT Smart Command Transfer (SCT), to the list of normative references to support the WRITE SAME command translation (05-177r2).
- e) Under 6.3.1 ABORT TASK, deleted unordered list item (e) which attempted to define a response to a failed attempt by the SATL to abort a command. But SCSI defines no such response.
- f) Added a statement at the beginning of the scope subclause (copied from SPC-3) to allow flexibility in implementation so long as it satisfies the requirement for interoperability.
- g) Deleted subclause 8.2.1 describing the page code under the LOG SENSE command and replaced text in the page code field in the command overview table with a reference to subclause 10.2 LOG PAGES.
- h) Removed WRITE BUFFER download microcode modes 4, 6, and 7 from table-30 and accompanying text, and added a table footnote explaining why only mode-5 is defined by SAT with a suggestion to use of ATA PASS-THROUGH; as was recommended by a SAT WG vote on July 12, 2005.
- i) Modified the list of common mode pages in subclause 10.1.3 to show all pages except the Read-Write Error Recovery, Caching, and Informational Exceptions Control mode pages as SATType "U" (unspecified) since there are no proposals yet to define translations for any of the other mode pages.
- j) Removed all instances of "See SPC-3" from tables showing translations marked as SATType "U", and having no additional description provided. This was per a straw-poll vote taken at the July 12, 2005 SAT WG.
- k) Modified several definitions in subclause 3.1.
- l) Deleted several definitions in subclause 3.1 that are not referenced anywhere in the body of the standard.
- m) Moved the definitions of "emulated", "implemented", and "unspecified" from the keywords subclause into the general definitions subclause, and modified the definitions to reflect that they are not keywords and for clarification identified in the July 2005 SAT WG.
- n) Modified table 4 in the commands summary (clause 7) to indicate ATA command mnemonics instead of opcodes and to make it consistent with command descriptions in other subclauses.
- o) Added ATA PASS-THROUGH commands to clause-7, summary of SAT command mappings.
- p) General cleanup of tables, references, and editorial changes.
- q) Removed the subclause describing VERIFY (6) since the command is not defined for block storage devices.

R.6 SAT-r06 (21 September 2005)

Incorporated SAT WG proposals approved in the September 2005 plenary as follows:

- a) 05-142r4 SAT - LOG SENSE command and SMART [Bellamy]
- b) 05-247r3 SAT: Add 16-byte CDBs and PIO modes [Sheffield]
- c) 05-226r3 SAT, START STOP UNIT command mapping [Evans]
- d) 05-108r3 SAT Task Management [Johnson]
- e) Incorporated editorial changes from the September 15, 2005 SAT editing session.

This page contains no comments

R.7 SAT-r07 (17 November 2005)

Incorporated SAT WG proposals approved in the November 2005 plenary as follows:

- a) 05-364r1 SAT comparison of SCSI and ATA queuing [Weber];
- b) 05-359r2 SAT: Control mode page translation [Overby];
- c) 05-385r1 SAT - MOST RECENT TEMPERATURE READING for Informational Exceptions Log Page [Bellamy].

Made miscellaneous other modifications resulting from draft review and editing sessions, including:

- a) Modified the IP disclaimer to account for a letter of assurance T10 received regarding a SAT-related patent;
- b) Extended definition of ATA hard reset to include parallel-ATA resets;
- c) Added logical block address (LBA) to definitions and acronyms;
- d) Removed REPORT LUNS subclause;
- e) Added conventions for terms referenced from ATA standards;
- f) Added a subclause with a brief description of the FOV bit in the defect list header;
- g) Added a table to decode defect list header bit combinations;
- h) Reformatted READ command and WRITE command subclauses so that common information is together at the beginning of each command type;
- i) Reformatted table decoding WRITE BUFFER CDB fields to pull IMMED bit handling out into a separate subclause;
- j) Added a table to show the settings of MWDMA bits in the Parallel ATA Control mode page;
- k) Made many editorial changes resulting from review of the working draft and editing sessions.

R.7a SAT-r07a (3 January 2006) - provisional from 12 December 2005 WG meeting

Incorporated (provisionally) SAT WG proposals recommended to the T10 plenary in the 12 December 2005 WG meeting, including:

- a) 05-245r4: SAT - SEND DIAGNOSTIC command and Self-Test Results [Bellamy];
- b) 06-001r1: SAT - I_T Nexus Loss [Sheffield];
- c) 06-020r1: Clarify error handling for PIO data-in commands [Elliott/Weber]; and
- d) 06-022r0 Rewrite TEST UNIT READY rewrite [Sheffield].

Incorporated changes identified during SAT draft review:

- a) Removed the reserved field from the table describing the MODE SENSE Block Descriptor fields;
- b) Modified footnote (b) in table-33 Read and write type command translation selection to identify the CHECK CONDITION status the SATL should return if it doesn't support 48-bit addressing and receives a command requesting access to an LBA beyond ($2^{28}-1$);
- c) Simplified the text in 5.2 explaining unit attention conditions according to draft review;
- d) made various editorial changes; and
- e) removed all but one editor's note (a reminder to update normative references - i.e., check SATA references).

This page contains no comments

R.8 SAT-r08 (17 January 2006) - posted for T10 letter ballot

Incorporated editorial changes identified in the January 10, 2006 SAT WG meeting, and the January 12, 2006 SAT editing session.

This page contains no comments

1 Foreword

This foreword is not part of American National Standard 2 INCITS.***:200x.

This standard provides a common set of definitions and requirements to establish common behavior among implementations that emulate SCSI device behavior through the combined use of ATA devices and a SCSI / ATA translation layer (SATL). The SATL may reside in a host-based driver, or it may reside in a separate component (e.g., a host bus adapter or external controller) with a separate processing unit to effect the translation. A SATL and ATA device combination may provide a functional subset of common SCSI capabilities. There is also a range of optional emulated SCSI capabilities that may be supported or not, depending on the capabilities of the SATL.

This standard defines SATL capabilities in terms of SCSI capabilities as defined by the applicable SCSI standards and working drafts, and defines the elements and use of ATA protocol to provide those SCSI capabilities and services in a consistent manner among SAT implementations that implement according to this standard.

With any technical document there may arise questions of interpretation as new products are implemented. INCITS has established procedures to issue technical opinions concerning the standards developed by INCITS. These procedures may result in SCSI Technical Information Bulletins being published by INCITS.

These Bulletins, while reflecting the opinion of the Technical Committee that developed the standard, are intended solely as supplementary information to other users of the standard. This standard, ANSI INCITS.***:200x, as approved through the publication and voting procedures of the American National Standards Institute, is not altered by these bulletins. Any subsequent revision to this standard may or may not reflect the contents of these Technical Information Bulletins.

Current INCITS practice is to make Technical Information Bulletins available through: 3

4 Global 5 Engineering Telephone: 303-792-2181 or

15 Inverness Way East 800-854-7179

Englewood, CO 80112-5704

Facsimile: 303-792-2192

Requests for interpretation, suggestions for improvement and addenda, or defect reports are welcome. They should be sent to the INCITS Secretariat, National Committee for Information Technology Standards, Information Technology Institute, 1250 Eye Street, NW, Suite 200, Washington, DC 20005-3922.

This standard was processed and approved for submittal to ANSI by the InterNational Committee for Information Technology Standards (INCITS). Committee approval of the standard does not necessarily imply that all committee members voted for approval. At the time of it approved this standard, INCITS had the following members:

<<Insert INCITS member list>>

Technical Committee T10 on Lower Level Interfaces, which developed and reviewed this standard, had the following members:



Page: 18

Sequence number: 1
Author: IBM[GPenokie]
Subject: Underline
Date: 3/7/2006 6:52:23 AM

T Foreword

Status

risheffi Cancelled 2/28/2006 2:02:00 PM

Sequence number: 2
Author: HPQ[RElliott]
Date: 5/26/2006 12:50:54 PM

T Foreword

NCITS. ***:200x. s/b INCITS xxx-200x

RESOLUTION:

"This foreword is not part of American National Standard INCITS ***-200x.

Status

risheffi Completed 5/26/2006 12:53:18 PM

Sequence number: 3
Author: IBM[GPenokie]
Subject: Rectangle
Date: 2/15/2006 7:22:59 AM

T This should be (see SPC for correct formatting):

Current INCITS practice is to make Technical Information Bulletins available through:

INCITS Online Store <http://www.techstreet.com/incits.html>

managed by Techstreet Telephone: 1-734-302-7801 or

1327 Jones Drive 1-800-699-9277

Ann Arbor, MI 48105 Facsimile: 1-734-302-7811

or

Global Engineering <http://global.ihs.com/>

15 Inverness Way East Telephone: 1-303-792-2181 or

Englewood, CO 80112-5704 1-800-854-7179

Facsimile: 1-303-792-2192

Status

risheffi Completed 5/26/2006 1:03:53 PM

Sequence number: 4
Author: MXO[MEvans]
Subject: Highlight
Date: 2/14/2006 10:53:45 AM

T Foreword: change TIB contact information to be as follows (see the SCSI style guide for proper formatting):

INCITS Online Store <http://www.techstreet.com/INCITS.html>

managed by Techstreet Telephone: 1-734-302-7801 or

1327 Jones Drive 1-800-699-9277

Ann Arbor, MI 48105 Facsimile: 1-734-302-7811

or

Global Engineering <http://global.ihs.com/>

15 Inverness Way East Telephone: 1-303-792-2181 or

Englewood, CO 80112-5704 1-800-854-7179

Facsimile: 1-303-792-2192

Status

risheffi Completed 5/26/2006 1:04:41 PM

Sequence number: 5
Author: ENDL[RWeber]
Date: 2/14/2006 7:23:47 PM

T Do not place Global Engineering Telephone number on same line as company name

Status

Comments from page 18 continued on next page

Foreword

This foreword is not part of American National Standard **NCITS.***:200x.**

This standard provides a common set of definitions and requirements to establish common behavior among implementations that emulate SCSI device behavior through the combined use of ATA devices and a SCSI / ATA translation layer (SATL). The SATL may reside in a host-based driver, or it may reside in a separate component (e.g., a host bus adapter or external controller) with a separate processing unit to effect the translation. A SATL and ATA device combination may provide a functional subset of common SCSI capabilities. There is also a range of optional emulated SCSI capabilities that may be supported or not, depending on the capabilities of the SATL.

This standard defines SATL capabilities in terms of SCSI capabilities as defined by the applicable SCSI standards and working drafts, and defines the elements and use of ATA protocol to provide those SCSI capabilities and services in a consistent manner among SAT implementations that implement according to this standard.

With any technical document there may arise questions of interpretation as new products are implemented. INCITS has established procedures to issue technical opinions concerning the standards developed by INCITS. These procedures may result in SCSI Technical Information Bulletins being published by INCITS.

These Bulletins, while reflecting the opinion of the Technical Committee that developed the standard, are intended solely as supplementary information to other users of the standard. This standard, ANSI NCITS.***:200x, as approved through the publication and voting procedures of the American National Standards Institute, is not altered by these bulletins. Any subsequent revision to this standard may or may not reflect the contents of these Technical Information Bulletins.

Current INCITS practice is to make Technical Information Bulletins available through:

Global Engineering Telephone: 303-792-2181 or

15 Inverness Way East 800-854-7179

Englewood, CO 80112-5704

Facsimile: 303-792-2192

Requests for interpretation, suggestions for improvement and addenda, or defect reports are welcome. They should be sent to the INCITS Secretariat, National Committee for Information Technology Standards, Information Technology Institute, 1250 Eye Street, NW, Suite 200, Washington, DC 20005-3922.

This standard was processed and approved for submittal to ANSI by the InterNational Committee for Information Technology Standards (INCITS). Committee approval of the standard does not necessarily imply that all committee members voted for approval. At the time of it approved this standard, INCITS had the following members:

<<Insert INCITS member list>>

Technical Committee T10 on Lower Level Interfaces, which developed and reviewed this standard, had the following members:



risheffi Completed 5/26/2006 1:05:46 PM

Sequence number: 6
Author: ENDL[RWeber]
Date: 2/14/2006 7:23:03 PM

 Remove blank lines between the line of the Global Engineering Address.

Status

risheffi Completed 5/26/2006 1:05:55 PM

Sequence number: 7
Author: ENDL[RWeber]
Date: 2/14/2006 7:24:50 PM

 Do not allow page break between sentence fragment that introduces the T10 members list and the members list proper.

Status

risheffi Completed 5/26/2006 6:46:14 PM

John B. Lohmeyer, Chair
George O. Penokie, Vice-Chair
Ralph O. Wehrt, Secretary

Note:  members list before posting for letter ballot

Page: 19

Sequence number: 1
Author: DELL[KMarks]
Subject: Note
Date: 1/30/2006 9:46:52 PM

 In Foreword

Add member list prior to forwarding to INCITS

Status
rlsheffi Completed 5/26/2006 6:45:59 PM

Sequence number: 2
Author: ENDL[RWeber]
Date: 2/14/2006 7:25:42 PM

 RE: "Note: Add members list before posting for letter ballot" It is a little late for Letter Ballot, but this advice needs to be followed prior to Public Review.

Status
rlsheffi Completed 5/26/2006 6:45:45 PM

Sequence number: 3
Author: LSI[JLohmeyer]
Subject: Highlight
Date: 2/14/2006 4:21:56 PM

 T10 membership list on page xix

Add T10 members list (available on T10 Project Editors Web Page).

Status
rlsheffi Completed 5/26/2006 6:45:02 PM

Introduction

The SCSI / ATA Translation (SAT) standard is divided into the following clauses:

Clause 1 defines the scope of this standard.

Clause 2 enumerates the normative references that apply to this standard.

Clause 3 describes the definitions, symbols, abbreviations, and notation conventions used in this standard.

Clause 4 describes the general framework for defining elements of translation between SCSI and ATA protocol.

Clause 5 describes elements of SCSI/ATA translation that relate to the SCSI architecture model.

Clause 6 describes the mapping of task management functions in the SATL layer.

Clause 7 provide a summary of SCSI commands mapped to ATA in this standard.

Clause 8 describes the mapping between SCSI Primary Commands and ATA protocol.

Clause 9 describes the mapping between SCSI Block Commands and ATA protocol.

Clause 10 describes the mapping of mode page and log page information to selected ATA protocol elements.

Clause 11 describes the mapping of SMART capabilities from ATA to SCSI.

Clause 12 describes error reporting and sense data conventions for SCSI/ATA translation.

Clause 13 describes SCSI commands, mode pages and log pages to support SCSI / ATA Translation.

Clause 14 describes SCSI / ATA Translation elements specific to ATAPI devices.

Appendix A provides informative text to assist in the implementation of SCSI/ATA translation.

Page: 20

Sequence number: 1
Author: MXO[MEvans]
Subject: Highlight
Date: 2/6/2006 12:35:53 PM

T Introduction, sentence describing clause 4: turn off hyphenization and indent the wrapped word (i.e., "protocol").

Status
rlsheffi Completed 5/26/2006 6:50:02 PM

Sequence number: 2
Author: DELL[KMarks]
Subject: Highlight
Date: 2/24/2006 1:42:40 PM

T Introduction

Change

"

...

Clause 10 describes the mapping of mode page and log page information to selected ATA protocol elements.

Clause 11 describes the mapping of SMART capabilities from ATA to SCSI.

Clause 12 describes error reporting and sense data conventions for SCSI/ATA translation.

Clause 13 describes SCSI commands, mode pages and log pages to support SCSI / ATA Translation.

Clause 14 describes SCSI / ATA Translation elements specific to ATAPI devices.

Appendix A provides informative text to assist in the implementation of SCSI/ATA translation."

to

"

Clause 10 describes the mapping of mode page and log page information to selected ATA protocol elements.

Clause 11 describes error reporting and sense data conventions for SCSI/ATA translation.

Clause 12 describes SCSI commands, and mode pages to support SCSI / ATA Translation.

Clause 13 describes SCSI / ATA Translation elements specific to ATAPI devices.

"

Resolution: As suggested, and adding VPD pages to clause 10 as suggested by R. Weber.

Status
rlsheffi Completed 5/26/2006 6:59:54 PM

Sequence number: 3
Author: ENDL[RWeber]
Date: 2/24/2006 1:43:20 PM

T Clause 10 also describes VPD page mappings, in addition to the mode page and log page mappings mentioned
Resolution: "Clause 10 describes the mapping of mode pages, log pages, and VPD page information to selected ATA protocol elements."

Status
rlsheffi Completed 5/26/2006 7:00:19 PM

Sequence number: 4
Author: ENDL[RWeber]
Date: 2/24/2006 1:44:29 PM

T The Clause 11 described in this list appears to be absent. Recommend removing the Clause 11 entry and renumbering the entries that follow it.

Resolution: See comment by K. Marks [DELL]

Status
rlsheffi Completed 5/28/2006 10:45:48 AM

Sequence number: 5
Author: ENDL[RWeber]
Date: 2/14/2006 7:30:47 PM

T There is no Appendix A in this working draft. Recommend removing Appendix A from this list.

Status
rlsheffi Completed 5/28/2006 10:46:19 AM



American National Standard for Information Systems - Information Technology - SCSI / ATA Translation

2 Scope

The set of SCSI standards specifies the interfaces, functions, and operations necessary to ensure interoperability between conforming SCSI implementations. This standard is a functional description. Conforming implementations may employ any design technique that does not violate interoperability.

This standard defines the protocol requirements of the SCSI / ATA Translation Layer (SATL) to allow conforming SCSI / ATA translating elements to interoperate with ~~various~~ ATA devices and ~~various~~ SCSI application layers. The SATL covers the range of implementations that use ATA ~~class~~ devices to emulate the behavior of SCSI devices as viewed by the SCSI application layer. The primary focus of this standard is to define SCSI / ATA translation for an ATA device (see 3.1.4).

Where possible, this standard defines SCSI / ATA translation in a manner that is consistent with SAM-3, SPC-3, and SBC-2 standards. In some instances, the defined function of an ~~attached~~ ATA device is ~~fundamentally~~ different from corresponding functions defined for SCSI target devices (e.g., ATA/ATAPI-7 provides no explicit method to disable an ATA device's read cache). The translation defined in this standard, in such cases, may not be ~~entirely~~ consistent with other SCSI standards. However, in such cases, this standard specifies the expected behavior, and in what manner it is inconsistent with the behavior specified in other SCSI standards.

The objectives of the SATL are:

- a) to provide host computers with device independence with respect to the ~~ATA/ATAPI devices that have storage capacity,~~ and with respect to various implementations of the translation layer ~~used to emulate the behavior of SCSI devices;~~
- b) to define common elements representing a subset of the capabilities ~~normally~~ available in SCSI devices that apply to SCSI / ATA Translation implementations;
- c) to define common methods to manage aspects of ~~ATA/ATAPI~~ devices that do not map ~~directly~~ to previously defined elements of SCSI, with provision made for the addition of special features and functions; and
- d) ~~to provide consistent means for discovery and control of optional SCSI features that may or may not be emulated in SCSI/ATA translator implementations by specifying handling of specific transport elements as required to represent a mixed-domain topology in a manner consistent with management of devices in a SCSI domain.~~

Figure 1 shows the general structure of SCSI standards. Figure 1 is not intended to imply a relationship such as a hierarchy, protocol stack, or system architecture.

Page: 21

Sequence number: 1
Author: IBM[GPenokie]
Subject: Note
Date: 2/28/2006 11:56:26 AM
 Ignore (it's for perl script)

1

Status
risheffi Cancelled 3/2/2006 7:56:34 PM

Sequence number: 2
Author: IBM[GPenokie]
Subject: Underline
Date: 3/7/2006 6:52:37 AM
 1 Scope

Status
risheffi Cancelled 3/9/2006 1:32:05 PM

Sequence number: 3
Author: MXO[MEvans]
Subject: Cross-Out
Date: 2/6/2006 12:36:11 PM
 Scope, paragraph 2: delete "various" twice.

Status
risheffi Completed 5/28/2006 10:47:45 AM

Sequence number: 4
Author: MXO[MEvans]
Subject: Cross-Out
Date: 2/6/2006 12:36:00 PM
 Scope, paragraph 2: delete "various" twice.

Status
risheffi Completed 5/28/2006 10:48:01 AM

Sequence number: 5
Author: MXO[MEvans]
Subject: Cross-Out
Date: 2/6/2006 12:36:19 PM
 Scope, paragraph 2: delete "-class".

Status
risheffi Completed 5/28/2006 10:48:34 AM

Sequence number: 6
Author: HPQ[RElliott]
Subject: Highlight
Date: 2/28/2006 11:36:22 AM
 "constituent" or just delete?

1

(global)

"attached ATA device" is not a good phrase, since in SAS attached means directly attached. The SAT in a SAS HBA, however, can be many expanders away from the ATA device.

Change "attached" globally to something like "mapped" or "translated"

Resolution: Replace "attached" with "constituent" (since the ATA device is one element used in the emulation of a SCSI target device), or just delete the word "attached" everywhere.

RESOLUTION: Delete the word "attached" from "attached ATA device", per Feb 28 WG.

Status
risheffi Completed 5/28/2006 10:49:52 AM

Sequence number: 7
Author: MXO[MEvans]
Subject: Cross-Out

Comments from page 21 continued on next page



American National Standard for Information Systems - Information Technology - SCSI / ATA Translation

1 Scope

The set of SCSI standards specifies the interfaces, functions, and operations necessary to ensure interoperability between conforming SCSI implementations. This standard is a functional description. Conforming implementations may employ any design technique that does not violate interoperability.

This standard defines the protocol requirements of the SCSI / ATA Translation Layer (SATL) to allow conforming SCSI / ATA translating elements to interoperate with ~~various~~ ATA devices and ~~various~~ SCSI application layers. The SATL covers the range of implementations that use ~~ATA-class~~ devices to emulate the behavior of SCSI devices as viewed by the SCSI application layer. The primary focus of this standard is to define SCSI / ATA translation for an ATA device (see 3.1.4).

Where possible, this standard defines SCSI / ATA translation in a manner that is consistent with SAM-3, SPC-3, and SBC-2 standards. In some instances, the defined function of an **attached ATA device is fundamentally different from corresponding functions defined for SCSI target devices (e.g., ⁸ATA/ATAPI-7 provides no explicit method to disable an ATA device's read cache)**. The translation defined in this standard, in such cases, may not be ¹⁰~~fully~~ consistent with other SCSI standards. However, in such cases, this standard specifies the expected behavior, and in what manner it is inconsistent with the behavior specified in other SCSI standards.

The objectives of the SATL are:

- a) to provide host computers with device independence with respect to the ¹¹ATA/ATAPI devices that have storage capacity, and with respect to various implementations of the translation layer ¹²ed to emulate the behavior of SCSI devices;
- b) to define common elements representing a subset of the capabilities ¹³~~normally~~ available in SCSI devices that apply to SCSI / ATA Translation implementations;
- c) to define common methods to manage aspects of **ATA/ATAPI** devices that do not map ~~directly~~ to previously defined elements of SCSI, with provision made for the addition of special features and functions; and
- d) **to provide consistent means for discovery and control of optional SCSI features that may or may not be emulated in SCSI/ATA translator implementations by specifying handling of specific transport elements as required to represent a mixed-domain topology in a manner consistent with management of devices in a SCSI domain.**

Figure 1 shows the general structure of SCSI standards. Figure 1 is not intended to imply a relationship such as a hierarchy, protocol stack, or system architecture.

Date: 2/6/2006 12:36:25 PM

T 1 Scope, paragraph 3: delete "fundamentally".

Status

risheffi Completed 5/28/2006 10:50:23 AM

Sequence number: 8

Author: MXO[MEvans]

Subject: Highlight

Date: 5/22/2006 10:53:55 AM

T 1 Scope, paragraph 3: change, "...provides no explicit method to disable an ATA device's read cache...", to, "...provides no deterministic method to disable an ATA device's read cache...", because a very explicit method is provided. It's just that the results are indeterminate.

RESOLUTION:

"(e.g., an ATA device provides no means to abort a single ATA queued command)."

Status

risheffi Completed 5/28/2006 10:51:33 AM

Sequence number: 9

Author: STX[GHoulder]

Subject: Highlight

Date: 5/22/2006 10:53:26 AM

T PDF page 21

section 1, paragraph 3

Choose a different example for a SCSI function that is not present in ATA:

The quoted example is incorrect. There is a SET FEATURES command to do this.

"(e.g., ATA/ATAPI-7 provides no explicit method to disable an ATA device's read cache)"

RESOLUTION:

"(e.g., an ATA device provides no means to abort a single ATA queued command)."

Status

risheffi Completed 5/28/2006 10:51:41 AM

Sequence number: 10

Author: MXO[MEvans]

Subject: Cross-Out

Date: 2/13/2006 10:09:55 AM

T 1 Scope, paragraph 3: delete "entirely:."

Status

risheffi Completed 5/28/2006 10:52:23 AM

Sequence number: 11

Author: MXO[MEvans]

Subject: Highlight

Date: 5/22/2006 10:55:28 AM

T 1 Scope, list item a: change "ATA/ATAPI devices that have storage capacity" to "ATA/ATAPI devices that have user storage capacity".

RESOLUTION: change to:

"ATA devices that have user storage capacity"

Status

risheffi Completed 5/28/2006 10:53:18 AM

Sequence number: 12

Author: MXO[MEvans]

Subject: Highlight

Date: 2/14/2006 12:01:41 PM

T 1 Scope, list item a: change "used to emulate the behavior of SCSI devices" to "used to emulate the behavior of SCSI target devices".

Status

risheffi Completed 5/28/2006 10:54:13 AM

Sequence number: 13

Author: MXO[MEvans]

Subject: Cross-Out

Date: 2/14/2006 12:02:15 PM

T 1 Scope, list item b: delete "normally".

Status

risheffi Completed 5/28/2006 10:54:35 AM

Comments from page 21 continued on next page



American National Standard for Information Systems - Information Technology - SCSI / ATA Translation

1 Scope

The set of SCSI standards specifies the interfaces, functions, and operations necessary to ensure interoperability between conforming SCSI implementations. This standard is a functional description. Conforming implementations may employ any design technique that does not violate interoperability.

This standard defines the protocol requirements of the SCSI / ATA Translation Layer (SATL) to allow conforming SCSI / ATA translating elements to interoperate with ~~various~~ ATA devices and ~~various~~ SCSI application layers. The SATL covers the range of implementations that use ~~ATA-class~~ devices to emulate the behavior of SCSI devices as viewed by the SCSI application layer. The primary focus of this standard is to define SCSI / ATA translation for an ATA device (see 3.1.4).

Where possible, this standard defines SCSI / ATA translation in a manner that is consistent with SAM-3, SPC-3, and SBC-2 standards. In some instances, the defined function of an **attached ATA device** is ~~fundamentally~~ different from corresponding functions defined for SCSI target devices (e.g., **ATA/ATAPI-7 provides no explicit method to disable an ATA device's read cache**). The translation defined in this standard, in such cases, may not be ~~entirely~~ consistent with other SCSI standards. However, in such cases, this standard specifies the expected behavior, and in what manner it is inconsistent with the behavior specified in other SCSI standards.

The objectives of the SATL are:

- a) to provide host computers with device independence with respect to the **ATA/ATAPI devices that have storage capacity**, and with respect to various implementations of the translation layer **used to emulate the behavior of SCSI devices**;
- b) to define common elements representing a subset of the capabilities ~~normally~~ available in SCSI devices that apply to SCSI / ATA Translation implementations;
- c) to define common methods to manage aspects of **ATA/ATAPI** devices that do not map ~~directly~~ to previously defined elements of SCSI, with provision made for the addition of special features and functions; and
- d) **provide consistent means for discovery and control of optional SCSI features that may or may not be emulated in SCSI/ATA translator implementations by specifying handling of specific transport elements as required to represent a mixed-domain topology in a manner consistent with management of devices in a SCSI domain.**

Figure 1 shows the general structure of SCSI standards. Figure 1 is not intended to imply a relationship such as a hierarchy, protocol stack, or system architecture.

Sequence number: 14
Author: MXO[MEvans]
Subject: Cross-Out
Date: 2/14/2006 12:02:05 PM

T 1 Scope, list item c: delete "directly".

Status
risheffi Completed 5/28/2006 10:54:56 AM

Sequence number: 15
Author: EDITOR[risheffi]
Subject: Highlight
Date: 5/22/2006 10:57:29 AM

T 1 Scope, list item c:
change "ATA/ATAPI" to "ATA"

Status
risheffi Completed 5/28/2006 10:55:19 AM

Sequence number: 16
Author: MXO[MEvans]
Subject: Highlight
Date: 2/14/2006 12:14:37 PM

T 1 Scope, list item d: change to something like, "to provide consistent means for discovery and control of optional SCSI features that may or may not be emulated in SCSI/ATA translator implementations. These means are provided by specifying how transport specific elements are represented in a mixed-domain topology in a manner consistent with management of devices in a SCSI domain."

Status
risheffi Completed 5/28/2006 10:56:43 AM

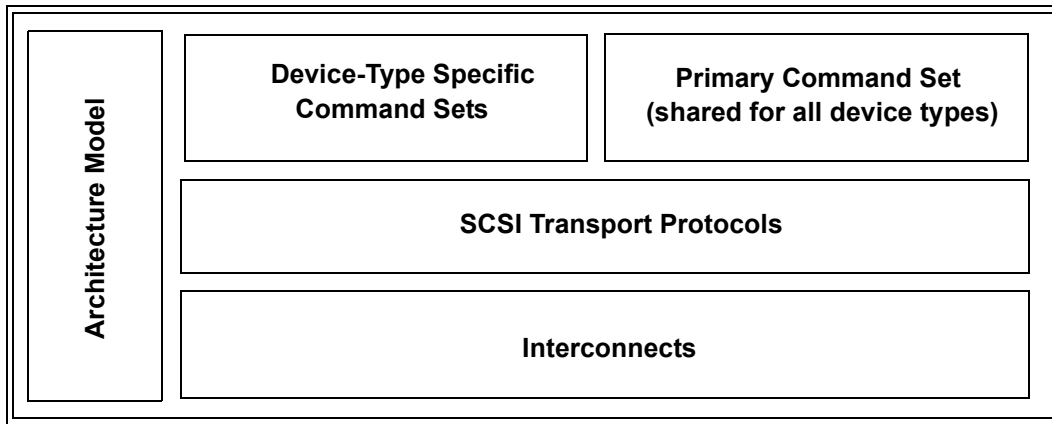

Figure 1 — SCSI document relationships

1 The term SCSI is used wherever it is not necessary to distinguish between the versions of SCSI.

Figure 2 shows the relationship of the 2 ATA/ATAPI-7 documents to each other.

3

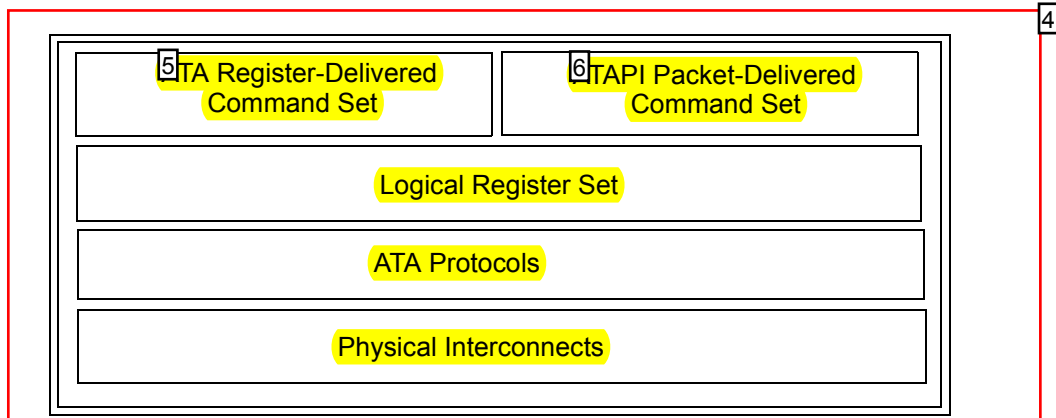

Figure 2 — ATA document structure

Figure 3 shows the relationship of this standard to standards in both the SCSI family of standards and the ATA family of standards.

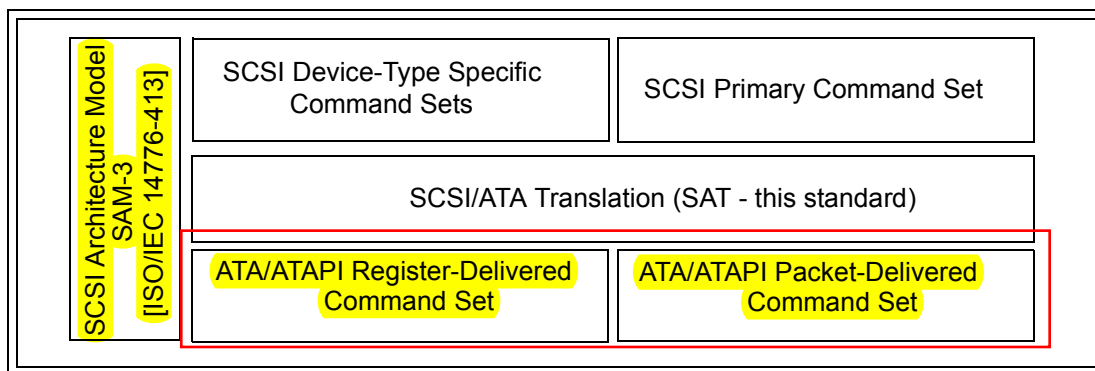

Figure 3 — SCSI/ATA translation document role

Page: 22

Sequence number: 1
Author: IBM[GPenokie]
Subject: Highlight
Date: 2/15/2006 7:29:51 AM

T first sentence after figure 1

This statement is obsolete and should be changed to something like << The term SCSI is used wherever it is not necessary to distinguish between the different SCSI standards.>>

Status
risheffi Completed 5/28/2006 10:57:57 AM

Sequence number: 2
Author: EDITOR[risheffi]
Subject: Highlight
Date: 5/28/2006 10:58:53 AM

T 1 Scope, the line just before figure-2
Change "ATA/ATAPI-7" to "ATA8".

Status
risheffi Completed 5/28/2006 10:58:59 AM

Sequence number: 3
Author: ENDL[RWeber]
Date: 2/14/2006 7:33:13 PM

T Remove the period below the words "Figure 2 shows ..." and above the actual Figure 2.

Status
risheffi Completed 5/28/2006 10:59:37 AM

Sequence number: 4
Author: EDITOR[risheffi]
Subject: Rectangle
Date: 6/24/2006 1:15:18 PM

 Figure-2 - ATA document structure

Replace this figure with one showing the ATA8 documents as follows (ignore italics):

"ATA	<i>AT Attachment-8 ATA/ATAPI Command Set (ATA8-ACS)</i>
<i>Architecture</i>	<i>AT Attachment-8 AT Attachment-8 Serial ATA</i>
<i>Model</i>	<i>Parallel Transport Serial Transport Revision 2.5</i>
<i>(i.e.,</i>	<i>(i.e., ATA8-APT) (i.e., ATA8-AST) (i.e., SAT -2.5)</i>
<i>ATA8-AAM)"</i>	

Note: The ATA8-AST box with dotted line, all others with solid line, to indicate applicability of SATA 2.5 to this standard.

After figure 2, add the text,

"ATA-8 AST and SATA 2.5 provide similar descriptions for an ATA serial transport. Requirements of this standard depend upon the ATA serial transport as defined by SATA 2.5, but not ATA8-AST."

Status
risheffi Completed 6/24/2006 1:15:23 PM

Sequence number: 5
Author: DELL[KMarks]
Subject: Highlight
Date: 1/19/2006 8:45:54 PM

T In Figure 2
change
"ATA Register-Delivered Command Set"
to
"ATA register delivered command set"

Status
risheffi Completed 6/24/2006 9:08:16 AM

Sequence number: 6

Comments from page 22 continued on next page

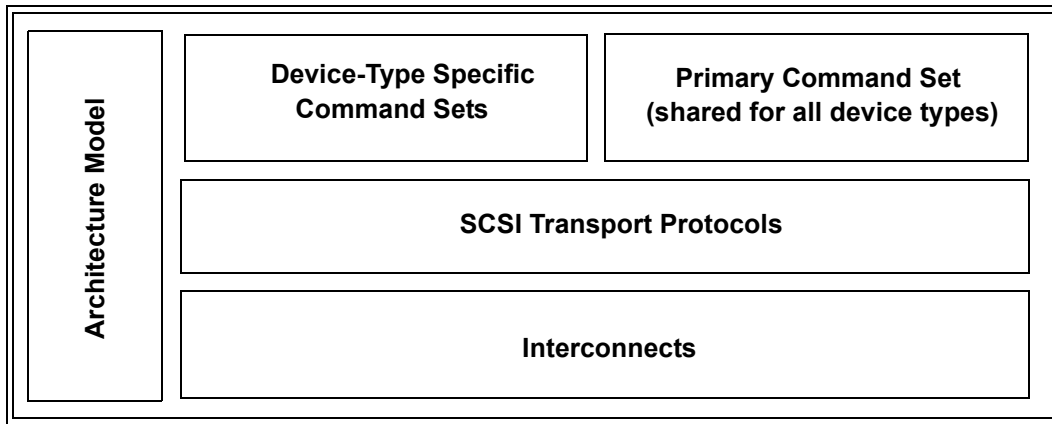

Figure 1 — SCSI document relationships

The term SCSI is used wherever it is not necessary to distinguish between the versions of SCSI.

Figure 2 shows the relationship of the ATA/ATAPI-7 documents to each other.

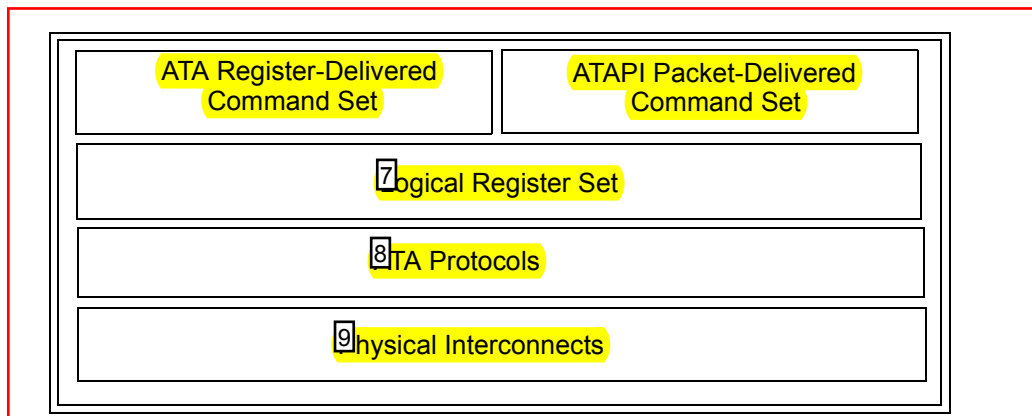

Figure 2 — ATA document structure

Figure 3 shows the relationship of this standard to standards in both the SCSI family of standards and the ATA family of standards.

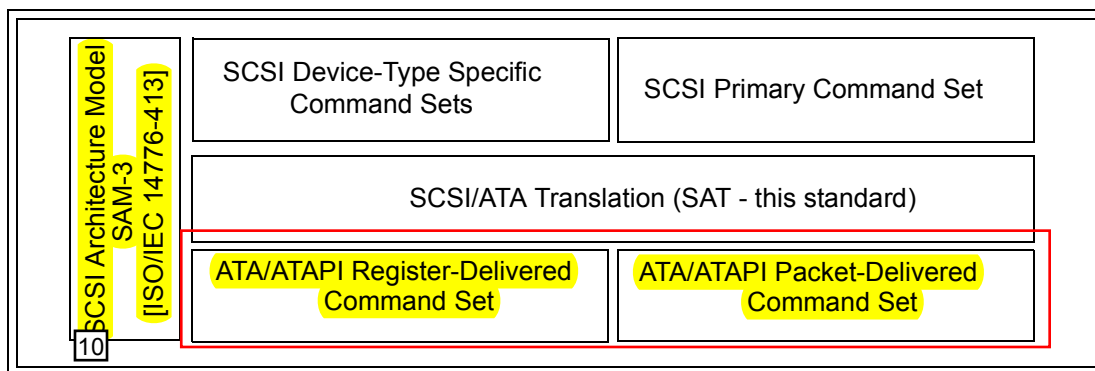

Figure 3 — SCSI/ATA translation document role

Author: DELL[KMarks]
Subject: Highlight
Date: 5/25/2006 2:36:42 PM

T In Figure 2
change
"ATAPI Packet-Delivered Command Set"
to
"ATAPI packet delivered command set"
RESOLUTION: s/b "ATAPI packet delivered command sets", for consistency with ATA8-ACS.

Status
rlsheffi Completed 6/24/2006 9:33:51 AM

Sequence number: 7
Author: DELL[KMarks]
Subject: Highlight
Date: 5/25/2006 2:38:33 PM

T This layer doesn't appear in ATA/ATAPI-7
Figure 2
change
"Logical Register Set"
to
"ATA logical register set"
RESOLUTION: Delete the box containing "Logical Register Set" as it doesn't appear in ATA8-ACS.

Status
rlsheffi Completed 5/28/2006 3:04:48 PM

Sequence number: 8
Author: DELL[KMarks]
Subject: Highlight
Date: 1/19/2006 8:42:28 PM

T Figure 2
change
"ATA Protocols"
to
"ATA Transport Protocols"

Status
rlsheffi Completed 7/23/2006 7:49:29 PM

Sequence number: 9
Author: DELL[KMarks]
Subject: Highlight
Date: 1/19/2006 8:43:40 PM

T Figure 2
change
"Physical Interconnects"
to
"ATA physical interconnects"

Status
rlsheffi Completed 7/23/2006 7:49:46 PM

Sequence number: 10
Author: DELL[KMarks]
Subject: Highlight
Date: 2/24/2006 3:57:43 PM

T In Figure 3, remove
"SAM-3
[ISO/IEC 14776-413]"

or add versions to other boxes.
RESOLUTION: Delete "SAM-3 [ISO/IEC 14776-413]"

Status
rlsheffi Completed 5/28/2006 3:10:53 PM

Comments from page 22 continued on next page

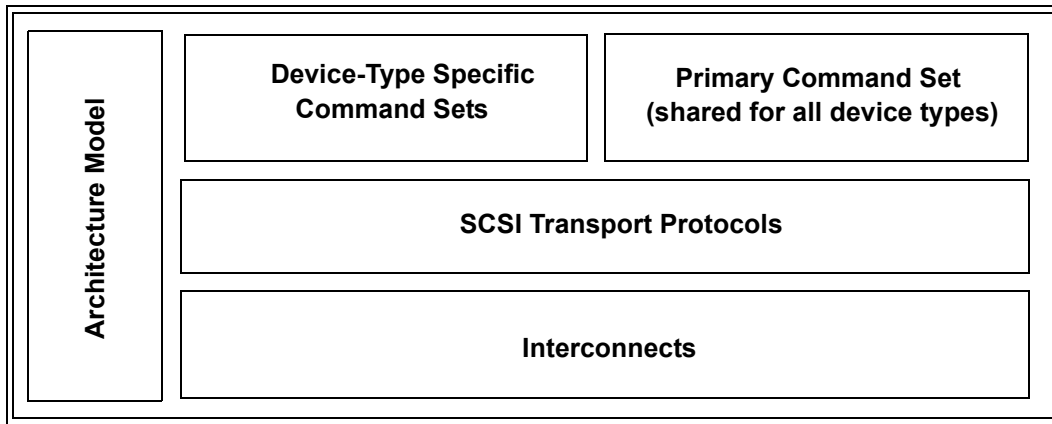

Figure 1 — SCSI document relationships

The term SCSI is used wherever it is not necessary to distinguish between the versions of SCSI.

Figure 2 shows the relationship of the ATA/ATAPI-7 documents to each other.

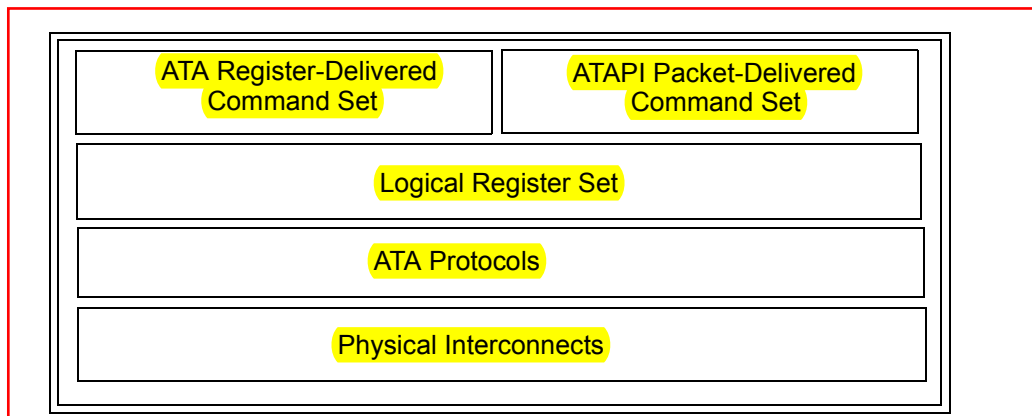

Figure 2 — ATA document structure

Figure 3 shows the relationship of this standard to standards in both the SCSI family of standards and the ATA family of standards.

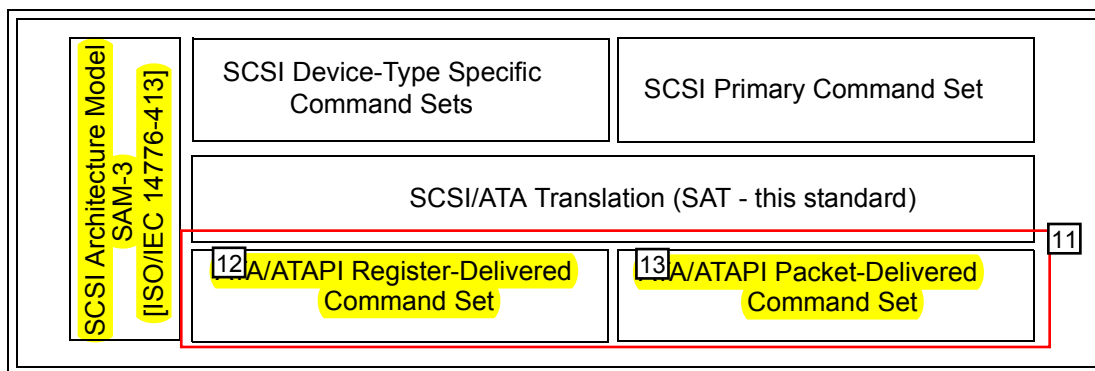



Figure 3 — SCSI/ATA translation document role

Sequence number: 11
Author: EDITOR[risheffi]
Subject: Rectangle
Date: 5/22/2006 11:18:46 AM

 Figure-3, bottom two boxes:

Replace the two boxes showing the ATA/ATAPI register/packet command sets with a single box containing:
"AT Attachment - 8 ATA/ATAPI Command Set (i.e., ATA8-ACS)"

Status
risheffi Completed 5/28/2006 3:13:21 PM

Sequence number: 12
Author: DELL[KMarks]
Subject: Highlight
Date: 5/23/2006 5:13:50 PM

 In Figure 3

change

"ATA/ATAPI Register-Delivered Command Set"

to

"ATA/ATAPI register delivered command set"

REASON: Using ATA8 model (see EDITOR's comment)

Status
risheffi Rejected 5/23/2006 5:13:17 PM

Sequence number: 13
Author: DELL[KMarks]
Subject: Highlight
Date: 5/23/2006 5:14:21 PM

 In Figure 3

change

"ATA/ATAPI Packet-Delivered Command Set"

to

"ATA/ATAPI packet delivered command set"

REASON: Using ATA8 model (see EDITOR's comment)

Status
risheffi Rejected 5/23/2006 5:14:25 PM



Page: 23

Sequence number: 1
Author: ENDL[RWeber]
Date: 2/14/2006 7:34:12 PM
 Remove this blank page

Status
risheffi Completed 5/28/2006 3:14:41 PM

Sequence number: 2
Author: HPQ[RElliott]
Subject: Note
Date: 1/19/2006 9:49:35 AM
 Printed Page 3
Delete blank page before chapter 2

Status
risheffi Completed 5/28/2006 3:14:41 PM

Sequence number: 3
Author: MXO[MEvans]
Subject: Note
Date: 2/14/2006 12:20:03 PM
 1 Scope, after figure 3: delete the blank page in the pdf (i.e., page 23).

Status
risheffi Completed 5/28/2006 3:14:41 PM

Sequence number: 4
Author: IBM[GPenokie]
Subject: Note
Date: 2/15/2006 7:31:30 AM
 This blank page should be removed. This can be accomplished by proper setup of the frame book file.

Status
risheffi Completed 5/28/2006 3:14:41 PM

Sequence number: 5
Author: DELL[KMarks]
Subject: Note
Date: 1/19/2006 8:52:47 PM
 Remove blank page after Figure 3.

page 3.

Status
risheffi Completed 5/28/2006 3:14:41 PM

1 Normative References

Editor's Note 1: This list shall be updated as required.

2.1 Normative references

The following standards contain provisions that, by reference in the text, constitute provisions of this standard. At the time of publication, the editions indicated were valid. All standards are subject to revision, and parties to agreements based on this standard are encouraged to investigate the possibility of applying the most recent editions of the standards listed below.

Copies of the following documents may be obtained from ANSI: approved ANSI standards, approved and draft international and regional standards (ISO, IEC, CEN/CENELEC, ITUT), and approved and draft foreign standards (including BSI, JIS, and DIN). For further information, contact ANSI Customer Service Department at 212-642-4900 (phone), 212-302-1286 (fax) or via the World Wide Web at <http://www.ansi.org>.

Additional availability contact information is provided below as needed.

2.2 Approved references

- ~~ISO/IEC 14776-971, AT Attachment - 7 with Packet Interface (ATA/ATAPI-7) [ANSI INCITS 397-2005]~~
- ISO/IEC 14776-413, *SCSI Architecture Model - 3 (SAM-3)* [ANSI INCITS 402-2005]
- ISO/IEC 14776-412, *SCSI Architecture Model - 2 (SAM-2)* [ANSI INCITS 366-2003]
- ISO/IEC 14776-453, *SCSI Primary Commands - 3 (SPC-3)* [T10/1416-D]
- ISO/IEC 14776-322, *SCSI Block Commands - 2 (SBC-2)* [ANSI INCITS 405-2005]
- ISO/IEC 14776-151, *Serial Attached SCSI - 1.1 (SAS-1.1)* [T10/1601-D]

2.3 References under development

At the time of publication, the following referenced standards were still under development. For information on the current status of the document, or regarding availability, contact the relevant standards body or other organization as indicated.

- ~~ISO/IEC 14776-152, Serial Attached SCSI - 2 (SAS-2) [T10/1760-D]~~
- ISO/IEC 14776-xxx, ~~Attachment-8 Serial Transport (ATA8-AST)~~ [T13/1697D]
- ISO/IEC 14776-861, *AT Attachment-8 Architecture Model (ATA8-AAM)* [T13/1700D]
- ISO/IEC 14776-871, *AT Attachment-8 ATA/ATAPI Command Set (ATA8-ACS)* [T13/1699D]
- ISO/IEC 14776-881, *AT Attachment-8 Parallel Transport (ATA8-APT)* [T13/1698D]
- ISO/IEC 14776-xxx, *Smart Command Transfer (SCT)* [T13/1701DT]
- ~~ISO/IEC 14776-414, SCSI Architecture Model - 4 (SAM-4) [T10/1683-D]~~



NOTE 1 For more information on the current status of the document, contact the INCITS Secretariat at 202-737-8888 (phone), 202-638-4922 (fax) or via E-mail at incits@itic.org. To obtain copies of this document, contact Global Engineering at 15 Inverness Way, East Englewood, CO 80112-5704 at 303-792-2181 (phone), 800-854-7179 (phone), or 303-792-2192 (fax).

2.4 Other references

For information on the current status of the listed document(s), or regarding availability, contact the indicated organization.

Serial ATA Revision 2.5 (SATA-2.5)



Sequence number: 1
Author: IBM[GPenokie]
Subject: Underline
Date: 2/24/2006 4:08:45 PM
 2 Normative References
 REASON: Nothing to change

Status
risheffi Cancelled 3/2/2006 8:13:45 PM

Sequence number: 2
Author: IBM[GPenokie]
Subject: Cross-Out
Date: 2/15/2006 7:32:14 AM
 This editors note needs to be removed.

Status
risheffi Completed 5/28/2006 3:16:02 PM

Sequence number: 3
Author: LSI[JLohmeyer]
Subject: Cross-Out
Date: 2/15/2006 2:48:29 PM
 2 Normative References

Delete "Editor's Note 1: This list shall be updated as required."

Status
risheffi Completed 5/28/2006 3:16:02 PM

Sequence number: 4
Author: ENDL[RWeber]
Date: 2/14/2006 7:34:44 PM
 Remove editor's note 1.

Status
risheffi Completed 5/28/2006 3:16:02 PM

Sequence number: 5
Author: DELL[KMarks]
Subject: Note
Date: 1/19/2006 8:54:12 PM
 Section 2

Remove editor's note 1 prior to forwarding to INCITS

Status
risheffi Completed 5/28/2006 3:16:01 PM

Sequence number: 6
Author: EDITOR[risheffi]
Subject: Cross-Out
Date: 7/12/2006 3:30:33 PM
 Remove as all ATA/ATAPI-7 references are being replaced with ATA8 references (per first LB comment).

REASON: Emulation of the START STOP UNIT eject function requires reference to the Removable Media feature set, which is defined in ATA/ATAPI-7 and not defined in ATA8.

Status
risheffi Rejected 7/12/2006 3:26:10 PM

Sequence number: 7
Author: DELL[KMarks]
Subject: Highlight
Date: 7/12/2006 4:00:36 PM
 **2.2 Approved references**
change

"ISO/IEC 14776-971, AT Attachment - 7 with Packet Interface (ATA/ATAPI-7) [ANSI INCITS 397-2005]"
to
"ISO/IEC 14776-971, AT Attachment with Packet Interface - 7 (ATA/ATAPI-7) [ANSI INCITS 397-2005]"

2 Normative References

 Editor's Note 1: This list shall be updated as required.

2.1 Normative references

The following standards contain provisions that, by reference in the text, constitute provisions of this standard. At the time of publication, the editions indicated were valid. All standards are subject to revision, and parties to agreements based on this standard are encouraged to investigate the possibility of applying the most recent editions of the standards listed below.

Copies of the following documents may be obtained from ANSI: approved ANSI standards, approved and draft international and regional standards (ISO, IEC, CEN/CENELEC, ITUT), and approved and draft foreign standards (including BSI, JIS, and DIN). For further information, contact ANSI Customer Service Department at 212-642-4900 (phone), 212-302-1286 (fax) or via the World Wide Web at <http://www.ansi.org>.



Additional availability contact information is provided below as needed.

2.2 Approved references

~~ISO/IEC 14776-971, AT Attachment - 7 with Packet Interface (ATA/ATAPI-7) [ANSI INCITS 397-2005]~~
 ISO/IEC 14776-413, *SCSI Architecture Model - 3 (SAM-3)* [ANSI INCITS 402-2005]
 ISO/IEC 14776-412, *SCSI Architecture Model - 2 (SAM-2)* [ANSI INCITS 366-2003]
 ISO/IEC 14776-453, *SCSI Primary Commands - 3 (SPC-3)* [T10/1416-D]
 ISO/IEC 14776-322, *SCSI Block Commands - 2 (SBC-2)* [ANSI INCITS 405-2005]
 ISO/IEC 14776-151, *Serial Attached SCSI - 1.1 (SAS-1.1)*  [10/1601-D]

2.3 References under development



At the time of publication, the following referenced standards were still under development. For information on the current status of the document, or regarding availability, contact the relevant standards body or other organization as indicated.

~~ISO/IEC 14776-152, Serial Attached SCSI - 2 (SAS-2) [T10/1760-D]~~
 ~~ISO/IEC 14776-xxx, Attachment-8 Serial Transport (ATA8-AST) [T13/1697D]~~
 ISO/IEC 14776-861, *AT Attachment-8 Architecture Model (ATA8-AAM)* [T13/1700D]
 ISO/IEC 14776-871, *AT Attachment-8 ATA/ATAPI Command Set (ATA8-ACS)* [T13/1699D]
 ISO/IEC 14776-881, *AT Attachment-8 Parallel Transport (ATA8-APT)* [T13/1698D]
 ~~ISO/IEC 14776-xxx, Smart Command Transfer (SCT) [T13/1701DT]~~
~~ISO/IEC 14776-414, SCSI Architecture Model - 4 (SAM-4) [T10/1683-D]~~

NOTE 1 For more information on the current status of the document, contact the INCITS Secretariat at 202-737-8888 (phone), 202-638-4922 (fax) or via E-mail at incits@itic.org. To obtain copies of this document, contact Global Engineering at 15 Inverness Way, East Englewood, CO 80112-5704 at 303-792-2181 (phone), 800-854-7179 (phone), or 303-792-2192 (fax).

2.4 Other references

For information on the current status of the listed document(s), or regarding availability, contact the indicated organization.

 **Serial ATA Revision 2.5 (SATA-2.5)**



Status
risheffi Completed 5/28/2006 3:18:19 PM

Sequence number: 8
Author: LSI[JLohmeyer]
Subject: Highlight
Date: 2/15/2006 2:49:42 PM
 2.2 Approved references

Replace "[T10/1601-D]" with "[ANSI INCITS 417-2006]"

Status
risheffi Completed 5/28/2006 3:19:03 PM

Sequence number: 9
Author: MXO[MEvans]
Subject: Cross-Out
Date: 2/6/2006 1:58:54 PM
 2.3 References under development: delete "ISO/IEC 14776-152, Serial Attached SCSI - 2 (SAS-2) [T10/1760-D]" as there is no other reference to this document in this standard.

Status
risheffi Completed 5/28/2006 3:19:34 PM

Sequence number: 10
Author: HPQ[RElliott]
Subject: Cross-Out
Date: 2/28/2006 1:02:11 PM
 Delete "ISO/IEC 14776-xxx, AT Attachment-8 Serial Transport (ATA8-AST) [T13/1697D]"

SATA 2.5 is the proper reference for anything related to SATA.
RESOLUTION: For the purposes of SAT, SATA 2.5 supercedes ATA8-AST, so delete this reference.

Status
risheffi Completed 5/29/2006 8:49:59 AM

Sequence number: 11
Author: STX[GHolder]
Subject: Highlight
Date: 2/28/2006 1:03:52 PM
 PDF page 24
section 2.3

Provide the correct ISO document number for
ISO/IEC 14776-xxx, AT Attachment-8 Serial Transport
REASON: Accepted HP comment to delete reference (use SATA 2.5 instead).

Status
risheffi Rejected 5/22/2006 11:20:59 AM

Sequence number: 12
Author: DELL[KMarks]
Subject: Note
Date: 2/27/2006 4:37:48 PM
 **2.3 References under development**

add SPC-4 for ASC/ASCQ defined in ATA PASS-THROUGH Commands
RESOLUTION: add the following to referenced under development:
ISO/IEC 14776-454, SCSI Primary Commands - 4 (SPC-4) [T10/1731-D]

Status
risheffi Completed 5/29/2006 8:51:40 AM

Sequence number: 13
Author: STX[GHolder]
Subject: Highlight
Date: 2/27/2006 5:09:48 PM
 PDF page 24
section 2.3
ISO/IEC 14776-xxx, Smart Command Transfer (SCT) [T13/1701DT]
Correct the document title
should be: SMART Command Transport

Comments from page 24 continued on next page

2 Normative References

 Editor's Note 1: This list shall be updated as required.

2.1 Normative references

The following standards contain provisions that, by reference in the text, constitute provisions of this standard. At the time of publication, the editions indicated were valid. All standards are subject to revision, and parties to agreements based on this standard are encouraged to investigate the possibility of applying the most recent editions of the standards listed below.

Copies of the following documents may be obtained from ANSI: approved ANSI standards, approved and draft international and regional standards (ISO, IEC, CEN/CENELEC, ITUT), and approved and draft foreign standards (including BSI, JIS, and DIN). For further information, contact ANSI Customer Service Department at 212-642-4900 (phone), 212-302-1286 (fax) or via the World Wide Web at <http://www.ansi.org>.

Additional availability contact information is provided below as needed.

2.2 Approved references

~~ISO/IEC 14776-971, AT Attachment - 7 with Packet Interface (ATA/ATAPI-7) [ANSI INCITS 397-2005]~~

ISO/IEC 14776-413, *SCSI Architecture Model - 3 (SAM-3)* [ANSI INCITS 402-2005]

ISO/IEC 14776-412, *SCSI Architecture Model - 2 (SAM-2)* [ANSI INCITS 366-2003]

ISO/IEC 14776-453, *SCSI Primary Commands - 3 (SPC-3)* [T10/1416-D]

ISO/IEC 14776-322, *SCSI Block Commands - 2 (SBC-2)* [ANSI INCITS 405-2005]

ISO/IEC 14776-151, *Serial Attached SCSI - 1.1 (SAS-1.1)* [T10/1601-D]

2.3 References under development

At the time of publication, the following referenced standards were still under development. For information on the current status of the document, or regarding availability, contact the relevant standards body or other organization as indicated.

~~ISO/IEC 14776-152, Serial Attached SCSI - 2 (SAS-2) [T10/1760-D]~~

~~ISO/IEC 14776-xxx, Attachment-8 Serial Transport (ATA8-AST) [T13/1697D]~~

ISO/IEC 14776-861, *AT Attachment-8 Architecture Model (ATA8-AAM)* [T13/1700D]

ISO/IEC 14776-871, *AT Attachment-8 ATA/ATAPI Command Set (ATA8-ACS)* [T13/1699D]

ISO/IEC 14776-881, *AT Attachment-8 Parallel Transport (ATA8-APT)* [T13/1698D]

¹⁴ ISO/IEC 14776-xxx, *Smart Command Transfer (SCT)* [T13/1701DT]

~~¹⁵ ISO/IEC 14776-414, SCSI Architecture Model - 4 (SAM-4) [T10/1683-D]~~

¹⁶ **TE 1 For more information** on the current status of the document, contact the INCITS Secretariat at 202-737-8888 (phone), 202-638-4922 (fax) or via E-mail at incits@itic.org. To obtain copies of this document, contact Global Engineering at 15 Inverness Way, East Englewood, CO 80112-5704 at 303-792-2181 (phone), 800-854-7179 (phone), or 303-792-2192 (fax).

2.4 Other references

For information on the current status of the listed document(s), or regarding availability, contact the indicated organization.

¹⁷ ~~Serial ATA Revision 2.5 (SATA-2.5)~~



Status
rlsheffi Completed 5/29/2006 8:52:35 AM

Sequence number: 14
Author: STX[GHolder]
Subject: Highlight
Date: 3/7/2006 7:28:07 AM

T PDF page 24
section 2.3

Provide the correct document number for
ISO/IEC 14776-xxx, Smart Command Transfer (SCT) [T13/1701DT]
RESOLUTION: Use ANSI INCITS number:
"ANSI INCITS TR38-2005, Smart Command Transport (SCT)".

Status
rlsheffi Completed 5/29/2006 8:55:21 AM

Sequence number: 15
Author: MXO[MEvans]
Subject: Cross-Out
Date: 5/11/2006 12:15:01 PM

T 2.3 References under development: delete "ISO/IEC 14776-414, SCSI Architecture Model - 4 (SAM-4) [T10/1683-D]" as this is only used in the Abbreviations clause.

Status
rlsheffi Completed 5/29/2006 8:55:54 AM

Sequence number: 16
Author: DELL[KMarks]
Subject: Highlight
Date: 1/30/2006 9:48:26 PM

T 2.3 References under development

Change
"NOTE 1 For more information"
to
"NOTE 1 - For more information"

Status
rlsheffi Completed 5/29/2006 8:57:01 AM

Sequence number: 17
Author: ENDL[RWeber]
Date: 3/7/2006 12:16:17 PM

 http://www.sata-io.org/docs/SerialATA_Revision_2_5_Gold.pdf
<http://www.sata-io.org/spec.asp>

_T Please provide the contact information described in the subclause introduction for the SATA-2.5 reference.
RESOLUTION: per Feb 28 SAT WG
"The SATA 2.5 document may be obtained from SATA I/O at www.sata-io.org."

Status
rlsheffi Completed 5/29/2006 8:58:14 AM

Sequence number: 18
Author: DELL[KMarks]
Subject: Highlight
Date: 2/27/2006 9:15:58 PM

T **2.4 Other references**

Serial ATA Revision 2.5 (SATA-2.5)

No organization is specified for SATA, add SATA-IO
REASON: Duplicate of ENDL comment

Status
rlsheffi Completed 5/29/2006 8:58:30 AM

Sequence number: 19
Author: STX[GHolder]
Subject: Highlight
Date: 3/4/2006 2:26:15 PM

T PDF page 24
section 2.4

Provide an 'indicated organization' for where to obtain the

Comments from page 24 continued on next page

2 Normative References

 Editor's Note 1: This list shall be updated as required.

2.1 Normative references

The following standards contain provisions that, by reference in the text, constitute provisions of this standard. At the time of publication, the editions indicated were valid. All standards are subject to revision, and parties to agreements based on this standard are encouraged to investigate the possibility of applying the most recent editions of the standards listed below.

Copies of the following documents may be obtained from ANSI: approved ANSI standards, approved and draft international and regional standards (ISO, IEC, CEN/CENELEC, ITUT), and approved and draft foreign standards (including BSI, JIS, and DIN). For further information, contact ANSI Customer Service Department at 212-642-4900 (phone), 212-302-1286 (fax) or via the World Wide Web at <http://www.ansi.org>.

Additional availability contact information is provided below as needed.

2.2 Approved references

~~ISO/IEC 14776-971, AT Attachment - 7 with Packet Interface (ATA/ATAPI-7) [ANSI INCITS 397-2005]~~

ISO/IEC 14776-413, *SCSI Architecture Model - 3 (SAM-3)* [ANSI INCITS 402-2005]

ISO/IEC 14776-412, *SCSI Architecture Model - 2 (SAM-2)* [ANSI INCITS 366-2003]

ISO/IEC 14776-453, *SCSI Primary Commands - 3 (SPC-3)* [T10/1416-D]

ISO/IEC 14776-322, *SCSI Block Commands - 2 (SBC-2)* [ANSI INCITS 405-2005]

ISO/IEC 14776-151, *Serial Attached SCSI - 1.1 (SAS-1.1)* [T10/1601-D]

2.3 References under development

At the time of publication, the following referenced standards were still under development. For information on the current status of the document, or regarding availability, contact the relevant standards body or other organization as indicated.

~~ISO/IEC 14776-152, Serial Attached SCSI - 2 (SAS-2) [T10/1760-D]~~

ISO/IEC 14776-xxx,  Attachment-8 Serial Transport (ATA8-AST) [T13/1697D]

ISO/IEC 14776-861, *AT Attachment-8 Architecture Model (ATA8-AAM)* [T13/1700D]

ISO/IEC 14776-871, *AT Attachment-8 ATA/ATAPI Command Set (ATA8-ACS)* [T13/1699D]

ISO/IEC 14776-881, *AT Attachment-8 Parallel Transport (ATA8-APT)* [T13/1698D]

ISO/IEC 14776-xxx, *Smart Command Transfer (SCT)* [T13/1701DT]

~~ISO/IEC 14776-414, SCSI Architecture Model - 4 (SAM-4) [T10/1683-D]~~

NOTE 1 For more information on the current status of the document, contact the INCITS Secretariat at 202-737-8888 (phone), 202-638-4922 (fax) or via E-mail at incits@itic.org. To obtain copies of this document, contact Global Engineering at 15 Inverness Way, East Englewood, CO 80112-5704 at 303-792-2181 (phone), 800-854-7179 (phone), or 303-792-2192 (fax).

2.4 Other references

For information on the current status of the listed document(s), or regarding availability, contact the indicated organization.

 **Serial ATA Revision 2.5 (SATA-2.5)**

 21 20

 22

RESOLUTION: See ENDL comment

Status
rlsheffi Completed 5/29/2006 8:58:44 AM

Sequence number: 20
Author: HPQ[RElliott]
Subject: Note
Date: 3/4/2006 2:25:43 PM

 2.4
Add contact information for SATA-IO
RESOLUTION: See ENDL comment

Status
rlsheffi Completed 5/29/2006 8:58:56 AM

Sequence number: 21
Author: MXO[MEvans]
Subject: Note
Date: 3/4/2006 2:25:17 PM

 2.4 Other references: add the contact information for SATA 2.5.
RESOLUTION: See ENDL comment

Status
rlsheffi Completed 5/29/2006 8:59:13 AM

Sequence number: 22
Author: INTC[RSheffield]
Subject: Note
Date: 3/7/2006 7:31:53 AM

 Add the T10 Editor's Style Guide:
"T10 Editor's Style Guide, available on the T10 website at <http://www.t10.org/ftp/t10/document.05/05-085r9.pdf/>
REASON: Bad idea.

Status
rlsheffi Rejected 3/7/2006 7:31:24 AM

3 Definitions, symbols, abbreviations, and conventions

3.1 Definitions

3.1.1 additional sense code: A combination of the ADDITIONAL SENSE CODE and ADDITIONAL SENSE CODE QUALIFIER fields in the sense data. Detailed definition of sense data may be found in SPC-3.

3.1.2 application client: An object that is the source of SCSI commands. Further definition of an application client is found in SAM-3.

~~**3.1.3 AT Attachment (ATA):** A standard for the attachment of storage devices to hosts. See ATA/ATAPI-7 V1.~~

3.1.4 ATA device: A device implementing the general feature set, and does not implement the packet feature set, as described in ATA/ATAPI-7 (see 2.2).

~~**3.1.5 ATA/ATAPI device:** ATA/ATAPI-7 device (see 3.1.6).~~

~~**3.1.6 ATA/ATAPI-7 device:** A device that complies with ATA/ATAPI-7.~~

3.1.7 ATA domain: An I/O system consisting of an ATA hosts and ATA/ATAPI devices that communicate with one another by means of a service delivery subsystem.

3.1.8 ATA flush command: A FLUSH CACHE or FLUSH CACHE EXT command defined in ATA/ATAPI-7.

3.1.9 ATA hard reset: For a SATA device, an action in response to a reset event (COMRESET or power-on reset) in which the SATA Phy state machine transitions to the initial state (see ATA8-AST). For a PATA device, assertion of the RESET- signal (Hardware reset) by an ATA host to reset the attached ATA device (See ATA8-APT).

3.1.10 ATA host: A host device that originates requests to be processed by an ATA/ATAPI device.

3.1.11 ATA LBA: If the attached ATA device is a PATA device, this is the set of registers comprised of the LBA High, LBA Mid, and LBA Low registers (i.e., inclusive of both previous and current instances of those registers when 48-bit addressing is used) in the ATA Command Block registers. If the attached ATA device is a SATA device, this is the set of fields in the SATA Command FIS comprised if the LBA Low, LBA Mid, LBA High, LBA Low (ext), LBA Mid (ext), and LBA High (ext) fields (see ATA/ATAPI-7).

3.1.12 AT Attachment Packet Interface (ATAPI): An element of the ATA specification that defines a Packet Command feature set that provides the capability to pass-through SCSI-type commands encapsulated through an ATA transport.

3.1.13 ATAPI device: A device implementing the packet feature set as described in ATA/ATAPI-7.

3.1.14 ATA queued commands: Queued read and write commands issued to an ATA device (see 3.1.4) that supports the Overlapped feature set of ATA/ATAPI-7 or the native command queuing (see 3.1.45) feature of SATA 2.5 (see 3.1.59).

3.1.15 ATA read command: One of the following ATA commands: READ DMA, READ DMA EXT, READ DMA QUEUED, READ DMA QUEUED EXT, READ MULTIPLE, READ MULTIPLE EXT, READ SECTOR(S), or READ SECTOR(S) EXT defined in ATA/ATAPI-7; or READ FPDMA QUEUED defined in SATA 2.5.

3.1.16 ATA Sector Count: If the attached ATA device is a PATA device this is the Sector Count register (i.e., inclusive of both previous and current instances of the register when 48-bit addressing is used). If the attached device is a SATA device this is the Sector Count and Sector Count (ext) fields in a SATA Command FIS.

Page: 25

Sequence number: 1
Author: EDITOR[risheffi]
Subject: Inserted Text
Date: 4/24/2006 11:06:41 AM

T field

Status
risheffi Completed 5/29/2006 8:59:49 AM

Sequence number: 2
Author: EDITOR[risheffi]
Subject: Inserted Text
Date: 4/24/2006 11:05:08 AM

T field

Status
risheffi Completed 5/29/2006 9:00:31 AM

Sequence number: 3
Author: EDITOR[risheffi]
Subject: Inserted Text
Date: 4/24/2006 11:05:20 AM

T the

Status
risheffi Completed 5/29/2006 9:01:54 AM

Sequence number: 4
Author: EDITOR[risheffi]
Subject: Inserted Text
Date: 4/24/2006 11:05:16 AM

T the

Status
risheffi Completed 5/29/2006 9:01:15 AM

Sequence number: 5
Author: SIERLGC[BMartin]
Subject: Highlight
Date: 2/28/2006 1:53:44 PM

T Page 5, 3.1.1

change last sentence to "SPC-3 contains a detailed definition of sense data."

RESOLUTION: global - change all these sorts of references to (see xxx) format. Do a global search on "may be found" "provides", and "contains".

This one becomes "...in the sense data (see SPC-3)."

Status
risheffi Completed 5/29/2006 9:12:27 AM

Sequence number: 6
Author: MXO[MEvans]
Subject: Highlight
Date: 3/9/2006 1:38:52 PM

T 3.1.1 additional sense code: change the definition to, "a combination of the ADDITIONAL SENSE CODE and ADDITIONAL SENSE CODE QUALIFIER fields in the sense data (see SPC-3).

REASON: Accepted a variant of the revised definition proposed by Bill Martin of Sierra Logic.

Status
risheffi Completed 5/29/2006 9:05:48 AM

Sequence number: 7
Author: EDITOR[risheffi]
Subject: Highlight
Date: 4/24/2006 11:05:24 AM

T fields

s/b
field

Status
risheffi Completed 5/29/2006 9:02:16 AM

Comments from page 25 continued on next page

3 Definitions, symbols, abbreviations, and conventions

3.1 Definitions

3.1.1 additional sense code: A combination of the ADDITIONAL SENSE CODE and ADDITIONAL SENSE CODE QUALIFIER fields in the sense data. A detailed definition of sense data may be found in SPC-3.

3.1.2 application client: An object that is the source of SCSI commands. Further definition of an application client is found in SAM-3.

~~**3.1.3 AT Attachment (ATA):** A standard for the attachment of storage devices to hosts. See ATA/ATAPI-7~~

3.1.4 ATA device: A device implementing the general feature set, and does not implement the packet feature set, as described in ATA/ATAPI-7 (see 2.2).

~~**3.1.5 ATA/ATAPI device:** ATA/ATAPI-7 device (see 3.1.6).~~

~~**3.1.6 ATA/ATAPI-7 device:** A device that complies with ATA/ATAPI-7.~~

3.1.7 ATA domain: An I/O system consisting of an ATA hosts and ATA/ATAPI devices that communicate with one another by means of a service delivery subsystem.

3.1.8 ATA flush command: A FLUSH CACHE or FLUSH CACHE EXT command defined in ATA/ATAPI-7.

3.1.9 ATA hard reset: For a SATA device, an action in response to a reset event (COMRESET or power-on reset) in which the SATA Phy state machine transitions to the initial state (see ATA8-AST). For a PATA device, assertion of the RESET- signal (Hardware reset) by an ATA host to reset the attached ATA device (See ATA8-APT).

3.1.10 ATA host: A host device that originates requests to be processed by an ATA/ATAPI device.

3.1.11 ATA LBA: If the attached ATA device is a PATA device, this is the set of registers comprised of the LBA High, LBA Mid, and LBA Low registers (i.e., inclusive of both previous and current instances of those registers when 48-bit addressing is used) in the ATA Command Block registers. If the attached ATA device is a SATA device, this is the set of fields in the SATA Command FIS comprised if the LBA Low, LBA Mid, LBA High, LBA Low (ext), LBA Mid (ext), and LBA High (ext) fields (see ATA/ATAPI-7).

3.1.12 AT Attachment Packet Interface (ATAPI): An element of the ATA specification that defines a Packet Command feature set that provides the capability to pass-through SCSI-type commands encapsulated through an ATA transport.

~~**3.1.13 ATAPI device:** A device implementing the packet feature set as described in ATA/ATAPI-7.~~

3.1.14 ATA queued commands: Queued read and write commands issued to an ATA device (see 3.1.4) that supports the Overlapped feature set of ATA/ATAPI-7 or the native command queuing (see 3.1.45) feature of SATA 2.5 (see 3.1.59).

3.1.15 ATA read command: One of the following ATA commands: READ DMA, READ DMA EXT, READ DMA QUEUED, READ DMA QUEUED EXT, READ MULTIPLE, READ MULTIPLE EXT, READ SECTOR(S), or READ SECTOR(S) EXT defined in ATA/ATAPI-7; or READ FPDMA QUEUED defined in SATA 2.5.

3.1.16 ATA Sector Count: If the attached ATA device is a PATA device this is the Sector Count register (i.e., inclusive of both previous and current instances of the register when 48-bit addressing is used). If the attached device is a SATA device this is the Sector Count and Sector Count (ext) fields in a SATA Command FIS.

Sequence number: 8
Author: DELL[KMarks]
Subject: Highlight
Date: 2/28/2006 2:16:26 PM

T Change

"3.1.2 application client: An object that is the source of SCSI commands. Further definition of an application client is found in SAM-3."

to
"3.1.2 application client: An object that is the source of SCSI commands. Further definition of an application client may be found in SAM-3."

RESOLUTION:

"3.1.2 application client: An object that is the source of SCSI commands (see SAM-3)."

Status
rlsheffi Completed 5/29/2006 9:13:36 AM

Sequence number: 9
Author: MXO[MEvans]
Subject: Highlight
Date: 2/28/2006 2:15:03 PM

T 3.1.2 application client: change the definition to, "An object that is the source of SCSI commands (see SAM-3).

Status
rlsheffi Completed 5/29/2006 9:14:02 AM

Sequence number: 10
Author: MXO[MEvans]
Subject: Cross-Out
Date: 5/29/2006 9:18:22 AM

T 3.1.3 AT Attachment (ATA): delete this definition. It is not used in the document (and, as it is, is incorrect).

T REASON:

"ATA" is used throughout the document, and this is a trace-point to determine what it means. Will correct by deleting "V1" (see ENDL comment)

RESOLUTION: Define

"A family of standards that define the attachment of storage devices to hosts (see ATA8-AAM, ATA8-ACS, ATA8-APT, and SATA 2.5)"

Status
rlsheffi Completed 5/29/2006 9:18:09 AM

Sequence number: 11
Author: ENDL[RWeber]
Date: 2/28/2006 2:47:44 PM

T "V1" might be confused with "Version 1". Recommend spelling out "Volume".

RESOLUTION:

Delete "V1", as it refers to all three volumes.

Status
rlsheffi Completed 5/29/2006 9:19:05 AM

Sequence number: 12
Author: WDC[CStevens]
Subject: Cross-Out
Date: 3/9/2006 2:03:18 PM

T packet

S/B PACKET feature set

RESOLUTION: change "packet feature set" to "PACKET Command feature set"

Status
rlsheffi Completed 5/29/2006 9:19:38 AM

Sequence number: 13
Author: HPQ[RElliott]
Date: 2/28/2006 8:33:42 AM

T 3.1.4

packet s/b Packet

REASON: Accepted WDC suggestion instead - "PACKET" (actually, "PACKET Command").

Status

Comments from page 25 continued on next page

3 Definitions, symbols, abbreviations, and conventions

3.1 Definitions

3.1.1 additional sense code: A combination of the ADDITIONAL SENSE CODE and ADDITIONAL SENSE CODE QUALIFIER fields in the sense data. A detailed definition of sense data may be found in SPC-3.

3.1.2 application client: An object that is the source of SCSI commands. Further definition of an application client is found in SAM-3.

~~**3.1.3 AT Attachment (ATA):** A standard for the attachment of storage devices to hosts. See ATA/ATAPI-7 V1.~~

3.1.4 ATA device: ¹⁵ device implementing the ¹⁴ general feature set, and does not implement the ~~packet~~ feature set, as described in ATA/ATAPI-7 (see 2.2).

~~**3.1.5 ATA/ATAPI device:** ¹⁷ ATA/ATAPI-7 device (see 3.1.6).~~

~~**3.1.6 ATA/ATAPI-7 device:** A device that complies with ATA/ATAPI-7.~~

3.1.7 ATA domain: An I/O system ²⁰ consisting of ¹⁹ ATA hosts and ATA/ATAPI devices that communicate with one another by means of a service delivery subsystem.

3.1.8 ATA flush command: A FLUSH CACHE or FLUSH CACHE EXT command defined in ATA/ATAPI-7.

3.1.9 ATA hard reset: For a SATA device, an action in response to a reset event (COMRESET or power-on reset) in which the SATA Phy state machine transitions to the initial state (see ATA8-AST). For a PATA device, assertion of the RESET- signal (Hardware reset) by an ATA host to reset the attached ATA device (See ATA8-APT).

3.1.10 ATA host: A host device that originates requests to be processed by an ATA/ATAPI device.

3.1.11 ATA LBA: If the attached ATA device is a PATA device, this is the set of registers comprised of the LBA High, LBA Mid, and LBA Low registers (i.e., inclusive of both previous and current instances of those registers when 48-bit addressing is used) in the ATA Command Block registers. If the attached ATA device is a SATA device, this is the set of fields in the SATA Command FIS comprised if the LBA Low, LBA Mid, LBA High, LBA Low (ext), LBA Mid (ext), and LBA High (ext) fields (see ATA/ATAPI-7).

3.1.12 AT Attachment Packet Interface (ATAPI): An element of the ATA specification that defines a Packet Command feature set that provides the capability to pass-through SCSI-type commands encapsulated through an ATA transport.

3.1.13 ATAPI device: A device implementing the ~~packet feature~~ set as described in ATA/ATAPI-7.

3.1.14 ATA queued commands: Queued read and write commands issued to an ATA device (see 3.1.4) that supports the Overlapped feature set of ATA/ATAPI-7 or the native command queuing (see 3.1.45) feature of SATA 2.5 (see 3.1.59).

3.1.15 ATA read command: One of the following ATA commands: READ DMA, READ DMA EXT, READ DMA QUEUED, READ DMA QUEUED EXT, READ MULTIPLE, READ MULTIPLE EXT, READ SECTOR(S), or READ SECTOR(S) EXT defined in ATA/ATAPI-7; or READ FPDMA QUEUED defined in SATA 2.5.

3.1.16 ATA Sector Count: If the attached ATA device is a PATA device this is the Sector Count register (i.e., inclusive of both previous and current instances of the register when 48-bit addressing is used). If the attached device is a SATA device this is the Sector Count and Sector Count (ext) fields in a SATA Command FIS.

rlsheffi Rejected 2/28/2006 8:24:34 AM

Sequence number: 14
Author: HPQ[RElliott]
Date: 2/3/2006 7:52:01 AM
T 3.1.4

general s/b General

Status
rlsheffi Completed 5/29/2006 9:20:26 AM

Sequence number: 15
Author: MXO[MEvans]
Subject: Highlight
Date: 5/23/2006 5:08:42 PM
T 3.1.4 ATA device: change the definition to, "A device that implements the General feature set and does not implement the PACKET Command feature set (see ATA/ATAPI-7)." Note: the names of the feature sets are capitalized, and the PACKET Command feature set ["PACKET" capitalized] is the name in A/A-7. It was changed to the PACKET feature set in ATA8-ACS.
RESOLUTION: change to,
"A device that implements the General feature set and does not implement the PACKET Command feature set (see ATA8-ACS)."
NOTE: Per Feb 28 SAT WG, consensus was the proper term (in ATA8-ACS) is "PACKET Command feature set".

Status
rlsheffi Completed 5/29/2006 9:21:45 AM

Sequence number: 16
Author: EDITOR[rlsheffi]
Subject: Cross-Out
Date: 5/23/2006 12:44:40 PM
T REASON: Per earlier LB comment, changing ATA/ATAPI-7 references to ATA8 document references, and ATA8 does not use the term ATA/ATAPI device.

Status
rlsheffi Completed 5/29/2006 9:24:56 AM

Sequence number: 17
Author: MXO[MEvans]
Subject: Highlight
Date: 5/23/2006 12:46:08 PM
T 3.1.5 ATA/ATAPI device: change the definition to, "An ATA/ATAPI-7 device (see 3.1.6)."
REASON: Deleting definition to conform with ATA8 terminology per earlier LB comment to reference ATA8 instead of ATA/ATAPI-7.

Status
rlsheffi Rejected 5/23/2006 12:45:09 PM

Sequence number: 18
Author: EDITOR[rlsheffi]
Subject: Cross-Out
Date: 5/22/2006 2:49:59 PM
T 3.1.6 ATA/ATAPI-7 device:
Delete definition (referencing ATA8, which defines "ATAPI device", see)

Status
rlsheffi Completed 5/29/2006 9:25:08 AM

Sequence number: 19
Author: HPQ[RElliott]
Subject: Highlight
Date: 2/28/2006 8:43:52 AM
T 3.1.7

"an ATA hosts" s/b singular (see SAS-1.1 and ATA8-AAM)
REASON: Duplicate of MXO comment. Resolution includes this suggestion.

Status
rlsheffi Completed 5/29/2006 9:27:38 AM

Sequence number: 20
Author: DELL[KMarks]
Subject: Highlight
Date: 2/28/2006 8:42:32 AM
T 3.1.7 ATA domain:
change
"...consisting of an ATA hosts and ATA/ATAPI..."

Comments from page 25 continued on next page

3 Definitions, symbols, abbreviations, and conventions

3.1 Definitions

3.1.1 additional sense code: A combination of the ADDITIONAL SENSE CODE and ADDITIONAL SENSE CODE QUALIFIER fields in the sense data. A detailed definition of sense data may be found in SPC-3.

3.1.2 application client: An object that is the source of SCSI commands. Further definition of an application client is found in SAM-3.

~~**3.1.3 AT Attachment (ATA):** A standard for the attachment of storage devices to hosts. See ATA/ATAPI-7 V1.~~

3.1.4 ATA device: A device implementing the general feature set, and does not implement the packet feature set, as described in ATA/ATAPI-7 (see 2.2).

~~**3.1.5 ATA/ATAPI device:** ATA/ATAPI-7 device (see 3.1.6).~~

~~**3.1.6 ATA/ATAPI-7 device:** A device that complies with ATA/ATAPI-7.~~

3.1.7 ATA domain: ²¹ I/O system consisting of ~~an ATA hosts~~ and ATA/ATAPI devices that communicate with one another by means of a service delivery subsystem. ²²

²³ **3.8 ATA flush command:** ²⁵ FLUSH CACHE or FLUSH CACHE EXT command defined in ATA/ATAPI-7.

²⁶ **3.9 ATA hard reset:** For a SATA device, an action in response to a reset event (COMRESET ²⁷ power-on reset) in which the SATA Phy state machine transitions to the initial state (see ATA8-AST). For a PATA device, assertion of the RESET- signal (Hardware reset) by an ATA host to reset the attached ATA device (See ATA8-APT).

3.1.10 ATA host: A host device that originates requests to be processed by an ATA/ATAPI device.

3.1.11 ATA LBA: If the attached ATA device is a PATA device, this is the set of registers comprised of the LBA High, LBA Mid, and LBA Low registers (i.e., inclusive of both previous and current instances of those registers when 48-bit addressing is used) in the ATA Command Block registers. If the attached ATA device is a SATA device, this is the set of fields in the SATA Command FIS comprised if the LBA Low, LBA Mid, LBA High, LBA Low (ext), LBA Mid (ext), and LBA High (ext) fields (see ATA/ATAPI-7).

3.1.12 AT Attachment Packet Interface (ATAPI): An element of the ATA specification that defines a Packet Command feature set that provides the capability to pass-through SCSI-type commands encapsulated through an ATA transport.

3.1.13 ATAPI device: A device implementing the packet feature set as described in ATA/ATAPI-7.

3.1.14 ATA queued commands: Queued read and write commands issued to an ATA device (see 3.1.4) that supports the Overlapped feature set of ATA/ATAPI-7 or the native command queuing (see 3.1.45) feature of SATA 2.5 (see 3.1.59).

3.1.15 ATA read command: One of the following ATA commands: READ DMA, READ DMA EXT, READ DMA QUEUED, READ DMA QUEUED EXT, READ MULTIPLE, READ MULTIPLE EXT, READ SECTOR(S), or READ SECTOR(S) EXT defined in ATA/ATAPI-7; or READ FPDMA QUEUED defined in SATA 2.5.

3.1.16 ATA Sector Count: If the attached ATA device is a PATA device this is the Sector Count register (i.e., inclusive of both previous and current instances of the register when 48-bit addressing is used). If the attached device is a SATA device this is the Sector Count and Sector Count (ext) fields in a SATA Command FIS.

to
"...consisting of an ATA host and ATA/ATAPI..."

Don't follow argument of a SATA A/A Mux having only one domain.

REASON: Duplicate of MXO comment, and the SATA A/A mux isn't (yet) defined by any standard or public specification.

Status
risheffi Rejected 2/28/2006 8:41:25 AM

Sequence number: 21
Author: MXO[MEvans]
Subject: Highlight
Date: 5/22/2006 2:53:21 PM
T 3.1.7 ATA domain: change the definition to, "An I/O subsystem that is made up of one host, one or more devices, and a service delivery subsystem (see ATA8-AAM)."
RESOLUTION:
"An I/O subsystem that is made up of one ATA host, a service delivery subsystem, and one or more ATA devices or ATAPI devices (see ATA8-AAM)."

Status
risheffi Completed 5/29/2006 9:27:52 AM

Sequence number: 22
Author: WDC[CStevens]
Subject: Replacement Text
Date: 3/9/2006 2:05:27 PM
T S/B an ATA host...
A REASON: duplicate of MXO comment

Status
risheffi Completed 5/29/2006 9:28:11 AM

Sequence number: 23
Author: IBM[GPenokie]
Subject: Underline
Date: 2/16/2006 1:42:36 PM
T 3.1.8 ATA flush command:

Status
risheffi Cancelled 2/28/2006 2:17:55 PM

Sequence number: 24
Author: IBM[GPenokie]
Subject: Highlight
Date: 2/15/2006 7:37:16 AM
T Should be << A FLUSH CACHE command or FLUSH CACHE EXT command >>

Status
risheffi Completed 5/29/2006 9:29:32 AM

Sequence number: 25
Author: MXO[MEvans]
Subject: Highlight
Date: 5/29/2006 9:30:18 AM
T 3.1.8 ATA flush command: change the definition to, "A FLUSH CACHE or FLUSH CACHE EXT command (see ATA/ATAPI-7)."
RESOLUTION: s/b
"A FLUSH CACHE command or a FLUSH CACHE EXT command (see ATA8-ACS)."

Status
risheffi Completed 5/29/2006 9:29:47 AM

Sequence number: 26
Author: IBM[GPenokie]
Subject: Underline
Date: 2/16/2006 1:42:53 PM
T 3.1.9 ATA hard reset:

Status
risheffi Cancelled 2/28/2006 2:18:06 PM

Sequence number: 27
Author: STX[GHoulder]
Subject: Cross-Out
Date: 2/28/2006 1:42:54 PM

Comments from page 25 continued on next page

3 Definitions, symbols, abbreviations, and conventions

3.1 Definitions

3.1.1 additional sense code: A combination of the ADDITIONAL SENSE CODE and ADDITIONAL SENSE CODE QUALIFIER fields in the sense data. A detailed definition of sense data may be found in SPC-3.

3.1.2 application client: An object that is the source of SCSI commands. Further definition of an application client is found in SAM-3.

~~**3.1.3 AT Attachment (ATA):** A standard for the attachment of storage devices to hosts. See ATA/ATAPI-7 V1.~~

3.1.4 ATA device: A device implementing the general feature set, and does not implement the packet feature set, as described in ATA/ATAPI-7 (see 2.2).

~~**3.1.5 ATA/ATAPI device:** ATA/ATAPI-7 device (see 3.1.6).~~

~~**3.1.6 ATA/ATAPI-7 device:** A device that complies with ATA/ATAPI-7.~~

3.1.7 ATA domain: An I/O system consisting of an ATA hosts and ATA/ATAPI devices that communicate with one another by means of a service delivery subsystem.

3.1.8 ATA flush command: A FLUSH CACHE or FLUSH CACHE EXT command defined in ATA/ATAPI-7.

3.1.9 ATA hard reset: ²⁸ For a SATA device, an action in response to a reset event (COMRESET or power-on reset) in which the SATA Phy state machine transitions to the initial state (see ATA8-AST). ³⁰ For a PATA device, assertion of the ³¹ RESET- signal (Hardware reset) by an ATA host to reset the attached ATA device (See ATA8-APT).

3.1.10 ATA host: ³² host device that originates requests to be processed by an ATA/ATAPI device.

3.1.11 ATA LBA: If the attached ATA device is a PATA device, this is the set of registers comprised of the LBA High, LBA Mid, and LBA Low registers (i.e., inclusive of both previous and current instances of those registers when 48-bit addressing is used) in the ATA Command Block registers. If the attached ATA device is a SATA device, this is the set of fields in the SATA Command FIS comprised if the LBA Low, LBA Mid, LBA High, LBA Low (ext), LBA Mid (ext), and LBA High (ext) fields (see ATA/ATAPI-7).

3.1.12 AT Attachment Packet Interface (ATAPI): An element of the ATA specification that defines a Packet Command feature set that provides the capability to pass-through SCSI-type commands encapsulated through an ATA transport.

3.1.13 ATAPI device: A device implementing the packet feature set as described in ATA/ATAPI-7.

3.1.14 ATA queued commands: Queued read and write commands issued to an ATA device (see 3.1.4) that supports the Overlapped feature set of ATA/ATAPI-7 or the native command queuing (see 3.1.45) feature of SATA 2.5 (see 3.1.59).

3.1.15 ATA read command: One of the following ATA commands: READ DMA, READ DMA EXT, READ DMA QUEUED, READ DMA QUEUED EXT, READ MULTIPLE, READ MULTIPLE EXT, READ SECTOR(S), or READ SECTOR(S) EXT defined in ATA/ATAPI-7; or READ FPDMA QUEUED defined in SATA 2.5.

3.1.16 ATA Sector Count: If the attached ATA device is a PATA device this is the Sector Count register (i.e., inclusive of both previous and current instances of the register when 48-bit addressing is used). If the attached device is a SATA device this is the Sector Count and Sector Count (ext) fields in a SATA Command FIS.

 PDF page 25

section 3.1.9

delete the phrase "or power-on reset"

RESOLUTION: comment withdrawn

Status

rsheffi Cancelled 2/28/2006 1:42:12 PM

Sequence number: 28

Author: MXO[MEvans]

Subject: Highlight

Date: 5/29/2006 9:51:34 AM

 3.1.9 ATA hard reset: change the definition to, "An event that causes an ATA device to perform its device specific hardware reset and internal diagnostics routine. For a SATA device, this event is a COMRESET or power on reset, for a PATA device, this event is the assertion of the RESET- signal (see ATA/ATAPI-7)."

RESOLUTION: (definition of "hardware reset" from ATA8-AAM) and change all instances of "ATA hard reset" to "ATA hardware reset":

"The routines performed by the ATA device server and the ATA device port in an ATA device after a hardware reset event occurs (see ATA8-AAM). The hardware reset routines performed by the ATA device include the actions performed by the ATA device for a software reset (see ATA-AAM), and the actions defined in ATA8-ACS and the applicable ATA transport standards."

Status

rsheffi Completed 5/29/2006 9:42:14 AM

Sequence number: 29

Author: WDC[CStevens]

Subject: Note

Date: 3/2/2006 8:20:36 PM

 Remove artifact

Status

rsheffi Completed 5/29/2006 9:31:12 AM

Sequence number: 30

Author: HPQ[RElliott]

Subject: Highlight

Date: 2/28/2006 1:05:28 PM

 3.1.9

remove all ATA8-AST references

RESOLUTION: Change all ATA8-AST references to SATA 2.5.

Status

rsheffi Completed 5/29/2006 9:47:21 AM

Sequence number: 31

Author: IBM[GPenokie]

Subject: Highlight

Date: 3/9/2006 2:21:28 PM

 This <<RESET- signal (Hardware reset) by >> should be << RESET- signal (i.e., Hardware reset) by >>

REASON: Accepted MXO comment instead, which deletes the parenthetical expression.

CONFIRMED

Status

rsheffi Rejected 2/28/2006 8:52:24 AM

Sequence number: 32

Author: MXO[MEvans]

Subject: Note

Date: 2/15/2006 10:35:58 AM

 3.1x Definitions and global: The terms "host" and "ATA/ATAPI host" are used in the draft with no definition. Search and replace these terms with "ATA host".

Status

rsheffi Completed 5/29/2006 9:55:10 AM

Sequence number: 33

Author: MXO[MEvans]

Subject: Highlight

Date: 5/23/2006 12:36:22 PM

 3.1.10 ATA host: change the definition to, "An object that originates requests to be processed by an ATA/ATAPI device."

RESOLUTION: s/b

"An object that originates requests to be processed by an ATA device or an ATAPI device."

Comments from page 25 continued on next page

3 Definitions, symbols, abbreviations, and conventions

3.1 Definitions

3.1.1 additional sense code: A combination of the ADDITIONAL SENSE CODE and ADDITIONAL SENSE CODE QUALIFIER fields in the sense data. A detailed definition of sense data may be found in SPC-3.

3.1.2 application client: An object that is the source of SCSI commands. Further definition of an application client is found in SAM-3.

~~**3.1.3 AT Attachment (ATA):** A standard for the attachment of storage devices to hosts. See ATA/ATAPI-7 V1.~~

3.1.4 ATA device: A device implementing the general feature set, and does not implement the packet feature set, as described in ATA/ATAPI-7 (see 2.2).

~~**3.1.5 ATA/ATAPI device:** ATA/ATAPI-7 device (see 3.1.6).~~

~~**3.1.6 ATA/ATAPI-7 device:** A device that complies with ATA/ATAPI-7.~~

3.1.7 ATA domain: An I/O system consisting of an ATA hosts and ATA/ATAPI devices that communicate with one another by means of a service delivery subsystem.

3.1.8 ATA flush command: A FLUSH CACHE or FLUSH CACHE EXT command defined in ATA/ATAPI-7.

3.1.9 ATA hard reset: For a SATA device, an action in response to a reset event (COMRESET or power-on reset) in which the SATA Phy state machine transitions to the initial state (see ATA8-AST). For a PATA device, assertion of the RESET- signal (Hardware reset) by an ATA host to reset the attached ATA device (See ATA8-APT).

3.1.10 ATA host: A host device that originates requests to be processed by an ATA/ATAPI device.

37 3.1.11 ATA LBA 339: If the attached ATA device is a PATA device, this is the set of registers comprised of the LBA High, LBA Mid, and LBA Low registers (i.e., inclusive of both previous and current instances of those registers when 48-bit addressing is used) in the ATA Command Block registers. If the attached ATA device is a SATA device, this is the set of fields in the SATA Command FIS comprised if the LBA Low, LBA Mid, LBA High, LBA Low (ext), LBA Mid (ext), and LBA High (ext) fields (see ATA/ATAPI-7).

40 3.1.12 AT Attachment Packet Interface (ATAPI): An element of the ATA specification that defines a Packet Command feature set that provides the capability to pass-through SCSI-type commands encapsulated through an ATA transport.

3.1.13 ATAPI device: A device implementing the packet feature set as described in ATA/ATAPI-7.

3.1.14 ATA queued commands: Queued read and write commands issued to an ATA device (see 3.1.4) that supports the Overlapped feature set of ATA/ATAPI-7 or the native command queuing (see 3.1.45) feature of SATA 2.5 (see 3.1.59).

3.1.15 ATA read command: One of the following ATA commands: READ DMA, READ DMA EXT, READ DMA QUEUED, READ DMA QUEUED EXT, READ MULTIPLE, READ MULTIPLE EXT, READ SECTOR(S), or READ SECTOR(S) EXT defined in ATA/ATAPI-7; or READ FPDMA QUEUED defined in SATA 2.5.

3.1.16 ATA Sector Count: If the attached ATA device is a PATA device this is the Sector Count register (i.e., inclusive of both previous and current instances of the register when 48-bit addressing is used). If the attached device is a SATA device this is the Sector Count and Sector Count (ext) fields in a SATA Command FIS.

Status
risheffi Completed 5/29/2006 9:56:18 AM

Sequence number: 34
Author: IBM[GPenokie]
Subject: Underline
Date: 2/16/2006 1:43:43 PM
T 3.1.11 ATA LBA:

Status
risheffi Cancelled 2/28/2006 2:18:16 PM

Sequence number: 35
Author: STX[GHolder]
Subject: Cross-Out
Date: 2/23/2006 6:42:23 PM
T PDF page 25 and 28

T section 3.1.11
Remove the period that preceeds the text
".If the ..."

Status
risheffi Completed 5/29/2006 9:56:59 AM

Sequence number: 36
Author: HPQ[RElliott]
Subject: Highlight
Date: 1/19/2006 9:21:16 AM
T 3.1.11

Delete leading .

Status
risheffi Completed 5/29/2006 9:57:09 AM

Sequence number: 37
Author: DELL[KMarks]
Subject: Highlight
Date: 1/20/2006 12:57:47 PM
T 3.1.11 ATA LBA: .If the attached

Remove leading period.

Status
risheffi Completed 5/29/2006 9:57:22 AM

Sequence number: 38
Author: IBM[GPenokie]
Subject: Highlight
Date: 2/15/2006 7:40:50 AM
T There appears to be a period at the start of this sentence. It needs to be removed.

Status
risheffi Completed 5/29/2006 9:57:31 AM

Sequence number: 39
Author: MXO[MEvans]
Subject: Highlight
Date: 5/22/2006 10:44:45 AM
T 3.1.11 ATA LBA: change the definition to, "A logical block address (see 3.1.38 [or whatever the cross reference becomes as the result of other changes]) in an ATA device. For a PATA device, the ATA LBA is contained in the set of registers comprised of the LBA High, LBA Mid, and LBA Low registers inclusive of both previous and current instances of those registers when 48-bit addressing is used. For a SATA device, the ATA LBA is contained in the set of fields in the SATA Command FIS comprised if the LBA Low, LBA Mid, LBA High, LBA Low (ext), LBA Mid (ext), and LBA High (ext) fields (see ATA/ATAPI-7)."
RESOLUTION: To conform with the global LB comment to reference ATA8, change definition to,
"A logical block address (see 3.1.38) used to reference a logical sector in an ATA device (see ATA8-ACS)".

Status
risheffi Completed 5/29/2006 9:59:46 AM

Sequence number: 40
Author: DELL[KMarks]
Subject: Highlight
Date: 2/28/2006 9:07:03 AM

Comments from page 25 continued on next page

3 Definitions, symbols, abbreviations, and conventions

3.1 Definitions

3.1.1 additional sense code: A combination of the ADDITIONAL SENSE CODE and ADDITIONAL SENSE CODE QUALIFIER fields in the sense data. A detailed definition of sense data may be found in SPC-3.

3.1.2 application client: An object that is the source of SCSI commands. Further definition of an application client is found in SAM-3.

~~**3.1.3 AT Attachment (ATA):** A standard for the attachment of storage devices to hosts. See ATA/ATAPI-7 V1.~~

3.1.4 ATA device: A device implementing the general feature set, and does not implement the packet feature set, as described in ATA/ATAPI-7 (see 2.2).

~~**3.1.5 ATA/ATAPI device:** ATA/ATAPI-7 device (see 3.1.6).~~

~~**3.1.6 ATA/ATAPI-7 device:** A device that complies with ATA/ATAPI-7.~~

3.1.7 ATA domain: An I/O system consisting of an ATA hosts and ATA/ATAPI devices that communicate with one another by means of a service delivery subsystem.

3.1.8 ATA flush command: A FLUSH CACHE or FLUSH CACHE EXT command defined in ATA/ATAPI-7.

3.1.9 ATA hard reset: For a SATA device, an action in response to a reset event (COMRESET or power-on reset) in which the SATA Phy state machine transitions to the initial state (see ATA8-AST). For a PATA device, assertion of the RESET- signal (Hardware reset) by an ATA host to reset the attached ATA device (See ATA8-APT).

3.1.10 ATA host: A host device that originates requests to be processed by an ATA/ATAPI device.

3.1.11 ATA LBA: If the attached ATA device is a PATA device, this is the set of registers comprised of the LBA High, LBA Mid, and LBA Low registers (i.e., inclusive of both previous and current instances of those registers when 48-bit addressing is used) in the ATA Command Block registers. If the attached ATA device is a SATA device, this is the set of fields in the SATA Command FIS comprised if the LBA Low, LBA Mid, LBA High, LBA Low (ext), LBA Mid (ext), and LBA High (ext) fields (see ATA/ATAPI-7).

3.1.12 AT Attachment Packet Interface (ATAPI): ⁴¹ element of the ATA specification that defines a ⁴² packet Command feature set that provides the capability to pass-through SCSI-type commands encapsulated through an ATA transport.

⁴⁴ **3.1.13 ATAPI device:** A device implementing the ⁴⁶ packet feature set as described in ATA/ATAPI-7.

3.1.14 ATA queued commands: Queued read and write commands issued to an ATA device (see 3.1.4) that supports the Overlapped feature set of ATA/ATAPI-7 or the native command queuing (see 3.1.45) feature of SATA 2.5 (see 3.1.59).

3.1.15 ATA read command: One of the following ATA commands: READ DMA, READ DMA EXT, READ DMA QUEUED, READ DMA QUEUED EXT, READ MULTIPLE, READ MULTIPLE EXT, READ SECTOR(S), or READ SECTOR(S) EXT defined in ATA/ATAPI-7; or READ FPDMA QUEUED defined in SATA 2.5.

3.1.16 ATA Sector Count: If the attached ATA device is a PATA device this is the Sector Count register (i.e., inclusive of both previous and current instances of the register when 48-bit addressing is used). If the attached device is a SATA device this is the Sector Count and Sector Count (ext) fields in a SATA Command FIS.

T 3.1.12 AT Attachment Packet Interface (ATAPI)

change

"... defines a Packet Command feature set that provides ..."

to"... defines a PACKET Command feature set that provides ..."

REASON: Accepted MXO comment instead, which also fixes this problem.

Status
rlsheffi Completed 5/29/2006 10:01:22 AM

Sequence number: 41
Author: MXO[MEvans]
Subject: Highlight
Date: 2/15/2006 10:38:33 AM

T 3.1.12 AT Attachment Packet Interface (ATAPI): change the definition to, "The elements of the ATA standards that define the PACKET Command feature set, which provides the capability to encapsulate SCSI and other types of commands and pass them through an ATA transport."

Status
rlsheffi Completed 5/29/2006 10:01:09 AM

Sequence number: 42
Author: HPQ[RElliott]
Date: 3/9/2006 2:22:46 PM

T 3.1.12

"Packet Command feature set" s/b Packet feature set"

REASON: Correct usage is "PACKET Command feature set" per Feb 28 SAT WG.

CONFIRMED

Status
rlsheffi Rejected 2/28/2006 9:07:11 AM

Sequence number: 43
Author: WDC[CStevens]
Subject: Cross-Out
Date: 5/23/2006 5:25:42 PM

T packet feature

S/B PACKET feature set

RESOLUTION: s/b "PACKET Command feature set"

REASON: Applying an earlier LB comment to reference ATA8 documents rather than ATA/ATAPI-7

Status
rlsheffi Completed 5/29/2006 10:02:50 AM

Sequence number: 44
Author: DELL[KMarks]
Subject: Highlight
Date: 5/23/2006 5:06:10 PM

T change

"3.1.13 ATAPI device: A device implementing the packet feature set as described in ATA/ATAPI-7."

to

"3.1.13 ATAPI device: A device implementing the PACKET Command feature set as described in ATA/ATAPI-7."

RESOLUTION: change to

"3.1.13 ATAPI device: A device implementing the PACKET Command feature set (see ATA8-ACS)."

Status
rlsheffi Completed 5/29/2006 10:03:15 AM

Sequence number: 45
Author: MXO[MEvans]
Subject: Highlight
Date: 5/29/2006 10:03:45 AM

T 3.1.13 ATAPI device: change, "packet feature set" to "PACKET Command feature set".

Status
rlsheffi Completed 5/29/2006 10:03:49 AM

Sequence number: 46
Author: HPQ[RElliott]
Date: 5/23/2006 5:00:56 PM

T 3.1.13

3 Definitions, symbols, abbreviations, and conventions

3.1 Definitions

3.1.1 additional sense code: A combination of the ADDITIONAL SENSE CODE and ADDITIONAL SENSE CODE QUALIFIER fields in the sense data. A detailed definition of sense data may be found in SPC-3.

3.1.2 application client: An object that is the source of SCSI commands. Further definition of an application client is found in SAM-3.

~~**3.1.3 AT Attachment (ATA):** A standard for the attachment of storage devices to hosts. See ATA/ATAPI-7 V1.~~

3.1.4 ATA device: A device implementing the general feature set, and does not implement the packet feature set, as described in ATA/ATAPI-7 (see 2.2).

~~**3.1.5 ATA/ATAPI device:** ATA/ATAPI-7 device (see 3.1.6).~~

~~**3.1.6 ATA/ATAPI-7 device:** A device that complies with ATA/ATAPI-7.~~

3.1.7 ATA domain: An I/O system consisting of an ATA hosts and ATA/ATAPI devices that communicate with one another by means of a service delivery subsystem.

3.1.8 ATA flush command: A FLUSH CACHE or FLUSH CACHE EXT command defined in ATA/ATAPI-7.

3.1.9 ATA hard reset: For a SATA device, an action in response to a reset event (COMRESET or power-on reset) in which the SATA Phy state machine transitions to the initial state (see ATA8-AST). For a PATA device, assertion of the RESET- signal (Hardware reset) by an ATA host to reset the attached ATA device (See ATA8-APT).

3.1.10 ATA host: A host device that originates requests to be processed by an ATA/ATAPI device.

3.1.11 ATA LBA: If the attached ATA device is a PATA device, this is the set of registers comprised of the LBA High, LBA Mid, and LBA Low registers (i.e., inclusive of both previous and current instances of those registers when 48-bit addressing is used) in the ATA Command Block registers. If the attached ATA device is a SATA device, this is the set of fields in the SATA Command FIS comprised if the LBA Low, LBA Mid, LBA High, LBA Low (ext), LBA Mid (ext), and LBA High (ext) fields (see ATA/ATAPI-7).

3.1.12 AT Attachment Packet Interface (ATAPI): An element of the ATA specification that defines a Packet Command feature set that provides the capability to pass-through SCSI-type commands encapsulated through an ATA transport.

3.1.13 ATAPI device: A device implementing the packet feature set as described in ATA/ATAPI-7.

⁴⁷**3.1.14 ATA queued commands:** Queued read and write commands issued to an ATA device (see 3.1.4) that supports the Overlapped feature set of ATA/ATAPI-7 or the native command queuing (see 3.1.45) feature of SATA 2.5 (see 3.1.59).

⁴⁸**3.1.15 ATA read command:** ⁵⁰One of the following ATA commands: ⁴⁹READ DMA, READ DMA EXT, READ DMA QUEUED, READ DMA QUEUED EXT, READ MULTIPLE, READ MULTIPLE EXT, READ SECTOR(S), or READ SECTOR(S) EXT defined in ATA/ATAPI-7; or READ FPDMA QUEUED defined in SATA 2.5.

⁵¹**3.1.16 ATA Sector Count:** ⁵²If the attached ATA device is a PATA device this is the Sector Count register (i.e., inclusive of both previous and current instances of the register when 48-bit addressing is used). If the attached device is a SATA device this is the Sector Count and Sector Count (ext) fields in a SATA Command FIS.

packet s/b Packet

REASON: Accepted modified MXO & DELL comment instead, "PACKET Command feature set".

Status

rlsheffi Rejected 2/28/2006 9:09:32 AM

Sequence number: 47

Author: MXO[MEvans]

Subject: Highlight

Date: 5/25/2006 3:31:06 PM

T 3.1.14 ATA queued commands: change to, "3.1.14 ATA queued command: One of the following commands: READ DMA QUEUED, READ DMA QUEUED EXT, WRITE DMA QUEUED, WRITE DMA QUEUED EXT, or WRITE DMA QUEUED FUA EXT (see ATA/ATAPI-7); or READ FPDMA QUEUED or WRITE FPDMA QUEUED (see SATA 2.5)."

RESOLUTION:

3.1.14 ATA queued commands: change to, "3.1.14 ATA queued command: One of the following ATA commands: READ DMA QUEUED, READ DMA QUEUED EXT, WRITE DMA QUEUED, WRITE DMA QUEUED EXT, or WRITE DMA QUEUED FUA EXT (see ATA8-ACS); or READ FPDMA QUEUED or WRITE FPDMA QUEUED command (see SATA 2.5)."

(changed reference to ATA8-ACS instead of ATA/ATAPI-7)

Status

rlsheffi Completed 5/29/2006 10:05:57 AM

Sequence number: 48

Author: IBM[GPenokie]

Subject: Underline

Date: 2/16/2006 1:45:29 PM

T 3.1.15 ATA read command:

Status

rlsheffi Cancelled 2/28/2006 2:18:27 PM

Sequence number: 49

Author: IBM[GPenokie]

Subject: Highlight

Date: 5/29/2006 10:08:16 AM

T All the command names need to have the term << command >> after them.
SAT WG said it was redundant.

Status

rlsheffi Rejected 5/29/2006 10:07:27 AM

Sequence number: 50

Author: MXO[MEvans]

Subject: Highlight

Date: 5/23/2006 5:27:33 PM

T 3.1.15 ATA read command: change the definition to, "One of the following commands: READ DMA, READ DMA EXT, READ DMA QUEUED, READ DMA QUEUED EXT, READ MULTIPLE, READ MULTIPLE EXT, READ SECTOR(S), or READ SECTOR(S) EXT (see ATA/ATAPI-7); or READ FPDMA QUEUED (see SATA 2.5)."

RESOLUTION: s/b

"One of the following commands: READ DMA, READ DMA EXT, READ DMA QUEUED, READ DMA QUEUED EXT, READ MULTIPLE, READ MULTIPLE EXT, READ SECTOR(S), or READ SECTOR(S) EXT (see ATA8-ACS); or READ FPDMA QUEUED (see SATA 2.5)."

Status

rlsheffi Completed 5/29/2006 10:09:10 AM

Sequence number: 51

Author: IBM[GPenokie]

Subject: Underline

Date: 2/16/2006 1:45:44 PM

T 3.1.16 ATA Sector Count:

Status

rlsheffi Cancelled 2/28/2006 2:19:13 PM

Sequence number: 52

Author: MXO[MEvans]

Subject: Highlight

Date: 5/29/2006 10:10:05 AM

T 3.1.16 ATA Sector Count: change the definition to, "For a PATA device, the ATA Sector Count is contained in the set of registers comprised of the Sector Count register inclusive of both previous and current instances of that register when 48-bit addressing is

Comments from page 25 continued on next page

3 Definitions, symbols, abbreviations, and conventions

3.1 Definitions

3.1.1 additional sense code: A combination of the ADDITIONAL SENSE CODE and ADDITIONAL SENSE CODE QUALIFIER fields in the sense data. A detailed definition of sense data may be found in SPC-3.

3.1.2 application client: An object that is the source of SCSI commands. Further definition of an application client is found in SAM-3.

~~**3.1.3 AT Attachment (ATA):** A standard for the attachment of storage devices to hosts. See ATA/ATAPI-7 V1.~~

3.1.4 ATA device: A device implementing the general feature set, and does not implement the packet feature set, as described in ATA/ATAPI-7 (see 2.2).

~~**3.1.5 ATA/ATAPI device:** ATA/ATAPI-7 device (see 3.1.6).~~

~~**3.1.6 ATA/ATAPI-7 device:** A device that complies with ATA/ATAPI-7.~~

3.1.7 ATA domain: An I/O system consisting of an ATA hosts and ATA/ATAPI devices that communicate with one another by means of a service delivery subsystem.

3.1.8 ATA flush command: A FLUSH CACHE or FLUSH CACHE EXT command defined in ATA/ATAPI-7.

3.1.9 ATA hard reset: For a SATA device, an action in response to a reset event (COMRESET or power-on reset) in which the SATA Phy state machine transitions to the initial state (see ATA8-AST). For a PATA device, assertion of the RESET- signal (Hardware reset) by an ATA host to reset the attached ATA device (See ATA8-APT).

3.1.10 ATA host: A host device that originates requests to be processed by an ATA/ATAPI device.

3.1.11 ATA LBA: If the attached ATA device is a PATA device, this is the set of registers comprised of the LBA High, LBA Mid, and LBA Low registers (i.e., inclusive of both previous and current instances of those registers when 48-bit addressing is used) in the ATA Command Block registers. If the attached ATA device is a SATA device, this is the set of fields in the SATA Command FIS comprised if the LBA Low, LBA Mid, LBA High, LBA Low (ext), LBA Mid (ext), and LBA High (ext) fields (see ATA/ATAPI-7).

3.1.12 AT Attachment Packet Interface (ATAPI): An element of the ATA specification that defines a Packet Command feature set that provides the capability to pass-through SCSI-type commands encapsulated through an ATA transport.

3.1.13 ATAPI device: A device implementing the packet feature set as described in ATA/ATAPI-7.

3.1.14 ATA queued commands: Queued read and write commands issued to an ATA device (see 3.1.4) that supports the Overlapped feature set of ATA/ATAPI-7 or the native command queuing (see 3.1.45) feature of SATA 2.5 (see 3.1.59).

3.1.15 ATA read command: One of the following ATA commands: READ DMA, READ DMA EXT, READ DMA QUEUED, READ DMA QUEUED EXT, READ MULTIPLE, READ MULTIPLE EXT, READ SECTOR(S), or READ SECTOR(S) EXT defined in ATA/ATAPI-7; or READ FPDMA QUEUED defined in SATA 2.5.

3.1.16 ATA Sector Count: If the attached ATA device is a PATA device this is the Sector Count register (i.e., inclusive of both previous and current instances of the register when 48-bit addressing is used). If the attached device is a SATA device this is the Sector Count and Sector Count (ext) fields in a SATA Command FIS.

54

55

used. For a SATA device, the ATA Sector Count is contained in the Sector Count and Sector Count (ext) fields in a SATA Command FIS (see ATA/ATAPI-7)."

Proposed resolution:

"For a PATA device, the ATA Sector Count is contained in the set of registers comprised of the Sector Count register inclusive of both previous and current instances of that register when 48-bit addressing is used. For a SATA device, the ATA Sector Count is contained in the Sector Count field and Sector Count (ext) field in a SATA Command FIS (see ATA8-ACS)."

RESOLUTION: To conform with the global LB comment to reference ATA8, change definition to,

"A count of ATA logical sectors to transfer or process, represented by the Count field in an ATA command (see ATA8-ACS)".

Status
rlsheffi Completed 5/29/2006 10:10:45 AM

Sequence number: 53
Author: IBM[GPenokie]
Subject: Highlight
Date: 2/28/2006 9:20:17 AM

 This should be << Sector Count field and Sector Count (ext) field >>
RESOLUTION: Incorporated into MXO comment resolution on same definition.

Status
rlsheffi Completed 5/29/2006 10:11:03 AM

Sequence number: 54
Author: INTC[RSheffield]
Subject: Note
Date: 6/2/2006 3:40:54 PM
 Add a definition for ATA software reset:
3.1.xx ATA software reset:

Status
rlsheffi Completed 5/29/2006 10:14:52 AM

Sequence number: 55
Author: EDITOR[rlsheffi]
Subject: Note
Date: 4/24/2006 11:06:26 AM
 Ignore (for page alignment in comment summary).

Status
rlsheffi Cancelled 3/1/2006 10:41:28 AM

3.1.17 ATA verify command: A READ VERIFY SECTOR(S) or READ VERIFY SECTOR(S) EXT command defined in ATA/ATAPI-7.

3.1.18 ATA write command: One of the following ATA commands: WRITE DMA, WRITE DMA EXT, WRITE DMA FUA EXT, WRITE DMA QUEUED, WRITE DMA QUEUED EXT, WRITE DMA QUEUED FUA EXT, WRITE MULTIPLE, WRITE MULTIPLE EXT, WRITE MULTIPLE FUA EXT, WRITE SECTOR(S), or WRITE SECTOR(S) EXT defined in ATA/ATAPI-7; or WRITE FPDMA QUEUED defined in SATA 2.5.

3.1.19 ATA write FUA command sequence: A sequence of commands that writes logical blocks to an attached ATA device in a way that forces media access and consists of one of the following:

- a) a write followed by read verify command sequence as follows:
 - 1) a WRITE DMA, WRITE DMA EXT, WRITE DMA QUEUED, WRITE DMA QUEUED EXT, WRITE MULTIPLE, WRITE MULTIPLE EXT, WRITE SECTOR(S), or WRITE SECTOR(S) EXT command (see ATA/ATAPI-7) followed by
 - 2) a READ VERIFY SECTOR(S) or READ VERIFY SECTOR(S) EXT command (see ATA/ATAPI-7) accessing the same range of logical blocks written in the previous step;
- c) a WRITE DMA FUA EXT, WRITE DMA QUEUED FUA EXT, or WRITE MULTIPLE FUA EXT command (ATA/ATAPI-7), or
- d) a WRITE FPDMA QUEUED command (see SATA 2.5) with the FUA bit in the Device/Head field set to one.

See 5.3 for a description of multiple command sequence error handling.

3.1.20 auto-contingent allegiance (ACA): The task set condition established following the return of a CHECK CONDITION status when the NACA bit is set to one in the CONTROL byte. A detailed definition of ACA may be found in SAM-3.

3.1.21 autosense: Sense data that is returned in the same I_T_L_Q nexus transaction as the CHECK CONDITION status (see SAM-3). The alternative to autosense (i.e., use of a REQUEST SENSE command) is defined in SAM-2.

3.1.22 big-endian: A format for storage or transmission of binary data in which the most significant byte appears first. In a multi-byte value, the byte containing the most significant bit is stored in the lowest memory address and transmitted first and the byte containing the least significant bit is stored in the highest memory address and transmitted last (e.g., for the value 0080h, the byte containing 00h is stored in the lowest memory address and the byte containing 80h is stored in the highest memory address).

3.1.23 byte: A sequence of eight contiguous bits considered as a unit.

3.1.24 command descriptor block (CDB): A structure used to communicate a command from a SCSI application client to a SCSI device server.

3.1.25 device server: An object within the logical unit that processes SCSI tasks according to the rules for task management as described in SAM-3.

3.1.26 domain: A SCSI domain (see SAM-3) or an ATA domain (see ATA8-AAM).

3.1.27 DRQ data block: A unit of data words associated with available status when using either the PIO data-in command protocol or the PIO data-out command protocol (see ATA8-ACS)

3.1.28 field: A group of one or more contiguous bits.

3.1.29 first-party direct memory access (FPDMA): A method by which a device accesses host memory (see SATA 2.5).

~~**3.1.30 frame information structure (FIS):** The SATA frame format. The payload of a frame, does not include the SOF, CRC, and EOF delimiters (see ATA/ATAPI-7).~~

Sequence number: 1
Author: MXO[MEvans]
Subject: Highlight
Date: 5/25/2006 7:55:58 AM

T 3.1.17 ATA verify command: change, "defined in ATA/ATAPI-7" to "(see ATA/ATAPI-7)".
RESOLUTION: change to,
"(see ATA8-ACS)"

Status
rlsheffi Completed 5/29/2006 10:40:13 AM

Sequence number: 2
Author: IBM[GPenokie]
Subject: Underline
Date: 2/16/2006 1:40:41 PM
T 3.1.18 ATA write command:

Status
rlsheffi Cancelled 2/28/2006 2:19:21 PM

Sequence number: 3
Author: IBM[GPenokie]
Subject: Highlight
Date: 2/28/2006 2:28:38 PM

T All the command names need to have the term << command >> after them.
REASON: Per Feb 28 WG want to use a format consistent with searching for these terms in ATA documents.
Editor: find similar comments and disposition the same way (even those already accepted).

Status
rlsheffi Rejected 2/28/2006 2:37:35 PM

Sequence number: 4
Author: MXO[MEvans]
Subject: Highlight
Date: 5/25/2006 7:56:32 AM

T 3.1.18 ATA write command: change the definition to, "One of the following commands: WRITE DMA, WRITE DMA EXT, WRITE DMA FUA EXT, WRITE DMA QUEUED, WRITE DMA QUEUED EXT, WRITE DMA QUEUED FUA EXT, WRITE MULTIPLE, WRITE MULTIPLE EXT, WRITE MULTIPLE FUA EXT, WRITE SECTOR(S), or WRITE SECTOR(S) EXT (see ATA/ATAPI-7); or WRITE FPDMA QUEUED (see SATA 2.5)."
RESOLUTION:
"One of the following ATA commands: WRITE DMA, WRITE DMA EXT, WRITE DMA FUA EXT, WRITE DMA QUEUED, WRITE DMA QUEUED EXT, WRITE DMA QUEUED FUA EXT, WRITE MULTIPLE, WRITE MULTIPLE EXT, WRITE MULTIPLE FUA EXT, WRITE SECTOR(S), or WRITE SECTOR(S) EXT (see ATA8-ACS); or WRITE FPDMA QUEUED (see SATA 2.5)."

Status
rlsheffi Completed 5/29/2006 10:42:44 AM

Sequence number: 5
Author: IBM[GPenokie]
Subject: Underline
Date: 2/16/2006 1:41:23 PM
T 3.1.19 ATA write FUA command sequence:

Status
rlsheffi Cancelled 2/28/2006 2:40:15 PM

Sequence number: 6
Author: MXO[MEvans]
Subject: Highlight
Date: 2/28/2006 3:06:42 PM

T 3.1.19 ATA write FUA sequence: change the definition to, "A sequence of commands that writes logical blocks to an attached ATA device in a way that forces media access (see 5.3)." Then move all of the other stuff on how it works to 5.3, adding a new subclause, if necessary.
RESOLUTION: Move the unordered/ordered list to 9.17.2 and delete this definition.

Status
rlsheffi Completed 5/29/2006 10:51:46 AM

3.1.17 ATA verify command: A READ VERIFY SECTOR(S) or READ VERIFY SECTOR(S) EXT command defined in ATA/ATAPI-7.

3.1.18 ATA write command: One of the following ATA commands: WRITE DMA, WRITE DMA EXT, WRITE DMA FUA EXT, WRITE DMA QUEUED, WRITE DMA QUEUED EXT, WRITE DMA QUEUED FUA EXT, WRITE MULTIPLE, WRITE MULTIPLE EXT, WRITE MULTIPLE FUA EXT, WRITE SECTOR(S), or WRITE SECTOR(S) EXT defined in ATA/ATAPI-7; or WRITE FPDMA QUEUED defined in SATA 2.5.

3.1.19 ATA write FUA command sequence: A sequence of commands that writes logical blocks to an attached ATA device in a way that forces media access and consists of one of the following:

- a) a write followed by read verify command sequence as follows:
 - 1) a WRITE DMA, WRITE DMA EXT, WRITE DMA QUEUED, WRITE DMA QUEUED EXT, WRITE MULTIPLE, WRITE MULTIPLE EXT, WRITE SECTOR(S), or WRITE SECTOR(S) EXT command (see ATA/ATAPI-7) followed by
 - 2) a READ VERIFY SECTOR(S) or READ VERIFY SECTOR(S) EXT command (see ATA/ATAPI-7) accessing the same range of logical blocks written in the previous step;
- c) a WRITE DMA FUA EXT, WRITE DMA QUEUED FUA EXT, or WRITE MULTIPLE FUA EXT command (ATA/ATAPI-7), or
- d) a WRITE FPDMA QUEUED command (see SATA 2.5) with the FUA in the Device/Head field set to one.

See 5.3 for a description of multiple command sequence error handling.

3.1.20 auto-contingent allegiance (ACA): The task set condition established following the return of a CHECK CONDITION status when the NACA bit is set to one in the CONTROL field. A detailed definition of ACA may be found in SAM-3.

3.1.21 autosense: Sense data that is returned in the same I_T_L_Q nexus transaction as the CHECK CONDITION status (see SAM-3). The alternative to autosense (i.e., use of a REQUEST SENSE command) is defined in SAM-2.

3.1.22 big-endian: A format for storage or transmission of binary data in which the most significant byte appears first. In a multi-byte value, the byte containing the most significant bit is stored in the lowest memory address and transmitted first and the byte containing the least significant bit is stored in the highest memory address and transmitted last (e.g., for the value 0080h, the byte containing 00h is stored in the lowest memory address and the byte containing 80h is stored in the highest memory address).

3.1.23 byte: A sequence of eight contiguous bits considered as a unit.

3.1.24 command descriptor block (CDB): A structure used to communicate a command from a SCSI application client to a SCSI device server.

3.1.25 device server: An object within the logical unit that processes SCSI tasks according to the rules for task management as described in SAM-3.

3.1.26 domain: A SCSI domain (see SAM-3) or an ATA domain (see ATA8-AAM).

3.1.27 DRQ data block: A unit of data words associated with available status when using either the PIO data-in command protocol or the PIO data-out command protocol (see ATA8-ACS)

3.1.28 field: A group of one or more contiguous bits.

3.1.29 first-party direct memory access (FPDMA): A method by which a device accesses host memory (see SATA 2.5).

~~**3.1.30 frame information structure (FIS):** The SATA frame format. The payload of a frame, does not include the SOF, CRC, and EOF delimiters (see ATA/ATAPI-7).~~

Sequence number: 7
Author: IBM[GPenokie]
Subject: Highlight
Date: 2/15/2006 7:48:17 AM

T

Status
rlsheffi Cancelled 2/28/2006 3:07:50 PM

Sequence number: 8
Author: IBM[GPenokie]
Subject: Highlight
Date: 2/28/2006 3:40:00 PM

T

All the command names need to have the term << command >> after them.
REASON: The Feb 28 SAT WG disagrees - feels "ATA XXX command, ATA YYY command,..." is too wordy and would rather introduce the list as "the following ATA commands: XXX, YYY,...". Entire list moved into 9.17.2 and revised.

Status
rlsheffi Rejected 2/28/2006 3:40:10 PM

Sequence number: 9
Author: IBM[GPenokie]
Subject: Note
Date: 2/28/2006 3:41:40 PM



This is way to much for a glossary entry. It should be moved to a subclause in clause 4.
RESOLUTION: Moved to subclause 9.17.2 and revised (the only place the terms is referenced), and definition deleted. See DELL comment resolution at 9.17.2.

Status
rlsheffi Completed 5/29/2006 10:52:47 AM

Sequence number: 10
Author: IBM[GPenokie]
Subject: Highlight
Date: 2/28/2006 3:42:20 PM

T

All the command names need to have the term << command >> after them.
REASON: Feb 28 SAT WG felt it would be too wordy.

Status
rlsheffi Rejected 2/28/2006 3:42:28 PM

Sequence number: 11
Author: IBM[GPenokie]
Subject: Highlight
Date: 2/28/2006 3:42:55 PM

T

All the command names need to have the term << command >> after them.
REASON: Feb 28 SAT WG felt it was too wordy.

Status
rlsheffi Rejected 2/28/2006 3:43:00 PM

Sequence number: 12
Author: DELL[KMarks]
Subject: Highlight
Date: 2/28/2006 3:53:08 PM

T

In 3.1.19 ATA write FUA command sequence, d)

change
"...bit in the Device/Head field set..."
to
"...bit in the Device field set..."

SATA and PATA specs don't use head any more.
RESOLUTION: Captured in new text in 9.17.2 (see DELL comment)

Status
rlsheffi Completed 5/29/2006 10:54:51 AM

Sequence number: 13
Author: MXO[MEvans]
Subject: Highlight
Date: 2/28/2006 3:53:54 PM

T

3.1.20 auto-contingent allegiance (ACA): change. "...CONTROL byte. A detailed definition of ACA may be found in SAM-3." to, "...CONTROL byte (see SAM-3)."

Comments from page 26 continued on next page

3.1.17 ATA verify command: A READ VERIFY SECTOR(S) or READ VERIFY SECTOR(S) EXT command defined in ATA/ATAPI-7.

3.1.18 ATA write command: One of the following ATA commands: WRITE DMA, WRITE DMA EXT, WRITE DMA FUA EXT, WRITE DMA QUEUED, WRITE DMA QUEUED EXT, WRITE DMA QUEUED FUA EXT, WRITE MULTIPLE, WRITE MULTIPLE EXT, WRITE MULTIPLE FUA EXT, WRITE SECTOR(S), or WRITE SECTOR(S) EXT defined in ATA/ATAPI-7; or WRITE FPDMA QUEUED defined in SATA 2.5.

3.1.19 ATA write FUA command sequence: A sequence of commands that writes logical blocks to an attached ATA device in a way that forces media access and consists of one of the following:

- a) a write followed by read verify command sequence as follows:
 - 1) a WRITE DMA, WRITE DMA EXT, WRITE DMA QUEUED, WRITE DMA QUEUED EXT, WRITE MULTIPLE, WRITE MULTIPLE EXT, WRITE SECTOR(S), or WRITE SECTOR(S) EXT command (see ATA/ATAPI-7) followed by
 - 2) a READ VERIFY SECTOR(S) or READ VERIFY SECTOR(S) EXT command (see ATA/ATAPI-7) accessing the same range of logical blocks written in the previous step;
- c) a WRITE DMA FUA EXT, WRITE DMA QUEUED FUA EXT, or WRITE MULTIPLE FUA EXT command (ATA/ATAPI-7), or
- d) a WRITE FPDMA QUEUED command (see SATA 2.5) with the FUA bit in the Device/Head field set to one.

See 5.3 for a description of multiple command sequence error handling.

3.1.20 auto-contingent allegiance (ACA): The task set condition established following the return of a CHECK CONDITION status when the NACA bit is set to one in the CONTROL byte. ¹⁴ Detailed definition of ACA may be found in SAM-3.

3.1.21 autosense: ¹⁵ Sense data that is returned in the same I_T_L_Q nexus transaction as the CHECK CONDITION status (see SAM-3). The alternative to autosense (i.e., use of a REQUEST SENSE command) is defined in SAM-2.

3.1.22 big-endian: A format for storage or transmission of binary data in which the most significant byte appears first. In a multi-byte value, the byte containing the most significant bit is stored in the lowest memory address and transmitted first and the byte containing the least significant bit is stored in the highest memory address and transmitted last (e.g., for the value 0080h, the byte containing 00h is stored in the lowest memory address and the byte containing 80h is stored in the highest memory address).

3.1.23 byte: A sequence of eight contiguous bits considered as a unit.

3.1.24 command descriptor block (CDB): A structure used to communicate a command from a SCSI application client to a SCSI device server.

3.1.25 device server: An object within the logical unit that processes SCSI tasks according to the rules for task management as described in SAM-3.

3.1.26 domain: A SCSI domain (see SAM-3) or an ATA domain (see ATA8-AAM).

3.1.27 DRQ data block: A unit of data words associated with available status when using either the PIO data-in command protocol or the PIO data-out command protocol (see ATA8-ACS)

3.1.28 field: A group of one or more contiguous bits.

3.1.29 first-party direct memory access (FPDMA): A method by which a device accesses host memory (see SATA 2.5).

~~¹⁶ **3.1.30 frame information structure (FIS):** The SATA frame format. ¹⁷ The payload of a frame, does not include the SOF, CRC, and EOF delimiters (see ATA/ATAPI-7).~~

Status
rlsheffi Completed 5/29/2006 10:56:32 AM

Sequence number: 14
Author: SIERLGC[BMartin]
Subject: Highlight
Date: 2/28/2006 3:55:11 PM

T Page 6, 3.1.20
change last sentence to "SAM-3 contains a detailed definition of ACA."
RESOLUTION:
(See SAM-3)

Status
rlsheffi Completed 5/29/2006 10:56:32 AM

Sequence number: 15
Author: MXO[MEvans]
Subject: Highlight
Date: 2/28/2006 4:07:22 PM

T 3.1.21 autosense: this term is not found in SAM-3, so this is a new definition unique to this standard, though the definition here is similar to the definition for "sense data" in SAM (except that the last phrase here is incorrect). However, the definition here does not reflect how the term is used in this standard. Change the definition to, "The ability for a SCSI target device to return sense data in the same I_T_L_Q nexus transaction as the CHECK CONDITION status (see SAM-3)."
REASON: Autosense is defined in SAM-2, and SAM-3 specifies what SAM-2 defines as autosense as returning SENSE data since the other method is not recognized. So this is the proper way to reference it. There should be an informative note to clarify what's going on.

RESOLUTION: add an informative note:

NOTE x - Autosense is defined in SAM-2. SAM-3 specifies what SAM-2 defines as autosense as the only valid way of returning SENSE data, but does not refer to it as autosense.

Status
rlsheffi Completed 5/29/2006 10:59:34 AM

Sequence number: 16
Author: INTC[RSheffield]
Subject: Cross-Out
Date: 2/28/2006 4:57:19 PM

T 3.1.30 frame information structure (FIS)
Delete this definition and put the reference to SATA 2.5 in the FIS entry in the acronym list.

Status
rlsheffi Completed 5/29/2006 11:01:14 AM

Sequence number: 17
Author: DELL[KMarks]
Subject: Cross-Out
Date: 5/29/2006 11:02:07 AM

T 3.1.30
Remove second sentence
"The payload of a frame, does not
include the SOF, CRC, and EOF delimiters"

Although part of ATA/ATAPI-7 definition, does not seem applicable to this standard.

RESOLUTION: Delete definition (FIS is in acronym list with appropriate reference).

Status
rlsheffi Completed 5/29/2006 11:02:13 AM

3.1.31 I_T nexus: A nexus ¹that exists between a SCSI initiator port and a SCSI target port (see SAM-3).

2 3.1.32 I_T_L nexus: A nexus that exists between a SCSI initiator port, a SCSI target port, and a logical unit. This relationship extends the prior I_T nexus (see SAM-3).

3 3.1.33 I_T_L_Q nexus: A nexus between a SCSI initiator port, a SCSI target port, a logical unit, and a queue tag following the successful receipt of a queue tag. This relationship replaces the prior I_T nexus or I_T_L nexus (see SAM-3).

3.1.34 least significant bit (LSB): In a binary code, the bit or bit position with the smallest numerical weighting in a group of bits that, when taken as a whole, represent a numerical value (e.g., in the number 0001b, the bit that is set to one).

3.1.35 link reset: Performing the link reset sequence.

4 3.1.36 link reset sequence: ⁵For SATA, a phy reset sequence. For PATA, a software reset as defined in ATA/ATAPI-7.

3.1.37 little-endian: A format for storage or transmission of binary data in which the least significant byte appears first. In a multi-byte value, the byte containing the least significant bit is stored in the lowest memory address and transmitted first and the byte containing the most significant bit is stored in the highest memory address and transmitted last (e.g., for the value 0080h, the byte containing 80h is stored in the lowest memory address and the byte containing 00h is stored in the highest memory address).

3.1.38 logical block address (LBA): The value used to reference a logical block.

3.1.39 logical unit number: An identifier for a ~~SCSI~~ logical unit.

3.1.40 logical unit reset event: An event that triggers a logical unit reset from a logical unit as described in SAM-3.

3.1.41 logical unit reset: A logical unit action in response to a logical unit reset event in which the logical unit performs the operations described in SAM-3.

3.1.42 logical unit: An externally addressable entity within a SCSI target device. See SAM-3 for a detailed definition of a logical unit.

3.1.43 medium: The material on which data is stored (e.g., a magnetic disk).

3.1.44 most significant bit (MSB): In a binary code, the bit or bit position with the largest numerical weighting in a group of bits that, when taken as a whole, represent a numerical value (e.g., in the number 1000b, the bit that is set to one).

3.1.45 native command queuing (NCQ): A method by which a device may maintain up to 32 outstanding commands concurrently and may order processing of those outstanding commands (see SATA 2.5). An ATA device indicates support for NCQ in IDENTIFY DEVICE information word 76, bit 8 (see ATA/ATAPI-7). ~~There is no enable or disable function.~~

3.1.46 nexus: A relationship between a SCSI initiator port and a SCSI target port that may extend to a logical unit and a task ~~tag~~ (see SAM-3).

3.1.47 object: An architectural abstraction or container that encapsulates data types, services, or other objects that are related in some way.

3.1.48 PATA bus: An interface that contains no more than two ATA/ATAPI devices connected by a single signal path using parallel signalling (see ATA/ATAPI-7).

Page: 27

Sequence number: 1
Author: DELL[KMarks]
Subject: Cross-Out
Date: 1/22/2006 6:01:10 PM

T 3.1.31
remove "that exists" from 1st sentence.

Status
r/sheffi Completed 5/29/2006 11:03:04 AM

Sequence number: 2
Author: DELL[KMarks]
Subject: Highlight
Date: 2/16/2006 10:15:29 AM

T 3.1.32
change
"3.1.32 I_T_L nexus: A nexus that exists between a SCSI initiator port, a SCSI target port, and a logical unit. This relationship extends the prior I_T nexus (see SAM-3)."
to
"3.1.32 I_T_L nexus: A nexus between a SCSI initiator port, a SCSI target port, and a logical unit (see SAM-3)."

Status
r/sheffi Completed 5/29/2006 11:04:44 AM

Sequence number: 3
Author: DELL[KMarks]
Subject: Highlight
Date: 2/16/2006 10:15:50 AM

T 3.1.33
Change
"3.1.33 I_T_L_Q nexus: A nexus between a SCSI initiator port, a SCSI target port, a logical unit, and a queue tag following the successful receipt of a queue tag. This relationship replaces the prior I_T nexus or I_T_L nexus (see SAM-3)."
to
"3.1.33 I_T_L_Q nexus: A nexus between a SCSI initiator port, a SCSI target port, a logical unit, and a task (see SAM-3)."

Status
r/sheffi Completed 5/29/2006 11:30:45 AM

Sequence number: 4
Author: DELL[KMarks]
Subject: Highlight
Date: 3/2/2006 8:39:15 PM

T 3.1.36
change
"3.1.36 link reset sequence: For SATA, a phy reset sequence. For PATA, a software reset as defined in ATA/ATAPI-7."
to
"3.1.36 link reset sequence: A phy reset sequence (see ATA/ATAPI-7)."

link reset or link reset sequence is never used with reference to PATA in spec.

RESOLUTION:

"3.1.36 link reset sequence: A phy reset sequence (see SATA 2.5)."

Status
r/sheffi Completed 5/29/2006 11:33:37 AM

Sequence number: 5
Author: MXO[MEvans]
Subject: Highlight
Date: 3/2/2006 8:38:04 PM

T 3.1.36 link reset sequence: change the definition to, "For SATA, a phy reset sequence (see SATA 2.5), or, for PATA, a software reset (see ATA/ATAPI-7)."
REASON: Accepted DELL comment which accounts for the fact that a link reset sequence isn't defined for PATA.

Status
r/sheffi Rejected 3/2/2006 8:37:00 PM

Comments from page 27 continued on next page

3.1.31 I_T nexus: A nexus ~~that exists~~ between a SCSI initiator port and a SCSI target port (see SAM-3).

3.1.32 I_T_L nexus: A nexus that exists between a SCSI initiator port, a SCSI target port, and a logical unit. This relationship extends the prior I_T nexus (see SAM-3).

3.1.33 I_T_L_Q nexus: A nexus between a SCSI initiator port, a SCSI target port, a logical unit, and a queue tag following the successful receipt of a queue tag. This relationship replaces the prior I_T nexus or I_T_L nexus (see SAM-3).

3.1.34 least significant bit (LSB): In a binary code, the bit or bit position with the smallest numerical weighting in a group of bits that, when taken as a whole, represent a numerical value (e.g., in the number 0001b, the bit that is set to one).

3.1.35 link reset: Performing the link reset sequence.

3.1.36 link reset sequence: For SATA, a phy reset sequence. For PATA, a software reset as defined in ATA/ATAPI-7.

3.1.37 little-endian: A format for storage or transmission of binary data in which the least significant byte appears first. In a multi-byte value, the byte containing the least significant bit is stored in the lowest memory address and transmitted first and the byte containing the most significant bit is stored in the highest memory address and transmitted last (e.g., for the value 0080h, the byte containing 80h is stored in the lowest memory address and the byte containing 00h is stored in the highest memory address).

3.1.38 logical block address (LBA): The value used to reference a logical block.

3.1.39 logical unit number: An identifier for a SCSI logical unit.

3.1.40 logical unit reset event: event that triggers a logical unit reset from a logical unit as described in SAM-3.

3.1.41 logical unit reset: A logical unit action in response to a logical unit reset event in which the logical unit performs the operations described in SAM-3.

3.1.42 logical unit: An externally addressable entity within a SCSI target device. See SAM-3 for a detailed definition of a logical unit.

3.1.43 medium: The material on which data is stored (e.g., a magnetic disk).

3.1.44 most significant bit (MSB): In a binary code, the bit or bit position with the largest numerical weighting in a group of bits that, when taken as a whole, represent a numerical value (e.g., in the number 1000b, the bit that is set to one).

3.1.45 native command queuing (NCQ): method by which a device may maintain up to 32 outstanding commands concurrently and may order processing of those outstanding commands (see SATA 2.5). An ATA device indicates support for NCQ in IDENTIFY DEVICE information word 76, bit 8 (see ATA/ATAPI-7). ~~There is no enable or disable function.~~

3.1.46 nexus: A relationship between a SCSI initiator port and a SCSI target port that may extend to a logical unit and a task-tag (see SAM-3).

3.1.47 object: An architectural abstraction or container that encapsulates data types, services, or other objects that are related in some way.

3.1.48 PATA bus: An interface that contains no more than two ATA/ATAPI devices connected by a single signal path using parallel signalling (see ATA/ATAPI-7).

Sequence number: 6
Author: MXO[MEvans]
Subject: Note
Date: 2/13/2006 2:06:17 PM

 3.1.3x Definitions: add a definition for logical block something like, "A set of user data words accessed and referenced as a unit."

Status
rlsheffi Completed 5/29/2006 11:37:02 AM

Sequence number: 7
Author: DELL[KMarks]
Subject: Cross-Out
Date: 1/22/2006 8:09:43 PM

 3.1.39
Remove "SCSI" from 1st Sentence

Status
rlsheffi Completed 5/29/2006 11:37:34 AM

Sequence number: 8
Author: HPQ[RElliott]
Subject: Highlight
Date: 2/1/2006 3:50:19 PM

 3.1.39
After "logical unit number" add "(LUN)"

Status
rlsheffi Completed 5/29/2006 11:37:54 AM

Sequence number: 9
Author: DELL[KMarks]
Subject: Highlight
Date: 3/3/2006 5:46:30 PM

 3.1.40
change in 1st sentence
"...unit reset from a logical..."
to
"...unit reset to a logical..."
REASON: Accepted MXO comment instead:
"An event that triggers a logical unit reset (see SAM-3)."

Status
rlsheffi Rejected 3/3/2006 5:46:34 PM

Sequence number: 10
Author: MXO[MEvans]
Subject: Highlight
Date: 2/15/2006 10:46:51 AM

 3.1.40 logical unit reset event: change the definition to, "An event that triggers a logical unit reset (see SAM-3)."

Status
rlsheffi Completed 5/29/2006 11:42:59 AM

Sequence number: 11
Author: DELL[KMarks]
Subject: Highlight
Date: 1/22/2006 8:52:48 PM

 3.1.41
change
"3.1.41 logical unit reset: A logical unit action in response to a logical unit reset event in which the logical unit performs the operations described in SAM-3."
to
"3.1.41 logical unit reset: A condition resulting from a hard reset condition or a logical unit reset event in which the logical unit performs the logical unit reset operations described in SAM-3, SPC-3, and this standard."

Status
rlsheffi Completed 5/29/2006 11:52:14 AM

Sequence number: 12
Author: MXO[MEvans]
Subject: Highlight
Date: 2/15/2006 10:50:22 AM

 3.1.45 native command queuing (NCQ): change the definition to, "A method by which a SATA device may maintain and order the

Comments from page 27 continued on next page

3.1.31 I_T nexus: A nexus ~~that exists~~ between a SCSI initiator port and a SCSI target port (see SAM-3).

3.1.32 I_T_L nexus: A nexus that exists between a SCSI initiator port, a SCSI target port, and a logical unit. This relationship extends the prior I_T nexus (see SAM-3).

3.1.33 I_T_L_Q nexus: A nexus between a SCSI initiator port, a SCSI target port, a logical unit, and a queue tag following the successful receipt of a queue tag. This relationship replaces the prior I_T nexus or I_T_L nexus (see SAM-3).

3.1.34 least significant bit (LSB): In a binary code, the bit or bit position with the smallest numerical weighting in a group of bits that, when taken as a whole, represent a numerical value (e.g., in the number 0001b, the bit that is set to one).

3.1.35 link reset: Performing the link reset sequence.

3.1.36 link reset sequence: For SATA, a phy reset sequence. For PATA, a software reset as defined in ATA/ATAPI-7.

3.1.37 little-endian: A format for storage or transmission of binary data in which the least significant byte appears first. In a multi-byte value, the byte containing the least significant bit is stored in the lowest memory address and transmitted first and the byte containing the most significant bit is stored in the highest memory address and transmitted last (e.g., for the value 0080h, the byte containing 80h is stored in the lowest memory address and the byte containing 00h is stored in the highest memory address).

3.1.38 logical block address (LBA): The value used to reference a logical block.

3.1.39 logical unit number: An identifier for a ~~SCSI~~ logical unit.

3.1.40 logical unit reset event: An event that triggers a logical unit reset from a logical unit as described in SAM-3.

3.1.41 logical unit reset: A logical unit action in response to a logical unit reset event in which the logical unit performs the operations described in SAM-3.

3.1.42 logical unit: An externally addressable entity within a SCSI target device. See SAM-3 for a detailed definition of a logical unit.

3.1.43 medium: The material on which data is stored (e.g., a magnetic disk).

3.1.44 most significant bit (MSB): In a binary code, the bit or bit position with the largest numerical weighting in a group of bits that, when taken as a whole, represent a numerical value (e.g., in the number 1000b, the bit that is set to one).

3.1.45 native command queuing (NCQ): A method by which a device may maintain up to 32 outstanding commands concurrently and may order processing of those outstanding commands (see SATA 2.5). An ATA device indicates support for NCQ in IDENTIFY DEVICE information word 76, bit 8 (see ATA/ATAPI-7). ~~There is no enable or disable function.~~

3.1.46 nexus: A relationship between a SCSI initiator port and a SCSI target port that may extend to a logical unit and a task (see SAM-3).

3.1.47 object: An architectural abstraction or container that encapsulates data types, services, or other objects that are related in some way.

3.1.48 PATA bus: interface that contains no more than two ATA/ATAPI devices connected by a single signal path using parallel signalling (see ATA/ATAPI-7).

processing of up to 32 outstanding commands (see SATA 2.5)."

Status
rlsheffi Completed 5/29/2006 12:10:48 PM

Sequence number: 13
Author: DELL[KMarks]
Subject: Cross-Out
Date: 3/3/2006 5:58:58 PM
T 3.1.45

Remove last sentence

"There is no enable or disable function."

REASON: Accepted MXO comment instead:

"A method by which a SATA device may maintain and order the processing of up to 32 outstanding commands (see SATA 2.5)."

Status
rlsheffi Rejected 3/3/2006 5:59:02 PM

Sequence number: 14
Author: DELL[KMarks]
Subject: Highlight
Date: 1/22/2006 8:21:29 PM
T 3.1.45

Change

"(see ATA/ATAPI-7)."

to

"(see SATA 2.5)."

word 76 is assigned to SATA in ATA/ATAPI-7

Status
rlsheffi Completed 5/29/2006 12:11:15 PM

Sequence number: 15
Author: DELL[KMarks]
Subject: Highlight
Date: 3/3/2006 6:01:03 PM
T 3.1.45

change

"information"

to

"data" in 2nd sentence to match rest of spec and add "ATA" in front of "IDENTIFY DEVICE"

REASON: Accepted MXO comment to delete the entire sentence.

Status
rlsheffi Rejected 3/3/2006 6:00:43 PM

Sequence number: 16
Author: HPQ[RElliott]
Subject: Highlight
Date: 3/3/2006 6:01:36 PM
T 3.1.45

"IDENTIFY DEVICE information" s/b "IDENTIFY DEVICE data"

REASON: Accepted MXO comment to delete the entire sentence.

Status
rlsheffi Rejected 3/3/2006 6:01:40 PM

Sequence number: 17
Author: DELL[KMarks]
Subject: Cross-Out
Date: 1/22/2006 8:12:18 PM
T 3.1.46

remove "tag" from 1st sentence.

Status
rlsheffi Completed 5/29/2006 12:12:13 PM

Sequence number: 18
Author: MXO[MEvans]

Comments from page 27 continued on next page

3.1.31 I_T nexus: A nexus ~~that exists~~ between a SCSI initiator port and a SCSI target port (see SAM-3).

3.1.32 I_T_L nexus: A nexus that exists between a SCSI initiator port, a SCSI target port, and a logical unit. This relationship extends the prior I_T nexus (see SAM-3).

3.1.33 I_T_L_Q nexus: A nexus between a SCSI initiator port, a SCSI target port, a logical unit, and a queue tag following the successful receipt of a queue tag. This relationship replaces the prior I_T nexus or I_T_L nexus (see SAM-3).

3.1.34 least significant bit (LSB): In a binary code, the bit or bit position with the smallest numerical weighting in a group of bits that, when taken as a whole, represent a numerical value (e.g., in the number 0001b, the bit that is set to one).

3.1.35 link reset: Performing the link reset sequence.

3.1.36 link reset sequence: For SATA, a phy reset sequence. For PATA, a software reset as defined in ATA/ATAPI-7.

3.1.37 little-endian: A format for storage or transmission of binary data in which the least significant byte appears first. In a multi-byte value, the byte containing the least significant bit is stored in the lowest memory address and transmitted first and the byte containing the most significant bit is stored in the highest memory address and transmitted last (e.g., for the value 0080h, the byte containing 80h is stored in the lowest memory address and the byte containing 00h is stored in the highest memory address).

3.1.38 logical block address (LBA): The value used to reference a logical block.

3.1.39 logical unit number: An identifier for a ~~SCSI~~ logical unit.

3.1.40 logical unit reset event: An event that triggers a logical unit reset from a logical unit as described in SAM-3.

3.1.41 logical unit reset: A logical unit action in response to a logical unit reset event in which the logical unit performs the operations described in SAM-3.

3.1.42 logical unit: An externally addressable entity within a SCSI target device. See SAM-3 for a detailed definition of a logical unit.

3.1.43 medium: The material on which data is stored (e.g., a magnetic disk).

3.1.44 most significant bit (MSB): In a binary code, the bit or bit position with the largest numerical weighting in a group of bits that, when taken as a whole, represent a numerical value (e.g., in the number 1000b, the bit that is set to one).

3.1.45 native command queuing (NCQ): A method by which a device may maintain up to 32 outstanding commands concurrently and may order processing of those outstanding commands (see SATA 2.5). An ATA device indicates support for NCQ in IDENTIFY DEVICE information word 76, bit 8 (see ATA/ATAPI-7). ~~There is no enable or disable function.~~

3.1.46 nexus: A relationship between a SCSI initiator port and a SCSI target port that may extend to a logical unit and a task ~~tag~~ (see SAM-3).

3.1.47 object: An architectural abstraction or container that encapsulates data types, services, or other objects that are related in some way.

3.1.48 PATA bus: An interface that contains no more than two ATA/ATAPI devices connected by a single signal path using parallel signalling (see ATA/ATAPI-7).

Subject: Highlight

Date: 5/29/2006 12:16:48 PM

T 3.1.48 PATA bus: change the definition to, "All of the conductors and connectors required to attain signal line continuity between every driver, receiver, and terminator for each signal between one PATA host and one or two PATA devices (see ATA/ATAPI-7)."

RESOLUTION: change to,

"All of the conductors and connectors required to attain signal line continuity between every driver, receiver, and terminator for each signal between one PATA host and one or two PATA devices (see ATA8-APT)."

DISCUSS: should reference ATA8-APT or ATA8-ACS?

Status

rlsheffi Completed

5/29/2006 12:16:04 PM

1.1.49 PATA device: ² storage device that uses the PATA transport (see ATA/ATAPI-7).

1.1.50 PATA host: ⁴ host that uses the PATA transport (see ATA/ATAPI-7).

3.1.51 power on: Power being applied.

3.1.52 queue: The arrangement of tasks within a task set usually according to the temporal order that they were created.

3.1.53 reset event: An event that triggers a hard reset from a SCSI initiator device (see SAM-3) or an ATA/ATAPI host (see ATA/ATAPI-7).

3.1.54 SAS address: A worldwide unique name assigned to a SAS initiator port, SAS target port, expander device, SAS initiator device, or SAS target device (see SAS-1.1).

3.1.55 SAS initiator device: A device containing SSP, STP, and/or SMP initiator ports in a SAS domain (see SAS-1.1).

3.1.56 SAS initiator port: An SSP initiator port, STP initiator port, and/or SMP initiator port in a SAS domain (see SAS-1.1).

3.1.57 SATA device: A device that implements a Serial ATA transport (see ATA/ATAPI-7).

3.1.58 SATA host: A host that implements a Serial ATA transport (see ATA/ATAPI-7).

~~**3.1.59 SATA 2.5:** A specification for the internal attachment of storage devices to hosts. See Serial ATA Revision 2.5.~~

3.1.60 SCSI / ATA translation layer (SATL): The functional layer that emulates a SCSI logical unit, device server, task manager, and task set (see SAM-3), using an ATA device.

3.1.61 SCSI device: A device that contains one or more SCSI ports that are connected to a service delivery subsystem and supports a SCSI application protocol.

3.1.62 SCSI hard reset: A condition resulting from a power on condition or a reset event in which the SCSI device performs the hard reset operations described in SAM-3, SPC-3, and the appropriate command standards.

3.1.63 SCSI initiator port: A SCSI initiator device object acts as the connection between application clients and the service delivery subsystem through which requests and responses are routed. See SAM-3 for a detailed definition of a SCSI initiator port.

3.1.64 SCSI read command: A SCSI-READ (6), READ (10), READ (12), or READ (16) command defined in SBC-2.

3.1.65 SCSI synchronize cache command: A SCSI-SYNCHRONIZE CACHE(10), or SYNCHRONIZE CACHE (16) command defined in SBC-2

3.1.66 SCSI target port: A SCSI target device object that contains a task router and acts as the connection between device servers and task managers and the service delivery subsystem through which requests and responses are routed. See SAM-3 for a detailed definition of a SCSI target port.

3.1.67 SCSI verify command: A SCSI VERIFY (10), VERIFY (12), or VERIFY (16) command defined in SBC-2.

3.1.68 SCSI write command: A SCSI WRITE (6), WRITE (10), WRITE (12), or WRITE (16) command defined in SBC-2.

Sequence number: 1
Author: DELL[KMarks]
Subject: Highlight
Date: 5/25/2006 3:40:07 PM

 3.1.49

change

"3.1.49 PATA device: A storage device that uses the PATA transport (see ATA/ATAPI-7)."

to

"3.1.49 PATA device: An storage device that uses the PATA transport protocol (see ATA/ATAPI-7)."

RESOLUTION: Combined with MXO comment - "3.1.49 PATA device: An ATA device or ATAPI device that uses the PATA transport protocol (see ATA8-APT)."

Status
rlsheffi Completed 5/29/2006 12:17:31 PM

Sequence number: 2
Author: MXO[MEvans]
Subject: Highlight
Date: 5/25/2006 8:02:11 AM

 3.1.49 PATA device: change the definition to, "An ATA/ATAPI device that implements the PATA transport (see ATA/ATAPI-7)."
RESOLUTION: Combined with MXO comment - "3.1.49 PATA device: An ATA device or ATAPI device that uses the PATA transport protocol (see ATA8-APT)."

Status
rlsheffi Completed 5/29/2006 12:17:43 PM

Sequence number: 3
Author: DELL[KMarks]
Subject: Highlight
Date: 5/25/2006 3:41:30 PM

 3.1.50

change

"3.1.50 PATA host: A host that uses the PATA transport (see ATA/ATAPI-7)."

to

"3.1.50 PATA host: An host that uses the PATA transport protocol (see ATA/ATAPI-7)."

RESOLUTION: "3.1.50 PATA host: An ATA host that uses the PATA transport protocol (see ATA8-APT)."

Status
rlsheffi Completed 5/29/2006 12:18:41 PM

Sequence number: 4
Author: MXO[MEvans]
Subject: Highlight
Date: 5/25/2006 8:02:39 AM

 3.1.49 PATA host: change the definition to, "An ATA host that implements the PATA transport (see ATA/ATAPI-7)."
RESOLUTION: "3.1.50 PATA host: An ATA host that uses the PATA transport protocol (see ATA8-APT)."

Status
rlsheffi Completed 5/29/2006 12:18:52 PM

Sequence number: 5
Author: EDITOR[rlsheffi]
Subject: Note
Date: 3/20/2006 12:32:56 PM

 Add the definition:

3.1.xx queued command: An ATA command that may be sent to an ATA device while the ATA device is processing another ATA command and is placed in the command queue of the ATA device. Also, a SCSI command received by the SATL from an application client for an emulated logical unit while the emulated logical unit is processing another SCSI command.

RESOLUTION:

3.1.xx queued command: An ATA queued command (see 3.1.xx), or a SCSI command received by the SATL from an application client for an emulated logical unit while the emulated logical unit is processing another SCSI command (see SAM-3).

TO DO: add definition

Status
rlsheffi Completed 5/29/2006 12:20:47 PM

3.1.49 PATA device: A storage device that uses the PATA transport (see ATA/ATAPI-7).

3.1.50 PATA host: A host that uses the PATA transport (see ATA/ATAPI-7).

3.1.51 power on: Power being applied.

3.1.52 queue: The arrangement of tasks within a task set usually according to the temporal order that they were created.

3.1.53 reset event: An event that triggers a hard reset from a SCSI initiator device (see SAM-3) or an ATA/ATAPI host (see ATA/ATAPI-7).

3.1.54 SAS address: A worldwide unique name assigned to a SAS initiator port, SAS target port, expander device, SAS initiator device, or SAS target device (see SAS-1.1).

3.1.55 SAS initiator device: A device containing SSP, STP, and/or SMP initiator ports in a SAS domain (see SAS-1.1).

3.1.56 SAS initiator port: An SSP initiator port, STP initiator port, and/or SMP initiator port in a SAS domain (see SAS-1.1).

3.1.57 SATA device: A device that implements a Serial ATA transport (see ATA/ATAPI-7).

3.1.58 SATA host: A host that implements a Serial ATA transport (see ATA/ATAPI-7).

~~3.1.59 SATA 2.5:~~ A specification for the internal attachment of storage devices to hosts. See Serial ATA Revision 2.5.

3.1.60 SCSI / ATA translation layer (SATL): The functional layer that emulates a SCSI logical unit, device server, task manager, and task set (see SAM-3), using an ATA device.

3.1.61 SCSI device: A device that contains one or more SCSI ports that are connected to a service delivery subsystem and supports a SCSI application protocol.

3.1.62 SCSI hard reset: A condition resulting from a power on condition or a reset event in which the SCSI device performs the hard reset operations described in SAM-3, SPC-3, and the appropriate command standards.

3.1.63 SCSI initiator port: A SCSI initiator device object acts as the connection between application clients and the service delivery subsystem through which requests and responses are routed. See SAM-3 for a detailed definition of a SCSI initiator port.

3.1.64 SCSI read command: A SCSI-READ (6), READ (10), READ (12), or READ (16) command defined in SBC-2.

3.1.65 SCSI synchronize cache command: A SCSI-SYNCHRONIZE CACHE(10), or SYNCHRONIZE CACHE (16) command defined in SBC-2.

3.1.66 SCSI target port: A SCSI target device object that contains a task router and acts as the connection between device servers and task managers and the service delivery subsystem through which requests and responses are routed. See SAM-3 for a detailed definition of a SCSI target port.

3.1.67 SCSI verify command: A SCSI VERIFY (10), VERIFY (12), or VERIFY (16) command defined in SBC-2.

3.1.68 SCSI write command: A SCSI WRITE (6), WRITE (10), WRITE (12), or WRITE (16) command defined in SBC-2.

Sequence number: 6
Author: EDITOR[risheffi]
Subject: Note
Date: 3/20/2006 1:06:46 PM

 Add the definition:

3.1.xx non-queued command: A valid ATA command which causes the ATA device to report an error because it is sent to an ATA device while the ATA device is processing another ATA command or has one or more commands in its command queue.

RESOLUTION:

3.1.xx ATA non-queued command:

An ATA command that is not an ATA queued command (see 3.1.xx).

3.1.xx non-queued command:

An ATA non-queued command (see 3.1.xx).

Status
risheffi Completed 5/29/2006 12:25:25 PM

Sequence number: 7
Author: MXO[MEvans]
Subject: Highlight
Date: 5/25/2006 8:31:54 AM

 3.1.53 reset event: change the definition to, "A transport protocol specific event that results in a hard reset condition (see SAM-3 and ATA/ATAPI-7)."

RESOLUTION: change to,

"A transport protocol specific event that results in a hard reset condition (see SAM-3) or a hardware reset (see ATA8-AAM)."

Status
risheffi Completed 5/29/2006 12:56:09 PM

Sequence number: 8
Author: DELL[KMarks]
Subject: Highlight
Date: 1/22/2006 9:13:12 PM

 3.1.54
change
"...unique name assigned..."

to

"...unique name or identifier assigned..."

Status
risheffi Completed 5/29/2006 12:57:03 PM

Sequence number: 9
Author: DELL[KMarks]
Subject: Highlight
Date: 5/25/2006 8:36:04 AM

 3.1.57
change
"3.1.57 SATA device: A device that implements a Serial ATA transport (see ATA/ATAPI-7)."

to

"3.1.57 SATA device: An storage device that uses the Serial ATA transport protocol (see ATA/ATAPI-7)."

RESOLUTION: "3.1.57 SATA device: An ATA device or ATAPI device that uses the Serial ATA transport protocol (see SATA 2.5)."

Status
risheffi Completed 5/29/2006 12:58:20 PM

Sequence number: 10
Author: MXO[MEvans]
Subject: Highlight
Date: 5/25/2006 8:35:30 AM

 3.1.57 SATA device: change the definition to, "An ATA/ATAPI device that implements the Serial ATA transport (see ATA/ATAPI-7)."

RESOLUTION: "3.1.57 SATA device: An ATA device or ATAPI device that uses the Serial ATA transport protocol (see SATA 2.5)."

Status
risheffi Completed 5/29/2006 12:58:47 PM

Sequence number: 11
Author: DELL[KMarks]
Subject: Highlight
Date: 5/25/2006 3:42:55 PM

 3.1.58
change

"3.1.58 SATA host: A host that implements a Serial ATA transport (see ATA/ATAPI-7)."

Comments from page 28 continued on next page

3.1.49 PATA device: A storage device that uses the PATA transport (see ATA/ATAPI-7).

3.1.50 PATA host: A host that uses the PATA transport (see ATA/ATAPI-7).

3.1.51 power on: Power being applied.

3.1.52 queue: The arrangement of tasks within a task set usually according to the temporal order that they were created.

3.1.53 reset event: An event that triggers a hard reset from a SCSI initiator device (see SAM-3) or an ATA/ATAPI host (see ATA/ATAPI-7).

3.1.54 SAS address: A worldwide unique name assigned to a SAS initiator port, SAS target port, expander device, SAS initiator device, or SAS target device (see SAS-1.1).

3.1.55 SAS initiator device: A device containing SSP, STP, and/or SMP initiator ports in a SAS domain (see SAS-1.1).

3.1.56 SAS initiator port: An SSP initiator port, STP initiator port, and/or SMP initiator port in a SAS domain (see SAS-1.1).

3.1.57 SATA device: A device that implements a Serial ATA transport (see ATA/ATAPI-7).

3.1.58 SATA host: ¹²host that implements a Serial ATA transport (see ATA/ATAPI-7).

~~**3.1.59 SATA 2.5:** A specification for the internal attachment of storage devices to hosts. See Serial ATA Revision 2.5.~~

3.1.60 SCSI / ATA translation layer (SATL): ¹⁵functional layer that emulates a SCSI logical unit, device server, task manager, and task set (see SAM-3), using an ATA device.

3.1.61 SCSI device: A device that contains one or more SCSI ports that are connected to a service delivery subsystem and supports a SCSI application protocol.

3.1.62 SCSI hard reset: ¹⁶condition resulting from a power on condition or a reset event in which the SCSI device performs the hard reset operations described in SAM-3, SPC-3, and the appropriate command standards.

3.1.63 SCSI initiator port: ¹⁷SCSI initiator device object acts as the connection between application clients and the service delivery subsystem through which requests and responses are routed. See SAM-3 for a detailed definition of a SCSI initiator port.

~~**3.1.64 SCSI read command:** A SCSI-READ (6), READ (10), READ (12), or READ (16) command defined in SBC-2.~~

~~**3.1.65 SCSI synchronize cache command:** -A SCSI-SYNCHRONIZE CACHE(10), or SYNCHRONIZE CACHE (16) command defined in SBC-2~~

3.1.66 SCSI target port: A SCSI target device object that contains a task router and acts as the connection between device servers and task managers and the service delivery subsystem through which requests and responses are routed. See SAM-3 for a detailed definition of a SCSI target port.

~~**3.1.67 SCSI verify command:** -A SCSI VERIFY (10), VERIFY (12), or VERIFY (16) command defined in SBC-2.~~

~~**3.1.68 SCSI write command:** -A SCSI WRITE (6), WRITE (10), WRITE (12), or WRITE (16) command defined in SBC-2.~~

to
"3.1.58 SATA host: An host that implements a Serial ATA transport protocol (see ATA/ATAPI-7)."
RESOLUTION: "3.1.58 SATA host: An ATA host that implements the Serial ATA transport protocol (see SATA 2.5)."

Status
rlsheffi Completed 5/29/2006 12:59:29 PM

Sequence number: 12
Author: MXO[MEvans]
Subject: Highlight
Date: 5/25/2006 8:36:48 AM

T 3.1.58 SATA host: change the definition to, "An ATA host that implements the Serial ATA transport (see ATA/ATAPI-7)."
RESOLUTION: "3.1.58 SATA host: An ATA host that implements the Serial ATA transport protocol (see SATA 2.5)."

Status
rlsheffi Completed 5/29/2006 12:59:44 PM

Sequence number: 13
Author: DELL[KMarks]
Subject: Cross-Out
Date: 1/22/2006 9:52:03 PM

T 3.1.59 SATA 2.5

Remove definition, already in references and acronyms.

Status
rlsheffi Completed 5/29/2006 1:00:36 PM

Sequence number: 14
Author: INTC[RSheffield]
Subject: Note
Date: 5/29/2006 1:05:23 PM

! Add:

3.1.xx SCSI / ATA translation (SAT): A standard defining the translation of SCSI commands and responses to ATA commands and responses (i.e., this standard).

Status
rlsheffi Completed 5/29/2006 1:01:40 PM

Sequence number: 15
Author: MXO[MEvans]
Subject: Highlight
Date: 2/7/2006 11:01:28 AM

T 3.1.60 SCSI /ATA translation layer (SATL): change the definition to, "The functional layer defined in this standard that uses an ATA device to emulate objects in a SCSI logical unit, including the device server, task manager, and task set (see SAM-3)."

Status
rlsheffi Completed 5/29/2006 1:02:38 PM

Sequence number: 16
Author: MXO[MEvans]
Subject: Highlight
Date: 2/15/2006 11:41:07 AM

T 3.1.62 SCSI hard reset: even though this is the definition in SPC, a bit is omitted, and that's what happens at the transport layer. So, change the definition to, "A condition resulting from a power on condition or a reset event in which the SCSI device performs the hard reset operations described in SAM-3, SPC-3, and the appropriate command and transport standards."

Status
rlsheffi Completed 5/29/2006 1:03:44 PM

Sequence number: 17
Author: MXO[MEvans]
Subject: Highlight
Date: 2/7/2006 11:13:30 AM

T 3.1.63 SCSI initiator port: change the definition to, "A SCSI initiator device object that acts as the connection between application clients and the service delivery subsystem through which requests and responses are routed (see SAM-3)."

Status
rlsheffi Completed 5/29/2006 1:04:45 PM

Sequence number: 18
Author: IBM[GPenokie]
Subject: Underline
Date: 2/16/2006 1:44:42 PM

T 3.1.64 SCSI read command:

Comments from page 28 continued on next page

3.1.49 PATA device: A storage device that uses the PATA transport (see ATA/ATAPI-7).

3.1.50 PATA host: A host that uses the PATA transport (see ATA/ATAPI-7).

3.1.51 power on: Power being applied.

3.1.52 queue: The arrangement of tasks within a task set usually according to the temporal order that they were created.

3.1.53 reset event: An event that triggers a hard reset from a SCSI initiator device (see SAM-3) or an ATA/ATAPI host (see ATA/ATAPI-7).

3.1.54 SAS address: A worldwide unique name assigned to a SAS initiator port, SAS target port, expander device, SAS initiator device, or SAS target device (see SAS-1.1).

3.1.55 SAS initiator device: A device containing SSP, STP, and/or SMP initiator ports in a SAS domain (see SAS-1.1).

3.1.56 SAS initiator port: An SSP initiator port, STP initiator port, and/or SMP initiator port in a SAS domain (see SAS-1.1).

3.1.57 SATA device: A device that implements a Serial ATA transport (see ATA/ATAPI-7).

3.1.58 SATA host: A host that implements a Serial ATA transport (see ATA/ATAPI-7).

~~**3.1.59 SATA 2.5:** A specification for the internal attachment of storage devices to hosts. See Serial ATA Revision 2.5.~~

3.1.60 SCSI / ATA translation layer (SATL): The functional layer that emulates a SCSI logical unit, device server, task manager, and task set (see SAM-3), using an ATA device.

3.1.61 SCSI device: A device that contains one or more SCSI ports that are connected to a service delivery subsystem and supports a SCSI application protocol.

3.1.62 SCSI hard reset: A condition resulting from a power on condition or a reset event in which the SCSI device performs the hard reset operations described in SAM-3, SPC-3, and the appropriate command standards.

3.1.63 SCSI initiator port: A SCSI initiator device object acts as the connection between application clients and the service delivery subsystem through which requests and responses are routed. See SAM-3 for a detailed definition of a SCSI initiator port.

3.1.64 SCSI read command: ²¹20 SCSI READ (6), READ (10), READ (12), or READ (16) command defined in SBC-2.

3.1.65 SCSI synchronize cache command: ²⁴23 s ²⁶ SYNCHRONIZE CACHE(10), or SYNCHRONIZE CACHE (16) command defined in SBC-2

3.1.66 SCSI target port: A SCSI target device object that contains a task router and acts as the connection between device servers and task managers and the service delivery subsystem through which requests and responses are routed. See SAM-3 for a detailed definition of a SCSI target port.

3.1.67 SCSI verify command: A SCSI VERIFY (10), VERIFY (12), or VERIFY (16) command defined in SBC-2.

3.1.68 SCSI write command: A SCSI WRITE (6), WRITE (10), WRITE (12), or WRITE (16) command defined in SBC-2.

Status

rlsheffi Cancelled 3/4/2006 11:24:55 AM

Sequence number: 19

Author: DELL[KMarks]

Subject: Cross-Out

Date: 2/16/2006 10:39:16 AM

T 3.1.64 remove "SCSI" in definition.

Status

rlsheffi Completed 5/29/2006 1:06:08 PM

Sequence number: 20

Author: IBM[GPenokie]

Subject: Highlight

Date: 5/29/2006 1:07:10 PM

T All the command names need to have the term << command >> after them.

REASON: Feb 28, 2006 SAT WG thought it was too wordy with << command >> before each command.

Status

rlsheffi Rejected 5/29/2006 1:06:25 PM

Sequence number: 21

Author: MXO[MEvans]

Subject: Highlight

Date: 5/29/2006 1:08:05 PM

T 3.1.64 SCSI read command: change the definition to, "A READ (6), READ (10), READ (12), or READ (16) command (see SBC-2)."

Status

rlsheffi Completed 5/29/2006 1:08:25 PM

Sequence number: 22

Author: IBM[GPenokie]

Subject: Underline

Date: 2/16/2006 1:45:13 PM

T 3.1.65 SCSI synchronize cache command:

Status

rlsheffi Cancelled 3/4/2006 11:27:48 AM

Sequence number: 23

Author: DELL[KMarks]

Subject: Cross-Out

Date: 5/29/2006 1:13:47 PM

T 3.1.65 remove "SCSI" in definition.

RESOLUTION: See MXO comment.

Status

rlsheffi Completed 5/29/2006 1:11:08 PM

Sequence number: 24

Author: STX[GHolder]

Subject: Cross-Out

Date: 5/29/2006 1:09:48 PM

T PDF page 25 and 28

section 3.1.65

Remove the period that precedes the text

".If the ..."

Status

rlsheffi Completed 5/29/2006 1:09:51 PM

Sequence number: 25

Author: DELL[KMarks]

Subject: Highlight

Date: 5/29/2006 1:11:31 PM

T 3.1.65

"3.1.65 SCSI synchronize cache command: A ..."

remove leading period

Status

rlsheffi Completed 5/29/2006 1:11:34 PM

Sequence number: 26

Author: IBM[GPenokie]

Comments from page 28 continued on next page

3.1.49 PATA device: A storage device that uses the PATA transport (see ATA/ATAPI-7).

3.1.50 PATA host: A host that uses the PATA transport (see ATA/ATAPI-7).

3.1.51 power on: Power being applied.

3.1.52 queue: The arrangement of tasks within a task set usually according to the temporal order that they were created.

3.1.53 reset event: An event that triggers a hard reset from a SCSI initiator device (see SAM-3) or an ATA/ATAPI host (see ATA/ATAPI-7).

3.1.54 SAS address: A worldwide unique name assigned to a SAS initiator port, SAS target port, expander device, SAS initiator device, or SAS target device (see SAS-1.1).

3.1.55 SAS initiator device: A device containing SSP, STP, and/or SMP initiator ports in a SAS domain (see SAS-1.1).

3.1.56 SAS initiator port: An SSP initiator port, STP initiator port, and/or SMP initiator port in a SAS domain (see SAS-1.1).

3.1.57 SATA device: A device that implements a Serial ATA transport (see ATA/ATAPI-7).

3.1.58 SATA host: A host that implements a Serial ATA transport (see ATA/ATAPI-7).

~~**3.1.59 SATA 2.5:** A specification for the internal attachment of storage devices to hosts. See Serial ATA Revision 2.5.~~

3.1.60 SCSI / ATA translation layer (SATL): The functional layer that emulates a SCSI logical unit, device server, task manager, and task set (see SAM-3), using an ATA device.

3.1.61 SCSI device: A device that contains one or more SCSI ports that are connected to a service delivery subsystem and supports a SCSI application protocol.

3.1.62 SCSI hard reset: A condition resulting from a power on condition or a reset event in which the SCSI device performs the hard reset operations described in SAM-3, SPC-3, and the appropriate command standards.

3.1.63 SCSI initiator port: A SCSI initiator device object acts as the connection between application clients and the service delivery subsystem through which requests and responses are routed. See SAM-3 for a detailed definition of a SCSI initiator port.

3.1.64 SCSI read command: A SCSI-READ (6), READ (10), READ (12), or READ (16) command defined in SBC-2.

3.1.65 SCSI synchronize cache command: ²⁷SCSI-SYNCHRONIZE CACHE(10), or SYNCHRONIZE CACHE (16) command defined in SBC-2

3.1.66 SCSI target port: A SCSI target device object that contains a task router and acts as the connection between device servers and task managers and the service delivery subsystem through which requests and responses are ²⁸ routed. See SAM-3 for a detailed definition of a SCSI target port.

3.1.67 SCSI verify command: ³¹³³SCSI VERIFY (10), VERIFY (12), or VERIFY (16) command defined in SBC-2.

3.1.68 SCSI write command: A SCSI WRITE (6), WRITE (10), WRITE (12), or WRITE (16) command defined in SBC-2.

Subject: Highlight
Date: 5/29/2006 1:12:58 PM

T All the command names need to have the term << command >> after them.
REASON: Feb 28, 2006 SAT WG indicated this style is too wordy.

Status
rlsheffi Rejected 5/29/2006 1:12:17 PM

Sequence number: 27
Author: MXO[MEvans]
Subject: Highlight
Date: 5/29/2006 1:10:45 PM

T 3.1.65 SCSI synchronize cache command: change the definition to, "A SYNCHRONIZE CACHE(10) or SYNCHRONIZE CACHE (16) command (see SBC-2)."

Status
rlsheffi Completed 5/29/2006 1:13:25 PM

Sequence number: 28
Author: MXO[MEvans]
Subject: Highlight
Date: 2/7/2006 11:19:01 AM

T 3.1.66 SCSI target port: change, "...routed. See SAM-3 for a detailed definition of a SCSI target port.", to, "...routed (see SAM-3)."

Status
rlsheffi Completed 5/29/2006 1:15:15 PM

Sequence number: 29
Author: IBM[GPenokie]
Subject: Underline
Date: 2/16/2006 1:45:40 PM

T 3.1.67 SCSI verify command:

Status
rlsheffi Cancelled 3/4/2006 11:44:49 AM

Sequence number: 30
Author: DELL[KMarks]
Subject: Cross-Out
Date: 3/4/2006 11:47:29 AM

T 3.1.67 remove "SCSI" in definition.
RESOLUTION: See MXO comment.

Status
rlsheffi Completed 5/29/2006 1:15:39 PM

Sequence number: 31
Author: STX[GHolder]
Subject: Cross-Out
Date: 3/4/2006 11:47:13 AM

T PDF page 25 and 28

T section 3.1.67
Remove the period that precedes the text
".If the ..."
RESOLUTION: See MXO comment.

Status
rlsheffi Completed 5/29/2006 1:16:03 PM

Sequence number: 32
Author: DELL[KMarks]
Subject: Highlight
Date: 3/4/2006 11:47:05 AM

T 3.1.67

"3.1.67 SCSI verify command: A SCSI"

Remove leading period
RESOLUTION: See MXO comment.

Status
rlsheffi Completed 5/29/2006 1:16:17 PM

Sequence number: 33
Author: IBM[GPenokie]

Comments from page 28 continued on next page

3.1.49 PATA device: A storage device that uses the PATA transport (see ATA/ATAPI-7).

3.1.50 PATA host: A host that uses the PATA transport (see ATA/ATAPI-7).

3.1.51 power on: Power being applied.

3.1.52 queue: The arrangement of tasks within a task set usually according to the temporal order that they were created.

3.1.53 reset event: An event that triggers a hard reset from a SCSI initiator device (see SAM-3) or an ATA/ATAPI host (see ATA/ATAPI-7).

3.1.54 SAS address: A worldwide unique name assigned to a SAS initiator port, SAS target port, expander device, SAS initiator device, or SAS target device (see SAS-1.1).

3.1.55 SAS initiator device: A device containing SSP, STP, and/or SMP initiator ports in a SAS domain (see SAS-1.1).

3.1.56 SAS initiator port: An SSP initiator port, STP initiator port, and/or SMP initiator port in a SAS domain (see SAS-1.1).

3.1.57 SATA device: A device that implements a Serial ATA transport (see ATA/ATAPI-7).

3.1.58 SATA host: A host that implements a Serial ATA transport (see ATA/ATAPI-7).

~~**3.1.59 SATA 2.5:** A specification for the internal attachment of storage devices to hosts. See Serial ATA Revision 2.5.~~

3.1.60 SCSI / ATA translation layer (SATL): The functional layer that emulates a SCSI logical unit, device server, task manager, and task set (see SAM-3), using an ATA device.

3.1.61 SCSI device: A device that contains one or more SCSI ports that are connected to a service delivery subsystem and supports a SCSI application protocol.

3.1.62 SCSI hard reset: A condition resulting from a power on condition or a reset event in which the SCSI device performs the hard reset operations described in SAM-3, SPC-3, and the appropriate command standards.

3.1.63 SCSI initiator port: A SCSI initiator device object acts as the connection between application clients and the service delivery subsystem through which requests and responses are routed. See SAM-3 for a detailed definition of a SCSI initiator port.

3.1.64 SCSI read command: A SCSI-READ (6), READ (10), READ (12), or READ (16) command defined in SBC-2.

3.1.65 SCSI synchronize cache command: A SCSI-SYNCHRONIZE CACHE(10), or SYNCHRONIZE CACHE (16) command defined in SBC-2

3.1.66 SCSI target port: A SCSI target device object that contains a task router and acts as the connection between device servers and task managers and the service delivery subsystem through which requests and responses are routed. See SAM-3 for a detailed definition of a SCSI target port.

3.1.67 SCSI verify command: ³⁴SCSI VERIFY (10), VERIFY (12), or VERIFY (16) command defined in SBC-2.

3.1.68 SCSI write command: ³⁹³⁸SI WRITE (6), WRITE (10), WRITE (12), or WRITE (16) command defined in SBC-2.

Subject: Highlight
Date: 5/29/2006 1:16:55 PM

T All the command names need to have the term << command >> after them.
REASON: The Feb 28, 2006 SAT WG indicated it would be too wordy.

Status
rlsheffi Completed 5/29/2006 1:16:58 PM

Sequence number: 34
Author: MXO[MEvans]
Subject: Highlight
Date: 5/29/2006 1:17:39 PM

T 3.1.67 SCSI verify command: change the definition to, "A VERIFY (10), VERIFY (12), or VERIFY (16) command (see SBC-2)."

Status
rlsheffi Completed 5/29/2006 1:17:59 PM

Sequence number: 35
Author: IBM[GPenokie]
Subject: Underline
Date: 2/16/2006 1:46:05 PM

T 3.1.68 SCSI write command:

Status
rlsheffi Cancelled 3/4/2006 11:52:15 AM

Sequence number: 36
Author: STX[GHolder]
Subject: Cross-Out
Date: 3/4/2006 11:55:13 AM

T PDF page 25 and 28

section 3.1.68
Remove the period that precedes the text
".If the ..."
RESOLUTION: See MXO comment.

Status
rlsheffi Completed 5/29/2006 1:18:57 PM

Sequence number: 37
Author: DELL[KMarks]
Subject: Highlight
Date: 3/4/2006 11:54:59 AM

T 3.1.68

"3.1.68 SCSI write command: A SCSI WRITE"

Remove leading period and "SCSI" from definition.
RESOLUTION: See MXO comment.

Status
rlsheffi Completed 5/29/2006 1:19:23 PM

Sequence number: 38
Author: IBM[GPenokie]
Subject: Highlight
Date: 5/29/2006 1:19:52 PM

T All the command names need to have the term << command >> after them.
REASON: The Feb 28, 2006 SAT WG indicated it would be too wordy.

Status
rlsheffi Rejected 5/29/2006 1:19:56 PM

Sequence number: 39
Author: MXO[MEvans]
Subject: Highlight
Date: 5/29/2006 1:20:18 PM

T 3.1.68 SCSI write command: change the definition to, "A WRITE (6), WRITE (10), WRITE (12), or WRITE (16) command (see SBC-2)."

Status
rlsheffi Completed 5/29/2006 1:20:22 PM

2.1.69 SCSI write and verify command: **5.4** SCSI WRITE AND VERIFY (10), WRITE AND **3** ERIFY(12), or WRITE AND VERIFY (16) command defined in SBC-2.

6.1.70 Serial ATA (SATA): A protocol defined by ATA/ATAPI-7.

3.1.71 Serial ATA Tunneled Protocol (STP): The protocol defined in this standard used by STP initiator ports to communicate with STP target ports in a SAS domain.

3.1.72 Serial Attached SCSI (SAS): A set of protocols and the interconnect defined by SAS-1.1.

3.1.73 service delivery subsystem: The part of a SCSI I/O system that transmits information between a SCSI initiator port and a SCSI target port, or the part of an ATA I/O system that transmits information between an ATA host and an ATA/ATAPI device, or the part of a SAS I/O system that transmits information between a SAS initiator port and a SAS target port (see SAM-3 and SAS-1.1).

3.1.74 STP initiator port: A SAS initiator device object in a SAS domain that interfaces to the service delivery subsystem with STP (see SAS-1.1).

3.1.75 STP target port: A SAS target device object in a SAS domain that interfaces to the service delivery subsystem with STP (see SAS-1.1).

3.1.76 STP/SATA bridge: An expander device object containing an STP target port, a SATA host port, and the functions required to forward information between the STP target port and SATA host port to enable STP initiator ports in a SAS domain to communicate with SATA devices in an ATA domain (see SAS-1.1).

3.1.77 task management function: A task manager service capable of being requested by an application client to affect the processing of **one or more tasks.**

3.1.78 task set: A group of tasks within a device server whose interaction is dependent on the task management and auto-contingent **allegiance rules.** See SAM-3 for a detailed definition of a task set.

3.1.79 task: ~~An object within the logical unit representing the work associated with a command or group of linked commands. A task consists of one initial connection and zero or more physical or logical reconnections, all pertaining to the task.~~

3.1.80 tagged command queuing (TCQ): A method that makes use of the ATA/ATAPI-7 Queued feature set by which an ATA device may maintain up to 32 outstanding commands concurrently, may order processing of those outstanding commands, and identifies the context of each outstanding command with a unique Tag (see ATA/ATAPI-7). An ATA device indicates support for the Queued feature set in IDENTIFY DEVICE data word 83, bit 1 (see ATA/ATAPI-7). An ATA device indicates the number of commands that may be queued at one time in IDENTIFY DEVICE data word 75, bits 4:0 (see ATA/ATAPI-7).

3.1 vendor-specific: Something (e.g., a bit, field, code value) that is not defined by this standard and may be used differently in various implementations.

3.1.82 word: A sequence of two contiguous bytes considered as a unit.

3.2 Symbols and abbreviations

≠ or NE	not equal
≤ or LE	less than or equal to
±	plus or minus
≈	approximately
x	multiply
+	add
-	subtract
< or LT	less than

Sequence number: 1
Author: IBM[GPenokie]
Subject: Underline
Date: 2/16/2006 1:29:43 PM
T 3.1.69 SCSI write and verify command:

Status
rsheffi Cancelled 3/4/2006 11:55:38 AM

Sequence number: 2
Author: DELL[KMarks]
Subject: Highlight
Date: 3/4/2006 11:59:19 AM
T 3.1.69

"3.1.69 SCSI write and verify command: A SCSI"

Remove leading period and "SCSI" from definition.
RESOLUTION: See MXO comment.

Status
rsheffi Completed 5/29/2006 1:21:13 PM

Sequence number: 3
Author: HPQ[RElliott]
Subject: Highlight
Date: 3/4/2006 11:59:03 AM
T 3.1.69

Add space to VERIFY(12)
RESOLUTION: See MXO comment.

Status
rsheffi Completed 5/29/2006 1:21:35 PM

Sequence number: 4
Author: IBM[GPenokie]
Subject: Highlight
Date: 5/29/2006 1:22:02 PM
T All the command names need to have the term << command >> after them.
REASON: The Feb 28, 2006 SAT WG indicated it would be too wordy.

Status
rsheffi Rejected 5/29/2006 1:21:50 PM

Sequence number: 5
Author: MXO[MEvans]
Subject: Highlight
Date: 5/29/2006 1:22:27 PM
T 3.1.69 SCSI write and verify command: change the definition to, "A WRITE AND VERIFY (10), WRITE AND VERIFY(12), or WRITE AND VERIFY (16) command (see SBC-2)."

Status
rsheffi Completed 5/29/2006 1:22:31 PM

Sequence number: 6
Author: DELL[KMarks]
Subject: Highlight
Date: 5/29/2006 1:24:09 PM
T 3.1.70

change
"3.1.70 Serial ATA (SATA): A protocol defined by ATA/ATAPI-7."
to
"3.1.70 Serial ATA (SATA): A transport serial protocol (see SATA 2.5)."
RESOLUTION: change to,
"3.1.70 Serial ATA (SATA): A serial transport protocol (see SATA 2.5)."

Status
rsheffi Completed 5/29/2006 1:24:12 PM

3.1.69 SCSI write and verify command: A SCSI WRITE AND VERIFY (10), WRITE AND VERIFY(12), or WRITE AND VERIFY (16) command defined in SBC-2.

3.1.70 Serial ATA (SATA): ⁷ protocol defined by ATA/ATAPI-7.

3.1.71 Serial ATA Tunneled Protocol (STP): ⁸ ¹⁰ protocol defined ⁹ in this standard used by STP initiator ports to communicate with STP target ports in a SAS domain.

3.1.72 Serial Attached SCSI (SAS): A set of protocols and the interconnect defined by SAS-1.1.

3.1.73 service delivery subsystem: ¹¹ part of a SCSI I/O system that transmits information between a SCSI initiator port and a SCSI target port, or the part of an ATA I/O system that transmits information between an ATA host and an ATA/ATAPI device, or the part of a SAS I/O system that transmits information between a SAS initiator port and a SAS target port (see SAM-3 and SAS-1.1).

3.1.74 STP initiator port: A SAS initiator device object in a SAS domain that interfaces to the service delivery subsystem with STP (see SAS-1.1).

3.1.75 STP target port: A SAS target device object in a SAS domain that interfaces to the service delivery subsystem with STP (see SAS-1.1).

3.1.76 STP/SATA bridge: An expander device object containing an STP target port, a SATA host port, and the functions required to forward information between the STP target port and SATA host port to enable STP initiator ports in a SAS domain to communicate with SATA devices in an ATA domain (see SAS-1.1).

3.1.77 task management function: A task manager service capable of being requested by an application client to affect the processing of ¹² one or more tasks.

3.1.78 task set: A group of tasks within a device server whose interaction is dependent on the task management and auto-contingent ¹³ compliance rules. See SAM-3 for a detailed definition of a task set.

3.1.79 task: ~~An object within the logical unit representing the work associated with a command or group of linked commands. A task consists of one initial connection and zero or more physical or logical reconnections, all pertaining to the task.~~

3.1.80 tagged command queuing (TCQ): A method that makes use of the ATA/ATAPI-7 Queued feature set by which an ATA device may maintain up to 32 outstanding commands concurrently, may order processing of those outstanding commands, and identifies the context of each outstanding command with a unique Tag (see ATA/ATAPI-7). An ATA device indicates support for the Queued feature set in IDENTIFY DEVICE data word 83, bit 1 (see ATA/ATAPI-7). An ATA device indicates the number of commands that may be queued at one time in IDENTIFY DEVICE data word 75, bits 4:0 (see ATA/ATAPI-7).

3.1 vendor-specific: Something (e.g., a bit, field, code value) that is not defined by this standard and may be used differently in various implementations.

3.1.82 word: A sequence of two contiguous bytes considered as a unit.

3.2 Symbols and abbreviations

≠ or NE	not equal
≤ or LE	less than or equal to
±	plus or minus
≈	approximately
x	multiply
+	add
-	subtract
< or LT	less than

Sequence number: 7
Author: MXO[MEvans]
Subject: Highlight
Date: 5/25/2006 9:59:53 AM

T 3.1.70 Serial ATA: change the definition to, "A transport protocol defined by ATA/ATAPI-7."
RESOLUTION: change to,
"A serial transport protocol (see SATA 2.5)."

Status
risheffi Completed 5/29/2006 1:24:34 PM

Sequence number: 8
Author: DELL[KMarks]
Subject: Highlight
Date: 3/4/2006 12:03:36 PM

T 3.1.71
change
"3.1.71 Serial ATA Tunneled Protocol (STP): The protocol defined in this standard used by STP initiator ports to communicate with STP target ports in a SAS domain."
to
"3.1.71 Serial ATA Tunneled Protocol (STP): The protocol defined by SAS-1.1 used by STP initiator ports to communicate with STP target ports in a SAS domain."
RESOLUTION: See MXO comment.

Status
risheffi Completed 5/29/2006 1:26:14 PM

Sequence number: 9
Author: HPQ[RElliott]
Subject: Highlight
Date: 3/4/2006 12:03:29 PM

T 3.1.71
Change "in this standard" to "by SAS-1.1"
RESOLUTION: See MXO comment.

Status
risheffi Completed 5/29/2006 1:26:00 PM

Sequence number: 10
Author: MXO[MEvans]
Subject: Highlight
Date: 2/15/2006 11:50:10 AM

T 3.1.71 Serial ATA Tunneled Protocol (STP): change the definition to, "The protocol used by STP initiator ports to communicate with STP target ports in a SAS domain (see SAS 1.1)."

Status
risheffi Completed 5/29/2006 1:25:42 PM

Sequence number: 11
Author: MXO[MEvans]
Subject: Highlight
Date: 2/7/2006 11:44:05 AM

T 3.1.73 service delivery subsystem: change the definition to, "That part of a SCSI I/O system that transmits service requests to a logical unit or SCSI target device and returns logical unit or SCSI target device responses to a SCSI initiator device (see SAM-3), or that part of an ATA I/O system that connects an ATA host port and one or more ATA/ATAPI device ports and is a single path for the transfer of requests and responses between a host and one or more devices (see ATA8-AAM)."

Status
risheffi Completed 5/29/2006 1:27:26 PM

Sequence number: 12
Author: MXO[MEvans]
Subject: Highlight
Date: 2/7/2006 11:46:57 AM

T 3.1.77 task management function: change, "...one or more tasks.", to, "...one or more tasks (see SAM-3)."

Status
risheffi Completed 5/29/2006 1:30:25 PM

Sequence number: 13
Author: MXO[MEvans]
Subject: Highlight
Date: 2/7/2006 11:48:02 AM

Comments from page 29 continued on next page

3.1.69 SCSI write and verify command: A SCSI WRITE AND VERIFY (10), WRITE AND VERIFY(12), or WRITE AND VERIFY (16) command defined in SBC-2.

3.1.70 Serial ATA (SATA): A protocol defined by ATA/ATAPI-7.

3.1.71 Serial ATA Tunneled Protocol (STP): The protocol defined in this standard used by STP initiator ports to communicate with STP target ports in a SAS domain.

3.1.72 Serial Attached SCSI (SAS): A set of protocols and the interconnect defined by SAS-1.1.

3.1.73 service delivery subsystem: The part of a SCSI I/O system that transmits information between a SCSI initiator port and a SCSI target port, or the part of an ATA I/O system that transmits information between an ATA host and an ATA/ATAPI device, or the part of a SAS I/O system that transmits information between a SAS initiator port and a SAS target port (see SAM-3 and SAS-1.1).

3.1.74 STP initiator port: A SAS initiator device object in a SAS domain that interfaces to the service delivery subsystem with STP (see SAS-1.1).

3.1.75 STP target port: A SAS target device object in a SAS domain that interfaces to the service delivery subsystem with STP (see SAS-1.1).

3.1.76 STP/SATA bridge: An expander device object containing an STP target port, a SATA host port, and the functions required to forward information between the STP target port and SATA host port to enable STP initiator ports in a SAS domain to communicate with SATA devices in an ATA domain (see SAS-1.1).

3.1.77 task management function: A task manager service capable of being requested by an application client to affect the processing of one or more tasks.

3.1.78 task set: A group of tasks within a device server whose interaction is dependent on the task management and auto-contingent allegiance rules. See SAM-3 for a detailed definition of a task set.

3.1.79 task: ¹⁵ object within the logical unit representing the work associated with a command ¹⁴ group of linked commands. ¹⁶ task consists of one initial connection and zero or more physical or logical reconnections, all pertaining to the task.

3.1.80 tagged command queuing (TCQ): ¹⁷ method that makes use of the ATA/ATAPI-7 Queued feature set by which an ATA device may maintain up to 32 outstanding commands concurrently, may order processing of those outstanding commands, and identifies the context of each outstanding command with a unique Tag (see ATA/ATAPI-7). An ATA device indicates support for the Queued feature set in IDENTIFY DEVICE data word 83, bit 1 (see ATA/ATAPI-7). An ATA device indicates the number of commands that may be queued at one time in IDENTIFY DEVICE data word 75, bits 4:0 (see ATA/ATAPI-7).

 ¹⁸ vendor-specific: Something (e.g., a bit, field, code value) that is not defined by this standard and may be used differently in various implementations.

3.1.82 word: A sequence of two contiguous bytes considered as a unit.

3.2 Symbols and abbreviations

≠ or NE	not equal
≤ or LE	less than or equal to
±	plus or minus
≈	approximately
x	multiply
+	add
-	subtract
< or LT	less than

T 3.1.78 task set: change, "...allegiance rules. See SAM-3 for a detailed definition of a task set.", to "...allegiance rules (see SAM-3)."

Status
rlsheffi Completed 5/29/2006 1:31:19 PM

Sequence number: 14
Author: EDITOR[rlsheffi]
Subject: Cross-Out
Date: 7/12/2006 12:59:22 PM

T Delete this text since linked commands are being obsoleted in SPC-4.

Status
rlsheffi Completed 7/12/2006 1:16:04 PM

Sequence number: 15
Author: MXO[MEvans]
Subject: Highlight
Date: 2/7/2006 11:52:25 AM

T 3.1.79 task: change the definition to, "An object within the logical unit representing the work associated with a command or group of linked commands (see SAM-3)." The stuff about "A task consists of one initial connection and zero or more physical or logical reconnections..." is incorrect. A task may be COMPLETED during one connection, but its consistence is independent of the number of connections.

Status
rlsheffi Completed 5/29/2006 1:32:48 PM

Sequence number: 16
Author: DELL[KMarks]
Subject: Cross-Out
Date: 3/4/2006 12:29:16 PM

T 3.1.79

T Remove 2nd sentence

"A task consists of one initial connection and zero or more physical or logical reconnections, all pertaining to the task."
RESOLUTION: See MXO comment.

Status
rlsheffi Completed 5/29/2006 1:32:59 PM

Sequence number: 17
Author: MXO[MEvans]
Subject: Highlight
Date: 5/25/2006 10:19:01 AM

T 3.1.80 tagged command queuing (TCQ): change the definition to, "A method that makes use of the ATA/ ATAPI-7 Queued feature set by which an ATA device may maintain and order the processing of up to 32 outstanding commands, identifying the context of each outstanding command with a unique tag (see ATA/ ATAPI-7)."

RESOLUTION: change to

"A method that makes use of the ATA Tagged Command Queuing feature set, by which an ATA device may maintain and order the processing of up to 32 outstanding commands, identifying the context of each outstanding command with a unique tag (see ATA8-ACS)."

Status
rlsheffi Completed 5/29/2006 1:33:50 PM

Sequence number: 18
Author: DELL[KMarks]
Subject: Note
Date: 5/29/2006 1:42:07 PM

T 3.1.81 vendor-specific

vendor-specific should be moved to the keyword section 3.3.

RESOLUTION (moved to keywords subclause, and modified to look more like SAM-3 definition since SAM-3 has this as a keyword):

"3.3.11: A keyword indicating specification of the referenced item is determined by the SCSI device vendor."

Status
rlsheffi Completed 5/29/2006 1:42:11 PM

= or EQ	equal
> or GT	greater than
≥ or GE	greater than or equal to
ACA	1 Auto-contingent allegiance
ATA	2 AT Attachment (see 3.1.3)
ATAPI	AT attachment packet interface (see 3.1.12)
CDB	3 Command Descriptor Block
FIS	4 Frame Information Structure
FPDMA	First-party direct memory access (see 3.1.29)
FUA	Force Unit Access
LBA	Logical Block Address (see 3.1.38)
LSB	5 Least significant bit
LUN	6 Logical unit number
MSB	7 Most significant bit
n/a	not applicable
NCQ	Native command queuing (see 3.1.45)
PATA	Parallel ATA
SATA	Serial Attached SCSI
SATA	Serial ATA
SATA 2.5	Serial ATA 2.5
SATL	SCSI / ATA Translation Layer (see 3.1.60)
SAM-2	SCSI Architecture Model-2
SAM-3	SCSI Architecture Model-3
SAM-4	SCSI Architecture Model-4
SCSI	Small Computer System Interface
SCT	Smart Command Transport
SPC-3	SCSI Primary Commands-3
STP	Serial ATA Tunneled Protocol
TCQ	Tagged command queuing

3.3 Keywords

3.3.1 expected: A keyword used to describe the behavior of the hardware or software in the design models assumed by this standard. Other hardware and software design models may also be implemented.

3.3.2 invalid: A keyword used to describe an illegal or unsupported bit, byte, word, field or code value. Receipt of an invalid bit, byte, word, field or code value shall be reported as an error.

3.3.3 mandatory: A keyword indicating an item that is required to be implemented as defined in this standard ~~to claim compliance with this standard.~~

3.3.4 may: A keyword that indicates flexibility of choice with no implied preference.

3.3.5 may not: Keywords that indicates flexibility of choice with no implied preference.

3.3.6 obsolete: A keyword indicating that an item was defined in prior SCSI standards but has been removed from this standard.

3.3.7 optional: A keyword that describes features that are not required to be implemented by this standard. However, if any optional feature defined by this standards is implemented, it shall be implemented as defined in this standard.

3.3.8 reserved: A keyword referring to bits, bytes, words, fields and code values that are set aside for future standardization. Their use and interpretation may be specified by future extensions to this or other standards. A reserved bit, byte, word or field shall be set to zero, or in accordance with a future extension to this standard. Recipients are not required to check reserved bits, bytes, words or fields for zero values. Receipt of

Page: 30

Sequence number: 1
Author: HPQ[RElliott]
Subject: Highlight
Date: 2/1/2006 3:51:04 PM

T 3.2
After "auto-contingent allegiance" add "(see 3.1.20)"

Status
rlsheffi Completed 5/29/2006 3:46:45 PM

Sequence number: 2
Author: MXO[MEvans]
Subject: Cross-Out
Date: 3/4/2006 12:48:51 PM

T 3.2 Symbols and abbreviations: delete the cross reference for AT Attachment ("(see 3.1.3)") to be consistent with the deletion of the definition.
REASON: Feb 28 SAT WG rejected the comment to delete ATA Attachment from the Definitions.

Status
rlsheffi Rejected 3/4/2006 12:48:55 PM

Sequence number: 3
Author: HPQ[RElliott]
Subject: Highlight
Date: 2/1/2006 3:51:15 PM

T 3.2
After "Command Descriptor Block" add "(see 3.1.24)"

Status
rlsheffi Completed 5/29/2006 3:48:02 PM

Sequence number: 4
Author: HPQ[RElliott]
Subject: Highlight
Date: 3/4/2006 12:51:52 PM

T 3.2
After "Frame Information Structure" add "(see 3.1.30)"
RESOLUTION:
"Frame Information Structure (see SATA 2.5)."
REASON: The Feb 28 SAT WG decided to remove "Frame Information Structure" from the Definitions, so the reference goes to SATA 2.5.

Status
rlsheffi Completed 5/29/2006 3:48:31 PM

Sequence number: 5
Author: HPQ[RElliott]
Subject: Highlight
Date: 2/1/2006 3:46:42 PM

T 3.2
After "Least significant bit" add "(see 3.1.34)"

Status
rlsheffi Completed 5/29/2006 3:50:05 PM

Sequence number: 6
Author: HPQ[RElliott]
Subject: Highlight
Date: 2/1/2006 3:50:39 PM

T 3.2
After "Logical unit number" add "(see 3.1.39)"

Status
rlsheffi Completed 5/29/2006 3:51:25 PM

Sequence number: 7
Author: HPQ[RElliott]
Subject: Highlight
Date: 2/1/2006 3:46:09 PM

Comments from page 30 continued on next page

= or EQ	equal
> or GT	greater than
≥ or GE	greater than or equal to
ACA	auto-contingent allegiance
ATA	AT Attachment (see 3.1.3)
ATAPI	AT attachment packet interface (see 3.1.12)
CDB	Command Descriptor Block
FIS	Frame Information Structure
FPDMA	First-party direct memory access (see 3.1.29)
FUA	Force Unit Access
LBA	Logical Block Address (see 3.1.38)
LSB	Least significant bit
LUN	Logical unit number
MSB	Most significant bit
n/a	not applicable
NCQ	Native command queuing (see 3.1.45)
PATA	Parallel ATA
SATA	Serial Attached SCSI
SATA 2.5	Serial ATA 2.5
SATL	SCSI / ATA Translation Layer (see 3.1.60)
SAM-2	SI Architecture Model-2
SAM-3	SI Architecture Model-3
SAM-4	SI Architecture Model-4
SCSI	Small Computer System Interface
SCT	Smart Command Transport
SPC-3	SCSI Primary Commands-3
STP	Serial ATA Tunneled Protocol
TCQ	Tagged command queuing

3.3 Keywords

3.3.1 expected: A keyword used to describe the behavior of the hardware or software in the design models assumed by this standard. Other hardware and software design models may also be implemented.

3.3.2 invalid: A keyword used to describe an illegal or unsupported bit, byte, word, field or code value. Receipt of an invalid bit, byte, word, field or code value shall be reported as an error.

3.3.3 mandatory: A keyword indicating an item that is required to be implemented as defined in this standard ~~to claim compliance with this standard.~~

3.3.4 may: A keyword that indicates flexibility of choice with no implied preference.

3.3.5 may not: Keywords that indicates flexibility of choice with no implied preference.

3.3.6 obsolete: A keyword indicating that an item was defined in prior SCSI standards but has been removed from this standard.

3.3.7 optional: A keyword that describes features that are not required to be implemented by this standard. However, if any optional feature defined by this standards is implemented, it shall be implemented as defined in this standard.

3.3.8 reserved: A keyword referring to bits, bytes, words, fields and code values that are set aside for future standardization. Their use and interpretation may be specified by future extensions to this or other standards. A reserved bit, byte, word or field shall be set to zero, or in accordance with a future extension to this standard. Recipients are not required to check reserved bits, bytes, words or fields for zero values. Receipt of

T 3.2
After "Most significant bit" add "(see 3.1.44)"

Status
rlsheffi Completed 5/29/2006 3:51:17 PM

Sequence number: 8
Author: INTC[RSheffield]
Subject: Note
Date: 3/4/2006 1:01:01 PM

3.2 Symbols and abbreviations

SAT is missing.
RESOLUTION: Add "SAT SCSI / ATA Translation (see 3.1.xx)"

Status
rlsheffi Completed 5/29/2006 3:52:42 PM

Sequence number: 9
Author: HPQ[RElliott]
Subject: Highlight
Date: 2/1/2006 3:45:23 PM

T 3.2
After "Serial Attached SCSI" add "(see 3.1.72)"

Status
rlsheffi Completed 5/29/2006 3:53:29 PM

Sequence number: 10
Author: HPQ[RElliott]
Subject: Highlight
Date: 2/1/2006 3:45:29 PM

T 3.2
After "Serial ATA" add (see 3.1.70)"

Status
rlsheffi Completed 5/29/2006 3:54:30 PM

Sequence number: 11
Author: HPQ[RElliott]
Subject: Highlight
Date: 2/1/2006 3:53:44 PM

T 3.2
After "Serial ATA 2.5" add "specification (see 2.4)"

Status
rlsheffi Completed 5/29/2006 3:55:48 PM

Sequence number: 12
Author: HPQ[RElliott]
Subject: Highlight
Date: 2/1/2006 3:52:49 PM

T 3.2
After "SCSI Architecture Model-2" add "standard (see 2.2)"

Status
rlsheffi Completed 5/29/2006 3:56:34 PM

Sequence number: 13
Author: HPQ[RElliott]
Subject: Highlight
Date: 2/1/2006 3:53:02 PM

T 3.2
After "SCSI Architecture Model-3" add "standard (see 2.2)"

Status
rlsheffi Completed 5/29/2006 3:57:23 PM

Sequence number: 14
Author: EDITOR[rlsheffi]
Subject: Cross-Out
Date: 5/11/2006 12:17:11 PM

T There are no SAM-4 references in the document

Status
rlsheffi Completed 5/29/2006 3:58:36 PM

Sequence number: 15

Comments from page 30 continued on next page

= or EQ	equal
> or GT	greater than
≥ or GE	greater than or equal to
ACA	auto-contingent allegiance
ATA	AT Attachment (see 3.1.3)
ATAPI	AT attachment packet interface (see 3.1.12)
CDB	Command Descriptor Block
FIS	Frame Information Structure
FPDMA	First-party direct memory access (see 3.1.29)
FUA	Force Unit Access
LBA	Logical Block Address (see 3.1.38)
LSB	Least significant bit
LUN	Logical unit number
MSB	Most significant bit
n/a	not applicable
NCQ	Native command queuing (see 3.1.45)
PATA	Parallel ATA
SATA	Serial Attached SCSI
SATA	Serial ATA
SATA 2.5	Serial ATA 2.5
SATL	SCSI / ATA Translation Layer (see 3.1.60)
SAM-2	SCSI Architecture Model-2
SAM-3	SCSI Architecture Model-3
SAM-4	SCSI Architecture Model-4
SCSI	Small Computer System Interface
SCT	Smart Command Transport
SPC-3	SCSI Primary Commands-3
STP	Serial ATA Tunneled Protocol
TCQ	Toggled command queuing

3.3 Keywords

3.3.1 expected: A word used to describe the behavior of the hardware or software in the design models assumed by this standard. Other hardware and software design models may also be implemented.

3.3.2 invalid: A keyword used to describe an illegal or unsupported bit, byte, word, field or code value. Receipt of an invalid bit, byte, word, field or code value shall be reported as an error.

3.3.3 mandatory: A keyword indicating an item that is required to be implemented as defined in this standard ~~to claim compliance with this standard.~~

3.3.4 may: A keyword that indicates flexibility of choice with no implied preference.

3.3.5 may not: Keywords that indicates flexibility of choice with no implied preference.

3.3.6 obsolete: A keyword indicating that an item was defined in prior SCSI standards but has been removed from this standard.

3.3.7 optional: A keyword that describes features that are not required to be implemented by this standard. However, if any optional feature defined by this standards is implemented, it shall be implemented as defined in this standard.

3.3.8 reserved: A keyword referring to bits, bytes, words, fields and code values that are set aside for future standardization. Their use and interpretation may be specified by future extensions to this or other standards. A reserved bit, byte, word or field shall be set to zero, or in accordance with a future extension to this standard. Recipients are not required to check reserved bits, bytes, words or fields for zero values. Receipt of

Author: HPQ[RElliott]
Subject: Highlight
Date: 5/29/2006 3:58:19 PM

 3.2
After "SCSI Architecture Model-4" add "standard (see 2.3)"
REASON: Deleting "SAM-4" because it's not referenced anywhere in SAT.

Status
rlsheffi Rejected 5/29/2006 3:57:43 PM

Sequence number: 16
Author: HPQ[RElliott]
Subject: Highlight
Date: 2/1/2006 3:54:26 PM

 3.2
After "Small Computer System Interface" add "family of standards"

Status
rlsheffi Completed 5/29/2006 3:59:00 PM

Sequence number: 17
Author: HPQ[RElliott]
Subject: Highlight
Date: 2/1/2006 3:52:37 PM

 3.2
After "Smart Command Transport" add "standard (see 2.3)"

Status
rlsheffi Completed 5/29/2006 3:59:55 PM

Sequence number: 18
Author: HPQ[RElliott]
Subject: Highlight
Date: 2/1/2006 3:54:39 PM

 3.2
After "SCSI Primary Commands-3" add "standard (see 2.2)"

Status
rlsheffi Completed 5/29/2006 4:00:07 PM

Sequence number: 19
Author: HPQ[RElliott]
Subject: Highlight
Date: 2/1/2006 3:44:09 PM

 3.2
After "Serial ATA Tunneled Protocol" add "(see 3.1.71)"

Status
rlsheffi Completed 5/29/2006 4:00:40 PM

Sequence number: 20
Author: HPQ[RElliott]
Subject: Highlight
Date: 2/1/2006 3:44:39 PM

 3.2
After "Tagged command queuing" add "(see 3.1.80)"

Status
rlsheffi Completed 5/29/2006 4:01:08 PM

Sequence number: 21
Author: INTC[RSheffield]
Subject: Note
Date: 5/29/2006 4:06:08 PM

 3.2 Acronyms...
Add a definition for VPD (pull from SPC-4).
RESOLUTION: add "VPD Vital Product Data (see SPC-3)", as the reference appears in SAM-3.

Status
rlsheffi Completed 5/29/2006 4:06:12 PM

Sequence number: 22
Author: MXO[MEvans]
Subject: Note
Date: 2/7/2006 2:07:07 PM

Comments from page 30 continued on next page

= or EQ	equal
> or GT	greater than
≥ or GE	greater than or equal to
ACA	auto-contingent allegiance
ATA	AT Attachment (see 3.1.3)
ATAPI	AT attachment packet interface (see 3.1.12)
CDB	Command Descriptor Block
FIS	Frame Information Structure
FPDMA	First-party direct memory access (see 3.1.29)
FUA	Force Unit Access
LBA	Logical Block Address (see 3.1.38)
LSB	Least significant bit
LUN	Logical unit number
MSB	Most significant bit
n/a	not applicable
NCQ	Native command queuing (see 3.1.45)
PATA	Parallel ATA
SATA	Serial Attached SCSI
SATA	Serial ATA
SATA 2.5	Serial ATA 2.5
SATL	SCSI / ATA Translation Layer (see 3.1.60)
SAM-2	SCSI Architecture Model-2
SAM-3	SCSI Architecture Model-3
SAM-4	SCSI Architecture Model-4
SCSI	Small Computer System Interface
SCT	Smart Command Transport
SPC-3	SCSI Primary Commands-3
STP	Serial ATA Tunneled Protocol
TCQ	Tagged command queuing

3.3 Keywords

3.3.1 expected: ²³word used to describe the behavior of the hardware or software in the design models assumed by this standard. Other hardware and software design models may also be implemented.

3.3.2 invalid: A keyword used to describe an illegal or unsupported bit, byte, word, field or code value. Receipt of an invalid bit, byte, word, field or code value shall be reported as an error.

3.3.3 mandatory: A keyword indicating an item that is required to be implemented as defined in this standard. ²⁴~~claim compliance with this standard.~~

3.3.4 may: A keyword that indicates flexibility of choice with no implied preference.

3.3.5 may not: Keywords that indicates flexibility of choice with no implied preference.

3.3.6 obsolete: ²⁵keyword indicating that an item was defined in prior SCSI standards but has been removed from this standard.

3.3.7 optional: A keyword that describes features that are not required to be implemented by this standard. However, if any optional feature defined by this standards is implemented, it shall be implemented as defined in this standard.

3.3.8 reserved: A keyword referring to bits, bytes, words, fields and code values that are set aside for future standardization. Their use and interpretation may be specified by future extensions to this or other standards. A reserved bit, byte, word or field shall be set to zero, or in accordance with a future extension to this standard. Recipients are not required to check reserved bits, bytes, words or fields for zero values. Receipt of

 3.3.1 expected: add a space between "A" and "keyword".

Status
rlsheffi Completed 5/29/2006 4:06:36 PM

Sequence number: 23
Author: DELL[KMarks]
Subject: Highlight
Date: 1/22/2006 11:28:35 PM

 3.3.1
add space between A and keyword.

"3.3.1 expected: A keyword..."

Status
rlsheffi Completed 5/29/2006 4:06:45 PM

Sequence number: 24
Author: MXO[MEvans]
Subject: Cross-Out
Date: 2/7/2006 2:08:29 PM

 3.3.3 mandatory: delete, "...to claim compliance with this standard".

Status
rlsheffi Completed 5/29/2006 4:07:15 PM

Sequence number: 25
Author: MXO[MEvans]
Subject: Highlight
Date: 3/4/2006 1:08:51 PM

 3.3.6 obsolete: this is tricky. First, there are no SAT standards prior to this one. Second, the only two places where this word is used are two bits in the ATA PASS THROUGH command. Either delete this keyword or change its definition to something like, "A keyword indicating that an item was defined in a previous version of a standard but has been removed from the most recent version of that standard."
RESOLUTION: Adopt suggested text.

Status
rlsheffi Completed 5/29/2006 4:08:42 PM

reserved code values in defined fields shall be reported as an error.

3.3.9 shall: A keyword indicating a mandatory requirement (equivalent to “is required”). Designers are required to implement all such requirements to ensure interoperability with other products that conform to this standard.

3.3.10 should: A keyword indicating flexibility of choice with a preferred alternative (equivalent to “it is strongly recommended”).

3.4 Command description specific terminology

3.4.1 emulated: term that specifies a requirement for the SATL to implement a specified function by emulating the behavior in a way that involves more than the simple use of a corresponding ATA function implemented in the attached ATA device.

3.4.2 implemented: term that specifies a requirement for the SATL to implement a specified function by using a corresponding ATA function implemented in the attached ATA device. Implemented fields shall not be emulated (e.g., the SCSI-READ (10) command has a 32 bit address, and a 16 bit transfer length. This enables the translator, under the right conditions, to issue a single ATA READ DMA EXT command without providing additional information or capability).

3.4.3 unspecified: A term indicating that this version of this standard does not specify a translation for a SCSI protocol element, but does not preclude a future version of this standard defining a translation. Implementations for fields marked unspecified shall not conflict with SPC-3 or SBC-2.

3.5 Conventions

3.5.1 Overview

Certain words and terms used in this standard have a specific meaning beyond the normal English meaning. These words and terms are defined either in clause 3.1 or in the text where they first appear. Names of commands, statuses, sense keys, and additional sense codes are in all uppercase (e.g., REQUEST SENSE). Lowercase is used for words having the normal English meaning.

If there is more than one CDB length for a particular command (e.g., MODE SENSE (6) and MODE SENSE (10)) and the name of the command is used in a sentence without any CDB length descriptor (e.g., MODE SENSE), then the condition specified in the sentence applies to all CDB lengths for that command.

The names of fields are in small uppercase (e.g., ALLOCATION LENGTH). When a field name is a concatenation of acronyms, uppercase letter may be used for readability (e.g., NORMACA). Normal case is used when the contents of a field are being discussed. Fields containing only one bit are usually referred to as the NAME bit instead of the NAME field.

A binary number is represented in this standard by any sequence of digits comprised of only the Western-Arabic numerals 0 and 1 immediately followed by a lower-case b (e.g., 0101b). Underscores or spaces may be included in binary number representations to increase readability or delineate field boundaries (e.g., 0 0101 1010b or 0_0101_1010b).

A hexadecimal number is represented in this standard by any sequence of digits comprised of only the Western-Arabic numerals 0 through 9 and/or the upper-case English letters A through F immediately followed by a lower-case h (e.g., FA23h). Underscores or spaces may be included in hexadecimal number representations to increase readability or delineate field boundaries (e.g., B FD8C FA23h or B_FD8C_FA23h).

A decimal number is represented in this standard by any sequence of digits comprised of only the Western-Arabic numerals 0 through 9 not immediately followed by a lower-case b or lower-case h (e.g., 25).

When the value of the bit or field is not relevant, x or xx appears in place of a specific value.

Page: 31

Sequence number: 1
Author: INTC[RSheffield]
Subject: Highlight
Date: 3/7/2006 8:02:31 AM

Ts/b
SAT specific terminology

Status
risheffi Completed 5/29/2006 4:09:39 PM

Sequence number: 2
Author: WDC[CStevens]
Subject: Replacement Text
Date: 3/9/2006 10:50:44 AM

T Comment: Since we removed the recommendations, this subclause should be nuked
ARESOLUTION: Remove the term "implemented" since it's not used except in rare instances where the common English interpretation is adequate. Keep definitions for "emulated" and "unspecified" since they're used throughout the document and do have special meaning.

Status
risheffi Completed 5/29/2006 4:10:35 PM

Sequence number: 3
Author: MXO[MEvans]
Subject: Highlight
Date: 5/11/2006 12:27:07 PM

T 3.4.1 emulated: change the definition to something like, "A term designating that a SATL is required to implement supplemental functionality for a SCSI function when an ATA device does not provide an exact equivalent for that function."
RESOLUTION: "A term designating that the SATL is required to implement functions in addition to or in place of functions supported by an ATA device to provide a defined SCSI capability."

Status
risheffi Completed 5/29/2006 4:11:52 PM

Sequence number: 4
Author: MXO[MEvans]
Subject: Highlight
Date: 3/9/2006 10:49:21 AM

T 3.4.2 implemented: change the definition to something like, "A term designating that a SATL is required to implement a specified SCSI function by using a corresponding ATA function implemented in the attached ATA device. Implemented fields shall not be emulated (e.g., the SCSI READ (10) command has a 32 bit address, and a 16 bit transfer length. This enables the translator, under the right conditions, to issue a single ATA READ DMA EXT command without providing additional information or capability)."

RESOLUTION:Delete the definition of the term "Implemented"

Status
risheffi Completed 5/29/2006 4:12:05 PM

Sequence number: 5
Author: DELL[KMarks]
Subject: Cross-Out
Date: 5/29/2006 4:12:51 PM

T 3.4.2 remove "SCSI" from "SCSI READ (10)"
ARESOLUTION: Deleted subclause for "Implemented"

Status
risheffi Completed 5/29/2006 4:12:27 PM

Sequence number: 6
Author: DELL[KMarks]
Subject: Highlight
Date: 5/29/2006 4:13:16 PM

T 3.4.2 implemented:

2nd sentence

change

Comments from page 31 continued on next page

reserved code values in defined fields shall be reported as an error.

3.3.9 shall: A keyword indicating a mandatory requirement (equivalent to “is required”). Designers are required to implement all such requirements to ensure interoperability with other products that conform to this standard.

3.3.10 should: A keyword indicating flexibility of choice with a preferred alternative (equivalent to “it is strongly recommended”).

3.4 Command description specific terminology

3.4.1 emulated: A term that specifies a requirement for the SATL to implement a specified function by emulating the behavior in a way that involves more than the simple use of a corresponding ATA function implemented in the attached ATA device.

3.4.2 implemented: A term that specifies a requirement for the SATL to implement a specified function by using a corresponding ATA function implemented in the attached ATA device. Implemented fields shall not be emulated (e.g., the SCSI-READ (10) command has a 32 bit address, and a 16 bit transfer length. This enables the translator, under the right conditions, to issue a single ATA READ DMA EXT command without providing additional information or capability).

3.4.3 unspecified: ⁷ term indicating that this version of this standard does not specify a translation for a SCSI protocol element, but does not preclude a future version of this standard defining a translation. Implementations for fields marked unspecified shall not conflict with SPC-3 or SBC-2.

3.5 Conventions

3.5.1 Overview

Certain words and terms used in this standard have a specific meaning beyond the normal English meaning. These words and terms are defined either in clause 3.1 or in the text where they first appear. Names of commands, statuses, sense keys, and additional sense codes are in all uppercase (e.g., REQUEST SENSE). Lowercase is used for words having the normal English meaning.

If there is more than one CDB length for a particular command (e.g., MODE SENSE (6) and MODE SENSE (10)) and the name of the command is used in a sentence without any CDB length descriptor (e.g., MODE SENSE), then the condition specified in the sentence applies to all CDB lengths for that command.

The names of fields are in small uppercase (e.g., ALLOCATION LENGTH). When a field name is a concatenation of acronyms, uppercase letter may be used for readability (e.g., NORMACA). Normal case is used when the contents of a field are being discussed. Fields containing only one bit are usually referred to as the NAME bit ¹⁰ of the NAME field.

A binary number is represented in this standard by any sequence of digits comprised of only the Western-Arabic numerals 0 and 1 immediately followed by a lower-case b (e.g., 0101b). Underscores or spaces may be included in binary number representations to increase readability or delineate field boundaries (e.g., 0 0101 1010b or 0_0101_1010b).

A hexadecimal number is represented in this standard by any sequence of digits comprised of only the Western-Arabic numerals 0 through 9 and/or the upper-case English letters A through F immediately followed by a lower-case h (e.g., FA23h). Underscores or spaces may be included in hexadecimal number representations to increase readability or delineate field boundaries (e.g., B FD8C FA23h or B_FD8C_FA23h).

A decimal number is represented in this standard by any sequence of digits comprised of only the Western-Arabic numerals 0 through 9 not immediately followed by a lower-case b or lower-case h (e.g., 25).

When the value of the bit or field is not relevant, x or xx appears in place of a specific value.

"...command has a 32 bit address, and 16 bit transfer length."
to
"...command has a 32 bit logical block address, and a 16 bit transfer length."
RESOLUTION: Deleted subclause for "Implemented".

Status
risheffi Completed 5/29/2006 4:13:19 PM

Sequence number: 7
Author: MXO[MEvans]
Subject: Highlight
Date: 3/9/2006 10:43:45 AM

T 3.4.3 unspecified: change the definition to something like, "A term designating that this version of this standard does not specify a translation for a SCSI function. A translation for an unspecified SCSI function may be specified by future extensions to this or other standards. Implementations for fields marked unspecified shall not conflict with SPC-3 or SBC-2."

RESOLUTION:
"A term designating that this version of this standard does not specify a translation for a SCSI field. A translation for an unspecified field may be specified by future versions of this standard. Translation of fields marked unspecified shall not conflict with other standards in the set of SCSI standards."

Status
risheffi Completed 5/29/2006 4:14:25 PM

Sequence number: 8
Author: IBM[GPenokie]
Subject: Underline
Date: 2/16/2006 1:43:13 PM

T 3.5.1 Overview

Status
risheffi Cancelled 3/4/2006 1:55:50 PM

Sequence number: 9
Author: IBM[GPenokie]
Subject: Highlight
Date: 2/15/2006 8:52:06 AM

T 1st paragraph
This <<defined either in clause 3.1 or in the text where they first >> should be << defined either in 3.1 or in the text where they first >>

Status
risheffi Completed 5/29/2006 4:21:17 PM

Sequence number: 10
Author: MXO[MEvans]
Subject: Note
Date: 2/15/2006 1:35:34 PM

T 3.5.1 [Conventions] Overview: make a new "head2" clause, "Numeric conventions", after the third paragraph.

Status
risheffi Completed 5/29/2006 4:22:02 PM

This standard uses the ISO convention for representing decimal numbers (e.g., the thousands and higher multiples are separated by a space and a comma is used as the decimal point). Table 1 shows some examples of decimal numbers represented using the ISO and American conventions.

Table 1 — ISO and American numbering conventions examples

ISO	American
0,6	0.6
3,141 592 65	3.14159265
1 000	1,000
1 323 462,95	1,323,462.95

1 Lists sequenced by letters (e.g., a-red, b-blue, c-green) show no ordering relationship between the listed items. Numbered lists (e.g., 1-red, 2-blue, 3-green) show a ordering relationship between the listed items.

2 If a conflict arises between text, tables, or figures, the order of precedence to resolve the conflicts is text; then tables; and finally figures. Not all tables or figures are fully described in the text. Tables show data format and values. Notes do not constitute any requirements for implementors.

5.2 Bit and byte ordering

This subclause describes the representation of fields in a table that defines the format of a SCSI structure (e.g., the format of a CDB).

If a field consists of more than one bit and contains a single value (e.g., a number), the least significant bit (LSB) is shown on the right and the most significant bit (MSB) is shown on the left (e.g., in a byte, bit 7 is the MSB and is shown on the left; and bit 0 is the LSB and is shown on the right). The MSB and LSB are not labeled if the field consists of 8 or fewer bits.

If a field consists of more than one byte and contains a single value, the byte containing the MSB is stored at the lowest address and the byte containing the LSB is stored at the highest address (i.e., big-endian byte ordering). The MSB and LSB are labeled.

If a field consists of more than one byte and contains multiple fields each with their own values (e.g., a descriptor), there is no MSB and LSB of the field itself and thus there are no MSB and LSB labels. Each individual field has an MSB and LSB that are labeled as appropriate in the table (if any) that describes the format of the sub-structure having multiple fields.

If a field contains a text string (e.g., ASCII or UTF-8), the MSB label is the MSB of the first character and the LSB label is the LSB of the last character.

When required for clarity, multiple byte fields may be represented with only two rows in a table. This condition is represented by values in the byte number column not increasing by one in each subsequent table row, thus indicating the presence of additional bytes.

5.3 Notation for byte encoded character strings

When this standard requires one or more bytes to contain specific encoded character, the specific characters are enclosed in single quotation marks. The single quotation marks identify the start and end of the characters that are required to be encoded but are not themselves to be encoded. The characters that are to be encoded are shown in exactly the case that is to be encoded.

The encoded characters and the single quotation marks that enclose them are preceded by text that specifies the character encoding methodology and the number of characters required to be encoded.

Using the notation described in this subclause, stating that eleven ASCII characters 'SCSI device' are to be encoded would be the same writing out the following sequence of byte values: 53h 43h 53h 49h 20h 64h 65h 76h 69h 63h 65h.

Page: 32

Sequence number: 1
Author: MXO[MEvans]
Subject: Highlight
Date: 3/20/2006 11:19:28 AM
T CONFIRM: with Mark Evans

3.5.1 [Conventions] Overview: make a new clause on lists (see the SCSI style guide for an example), and remove the paragraph, "Lists sequenced by letters (e.g., a-red, b-blue, c-green) show no ordering relationship between the listed items. Numbered lists (e.g., 1-red, 2-blue, 3-green) show a ordering relationship between the listed items."
RESOLUTION: Create new heading and move text to a location consistent with the latest T10 draft template, but leave the text as is.
REASON: The section of the style guide you refer to is written with T10 editors as the intended audience, not readers of the actual standards. The text here is identical to that contained in the draft standard document template that accompanies the T10 Editor's Style Guide. Readers interested in more detailed information on conventions can refer to the T10 Style Guide.

Status
rlsheffi Rejected 3/4/2006 2:44:29 PM

Sequence number: 2
Author: MXO[MEvans]
Subject: Highlight
Date: 3/4/2006 2:54:52 PM

T 3.5.1 [Conventions] Overview: move the last paragraph ("If a conflict arises between text, tables, or figures, the order of precedence to resolve the conflicts is text, then tables, and finally figures. Not all tables or figures are fully described in the text. Tables show data format and values. Notes do not constitute any requirements for implementors.") above the new numeric conventions clause (i.e., after the paragraph beginning, "The names of fields...").

Status
rlsheffi Completed 5/29/2006 4:23:46 PM

Sequence number: 3
Author: INTC[RSheffield]
Subject: Note
Date: 3/7/2006 8:05:11 AM

Add an informative note at the end of subclause 3.5.1:
Note - See the T10 Editor's Style Guide for more detailed information on editorial conventions used in this standard.

Status
rlsheffi Rejected 3/7/2006 8:05:02 AM

Sequence number: 4
Author: IBM[GPenokie]
Subject: Underline
Date: 2/16/2006 1:42:21 PM
T 3.5.2 Bit and byte ordering

Status
rlsheffi Cancelled 3/4/2006 2:34:08 PM

Sequence number: 5
Author: MXO[MEvans]
Subject: Highlight
Date: 3/4/2006 2:56:13 PM

T 3.5.2 Bit and byte ordering: make this clause be consistent with the SCSI style guide.
RESOLUTION: Copy subclause 3.7 from the Draft template that accompanies the T10 Editor's Style Guide.

Status
rlsheffi Completed 5/29/2006 4:48:28 PM

Sequence number: 6
Author: IBM[GPenokie]
Subject: Note
Date: 3/4/2006 2:57:58 PM

You should replace this subclause with the comparable on from the style guide.
RESOLUTION: Copy subclause 3.7 from the Draft template that accompanies the T10 Editor's Style Guide

Status
rlsheffi Completed 5/29/2006 4:48:39 PM

Sequence number: 7
Author: MXO[MEvans]

Comments from page 32 continued on next page

This standard uses the ISO convention for representing decimal numbers (e.g., the thousands and higher multiples are separated by a space and a comma is used as the decimal point). Table 1 shows some examples of decimal numbers represented using the ISO and American conventions.

Table 1 — ISO and American numbering conventions examples

ISO	American
0,6	0.6
3,141 592 65	3.14159265
1 000	1,000
1 323 462,95	1,323,462.95

Lists sequenced by letters (e.g., a-red, b-blue, c-green) show no ordering relationship between the listed items. Numbered lists (e.g., 1-red, 2-blue, 3-green) show a ordering relationship between the listed items.

If a conflict arises between text, tables, or figures, the order of precedence to resolve the conflicts is text; then tables; and finally figures. Not all tables or figures are fully described in the text. Tables show data format and values. Notes do not constitute any requirements for implementors.

3.5.2 Bit and byte ordering

This subclause describes the representation of fields in a table that defines the format of a SCSI structure (e.g., the format of a CDB).

If a field consists of more than one bit and contains a single value (e.g., a number), the least significant bit (LSB) is shown on the right and the most significant bit (MSB) is shown on the left (e.g., in a byte, bit 7 is the MSB and is shown on the left; and bit 0 is the LSB and is shown on the right). The MSB and LSB are not labeled if the field consists of 8 or fewer bits.

If a field consists of more than one byte and contains a single value, the byte containing the MSB is stored at the lowest address and the byte containing the LSB is stored at the highest address (i.e., big-endian byte ordering). The MSB and LSB are labeled.

If a field consists of more than one byte and contains multiple fields each with their own values (e.g., a descriptor), there is no MSB and LSB of the field itself and thus there are no MSB and LSB labels. Each individual field has an MSB and LSB that are labeled as appropriate in the table (if any) that describes the format of the sub-structure having multiple fields.

If a field contains a text string (e.g., ASCII or UTF-8), the MSB label is the MSB of the first character and the LSB label is the LSB of the last character.

When required for clarity, multiple byte fields may be represented with only two rows in a table. This condition is represented by values in the byte number column not increasing by one in each subsequent table row, thus indicating the presence of additional bytes.

3.5.3 Notation for byte encoded character strings

When this standard requires one or more bytes to contain specific encoded character, the specific characters are enclosed in single quotation marks. The single quotation marks identify the start and end of the characters that are required to be encoded but are not themselves to be encoded. The characters that are to be encoded are shown in exactly the case that is to be encoded.

The encoded characters and the single quotation marks that enclose them are preceded by text that specifies the character encoding methodology and the number of characters required to be encoded.

Using the notation described in this subclause, stating that eleven ASCII characters 'SCSI device' are to be encoded would be the same writing out the following sequence of byte values: 53h 43h 53h 49h 20h 64h 65h 76h 69h 63h 65h.

Subject: Highlight

Date: 2/7/2006 2:27:07 PM

T 3.5.3 Notation for byte encoded character strings: make this clause be consistent with the SCSI style guide.

Status

risheffi Completed

5/29/2006 5:32:24 PM

An ASCII space character (value 20h) may be represented in a string by the character ‘\ ’ (e.g., ‘\ CSI-device’). This is useful when a string contains adjacent space characters.

3.5.4 Notation for command descriptions

3.5.4.1 Description

The description of each command begins with a subclause describing the general method applied in translating the SCSI command to the corresponding ATA commands, as well as any constraints and special considerations that may apply to the translation applied.

The subclause describing the general translation method for each command contains a table formatted like Table 2 with two columns as follows:

- a) the first column lists each of the fields in the SCSI CDB (the format and byte-position of each field is defined in the SCSI command standard that defines the CDB for that command); and
- b) the second column is either a brief description of the corresponding ATA protocol element(s) used to implement the identified SCSI field, or a reference to a subsequent subclause containing a more lengthy description of the method of emulation or implementation.

Table 2 — Format for translated command field descriptions

Field	Description or reference
IMPLEMENTED OR EMULATED FIELD	A brief identification of the corresponding ATA protocol element, or a paragraph reference if there are special considerations that need to be applied in the use of the corresponding ATA protocol element that require a separate paragraph of description.
SUMMARY EMULATED FIELD	Summary field with more detailed structure.
UNSPECIFIED FIELD	Unspecified (see 3.4.3)

Tables listing fields in mode pages have an additional column that indicates whether the field is changeable or not.

~~3.5.4.2 Recursive descent~~

3.5.4.2.1 Overview

Many times a field may itself either be a summary of a more complex structure of fields or may refer to other structures such as mode pages or log pages. In this case the subclause describing the summary field may contain a table with a structure like that shown in Table 2 to describe the emulation or implementation of each of the specific fields represented in the summary field identified at the next level up, with references to following subclauses, as required. This method of documentation may be applied recursively until all the applicable fields involved in the translation of a SCSI command to ATA protocol elements have been described in sufficient detail.

Table 3 — Format for summary field expanded descriptions

Field	SATType	Description or reference
FIELD NAME		Brief description of field or reference to paragraph (see 3.5.4.2.2)
Additional fields as required		
^a Table footnotes		

Sequence number: 1
Author: EDITOR[rlsheffi]
Subject: Note
Date: 5/25/2006 11:03:58 AM

 3.5 Conventions
Add subclause 3.5.x as follows:

"3.5.x Use of 'and/or'

The text 'x and/or y' means the same as:

- a) x;
- b) y; or
- c) x and y;

where x and y are defined terms, descriptive elements, steps in a procedure, or other phrases used to define requirements in this standard.

Status
rlsheffi Completed 5/29/2006 5:34:45 PM

Sequence number: 2
Author: IBM[GPenokie]
Subject: Underline
Date: 2/16/2006 1:41:00 PM
T 3.5.4.1 Description

Status
rlsheffi Cancelled 3/5/2006 8:01:02 AM

Sequence number: 3
Author: DELL[KMarks]
Subject: Highlight
Date: 1/23/2006 12:21:00 PM

T 3.5.4.1 Description
1st Sentence

change

"...corresponding ATA commands, as well..."

to

"...corresponding ATA command(s), as well..."

Status
rlsheffi Completed 5/29/2006 5:35:46 PM

Sequence number: 4
Author: HPQ[RElliott]
Date: 2/3/2006 7:52:01 AM
 3.5.4.1 and global

"Table nn" should be lowercase unless starting a sentence

Status
rlsheffi Completed 5/29/2006 5:44:48 PM

Sequence number: 5
Author: IBM[GPenokie]
Subject: Highlight
Date: 3/7/2006 8:08:32 AM

T This <<SCSI CDB (the format and byte-position of each field is defined in the SCSI command standard that defines the CDB for that command); >> should be << SCSI CDB (i.e., the format and byte-position of each field is defined in the SCSI command standard that defines the CDB for that command);
RESOLUTION: replace the parenthetical expression with "(see SPC-3 and SBC-2)".

Status
rlsheffi Completed 5/29/2006 5:45:50 PM

Sequence number: 6
Author: MXO[MEvans]
Subject: Cross-Out
Date: 3/7/2006 8:23:12 AM

An ASCII space character (value 20h) may be represented in a string by the character ‘\ ’ (e.g., ‘SCSI-device’). This is useful when a string contains adjacent space characters.

3.5.4 Notation for command descriptions

3.5.4.1 Description

The description of each command begins with a subclause describing the general method applied in translating the SCSI command to the corresponding ATA commands, as well as any constraints and special considerations that may apply to the translation applied.

The subclause describing the general translation method for each command contains a table formatted like Table 2 with two columns as follows:

- a) the first column lists each of the fields in the SCSI CDB (the format and byte-position of each field is defined in the SCSI command standard that defines the CDB for that command); and
- b) the second column is either a brief description of the corresponding ATA protocol element(s) used to implement the identified SCSI field, or a reference to a subsequent subclause containing a more lengthy description of the method of emulation or implementation.

Table 2 — Format for translated command field descriptions

Field	Description or reference
IMPLEMENTED OR EMULATED FIELD	A brief identification of the corresponding ATA protocol element, or a paragraph reference if there are special considerations that need to be applied in the use of the corresponding ATA protocol element that require a separate paragraph of description.
SUMMARY EMULATED FIELD	Summary field with more detailed structure.
UNSPECIFIED FIELD	Unspecified (see 3.4.3)

Tables listing fields in mode pages have an additional column that indicates whether the field is changeable or not.

~~3.5.4.2 Recursive descent~~

3.5.4.2.1 Overview

Many times a field may itself either be a summary of a more complex structure of fields or may refer to other structures such as mode pages or log pages. In this case the subclause describing the summary field may contain a table with a structure like that shown in Table 2 to describe the emulation or implementation of each of the specific fields represented in the summary field identified at the next level up, with references to following subclauses, as required. This method of documentation may be applied recursively until all the applicable fields involved in the translation of a SCSI command to ATA protocol elements have been described in sufficient detail.

Table 3 — Format for summary field expanded descriptions

Field	SATType	Description or reference
FIELD NAME		Brief description of field or reference to paragraph (see 3.5.4.2.2)
Additional fields as required		
^a Table footnotes		

T Table 2 and global: delete "(see 3.4.3)". This unnecessary cross reference points to the definition for "unspecified" and occurs many, many times in this standard. It is interesting to note that the other two words defined in clause 3.4 ("emulated" and "implemented") are never cross referenced anywhere in this standard.
REASON: The "unspecified" instances all have cross references, and the "emulated" instances do not simply because the instances of "unspecified" all occur as isolated terms in table cells, whereas all instances of "emulated" occur in normal text. So if "emulated" appeared alone in a table cell, it would have a cross reference. It just happens that there are no such instances.

Status
rlsheffi Rejected 3/7/2006 8:22:51 AM

Sequence number: 7
Author: HPQ[RElliott]
Subject: Highlight
Date: 2/1/2006 3:32:47 PM

T 3.5.4.1

indicates s/b defines

Status
rlsheffi Completed 5/29/2006 5:46:47 PM

Sequence number: 8
Author: EDITOR[rlsheffi]
Subject: Cross-Out
Date: 4/24/2006 11:06:08 AM

T March 7 SAT WG agreed to delete this subclause.

Status
rlsheffi Completed 5/29/2006 5:50:09 PM

Sequence number: 9
Author: MXO[MEvans]
Subject: Highlight
Date: 3/7/2006 8:35:24 AM

T 3.5.4.2.1 [Recursive decent] Overview, first paragraph: The whole paragraph is not clear, beginning with the first sentence. This sentence reads, "Many times a field may itself either be a summary of a more complex structure of fields or may refer to other structures such as mode pages or log pages." However, a field is defined in other SCSI standards as, "A group of one or more contiguous bits, a part of a larger structure such as a CDB or sense data." Ignoring the "many times", is this intended to mean "The content of a cell in the Field column may refer to other structures"? Including this and other changes, make the paragraph be, "The content of a cell in the Field column may refer to other structures (i.e., mode pages or log pages). A subclause describing one of the other structures may contain a table to describe the emulation or implementation of that structure with references to following subclauses, as required. Table 2 shows an example of a table in a subclause describing one of the other structures. This method of documentation may be applied recursively until all the applicable fields involved in the translation of a SCSI command to ATA protocol elements have been described in sufficient detail."

RESOLUTION:
Delete subclause 3.5.4.2 Recursive descent

Status
rlsheffi Completed 5/29/2006 5:50:09 PM

Sequence number: 10
Author: HPQ[RElliott]
Date: 2/3/2006 7:52:01 AM

T 3.5.4.2.1

"in Table 2" s/b "in table 3"

Status
rlsheffi Completed 5/29/2006 5:50:09 PM

Sequence number: 11
Author: DELL[KMarks]
Subject: Highlight
Date: 3/5/2006 8:19:04 AM

T 3.5.4.2.1 Overview

2nd Sentence
change

"...shown in Table 2 to describe the..."

An ASCII space character (value 20h) may be represented in a string by the character ‘\ ’ (e.g., ‘SCSI-device’). This is useful when a string contains adjacent space characters.

3.5.4 Notation for command descriptions

3.5.4.1 Description

The description of each command begins with a subclause describing the general method applied in translating the SCSI command to the corresponding ATA commands, as well as any constraints and special considerations that may apply to the translation applied.

The subclause describing the general translation method for each command contains a table formatted like Table 2 with two columns as follows:

- a) the first column lists each of the fields in the SCSI CDB (the format and byte-position of each field is defined in the SCSI command standard that defines the CDB for that command); and
- b) the second column is either a brief description of the corresponding ATA protocol element(s) used to implement the identified SCSI field, or a reference to a subsequent subclause containing a more lengthy description of the method of emulation or implementation.

Table 2 — Format for translated command field descriptions

Field	Description or reference
IMPLEMENTED OR EMULATED FIELD	A brief identification of the corresponding ATA protocol element, or a paragraph reference if there are special considerations that need to be applied in the use of the corresponding ATA protocol element that require a separate paragraph of description.
SUMMARY EMULATED FIELD	Summary field with more detailed structure.
UNSPECIFIED FIELD	Unspecified (see 3.4.3)

Tables listing fields in mode pages have an additional column that indicates whether the field is changeable or not.

~~3.5.4.2 Recursive descent~~

3.5.4.2.1 Overview

Many times a field may itself either be a summary of a more complex structure of fields or may refer to other structures such as mode pages or log pages. In this case the subclause describing the summary field may contain a table with a structure like that shown in Table 2 to describe the emulation or implementation of each of the specific fields represented in the summary field identified at the next level up, with references to following subclauses, as required. This method of documentation may be applied recursively until all the applicable fields involved in the translation of a SCSI command to ATA protocol elements have been described in sufficient detail.

Table 3 — Format for summary field expanded descriptions

Field	SATType	Description or reference
FIELD NAME	U ¹⁴	Brief description of field or reference to paragraph (see 3.5.4.2.2)
Additional fields as required		
^a Table footnotes		

to
"...shown in Table 3 to describe the..."
RESOLUTION: "...shown in table 2 to describe the..."

Status
risheffi Completed 5/29/2006 5:50:09 PM

Sequence number: 12
Author: IBM[GPenokie]
Subject: Comment on Text
Date: 2/16/2006 8:39:04 AM

 1st paragraph
This << shown in Table 2 to describe >> should be << shown in table 3 to describe >>

Status
risheffi Completed 5/29/2006 5:50:09 PM

Sequence number: 13
Author: MXO[MEvans]
Subject: Highlight
Date: 3/7/2006 8:35:06 AM

 Table 3 — Format for summary field expanded descriptions: to be consistent with the previous comment, change the table title to, "Format for other structure descriptions".

RESOLUTION:
Delete subclause 3.5.4.2 Recursive descent

Status
risheffi Completed 5/29/2006 5:50:09 PM

Sequence number: 14
Author: DELL[KMarks]
Subject: Note
Date: 3/7/2006 8:34:12 AM

 In Table 3

Remove SATType column.
RESOLUTION:
Delete subclause 3.5.4.2 Recursive descent

Status
risheffi Completed 5/29/2006 5:50:09 PM

~~1 5.4.2.2 Detailed field description~~

~~A paragraph at this level is used to describe the implementation of a sub field of a summary field at a higher level, or a field in a mode page, log page, sense data, or other referenced information structure.~~

3.5.5 Use of field names defined in ATA standards and specifications

This standard discusses fields and values defined in other standards and specifications, in particular the ~~2 ATA~~ ATAPI 7, ~~3 ATA8-AST~~, ATA8-APT, ATA8-ACS, ATA8-AAM, and SCT standards developed by T13, and the SATA ~~4~~ 2.5 specification. Such fields and values discussed in this standard are shown using the same notation conventions used in the standards where those fields and values are defined.

When this standard uses terms defined in T13 ATA standards or the SATA-2.5 specification, the following conventions apply:

- a) The names of abbreviations, commands, and acronyms used as signal names are in all uppercase (e.g., IDENTIFY DEVICE). Fields containing only one bit are usually referred to as the “name” bit instead of the “name” field.
- b) Names of device registers, fields in data structures, and other defined terms begin with a upper-case letter (e.g., LBA Mid register) and may be represented in mixed-case (e.g. PhyRdy).
- c) The expression “word n” or “bit n” shall be interpreted as indicating the content of word n or bit n.
- d) ~~5~~ Signal names are shown in all uppercase letters. All signals are either high active or low active signals. A dash character (-) at the end of a signal name indicates the signal is a low active signal. No dash at the end of a signal name indicates the signal is a high active signal.
- e) Asserted means that the signal is driven by an active circuit to the true state. Negated means that the signal is driven by an active circuit to the false state. Released means that the signal is not actively driven to any state.
- f) SIGNAL(n:m) denotes a set of signals, for example, DD(15:0).
- g) Bit names are shown in all uppercase letters except where a lowercase n precedes a bit name. If there is no preceding n, then when BIT is set to one the meaning of the bit is true, and when BIT is cleared to zero the meaning of the bit is false. If there is a preceding n, then when nBIT is cleared to zero the meaning of the bit is true and when nBIT is set to one the meaning of the bit is false.
- h) Bit (n:m) denotes a set of bits, for example, bits (7:0).
- i) ~~6~~ Primitive names are followed by a 'P' subscript (e.g., R_OK_P).

Sequence number: 1
Author: MXO[MEvans]
Subject: Cross-Out
Date: 3/7/2006 8:34:47 AM

T 3.5.4.2.2 Detailed field description: delete this clause.

T RESOLUTION:

Delete subclause 3.5.4.2 Recursive descent

Status

rlsheffi Completed 5/29/2006 5:50:09 PM

Sequence number: 2
Author: EDITOR[rlsheffi]
Subject: Cross-Out
Date: 5/25/2006 10:23:01 AM

T 3.5.5 Use of field names defined in ATA standards and specifications

T First sentence

Delete "ATA/ATAPI-7" for consistency with an earlier accepted LB comment to reference only ATA8 documents.

Status

rlsheffi Completed 5/29/2006 5:52:54 PM

Sequence number: 3
Author: HPQ[RElliott]
Subject: Cross-Out
Date: 3/5/2006 8:28:57 AM

T 3.5.5

Delete all references to ATA8-AST

Status

rlsheffi Completed 5/29/2006 5:52:32 PM

Sequence number: 4
Author: INTC[RSheffield]
Subject: Cross-Out
Date: 2/28/2006 1:20:01 PM

T Delete dash (use space)

Status

rlsheffi Completed 5/29/2006 5:53:10 PM

Sequence number: 5
Author: WDC[CStevens]
Subject: Comment on Text
Date: 2/13/2006 9:56:16 AM

T This document does not have signaling, these items should be removed.

Status

rlsheffi Completed 5/29/2006 5:54:07 PM

Sequence number: 6
Author: WDC[CStevens]
Subject: Comment on Text
Date: 2/13/2006 9:56:46 AM

T This document does not use primitives, this should be removed.

Status

rlsheffi Completed 5/29/2006 5:54:31 PM

1 General

2 This standard defines a translation layer that may be inserted between host driver software and Serial ATA or Parallel ATA devices. The translation layer thus defined maps SCSI commands and SAM-3 behaviors to ATA devices. The mapping provides a consistent SAM-3, SPC-3, and SBC-2 view of the translated ATA devices to the host driver software.

4 The following items are 3 defined.

- a) translation of selected SCSI commands implemented using ATA devices;
- b) specification of sense data reporting;
- c) mode and log pages applicable to SCSI devices emulated using ATA devices;
- d) usage of task management functions for SCSI emulation using ATA devices;
- e) mapping of SMART functions;
- f) elements to facilitate use of SATA port selectors and SATA port multipliers;
- g) elements to provide consistent mapping of ATA/ATAPI devices as SCSI devices; and
- h) other capabilities that may fit within the scope of this standard.

Implementations of SCSI/ATA Translation may provide varying levels of SCSI function. Two examples are:

- a) The SATL may provide a level of SCSI emulation that is indistinguishable from native SCSI devices in terms of reported capabilities. Such SATL implementations need little guidance from this standard to effect interoperability since other SCSI protocol standards define all that is required to establish interoperability; and
- b) A SCSI / ATA Translation implementation may:
 - A) implement a subset of SCSI;
 - B) have limited or no capability to maintain persistent information about the characteristics or state of the emulated SCSI device;
 - C) have limited capability to manage device state information that carries forward from one command to the next; and
 - D) maintain little or no capability to coordinate between multiple commands outstanding at a time. The characteristics and behavior of the underlying ATA devices in these minimal implementations of the SATL are expected to be more visible to the SCSI application clients.

This standard provides a set of definitions, conventions, and guidelines for:

- a) the consistent reporting of capabilities of emulated SCSI devices implemented by the SATL;
- b) the consistent identification of the attached devices; and
- c) identification of limits for specific levels of SATL capability.

This allows SATL aware and SATL non-aware application clients to establish standard behaviors for all implementations.

The objective of this standard is to allow a complete set of SCSI functions while minimizing the complexity of the SATL and preserving compatibility with existing SCSI application clients.

By outlining expected behavior in terms of the SCSI commands issued, corresponding activity in the ATA domain, and expected SCSI responses based on the results of activity in the ATA domain; this standard eliminates:

- a) incompatibility between legacy SCSI/ATA Translation implementations; and
- b) SCSI application client /device interdependence.

This standard refers to behaviors for SCSI devices defined in SBC-2 and SPC-3. Unless otherwise specified, any behaviors that are optional in SBC-2 or SPC-3 are optional for devices implementing SCSI / ATA Translation. Any optional behaviors referred to in this standard and implemented by the SATL shall be implemented as described in this standard.

If the SATL receives a SCSI request specifying any value in any field of the CDB that the SATL does not support, the SATL shall terminate the command with CHECK CONDITION status with the sense key set to ILLEGAL REQUEST and the additional sense code set to INVALID FIELD IN CDB (see SPC-3).

If the SATL receives a SCSI request specifying any value in any field of the parameter data that the SATL does not support, the SATL shall terminate the command with CHECK CONDITION status with the sense key

Sequence number: 1
Author: IBM[GPenokie]
Subject: Underline
Date: 2/16/2006 1:38:08 PM

T4 General

Status

risheffi Cancelled 3/5/2006 8:31:05 AM

Sequence number: 2
Author: MXO[MEvans]
Subject: Highlight
Date: 3/9/2006 1:05:32 PM

T4 General, first paragraph: change to, "This standard defines a translation layer (i.e., the SATL) that may be inserted between host driver software and Serial ATA or Parallel ATA devices. The translation layer thus defined maps SCSI commands and SAM-3 behaviors to ATA devices."

RESOLUTION: "This standard defines a translation layer (i.e., the SATL) that provides a method for a SCSI application layer (see SAM-3) to access Serial ATA or Parallel ATA devices by representing ATA devices as SCSI direct-access block devices."

Status

risheffi Completed 5/29/2006 5:55:47 PM

Sequence number: 3
Author: HPQ[RElliott]
Date: 2/3/2006 7:52:01 AM

T4
"defined." s/b "defined:"

Status

risheffi Completed 5/29/2006 5:56:22 PM

Sequence number: 4
Author: MXO[MEvans]
Subject: Highlight
Date: 5/25/2006 3:44:59 PM

T4 General, first unordered list: change to be as follows:

This standard defines how the SATL translates the following items:

- a) selected SCSI commands for use by ATA devices;
- b) responses from ATA devices to SCSI sense data reporting;
- c) mode and log page information to and from ATA devices;
- d) task management functions to ATA devices;
- e) SMART functions;
- f) elements to facilitate use of SATA port selectors and SATA port multipliers;
- g) elements to provide consistent mapping of ATA devices and ATAPI devices as SCSI devices; and
- h) other capabilities that may fit within the scope of this standard.

RESOLUTION:

Change the list to

"This standard defines the following aspects of the translation between the SCSI application layer (see SAM-3) and ATA device protocol:

- a) the mapping of selected SCSI commands to ATA commands;
- b) the mapping of ATA device responses to SCSI sense data reporting;
- c) the mapping of SCSI parameter data to ATA equivalents;
- d) the emulation of SCSI task management functions;
- e) the mapping of SCSI informational exceptions to ATA SMART functions;
- f) elements to provide consistent mapping of ATA devices as SCSI devices; and
- g) other capabilities that may fit within the scope of this standard."

Merge the list into the Scope (along with the list in subclause 5.1).

Status

risheffi Completed 5/29/2006 6:29:53 PM

4 General

This standard defines a translation layer that may be inserted between host driver software and Serial ATA or Parallel ATA devices. The translation layer thus defined maps SCSI commands and SAM-3 behaviors to ATA devices. The mapping provides a consistent SAM-3, SPC-3, and SBC-2 view of the translated ATA devices to the host driver software.

The following items are defined.

- a) translation of selected SCSI commands implemented using ATA devices;
- b) specification of sense data reporting;
- c) mode and log pages applicable to SCSI devices emulated using ATA devices;
- d) usage of task management functions for SCSI emulation using ATA devices;
- e) mapping of SMART functions;
- f) elements to facilitate use of SATA port selectors and SATA port multipliers;
- g) elements to provide consistent mapping of ATA/ATAPI devices as SCSI devices; and
- h) other capabilities that may fit within the scope of this standard.

Implementations of SCSI/ATA Translation may provide varying levels of SCSI function. **5** Two examples are:

- a) The SATL may provide a level of SCSI emulation that is indistinguishable from native SCSI devices in terms of reported capabilities. Such SATL implementations need little guidance from this standard to effect interoperability since other SCSI protocol standards define all that is required to establish interoperability; and
- b) A SCSI / ATA Translation implementation may:
 - A) implement a subset of SCSI;
 - B) have limited or no capability to maintain persistent information about the characteristics or state of the emulated SCSI device;
 - C) have limited capability to manage device state information that carries forward from one command to the next; and
 - D) maintain little or no capability to coordinate between multiple commands outstanding at a time.
 The characteristics and behavior of the underlying ATA devices in these minimal implementations of the SATL are expected to be more visible to the SCSI application clients.

6 This standard provides a set of definitions, conventions, and guidelines for:

- a) the consistent reporting of capabilities of emulated SCSI devices implemented by the SATL;
- b) the consistent identification of the attached devices; and
- c) identification of limits for specific levels of SATL capability.

This allows SATL aware and SATL non-aware application clients to establish standard behaviors for all implementations.

7 The objective of this standard is to allow a complete set of SCSI functions while minimizing the complexity of the SATL and preserving compatibility with existing SCSI application clients.

By **8** outlining expected behavior in terms of the SCSI commands issued, corresponding activity in the ATA domain, and expected SCSI responses based on the results of activity **9** in the ATA domain; this standard eliminates:

- a) incompatibility between legacy SCSI/ATA Translation implementations; and
- b) SCSI application client /device interdependence.

This standard refers to behaviors for SCSI devices defined in SBC-2 and SPC-3. Unless otherwise specified, any behaviors that are optional in SBC-2 or SPC-3 are optional for devices implementing SCSI / ATA Translation. Any optional behaviors referred to in this standard and implemented by the SATL shall be implemented as described in this standard.

If the SATL receives a SCSI request specifying any value in any field of the CDB that the SATL does not support, the SATL shall terminate the command with CHECK CONDITION status with the sense key set to ILLEGAL REQUEST and the additional sense code set to INVALID FIELD IN CDB (see SPC-3).

If the SATL receives a SCSI request specifying any value in any field of the parameter data that the SATL does not support, the SATL shall terminate the command with CHECK CONDITION status with the sense key

Sequence number: 5
Author: IBM[GPenokie]
Subject: Highlight
Date: 3/7/2006 8:41:52 AM

T RESOLUTION: Two examples are provided below.

EXAMPLE 1 - The SATL may provide a level of SCSI emulation that is indistinguishable from native SCSI devices in terms of reported capabilities. Such SATL implementations need little guidance from this standard to effect interoperability since other SCSI protocol standards define all that is required to establish interoperability.

EXAMPLE 2 - A SCSI / ATA Translation implementation may implement a subset of SCSI, have limited or no capability to maintain persistent information about the characteristics or state of the emulated SCSI device, have limited capability to manage device state information that carries forward from one command to the next, and maintain little or no capability to coordinate between multiple commands outstanding at a time. The characteristics and behavior of the underlying ATA devices in these minimal implementations of the SATL are expected to be more visible to the SCSI application clients.

Status
rIsheffi Completed 5/29/2006 6:42:58 PM

Sequence number: 6
Author: MXO[MEvans]
Subject: Highlight
Date: 3/7/2006 8:56:13 AM

T 4 General, fourth and fifth paragraphs: change to:

This standard provides a set of definitions, conventions, and guidelines for:

- a) the consistent reporting by the SATL of capabilities of emulated SCSI devices;
- b) the consistent identification of the attached devices by the application clients; and
- c) identification of limits for specific levels of SATL capability.

These provisions allow application clients to have consistent behavior whether or not the application clients comprehend the presence of a SATL in a system.

RESOLUTION:

This standard provides a set of definitions, conventions, and guidelines for:

- a) the consistent reporting by the SATL of capabilities of emulated SCSI devices; and
- b) the consistent identification of the attached devices by the application clients.

These provisions allow application clients to observe consistent behavior whether or not the application clients recognize the presence of a SATL in a system.

Status
rIsheffi Completed 5/29/2006 6:45:01 PM

Sequence number: 7
Author: MXO[MEvans]
Subject: Highlight
Date: 3/5/2006 9:49:36 AM

T 4 General, sixth paragraph ["The objective of this standard is to allow a complete set of SCSI functions while minimizing the complexity of the SATL and preserving compatibility with existing SCSI application clients."]: this should be in the scope (as, I would argue, should be the content of much of this clause).

RESOLUTION: Will move this paragraph to an appropriate place in the Scope.

Status
rIsheffi Completed 5/29/2006 6:48:12 PM

Sequence number: 8
Author: MXO[MEvans]
Subject: Highlight
Date: 2/8/2006 8:24:01 AM

T General, seventh paragraph: change "outlining" to "defining".

Status
rIsheffi Completed 5/29/2006 6:49:01 PM

Sequence number: 9

Comments from page 35 continued on next page

4 General

This standard defines a translation layer that may be inserted between host driver software and Serial ATA or Parallel ATA devices. The translation layer thus defined maps SCSI commands and SAM-3 behaviors to ATA devices. The mapping provides a consistent SAM-3, SPC-3, and SBC-2 view of the translated ATA devices to the host driver software.

The following items are defined.

- a) translation of selected SCSI commands implemented using ATA devices;
- b) specification of sense data reporting;
- c) mode and log pages applicable to SCSI devices emulated using ATA devices;
- d) usage of task management functions for SCSI emulation using ATA devices;
- e) mapping of SMART functions;
- f) elements to facilitate use of SATA port selectors and SATA port multipliers;
- g) elements to provide consistent mapping of ATA/ATAPI devices as SCSI devices; and
- h) other capabilities that may fit within the scope of this standard.

Implementations of SCSI/ATA Translation may provide varying levels of SCSI function. Two examples are:

- a) The SATL may provide a level of SCSI emulation that is indistinguishable from native SCSI devices in terms of reported capabilities. Such SATL implementations need little guidance from this standard to effect interoperability since other SCSI protocol standards define all that is required to establish interoperability; and
- b) A SCSI / ATA Translation implementation may:
 - A) implement a subset of SCSI;
 - B) have limited or no capability to maintain persistent information about the characteristics or state of the emulated SCSI device;
 - C) have limited capability to manage device state information that carries forward from one command to the next; and
 - D) maintain little or no capability to coordinate between multiple commands outstanding at a time.
 The characteristics and behavior of the underlying ATA devices in these minimal implementations of the SATL are expected to be more visible to the SCSI application clients.

This standard provides a set of definitions, conventions, and guidelines for:

- a) the consistent reporting of capabilities of emulated SCSI devices implemented by the SATL;
- b) the consistent identification of the attached devices; and
- c) identification of limits for specific levels of SATL capability.

This allows SATL aware and SATL non-aware application clients to establish standard behaviors for all implementations.

The objective of this standard is to allow a complete set of SCSI functions while minimizing the complexity of the SATL and preserving compatibility with existing SCSI application clients.

By outlining expected behavior in terms of the SCSI commands issued, corresponding activity in the ATA domain, and expected SCSI responses based on the results of activity in the ATA domain; this standard eliminates:

- a) incompatibility between legacy SCSI/ATA¹⁰ translation implementations; and
- b) SCSI application client /device interdependence.

This standard refers to behaviors for SCSI devices defined in SBC-2 and SPC-3. Unless otherwise specified, any behaviors that are optional in SBC-2 or SPC-3 are optional for devices implementing SCSI / ATA Translation. Any optional behaviors referred to in this standard and implemented by the SATL shall be implemented as described in this standard.

If the SATL receives a SCSI request specifying any value in any field of the CDB that the SATL does not support, the SATL shall terminate the command with CHECK CONDITION status with the sense key set to ILLEGAL REQUEST and the additional sense code set to INVALID FIELD IN CDB (see SPC-3).

If the SATL receives a SCSI request specifying any value in any field of the parameter data that the SATL does not support, the SATL shall terminate the command with CHECK CONDITION status with the sense key

Author: IBM[GPenokie]
Subject: Highlight
Date: 5/29/2006 6:50:20 PM

T paragraph above last a,b list

This <<activity in the ATA domain; this standard >> should be << activity in the ATA domain this standard >>

RESOLUTION:

"activity in the ATA domain, this standard"

REASON: This sentence has a dependent clause in juxtaposed position, which requires it be separated by a comma. No comma would be necessary if the order were reversed (i.e., "This standard eliminates... by outlining expected behavior...").

Status
risheffi Completed 5/29/2006 6:50:32 PM

Sequence number: 10
Author: DELL[KMarks]
Subject: Highlight
Date: 5/29/2006 6:51:26 PM

T 4 General

7th paragraph, b) in a,b list

make translation lower case "t"

RESOLUTION: Mate it "T" everywhere else for consistency.

Status
risheffi Completed 5/29/2006 6:51:30 PM

set to ILLEGAL REQUEST and the additional sense code set to INVALID FIELD IN PARAMETER LIST (see SPC-3).

This page contains no comments

1 SCSI Architectural Elements

2.1 Overview

3 Clause 5 defines SCSI/ATA translation elements that impact the representation of the storage domain in terms of elements defined in SAM-3.

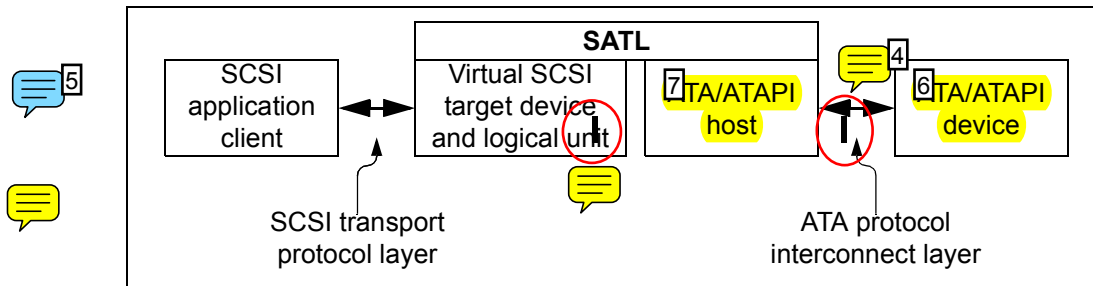

Figure 4 — SATL functional protocol reference model

Figure 4 shows a SATL connecting a SCSI application client to an ATA/ATAPI device. The SATL accomplishes this by:

- emulating a SCSI logical unit;
- integrating an ATA/ATAPI host; and
- providing the translation elements to link them together.
- This standard defines SCSI/ATA translation using SCSI and ATA command sets. This standard does not define the mapping of transport capabilities as defined at the SCSI Transport Protocol Layer and the ATA Protocol Interconnect Layer.

An implementation utilizing a SATL may or may not include a SCSI transport. Examples of a SATL implemented in accordance to this standard include:

- A SATL contained within a SCSI target comprised of ATA/ATAPI devices using a defined SCSI transport (e.g., Fibre Channel, SCSI parallel interface, or SBP-3);
- An ATA/ATAPI Host Bus Adapter (HBA) directly connected to ATA/ATAPI devices, and provides SCSI transport protocol layer services to a SCSI application client in accordance with SAM-3; and
- A SAS STP initiator port (see SAS-1.1) to connect ATA/ATAPI devices. The STP initiator port includes a SATL to provide the SCSI transport protocol layer services to the application client.

This standard defines SCSI/ATA Translation rules for:

- generating responses to SCSI task management requests;
- returning standard INQUIRY data and VPD pages;
- mapping of ATA IDENTIFY DEVICE data to common and protocol-specific VPD pages;
- mapping SCSI tasks to ATA commands (e.g., SATA NCQ);
- mapping SCSI mode page fields to the capabilities provided by underlying ATA devices;
- implementing mode pages, and the effects of mode page settings on ATA-domain operations;
- returning log pages;
- implementing read and write commands;
- implementing the ATA PASS-THROUGH command;
- returning SCSI sense data with respect to conditions that may occur in the ATA domain; and
- mapping ATA responses to SCSI responses.

5.2 Unit attention condition

The SATL shall report asynchronous events to SCSI application clients by emulating unit attention conditions (see SAM-3).

Sequence number: 1
Author: MXO[MEvans]
Subject: Highlight
Date: 2/8/2006 9:45:35 AM

T 5 SCSI Architectural Elements: remove the caps, changing the clause title to, "SCSI architectural elements".

Status
rlsheffi Completed 5/30/2006 8:17:16 AM

Sequence number: 2
Author: IBM[GPenokie]
Subject: Underline
Date: 2/16/2006 1:39:22 PM

T 5.1 Overview

Status
rlsheffi Cancelled 3/5/2006 10:12:46 AM

Sequence number: 3
Author: MXO[MEvans]
Subject: Highlight
Date: 5/30/2006 8:20:46 AM

T 5.1 [SCSI architectural elements] Overview, first paragraph: change to, "Clause 5 defines SCSI/ATA translation elements that impact the representation of the storage domains defined in SAM-3 and ATA8-AAM. Figure 4 shows a SATL connecting a SCSI application client to an ATA/ATAPI device.

RESOLUTION:

change to, "Clause 5 defines SCSI / ATA translation elements that impact the representation of the storage domains defined in SAM-3 and ATA8-AAM. Figure 4 shows a SATL providing a communication path between a SCSI application client and an ATA device or an ATAPI device.

Status
rlsheffi Completed 5/30/2006 8:20:50 AM

Sequence number: 4
Author: WDC[CStevens]
Subject: Note
Date: 2/13/2006 10:18:07 AM

 Remove artifacts...

Status
rlsheffi Completed 5/30/2006 8:21:02 AM

Sequence number: 5
Author: ENDL[RWeber]
Date: 2/14/2006 7:45:47 PM

 Figure 4

There are two vertical lines, one in the Virtual SCSI target ... box and one under the right-hand double arrowhead line. Remove them.

Status
rlsheffi Completed 5/30/2006 8:21:11 AM

Sequence number: 6
Author: EDITOR[rlsheffi]
Subject: Highlight
Date: 5/25/2006 10:30:26 AM

T 3.5.5 Use of field names defined in ATA standards and specifications

change
"ATA/ATAPI device"
to
"ATA device or ATAPI device"

For consistency with ATA8 definitions.

Status
rlsheffi Completed 5/30/2006 8:22:40 AM

Sequence number: 7

5 SCSI Architectural Elements

5.1 Overview

Clause 5 defines SCSI/ATA translation elements that impact the representation of the storage domain in terms of elements defined in SAM-3.

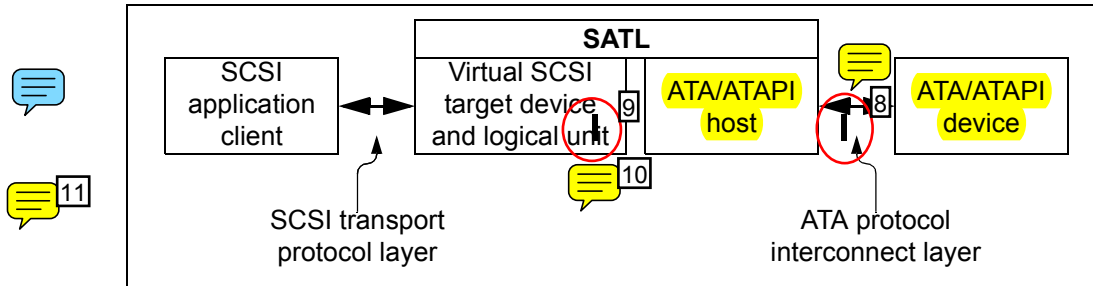

Figure 4 — SATL functional protocol reference model

Figure 4 shows a SATL connecting a SCSI application client to an ATA/ATAPI device. The SATL accomplishes this by:

- emulating a SCSI logical unit;
- integrating an ATA/ATAPI host; and
- providing the translation elements to link them together.
- This standard defines SCSI/ATA translation using SCSI and ATA command sets. This standard does not define the mapping of transport capabilities as defined at the SCSI Transport Protocol Layer and the ATA Protocol Interconnect Layer.

An implementation utilizing a SATL may or may not include a SCSI transport. Examples of a SATL implemented in accordance to this standard include:

- A SATL contained within a SCSI target comprised of ATA/ATAPI devices using a defined SCSI transport (e.g., Fibre Channel, SCSI parallel interface, or SBP-3);
- An ATA/ATAPI Host Bus Adapter (HBA) directly connected to ATA/ATAPI devices, and provides SCSI transport protocol layer services to a SCSI application client in accordance with SAM-3; and
- A SAS STP initiator port (see SAS-1.1) to connect ATA/ATAPI devices. The STP initiator port includes a SATL to provide the SCSI transport protocol layer services to the application client.

This standard defines SCSI/ATA Translation rules for:

- generating responses to SCSI task management requests;
- returning standard INQUIRY data and VPD pages;
- mapping of ATA IDENTIFY DEVICE data to common and protocol-specific VPD pages;
- mapping SCSI tasks to ATA commands (e.g., SATA NCQ);
- mapping SCSI mode page fields to the capabilities provided by underlying ATA devices;
- implementing mode pages, and the effects of mode page settings on ATA-domain operations;
- returning log pages;
- implementing read and write commands;
- implementing the ATA PASS-THROUGH command;
- returning SCSI sense data with respect to conditions that may occur in the ATA domain; and
- mapping ATA responses to SCSI responses.

5.2 Unit attention condition

The SATL shall report asynchronous events to SCSI application clients by emulating unit attention conditions (see SAM-3).

Author: EDITOR[rlsheffi]
Subject: Highlight
Date: 5/25/2006 10:27:06 AM

 Figure 4 - SAT functional protocol reference model
change
"ATA/ATAPI host"
to
"ATA host"

For consistency with ATA8 definitions.

Status
rlsheffi Completed 5/30/2006 8:22:55 AM

Sequence number: 8
Author: IBM[GPenokie]
Subject: Oval
Date: 2/15/2006 9:27:39 AM



Status
rlsheffi Completed 5/30/2006 8:23:06 AM

Sequence number: 9
Author: IBM[GPenokie]
Subject: Oval
Date: 2/15/2006 9:27:32 AM



Status
rlsheffi Completed 5/30/2006 8:24:57 AM

Sequence number: 10
Author: HPQ[RElliott]
Subject: Note
Date: 1/19/2006 9:14:36 AM



5.1
figure 4
remove extra lines in figure

Status
rlsheffi Completed 5/30/2006 8:25:09 AM

Sequence number: 11
Author: IBM[GPenokie]
Subject: Note
Date: 5/30/2006 8:30:01 AM



Figure 4
This figure has some strange fat lines in it that need to be removed.

Status
rlsheffi Completed 5/30/2006 8:25:17 AM

Sequence number: 12
Author: DELL[KMarks]
Subject: Highlight
Date: 5/25/2006 3:45:51 PM



Comment:
Figure 4 — SAT functional protocol reference model

1. Remove what look like change bars in Figure 4
2. Change "logical unit" to "logical unit(s)"
3. Change "ATA protocol interconnect layer" to "ATA transport protocol interconnect layer"

RESOLUTION:

Change the figure title to: "Figure 4 - Example of a SATL between a SCSI application client and an ATA or ATAPI device", fix change bars, and the change in item-3 as well.

Status
rlsheffi Completed 5/30/2006 8:29:17 AM

Sequence number: 13
Author: MXO[MEvans]
Subject: Highlight

Comments from page 37 continued on next page

5 SCSI Architectural Elements

5.1 Overview

Clause 5 defines SCSI/ATA translation elements that impact the representation of the storage domain in terms of elements defined in SAM-3.

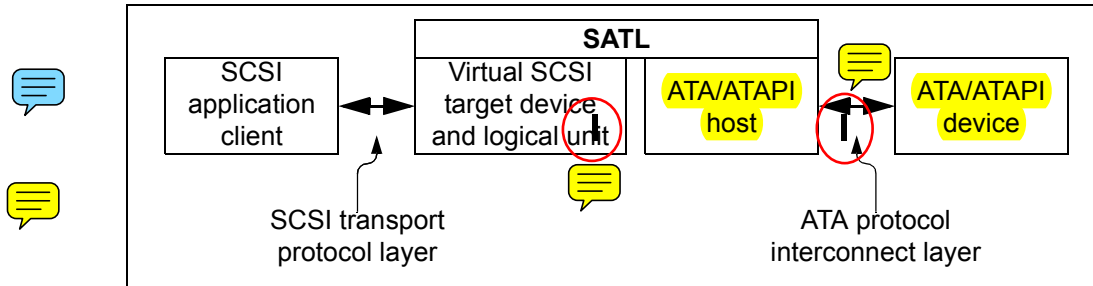

Figure 4 — SATL functional protocol reference model

Figure 4 shows a SATL connecting a SCSI application client to an ATA/ATAPI device. The SATL accomplishes this by:

- a) emulating a SCSI logical unit;
- b) integrating an ATA/ATAPI host; and
- c) providing the translation elements to link them together.

This standard defines SCSI/ATA translation using SCSI and ATA command sets. This standard does not define the mapping of transport capabilities as defined at the SCSI Transport Protocol Layer and the ATA Protocol Interconnect Layer.

An implementation utilizing a SATL may or may not include a SCSI transport. Examples of a SATL implemented in accordance to this standard include:

- a) A SATL contained within a SCSI target comprised of ATA/ATAPI devices using a defined SCSI transport (e.g., Fibre Channel, SCSI parallel interface, or SBP-3);
- b) An ATA/ATAPI Host Bus Adapter (HBA) directly connected to ATA/ATAPI devices, and provides SCSI transport protocol layer services to a SCSI application client in accordance with SAM-3; and
- c) A SAS STP initiator port (see SAS-1.1) to connect ATA/ATAPI devices. The STP initiator port includes a SATL to provide the SCSI transport protocol layer services to the application client.

This standard defines SCSI/ATA Translation rules for:

- a) generating responses to SCSI task management requests;
- b) returning standard INQUIRY data and VPD pages;
- c) mapping of ATA IDENTIFY DEVICE data to common and protocol-specific VPD pages;
- d) mapping SCSI tasks to ATA commands (e.g., SATA NCQ);
- e) mapping SCSI mode page fields to the capabilities provided by underlying ATA devices;
- f) implementing mode pages, and the effects of mode page settings on ATA-domain operations;
- g) returning log pages;
- h) implementing read and write commands;
- i) implementing the ATA PASS-THROUGH command;
- j) returning SCSI sense data with respect to conditions that may occur in the ATA domain; and
- k) mapping ATA responses to SCSI responses.

5.2 Unit attention condition

The SATL shall report asynchronous events to SCSI application clients by emulating unit attention conditions (see SAM-3).

Date: 5/25/2006 10:32:54 AM

T 5.1 [SCSI architectural elements] Overview, second paragraph: delete the first sentence ("Figure 4 shows a SATL connecting a SCSI application client to an ATA/ATAPI device.") as it is now included in the paragraph before the figure based on the previous comment. Change the remaining sentence to, "The SATL accomplishes this connection by:"

RESOLUTION: "The SATL provides the communication path between a SCSI application client and an ATA device or ATAPI device by:"

Status
risheffi Completed 5/30/2006 8:31:48 AM

Sequence number: 14
Author: ENDL[RWeber]
Date: 2/14/2006 7:46:55 PM
 1st a,b,c list under figure 4
List entry d) appears to be a regular paragraph, not a list entry.

Status
risheffi Completed 5/30/2006 8:32:34 AM

Sequence number: 15
Author: EDITOR[risheffi]
Subject: Highlight
Date: 5/25/2006 10:38:18 AM

T 5.1 Overview
First unordered list item b)
change
"ATA/ATAPI host"
to
"ATA host"
for consistency with ATA8 documents.

Status
risheffi Completed 5/30/2006 8:33:05 AM

Sequence number: 16
Author: DELL[KMarks]
Subject: Highlight
Date: 3/5/2006 11:57:49 AM

T In 5.1 Overview
2nd Paragraph, in b) and c)

move ";and" from b) to c) (fixing missing ";")
REASON: Correction is to terminate the list with item c). Item d) is not part of the list.

Status
risheffi Rejected 3/5/2006 11:57:13 AM

Sequence number: 17
Author: HPQ[RElliott]
Subject: Cross-Out
Date: 2/1/2006 1:17:41 PM

T 5.1

Delete d) - this should be a normal paragraph.

Status
risheffi Completed 5/30/2006 8:33:40 AM

Sequence number: 18
Author: MXO[MEvans]
Subject: Highlight
Date: 2/16/2006 8:06:05 AM

T 5.1 [SCSI architectural elements] Overview, second paragraph, list item (d): make this be a new paragraph and change to, "This standard defines SCSI/ATA translation using SCSI and ATA command sets. This standard does not define the mapping of transport capabilities as defined at the SCSI transport protocol layer and the ATA transport protocol layer."

Status
risheffi Completed 5/30/2006 8:34:52 AM

Sequence number: 19
Author: IBM[GPenokie]

Comments from page 37 continued on next page

5 SCSI Architectural Elements

5.1 Overview

Clause 5 defines SCSI/ATA translation elements that impact the representation of the storage domain in terms of elements defined in SAM-3.

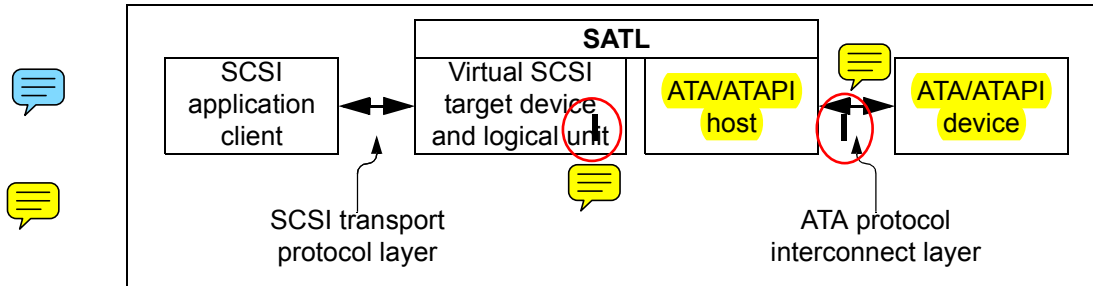

Figure 4 — SATL functional protocol reference model

Figure 4 shows a SATL connecting a SCSI application client to an ATA/ATAPI device. The SATL accomplishes this by:

- emulating a SCSI logical unit;
- integrating an ATA/ATAPI host; and
- providing the translation elements to link them together.
- This standard defines SCSI/ATA translation using SCSI and ATA command sets. This standard does not define the mapping of transport capabilities as defined in the SCSI Transport Protocol Layer and the ATA Protocol Interconnect Layer.

An implementation utilizing a SATL may ~~not~~ include a SCSI transport. Examples of a SATL implemented in accordance to this standard include:

- A SATL contained within a SCSI target comprised of ATA/ATAPI devices using a defined SCSI transport (e.g., Fibre Channel, SCSI parallel interface, or SBP-3);
- An ATA/ATAPI Host Bus Adapter (HBA) directly connected to ATA/ATAPI devices, and provides SCSI transport protocol layer services to a SCSI application client in accordance with SAM-3; and
- A SAS STP initiator port (see SAS-1.1) to connect ATA/ATAPI devices. The STP initiator port includes a SATL to provide the SCSI transport protocol layer services to the application client.

This standard defines SCSI/ATA Translation rules for:

- generating responses to SCSI task management requests;
- returning standard INQUIRY data and VPD pages;
- mapping of ATA IDENTIFY DEVICE data to common and protocol-specific VPD pages;
- mapping SCSI tasks to ATA commands (e.g., SATA NCQ);
- mapping SCSI mode page fields to the capabilities provided by underlying ATA devices;
- implementing mode pages, and the effects of mode page settings on ATA-domain operations;
- returning log pages;
- implementing read and write commands;
- implementing the ATA PASS-THROUGH command;
- returning SCSI sense data with respect to conditions that may occur in the ATA domain; and
- mapping ATA responses to SCSI responses.

5.2 Unit attention condition

The SATL shall report asynchronous events to SCSI application clients by emulating unit attention conditions (see SAM-3).

Subject: Note
Date: 2/15/2006 9:35:23 AM

 1st a,b,c list

Item d looks like it belongs as a separate paragraph under the list instead of part of list.

Status
r/sheffi Completed 5/30/2006 8:35:02 AM

Sequence number: 20
Author: DELL[KMarks]
Subject: Note
Date: 3/7/2006 9:16:00 AM

 Comment:
In 5.1 Overview
2nd Paragraph, in d)

the standard does seem to have transport specific capabilities relating to SAS, contradicting d)

RESOLUTION: remove "This standard doe not define the mapping of transport capabilities as defined at the SCSI Transport Protocol Layer and the ATA Protocol Interconnect Layer."

Status
r/sheffi Completed 5/30/2006 8:35:44 AM

Sequence number: 21
Author: DELL[KMarks]
Subject: Highlight
Date: 1/30/2006 10:15:57 AM

 In 5.1 Overview
2nd Paragraph, in d)
change

"... at the SCSI Transport Protocol Layer and the ATA Protocol Interconnect Layer."

to

"... at the SCSI transport protocol layer and the ATA transport protocol interconnect layer."

Status
r/sheffi Completed 5/30/2006 8:36:09 AM

Sequence number: 22
Author: DELL[KMarks]
Subject: Cross-Out
Date: 1/30/2006 10:20:49 AM

 In 5.1 Overview
2nd Paragraph, 1st Sentence
remove
"or may not"

Status
r/sheffi Completed 5/30/2006 8:39:28 AM

Sequence number: 23
Author: IBM[GPenokie]
Subject: Highlight
Date: 5/30/2006 8:17:09 PM

 When there is more than one examples listed like this in one subclause they need to be labeled and numbered as shown in the style guide

RESOLUTION:

Below are examples of SATLs implemented in accordance with this standard.

Example 1 - A SATL contained within a SCSI target device is comprised of ATA devices and/or ATAPI devices and is accessed by SCSI application clients through standard SCSI transport protocol (e.g., Fibre Channel, SCSI parallel interface, or SBP-3).

Example 2 - An ATA Host Bus Adapter (HBA) is directly connected to ATA/ATAPI devices and provides SCSI transport protocol layer services to a SCSI application client in accordance with SAM-3.

Example 3 - A SAS STP initiator port (see SAS-1.1) accesses ATA devices and/or ATAPI devices through a SAS service delivery subsystem. The STP initiator port includes a SATL to provide the SCSI transport

Comments from page 37 continued on next page

5 SCSI Architectural Elements

5.1 Overview

Clause 5 defines SCSI/ATA translation elements that impact the representation of the storage domain in terms of elements defined in SAM-3.

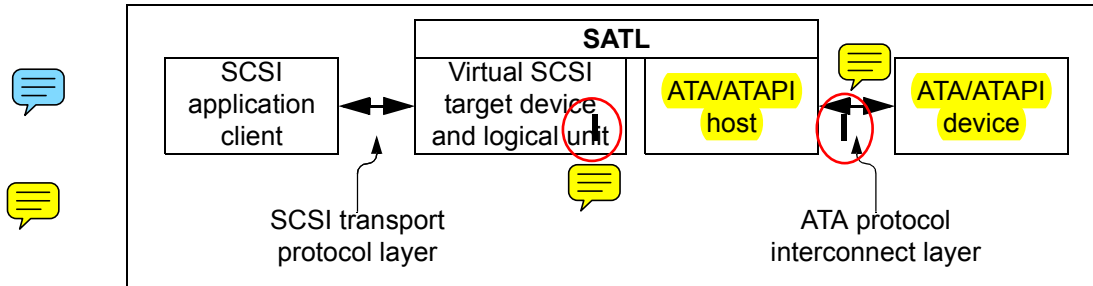

Figure 4 — SAT functional protocol reference model

Figure 4 shows a SATL connecting a SCSI application client to an ATA/ATAPI device. The SATL accomplishes this by:

- emulating a SCSI logical unit;
- integrating an ATA/ATAPI host; and
- providing the translation elements to link them together.
- This standard defines SCSI/ATA translation using SCSI and ATA command sets. This standard does not define the mapping of transport capabilities as defined at the SCSI Transport Protocol Layer and the ATA Protocol Interconnect Layer.

An implementation utilizing a SATL may or may not include a SCSI transport. Examples of a SATL implemented in accordance to this standard include:

- A SATL contained within a SCSI target comprised of ATA/ATAPI devices using a defined SCSI transport (e.g., Fibre Channel, SCSI parallel interface, or SBP-3);
- An ATA/ATAPI Host Bus Adapter (HBA) directly connected to ATA/ATAPI devices, which provides SCSI transport protocol layer services to a SCSI application client in accordance with SAM-3; and
- A SAS STP initiator port (see SAS-1.1) to connect ATA/ATAPI devices. The STP initiator port includes a SATL to provide the SCSI transport protocol layer services to the application client.

This standard defines SCSI/ATA Translation rules for:

- generating responses to SCSI task management requests;
- returning standard INQUIRY data and VPD pages;
- mapping of ATA IDENTIFY DEVICE data to common and protocol-specific VPD pages;
- mapping SCSI tasks to ATA commands (e.g., SATA NCQ);
- mapping SCSI mode page fields to the capabilities provided by underlying ATA devices;
- implementing mode pages, and the effects of mode page settings on ATA-domain operations;
- returning log pages;
- implementing read and write commands;
- implementing the ATA PASS-THROUGH command;
- returning SCSI sense data with respect to conditions that may occur in the ATA domain; and
- mapping ATA responses to SCSI responses.

5.2 Unit attention condition

The SATL shall report asynchronous events to SCSI application clients by emulating unit attention conditions (see SAM-3).

protocol layer services to the application client.
RESOLUTION: See 06-262

Status
rlsheffi Completed 7/23/2006 7:51:44 PM

Sequence number: 24
Author: EDITOR[rlsheffi]
Subject: Note
Date: 5/30/2006 12:45:24 PM

 DONE: Bring in figures from VPD data descriptions showing the three cases and cross-reference. Draft a proposal showing the changes. These figures will be a little different because they won't show the inquiry command specifics. So copy & simplify figures.
RESOLUTION: Modifications to resolve this comment are in 06-262.

Status
rlsheffi Completed 7/23/2006 7:51:58 PM

Sequence number: 25
Author: EDITOR[rlsheffi]
Subject: Highlight
Date: 5/30/2006 8:11:49 PM

T **5.1 Overview**
Second unordered list, list item a)
change
"ATA/ATAPI devices"
to
"ATA devices and/or ATAPI devices"
for consistency with ATA8 definitions.
RESOLUTION: See 06-262

Status
rlsheffi Completed 7/23/2006 7:52:33 PM

Sequence number: 26
Author: DELL[KMarks]
Subject: Highlight
Date: 5/30/2006 8:16:23 PM

T In 5.1 Overview
3rd paragraph, 2nd sentence in a)
change
"SCSI transport (e.g.,"
to
"SCSI transport protocol (e.g.,"
RESOLUTION: See 06-262

Status
rlsheffi Completed 7/24/2006 11:17:44 AM

Sequence number: 27
Author: MXO[MEvans]
Subject: Highlight
Date: 5/30/2006 8:16:54 PM

T 5.1 [SCSI architectural elements] Overview, third paragraph, list item (b): change "...and provides..." to "and providing...".
RESOLUTION: See 06-262

Status
rlsheffi Completed 7/24/2006 11:18:08 AM

Sequence number: 28
Author: EDITOR[rlsheffi]
Subject: Highlight
Date: 5/30/2006 8:29:01 PM

T **5.1 Overview**
Second unordered list, list item b)
change
"ATA/ATAPI devices,"
to
"ATA devices and/or ATAPI devices,"
for consistency with ATA8 definitions.
RESOLUTION: Modifications to resolve this comment are in 06-262.

5 SCSI Architectural Elements

5.1 Overview

Clause 5 defines SCSI/ATA translation elements that impact the representation of the storage domain in terms of elements defined in SAM-3.

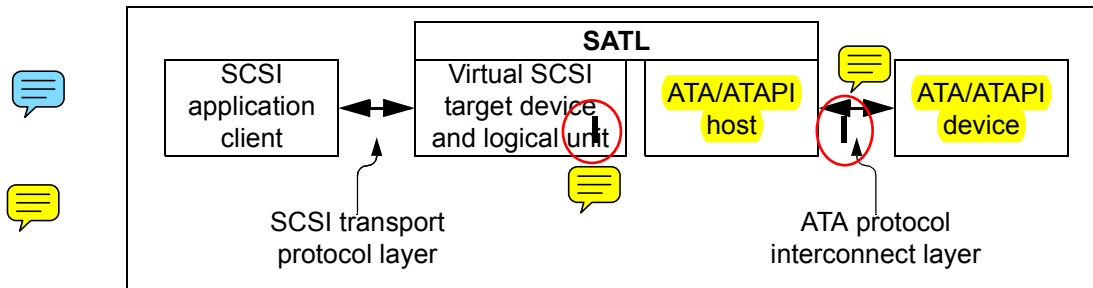

Figure 4 — SAT functional protocol reference model

Figure 4 shows a SATL connecting a SCSI application client to an ATA/ATAPI device. The SATL accomplishes this by:

- emulating a SCSI logical unit;
- integrating an ATA/ATAPI host; and
- providing the translation elements to link them together.
- This standard defines SCSI/ATA translation using SCSI and ATA command sets. This standard does not define the mapping of transport capabilities as defined at the SCSI Transport Protocol Layer and the ATA Protocol Interconnect Layer.

An implementation utilizing a SATL may or may not include a SCSI transport. Examples of a SATL implemented in accordance to this standard include:

- A SATL contained within a SCSI target comprised of ATA/ATAPI devices using a defined SCSI transport (e.g., Fibre Channel, SCSI parallel interface, or SBP-3);
- An ATA/ATAPI Host Bus Adapter (HBA) directly connected to ATA/ATAPI devices, and provides SCSI transport protocol layer services to a SCSI application client in accordance with SAM-3; and
- A SAS STP initiator port (see SAS-1.1) to connect ATA/ATAPI devices. The STP initiator port includes a SATL to provide the SCSI transport protocol layer services to the application client.

This standard defines SCSI/ATA Translation rules for:

- generating responses to SCSI task management requests;
- returning standard INQUIRY data and VPD pages;
- mapping of ATA IDENTIFY DEVICE data to common and protocol-specific VPD pages;
- mapping SCSI tasks to ATA commands (e.g., SATA NCQ);
- mapping SCSI mode page fields to the capabilities provided by underlying ATA devices;
- implementing mode pages, and the effects of mode page settings on ATA-domain operations;
- returning log pages;
- implementing read and write commands;
- implementing the ATA PASS-THROUGH command;
- returning SCSI sense data with respect to conditions that may occur in the ATA domain; and
- mapping ATA responses to SCSI responses.

5.2 Unit attention condition

The SATL shall report asynchronous events to SCSI application clients by emulating unit attention conditions (see SAM-3).

Status
rlsheffi Completed 7/24/2006 11:18:25 AM

Sequence number: 29
Author: EDITOR[rlsheffi]
Subject: Highlight
Date: 5/30/2006 8:29:18 PM

T 5.1 Overview

Second unordered list, list item b)
change
"ATA/ATAPI Host Bus Adapter"
to
"ATA Host Bus Adapter"
for consistency with ATA8 definitions.
RESOLUTION: Modifications to resolve this comment are in 06-262.

Status
rlsheffi Completed 7/24/2006 11:18:36 AM

Sequence number: 30
Author: EDITOR[rlsheffi]
Subject: Highlight
Date: 5/25/2006 11:17:20 AM

T 5.1 Overview

Second unordered list, list item c)
change
"ATA/ATAPI devices"
to
"ATA devices and/or ATAPI devices"
for consistency with ATA8 definitions.

Status
rlsheffi Completed 7/24/2006 11:18:54 AM

Sequence number: 31
Author: MXO[MEvans]
Subject: Highlight
Date: 5/30/2006 8:30:44 PM

T 5.1 [SCSI architectural elements] Overview, last paragraph: this appears to be a more detailed list of the elements in the first list in clause 4. This is another argument for removing the redundant information in clause 4 and moving what remains to clause 1.

RESOLUTION:
Merge with lists in clause 4 and the Scope, and move into scope. Come back to SAT WG with the list for approval.
DISCUSS: View changes in SAT draft

Status
rlsheffi Completed 5/29/2006 6:32:10 PM

Sequence number: 32
Author: IBM[GPenokie]
Subject: Underline
Date: 2/16/2006 1:45:37 PM

T 5.2 Unit attention condition

Status
rlsheffi Cancelled 3/5/2006 12:31:14 PM

Sequence number: 33
Author: DELL[KMarks]
Subject: Highlight
Date: 3/5/2006 1:04:50 PM

T 5.2 Unit attention condition 1st Sentence.

change
"...shall report asynchronous events to SCSI..."
to
"...shall report SCSI events to SCSI..."
RESOLUTION: "...shall report events affecting the state of the emulated SCSI device to the SCSI..."

Status

Comments from page 37 continued on next page

5 SCSI Architectural Elements

5.1 Overview

Clause 5 defines SCSI/ATA translation elements that impact the representation of the storage domain in terms of elements defined in SAM-3.

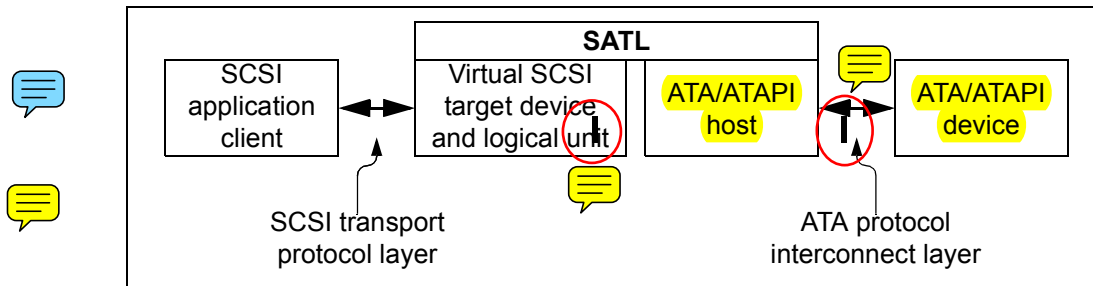

Figure 4 — SATL functional protocol reference model

Figure 4 shows a SATL connecting a SCSI application client to an ATA/ATAPI device. The SATL accomplishes this by:

- emulating a SCSI logical unit;
- integrating an ATA/ATAPI host; and
- providing the translation elements to link them together.
- This standard defines SCSI/ATA translation using SCSI and ATA command sets. This standard does not define the mapping of transport capabilities as defined at the SCSI Transport Protocol Layer and the ATA Protocol Interconnect Layer.

An implementation utilizing a SATL may or may not include a SCSI transport. Examples of a SATL implemented in accordance to this standard include:

- A SATL contained within a SCSI target comprised of ATA/ATAPI devices using a defined SCSI transport (e.g., Fibre Channel, SCSI parallel interface, or SBP-3);
- An ATA/ATAPI Host Bus Adapter (HBA) directly connected to ATA/ATAPI devices, and provides SCSI transport protocol layer services to a SCSI application client in accordance with SAM-3; and
- A SAS STP initiator port (see SAS-1.1) to connect ATA/ATAPI devices. The STP initiator port includes a SATL to provide the SCSI transport protocol layer services to the application client.

This standard defines SCSI/ATA Translation rules for:

- generating responses to SCSI task management requests;
- returning standard INQUIRY data and VPD pages;
- mapping of ATA IDENTIFY DEVICE data to common and protocol-specific VPD pages;
- mapping SCSI tasks to ATA commands (e.g., SATA NCQ);
- mapping SCSI mode page fields to the capabilities provided by underlying ATA devices;
- implementing mode pages, and the effects of mode page settings on ATA-domain operations;
- returning log pages;
- implementing read and write commands;
- implementing the ATA PASS-THROUGH command;
- returning SCSI sense data with respect to conditions that may occur in the ATA domain; and
- mapping ATA responses to SCSI responses.

5.2 Unit attention condition

The SATL shall report asynchronous events to SCSI application clients by emulating unit attention conditions³⁴ (see SAM-3).

risheffi Completed

5/30/2006 8:37:15 PM

Sequence number: 34

Author: ENDL[RWeber]

Date: 2/14/2006 7:49:10 PM



Mark the two-line paragraph that introduces this subclause "keep with next" so that it joins the main body of the subclause on the next page. This will not affect overall pagination because there is almost half a page of white space on the next page.

Status

risheffi Completed

5/30/2006 8:38:14 PM

A SATL that detects a link reset for a Serial ATA device or initiates any reset of an ATA/ATAPI device shall establish a unit attention condition on behalf of the logical unit corresponding to the ATA/ATAPI device with an additional sense code of POWER ON, RESET, OR BUS DEVICE RESET OCCURRED for the SCSI initiator port associated with each I_T nexus. The method a SATL uses to detect a link reset on the Serial ATA link is vendor specific.

A SATL shall establish a unit attention condition on behalf of the logical unit in response to a reset condition initiated by the ATA host on any logical unit corresponding to an ATA/ATAPI device on the PATA bus or on a SATA link for the SCSI initiator port associated with each I_T nexus.

The SATL shall report unit attention conditions, in accordance with SAM-3, even when the SCSI command being processed results in no action on the ATA interface (e.g., a READ (10) command with a transfer length of zero).

5.3 Handling errors in ATA commands

When a SCSI command is translated into one or more ATA commands and one of the ATA commands completes with an error, the SATL shall terminate processing of the SCSI command and report the error as described in Clause 11.

When interpreting data from an ATA command, the SATL shall use the data only if no error was reported for the command. In addition:

- a) when interpreting IDENTIFY DEVICE data and IDENTIFY PACKET DEVICE data, the SATL shall use the data only if the integrity word (word 255) contains the signature defined in ATA/ATAPI-7 and the checksum is correct;
- b) when interpreting SMART READ DATA data for the Summary SMART error log (i.e., log address 01h), the Comprehensive SMART error log (i.e., log address 02h), the SMART self-test log (i.e., log address 06h), or the Selective self-test log (i.e., log address 09h) (see ATA/ATAPI-7), the SATL shall use the data only if the data structure checksum byte (byte 511) is correct; and
- c) when interpreting READ LOG EXT data for Extended Comprehensive SMART error log (i.e., log address 03h) or Extended SMART self-test log (i.e., log address 07h) (see ATA/ATAPI-7), the SATL shall use the data only if the data structure checksum byte (byte 511) is correct.



Sequence number: 1
Author: EDITOR[rlsheffi]
Subject: Highlight
Date: 5/25/2006 11:27:24 AM

T **5.2 Unit attention condition**
First sentence of second paragraph
change
"ATA/ATAPI device"
to
"ATA device and/or ATAPI device"
for consistency with ATA8 definitions.

Status
rlsheffi Completed 5/30/2006 8:39:16 PM

Sequence number: 2
Author: EDITOR[rlsheffi]
Subject: Highlight
Date: 5/25/2006 11:26:54 AM

T **5.2 Unit attention condition**
First sentence of second paragraph (second occurrence)
change
"ATA/ATAPI device"
to
"ATA device and/or ATAPI device"
for consistency with ATA8 definitions.

Status
rlsheffi Completed 5/30/2006 8:39:54 PM

Sequence number: 3
Author: DELL[KMarks]
Subject: Highlight
Date: 3/7/2006 11:01:24 AM

T OK: Perhaps it should say "...establish a unit attention condition (see SPC-3) on behalf of the..."

5.2 Unit attention condition
2nd Paragraph, 1st Sentence

change
"...device with an additional sense code of POWER ON, RESET, OR BUS DEVICE RESET OCCURRED for the SCSI initiator..."
to
"...device with the sense key set to UNIT ATTENTION and the additional sense code set to POWER ON, RESET, OR BUS
DEVICE RESET OCCURRED for the SCSI initiator..."

REASON: SPC-3 specifies in several places to establish a unit attention condition, but does not, in that context, specify to set the sense key to UNIT ATTENTION. It would be redundant since it's already defined in the text that describes establishing a unit attention condition.

Status
rlsheffi Completed 5/30/2006 8:41:28 PM

Sequence number: 4
Author: IBM[GPenokie]
Subject: Highlight
Date: 2/15/2006 9:58:42 AM

T 2nd paragraph
This << ON, RESET, OR BUS DEVICE RESET >> should be << ON, RESET, or BUS DEVICE RESET >>.

Status
rlsheffi Completed 5/30/2006 8:42:04 PM

Sequence number: 5

A SATL that detects a link reset for a Serial ATA device or initiates any reset of an ATA/ATAPI device shall establish a unit attention condition on behalf of the logical unit corresponding to the ATA/ATAPI device with an additional sense code of POWER ON, RESET, OR BUS DEVICE RESET OCCURRED for the SCSI initiator port associated with each I_T nexus. The method a SATL uses to detect a link reset on the Serial ATA link is vendor specific.

A SATL shall establish a unit attention condition on behalf of the logical unit in response to a reset condition initiated by the ATA host on any logical unit corresponding to an ATA/ATAPI device on the PATA bus or on a SATA link for the SCSI initiator port associated with each I_T nexus.

The SATL shall report unit attention conditions, in accordance with SAM-3, even when the SCSI command being processed results in no action on the ATA interface (e.g., a READ (10) command with a transfer length of zero).

5.3 Handling errors in ATA commands

When a SCSI command is translated into one or more ATA commands and one of the ATA commands completes with an error, the SATL shall terminate processing of the SCSI command and report the error as described in Clause 11.

When interpreting data from an ATA command, the SATL shall use the data only if no error was reported for the command. In addition:

- a) when interpreting IDENTIFY DEVICE data and IDENTIFY PACKET DEVICE data, the SATL shall use the data only if the integrity word (word 255) contains the signature defined in ATA/ATAPI-7 and the checksum is correct;
- b) when interpreting SMART READ DATA data for the Summary SMART error log (i.e., log address 01h), the Comprehensive SMART error log (i.e., log address 02h), the SMART self-test log (i.e., log address 06h), or the Selective self-test log (i.e., log address 09h) (see ATA/ATAPI-7), the SATL shall use the data only if the data structure checksum byte (byte 511) is correct; and
- c) when interpreting READ LOG EXT data for Extended Comprehensive SMART error log (i.e., log address 03h) or Extended SMART self-test log (i.e., log address 07h) (see ATA/ATAPI-7), the SATL shall use the data only if the data structure checksum byte (byte 511) is correct.



Author: DELL[KMarks]
Subject: Note
Date: 3/5/2006 1:27:47 PM

 **5.2 Unit attention condition**

This seems to say the same as above. What reset condition initiated by the ATA host is not covered in the previous paragraph..

What reset condition can be initiated from the ATA host without the SATL's instructions to do so.

RESOLUTION: delete the paragraph: "A SATL shall establish a unit attention condition on behalf of the logical unit in response to a reset condition initiated by the ATA host on any logical unit corresponding to an ATA/ATAPI device on the PATA bus or on a SATA link for the SCSI initiator port associated with each I_T nexus."

Status
rlsheffi Completed 5/30/2006 8:43:04 PM

Sequence number: 6
Author: EDITOR[rlsheffi]
Subject: Highlight
Date: 5/30/2006 8:43:20 PM

 **5.2 Unit attention condition**

Third paragraph
change
"ATA/ATAPI device"

to
"ATA device and/or ATAPI device"
for consistency with ATA8 definitions.
RESOLUTION: Deleted paragraph.

Status
rlsheffi Completed 5/30/2006 8:43:24 PM

Sequence number: 7
Author: DELL[KMarks]
Subject: Note
Date: 4/10/2006 12:37:53 PM

 **5.2 Unit attention condition**

4th Paragraph.

after the SAM-3 does not seem to make sense to me, especially the e.g.. what does the READ(10) with a TR of zero have to do with a unit attention condition.

Are you trying to say that if a unit attention condition exists, then a unit attention shall be reported regardless if the SCSI command cause any action on the ATA/ATAPI device?

RESOLUTION (rls): "The SATL shall report unit attention conditions, in accordance with SAM-3, regardless of whether the condition results from accessing an ATA device or a condition internal to the SATL."

Status
rlsheffi Completed 5/30/2006 8:44:47 PM

Sequence number: 8
Author: DELL[KMarks]
Subject: Highlight
Date: 5/30/2006 8:45:48 PM

 **5.3 Handling errors in ATA commands**
1st paragraph, 1st sentence.

Should "Clause 11." be a link.

RESOLUTION (rls): Make "Clause 11" a link (and "Clause" s/b "clause")

Status
rlsheffi Completed 5/30/2006 8:45:26 PM

Sequence number: 9
Author: DELL[KMarks]
Subject: Highlight

Comments from page 38 continued on next page

A SATL that detects a link reset for a Serial ATA device or initiates any reset of an ATA/ATAPI device shall establish a unit attention condition on behalf of the logical unit corresponding to the ATA/ATAPI device with an additional sense code of POWER ON, RESET, OR BUS DEVICE RESET OCCURRED for the SCSI initiator port associated with each I_T nexus. The method a SATL uses to detect a link reset on the Serial ATA link is vendor specific.

A SATL shall establish a unit attention condition on behalf of the logical unit in response to a reset condition initiated by the ATA host on any logical unit corresponding to an ATA/ATAPI device on the PATA bus or on a SATA link for the SCSI initiator port associated with each I_T nexus.

The SATL shall report unit attention conditions, in accordance with SAM-3, even when the SCSI command being processed results in no action on the ATA interface (e.g., a READ (10) command with a transfer length of zero).

5.3 Handling errors in ATA commands

When a SCSI command is translated into one or more ATA commands and one of the ATA commands completes with an error, the SATL shall terminate processing of the SCSI command and report the error as described in Clause 11.

When interpreting data from an ATA command, the SATL shall use the data only if no error was reported for the command. In addition:

- a) when interpreting IDENTIFY DEVICE data and IDENTIFY PACKET DEVICE data, the SATL shall use the data only if the parity word (word 255) contains the signature defined in ATA/ATAPI-7 and the checksum is correct;
- b) when interpreting SMART READ DATA data for the Summary SMART error log (i.e., log address 01h), the Comprehensive SMART error log (i.e., log address 02h), the SMART self-test log (i.e., log address 06h), or the Selective self-test log (i.e., log address 09h) (see ATA/ATAPI-7), the SATL shall use the data only if the data structure checksum (byte 511) is correct; and
- c) when interpreting READ LOG EXT data for Extended Comprehensive SMART error log (i.e., log address 03h) or Extended SMART self-test log (i.e., log address 07h) (see ATA/ATAPI-7), the SATL shall use the data only if the data structure checksum (byte 511) is correct.



Date: 5/30/2006 8:48:04 PM

T 5.3 Handling errors in ATA commands

2nd Paragraph, 2nd Sentence in a) or a,b,c list
change
"and"
to
"or"

RESOLUTION: removed "and IDENTIFY PACKET DEVICE data"

Status

risheffi Completed 5/30/2006 8:46:11 PM

Sequence number: 10

Author: WDC[CStevens]

Subject: Comment on Text

Date: 2/13/2006 10:21:18 AM

T Global: We are not documenting ATAPI. References to PACKET should be removed.

Status

risheffi Completed 5/30/2006 8:48:13 PM

Sequence number: 11

Author: DELL[KMarks]

Subject: Note

Date: 5/25/2006 3:50:08 PM

T 5.3 Handling errors in ATA commands

2nd Paragraph, 2nd Sentence, a) in a,b,c list

The integrity word is optional in ATA/ATAPI-7, so this should not be a shall. You can reword and say that if bits (0:7) contain the signature (A5h) then only use if checksum is correct.

RESOLUTION (ris):

"when interpreting IDENTIFY DEVICE data, if the Integrity word contains the Signature value defined in ATA8-ACS (i.e., word 255 bits 0..7), then SATL shall use the data only if the Checksum is correct;"

Status

risheffi Completed 5/30/2006 8:49:04 PM

Sequence number: 12

Author: EDITOR[risheffi]

Subject: Highlight

Date: 5/25/2006 11:59:14 AM

T 5.3 Handling errors in ATA commands

First unordered list, list item a)

change
"ATA/ATAPI-7"
to
"ATA8-ACS"

for consistency with ATA8 definitions.

Status

risheffi Completed 5/30/2006 8:49:21 PM

Sequence number: 13

Author: EDITOR[risheffi]

Subject: Highlight

Date: 5/25/2006 11:54:34 AM

T 5.3 Handling errors in ATA commands

First unordered list, list item b)

change
"(see ATA/ATAPI-7),"
to
"(see ATA8-ACS),"

for consistency with ATA8 definitions.

Status

risheffi Completed 5/30/2006 8:49:58 PM

Sequence number: 14

Comments from page 38 continued on next page

A SATL that detects a link reset for a Serial ATA device or initiates any reset of an ATA/ATAPI device shall establish a unit attention condition on behalf of the logical unit corresponding to the ATA/ATAPI device with an additional sense code of POWER ON, RESET, OR BUS DEVICE RESET OCCURRED for the SCSI initiator port associated with each I_T nexus. The method a SATL uses to detect a link reset on the Serial ATA link is vendor specific.

A SATL shall establish a unit attention condition on behalf of the logical unit in response to a reset condition initiated by the ATA host on any logical unit corresponding to an ATA/ATAPI device on the PATA bus or on a SATA link for the SCSI initiator port associated with each I_T nexus.

The SATL shall report unit attention conditions, in accordance with SAM-3, even when the SCSI command being processed results in no action on the ATA interface (e.g., a READ (10) command with a transfer length of zero).

5.3 Handling errors in ATA commands

When a SCSI command is translated into one or more ATA commands and one of the ATA commands completes with an error, the SATL shall terminate processing of the SCSI command and report the error as described in Clause 11.

When interpreting data from an ATA command, the SATL shall use the data only if no error was reported for the command. In addition:

- a) when interpreting IDENTIFY DEVICE data and IDENTIFY PACKET DEVICE data, the SATL shall use the data only if the integrity word (word 255) contains the signature defined in ATA/ATAPI-7 and the checksum is correct;
- b) when interpreting SMART READ DATA data for the Summary SMART error log (i.e., log address 01h), the Comprehensive SMART error log (i.e., log address 02h), the SMART self-test log (i.e., log address 06h), or the Selective self-test log (i.e., log address 09h) (see ATA/ATAPI-7), the SATL shall use the data only if the data structure checksum byte (byte 511) is correct; and
- c) when interpreting READ LOG EXT data for Extended Comprehensive SMART error log (i.e., log address 03h) or Extended SMART self-test log (i.e., log address 07h) (see ATA/ATAPI-7), the SATL shall use the data only if the data structure checksum byte (byte 511) is correct.



Author: DELL[KMarks]
Subject: Cross-Out
Date: 3/5/2006 1:56:05 PM

 byte
RESOLUTION (rls):
s/b checksum (i.e., byte 511)

Status
rlsheffi Completed 5/30/2006 8:51:43 PM

Sequence number: 15
Author: EDITOR[rlsheffi]
Subject: Highlight
Date: 5/25/2006 11:56:18 AM

5.3 Handling errors in ATA commands

First unordered list, list item c)

change

"(see ATA/ATAPI-7)"

to

"(see ATA8-ACS)"

for consistency with ATA8 definitions.

Status
rlsheffi Completed 5/30/2006 8:51:43 PM

Sequence number: 16
Author: DELL[KMarks]
Subject: Cross-Out
Date: 3/5/2006 1:56:00 PM

 byte
RESOLUTION (rls):
s/b checksum (i.e., byte 511)

Status
rlsheffi Completed 5/30/2006 8:51:43 PM

Sequence number: 17
Author: Bill Martin
Subject: Note
Date: 9/13/2006 9:33:26 AM

In SAT-r08d 5.4 ATA nexus loss

If the ATA device is not physically present, allow Check Condition to be Hardware Error, Drive Not Present (04/93/00)

RESOLUTION - change

"A) if the SATL is able to determine that the ATA device is no longer physically present, REPORTED LUNS DATA HAS CHANGED; or

B) if the SATL is unable to determine if the ATA device is physically present or not, INQUIRY DATA HAS CHANGED."

to:

A) if the SATL is able to determine that the ATA device is no longer physically present, REPORTED LUNS DATA HAS CHANGED or DRIVE NOT PRESENT;

B) if the SATL is unable to determine if the ATA device is physically present or not, INQUIRY DATA HAS CHANGED; or

C) if the SATL is able to determine that the ATA device is present, INTERNAL TARGET FAILURE.

Status
rlsheffi Completed 9/13/2006 9:25:49 AM

6 Task Management Model

6.1 Overview

1 AT implementations may support the full task management model or the basic task management model as well as specific features of the task management model (e.g. SIMPLE and ORDERED task attributes) depending on the task management and queuing capabilities of the SATL and whether the SATL supports SATA native command queuing (NCQ) or the 2 ATA 3 3. Queued feature set (TCQ).

6.2 Queued commands

4 2.1 Comparison of SCSI and ATA queuing

Some differences between SCSI and ATA queuing methods are shown in Table 4. 5

Table 4 — Comparison of SCSI and ATA queuing methods

Feature	SCSI	7 ATA NCQ	6 ATA TCQ
Ordering	Specified by task attributes (e.g. SIMPLE, ORDERED) associated with each command	Always at the discretion of the device	Always at the discretion of the device
Queue Depth	Indeterminate	Fixed at 1 to 32 commands as reported by the IDENTIFY DEVICE command	Fixed at 1 to 32 commands as reported by the IDENTIFY DEVICE command
Queue Full Reporting	TASK SET FULL status	Treated as an error	Treated as an error
Queue Full Management	Device manages and indicates via TASK SET FULL status	Host manages	Host manages
Queued Commands	Queuing is applicable to all commands	Limited to READ FPDMA QUEUED and WRITE FPDMA QUEUED commands	Limited to READ DMA QUEUED, READ DMA QUEUED EXT, WRITE DMA QUEUED, WRITE DMA QUEUED EXT and WRITE DMA QUEUED FUA EXT commands
Handling of Non-Queued Commands	All commands are queued	Receipt of any command other than an NCQ queued command is treated as an error	Except for NOP with a non-zero subcommand, receipt of any command other than a TCQ queued command is treated as an error
Error Handling	Controlled with mode parameters	Any error aborts all queued commands	Any error aborts all queued commands

6.2.2 Mapping of SCSI queued commands to ATA queued commands

A SATL that translates SCSI tagged tasks to an ATA device using SATA NCQ or ATA TCQ, whether or not the SATL also queues commands internally, shall either:



Sequence number: 1
Author: DELL[KMarks]
Subject: Highlight
Date: 3/8/2006 10:05:13 AM

T 6.1 Overview
1st Paragraph, 1st Sentence

Spell out SAT or use SATL
RESOLUTION:
change "SAT implementations" to "A SATL".

Status
risheffi Completed 5/31/2006 11:25:58 AM

Sequence number: 2
Author: MXO[MEvans]
Subject: Highlight
Date: 5/31/2006 11:29:31 AM

T 6.1 [Task Management Model] Overview, first paragraph: change "ATA queued feature set" to "ATA Queued feature set".
RESOLUTION: changed to "ATA Tagged Command Queuing (TCQ) feature set", for consistency with ATA8-ACS.

Status
risheffi Completed 5/31/2006 11:29:34 AM

Sequence number: 3
Author: HPQ[RElliott]
Date: 5/31/2006 11:30:11 AM

T 6.1

queued s/b Queued
RESOLUTION: s/b "Tagged Command Queuing (TCQ) feature set" (see MXO comment).

Status
risheffi Completed 5/31/2006 11:30:14 AM

Sequence number: 4
Author: IBM[GPenokie]
Subject: Underline
Date: 2/16/2006 1:41:35 PM
T 6.2.1 Comparison of SCSI and ATA queuing

Status
risheffi Cancelled 3/8/2006 10:43:21 AM

Sequence number: 5
Author: IBM[GPenokie]
Subject: Oval
Date: 2/16/2006 8:41:01 AM

 Global
The capitalization of the references to tables is inconsistent. It should only be capitalized when it is the first word of a sentence.

Status
risheffi Completed 5/31/2006 11:30:44 AM

Sequence number: 6
Author: MXO[MEvans]
Subject: Highlight
Date: 3/8/2006 10:47:13 AM

T Table 4 and global: either change "ATA TCQ" to "TCQ" here and in several other places, or change the definition and abbreviation in clause 3 from "TCQ" to "ATA TCQ".
RESOLUTION (TO DO): Change column heading and other instances of "ATA TCQ" to "TCQ".

Status
risheffi Completed 5/31/2006 11:32:19 AM

Sequence number: 7
Author: MXO[MEvans]
Subject: Highlight
Date: 3/8/2006 10:49:06 AM

6 Task Management Model

6.1 Overview

SAT implementations may support the full task management model or the basic task management model as well as specific features of the task management model (e.g. SIMPLE and ORDERED task attributes) depending on the task management and queueing capabilities of the SATL and whether the SATL supports SATA native command queueing (NCQ) or the ATA queued feature set (TCQ).

6.2 Queued commands

6.2.1 Comparison of SCSI and ATA queuing

Some differences between SCSI and ATA queuing methods are shown in Table 4.

Table 4 — Comparison of SCSI and ATA queuing methods

Feature	SCSI	SATA NCQ	ATA TCQ
Ordering	Specified by task attributes (e.g. SIMPLE, ORDERED) associated with each command	Always at the discretion of the device	Always at the discretion of the device
Queue Depth	Indeterminate	Fixed at 1 to 32 commands ¹⁰ reported by the IDENTIFY DEVICE command	Fixed at 1 to 32 commands ⁹ reported by the IDENTIFY DEVICE command
Queue Full Reporting	TASK SET FULL status	¹¹ Treated as an error	Treated as an error
Queue Full Management	Device manages and indicates via TASK SET FULL status	Host manages	Host manages
Queued Commands	Queueing is applicable to all commands	Limited to READ FPDMA QUEUED and WRITE FPDMA QUEUED commands	Limited to READ DMA QUEUED, READ DMA QUEUED EXT, WRITE DMA QUEUED, WRITE DMA QUEUED EXT and WRITE DMA QUEUED FUA EXT commands
Handling of Non-Queued Commands	All commands are queued	Receipt of any command other than an NCQ queued command is treated as an error	Except for NOP with a non-zero subcommand, receipt of any command other than a TCQ queued command is treated as an error
Error Handling	Controlled with mode parameters	Any error aborts all queued commands	Any error aborts all queued commands

6.2.2 Mapping of SCSI queued commands to ATA queued commands

A SATL that translates SCSI tagged tasks to an ATA device using SATA NCQ or ATA TCQ, whether or not the SATL also queues commands internally, shall either:



T Table 4 and global: either change "SATA NCQ" to "NCQ" here and in several other places, or change the definition and abbreviation in clause 3 from "NCQ" to "SATA NCQ".

RESOLUTION (TO DO): Change column heading and other instances of "SATA NCQ" to "NCQ".

Status
risheffi Completed 5/31/2006 11:33:25 AM

Sequence number: 8
Author: DELL[KMarks]
Subject: Highlight
Date: 1/30/2006 2:22:00 PM

T In Table 4
Column: SCSI
Row: Ordering.

SIMPLE, ORDERED should be in small CAPS.

Status
risheffi Completed 5/31/2006 11:34:57 AM

Sequence number: 9
Author: DELL[KMarks]
Subject: Highlight
Date: 5/31/2006 11:35:52 AM

T In Table 4
Column: ATA TCQ
Row: Queue Depth

change
"...as reported by the IDENTIFY DEVICE
command"
to
"...as reported in the ATA IDENTIFY DEVICE data"

Status
risheffi Completed 5/31/2006 11:36:24 AM

Sequence number: 10
Author: DELL[KMarks]
Subject: Highlight
Date: 1/30/2006 2:21:41 PM

T In Table 4
Column: SATA NCQ
Row: Queue Depth

change
"...as reported by the IDENTIFY DEVICE
command"
to
"...as reported in the ATA IDENTIFY DEVICE
data"

Status
risheffi Completed 5/31/2006 11:36:54 AM

Sequence number: 11
Author: DELL[KMarks]
Subject: Highlight
Date: 3/9/2006 10:55:50 AM

T Coment:
In Table 4
Column: SATA NCQ and ATA TCQ
Row: Queue Full reporting

ATA devices do not report queue full, so how can it be treated as an error? It's not possible to issue more than 32 commands, if it did this would not be a queue full condition, but duplicate tags.

RESOLUTION: Replace "Treated as an error" with "n/a", in both places.

Comments from page 39 continued on next page

6 Task Management Model

6.1 Overview

SAT implementations may support the full task management model or the basic task management model as well as specific features of the task management model (e.g. SIMPLE and ORDERED task attributes) depending on the task management and queueing capabilities of the SATL and whether the SATL supports SATA native command queueing (NCQ) or the ATA queued feature set (TCQ).

6.2 Queued commands

6.2.1 Comparison of SCSI and ATA queuing

Some differences between SCSI and ATA queuing methods are shown in Table 4.

Table 4 — Comparison of SCSI and ATA queuing methods

Feature	SCSI	SATA NCQ	ATA TCQ
Ordering	Specified by task attributes (e.g. SIMPLE, ORDERED) associated with each command	Always at the discretion of the device	Always at the discretion of the device
Queue Depth	Indeterminate	Fixed at 1 to 32 commands as reported by the IDENTIFY DEVICE command	Fixed at 1 to 32 commands as reported by the IDENTIFY DEVICE command
Queue Full Reporting	TASK SET FULL status	Treated as an error	Treated as an error
Queue Full Management	Device manages and indicates via TASK SET FULL status	Host manages	Host manages
Queued Commands	Queueing is applicable to all commands	Limited to READ FPDMA QUEUED and WRITE FPDMA QUEUED commands	Limited to READ DMA QUEUED, READ DMA QUEUED EXT, WRITE DMA QUEUED, WRITE DMA QUEUED EXT and WRITE DMA QUEUED FUA EXT commands
Handling of Non-Queued Commands	All commands are queued	Receipt of any command other than an NCQ queued command is treated as an error	Receipt for NOP with a non-zero subcommand, receipt of any command other than a TCQ queued command is treated as an error
Error Handling	Controlled with mode parameters	Any error aborts all queued commands	Any error aborts all queued commands

6.2.2 Mapping of SCSI queued commands to ATA queued commands

A SATL that translates SCSI tagged tasks to an ATA device using SATA NCQ or ATA TCQ, whether or not the SATL also queues commands internally, shall either:



Status
r/sheffi Completed 5/31/2006 11:37:55 AM

Sequence number: 12
Author: DELL[KMarks]
Subject: Highlight
Date: 3/9/2006 7:08:16 AM

T In Table 4
Column: SATA NCQ and ATA TCQ
Row: Queue Full management

change
"Host manages"
to
"ATA Host manages"

RESOLUTION:
"ATA host managed"

Status
r/sheffi Completed 5/31/2006 11:38:44 AM

Sequence number: 13
Author: MXO[MEvans]
Subject: Highlight
Date: 3/9/2006 11:06:18 AM

T Table 4: change: Either add a definition for "TCQ command" and change this to, "Except for NOP with a non-zero subcommand code or a SERVICE command, receipt of any command other than a TCQ command is treated as an error." or change this to, "Receipt of any command except NOP with a non-zero subcommand code, SERVICE, READ DMA QUEUED, READ DMA QUEUED EXT, WRITE DMA QUEUED, WRITE DMA QUEUED EXT, or WRITE DMA QUEUED FUA EXT is treated as an error."
RESOLUTION: change to "Receipt of any command other than a NOP command with a non-zero subcommand code, a SERVICE command, a READ DMA QUEUED command, a READ DMA QUEUED EXT command, a WRITE DMA QUEUED command, a WRITE DMA QUEUED EXT command, or a WRITE DMA QUEUED FUA EXT command is an error."

Status
r/sheffi Completed 5/31/2006 11:40:53 AM

Sequence number: 14
Author: DELL[KMarks]
Subject: Highlight
Date: 3/9/2006 8:17:11 AM

T In Table 4
Column: SATA NCQ and ATA TCQ
Row: Handling of Non-Queued Commands

Need to add when a Queued command is present, queued, active, etc or else the non-queued command does not end in error.

RESOLUTION: handled by resolution of STX comment on same row of table.

Status
r/sheffi Completed 5/31/2006 11:43:30 AM

Sequence number: 15
Author: MXO[MEvans]
Subject: Highlight
Date: 3/9/2006 11:04:33 AM

T Table 4: either add a definition for "NCQ command" and change this to, "Receipt of any command other than an NCQ command is treated as an error.", or change this to, "Receipt of any command other than a READ FPDMA QUEUED or WRITE FPDMA QUEUED command is treated as an error."

RESOLUTION:
"Receipt of any command other than a READ FPDMA QUEUED command or a WRITE FPDMA QUEUED command is an error."

Status
r/sheffi Completed 5/31/2006 11:43:45 AM

Sequence number: 16
Author: STX[GHolder]
Subject: Highlight
Date: 3/9/2006 10:59:03 AM

T PDF page 39
Table 4, 'Feature' column

Comments from page 39 continued on next page

6 Task Management Model

6.1 Overview

SAT implementations may support the full task management model or the basic task management model as well as specific features of the task management model (e.g. SIMPLE and ORDERED task attributes) depending on the task management and queueing capabilities of the SATL and whether the SATL supports SATA native command queueing (NCQ) or the ATA queued feature set (TCQ).

6.2 Queued commands

6.2.1 Comparison of SCSI and ATA queuing

Some differences between SCSI and ATA queuing methods are shown in Table 4.

Table 4 — Comparison of SCSI and ATA queuing methods

Feature	SCSI	SATA NCQ	ATA TCQ
Ordering	Specified by task attributes (e.g. SIMPLE, ORDERED) associated with each command	Always at the discretion of the device	Always at the discretion of the device
Queue Depth	Indeterminate	Fixed at 1 to 32 commands as reported by the IDENTIFY DEVICE command	Fixed at 1 to 32 commands as reported by the IDENTIFY DEVICE command
Queue Full Reporting	TASK SET FULL status	Treated as an error	Treated as an error
Queue Full Management	Device manages and indicates via TASK SET FULL status	Host manages	Host manages
Queued Commands	Queueing is applicable to all commands	Limited to READ FPDMA QUEUED and WRITE FPDMA QUEUED commands	Limited to READ DMA QUEUED, READ DMA QUEUED EXT, WRITE DMA QUEUED, WRITE DMA QUEUED EXT and WRITE DMA QUEUED FUA EXT commands
Handling of Non-Queued Commands	All commands are queued	Receipt of any command other than an NCQ queued command is treated as an ¹⁷ or	Except for NOP with a non-zero subcommand, receipt of any command other than a TCQ queued command is treated as an ¹⁸ or
Error Handling	Controlled with mode parameters	Any error aborts all queued commands	Any error aborts all queued commands

6.2.2 Mapping of SCSI queued commands to ATA queued commands

A SATL that translates SCSI tagged tasks to an ATA device using SATA NCQ or ATA TCQ, whether or not the SATL also queues commands internally, shall either:

¹⁹

Change "Handling of Non-Queued Commands" to
"Handling of Non-Queued Commands While a Queued Command is
in Process"

RESOLUTION: "Handling of non-queued commands received while one or more queued commands are being processed"

Status

rlsheffi Completed 5/31/2006 11:43:51 AM

Sequence number: 17

Author: WDC[CStevens]

Subject: Comment on Text

Date: 3/9/2006 11:11:34 AM

 Comment: and aborts the entire queue

REASON: see next row (Error Handling)

Status

rlsheffi Rejected 3/9/2006 11:10:15 AM

Sequence number: 18

Author: WDC[CStevens]

Subject: Comment on Text

Date: 3/9/2006 11:10:00 AM

 Comment:

and aborts the entire queue

REASON: see next row (Error Handling)

Status

rlsheffi Rejected 3/9/2006 11:10:31 AM

Sequence number: 19

Author: ENDL[RWeber]

Date: 2/14/2006 7:53:52 PM

 There should not be a page break between the first entry of an a,b,c list and the text that introduces the list.

Status

rlsheffi Completed 5/31/2006 11:58:27 AM

- a) **2**port support for the basic task management model in **1** SCSI standard INQUIRY data (i.e., the BQUE bit is set to one and CMDQUE bit is set to zero), and follow the rules for the basic task management model (see SAM-3); or
- b) **4**port support for the full task management model in **3** SCSI standard INQUIRY data (i.e., the BQUE bit is set to zero and CMDQUE bit is set to one), and report 01b in the Queue error management (QERR) field of the SCSI Control mode page.

A SATL that supports SATA NCQ or ATA TCQ may report support for the full task management model with a QERR field set to a value other than 01b only if the SATL reissues all queued commands aborted by the ATA device due to an error condition reported by the ATA device on any one of the queued commands.

Error conditions with outstanding commands to an attached ATA device generally affect all outstanding commands being processed by the ATA device. See ATA/ATAPI-7 or SATA-2 for a description of how to determine the status of each command.

For each SCSI tagged task the SATL translates to an ATA device using SATA NCQ or ATA TCQ, the SATL shall allocate an inactive tag value (e.g. for NCQ, corresponding to an available bit in the reserved field of the SActive register). The SATL shall maintain a mapping between allocated NCQ or TCQ tags and the corresponding SCSI task tags.

The SATL shall detect the maximum queue depth supported by the ATA device (i.e., check word 75 in IDENTIFY DEVICE data), and may either:

- a) report a status of TASK SET FULL in response to a SCSI command issued to the corresponding emulated SCSI device when the ATA device represented has the maximum number of queued commands outstanding; or
- b) queue the command internally and return TASK SET FULL status when the SATL exhausts its internal queueing resources.

6.2.3 Commands the SATL queues internally

When queued commands are outstanding to the ATA device and new commands are received by the SATL that cannot be queued by the ATA device, the SATL shall queue the commands internally, or return a TASK SET FULL or BUSY status until at least one queued command has been completed. The SATL shall defer processing of the newly received non queued commands until the queued commands complete processing. The SATL shall perform task management in accordance with the reported task management model supported in accordance with the requirements in SAM-3.

If the SATL supports queued commands and the translation requires a mix of queued and non queued commands the SATL shall defer processing of subsequent commands, complete processing of all outstanding queued commands, process the non queued command, and then continue processing the previously deferred commands.

6.2.4 Multi-initiator and multi-port command queueing

If the SATL is accessed through a SCSI target port the SATL may be accessible by more than one SCSI initiator port and through more than one SCSI target port. As specified in SAM-3, the task tags maintained in the SATL mapping of task tags to NCQ tags or TCQ tags shall be qualified by the I_T_nexus from which the command was received. When translating from an NCQ tag or TCQ tag to the corresponding SCSI task tag, the SATL shall determine the correct SCSI I_T_nexus using the qualification information associated with the SCSI task tag. The SATL may return TASK SET FULL even if the SATA device has available NCQ tags or TCQ tags in order to maintain tags available for other initiators.

6.3 Task management functions

6.3.1 Task management functions overview

This subclause describes the translation of SCSI task management functions to ATA or SATA equivalents.

NOTE 2 - Due to architectural differences, some task management functions may not be successfully translated to ATA commands or control operations.

Sequence number: 1
Author: DELL[KMarks]
Subject: Cross-Out
Date: 1/30/2006 2:24:02 PM

 TSCSI

Status
risheffi Completed 5/31/2006 11:58:59 AM

Sequence number: 2
Author: DELL[KMarks]
Subject: Highlight
Date: 1/30/2006 2:26:19 PM

 **6.2.2 Mapping of SCSI queued commands to ATA queued commands**
1st Paragraph, 1st Sentence, in a) of a,b list

change
"report"
to
"Indicate"

Status
risheffi Completed 5/31/2006 11:59:19 AM

Sequence number: 3
Author: DELL[KMarks]
Subject: Cross-Out
Date: 1/30/2006 2:24:04 PM

 TSCSI

Status
risheffi Completed 5/31/2006 12:00:16 PM

Sequence number: 4
Author: DELL[KMarks]
Subject: Highlight
Date: 1/30/2006 2:26:27 PM

 **6.2.2 Mapping of SCSI queued commands to ATA queued commands**
1st Paragraph, 1st Sentence, in b) of a,b list

change
"report"
to
"Indicate"

Status
risheffi Completed 5/31/2006 12:01:04 PM

Sequence number: 5
Author: EDITOR[risheffi]
Subject: Rectangle
Date: 6/1/2006 11:47:56 AM

 RESOLUTION: s/b

"b) indicate support for the full task management model in SCSI standard INQUIRY data (i.e., the BQUE bit is set to zero and CMDQUE bit is set to one), and set the QERR (Queue error management) field of the Control mode page (see 10.1.4) as follows:
A) a value of 01b if the SATL does not reissue ATA queued commands aborted by the ATA device due to an error condition on any one of the ATA queued commands; or
B) a value other than 01b if the SATL reissues all other ATA queued commands (i.e. except the one in error) aborted by the ATA device due to an error condition on any one of the ATA queued commands."
See 06-179 for combined changes.

Status
risheffi Completed 5/31/2006 12:07:51 PM

Sequence number: 6
Author: DELL[KMarks]
Subject: Note
Date: 6/1/2006 11:49:00 AM

- a) report support for the basic task management model in SCSI standard INQUIRY data (i.e., the BQUE bit is set to one and CMDQUE bit is set to zero), and follow the rules for the basic task management model (see SAM-3); or
- b) report support for the full task management model in SCSI standard INQUIRY data (i.e., the BQUE bit is set to zero and CMDQUE bit is set to one), and report 01b in the Queue error management (QERR) field of the SCSI Control Mode page.

9. SATL that supports SATA NCQ or ATA TCQ may report support for the full task management model with a QERR field set to a value other than 01b only if 10. SATL reissues all queued commands aborted by the ATA device due to an error condition reported by the ATA device on any one of the queued commands.

Error conditions with outstanding commands to an attached ATA device 11. generally affect all outstanding commands being processed by the ATA device. See ATA/ATAPI-7 or SATA-2 for a description of how to determine the status of each command. 12.

For each SCSI tagged task the SATL translates to an ATA device using SATA NCQ or ATA TCQ, the SATL shall allocate an inactive tag value (e.g. for NCQ, corresponding to an available bit in the reserved field of the SActive register). The SATL shall maintain a mapping between allocated NCQ or TCQ tags and the corresponding SCSI task tags.

The SATL shall detect the maximum queue depth supported by the ATA device (i.e., check word 75 in IDENTIFY DEVICE data), and may either:

- a) report a status of TASK SET FULL in response to a SCSI command issued to the corresponding emulated SCSI device when the ATA device represented has the maximum number of queued commands outstanding; or
- b) queue the command internally and return TASK SET FULL status when the SATL exhausts its internal queueing resources.

6.2.3 Commands the SATL queues internally

When queued commands are outstanding to the ATA device and new commands are received by the SATL that cannot be queued by the ATA device, the SATL shall queue the commands internally, or return a TASK SET FULL or BUSY status until at least one queued command has been completed. The SATL shall defer processing of the newly received non queued commands until the queued commands complete processing. The SATL shall perform task management in accordance with the reported task management model supported in accordance with the requirements in SAM-3.

If the SATL supports queued commands and the translation requires a mix of queued and non queued commands the SATL shall defer processing of subsequent commands, complete processing of all outstanding queued commands, process the non queued command, and then continue processing the previously deferred commands.

6.2.4 Multi-initiator and multi-port command queuing

If the SATL is accessed through a SCSI target port the SATL may be accessible by more than one SCSI initiator port and through more than one SCSI target port. As specified in SAM-3, the task tags maintained in the SATL mapping of task tags to NCQ tags or TCQ tags shall be qualified by the I_T_nexus from which the command was received. When translating from an NCQ tag or TCQ tag to the corresponding SCSI task tag, the SATL shall determine the correct SCSI I_T_nexus using the qualification information associated with the SCSI task tag. The SATL may return TASK SET FULL even if the SATA device has available NCQ tags or TCQ tags in order to maintain tags available for other initiators.

6.3 Task management functions

6.3.1 Task management functions overview

This subclause describes the translation of SCSI task management functions to ATA or SATA equivalents.

NOTE 2 - Due to architectural differences, some task management functions may not be successfully translated to ATA commands or control operations.

 **6.2.2 Mapping of SCSI queued commands to ATA queued commands**
1st Paragraph, 1st Sentence, in b) and Paragraph 2

These two statements seem to contradict each other. b) says QERR shall be set to 01b and paragraph 2 say QERR may be set to values other than 01b provided

RESOLUTION: See 06-179

Status
rlsheffi Completed 5/31/2006 12:08:02 PM

Sequence number: 7
Author: DELL[KMarks]
Subject: Highlight
Date: 6/1/2006 11:49:28 AM
 **6.2.2 Mapping of SCSI queued commands to ATA queued commands**
1st Paragraph, 1st Sentence, in b) of a,b list

change

"...and report 01b in the Queue error management (QERR) field of the SCSI Control mode page."

to

"...and the QERR (Queue error management) field set to 01b in the Control mode page (see SPC-3)."

RESOLUTION: See 06-179

Status
rlsheffi Completed 5/31/2006 12:10:11 PM

Sequence number: 8
Author: HPQ[RElliott]
Date: 6/1/2006 11:50:15 AM

 6.2.2
After "mode page" add "(see 10.1.4)"
RESOLUTION: see 06-179

Status
rlsheffi Completed 5/31/2006 12:10:28 PM

Sequence number: 9
Author: SIERLGC[BMartin]
Subject: Note
Date: 6/1/2006 11:51:59 AM
 Page 20, 6.2.2 paragraph after first a-b list
All commands except the one in error shall be reissued.
RESOLUTION: see 06-179

Status
rlsheffi Completed 5/31/2006 12:10:53 PM

Sequence number: 10
Author: MXO[MEvans]
Subject: Highlight
Date: 6/1/2006 11:55:20 AM
 6.2.2 Mapping of SCSI queued commands to ATA queued commands, second paragraph and global: This is the first of many instances where the term "queued command" is used ("...the SATL reissues all queued commands aborted by the ATA device...") where "ATA queued command" as defined in clause 3 is intended. Change this instance to "ATA queued command", and check all other occurrences of the term and change to "ATA queued command" or otherwise correct as necessary.
DONE: find all occurrences of "queued command" without the preceding "ATA" and change to "ATA queued command" if that's what was intended.
RESOLUTION: see 06-179

Status
rlsheffi Completed 5/31/2006 12:39:11 PM

Sequence number: 11
Author: MXO[MEvans]
Subject: Cross-Out
Date: 6/1/2006 11:56:13 AM
 6.2.2 Mapping of SCSI queued commands to ATA queued commands, third paragraph: delete "generally".
RESOLUTION: see 06-179

Status
rlsheffi Completed 5/31/2006 12:40:02 PM

Sequence number: 12
Author: EDITOR[rlsheffi]

Comments from page 40 continued on next page

- a) report support for the basic task management model in SCSI standard INQUIRY data (i.e., the BQUE bit is set to one and CMDQUE bit is set to zero), and follow the rules for the basic task management model (see SAM-3); or
- b) report support for the full task management model in SCSI standard INQUIRY data (i.e., the BQUE bit is set to zero and CMDQUE bit is set to one), and report 01b in the Queue error management (QERR) field of the SCSI Control mode page.

A SATL that supports SATA NCQ or ATA TCQ may report support for the full task management model with a QERR field set to a value other than 01b only if the SATL reissues all queued commands aborted by the ATA device due to an error condition reported by the ATA device on any one of the queued commands.

Error conditions with outstanding commands to an attached ATA device generally affect all outstanding commands being processed by the ATA device. See ATA/ATAPI-7 or ATA-2 for a description of how to determine the status of each command.

For each SCSI tagged task the SATL translates to an ATA device using SATA NCQ or ATA TCQ, the SATL shall allocate an active tag value (e.g. for NCQ, corresponding to an available bit in the reserved field of the SActive register). The SATL shall maintain a mapping between allocated NCQ or TCQ tags and the corresponding SCSI task tags.

The SATL shall detect the maximum queue depth supported by the ATA device (i.e., check word 75 in IDENTIFY DEVICE data), and may either:

- a) report a status of TASK SET FULL in response to a SCSI command issued to the corresponding emulated SCSI device when the ATA device represented has the maximum number of queued commands outstanding; or
- b) queue the command internally and return TASK SET FULL status when the SATL exhausts its internal queueing resources.

6.2.3 Commands the SATL queues internally

When queued commands are outstanding to the ATA device and new commands are received by the SATL that cannot be queued by the ATA device, the SATL shall queue the commands internally, or return a TASK SET FULL or BUSY status until at least one queued command has been completed. The SATL shall defer processing of the newly received non queued commands until the queued commands complete processing. The SATL shall perform task management in accordance with the reported task management model supported in accordance with the requirements in SAM-3.

If the SATL supports queued commands and the translation requires a mix of queued and non queued commands the SATL shall defer processing of subsequent commands, complete processing of all outstanding queued commands, process the non queued command, and then continue processing the previously deferred commands.

6.2.4 Multi-initiator and multi-port command queuing

If the SATL is accessed through a SCSI target port the SATL may be accessible by more than one SCSI initiator port and through more than one SCSI target port. As specified in SAM-3, the task tags maintained in the SATL mapping of task tags to NCQ tags or TCQ tags shall be qualified by the I_T_nexus from which the command was received. When translating from an NCQ tag or TCQ tag to the corresponding SCSI task tag, the SATL shall determine the correct SCSI I_T_nexus using the qualification information associated with the SCSI task tag. The SATL may return TASK SET FULL even if the SATA device has available NCQ tags or TCQ tags in order to maintain tags available for other initiators.

6.3 Task management functions

6.3.1 Task management functions overview

This subclause describes the translation of SCSI task management functions to ATA or SATA equivalents.

NOTE 2 - Due to architectural differences, some task management functions may not be successfully translated to ATA commands or control operations.

Subject: Rectangle
Date: 6/1/2006 12:01:56 PM

 Change,

"Error conditions with outstanding commands to an attached ATA device generally affect all outstanding commands being processed by the ATA device. See ATA/ATAPI-7 or SATA-2 for a description of how to determine the status of each command."
to

"Error conditions with outstanding ATA commands to an ATA device affect all outstanding ATA commands being processed by the ATA device. An ATA host determines the status and error for each outstanding ATA queued command affected by the error condition and which ATA command(s) caused the error(s) (see ATA8-ACS or SATA 2.5)."

RESOLUTION: see 06-179

Status
rlsheffi Completed 5/31/2006 12:43:06 PM

Sequence number: 13
Author: DELL[KMarks]
Subject: Highlight
Date: 6/1/2006 12:02:43 PM

 **6.2.2 Mapping of SCSI queued commands to ATA queued commands**
3rd Paragraph, 2st Sentence

change
"SATA-2"

to

"SATA-2.5"

RESOLUTION: change to "SATA 2.5" (i.e., no "-"), see 06-179

Status
rlsheffi Completed 5/31/2006 12:43:33 PM

Sequence number: 14
Author: WDC[CStevens]
Subject: Comment on Text
Date: 6/1/2006 12:04:28 PM

 What is an inactive tag? This is the only use of the term inactive tag...
RESOLUTION: change "inactive tag" to "available tag", see 06-179

Status
rlsheffi Completed 5/31/2006 12:45:16 PM

Sequence number: 15
Author: DELL[KMarks]
Subject: Highlight
Date: 6/1/2006 12:08:18 PM

 **6.2.2 Mapping of SCSI queued commands to ATA queued commands**
4th Paragraph, 1st Sentence

Not sure what the reserved field in e.g. is? Inactive tags are bit positions set to 0 in the host's SActive register.

"value (e.g. for NCQ, corresponding to an available bit in the reserved field of the SActive register)."

RESOLUTION: change "value (e.g. for NCQ, corresponding to an available bit in the reserved field of the SActive register)." to "value (e.g. for NCQ, the value corresponding to the position of a bit set to zero in the SActive register)."

See 06-179

Status
rlsheffi Completed 5/31/2006 12:46:20 PM

Sequence number: 16
Author: EDITOR[rlsheffi]
Subject: Note
Date: 6/2/2006 12:50:46 PM

 Draft a proposal with a new subclause (or two) to spell out how to deal with ATA collateral aborts due to an error processing a queued command with and without ATA command retry. Should mirror what's described in 06-179.

Include appropriate cross-references with clause 11.

DISCUSS: see 06-179.

Status

Comments from page 40 continued on next page

- a) report support for the basic task management model in SCSI standard INQUIRY data (i.e., the BQUE bit is set to one and CMDQUE bit is set to zero), and follow the rules for the basic task management model (see SAM-3); or
- b) report support for the full task management model in SCSI standard INQUIRY data (i.e., the BQUE bit is set to zero and CMDQUE bit is set to one), and report 01b in the Queue error management (QERR) field of the SCSI Control mode page.

A SATL that supports SATA NCQ or ATA TCQ may report support for the full task management model with a QERR field set to a value other than 01b only if the SATL reissues all queued commands aborted by the ATA device due to an error condition reported by the ATA device on any one of the queued commands.

Error conditions with outstanding commands to an attached ATA device generally affect all outstanding commands being processed by the ATA device. See ATA/ATAPI-7 or SATA-2 for a description of how to determine the status of each command.

For each SCSI tagged task the SATL translates to an ATA device using SATA NCQ or ATA TCQ, the SATL shall allocate an inactive tag value (e.g. for NCQ, corresponding to an available bit in the reserved field of the SActive register). The SATL shall maintain a mapping between allocated NCQ or TCQ tags and the corresponding SCSI task tags.

The SATL shall detect the maximum queue depth supported by the ATA device (i.e., check word 75 in IDENTIFY DEVICE data), and may either:

- a) report a status of TASK SET FULL in response to a SCSI command issued to the corresponding emulated SCSI device when the ATA device represented has the maximum number of queued commands outstanding; or
- b) queue the command internally and return TASK SET FULL status when the SATL exhausts internal queueing resources.

6.2.3 Commands the SATL queues internally

When queued commands are outstanding to the ATA device and new commands are received by the SATL that cannot be queued by the ATA device, the SATL shall queue the commands internally, or return a TASK SET FULL or BUSY status until at least one queued command has been completed. The SATL shall defer processing of the newly received non queued commands until the queued commands complete processing. The SATL shall perform task management in accordance with the reported task management model supported in accordance with the requirements in SAM-3.

If the SATL supports queued commands and the translation requires a mix of queued and non queued commands the SATL shall defer processing of subsequent commands, complete processing of all outstanding queued commands, process the non queued command, and then continue processing the previously deferred commands.

6.2.4 Multi-initiator and multi-port command queuing

If the SATL is accessed through a SCSI target port the SATL may be accessible by more than one SCSI initiator port and through more than one SCSI target port. As specified in SAM-3, the task tags maintained in the SATL mapping of task tags to NCQ tags or TCQ tags shall be qualified by the I_T_nexus from which the command was received. When translating from an NCQ tag or TCQ tag to the corresponding SCSI task tag, the SATL shall determine the correct SCSI I_T_nexus using the qualification information associated with the SCSI task tag. The SATL may return TASK SET FULL even if the SATA device has available NCQ tags or TCQ tags in order to maintain tags available for other initiators.

6.3 Task management functions

6.3.1 Task management functions overview

This subclause describes the translation of SCSI task management functions to ATA or SATA equivalents.

NOTE 2 - Due to architectural differences, some task management functions may not be successfully translated to ATA commands or control operations.

risheffi Completed 6/24/2006 1:13:00 PM

Sequence number: 17
Author: DELL[KMarks]
Subject: Highlight
Date: 1/30/2006 9:10:29 PM

T 6.2.2 Mapping of SCSI queued commands to ATA queued commands
5th Paragraph, 1st Sentence a) in a,b list
change
"report"
to
"return"

Status
risheffi Completed 6/1/2006 8:26:43 AM

Sequence number: 18
Author: DELL[KMarks]
Subject: Highlight
Date: 1/30/2006 9:13:31 PM

T 6.2.2 Mapping of SCSI queued commands to ATA queued commands
5th Paragraph, 1st Sentence a) in a,b list
change
"device"
to
"logical unit"

Status
risheffi Completed 6/1/2006 8:27:27 AM

Sequence number: 19
Author: DELL[KMarks]
Subject: Cross-Out
Date: 2/16/2006 12:32:27 PM

T In b) before 6.2.3
remove
"it's"

Status
risheffi Completed 6/1/2006 8:28:03 AM

Sequence number: 20
Author: EDITOR[risheffi]
Subject: Rectangle
Date: 6/1/2006 10:34:49 AM

 RESOLUTION:
Replace subclause 6.2.3 as follows:
6.2.3 Commands the SATL queues internally
If the translation of a SCSI command requires the SATL to send a non-queued command to the ATA device, then the SATL shall not send the non-queued command to the ATA device until any commands outstanding in the ATA device have returned command complete (i.e., with or without error) and the bus is idle.

If the ATA device corresponding to a logical unit has not returned command complete for all ATA commands the SATL has previously sent to the ATA device, and the SATL receives a SCSI command that requires the SATL to send a non-queued command to the ATA device, the SATL shall:
a) suspend processing of the SCSI command, maintain the SCSI command in an internal queue, and resume processing when the ATA device returns command complete for all ATA commands the SATL has previously sent to the ATA device;
b) return TASK SET FULL status for the SCSI command; or
c) return BUSY status for the SCSI command.

The SATL shall perform task management in accordance with the task management model (see SAM-3) indicated in INQUIRY data and parameter data for the Control mode page (see SPC-3).

NOTE: Editor added new comments to define the terms "queued command" and "non-queued command".

Status
risheffi Completed 6/1/2006 8:35:06 AM

Sequence number: 21
Author: IBM[GPenokie]
Subject: Underline

Comments from page 40 continued on next page

- a) report support for the basic task management model in SCSI standard INQUIRY data (i.e., the BQUE bit is set to one and CMDQUE bit is set to zero), and follow the rules for the basic task management model (see SAM-3); or
- b) report support for the full task management model in SCSI standard INQUIRY data (i.e., the BQUE bit is set to zero and CMDQUE bit is set to one), and report 01b in the Queue error management (QERR) field of the SCSI Control mode page.

A SATL that supports SATA NCQ or ATA TCQ may report support for the full task management model with a QERR field set to a value other than 01b only if the SATL reissues all queued commands aborted by the ATA device due to an error condition reported by the ATA device on any one of the queued commands.

Error conditions with outstanding commands to an attached ATA device generally affect all outstanding commands being processed by the ATA device. See ATA/ATAPI-7 or SATA-2 for a description of how to determine the status of each command.

For each SCSI tagged task the SATL translates to an ATA device using SATA NCQ or ATA TCQ, the SATL shall allocate an inactive tag value (e.g. for NCQ, corresponding to an available bit in the reserved field of the SActive register). The SATL shall maintain a mapping between allocated NCQ or TCQ tags and the corresponding SCSI task tags.

The SATL shall detect the maximum queue depth supported by the ATA device (i.e., check word 75 in IDENTIFY DEVICE data), and may either:

- a) report a status of TASK SET FULL in response to a SCSI command issued to the corresponding emulated SCSI device when the ATA device represented has the maximum number of queued commands outstanding; or
- b) queue the command internally and return TASK SET FULL status when the SATL exhausts its internal queueing resources.

6.2.3 Commands the SATL queues internally

When queued commands are outstanding to the ATA device and new commands are received by the SATL that cannot be queued by the ATA device, the SATL shall queue the commands internally, or return a TASK SET FULL or BUSY status until at least one queued command has been completed. The SATL shall defer processing of the newly received non queued commands until the queued commands complete processing. The SATL shall perform task management in accordance with the reported task management model supported in accordance with the requirements in SAM-3.

If the SATL supports queued commands and the translation requires a mix of queued and non queued commands the SATL shall defer processing of subsequent commands, complete processing of all outstanding queued commands, process the non queued command, and then continue processing the previously deferred commands.

6.2.4 Multi-initiator and multi-port command queueing

If the SATL is accessed through a SCSI target port the SATL may be accessible by more than one SCSI initiator port and through more than one SCSI target port. As specified in SAM-3, the task tags maintained in the SATL mapping of task tags to NCQ tags or TCQ tags shall be qualified by the I_T_nexus from which the command was received. When translating from an NCQ tag or TCQ tag to the corresponding SCSI task tag, the SATL shall determine the correct SCSI I_T_nexus using the qualification information associated with the SCSI task tag. The SATL may return TASK SET FULL even if the SATA device has available NCQ tags or TCQ tags in order to maintain tags available for other initiators.

6.3 Task management functions

6.3.1 Task management functions overview

This subclause describes the translation of SCSI task management functions to ATA or SATA equivalents.

NOTE 2 - Due to architectural differences, some task management functions may not be successfully translated to ATA commands or control operations.

Date: 2/16/2006 1:43:02 PM

T 6.2.3 Commands the SATL queues internally

Status

rlsheffi Cancelled 3/10/2006 12:03:16 PM

Sequence number: 22

Author: MXO[MEvans]

Subject: Highlight

Date: 3/10/2006 1:11:15 PM

T 6.2.3 Commands the SATL queues internally and global: in addition to several "queued commands" that need to be rectified, the term "non queued commands" is introduced here. Either add this term to the definitions in clause 3, or replace this term where used in the document with explicit words.

RESOLUTION: See EDITOR's comment.

Status

rlsheffi Completed 6/1/2006 8:37:08 AM

Sequence number: 23

Author: DELL[KMarks]

Subject: Highlight

Date: 3/10/2006 1:12:57 PM

T 6.2.3 Commands the SATL queues internally

1st Paragraph, 1st Sentence

change

"When queued commands are outstanding..."

to

"When ATA queued commands are outstanding..."

RESOLUTION: See EDITOR's comment. A definition of the term "queued command" is added which explicitly refers to an ATA command.

Status

rlsheffi Completed 6/1/2006 8:36:43 AM

Sequence number: 24

Author: IBM[GPenokie]

Subject: Highlight

Date: 3/10/2006 1:14:22 PM

T 1st paragraph

This << SATL that cannot be queued by the ATA device, the >> should be << SATL that is not able to be queued by the ATA device, the >>

RESOLUTION: See EDITOR's comment to replace the subclause with text (that doesn't use the term "cannot").

Status

rlsheffi Completed 6/1/2006 8:36:55 AM

Sequence number: 25

Author: DELL[KMarks]

Subject: Cross-Out

Date: 3/10/2006 1:15:05 PM

T 6.2.3 1st Sentence

remove

"been"

RESOLUTION: See EDITOR's comment.

Status

rlsheffi Completed 6/1/2006 8:36:37 AM

Sequence number: 26

Author: DELL[KMarks]

Subject: Highlight

Date: 3/10/2006 1:16:27 PM

T 6.2.3 Commands the SATL queues internally

1st Paragraph, 2nd Sentence

change

"The SATL shall defer processing of the newly received non queued commands until the queued commands complete processing."

to

"If the SATL receives a SCSI command that requires a non ATA queued commands to be issues to the ATA device, the SATL shall defer processing of the SCSI command until all outstanding ATA queued commands complete."

or similar wording with this intent.

Comments from page 40 continued on next page

- a) report support for the basic task management model in SCSI standard INQUIRY data (i.e., the BQUE bit is set to one and CMDQUE bit is set to zero), and follow the rules for the basic task management model (see SAM-3); or
- b) report support for the full task management model in SCSI standard INQUIRY data (i.e., the BQUE bit is set to zero and CMDQUE bit is set to one), and report 01b in the Queue error management (QERR) field of the SCSI Control mode page.

A SATL that supports SATA NCQ or ATA TCQ may report support for the full task management model with a QERR field set to a value other than 01b only if the SATL reissues all queued commands aborted by the ATA device due to an error condition reported by the ATA device on any one of the queued commands.

Error conditions with outstanding commands to an attached ATA device generally affect all outstanding commands being processed by the ATA device. See ATA/ATAPI-7 or SATA-2 for a description of how to determine the status of each command.

For each SCSI tagged task the SATL translates to an ATA device using SATA NCQ or ATA TCQ, the SATL shall allocate an inactive tag value (e.g. for NCQ, corresponding to an available bit in the reserved field of the SActive register). The SATL shall maintain a mapping between allocated NCQ or TCQ tags and the corresponding SCSI task tags.

The SATL shall detect the maximum queue depth supported by the ATA device (i.e., check word 75 in IDENTIFY DEVICE data), and may either:

- a) report a status of TASK SET FULL in response to a SCSI command issued to the corresponding emulated SCSI device when the ATA device represented has the maximum number of queued commands outstanding; or
- b) queue the command internally and return TASK SET FULL status when the SATL exhausts its internal queueing resources.

6.2.3 Commands the SATL queues internally

When queued commands are outstanding to the ATA device and new commands are received by the SATL that cannot be queued by the ATA device, the SATL shall queue the commands internally, or return a TASK SET FULL or BUSY status until at least one queued command has been completed. The SATL shall defer processing of the newly received non queued commands until the queued commands complete processing. The SATL shall perform task management in accordance with the reported task management model supported in accordance with the requirements in SAM-3.

If the SATL supports queued commands and the translation requires a mix of queued and non queued commands the SATL shall defer processing of subsequent commands, complete processing of all outstanding queued commands, process the non queued command, and then continue processing the previously deferred commands.

6.2.4 Multi-initiator and multi-port command queueing

If the SATL is accessed through a SCSI target port the SATL may be accessible by more than one SCSI initiator port and through more than one SCSI target port. As specified in SAM-3, the task tags maintained in the SATL mapping of task tags to NCQ tags or TCQ tags shall be qualified by the I_T_nexus from which the command was received. When translating from an NCQ tag or TCQ tag to the corresponding SCSI task tag, the SATL shall determine the correct SCSI I_T_nexus using the qualification information associated with the SCSI task tag. The SATL may return TASK SET FULL even if the SATA device has available NCQ tags or TCQ tags in order to maintain tags available for other initiators.

6.3 Task management functions

6.3.1 Task management functions overview

This subclause describes the translation of SCSI task management functions to ATA or SATA equivalents.

NOTE 2 - Due to architectural differences, some task management functions may not be successfully translated to ATA commands or control operations.

RESOLUTION: See EDITOR's comment.

Status
rlsheffi Completed 6/1/2006 8:36:49 AM

Sequence number: 27
Author: DELL[KMarks]
Subject: Highlight
Date: 3/10/2006 1:21:33 PM

T 6.2.3 Commands the SATL queues internally
1st Paragraph, 3rd Sentence

change

"...requirements in SAM-3."

to

"...requirements in SAM-3 (see 6.3)."

REASON: See EDITOR's comment. This refers to the "basic" queue model or the "full" queue model, which is not described in 6.3. Instead the replacement text includes "(see SAM-3 and SPC-3)" as the reference for the task management model in general.

Status
rlsheffi Rejected 3/10/2006 1:20:37 PM

Sequence number: 28
Author: DELL[KMarks]
Subject: Note
Date: 3/10/2006 1:22:05 PM

T 6.2.3 Commands the SATL queues internally
2st Paragraph

This paragraph is similar to suggested wording changes above. Remove this one or the other.

If keeping this paragraph change to

"If the SATL supports ATA queued commands and the translation requires a mix of ATA queued and non ATA queued commands the SATL shall defer processing of subsequent commands, complete processing of all outstanding ATA queued commands, process the non ATA queued command, and then continue processing the previously deferred commands.

RESOLUTION: See EDITOR's comment.

Status
rlsheffi Completed 6/1/2006 8:37:02 AM

Sequence number: 29
Author: MXO[MEvans]
Subject: Highlight
Date: 6/24/2006 1:45:09 PM

T 6.2.4 Multi-initiator and multi-port command queuing, first sentence ("If the SATL is accessed through a SCSI target port the SATL may be accessible by more than one SCSI initiator port and through more than one SCSI target port."): a SATL is always accessed by a SCSI initiator device through a SCSI target port, though the SCSI target port through which the SATL is accessed may be an abstract object in a system with a SATL (i.e., a virtual SCSI target port), and the SATL may contain more than one of the virtual SCSI target ports for more than one virtual SCSI target device. Change this sentence to, "A SATL may present SCSI target ports for more than one SCSI target device and may be accessed by more than one SCSI initiator port."

Discussion: Is a SCSI target port ever associated with more than one SCSI target device? Suggestion: "A SATL may emulate more than one SCSI target device and may present more than one target port per emulated SCSI target device." Still, the point is that a SATL in an HBA that doesn't have a SCSI target port attached to an actual SCSI transport only has to worry about a single SCSI initiator port (a virtual one), and so doesn't need to apportion SATL resources among multiple initiators or qualify task tags with an initiator ID. But a SATL that attaches to an actual SCSI transport via an actual SCSI target port does have to worry about multi-initiator sorts of things. Has this point been lost in the suggested rewrite?

"A SATL that receives SCSI requests through a target port attached to a defined SCSI transport shall qualify task tags with the I_T_L nexus"

Another recommendation - after the figures are added to subclause 5.1 showing the applicable usage models, refer back to the figures to distinguish which requires a SATL to deal with multiple initiators and which doesn't.

RESOLUTION: see 06-262.

Status

Comments from page 40 continued on next page

- a) report support for the basic task management model in SCSI standard INQUIRY data (i.e., the BQUE bit is set to one and CMDQUE bit is set to zero), and follow the rules for the basic task management model (see SAM-3); or
- b) report support for the full task management model in SCSI standard INQUIRY data (i.e., the BQUE bit is set to zero and CMDQUE bit is set to one), and report 01b in the Queue error management (QERR) field of the SCSI Control mode page.

A SATL that supports SATA NCQ or ATA TCQ may report support for the full task management model with a QERR field set to a value other than 01b only if the SATL reissues all queued commands aborted by the ATA device due to an error condition reported by the ATA device on any one of the queued commands.

Error conditions with outstanding commands to an attached ATA device generally affect all outstanding commands being processed by the ATA device. See ATA/ATAPI-7 or SATA-2 for a description of how to determine the status of each command.

For each SCSI tagged task the SATL translates to an ATA device using SATA NCQ or ATA TCQ, the SATL shall allocate an inactive tag value (e.g. for NCQ, corresponding to an available bit in the reserved field of the SActive register). The SATL shall maintain a mapping between allocated NCQ or TCQ tags and the corresponding SCSI task tags.

The SATL shall detect the maximum queue depth supported by the ATA device (i.e., check word 75 in IDENTIFY DEVICE data), and may either:

- a) report a status of TASK SET FULL in response to a SCSI command issued to the corresponding emulated SCSI device when the ATA device represented has the maximum number of queued commands outstanding; or
- b) queue the command internally and return TASK SET FULL status when the SATL exhausts its internal queueing resources.

6.2.3 Commands the SATL queues internally

When queued commands are outstanding to the ATA device and new commands are received by the SATL that cannot be queued by the ATA device, the SATL shall queue the commands internally, or return a TASK SET FULL or BUSY status until at least one queued command has been completed. The SATL shall defer processing of the newly received non queued commands until the queued commands complete processing. The SATL shall perform task management in accordance with the reported task management model supported in accordance with the requirements in SAM-3.

If the SATL supports queued commands and the translation requires a mix of queued and non queued commands the SATL shall defer processing of subsequent commands, complete processing of all outstanding queued commands, process the non queued command, and then continue processing the previously deferred commands.

6.2.4 Multi-initiator and multi-port command queueing

If the SATL is accessed through a SCSI target port the SATL may be accessible by more than one SCSI initiator port and through more than one SCSI target port. As specified in SAM-3, the task tags maintained in the SATL mapping of task tags to NCQ tags or TCQ tags shall be qualified by the ³¹the ₃₀ nexus from which the command was received. When translating from an NCQ tag or TCQ tag to the corresponding SCSI task tag, the SATL shall determine the correct ³²SI I_T nexus using the qualification information associated with the SCSI task tag. The SATL may return TASK SET FULL even ³³the SATA device has available NCQ tags or TCQ tags in order to maintain tags available for other initiators.

6.3 Task management functions

6.3.1 Task management functions overview

This subclause describes the translation of SCSI task management functions to ATA or SATA equivalents.

NOTE 2 - ³⁴Due to architectural differences, some task management functions may not be successfully translated to ATA commands or control operations.

risheffi Completed 6/24/2006 1:45:12 PM

Sequence number: 30
Author: MXO[MEvans]
Subject: Highlight
Date: 2/8/2006 2:10:49 PM

T 6.2.4 Multi-initiator and multi-port command queuing (and global): change "I_T_nexus" to "I_T nexus" in several places in the draft standard. There are also several instances of "I_T_Nexus" to change to "I_T nexus"

Status
risheffi Completed 6/3/2006 8:13:43 AM

Sequence number: 31
Author: DELL[KMarks]
Subject: Highlight
Date: 1/30/2006 9:41:47 PM

T 6.2.4 Multi-initiator and multi-port command queuing
1st paragraph 2nd Sentence
change
"...by the I_T_nexus from..."
to
"...by the I_T nexus from..."

Status
risheffi Completed 6/3/2006 8:14:34 AM

Sequence number: 32
Author: DELL[KMarks]
Subject: Highlight
Date: 1/30/2006 9:42:45 PM

T 6.2.4 Multi-initiator and multi-port command queuing
1st paragraph 3rd Sentence
change
"... SCSI I_T_nexus using"
to
"... I_T nexus using"

Status
risheffi Completed 6/3/2006 8:15:11 AM

Sequence number: 33
Author: DELL[KMarks]
Subject: Highlight
Date: 1/30/2006 9:44:04 PM

T 6.2.4 Multi-initiator and multi-port command queuing
1st paragraph 4th Sentence
change
"...if the SATA device has..."
to
"...if the ATA device has..."

Status
risheffi Completed 6/3/2006 8:16:36 AM

Sequence number: 34
Author: MXO[MEvans]
Subject: Highlight
Date: 6/3/2006 8:22:47 AM

T Note 2: change to, "Due to architectural differences, some task management functions may not translate to ATA commands or control operations."
RESOLUTION: Delete the note, per comments on 06-179 (see).

Status
risheffi Completed 6/24/2006 2:32:13 PM

3.2 ABORT TASK

The SATL may process the ABORT TASK service request in any of the following ways:

- a) If no commands have yet been issued to the ATA device for the processing of the specified SCSI task tag the SATL shall delete the specified task from the SATL internal context and respond to the ABORT TASK request with FUNCTION COMPLETE.
- b) If the only command(s) being processed in the ATA device are related to the SCSI task specified by the ABORT TASK request, then the SATL may abort the ATA command(s) and respond with FUNCTION COMPLETE.
- c) If the ATA device is processing commands for SCSI tasks in addition to the task specified by the ABORT TASK request the SATL shall:
 - A) abort outstanding ATA commands and respond to the ABORT TASK request with FUNCTION COMPLETE (see SAM3); and
 - B) for each initiator port associated with an I_T_Nexus that had a task aborted, the SATL shall complete at least one command for that I_T_Nexus with CHECK CONDITION status with the sense key set to UNIT ATTENTION and additional sense code set to COMMANDS CLEARED BY ANOTHER INITIATOR.

NOTE 3 - It may be that the first place the SATL can abort the command without preventing the processing of other commands is when the attached ATA device returns completion status for the ATA command. In this case the SATL would not provide a SCSI response for the aborted command, even though processing completed in the ATA domain, but instead return FUNCTION COMPLETE for the ABORT TASK request.

6.3.3 ABORT TASK SET

The SATL may handle the ABORT TASK SET service request differently depending on whether the SATL provides multiple initiators access to the emulated SCSI device or not.

If the SATL does not provide multiple I_T nexuses access to the emulated SCSI device, the SATL shall process the service request as follows:

- 1) If commands have not been issued to the ATA device for the processing of the specified SCSI task tag the SATL shall delete all tasks in the task set from the SATL internal context and respond to the ABORT TASK SET request with FUNCTION COMPLETE.
- 2) If the only command(s) being processed in the ATA device are associated to the SCSI tasks in the task set, then the SATL shall abort the ATA command(s) and respond with FUNCTION COMPLETE.
- 3) The SATL shall abort outstanding ATA command(s) and respond to the ABORT TASK SET request with a FUNCTION COMPLETE.

If the SATL provides multiple initiators access to the emulated SCSI device, the SATL shall process the service request as follows:

- a) If commands have not been issued to the ATA device for the processing of the specified SCSI task tag the SATL shall delete the specified task from the SATL internal context and respond to the ABORT TASK SET request with FUNCTION COMPLETE.
- b) For each initiator port associated with an I_T_Nexus that had a task aborted, the SATL shall complete at least one command for that I_T_Nexus with CHECK CONDITION status with the sense key set to UNIT ATTENTION and additional sense code set to COMMANDS CLEARED BY ANOTHER INITIATOR.

6.3.4 CLEAR ACA

The SATL shall not support auto-contingent allegiance. The SATL shall indicate ACA is not supported by returning zero in the NORMACA bit in standard INQUIRY data. The SATL shall respond to a CLEAR ACA service request with FUNCTION REJECTED.

6.3.5 CLEAR TASK SET

The SATL may handle the CLEAR TASK SET service request differently depending on whether the SATL provides multiple initiators access to the emulated SCSI device or not.

Sequence number: 1
Author: EDITOR[rlsheffi]
Subject: Rectangle
Date: 4/24/2006 11:03:25 AM

 6.3.2 ABORT TASK: change as follows:

If no ATA commands have yet been issued to the ATA device for the processing of the SCSI task tag specified in the ABORT TASK task management function, then the SATL shall delete the specified task from the SATL internal context and respond to the ABORT TASK task management function with service response of FUNCTION COMPLETE (see SAM-3).

If the only ATA command(s) being processed in the ATA device are related to the SCSI task specified by the ABORT TASK task management function, then the SATL shall abort the ATA command(s) and respond to the ABORT TASK task management function with a service response of FUNCTION COMPLETE.

If the ATA device is processing ATA commands for SCSI tasks in addition to the task specified by the ABORT TASK task management function, then the SATL shall abort all outstanding ATA commands, and:

- a) respond to the ABORT TASK task management function with a service response of FUNCTION COMPLETE;
- b) if outstanding commands for other tasks in the task set for the same I_T nexus as the one that originated the ABORT TASK task management function are aborted, then the SATL shall complete at least one command for the I_T nexus that originated the ABORT TASK task management function with CHECK CONDITION status with the sense key set to UNIT ATTENTION and the additional sense code set to COMMANDS CLEARED BY ANOTHER INITIATOR; and
- c) for each other I_T nexus that had a task aborted, the SATL shall complete at least one command for that I_T nexus with CHECK CONDITION status with the sense key set to UNIT ATTENTION and additional sense code set to COMMANDS CLEARED BY ANOTHER INITIATOR.

NOTE 3 - It may be that the first time the SATL is able to abort the command without preventing the processing of other commands is when the attached ATA device returns completion status for the ATA command. In this case, the SATL does not provide a SCSI response for the aborted command, even though processing completed in the ATA domain, but instead returns a service response of FUNCTION COMPLETE for the ABORT TASK task management function.

RESOLUTION: See 06-179rX: SAT - Fix Task Management Functions

Status
rlsheffi Completed 6/24/2006 8:15:46 AM

Sequence number: 2
Author: IBM[GPenokie]
Subject: Underline
Date: 2/16/2006 1:29:47 PM

 6.3.2 ABORT TASK

Status
rlsheffi Cancelled 3/26/2006 6:41:57 PM

Sequence number: 3
Author: MXO[MEvans]
Subject: Highlight
Date: 6/3/2006 8:25:34 AM

 6.3.2 ABORT TASK: change as follows:

If no commands have yet been issued to the ATA device for the processing of the specified SCSI task tag, then the SATL shall delete the specified task from the SATL internal context and respond to the ABORT TASK request with FUNCTION COMPLETE.

If the only command(s) being processed in the ATA device are related to the SCSI task specified by the ABORT TASK request, then the SATL shall abort the ATA command(s) and respond with FUNCTION COMPLETE.

If the ATA device is processing commands for SCSI tasks in addition to the task specified by the ABORT TASK request, then the SATL shall abort all outstanding ATA commands, and:

- a) respond to the ABORT TASK request with FUNCTION COMPLETE;

6.3.2 ABORT TASK

The SATL may process the ABORT TASK service request in any of the following ways:

- a) If no commands have yet been issued to the ATA device for the processing of the specified SCSI task tag the SATL shall delete the specified task from the SATL internal context and respond to the ABORT TASK request with FUNCTION COMPLETE.
- b) If the only command(s) being processed in the ATA device are related to the SCSI task specified by the ABORT TASK request, then the SATL may abort the ATA command(s) and respond with FUNCTION COMPLETE.
- c) If the ATA device is processing commands for SCSI tasks in addition to the task specified by the ABORT TASK request the SATL shall:
 - A) abort outstanding ATA commands and respond to the ABORT TASK request with FUNCTION COMPLETE (see SAM3); and
 - B) for each initiator port associated with an I_T_Nexus that had a task aborted, the SATL shall complete at least one command for that I_T_Nexus with CHECK CONDITION status with the sense key set to UNIT ATTENTION and additional sense code set to COMMANDS CLEARED BY ANOTHER INITIATOR.

NOTE 3 - It may be that the first place the SATL can abort the command without preventing the processing of other commands is when the attached ATA device returns completion status for the ATA command. In this case the SATL would not provide a SCSI response for the aborted command, even though processing completed in the ATA domain, but instead return FUNCTION COMPLETE for the ABORT TASK request.

6.3.3 ABORT TASK SET

The SATL may handle the ABORT TASK SET service request differently depending on whether the SATL provides multiple initiators access to the emulated SCSI device or not.

If the SATL does not provide multiple I_T nexuses access to the emulated SCSI device, the SATL shall process the service request as follows:

- 1) If commands have not been issued to the ATA device for the processing of the specified SCSI task tag the SATL shall delete all tasks in the task set from the SATL internal context and respond to the ABORT TASK SET request with FUNCTION COMPLETE.
- 2) If the only command(s) being processed in the ATA device are associated to the SCSI tasks in the task set, then the SATL shall abort the ATA command(s) and respond with FUNCTION COMPLETE.
- 3) The SATL shall abort outstanding ATA command(s) and respond to the ABORT TASK SET request with a FUNCTION COMPLETE.

If the SATL provides multiple initiators access to the emulated SCSI device, the SATL shall process the service request as follows:

- a) If commands have not been issued to the ATA device for the processing of the specified SCSI task tag the SATL shall delete the specified task from the SATL internal context and respond to the ABORT TASK SET request with FUNCTION COMPLETE.
- b) For each initiator port associated with an I_T_Nexus that had a task aborted, the SATL shall complete at least one command for that I_T_Nexus with CHECK CONDITION status with the sense key set to UNIT ATTENTION and additional sense code set to COMMANDS CLEARED BY ANOTHER INITIATOR.

6.3.4 CLEAR ACA

The SATL shall not support auto-contingent allegiance. The SATL shall indicate ACA is not supported by returning zero in the NORMACA bit in standard INQUIRY data. The SATL shall respond to a CLEAR ACA service request with FUNCTION REJECTED.

6.3.5 CLEAR TASK SET

The SATL may handle the CLEAR TASK SET service request differently depending on whether the SATL provides multiple initiators access to the emulated SCSI device or not.

b) if outstanding commands for other tasks in the task set were aborted, then the SATL shall complete at least one command for the I_T nexus that originated the ABORT TASK service request with CHECK CONDITION status with the sense key set to UNIT ATTENTION and additional sense code set to COMMANDS CLEARED BY ANOTHER INITIATOR; and
c) for each other I_T nexus that had a task aborted, the SATL shall complete at least one command for that I_T nexus with CHECK CONDITION status with the sense key set to UNIT ATTENTION and additional sense code set to COMMANDS CLEARED BY ANOTHER INITIATOR.

NOTE 3 - It may be that the first time the SATL is able to abort the command without preventing the processing of other commands is when the attached ATA device returns completion status for the ATA command. In this case the SATL does not provide a SCSI response for the aborted command, even though processing completed in the ATA domain, but instead return FUNCTION COMPLETE for the ABORT TASK request.

Confirm (with Mark Evans): Item b) still isn't quite correct. It seems to apply to "other tasks in the task set", whether the "other tasks" are in the same I_T nexus as the ABORT TASK request or not. So, if it happens that all the "other tasks" are for a different I_T nexus, b) specifies, incorrectly, to generate a UNIT ATTENTION condition for the I_T nexus that originated the ABORT TASK service request. This could be fixed by rewriting b) as follows:

b) if outstanding commands for other tasks in the task set for the same I_T nexus as the one that originated the ABORT TASK service request are aborted, then the SATL shall complete at least one command for the I_T nexus that originated the ABORT TASK service request with CHECK CONDITION status with the sense key set to UNIT ATTENTION and the additional sense code set to COMMANDS CLEARED BY ANOTHER INITIATOR; and

RESOLUTION: see 06-179rX: SAT - Fix Task Management Functions

Status
rlsheffi Completed 6/24/2006 8:18:38 AM

Sequence number: 4
Author: HPQ[RElliott]
Subject: Highlight
Date: 3/31/2006 4:02:19 PM

T 6.3.2
an s/b in
RESOLUTION: see 06-179rX: SAT - Fix Task Management Functions

Status
rlsheffi Completed 6/24/2006 8:20:20 AM

Sequence number: 5
Author: SIERLGC[BMartin]
Subject: Highlight
Date: 3/31/2006 4:03:16 PM

T Page 21, 6.3.2, first paragraph
an s.b. in
RESOLUTION: see 06-179rX: SAT - Fix Task Management Functions

Status
rlsheffi Completed 7/24/2006 11:20:54 AM

Sequence number: 6
Author: IBM[GPenokie]
Subject: Highlight
Date: 3/31/2006 4:03:31 PM

T 1st paragraph
This << service request an any of the following >> should be << service request in any of the following >>
RESOLUTION: see 06-179rX: SAT - Fix Task Management Functions

Status
rlsheffi Completed 6/24/2006 8:20:32 AM

Sequence number: 7
Author: DELL[KMarks]
Subject: Highlight
Date: 3/31/2006 4:03:57 PM

T 6.3.2 ABORT TASK
1st Paragraph, 2nd Sentent
change
"...the ABORT TASK service request an any of the following ways:"
to
"...the ABORT TASK task management function request as follows:"

Comments from page 41 continued on next page

6.3.2 ABORT TASK

The SATL may process the ABORT TASK service request in any of the following ways:

- a) If no commands have yet been issued to the ATA device for the processing of the specified SCSI task tag the SATL shall delete the specified task from the SATL internal context and respond to the ABORT TASK request with FUNCTION COMPLETE.
- b) If the only command(s) being processed in the ATA device are related to the SCSI task specified by the ABORT TASK request, then the SATL may abort the ATA command(s) and respond with FUNCTION COMPLETE.
- c) If the ATA device is processing commands for SCSI tasks in addition to the task specified by the ABORT TASK request the SATL shall:
 - A) abort outstanding ATA commands and respond to the ABORT TASK request with FUNCTION COMPLETE (see SAM3); and
 - B) for each initiator port associated with an I_T_Nexus that had a task aborted, the SATL shall complete at least one command for that I_T_Nexus with CHECK CONDITION status with the sense key set to UNIT ATTENTION and additional sense code set to COMMANDS CLEARED BY ANOTHER INITIATOR.

NOTE 3 - It may be that the first place the SATL can abort the command without preventing the processing of other commands is when the attached ATA device returns completion status for the ATA command. In this case the SATL would not provide a SCSI response for the aborted command, even though processing completed in the ATA domain, but instead return FUNCTION COMPLETE for the ABORT TASK request.

6.3.3 ABORT TASK SET

The SATL may handle the ABORT TASK SET service request differently depending on whether the SATL provides multiple initiators access to the emulated SCSI device or not.

If the SATL does not provide multiple I_T nexuses access to the emulated SCSI device, the SATL shall process the service request as follows:

- 1) If commands have not been issued to the ATA device for the processing of the specified SCSI task tag the SATL shall delete all tasks in the task set from the SATL internal context and respond to the ABORT TASK SET request with FUNCTION COMPLETE.
- 2) If the only command(s) being processed in the ATA device are associated to the SCSI tasks in the task set, then the SATL shall abort the ATA command(s) and respond with FUNCTION COMPLETE.
- 3) The SATL shall abort outstanding ATA command(s) and respond to the ABORT TASK SET request with a FUNCTION COMPLETE.

If the SATL provides multiple initiators access to the emulated SCSI device, the SATL shall process the service request as follows:

- a) If commands have not been issued to the ATA device for the processing of the specified SCSI task tag the SATL shall delete the specified task from the SATL internal context and respond to the ABORT TASK SET request with FUNCTION COMPLETE.
- b) For each initiator port associated with an I_T_Nexus that had a task aborted, the SATL shall complete at least one command for that I_T_Nexus with CHECK CONDITION status with the sense key set to UNIT ATTENTION and additional sense code set to COMMANDS CLEARED BY ANOTHER INITIATOR.

6.3.4 CLEAR ACA

The SATL shall not support auto-contingent allegiance. The SATL shall indicate ACA is not supported by returning zero in the NORMACA bit in standard INQUIRY data. The SATL shall respond to a CLEAR ACA service request with FUNCTION REJECTED.

6.3.5 CLEAR TASK SET

The SATL may handle the CLEAR TASK SET service request differently depending on whether the SATL provides multiple initiators access to the emulated SCSI device or not.

service requests are generally for commands not TMFs.

RESOLUTION: see 06-179rX: SAT - Fix Task Management Functions

Status
risheffi Completed 6/24/2006 8:20:39 AM

Sequence number: 8
Author: DELL[KMarks]
Subject: Highlight
Date: 3/31/2006 4:04:13 PM

T 6.3.2 ABORT TASK
1st Paragraph a) in a,b,c list

change

"a) If no commands have yet been issued to the ATA device for the processing of the specified SCSI task tag the SATL shall delete the specified task from the SATL internal context and respond to the ABORT TASK request with FUNCTION COMPLETE."

to

"a) If no ATA commands have been issued to the ATA device for the processing for the SCSI task tag specified in the ABORT TASK task management function request, the SATL shall delete the specified task from the SATL internal context and respond to the ABORT TASK task management function request with a task management function response of FUNCTION COMPLETE;"

This use the word task instead of command need to be fix elsewhere,

RESOLUTION: see 06-179rX: SAT - Fix Task Management Functions

Status
risheffi Completed 6/24/2006 8:26:19 AM

Sequence number: 9
Author: ENDL[RWeber]
Date: 3/31/2006 4:04:27 PM

 a,b,c list

This list is not properly structured. Entries a and b end with periods. There is no conjunction between entries b and c.

RESOLUTION: see 06-179rX: SAT - Fix Task Management Functions

Status
risheffi Completed 6/24/2006 8:27:51 AM

Sequence number: 10
Author: HPQ[RElliott]
Subject: Highlight
Date: 6/3/2006 8:28:10 AM

T 6.3
throughout these sections

"with FUNCTION COMPLETE" s/b "with a service response of FUNCTION COMPLETE (all caps)"

RESOLUTION: s/b "with a service response of FUNCTION COMPLETE (small caps)". Small caps is consistent with usage in SAM-3 and SPC-3.

RESOLUTION: see 06-179rX: SAT - Fix Task Management Functions

Status
risheffi Completed 6/24/2006 8:32:23 AM

Sequence number: 11
Author: IBM[GPenokie]
Subject: Highlight
Date: 6/3/2006 8:29:58 AM

T item a
This item needs to end in a ; not a .

RESOLUTION: see 06-179rX: SAT - Fix Task Management Functions

Status
risheffi Completed 6/24/2006 8:32:34 AM

Sequence number: 12

Comments from page 41 continued on next page

6.3.2 ABORT TASK

The SATL may process the ABORT TASK service request in any of the following ways:

- a) If no commands have yet been issued to the ATA device for the processing of the specified SCSI task tag the SATL shall delete the specified task from the SATL internal context and respond to the ABORT TASK request with FUNCTION COMPLETE.
- 13 If the only command(s) being processed in the ATA device are related to the SCSI task specified by the ABORT TASK request, then the SATL may abort the ATA command(s) and 14 respond with FUNCTION COMPLETE.
- 15 16 If the ATA device is processing commands for SCSI tasks in addition to the task specified by the ABORT TASK request the SATL shall:
 - A) abort outstanding ATA commands and respond to the ABORT TASK request with FUNCTION COMPLETE (see SAM3); and
 - B) for each initiator port associated with an I_T_Nexus that had a task aborted, the SATL shall complete at least one command for that I_T_Nexus with CHECK CONDITION status with the sense key set to UNIT ATTENTION and additional sense code set to COMMANDS CLEARED BY ANOTHER INITIATOR.

NOTE 3 - It may be that the first place the SATL can abort the command without preventing the processing of other commands is when the attached ATA device returns completion status for the ATA command. In this case the SATL would not provide a SCSI response for the aborted command, even though processing completed in the ATA domain, but instead return FUNCTION COMPLETE for the ABORT TASK request.

6.3.3 ABORT TASK SET

The SATL may handle the ABORT TASK SET service request differently depending on whether the SATL provides multiple initiators access to the emulated SCSI device or not.

If the SATL does not provide multiple I_T nexuses access to the emulated SCSI device, the SATL shall process the service request as follows:

- 1) If commands have not been issued to the ATA device for the processing of the specified SCSI task tag the SATL shall delete all tasks in the task set from the SATL internal context and respond to the ABORT TASK SET request with FUNCTION COMPLETE.
- 2) If the only command(s) being processed in the ATA device are associated to the SCSI tasks in the task set, then the SATL shall abort the ATA command(s) and respond with FUNCTION COMPLETE.
- 3) The SATL shall abort outstanding ATA command(s) and respond to the ABORT TASK SET request with a FUNCTION COMPLETE.

If the SATL provides multiple initiators access to the emulated SCSI device, the SATL shall process the service request as follows:

- a) If commands have not been issued to the ATA device for the processing of the specified SCSI task tag the SATL shall delete the specified task from the SATL internal context and respond to the ABORT TASK SET request with FUNCTION COMPLETE.
- b) For each initiator port associated with an I_T_Nexus that had a task aborted, the SATL shall complete at least one command for that I_T_Nexus with CHECK CONDITION status with the sense key set to UNIT ATTENTION and additional sense code set to COMMANDS CLEARED BY ANOTHER INITIATOR.

6.3.4 CLEAR ACA

The SATL shall not support auto-contingent allegiance. The SATL shall indicate ACA is not supported by returning zero in the NORMACA bit in standard INQUIRY data. The SATL shall respond to a CLEAR ACA service request with FUNCTION REJECTED.

6.3.5 CLEAR TASK SET

The SATL may handle the CLEAR TASK SET service request differently depending on whether the SATL provides multiple initiators access to the emulated SCSI device or not.

Author: HPQ[RElliott]
Subject: Note
Date: 6/3/2006 8:30:28 AM
6.3.2

End a)b) list entries with ; and " ; and"
RESOLUTION: see 06-179rX: SAT - Fix Task Management Functions

Status
rlsheffi Completed 6/24/2006 8:33:05 AM

Sequence number: 13
Author: DELL[KMarks]
Subject: Highlight
Date: 3/31/2006 4:08:24 PM

T 6.3.2 ABORT TASK
1st Paragraph b) in a,b,c list
change

"b) If the only command(s) being processed in the ATA device are related to the SCSI task specified by the ABORT TASK request, then the SATL may abort the ATA command(s) and respond with FUNCTION COMPLETE."

to

"b) If the only ATA command(s) issued to the ATA device are related to the SCSI task specified in the ABORT TASK task management function request, then the SATL may abort the ATA command(s) and respond to the ABORT TASK task management function request with a task management function response of FUNCTION COMPLETE; or"

Believe this should be an or at the end.

How does one abort an ATA command on an ATA device? SRST? Additionally is any text needed about cleaning up the internal context as in a)?

RESOLUTION: see 06-179rX: SAT - Fix Task Management Functions

Status
rlsheffi Completed 7/24/2006 11:21:07 AM

Sequence number: 14
Author: SIERLGC[BMartin]
Subject: Note
Date: 3/31/2006 4:11:50 PM

Page 21, 6.3.2, item b

If it doesn't do this, what SHALL it do?

RESOLUTION: see 06-179rX: SAT - Fix Task Management Function ("may" to "shall")

Status
rlsheffi Completed 6/24/2006 8:35:09 AM

Sequence number: 15
Author: IBM[GPenokie]
Subject: Highlight
Date: 6/3/2006 8:30:55 AM

T item b
This item needs to end in a << ; or >>not a << . >>.

RESOLUTION: see 06-179rX: SAT - Fix Task Management Functions

Status
rlsheffi Completed 6/24/2006 8:35:26 AM

Sequence number: 16
Author: DELL[KMarks]
Subject: Highlight
Date: 3/31/2006 4:12:20 PM

T 6.3.2 ABORT TASK
1st Paragraph c) in a,b,c list
change

"c) If the ATA device is processing commands for SCSI tasks in addition to the task specified by the ABORT TASK request the SATL shall:

A) abort outstanding ATA commands and respond to the ABORT TASK request with FUNCTION COMPLETE (see SAM3); and

B) for each initiator port associated with an I_T_Nexus that had a task aborted, the SATL shall complete at least one command for that I_T_Nexus with CHECK CONDITION status with the sense key set to UNIT ATTENTION and

Comments from page 41 continued on next page

6.3.2 ABORT TASK

The SATL may process the ABORT TASK service request in any of the following ways:

- a) If no commands have yet been issued to the ATA device for the processing of the specified SCSI task tag the SATL shall delete the specified task from the SATL internal context and respond to the ABORT TASK request with FUNCTION COMPLETE.
- b) If the only command(s) being processed in the ATA device are related to the SCSI task specified by the ABORT TASK request, then the SATL may abort the ATA command(s) and respond with FUNCTION COMPLETE.
- c) If the ATA device is processing commands for SCSI tasks in addition to the task specified by the ABORT TASK request the SATL shall:
 - A) abort outstanding ATA commands and respond to the ABORT TASK request with FUNCTION COMPLETE (see 17.M3); and
 - B) for each initiator port associated with an I_T_Nexus that had a task aborted, the SATL shall complete at least one command for that I_T_Nexus with CHECK CONDITION status with the sense key set to UNIT ATTENTION and additional sense code set to COMMANDS CLEARED BY ANOTHER INITIATOR.

NOTE 3 - It may be that the first place the SATL aborts the command without preventing the processing of other commands is when the attached ATA device returns completion status for the ATA command. In this case the SATL would not provide a SCSI response for the aborted command, even though processing completed in the ATA domain, but instead return FUNCTION COMPLETE for the ABORT TASK request.

6.3.3 ABORT TASK SET

The SATL may handle the ABORT TASK SET service request differently depending on whether the SATL provides multiple initiators access to the emulated SCSI device or not.

If the SATL does not provide multiple I_T nexuses access to the emulated SCSI device, the SATL shall process the service request as follows:

- 1) If commands have not been issued to the ATA device for the processing of the specified SCSI task tag the SATL shall delete all tasks in the task set from the SATL internal context and respond to the ABORT TASK SET request with FUNCTION COMPLETE.
- 2) If the only command(s) being processed in the ATA device are associated to the SCSI tasks in the task set, then the SATL shall abort the ATA command(s) and respond with FUNCTION COMPLETE.
- 3) The SATL shall abort outstanding ATA command(s) and respond to the ABORT TASK SET request with a FUNCTION COMPLETE.

If the SATL provides multiple initiators access to the emulated SCSI device, the SATL shall process the service request as follows:

- a) If commands have not been issued to the ATA device for the processing of the specified SCSI task tag the SATL shall delete the specified task from the SATL internal context and respond to the ABORT TASK SET request with FUNCTION COMPLETE.
- b) For each initiator port associated with an I_T_Nexus that had a task aborted, the SATL shall complete at least one command for that I_T_Nexus with CHECK CONDITION status with the sense key set to UNIT ATTENTION and additional sense code set to COMMANDS CLEARED BY ANOTHER INITIATOR.

6.3.4 CLEAR ACA

The SATL shall not support auto-contingent allegiance. The SATL shall indicate ACA is not supported by returning zero in the NORMACA bit in standard INQUIRY data. The SATL shall respond to a CLEAR ACA service request with FUNCTION REJECTED.

6.3.5 CLEAR TASK SET

The SATL may handle the CLEAR TASK SET service request differently depending on whether the SATL provides multiple initiators access to the emulated SCSI device or not.

additional sense code set to **COMMANDS CLEARED BY ANOTHER INITIATOR.**"

to

"c) If the ATA device is processing ATA commands for SCSI tasks in addition to the task tag specified in the **ABORT TASK** task management function request the SATL shall:

A) abort all outstanding ATA commands and respond to the **ABORT TASK** task management function request with a task management function response of **FUNCTION COMPLETE** (see SAM3); and

B) for each SCSI initiator port associated with an I_T nexus that had a task aborted, complete at least one command for that I_T nexus with **CHECK CONDITION** status with the sense key set to **UNIT ATTENTION** and additional sense code set to **COMMANDS CLEARED BY ANOTHER INITIATOR.**"

How are all outstanding ATA commands aborted? **SRST? COMRESET?**

RESOLUTION: see 06-179rX: SAT - Fix Task Management Functions

Status
rIsheffi Completed 6/24/2006 3:17:59 PM

Sequence number: 17
Author: HPQ[RElliott]
Subject: Highlight
Date: 6/3/2006 8:31:29 AM

 6.3.2

SAM3 s/b SAM-3
RESOLUTION: see 06-179rX: SAT - Fix Task Management Functions

Status
rIsheffi Completed 6/24/2006 8:37:57 AM

Sequence number: 18
Author: HPQ[RElliott]
Subject: Highlight
Date: 2/1/2006 11:24:36 AM

 6.3.2

I_T_Nexus s/b I_T nexus

(several times)

Status
rIsheffi Completed 6/3/2006 8:32:18 AM

Sequence number: 19
Author: HPQ[RElliott]
Subject: Note
Date: 3/31/2006 4:13:01 PM

 6.3.2

If **TASK ABORTED** status is enabled for an I_T nexus, that will be used instead of unit attention.

Unit attention wording should be traditional "establish a unit attention condition with the additional sense code set to"

RESOLUTION: see 06-179rX: SAT - Fix Task Management Functions

Status
rIsheffi Completed 6/24/2006 8:38:52 AM

Sequence number: 20
Author: SIERLGC[BMartin]
Subject: Note
Date: 3/31/2006 4:13:24 PM

 Page 21, 6.3.2, list item B

add item C shall re-issue all commands to the drive for SCSI tasks other than for the task specified.

RESOLUTION: see 06-179rX: SAT - Fix Task Management Functions

Status
rIsheffi Completed 6/24/2006 8:47:45 AM

Sequence number: 21

Comments from page 41 continued on next page

6.3.2 ABORT TASK

The SATL may process the ABORT TASK service request in any of the following ways:

- a) If no commands have yet been issued to the ATA device for the processing of the specified SCSI task tag the SATL shall delete the specified task from the SATL internal context and respond to the ABORT TASK request with FUNCTION COMPLETE.
- b) If the only command(s) being processed in the ATA device are related to the SCSI task specified by the ABORT TASK request, then the SATL may abort the ATA command(s) and respond with FUNCTION COMPLETE.
- c) If the ATA device is processing commands for SCSI tasks in addition to the task specified by the ABORT TASK request the SATL shall:
 - A) abort outstanding ATA commands and respond to the ABORT TASK request with FUNCTION COMPLETE (see SAM3); and
 - B) for each initiator port associated with an I_T_Nexus that had a task aborted, the SATL shall complete at least one command for that I_T_Nexus with CHECK CONDITION status with the sense key set to UNIT ATTENTION and additional sense code set to COMMANDS CLEARED BY ANOTHER INITIATOR.

NOTE 3 - It may be that the first time the SATL can abort the command without preventing the processing of other commands is when the attached ATA device returns completion status for the ATA command. In this case the SATL would not provide a SCSI response for the aborted command, even though processing completed in the ATA main, but instead return FUNCTION COMPLETE for the ABORT TASK request.

6.3.3 ABORT TASK SET

The SATL may handle the ABORT TASK SET service request differently depending on whether the SATL provides multiple initiators access to the emulated SCSI device or not.

If the SATL does not provide multiple I_T nexuses access to the emulated SCSI device, the SATL shall process the service request as follows:

- 1) If commands have not been issued to the ATA device for the processing of the specified SCSI task tag the SATL shall delete all tasks in the task set from the SATL internal context and respond to the ABORT TASK SET request with FUNCTION COMPLETE.
- 2) If the only command(s) being processed in the ATA device are associated to the SCSI tasks in the task set, then the SATL shall abort the ATA command(s) and respond with FUNCTION COMPLETE.
- 3) The SATL shall abort outstanding ATA command(s) and respond to the ABORT TASK SET request with a FUNCTION COMPLETE.

If the SATL provides multiple initiators access to the emulated SCSI device, the SATL shall process the service request as follows:

- a) If commands have not been issued to the ATA device for the processing of the specified SCSI task tag the SATL shall delete the specified task from the SATL internal context and respond to the ABORT TASK SET request with FUNCTION COMPLETE.
- b) For each initiator port associated with an I_T_Nexus that had a task aborted, the SATL shall complete at least one command for that I_T_Nexus with CHECK CONDITION status with the sense key set to UNIT ATTENTION and additional sense code set to COMMANDS CLEARED BY ANOTHER INITIATOR.

6.3.4 CLEAR ACA

The SATL shall not support auto-contingent allegiance. The SATL shall indicate ACA is not supported by returning zero in the NORMACA bit in standard INQUIRY data. The SATL shall respond to a CLEAR ACA service request with FUNCTION REJECTED.

6.3.5 CLEAR TASK SET

The SATL may handle the CLEAR TASK SET service request differently depending on whether the SATL provides multiple initiators access to the emulated SCSI device or not.

Author: SIERLGC[BMartin]
Subject: Highlight
Date: 3/31/2006 4:15:30 PM
T Page 21, 6.3.2, Note 3
"can" s.b. "may"

RESOLUTION: see 06-179rX: SAT - Fix Task Management Functions (rewritten as part of normative text)

Status
rlsheffi Completed 6/24/2006 9:00:38 AM

Sequence number: 22
Author: IBM[GPenokie]
Subject: Highlight
Date: 3/31/2006 4:25:47 PM
T Note 3

This <<the SATL can abort the >> should be << the SATL is able to abort the >>.

RESOLUTION: see 06-179rX: SAT - Fix Task Management Functions

Status
rlsheffi Completed 6/24/2006 9:00:45 AM

Sequence number: 23
Author: HPQ[RElliott]
Subject: Highlight
Date: 3/31/2006 4:56:19 PM
T 6.3.2
note 3

place s/b time

RESOLUTION: see 06-179rX: SAT - Fix Task Management Functions (rewritten)

Status
rlsheffi Completed 6/24/2006 9:00:51 AM

Sequence number: 24
Author: DELL[KMarks]
Subject: Highlight
Date: 3/31/2006 4:57:04 PM
T In Note 3

Change

"...domain, but instead return FUNCTION COMPLETE for the ABORT TASK request."

to

"...domain, but instead return a task management response of FUNCTION COMPLETE for the ABORT TASK task management request."

RESOLUTION: see 06-179rX: SAT - Fix Task Management Functions (rewritten)

Status
rlsheffi Completed 6/24/2006 9:02:57 AM

Sequence number: 25
Author: IBM[GPenokie]
Subject: Underline
Date: 2/16/2006 1:42:31 PM
T 6.3.3 ABORT TASK SET

Status
rlsheffi Cancelled 3/27/2006 9:19:11 AM

Sequence number: 26
Author: MXO[MEvans]
Subject: Highlight
Date: 3/31/2006 4:57:35 PM

T 6.3.3 ABORT TASK SET: change this to:

If the SATL does not provide multiple SCSI initiator devices access to the emulated SCSI target device, then the SATL shall process the service request as follows:

a) If commands have not been issued to the ATA device for tasks in the task set, then the SATL shall delete all tasks in the task set from the SATL internal context and respond to the ABORT TASK SET request with FUNCTION COMPLETE; or

Comments from page 41 continued on next page

6.3.2 ABORT TASK

The SATL may process the ABORT TASK service request in any of the following ways:

- a) If no commands have yet been issued to the ATA device for the processing of the specified SCSI task tag the SATL shall delete the specified task from the SATL internal context and respond to the ABORT TASK request with FUNCTION COMPLETE.
- b) If the only command(s) being processed in the ATA device are related to the SCSI task specified by the ABORT TASK request, then the SATL may abort the ATA command(s) and respond with FUNCTION COMPLETE.
- c) If the ATA device is processing commands for SCSI tasks in addition to the task specified by the ABORT TASK request the SATL shall:
 - A) abort outstanding ATA commands and respond to the ABORT TASK request with FUNCTION COMPLETE (see SAM3); and
 - B) for each initiator port associated with an I_T_Nexus that had a task aborted, the SATL shall complete at least one command for that I_T_Nexus with CHECK CONDITION status with the sense key set to UNIT ATTENTION and additional sense code set to COMMANDS CLEARED BY ANOTHER INITIATOR.

NOTE 3 - It may be that the first place the SATL can abort the command without preventing the processing of other commands is when the attached ATA device returns completion status for the ATA command. In this case the SATL would not provide a SCSI response for the aborted command, even though processing completed in the ATA domain, but instead return FUNCTION COMPLETE for the ABORT TASK request.

6.3.3 ABORT TASK SET

²⁷The SATL may handle the ABORT TASK SET service request differently depending on whether the SATL provides multiple ²⁸initiators access to the emulated SCSI device or not.

²⁹If the SATL does not provide multiple I_T nexuses access to the emulated SCSI device, the SATL shall process the service request as follows:

- 1) If commands have not been issued to the ATA device for the processing of the specified SCSI task tag the SATL shall delete all tasks in the task set from the SATL internal context and respond to the ABORT TASK SET request with FUNCTION COMPLETE.
- 2) If the only command(s) being processed in the ATA device are associated to the SCSI tasks in the task set, then the SATL shall abort the ATA command(s) and respond with FUNCTION COMPLETE.
- 3) The SATL shall abort outstanding ATA command(s) and respond to the ABORT TASK SET request with a FUNCTION COMPLETE.

If the SATL provides multiple initiators access to the emulated SCSI device, the SATL shall process the service request as follows:

- a) If commands have not been issued to the ATA device for the processing of the specified SCSI task tag the SATL shall delete the specified task from the SATL internal context and respond to the ABORT TASK SET request with FUNCTION COMPLETE.
- b) For each initiator port associated with an I_T_Nexus that had a task aborted, the SATL shall complete at least one command for that I_T_Nexus with CHECK CONDITION status with the sense key set to UNIT ATTENTION and additional sense code set to COMMANDS CLEARED BY ANOTHER INITIATOR.

6.3.4 CLEAR ACA

The SATL shall not support auto-contingent allegiance. The SATL shall indicate ACA is not supported by returning zero in the NORMACA bit in standard INQUIRY data. The SATL shall respond to a CLEAR ACA service request with FUNCTION REJECTED.

6.3.5 CLEAR TASK SET

The SATL may handle the CLEAR TASK SET service request differently depending on whether the SATL provides multiple initiators access to the emulated SCSI device or not.

b) The SATL shall abort outstanding ATA command(s) and respond to the ABORT TASK SET request with a FUNCTION COMPLETE.

If the SATL provides multiple SCSI initiator devices access to the emulated SCSI target device, then the SATL shall process the service request as follows:

a) If commands have not been issued to the ATA device for tasks in the task set, then the SATL shall delete the all tasks in the task set from the SATL internal context and respond to the ABORT TASK SET request with FUNCTION COMPLETE; or

b) If commands have been issued to the ATA device for tasks in the task set, then:

A) The SATL shall abort outstanding ATA command(s) and respond to the ABORT TASK SET request with a FUNCTION COMPLETE; and

B) For each other I_T nexus that had a task aborted, the SATL shall complete at least one command for that I_T nexus with CHECK CONDITION status with the sense key set to UNIT ATTENTION and additional sense code set to COMMANDS CLEARED BY ANOTHER INITIATOR.

RESOLUTION: see 06-179rX: SAT - Fix Task Management Functions

Status
rlsheffi Completed 6/24/2006 9:04:17 AM

Sequence number: 27
Author: DELL[KMarks]
Subject: Highlight
Date: 3/31/2006 4:58:08 PM

T 6.3.3 ABORT TASK SET
1st Paragraph, 1st Sentence
change

"The SATL may handle the ABORT TASK SET service request differently depending on whether the SATL provides multiple initiators access to the emulated SCSI device or not."

to

"The SATL may handle the ABORT TASK SET task management function request differently depending on whether the SATL provides multiple initiators access to the emulated SCSI logical unit or not."

RESOLUTION: see 06-179rX: SAT - Fix Task Management Functions

Status
rlsheffi Completed 7/24/2006 11:21:46 AM

Sequence number: 28
Author: HPQ[RElliott]
Subject: Highlight
Date: 3/31/2006 4:58:41 PM

T 6.3.3

fix bare "initiators"

RESOLUTION: see 06-179rX: SAT - Fix Task Management Functions (uses I_T_L nexus)

Status
rlsheffi Completed 6/24/2006 9:36:08 AM

Sequence number: 29
Author: DELL[KMarks]
Subject: Highlight
Date: 3/31/2006 4:59:28 PM

T 6.3.3 ABORT TASK SET
2nd Paragraph

"If the SATL does not provide multiple I_T nexuses access to the emulated SCSI device, the SATL shall process the service request as follows:

1) If commands have not been issued to the ATA device for the processing of the specified SCSI task tag the SATL shall delete all tasks in the task set from the SATL internal context and respond to the ABORT TASK SET request with FUNCTION COMPLETE.

2) If the only command(s) being processed in the ATA device are associated to the SCSI tasks in the task set, then the SATL shall abort the ATA command(s) and respond with FUNCTION COMPLETE.

3) The SATL shall abort outstanding ATA command(s) and respond to the ABORT TASK SET request with a FUNCTION COMPLETE."

6.3.2 ABORT TASK

The SATL may process the ABORT TASK service request in any of the following ways:

- a) If no commands have yet been issued to the ATA device for the processing of the specified SCSI task tag the SATL shall delete the specified task from the SATL internal context and respond to the ABORT TASK request with FUNCTION COMPLETE.
- b) If the only command(s) being processed in the ATA device are related to the SCSI task specified by the ABORT TASK request, then the SATL may abort the ATA command(s) and respond with FUNCTION COMPLETE.
- c) If the ATA device is processing commands for SCSI tasks in addition to the task specified by the ABORT TASK request the SATL shall:
 - A) abort outstanding ATA commands and respond to the ABORT TASK request with FUNCTION COMPLETE (see SAM3); and
 - B) for each initiator port associated with an I_T_Nexus that had a task aborted, the SATL shall complete at least one command for that I_T_Nexus with CHECK CONDITION status with the sense key set to UNIT ATTENTION and additional sense code set to COMMANDS CLEARED BY ANOTHER INITIATOR.

NOTE 3 - It may be that the first place the SATL can abort the command without preventing the processing of other commands is when the attached ATA device returns completion status for the ATA command. In this case the SATL would not provide a SCSI response for the aborted command, even though processing completed in the ATA domain, but instead return FUNCTION COMPLETE for the ABORT TASK request.

6.3.3 ABORT TASK SET

The SATL may handle the ABORT TASK SET service request differently depending on whether the SATL provides multiple initiators access to the emulated SCSI device or not.

If the SATL does not provide multiple I_T nexuses access to the emulated SCSI device, the SATL shall process the service request as follows:

- 1) If commands have not been issued to the ATA device for the processing of the specified SCSI task tag the SATL shall delete all tasks in the task set from the SATL internal context and respond to the ABORT TASK SET request with FUNCTION COMPLETE.
- 2) If the only command(s) being processed in the ATA device are associated to the SCSI tasks in the task set, then the SATL shall abort the ATA command(s) and respond with FUNCTION COMPLETE.
- 3) The SATL shall abort outstanding ATA command(s) and respond to the ABORT TASK SET request with a FUNCTION COMPLETE.

If the SATL provides multiple initiators access to the emulated SCSI device, the SATL shall process the service request as follows:

- a) If commands have not been issued to the ATA device for the processing of the specified SCSI task tag the SATL shall delete the specified task from the SATL internal context and respond to the ABORT TASK SET request with FUNCTION COMPLETE.
- b) For each initiator port associated with an I_T_Nexus that had a task aborted, the SATL shall complete at least one command for that I_T_Nexus with CHECK CONDITION status with the sense key set to UNIT ATTENTION and additional sense code set to COMMANDS CLEARED BY ANOTHER INITIATOR.

6.3.4 CLEAR ACA

The SATL shall not support auto-contingent allegiance. The SATL shall indicate ACA is not supported by returning zero in the NORMACA bit in standard INQUIRY data. The SATL shall respond to a CLEAR ACA service request with FUNCTION REJECTED.

6.3.5 CLEAR TASK SET

The SATL may handle the CLEAR TASK SET service request differently depending on whether the SATL provides multiple initiators access to the emulated SCSI device or not.

to
"If the SATL does not provide multiple initiators access to the emulated SCSI logical unit, the SATL shall process the ABORT TASK SET task management function request by aborting any outstanding ATA command(s), deleting all tasks in the task set from the SATL internal context and respond to the ABORT TASK SET task management function request with a task management response of FUNCTION COMPLETE."

If the SATL only supports 1 initiator, then there is only one task set, so abort all the ATA commands and SATL internal context and response FUNCTION COMPLETE. Don't see what the SCSI task tag has to do with ABORT TASK SET?

RESOLUTION: see 06-179rX: SAT - Fix Task Management Functions (rewritten)

Status
risheffi Completed 6/24/2006 9:40:44 AM

Sequence number: 30
Author: ENDL[RWeber]
Date: 6/3/2006 8:33:41 AM

 1,2,3 list

This list is not properly structured. Entries 1 and 2 end with periods. There is no conjunction between entries 2 and 3.
RESOLUTION: see 06-179rX: SAT - Fix Task Management Functions

Status
risheffi Completed 6/24/2006 1:23:07 PM

Sequence number: 31
Author: IBM[GPenokie]
Subject: Comment on Text
Date: 6/3/2006 8:34:02 AM

 Item 1

This needs to end in a ; not a .
RESOLUTION: see 06-179rX: SAT - Fix Task Management Functions

Status
risheffi Completed 6/24/2006 1:26:19 PM

Sequence number: 32
Author: SIERLGC[BMartin]
Subject: Note
Date: 3/31/2006 5:00:29 PM

 Page 21, 6.3.3, list items 1 2 and 3
add "associated with the I_T_Nexus"

RESOLUTION: see 06-179rX: SAT - Fix Task Management Functions

Status
risheffi Completed 6/24/2006 1:27:27 PM

Sequence number: 33
Author: IBM[GPenokie]
Subject: Comment on Text
Date: 6/3/2006 8:34:21 AM

 Item 2

This item needs to end in a << ; and >>not a << . >>.
RESOLUTION: see 06-179rX: SAT - Fix Task Management Functions

Status
risheffi Completed 6/24/2006 1:31:59 PM

Sequence number: 34
Author: SIERLGC[BMartin]
Subject: Note
Date: 3/31/2006 5:01:15 PM

 Page 21, 6.3.3, 1-3 list
why is this a numbered list?

RESOLUTION: see 06-179rX: SAT - Fix Task Management Functions

Status
risheffi Completed 6/24/2006 1:33:07 PM

Sequence number: 35
Author: DELL[KMarks]
Subject: Highlight

Comments from page 41 continued on next page

6.3.2 ABORT TASK

The SATL may process the ABORT TASK service request in any of the following ways:

- a) If no commands have yet been issued to the ATA device for the processing of the specified SCSI task tag the SATL shall delete the specified task from the SATL internal context and respond to the ABORT TASK request with FUNCTION COMPLETE.
- b) If the only command(s) being processed in the ATA device are related to the SCSI task specified by the ABORT TASK request, then the SATL may abort the ATA command(s) and respond with FUNCTION COMPLETE.
- c) If the ATA device is processing commands for SCSI tasks in addition to the task specified by the ABORT TASK request the SATL shall:
 - A) abort outstanding ATA commands and respond to the ABORT TASK request with FUNCTION COMPLETE (see SAM3); and
 - B) for each initiator port associated with an I_T_Nexus that had a task aborted, the SATL shall complete at least one command for that I_T_Nexus with CHECK CONDITION status with the sense key set to UNIT ATTENTION and additional sense code set to COMMANDS CLEARED BY ANOTHER INITIATOR.

NOTE 3 - It may be that the first place the SATL can abort the command without preventing the processing of other commands is when the attached ATA device returns completion status for the ATA command. In this case the SATL would not provide a SCSI response for the aborted command, even though processing completed in the ATA domain, but instead return FUNCTION COMPLETE for the ABORT TASK request.

6.3.3 ABORT TASK SET

The SATL may handle the ABORT TASK SET service request differently depending on whether the SATL provides multiple initiators access to the emulated SCSI device or not.

If the SATL does not provide multiple I_T nexuses access to the emulated SCSI device, the SATL shall process the service request as follows:

- 1) If commands have not been issued to the ATA device for the processing of the specified SCSI task tag the SATL shall delete all tasks in the task set from the SATL internal context and respond to the ABORT TASK SET request with FUNCTION COMPLETE.
- 2) If the only command(s) being processed in the ATA device are associated to the SCSI tasks in the task set, then the SATL shall abort the ATA command(s) and respond with FUNCTION COMPLETE.
- 3) The SATL shall abort outstanding ATA command(s) and respond to the ABORT TASK SET request with a FUNCTION COMPLETE.

If the SATL provides multiple initiators access to the emulated SCSI device, the SATL shall process the service request as follows:

- a) If commands have not been issued to the ATA device for the processing of the specified SCSI task tag the SATL shall delete the specified task from the SATL internal context and respond to the ABORT TASK SET request with FUNCTION COMPLETE.
- b) For each initiator port associated with an I_T_Nexus that had a task aborted, the SATL shall complete at least one command for that I_T_Nexus with CHECK CONDITION status with the sense key set to UNIT ATTENTION and additional sense code set to COMMANDS CLEARED BY ANOTHER INITIATOR.

6.3.4 CLEAR ACA

The SATL shall not support auto-contingent allegiance. The SATL shall indicate ACA is not supported by returning zero in the NORMACA bit in standard INQUIRY data. The SATL shall respond to a CLEAR ACA service request with FUNCTION REJECTED.

6.3.5 CLEAR TASK SET

The SATL may handle the CLEAR TASK SET service request differently depending on whether the SATL provides multiple initiators access to the emulated SCSI device or not.

Date: 3/31/2006 5:01:30 PM

T 6.3.3 ABORT TASK SET

3rd Paragraph
change

"If the SATL provides multiple initiators access to the emulated SCSI device, the SATL shall process the service request as follows:

a) If commands have not been issued to the ATA device for the processing of the specified SCSI task tag the SATL shall delete the specified task from the SATL internal context and respond to the ABORT TASK SET request with FUNCTION COMPLETE.

b) For each initiator port associated with an I_T_Nexus that had a task aborted, the SATL shall complete at least one command for that I_T_Nexus with CHECK CONDITION status with the sense key set to UNIT ATTENTION and additional sense code set to COMMANDS CLEARED BY ANOTHER INITIATOR."

Current text directly violates SAM-3, in that the ABORT TASK SET shall not affect tasks from other I_T nexuses.

to

"If the SATL does provide multiple initiators access to the emulated SCSI logical unit, the SATL shall process the ABORT TASK SET task management function request as follows:

1) allow any outstanding ATA command(s) to complete related to the processing of tasks associated with the I_T nexus which the ABORT TASK SET task management function was received;

2) delete all tasks in the task set from the SATL internal context for tasks associated with the I_T nexus which the ABORT TASK SET task management function was received; and

3) respond to the ABORT TASK SET task management function request with a task management function response of FUNCTION COMPLETE."

RESOLUTION: see 06-179rX: SAT - Fix Task Management Functions

Status

risheffi Completed 6/24/2006 1:41:18 PM

Sequence number: 36

Author: ENDL[RWeber]

Date: 6/3/2006 8:34:44 AM

 a,b list

This list is not properly structured. Entry a ends with a period. There is no conjunction between entries a and b.

RESOLUTION: see 06-179rX: SAT - Fix Task Management Functions

Status

risheffi Completed 6/24/2006 1:49:22 PM

Sequence number: 37

Author: SIERLGC[BMartin]

Subject: Note

Date: 3/31/2006 5:02:12 PM

 Page 21, 6.3.3, a-b list

Why are the ATA commands not aborted as in list above? Also needs to do the same as suggested in 6.3.2

RESOLUTION: see 06-179rX: SAT - Fix Task Management Functions (agree - should be aborted)

Status

risheffi Completed 6/24/2006 1:51:02 PM

Sequence number: 38

Author: IBM[GPenokie]

Subject: Comment on Text

Date: 6/3/2006 8:34:55 AM

 item a

This item needs to end in a << ; and >>not a << . >>.

RESOLUTION: see 06-179rX: SAT - Fix Task Management Functions

Status

risheffi Completed 6/24/2006 1:51:25 PM

Sequence number: 39

Author: HPQ[RElliott]

Subject: Highlight

Date: 2/1/2006 11:19:50 AM

 6.3.3

Comments from page 41 continued on next page

6.3.2 ABORT TASK

The SATL may process the ABORT TASK service request in any of the following ways:

- a) If no commands have yet been issued to the ATA device for the processing of the specified SCSI task tag the SATL shall delete the specified task from the SATL internal context and respond to the ABORT TASK request with FUNCTION COMPLETE.
- b) If the only command(s) being processed in the ATA device are related to the SCSI task specified by the ABORT TASK request, then the SATL may abort the ATA command(s) and respond with FUNCTION COMPLETE.
- c) If the ATA device is processing commands for SCSI tasks in addition to the task specified by the ABORT TASK request the SATL shall:
 - A) abort outstanding ATA commands and respond to the ABORT TASK request with FUNCTION COMPLETE (see SAM3); and
 - B) for each initiator port associated with an I_T_Nexus that had a task aborted, the SATL shall complete at least one command for that I_T_Nexus with CHECK CONDITION status with the sense key set to UNIT ATTENTION and additional sense code set to COMMANDS CLEARED BY ANOTHER INITIATOR.

NOTE 3 - It may be that the first place the SATL can abort the command without preventing the processing of other commands is when the attached ATA device returns completion status for the ATA command. In this case the SATL would not provide a SCSI response for the aborted command, even though processing completed in the ATA domain, but instead return FUNCTION COMPLETE for the ABORT TASK request.

6.3.3 ABORT TASK SET

The SATL may handle the ABORT TASK SET service request differently depending on whether the SATL provides multiple initiators access to the emulated SCSI device or not.

If the SATL does not provide multiple I_T nexuses access to the emulated SCSI device, the SATL shall process the service request as follows:

- 1) If commands have not been issued to the ATA device for the processing of the specified SCSI task tag the SATL shall delete all tasks in the task set from the SATL internal context and respond to the ABORT TASK SET request with FUNCTION COMPLETE.
- 2) If the only command(s) being processed in the ATA device are associated to the SCSI tasks in the task set, then the SATL shall abort the ATA command(s) and respond with FUNCTION COMPLETE.
- 3) The SATL shall abort outstanding ATA command(s) and respond to the ABORT TASK SET request with a FUNCTION COMPLETE.

If the SATL provides multiple initiators access to the emulated SCSI device, the SATL shall process the service request as follows:

- a) If commands have not been issued to the ATA device for the processing of the specified SCSI task tag the SATL shall delete the specified task from the SATL internal context and respond to the ABORT TASK SET request with FUNCTION COMPLETE.
- b) For each initiator port associated with an I_T_Nexus that had a task aborted, the SATL shall complete at least one command for that I_T_Nexus with CHECK CONDITION status with the sense key set to UNIT ATTENTION and additional sense code set to COMMANDS CLEARED BY ANOTHER INITIATOR.

6.3.4 CLEAR ACA

The SATL shall not support auto-contingent allegiance. The SATL shall indicate ACA is not supported by turning zero in the NORMACA bit in standard INQUIRY data. The SATL shall respond to a CLEAR ACA service request with FUNCTION REJECTED.

6.3.5 CLEAR TASK SET

The SATL may handle the CLEAR TASK SET service request differently depending on whether the SATL provides multiple initiators access to the emulated SCSI device or not.

I_T_Nexus s/b I_T nexus

Status

risheffi Completed 6/3/2006 8:35:18 AM

Sequence number: 40
Author: WDC[CStevens]
Subject: Comment on Text
Date: 6/24/2006 2:23:21 PM

T Why should this standard prevent a SATL from implementing ACA? What is the harm?
REASON: April 10 SAT Teleconference couldn't see a need to support it. Recommend deferring to SAT-2.

Status

risheffi Rejected 6/24/2006 2:22:41 PM

Sequence number: 41
Author: DELL[KMarks]
Subject: Highlight
Date: 3/31/2006 5:04:54 PM

T **6.3.4 CLEAR ACA**
1st Paragraph, 2nd Sentence
change
"...returning zero in the NORMACA bit in standard INQUIRY..."
to
"...returning the NORMACA bit set to zero in standard INQUIRY..."

RESOLUTION: see 06-179rX: SAT - Fix Task Management Functions (rewrite allows for ACA)

Status

risheffi Rejected 3/31/2006 5:04:26 PM

Sequence number: 42
Author: DELL[KMarks]
Subject: Highlight
Date: 3/31/2006 5:05:31 PM

T **6.3.4 CLEAR ACA**
1st Paragraph, 3rd Sentence
change
"The SATL shall respond to a CLEAR ACA service request with FUNCTION REJECTED."
to
"The SATL shall respond to a CLEAR ACA task management function request with a task management function response of FUNCTION REJECTED."

RESOLUTION: see 06-179rX: SAT - Fix Task Management Functions (rewrite allows for ACA).

Status

risheffi Rejected 3/31/2006 5:05:13 PM

Sequence number: 43
Author: ENDL[RWeber]
Date: 6/3/2006 8:39:36 AM

 Should the reference to 'standard INQUIRY data' be accompanied by a '(see SPC-3)?'
RESOLUTION: see 06-179rX: SAT - Fix Task Management Functions

Status

risheffi Completed 6/24/2006 2:25:42 PM

Sequence number: 44
Author: IBM[GPenokie]
Subject: Underline
Date: 2/16/2006 1:45:48 PM

T **6.3.5 CLEAR TASK SET**

Status

risheffi Cancelled 3/30/2006 4:38:46 PM

Sequence number: 45
Author: MXO[MEvans]
Subject: Highlight
Date: 3/31/2006 5:07:06 PM

T 6.3.5 CLEAR TASK SET: change the clause to be as specified in the next comment.

Comments from page 41 continued on next page

6.3.2 ABORT TASK

The SATL may process the ABORT TASK service request in any of the following ways:

- a) If no commands have yet been issued to the ATA device for the processing of the specified SCSI task tag the SATL shall delete the specified task from the SATL internal context and respond to the ABORT TASK request with FUNCTION COMPLETE.
- b) If the only command(s) being processed in the ATA device are related to the SCSI task specified by the ABORT TASK request, then the SATL may abort the ATA command(s) and respond with FUNCTION COMPLETE.
- c) If the ATA device is processing commands for SCSI tasks in addition to the task specified by the ABORT TASK request the SATL shall:
 - A) abort outstanding ATA commands and respond to the ABORT TASK request with FUNCTION COMPLETE (see SAM3); and
 - B) for each initiator port associated with an I_T_Nexus that had a task aborted, the SATL shall complete at least one command for that I_T_Nexus with CHECK CONDITION status with the sense key set to UNIT ATTENTION and additional sense code set to COMMANDS CLEARED BY ANOTHER INITIATOR.

NOTE 3 - It may be that the first place the SATL can abort the command without preventing the processing of other commands is when the attached ATA device returns completion status for the ATA command. In this case the SATL would not provide a SCSI response for the aborted command, even though processing completed in the ATA domain, but instead return FUNCTION COMPLETE for the ABORT TASK request.

6.3.3 ABORT TASK SET

The SATL may handle the ABORT TASK SET service request differently depending on whether the SATL provides multiple initiators access to the emulated SCSI device or not.

If the SATL does not provide multiple I_T nexuses access to the emulated SCSI device, the SATL shall process the service request as follows:

- 1) If commands have not been issued to the ATA device for the processing of the specified SCSI task tag the SATL shall delete all tasks in the task set from the SATL internal context and respond to the ABORT TASK SET request with FUNCTION COMPLETE.
- 2) If the only command(s) being processed in the ATA device are associated to the SCSI tasks in the task set, then the SATL shall abort the ATA command(s) and respond with FUNCTION COMPLETE.
- 3) The SATL shall abort outstanding ATA command(s) and respond to the ABORT TASK SET request with a FUNCTION COMPLETE.

If the SATL provides multiple initiators access to the emulated SCSI device, the SATL shall process the service request as follows:

- a) If commands have not been issued to the ATA device for the processing of the specified SCSI task tag the SATL shall delete the specified task from the SATL internal context and respond to the ABORT TASK SET request with FUNCTION COMPLETE.
- b) For each initiator port associated with an I_T_Nexus that had a task aborted, the SATL shall complete at least one command for that I_T_Nexus with CHECK CONDITION status with the sense key set to UNIT ATTENTION and additional sense code set to COMMANDS CLEARED BY ANOTHER INITIATOR.

6.3.4 CLEAR ACA

The SATL shall not support auto-contingent allegiance. The SATL shall indicate ACA is not supported by returning zero in the NORMACA bit in standard INQUIRY data. The SATL shall respond to a CLEAR ACA service request with FUNCTION REJECTED.

6.3.5 CLEAR TASK SET

The SATL may handle the CLEAR TASK SET service request differently depending on whether the SATL provides multiple initiators access to the emulated SCSI device or not.

RESOLUTION: see 06-179rX: SAT - Fix Task Management Functions

Status
rlsheffi Completed 6/24/2006 2:29:37 PM

Sequence number: 46
Author: DELL[KMarks]
Subject: Highlight
Date: 4/10/2006 11:43:28 AM

T 6.3.5 CLEAR TASK SET
1st Paragraph, 1st Sentence
change

"The SATL may handle the CLEAR TASK SET service request differently depending on whether the SATL provides multiple initiators access to the emulated SCSI device or not."

to

"The SATL may handle the CLEAR TASK SET task management function request differently depending on whether the SATL provides multiple initiators access to the emulated SCSI logical unit."

Probably need to add a statement about it being optional for LU's supporting only the basic task management model.

RESOLUTION: see 06-179rX: SAT - Fix Task Management Functions (Need consistency regarding support for the BASIC task management model)

Status
rlsheffi Completed 6/24/2006 2:31:08 PM

2 the SATL does not provide multiple initiators access to the emulated SCSI device, the SATL shall process the service request as follows:

- 1) If commands have not been issued to the ATA device for the processing of the specified SCSI task tag the SATL shall delete all tasks in the task set from the SATL internal context and respond to the CLEAR TASK SET request with FUNCTION COMPLETE.
- 2) If the only command(s) being processed in the ATA device are associated to the SCSI tasks in the task set, then the SATL shall abort the SATA command(s) and respond with FUNCTION COMPLETE.
- 3) The SATL shall abort outstanding ATA command(s) and respond to the CLEAR TASK SET request with FUNCTION COMPLETE.

If the SATL provides multiple initiators access to the emulated SCSI device, the SATL shall process the service request as follows:

- 1) If commands have not been issued to the ATA device for the processing of the specified SCSI task tag the SATL shall delete the specified task from the SATL internal context and respond to the CLEAR TASK SET request with FUNCTION COMPLETE.
- 2) For each initiator port associated with an I_T_Nexus that had a task aborted, the SATL shall complete at least one command for that I_T_Nexus with CHECK CONDITION status with the sense key set to UNIT ATTENTION and additional sense code set to COMMANDS CLEARED BY ANOTHER INITIATOR.

6.3.6 LOGICAL UNIT RESET

LOGICAL UNIT RESET shall cause the SATL to issue a software reset (i.e., set the SRST bit to one in the Device Control register, then set the bit to zero) to the ATA device representing the specified logical unit. Any persistent behaviors shall be reestablished by the SATL afterwards, including any behaviors related to saveable mode parameters.

NOTE 4 - BUS RESET is commonly used by SCSI application layers to hard reset each device mapped to a target ID on a given SCSI bus. The SATL may translate the BUS RESET by issuing a protocol specific HARD RESET to each target device (e.g. SATA COMRESET or SAS PHY HARD RESET).

NOTE 5 - If more than one device is present on a PATA bus, issuing a soft reset causes both devices to be reset.

6.3.7 QUERY TASK

QUERY TASK shall cause the SATL to search for the specified task and, if found, respond with FUNCTION SUCCEEDED. If the specified task is not found the SATL shall respond with FUNCTION COMPLETE.

6.4 SCSI Control Byte

6.4.1 CONTROL byte overview

Table 5 describes SATL handling of the CDB CONTROL byte. See SAM-3 for CONTROL byte details.

Table 5 — Control byte fields

Field	Description or reference
Vendor specific	The SATL may use this field for vendor-specific purposes.
NACA	If set to one, the SATL shall terminate the command with CHECK CONDITION status with the sense key set to ILLEGAL REQUEST and the additional sense code set to INVALID FIELD IN CDB.
LINK	If set to one, the SATL shall return a CHECK CONDITION with the sense key set to ILLEGAL REQUEST and additional sense code set to INVALID FIELD IN CDB.

Sequence number: 1
Author: DELL[KMarks]
Subject: Highlight
Date: 3/31/2006 5:09:14 PM

T 6.3.5 CLEAR TASK SET
2nd Paragraph, 1st Sentence
change

"If the SATL does not provide multiple initiators access to the emulated SCSI device, the SATL shall process the service request as follows:

1) If commands have not been issued to the ATA device for the processing of the specified SCSI task tag the SATL shall delete all tasks in the task set from the SATL internal context and respond to the CLEAR TASK SET request with FUNCTION COMPLETE.

2) If the only command(s) being processed in the ATA device are associated to the SCSI tasks in the task set, then the SATL shall abort the SATA command(s) and respond with FUNCTION COMPLETE.

3) The SATL shall abort outstanding ATA command(s) and respond to the CLEAR TASK SET request with FUNCTION COMPLETE."

to

"If the SATL does not provide multiple initiators access to the emulated SCSI logical unit, the SATL shall process the CLEAR TASK SET task management function request by aborting any outstanding ATA command(s), deleting all tasks in the task set from the SATL internal context and respond to the CLEAR TASK SET task management function request with a task management response of FUNCTION COMPLETE."

RESOLUTION: see 06-179rX: SAT - Fix Task Management Functions

Status
rlsheffi Completed 6/24/2006 3:15:25 PM

Sequence number: 2
Author: MXO[MEvans]
Subject: Highlight
Date: 3/31/2006 5:14:41 PM

T 6.3.3 CLEAR TASK SET: change this clause to be as follows:

If the SATL does not provide multiple SCSI initiator devices access to the emulated SCSI target device, then the SATL shall process the service request as follows:

- a) If commands have not been issued to the ATA device for tasks in the task set, then the SATL shall delete all tasks in the task set from the SATL internal context and respond to the CLEAR TASK SET request with FUNCTION COMPLETE; or
- b) The SATL shall abort outstanding ATA command(s) and respond to the CLEAR TASK SET request with a FUNCTION COMPLETE.

If the SATL provides multiple SCSI initiator devices access to the emulated SCSI target device, the SATL shall process the service request as follows:

- a) If commands have not been issued to the ATA device for tasks in the task set, then the SATL shall delete the all tasks in the task set as defined by the TST field in the Control mode page (see SPC-3) from the SATL internal context and respond to the CLEAR TASK SET request with FUNCTION COMPLETE; or
- b) If commands have been issued to the ATA device for tasks in the task set, then:
 - A) The SATL shall abort outstanding ATA command(s) and respond to the CLEAR TASK SET request with a FUNCTION COMPLETE; and
 - B) For each other I_T nexus that had a task aborted, the SATL shall complete at least one command for that I_T nexus with CHECK CONDITION status with the sense key set to UNIT ATTENTION and additional sense code set to COMMANDS CLEARED BY ANOTHER INITIATOR.

RESOLUTION: see 06-179rX: SAT - Fix Task Management Functions

Status
rlsheffi Completed 6/24/2006 8:19:32 AM

Sequence number: 3
Author: ENDL[RWeber]

If the SATL does not provide multiple initiators access to the emulated SCSI device, the SATL shall process the service request as follows:

- 1) If commands have not been issued to the ATA device for the processing of the specified SCSI task tag the SATL shall delete all tasks in the task set from the SATL internal context and respond to the CLEAR TASK SET request with **FUNCTION COMPLETE**.
- 2) If the only command(s) being processed in the ATA device are associated to the SCSI tasks in the task set, then the SATL shall abort the ATA command(s) and respond with **FUNCTION COMPLETE**.
- 3) The SATL shall abort outstanding ATA command(s) and respond to the CLEAR TASK SET request with **FUNCTION COMPLETE**.

If the SATL provides multiple initiators access to the emulated SCSI device, the SATL shall process the service request as follows:

- 1) If commands have not been issued to the ATA device for the processing of the specified SCSI task tag the SATL shall delete the specified task from the SATL internal context and respond to the CLEAR TASK SET request with **FUNCTION COMPLETE**.
- 2) For each initiator port associated with an I_T_Nexus that had a task aborted, the SATL shall complete at least one command for that I_T_Nexus with CHECK CONDITION status with the sense key set to UNIT ATTENTION and additional sense code set to COMMANDS CLEARED BY ANOTHER INITIATOR.

6.3.6 LOGICAL UNIT RESET

LOGICAL UNIT RESET shall cause the SATL to issue a software reset (i.e., set the SRST bit to one in the Device Control register, then set the bit to zero) to the ATA device representing the specified logical unit. Any persistent behaviors shall be reestablished by the SATL afterwards, including any behaviors related to saveable mode parameters.

NOTE 4 - BUS RESET is commonly used by SCSI application layers to hard reset each device mapped to a target ID on a given SCSI bus. The SATL may translate the BUS RESET by issuing a protocol specific HARD RESET to each target device (e.g. SATA COMRESET or SAS PHY HARD RESET).

NOTE 5 - If more than one device is present on a PATA bus, issuing a soft reset causes both devices to be reset.

6.3.7 QUERY TASK

QUERY TASK shall cause the SATL to search for the specified task and, if found, respond with **FUNCTION SUCCEEDED**. If the specified task is not found the SATL shall respond with **FUNCTION COMPLETE**.

6.4 SCSI Control Byte

6.4.1 CONTROL byte overview

Table 5 describes SATL handling of the CDB CONTROL byte. See SAM-3 for CONTROL byte details.

Table 5 — Control byte fields

Field	Description or reference
Vendor specific	The SATL may use this field for vendor-specific purposes.
NACA	If set to one, the SATL shall terminate the command with CHECK CONDITION status with the sense key set to ILLEGAL REQUEST and the additional sense code set to INVALID FIELD IN CDB.
LINK	If set to one, the SATL shall return a CHECK CONDITION with the sense key set to ILLEGAL REQUEST and additional sense code set to INVALID FIELD IN CDB.

Date: 6/3/2006 8:40:49 AM

 1,2,3 list

This list is not properly structured. Entries 1 and 2 end with periods. There is no conjunction between entries 2 and 3.
RESOLUTION: see 06-179rX: SAT - Fix Task Management Functions

Status
risheffi Completed 6/24/2006 8:27:34 AM

Sequence number: 4
Author: IBM[GPenokie]
Subject: Comment on Text
Date: 6/3/2006 8:40:58 AM
first item 1

 This item needs to end in a << ; >>not a << . >>.
RESOLUTION: see 06-179rX: SAT - Fix Task Management Functions

Status
risheffi Completed 6/24/2006 8:28:23 AM

Sequence number: 5
Author: IBM[GPenokie]
Subject: Comment on Text
Date: 6/3/2006 8:41:03 AM
first item 2

 This item needs to end in a << ; and >>not a << . >>.
RESOLUTION: see 06-179rX: SAT - Fix Task Management Functions

Status
risheffi Completed 6/24/2006 8:34:22 AM

Sequence number: 6
Author: ELX[KHirata]
Subject: Highlight
Date: 2/23/2006 4:55:06 PM
Page 22, First Paragraph, Second Numbered item.

 SATA s/b ATA

Status
risheffi Completed 6/3/2006 8:42:36 AM

Sequence number: 7
Author: DELL[KMarks]
Subject: Highlight
Date: 3/31/2006 5:17:01 PM

 **6.3.5 CLEAR TASK SET**
3rd Paragraph, 1st Sentence
change

"If the SATL provides multiple initiators access to the emulated SCSI device, the SATL shall process the service request as follows:

1) If commands have not been issued to the ATA device for the processing of the specified SCSI task tag the SATL shall delete the specified task from the SATL internal context and respond to the CLEAR TASK SET request with FUNCTION COMPLETE.

2) For each initiator port associated with an I_T_Nexus that had a task aborted, the SATL shall complete at least one command for that I_T_Nexus with CHECK CONDITION status with the sense key set to UNIT ATTENTION and additional sense code set to COMMANDS CLEARED BY ANOTHER INITIATOR."

to

"If the SATL does provide multiple initiators access to the emulated SCSI logical unit, the SATL shall process the CLEAR TASK SET task management function request as follows:

1) Abort any outstanding ATA command(s), delete all tasks in the task set from the SATL internal context and respond to the CLEAR TASK SET task management function request with a task management response of FUNCTION COMPLETE; and

2) For each initiator port associated with an I_T nexus that had a task aborted, complete at least one command for that I_T nexus with CHECK CONDITION status with the sense key set to UNIT ATTENTION and additional sense code set to COMMANDS CLEARED BY ANOTHER INITIATOR."

This assumes TST=0 for SAT devices

Comments from page 42 continued on next page

If the SATL does not provide multiple initiators access to the emulated SCSI device, the SATL shall process the service request as follows:

- 1) If commands have not been issued to the ATA device for the processing of the specified SCSI task tag the SATL shall delete all tasks in the task set from the SATL internal context and respond to the CLEAR TASK SET request with FUNCTION COMPLETE.
- 2) If the only command(s) being processed in the ATA device are associated to the SCSI tasks in the task set, then the SATL shall abort the SATA command(s) and respond with FUNCTION COMPLETE.
- 3) The SATL shall abort outstanding ATA command(s) and respond to the CLEAR TASK SET request with FUNCTION COMPLETE.

If the SATL provides multiple initiators access to the emulated SCSI device, the SATL shall process the service request as follows:

- 1) If commands have not been issued to the ATA device for the processing of the specified SCSI task tag the SATL shall delete the specified task from the SATL internal context and respond to the CLEAR TASK SET request with FUNCTION COMPLETE.
- 2) For each initiator port associated with an I_T_Nexus that had a task aborted, the SATL shall complete at least one command for that I_T_Nexus with CHECK CONDITION status with the sense key set to UNIT ATTENTION and additional sense code set to COMMANDS CLEARED BY ANOTHER INITIATOR.

6.3.6 LOGICAL UNIT RESET

LOGICAL UNIT RESET shall cause the SATL to issue a software reset, set the SRST bit to one in the Device Control register, then set the bit to zero) to the ATA device representing the specified logical unit. Any persistent behaviors shall be reestablished by the SATL afterwards, including any behaviors related to saveable mode parameters.

NOTE 4 - BUS RESET is commonly used by SCSI application layers to hard reset each device mapped to a target ID on a given SCSI bus. The SATL may translate the BUS RESET by issuing a protocol specific HARD RESET to each target device (e.g. SATA COMRESET or SAS PHY HARD RESET).

NOTE 5 - If more than one device is present on a PATA bus, issuing a soft reset causes both devices to be reset.

6.3.7 QUERY TASK

QUERY TASK shall cause the SATL to search for the specified task and, if found, respond with FUNCTION SUCCEEDED. If the specified task is not found the SATL shall respond with FUNCTION COMPLETE.

6.4 SCSI Control Byte

6.4.1 CONTROL byte overview

Table 5 describes SATL handling of the CDB CONTROL byte. See SAM-3 for CONTROL byte details.

Table 5 — Control byte fields

Field	Description or reference
Vendor specific	The SATL may use this field for vendor-specific purposes.
NACA	If set to one, the SATL shall terminate the command with CHECK CONDITION status with the sense key set to ILLEGAL REQUEST and the additional sense code set to INVALID FIELD IN CDB.
LINK	If set to one, the SATL shall return a CHECK CONDITION with the sense key set to ILLEGAL REQUEST and additional sense code set to INVALID FIELD IN CDB.

RESOLUTION: see 06-179rX: SAT - Fix Task Management Functions (The Control mode page requires TST=000h for SAT devices - i.e., only one task set shared by I_T_L nexuses).

Status
risheffi Completed 6/24/2006 3:18:33 PM

Sequence number: 8
Author: ENDL[RWeber]
Date: 6/3/2006 8:43:05 AM

 1,2 list

This list is not properly structured. Entry 1 ends with a period. There is no conjunction between entries 1 and 2.
RESOLUTION: see 06-179rX: SAT - Fix Task Management Functions

Status
risheffi Completed 6/24/2006 8:39:16 AM

Sequence number: 9
Author: IBM[GPenokie]
Subject: Comment on Text
Date: 6/3/2006 8:43:09 AM

 2nd item 1

This item needs to end in a << ; and >>not a << . >>.
RESOLUTION: see 06-179rX: SAT - Fix Task Management Functions

Status
risheffi Completed 6/24/2006 8:39:47 AM

Sequence number: 10
Author: MXO[MEvans]
Subject: Highlight
Date: 3/31/2006 5:17:42 PM

 6.3.6 LOGICAL UNIT RESET: either change the "i.e." to an "e.g.", or specify how this is done with SATA devices.

RESOLUTION: see 06-179rX: SAT - Fix Task Management Functions (rewritten)

Status
risheffi Completed 6/24/2006 9:02:29 AM

Sequence number: 11
Author: DELL[KMarks]
Subject: Highlight
Date: 6/3/2006 8:50:45 AM

 6.3.6 LOGICAL UNIT RESET
1st Paragraph, 1st Sentence

change

"LOGICAL UNIT RESET shall cause the SATL to issue a software reset (i.e., set the SRST bit to one in the Device Control register, then set the bit to zero) to the ATA device representing the specified logical unit. Any persistent behaviors shall be reestablished by the SATL afterwards, including any behaviors related to saveable mode parameters."
to

"A LOGICAL UNIT RESET task management function request shall cause the SATL to issue a software reset (i.e., set the SRST bit to one in the Device Control register, then set the bit to zero) to the ATA device representing the specified logical unit and delete all tasks in the task set from the SATL internal context and respond to the LOGICAL UNIT RESET task management function request with a task management response of FUNCTION COMPLETE. Any persistent behaviors shall be reestablished by the SATL afterwards, including any behaviors related to saveable mode parameters. "

Another instance of saveable mode page support?

RESOLUTION: see 06-179rX: SAT - Fix Task Management Functions (LOGICAL UNIT RESET clears "current" mode page values, so if SAT disallows savable mode parameters, behaviors should be restored to default values. I believe we've decided to allow support for savable mode pages, so the text is OK in that regard). Note: 06-179r1 incorrectly says to restore "current" values. The final version should say to restore to "saved or default values (see SPC-3)".

Status
risheffi Completed 6/24/2006 9:03:31 AM

Sequence number: 12
Author: STX[GHoulder]
Subject: Highlight
Date: 3/31/2006 5:28:35 PM

 PDF page 42

Section 6.3.6: "(i.e set the SRST bit to one in the Device Control

Comments from page 42 continued on next page

If the SATL does not provide multiple initiators access to the emulated SCSI device, the SATL shall process the service request as follows:

- 1) If commands have not been issued to the ATA device for the processing of the specified SCSI task tag the SATL shall delete all tasks in the task set from the SATL internal context and respond to the CLEAR TASK SET request with FUNCTION COMPLETE.
- 2) If the only command(s) being processed in the ATA device are associated to the SCSI tasks in the task set, then the SATL shall abort the SATA command(s) and respond with FUNCTION COMPLETE.
- 3) The SATL shall abort outstanding ATA command(s) and respond to the CLEAR TASK SET request with FUNCTION COMPLETE.

If the SATL provides multiple initiators access to the emulated SCSI device, the SATL shall process the service request as follows:

- 1) If commands have not been issued to the ATA device for the processing of the specified SCSI task tag the SATL shall delete the specified task from the SATL internal context and respond to the CLEAR TASK SET request with FUNCTION COMPLETE.
- 2) For each initiator port associated with an I_T_Nexus that had a task aborted, the SATL shall complete at least one command for that I_T_Nexus with CHECK CONDITION status with the sense key set to UNIT ATTENTION and additional sense code set to COMMANDS CLEARED BY ANOTHER INITIATOR.

6.3.6 LOGICAL UNIT RESET

LOGICAL UNIT RESET shall cause the SATL to issue a software reset (i.e., set the SRST bit to one in the Device Control register, then set the bit to zero) to the ATA device representing the specified logical unit. Any persistent behaviors shall be reestablished by the SATL afterwards, including any behaviors related to saveable mode parameters.

NOTE 4 - BUS RESET is commonly used by SCSI application layers to hard reset each device mapped to a target ID on a given bus. The SATL may translate the BUS RESET by issuing a protocol specific HARD RESET to each target device (e.g. SATA COMRESET or SAS PHY HARD RESET).

NOTE 5 - If more than one device is present on a PATA bus, issuing a soft reset causes both devices to be reset.

6.3.7 QUERY TASK

QUERY TASK shall cause the SATL to search for the specified task and, if found, respond with FUNCTION SUCCEEDED. If the specified task is not found the SATL shall respond with FUNCTION COMPLETE.

6.4 SCSI Control Byte

6.4.1 CONTROL byte overview

Table 5 describes SATL handling of the CDB CONTROL byte. See SAM-3 for CONTROL byte details.

Table 5 — Control byte fields

Field	Description or reference
Vendor specific	The SATL may use this field for vendor-specific purposes.
NACA	If set to one, the SATL shall terminate the command with CHECK CONDITION status with the sense key set to ILLEGAL REQUEST and the additional sense code set to INVALID FIELD IN CDB.
LINK	If set to one, the SATL shall return a CHECK CONDITION with the sense key set to ILLEGAL REQUEST and additional sense code set to INVALID FIELD IN CDB.

register, then set the bit to zero)"
This is what a PATA device would do. SATA does it differently.
RESOLUTION: see 06-179rX: SAT - Fix Task Management Functions

Status
r/sheffi Completed 6/24/2006 9:03:42 AM

Sequence number: 13
Author: SIERLGC[BMartin]
Subject: Note
Date: 3/31/2006 5:29:15 PM

 Page 22, 6.3.6 Paragraph 1

If a device is in the middle of IO, generating a soft reset may be problematic - make it possible to issue soft or hard reset. This is also consistent with Note 4.

RESOLUTION: see 06-179rX: SAT - Fix Task Management Functions (allows software or hard reset to be used)

Status
r/sheffi Completed 6/24/2006 9:05:38 AM

Sequence number: 14
Author: HPQ[RElliott]
Subject: Highlight
Date: 6/3/2006 9:01:40 AM

 6.3.6

"including any behaviors related to saveable mode parameters."

The mode page discussions say that SAT does not support saveable mode parameters.

RESOLUTION: see 06-179rX: SAT - Fix Task Management Functions (Draft being modified so as not to prohibit saving mode parameters)

Status
r/sheffi Completed 6/24/2006 9:06:35 AM

Sequence number: 15
Author: MXO[MEvans]
Subject: Highlight
Date: 6/3/2006 9:05:31 AM

 Note 4: there is no such thing as a "BUS RESET" in SCSI. Possible what is meant here is something like: "An application client may initiate a transport specific SCSI reset event. A SATL may translate the SCSI reset event by issuing a protocol specific hardware reset to each device (e.g. SATA COMRESET or SAS PHY HARD RESET).

RESOLUTION: see 06-179rX: SAT - Fix Task Management Functions (rewrite specifies ATA hardware reset or ATA software reset, and provides a separate subclause to discuss the obsolete TARGET RESET (a.k.a., BUS DEVICE RESET)).

Status
r/sheffi Completed 6/24/2006 9:41:24 AM

Sequence number: 16
Author: DELL[KMarks]
Subject: Note
Date: 6/3/2006 9:06:02 AM

 Not sure what NOTE 4 has to do with Logical Unit Reset? And the inclusion of the SAS PHY HARD RESET in the e.g.?

RESOLUTION: see 06-179rX: SAT - Fix Task Management Functions (addressed in a new subclause)

Status
r/sheffi Completed 6/24/2006 9:41:51 AM

Sequence number: 17
Author: HPQ[RElliott]
Subject: Highlight
Date: 3/31/2006 5:33:33 PM

 6.3.6
note 4

HARD RESET s/b hard reset

RESOLUTION: see 06-179rX: SAT - Fix Task Management Functions (informative subclause discusses obsolete TARGET RESET).

Comments from page 42 continued on next page

If the SATL does not provide multiple initiators access to the emulated SCSI device, the SATL shall process the service request as follows:

- 1) If commands have not been issued to the ATA device for the processing of the specified SCSI task tag the SATL shall delete all tasks in the task set from the SATL internal context and respond to the CLEAR TASK SET request with FUNCTION COMPLETE.
- 2) If the only command(s) being processed in the ATA device are associated to the SCSI tasks in the task set, then the SATL shall abort the SATA command(s) and respond with FUNCTION COMPLETE.
- 3) The SATL shall abort outstanding ATA command(s) and respond to the CLEAR TASK SET request with FUNCTION COMPLETE.

If the SATL provides multiple initiators access to the emulated SCSI device, the SATL shall process the service request as follows:

- 1) If commands have not been issued to the ATA device for the processing of the specified SCSI task tag the SATL shall delete the specified task from the SATL internal context and respond to the CLEAR TASK SET request with FUNCTION COMPLETE.
- 2) For each initiator port associated with an I_T_Nexus that had a task aborted, the SATL shall complete at least one command for that I_T_Nexus with CHECK CONDITION status with the sense key set to UNIT ATTENTION and additional sense code set to COMMANDS CLEARED BY ANOTHER INITIATOR.

6.3.6 LOGICAL UNIT RESET

LOGICAL UNIT RESET shall cause the SATL to issue a software reset (i.e., set the SRST bit to one in the Device Control register, then set the bit to zero) to the ATA device representing the specified logical unit. Any persistent behaviors shall be reestablished by the SATL afterwards, including any behaviors related to saveable mode parameters.

NOTE 4 - BUS RESET is commonly used by SCSI application layers to hard reset each device mapped to a target ID on a given SCSI bus. The SATL may translate the BUS RESET by issuing a protocol specific HARD RESET to each target device (e.g. SATA COMRESET or SAS PHY HARD RESET).

NOTE 5 - If more than one device is present on a PATA bus, issuing a ¹⁸ reset causes both devices to be reset.

6.3.7 QUERY TASK

¹⁹²⁰ QUERY TASK shall cause the SATL to search for the specified task and, if found, respond with FUNCTION SUCCEEDED. If the specified task is not found the SATL shall respond with FUNCTION COMPLETE.

6.4 SCSI Control Byte

6.4.1 CONTROL byte overview

Table 5 describes SATL handling of the CDB CONTROL byte. See SAM-3 for CONTROL byte details.

Table 5 — Control byte fields

Field	Description ²¹ reference
Vendor specific	The SATL may use this field for vendor-specific purposes.
NACA	If set to one, the SATL shall terminate the command with CHECK CONDITION status with the sense key set to ILLEGAL REQUEST and the additional sense code set to INVALID FIELD IN CDB.
LINK	If set to one, the SATL shall return a CHECK CONDITION with the sense key set to ILLEGAL REQUEST and additional sense code set to INVALID FIELD IN CDB.

Status
rsheffi Completed 7/24/2006 11:22:28 AM

Sequence number: 18
Author: MXO[MEvans]
Subject: Highlight
Date: 6/3/2006 9:06:41 AM

 Note 5: change "soft reset" to "software reset".
RESOLUTION: see 06-179rX: SAT - Fix Task Management Functions (ATA hardware reset or ATA software reset)

Status
rsheffi Completed 6/24/2006 1:24:49 PM

Sequence number: 19
Author: HPQ[RElliott]
Subject: Note
Date: 3/31/2006 5:34:35 PM

 6.3.7

QUERY TASK only follows these rules if the SCSI transport protocol on the front side of the SATL supports QUERY TASK (since it is not required by SAM-3). This transport protocol may just be a software interface inside an HBA and its driver stack.

RESOLUTION: see 06-179rX: SAT - Fix Task Management Functions

Status
rsheffi Completed 6/24/2006 1:37:08 PM

Sequence number: 20
Author: DELL[KMarks]
Subject: Highlight
Date: 3/31/2006 5:35:26 PM

 **6.3.7 QUERY TASK**
1st Paragraph, 1st Sentence
change

"QUERY TASK shall cause the SATL to search for the specified task and, if found, respond with FUNCTION SUCCEEDED. If the specified task is not found the SATL shall respond with FUNCTION COMPLETE."

to

"A QUERY TASK task management function request shall cause the SATL to respond with QUERY TASK task management function response of FUNCTION SUCCEEDED if the specified task is present in the task set and FUNCTION COMPLETE if the task is not present in the task set.."

Does a note need to be added that not all SCSI transport require/support the QUERY TASK TMF?

RESOLUTION: see 06-179rX: SAT - Fix Task Management Functions (clarifies that support for QUERY TASK is optional)

Status
rsheffi Completed 6/24/2006 1:38:09 PM

Sequence number: 21
Author: ENDL[RWeber]
Date: 2/14/2006 8:05:25 PM

 Table 5
Since there are no references in the second column, remove 'or reference' from the column heading.

Status
rsheffi Completed 6/3/2006 9:08:29 AM

Sequence number: 22
Author: ENDL[RWeber]
Date: 2/14/2006 8:04:36 PM

 Table 5
The description for the LINK bit should be identical to the description for the NACA bit.

Status
rsheffi Completed 6/3/2006 9:09:49 AM

6.5 ~~SAM-3~~ I_T nexus loss

The SATL may detect an I_T nexus loss (see SAM-3). If the SATL detects an I_T nexus loss (e.g., in a SAS domain the expander device with an STP/SATA bridge transmits a BROADCAST (CHANGE) and the subsequent REPORT PHY SATA response from the affected phy contains an STP I_T NEXUS LOSS OCCURRED bit set to one), the SATL:

- 1) shall issue an ATA hard reset (see 3.1.9) to the affected ATA device;
- 2) shall terminate processing of any commands to the affected ATA device; and
- 3) should establish a unit attention with the additional sense code set to I_T NEXUS LOSS OCCURRED.

Sequence number: 1
Author: DELL[KMarks]
Subject: Cross-Out
Date: 2/16/2006 1:22:50 PM
T from 6.4 subclause title.

T remove
"SAM-3"

Status
rlsheffi Completed 6/3/2006 9:10:27 AM

Sequence number: 2
Author: DELL[KMarks]
Subject: Highlight
Date: 6/5/2006 8:48:22 AM

T 6.5 I_T nexus loss
1st paragraph, 1st Sentence

change

"The SATL may detect an I_T nexus loss (see SAM-3). If the SATL detects an I_T nexus loss (e.g., in a SAS domain the expander device with an STP/SATA bridge transmits a BROADCAST (CHANGE) and the subsequent REPORT PHY SATA response from the affected phy contains an STP I_T NEXUS LOSS OCCURRED bit set to one), the SATL:

- 1) shall issue an ATA hard reset (see 3.1.9) to the affected ATA device;
- 2) shall terminate processing of any commands to the affected ATA device; and
- 3) should establish a unit attention with the additional sense code set to I_T NEXUS LOSS OCCURRED."

to

"The SATL may detect an I_T nexus loss event (see SAM-3). If the SATL detects an I_T nexus loss the SATL may handle the I_T nexus loss differently depending on whether the SATL provides multiple initiators access to the emulated SCSI logical unit.

If the SATL does not provide multiple initiators access to the emulated SCSI logical unit, the SATL shall handle the I_T nexus loss as follows:

- 1) abort any outstanding ATA command(s);
- 2) delete all tasks in the task set from the SATL internal context; and
- 3) establish a unit attention with the additional sense code set to I_T NEXUS LOSS OCCURRED.

If the SATL does provide multiple initiators access to the emulated SCSI logical unit, the SATL shall handle the I_T nexus loss as follows:

- 1) allow any outstanding ATA command(s) to complete for the I_T nexus for which the I_T nexus loss event occurred;
- 2) delete all tasks in the task set from the SATL internal context for tasks associated with the I_T nexus that the I_T nexus loss event occurred; and
- 3) establish a unit attention with the additional sense code set to I_T NEXUS LOSS OCCURRED for the SCSI initiator port associated with the I_T nexus."

The e.g. given in the original text is not an I_T nexus loss in terms of what this section is trying to define. The e.g. I_T nexus loss is between the SATL and the ATA device, and not between the SATL and SCSI initiator port.

Also why is the UA a should and not shall? SAM-3 says a shall.

RESOLUTION (see 06-270): Delete the e.g., (accept Kevin's rewording).

Add a subclause on ATA nexus loss handling.

Hard reset and power loss should also be covered.

When the SATL sees an ATA nexus loss (see ATA8-ACM), it needs to CHECK CONDITION all the commands with a sense key indicating a HW error with an additional sense code of LOGICAL UNIT COMMUNICATION FAILURE for each command aborted. Indicate the device is no longer present with 001b in the PERIPHERAL QUALIFIER field in standard INQUIRY data.

NOTE: SAM-3 and SPC-3 define how the SATL processes subsequent commands when the logical unit is no longer

6.5 SAM-3 I_T nexus loss

The SATL may detect an I_T nexus loss (see SAM-3). If the SATL detects an I_T nexus loss (e.g., in a SAS domain the expander device with an STP/SATA bridge transmits a BROADCAST (CHANGE) and the subsequent REPORT PHY SATA response from the affected phy contains an STP I_T NEXUS LOSS OCCURRED bit set to one), the SATL:

- 1) shall issue an ATA hard reset (see 3.1.9) to the affected ATA device;
- 2) shall terminate processing of any commands to the affected ATA device; and
- 3) should establish a bit attention with the additional sense code set to I_T NEXUS LOSS OCCURRED.

available (i.e., incorrect logical unit selection).

Add a subclause in clause-5 to define ATA hardware reset, ATA software reset, and returning from ATA nexus loss. Before using the ATA device to process SCSI commands following an ATA hardware reset, an ATA software reset, or reestablishing an ATA nexus following an ATA nexus loss, the SATL shall ensure the ATA software settings (e.g., ATA SET FEATURES command) are the same as they were before the ATA hardware reset, ATA software reset, or ATA nexus loss.

Status
rlsheffi Completed 6/24/2006 8:23:30 AM

Sequence number: 3
Author: HPQ[RElliott]
Subject: Highlight
Date: 6/5/2006 8:48:52 AM

T6.5

unit attention for whom?
RESOLUTION: See 06-270

Status
rlsheffi Completed 6/24/2006 8:36:08 AM

7 Summary of SCSI / ATA command mappings

7.1 Translated and emulated commands

In the event of a discrepancy between the contents of ¹this section and the description of individual commands, description of individual commands shall apply.

Clause 7, clause 8, and clause 9 describe the SCSI to ATA command mapping. Translation for ATAPI devices is described in clause 13.

⁵ ⁴ ~~Unless otherwise noted, the IMMED bit (immediate return) shall be ignored. For the FORMAT UNIT command, this bit shall be supported.~~

All ATA commands with the exception of ATA queued commands (see 3.1.14) shall be single threaded per device. The SATL shall queue received SCSI commands as necessary to enforce this.

Table 6 lists the SCSI / ATA command mappings defined in this standard. A SATL may implement commands defined in SPC-3 and SBC-2, but not listed in table 6. Translation of commands not listed in table 6 is vendor-specific.

Table 6 — Summary of SCSI / ATA Command Mapping (part 1 of 2)

SCSI command	ATA commands	Reference
ATA PASS-THROUGH (12)	Any	12.2.2
ATA PASS-THROUGH (16)		12.2.3
FORMAT UNIT	READ VERIFY SECTORS, READ VERIFY SECTORS EXT, WRITE SECTORS, WRITE SECTORS EXT	9.2
INQUIRY	IDENTIFY DEVICE	8.1
LOG SENSE	log page dependent (see 10.2)	8.2
MODE SELECT (6)	mode page dependent (see 10.1)	8.3
MODE SELECT (10)		8.4
MODE SENSE (6)		8.5
MODE SENSE (10)		8.6
READ (6)	See 9.1.	9.3
READ (10)		9.5
READ (12)		9.6
READ (16)		9.7
READ BUFFER	READ BUFFER	8.7
READ CAPACITY (10)	IDENTIFY DEVICE	9.8
READ CAPACITY (16)		9.9
READ MEDIA SERIAL NUMBER	IDENTIFY DEVICE	8.8
REASSIGN BLOCKS	READ VERIFY SECTOR(S), READ VERIFY SECTOR(S) EXT, WRITE DMA, WRITE DMA EXT, WRITE DMA FUA EXT, WRITE DMA QUEUED, WRITE DMA QUEUED EXT, WRITE DMA QUEUED FUA EXT, and WRITE FPDMA QUEUED	9.10
REPORT LUNS	n/a	SPC-3
REQUEST SENSE	SMART RETURN STATUS	8.9
SEND DIAGNOSTIC	EXECUTE DEVICE DIAGNOSTIC	8.10
START STOP UNIT	FLUSH CACHE, FLUSH CACHE EXT, STANDBY, READ VERIFY SECTOR(S), and MEDIA EJECT	9.11

Sequence number: 1
Author: IBM[GPenokie]
Subject: Comment on Text
Date: 2/15/2006 4:35:55 PM

T 1st paragraph
This << this section and >> should be << this clause and >>

Status
risheffi Completed 6/5/2006 9:05:53 AM

Sequence number: 2
Author: HPQ[RElliott]
Subject: Cross-Out
Date: 6/5/2006 9:07:54 AM

T 7.1

"Unless otherwise noted, the IMMED bit (immediate return) shall be ignored. For the FORMAT UNIT command, this bit shall be supported."

Every command with an IMMED bit mentioned by this standard does describe rules for it. This default rule is unnecessary (and generally wrong).

RESOLUTION: Remove the text, "Unless otherwise noted, the IMMED bit (immediate return) shall be ignored. For the FORMAT UNIT command, this bit shall be supported."

Status
risheffi Completed 6/5/2006 9:08:31 AM

Sequence number: 3
Author: DELL[KMarks]
Subject: Highlight
Date: 4/3/2006 11:53:44 AM

T 7.1 Translated and emulated commands
3rd Paragraph, 1st sentence

change

"Unless otherwise noted, the IMMED bit (immediate return) shall be ignored."

to

"Unless otherwise noted, the SATL shall ignore the IMMED bit (immediate return)"

RESOLUTION: Delete the sentence about the IMMED bit - it's covered elsewhere in context (see HPQ comment).

Status
risheffi Completed 6/5/2006 9:08:41 AM

Sequence number: 4
Author: MXO[MEvans]
Subject: Highlight
Date: 4/3/2006 11:54:02 AM

T 7.1 Translated and emulated commands, third paragraph: change to, "The IMMED bit (immediate return) shall be ignored unless otherwise noted (e.g., this bit shall be supported for the FORMAT UNIT command)."

RESOLUTION: Delete the sentence about the IMMED bit - it's covered elsewhere in context (see HPQ comment).

Status
risheffi Completed 6/5/2006 9:09:05 AM

Sequence number: 5
Author: SIERLGC[BMartin]
Subject: Note
Date: 4/3/2006 11:54:47 AM

T Page 24, 7.1 third paragraph

Why is the FORMAT UNIT command specifically called out here? There are other commands where it is supported. Remove this sentence.

RESOLUTION: Delete the sentence about the IMMED bit - it's covered elsewhere in context (see HPQ comment).

7 Summary of SCSI / ATA command mappings

7.1 Translated and emulated commands

In the event of a discrepancy between the contents of **this section and** the description of individual commands, description of individual commands shall apply.

Clause 7, clause 8, and clause 9 describe the SCSI to ATA command mapping. Translation for ATAPI devices is described in clause 13.

Unless otherwise noted, the IMMED bit (immediate return) shall be ignored. For the FORMAT UNIT command, this bit shall be supported.

6 **All ATA commands with the exception of ATA queued commands (see 3.1.14) shall be single threaded per device.** The SATL shall queue received SCSI commands as necessary to enforce this.

Table 6 lists the SCSI / ATA command mappings defined in this standard. A SATL may implement commands defined in SPC-3 and SBC-2, but not listed in table 6. Translation of commands not listed in table 6 is vendor-specific.

Table 6 — Summary of SCSI / ATA Command Mapping (part 1 of 2)

SCSI command	ATA commands	Reference
ATA PASS-THROUGH (12)	Any	12.2.2
ATA PASS-THROUGH (16)		12.2.3
FORMAT UNIT	READ VERIFY SECTORS, READ VERIFY SECTORS EXT, WRITE SECTORS, WRITE SECTORS EXT	9.2
INQUIRY	IDENTIFY DEVICE	8.1
LOG SENSE	log page dependent (see 10.2)	8.2
MODE SELECT (6)	mode page dependent (see 10.1)	8.3
MODE SELECT (10)		8.4
MODE SENSE (6)		8.5
MODE SENSE (10)		8.6
READ (6)	See 9.1.	9.3
READ (10)		9.5
READ (12)		9.6
READ (16)		9.7
READ BUFFER	READ BUFFER	8.7
READ CAPACITY (10)	IDENTIFY DEVICE	9.8
READ CAPACITY (16)		9.9
READ MEDIA SERIAL NUMBER	IDENTIFY DEVICE	8.8
REASSIGN BLOCKS	READ VERIFY SECTOR(S), READ VERIFY SECTOR(S) EXT, WRITE DMA, WRITE DMA EXT, WRITE DMA FUA EXT, WRITE DMA QUEUED, WRITE DMA QUEUED EXT, WRITE DMA QUEUED FUA EXT, and WRITE FPDMA QUEUED	9.10
REPORT LUNS	n/a	SPC-3
REQUEST SENSE	SMART RETURN STATUS	8.9
SEND DIAGNOSTIC	EXECUTE DEVICE DIAGNOSTIC	8.10
START STOP UNIT	FLUSH CACHE, FLUSH CACHE EXT, STANDBY, READ VERIFY SECTOR(S), and MEDIA EJECT	9.11

Status
risheffi Completed 6/5/2006 9:09:16 AM

Sequence number: 6
Author: DELL[KMarks]
Subject: Highlight
Date: 2/16/2006 1:28:01 PM

T 7.1 Translated and emulated commands
4th Paragraph, 1st Sentence

change

"All ATA commands with the exception of ATA queued commands (see 3.1.14) shall be single threaded per device."

to

"The SATL shall not issue more than one ATA command to the ATA device representing the logical unit with the exception of ATA queued commands (see 3.1.14)."

Status
risheffi Completed 6/5/2006 9:11:34 AM

Table 6 — Summary of SCSI / ATA Command Mapping (part 2 of 2)

SCSI command	ATA commands	Reference
SYNCHRONIZE CACHE (10)	FLUSH CACHE or	9.12
SYNCHRONIZE CACHE (16)	FLUSH CACHE EXT	9.13
TEST UNIT READY	CHECK POWER MODE	8.11
VERIFY (10)	See 9.1.	9.14
VERIFY (12)		9.15
VERIFY (16)		9.16
WRITE (6)	See 9.1.	9.18
WRITE (10)		9.19
WRITE (12)		9.20
WRITE (16)		9.21
WRITE AND VERIFY (10)	See 9.1.	9.23
WRITE AND VERIFY (12)		9.24
WRITE AND VERIFY (16)		9.25
WRITE BUFFER	WRITE BUFFER or DOWNLOAD MICROCODE	8.12
WRITE SAME (10)	See 9.1.	9.26
WRITE SAME (16)		9.27

This page contains no comments

8 SCSI Primary Commands (SPC) ¹ Mapping

8.1 INQUIRY command

2 1.1 INQUIRY command overview

The ~~3~~ SCSI INQUIRY command requests general information about a target ~~4~~ component LUN. The INQUIRY command and selected vital product data pages shall be emulated using information from the ATA IDENTIFY DEVICE command, and other information ~~5~~ described in subsequent subclauses. Table 7 describes the emulation of fields in the ~~6~~ SCSI INQUIRY CDB.

Table 7 — INQUIRY command CDB fields

Field	Description or reference
OPERATION CODE	The SATL shall issue an IDENTIFY DEVICE command (ECh) to the attached ATA device.
EVPD	The SATL shall implement this field as defined in SPC-3. (see 10.3)
PAGE CODE ^a	The SATL: a) shall support the Supported VPD pages (00h); b) may support the Unit Serial Number VPD page (80h); c) shall support the Device Identification VPD page (83h); and d) shall support the ATA Information VPD page (89h).
ALLOCATION LENGTH	The SATL shall implement this field as defined in SPC-3.
CONTROL	6.4
^a VPD page translations are defined in subclause 10.3	



The logical unit number identified with the I_T_L nexus should be set to zero. If the logical unit number of the request is not zero, the SATL may terminate the command with CHECK CONDITION status with the sense key set to ILLEGAL REQUEST and the additional sense code set to LOGICAL UNIT NOT SUPPORTED.

8.1.2 Standard INQUIRY data

Table 8 describes the standard INQUIRY data fields supported by the SATL.

Sequence number: 1
Author: HPQ[RElliott]
Subject: Highlight
Date: 1/19/2006 9:28:27 AM

T⁸

Mapping s/b mapping

Status
risheffi Completed 6/5/2006 9:27:23 AM

Sequence number: 2
Author: IBM[GPenokie]
Subject: Underline
Date: 2/16/2006 1:40:52 PM
T^{8.1.1} INQUIRY command overview

Status
risheffi Cancelled 4/4/2006 9:56:06 AM

Sequence number: 3
Author: DELL[KMarks]
Subject: Cross-Out
Date: 2/16/2006 1:28:46 PM
T^{8.1.1}

remove
"SCSI" from 1st Sentence

Status
risheffi Completed 6/5/2006 9:27:46 AM

Sequence number: 4
Author: DELL[KMarks]
Subject: Highlight
Date: 2/1/2006 3:46:14 PM
T^{8.1.1} INQUIRY command overview
1st paragraph, 1st Sentence

"... or component LUN."
to
".. and component logical unit."

Status
risheffi Completed 6/5/2006 9:28:27 AM

Sequence number: 5
Author: IBM[GPenokie]
Subject: Comment on Text
Date: 4/4/2006 10:15:03 AM
T^{8.1.1} 1st paragraph

This <<as described in subsequent subclauses. >> is not much better than saying below. This reference must be more specific as to which subsequent subclauses are relevant.

RESOLUTION: change "as described in subsequent subclauses" to (see 8.1.2)"

Status
risheffi Completed 6/5/2006 9:29:38 AM

Sequence number: 6
Author: DELL[KMarks]
Subject: Cross-Out
Date: 2/16/2006 1:28:58 PM
T^{8.1.1}

remove
"SCSI" from 2nd Sentence

Status
risheffi Completed 6/5/2006 9:29:50 AM

8 SCSI Primary Commands (SPC) Mapping

8.1 INQUIRY command

8.1.1 INQUIRY command overview

The ~~SCSI~~ INQUIRY command requests general information about a target or component LUN. The INQUIRY command and selected vital product data pages shall be emulated using information from the ATA IDENTIFY DEVICE command, and other information as described in subsequent subclauses. Table 7 describes the emulation of fields in the ~~SCSI~~ INQUIRY CDB.

Table 7 — INQUIRY command CDB fields

Field	Description or reference
OPERATION CODE	The SATL shall issue ⁸ an IDENTIFY DEVICE command (7Eh) to the attached ATA device.
EVPD	The SATL shall implement this field as defined in SPC-3 ⁹ (see 10.3)
PAGE CODE ^a	The SATL: <ul style="list-style-type: none"> a) shall support the Supported VPD pages (00h); b) may support the Unit Serial Number VPD page (80h); c) shall support the Device Identification VPD page (83h); and d) shall support the ATA Information VPD page (89h).
ALLOCATION LENGTH	The SATL shall implement this field as defined in SPC-3.
CONTROL	¹⁰
^a VPD page translations are ¹¹ defined in subclause 10.3	

¹² The logical unit number identified with the I_T_L nexus should be set to zero. If the logical unit number of the request is not zero, the SATL may terminate the command with CHECK CONDITION status with the sense key set to ILLEGAL REQUEST and the additional sense code set to LOGICAL UNIT NOT SUPPORTED.

8.1.2 Standard INQUIRY data

Table 8 describes the standard INQUIRY data fields supported by the SATL.

Sequence number: 7
Author: DELL[KMarks]
Subject: Cross-Out
Date: 2/16/2006 1:29:57 PM

T Table 7 — INQUIRY command CDB fields
Row: OPERATION CODE
remove "(ECh)" and "attached"

Status
risheffi Completed 6/5/2006 9:30:21 AM

Sequence number: 8
Author: DELL[KMarks]
Subject: Highlight
Date: 2/1/2006 11:01:33 PM

T Table 7 — INQUIRY command CDB fields
Row: OPERATION CODE

change
"...an IDENTIFY DEVICE command..."
to
"...an ATA IDENTIFY DEVICE command..."

Status
risheffi Completed 6/5/2006 9:30:33 AM

Sequence number: 9
Author: INTC[RSheffield]
Subject: Highlight
Date: 4/24/2006 11:04:09 AM

T 8.1.1 INQUIRY command overview
Table 7, EVPD row
"(see 10.3)" s/b "(see 10.3)." (move period to the end)

Status
risheffi Completed 6/5/2006 9:31:13 AM

Sequence number: 10
Author: MXO (MEvans)
Subject: Highlight
Date: 4/4/2006 11:30:08 AM

T Table 7: change "6.4" to "See 6.4".
REASON: Agree with being consistent. Earlier decision was in table columns where the only entry is a paragraph reference to include only the paragraph number and omit the "See".

Status
risheffi Rejected 4/4/2006 11:26:04 AM

Sequence number: 11
Author: IBM[GPenokie]
Subject: Comment on Text
Date: 2/15/2006 4:41:28 PM

T table 7 - footnote a
This << defined in subclause 10.3 >> should be << defined in 10.3 >>

Status
risheffi Completed 6/5/2006 9:32:03 AM

Sequence number: 12
Author: HPQ[RElliott]
Subject: Note
Date: 2/1/2006 10:16:42 AM

T 8.1.1
"The logical unit ... should be set to 0" paragraph
SAT shouldn't care about which logical unit number the SATL is part of. Delete this paragraph.

Status
risheffi Completed 6/5/2006 9:32:58 AM

Comments from page 46 continued on next page

8 SCSI Primary Commands (SPC) Mapping

8.1 INQUIRY command

8.1.1 INQUIRY command overview

The ~~SCSI~~ INQUIRY command requests general information about a target or component LUN. The INQUIRY command and selected vital product data pages shall be emulated using information from the ATA IDENTIFY DEVICE command, and other information as described in subsequent subclauses. Table 7 describes the emulation of fields in the ~~SCSI~~ INQUIRY CDB.

Table 7 — INQUIRY command CDB fields

Field	Description or reference
OPERATION CODE	The SATL shall issue an IDENTIFY DEVICE command (ECh) to the attached ATA device.
EVPD	The SATL shall implement this field as defined in SPC-3. (see 10.3)
PAGE CODE ^a	The SATL: <ul style="list-style-type: none"> a) shall support the Supported VPD pages (00h); b) may support the Unit Serial Number VPD page (80h); c) shall support the Device Identification VPD page (83h); and d) shall support the ATA Information VPD page (89h).
ALLOCATION LENGTH	The SATL shall implement this field as defined in SPC-3.
CONTROL	6.4
^a VPD page translations are defined in subclause 10.3	

The logical unit number identified with the I_T_L nexus should be set to zero. If the logical unit number of the request is not zero, the [13] may terminate the command with CHECK CONDITION status with the sense key set to ILLEGAL REQUEST and the additional sense code set to LOGICAL UNIT NOT SUPPORTED.

8.1.2 Standard INQUIRY data

Table 8 describes the standard INQUIRY data fields supported by the SATL.

Sequence number: 13
Author: DELL[KMarks]
Subject: Note
Date: 4/4/2006 11:33:13 AM



8.1.1 INQUIRY command overview
1st Paragraph after Table 7.

This paragraph does not seem correct. The SATL should return the INQUIRY data, with the PF=011b and PDT=1fh. I agree this is the response to other command types to an incorrect LU, expect request sense and report luns.

Additionally it contradicts what is in footnote a of Table 8.

RESOLUTION: Delete the paragraph (see HPQ comment).

Status

risheffi Completed

6/5/2006 9:32:58 AM

Table 8 — Standard INQUIRY data fields (part 1 of 3)

Field	Description or reference
PERIPHERAL QUALIFIER	¹ This field shall be set to 000b to indicate that the peripheral device is currently connected to this logical unit. ^a
PERIPHERAL DEVICE TYPE	² This field shall be set to 00h to indicate that the peripheral device is a direct access block device. ^a
RMB	The SATL shall set this bit to the value of bit 7 of ³ the GENERAL CONFIGURATION field of the IDENTIFY DEVICE data retrieved from the attached ATA device.
VERSION	The VERSION field indicates the version of SPC to which the SATL complies (see SPC-3) (e.g., 05h for SPC-3).
NORMACA	The SATL shall set this bit to zero to indicate the SATL does not support the NACA bit in the CONTROL byte (see 6.4).
HiSUP	Unspecified (see 3.4.3)
RESPONSE DATA FORMAT	The SATL shall set this field to 2h.
ADDITIONAL LENGTH	The SATL shall set this field to the length of the INQUIRY data that follows.
SCCS	Unspecified (see 3.4.3)
ACC	Unspecified (see 3.4.3)
TPGS	Unspecified (see 3.4.3)
3PC	Unspecified (see 3.4.3)
PROTECT	⁴ The SATL shall set this bit to zero to indicate that the peripheral device does not support protection information.
BQUE	Unspecified (see 3.4.3)
ENCSERV	Unspecified (see 3.4.3)
MULTIP	Unspecified (see 3.4.3)
MCHNGR	The SATL shall set this bit to zero to indicate the peripheral device is not attached to a medium transport element.
ADDR16	Unspecified (see 3.4.3)
WBUS16	Unspecified (see 3.4.3)
SYNC	Unspecified (see 3.4.3)
<p>^a If the INQUIRY command is issued ⁵an unsupported logical unit the SATL shall set the PERIPHERAL QUALIFIER field to 011b and shall set the PERIPHERAL DEVICE TYPE field to 1Fh.</p> <p>^b The full ATA IDENTIFY DEVICE ⁶data MODEL NUMBER field contents and the REVISION NUMBER field contents are retrieved with the ATA Information VPD page (see 10.3.5).</p> <p>^c There can only be 6 total version descriptors. Normally e) and f) are not together so they fit. A FC to SAS bridge might have both, though.</p> <p>^d The encoding used by T10 for INQUIRY version descriptors (see SPC-3) and T13 for IDENTIFY DEVICE major and minor version numbers (see ATA/ATAPI-7) differ, and the two standards organizations may not define values for the same revisions.</p>	

Sequence number: 1
Author: MXO[MEvans]
Subject: Highlight
Date: 2/9/2006 7:48:52 AM

T Table 8: change, "This field shall be set..." to "The SATL shall set this field..."

Status
rsheffi Completed 6/5/2006 9:34:02 AM

Sequence number: 2
Author: MXO[MEvans]
Subject: Highlight
Date: 2/9/2006 7:49:01 AM

T Table 8: change, "This field shall be set..." to "The SATL shall set this field..."

Status
rsheffi Completed 6/5/2006 9:34:27 AM

Sequence number: 3
Author: DELL[KMarks]
Subject: Highlight
Date: 2/1/2006 10:03:53 PM

T Table 8 — Standard INQUIRY data fields (part 1 of 3)
Row: RMB

change
"...the GENERAL CONFIGURATION field..."
to
"...the general configuration word..."

field is ok, but the word is defined with bit positions defining different functions, so I think word is better.

Status
rsheffi Completed 6/5/2006 9:35:37 AM

Sequence number: 4
Author: SIERLGC[BMartin]
Subject: Highlight
Date: 2/23/2006 7:27:07 PM

T Page 27, Table 8
There is no reason that a SATL cannot support protection data. This should be changed to "Unspecified (see 3.4.3)"

Status
rsheffi Completed 6/5/2006 9:36:27 AM

Sequence number: 5
Author: DELL[KMarks]
Subject: Highlight
Date: 2/1/2006 10:50:50 PM

T Table 8 — Standard INQUIRY data fields (part 1 of 3)
Footnote a - in all 3 parts

change
"...to an unsupported logical unit..."
to
"...to an incorrect logical unit..."

Status
rsheffi Completed 6/5/2006 9:36:55 AM

Sequence number: 6
Author: DELL[KMarks]
Subject: Highlight
Date: 4/10/2006 1:24:48 PM

T Table 8 — Standard INQUIRY data fields (part 1 of 3)
Footnote b - in all 3 parts

change

Table 8 — Standard INQUIRY data fields (part 1 of 3)

Field	Description or reference
PERIPHERAL QUALIFIER	This field shall be set to 000b to indicate that the peripheral device is currently connected to this logical unit. ^a
PERIPHERAL DEVICE TYPE	This field shall be set to 00h to indicate that the peripheral device is a direct access block device. ^a
RMB	The SATL shall set this bit to the value of bit 7 of the GENERAL CONFIGURATION field of the IDENTIFY DEVICE data retrieved from the attached ATA device.
VERSION	The VERSION field indicates the version of SPC to which the SATL complies (see SPC-3) (e.g., 05h for SPC-3).
NORMACA	The SATL shall set this bit to zero to indicate the SATL does not support the NACA bit in the CONTROL byte (see 6.4).
HiSUP	Unspecified (see 3.4.3)
RESPONSE DATA FORMAT	The SATL shall set this field to 2h.
ADDITIONAL LENGTH	The SATL shall set this field to the length of the INQUIRY data that follows.
SCCS	Unspecified (see 3.4.3)
ACC	Unspecified (see 3.4.3)
TPGS	Unspecified (see 3.4.3)
3PC	Unspecified (see 3.4.3)
PROTECT	The SATL shall set this bit to zero to indicate that the peripheral device does not support protection information.
BQUE	Unspecified (see 3.4.3)
ENCSERV	Unspecified (see 3.4.3)
MULTIP	Unspecified (see 3.4.3)
MCHNGR	The SATL shall set this bit to zero to indicate the peripheral device is not attached to a medium transport element.
ADDR16	Unspecified (see 3.4.3)
WBUS16	Unspecified (see 3.4.3)
SYNC	Unspecified (see 3.4.3)
<p>^a If the INQUIRY command is issued to an unsupported logical unit the SATL shall set the PERIPHERAL QUALIFIER field to 011b and shall set the PERIPHERAL DEVICE TYPE field to 1Fh.</p> <p>^b The full ATA IDENTIFY DEVICE data MODEL NUMBER field contents and the REVISION NUMBER field contents are retrieved with the ATA Information VPD page (see 10.3.5).</p> <p>^c There can only be 6 total version descriptors. Normally e) and f) are not together so they fit. A FC to SAS bridge might have both, though.</p> <p>^d The encoding used by T10 for INQUIRY version descriptors (see SPC-3) and T13 for IDENTIFY DEVICE major and minor version numbers (see ATA/ATAPI-7) differ, and the two standards organizations may not define values for the same revisions.</p>	

"data MODEL NUMBER field contents and the REVISION NUMBER field"

to

"data Model number field contents and the Firmware revision field"

I assume the REVISION NUMBER was supposed to be the Firmware Revision

RESOLUTION: Move the table footnote link (b) to the left column and apply it to both PRODUCT IDENTIFICATION and PRODUCT REVISION LEVEL, and change "REVISION NUMBER field" to "Firmware Revision field" in table footnote b.

Status
rlsheffi Completed 6/5/2006 10:12:52 AM

Sequence number: 7
Author: SIERLGC[BMartin]
Subject: Highlight
Date: 4/9/2006 12:56:49 PM

T Page 27, Table 8 footnote c
What does "Normally e) and f) are not together so they fit." mean?

RESOLUTION: Delete table footnote c and change the Field name to "VERSION DESCRIPTOR 1 through VERSION DESCRIPTOR 8".

REASON: The original intent may have been to try to show that the information the SATL "shall" include can fit into 6 descriptors (leaving two more available, since there are 8 in total). But SPC-3 adequately describes the options for including or not including descriptors, and the way e and f are worded makes it clear they are not both required, so table footnote c is not needed.

Status
rlsheffi Completed 6/5/2006 10:16:36 AM

Sequence number: 8
Author: SIERLGC[BMartin]
Subject: Highlight
Date: 4/9/2006 12:57:38 PM

T Page 27, Table 8 footnote c
"can only be" s.b. "are only"

RESOLUTION: Delete table footnote c.

Status
rlsheffi Completed 6/5/2006 10:16:46 AM

Sequence number: 9
Author: IBM[GPenokie]
Subject: Comment on Text
Date: 4/9/2006 12:58:32 PM

T table 8 - footnote c
This << There can only be 6 total version descriptors. Normally e) and f) are not together so they fit. A FC to SAS bridge might have both, though. >> should be << There are only 6 total version descriptors. Normally e) and f) are not together so they fit. A FC to SAS bridge may have both. >>

RESOLUTION: Delete table footnote c

Status
rlsheffi Completed 6/5/2006 10:16:53 AM

Sequence number: 10
Author: IBM[GPenokie]
Subject: Comment on Text
Date: 5/25/2006 12:06:33 PM

T Table 8 - footnote d
This <<The encoding used by T10 for INQUIRY version descriptors (see SPC-3) and T13 for IDENTIFY DEVICE major and minor version numbers (see ATA/ATAPI-7) differ, and the two standards organizations may not define values for the same revisions. >> should be << The encoding used by the SPC-3 standard for INQUIRY version descriptors and the ATA/ATAPI-7 IDENTIFY DEVICE major and minor version numbers differ, and the two standards may not define values for the same revisions. >>

RESOLUTION: change to "The encoding used by the SPC-3 standard for INQUIRY version descriptors and the encoding used by the ATA8-ACS standard for IDENTIFY DEVICE major and minor version numbers differ. The two standards may not define values for the same revisions."

Status

Comments from page 47 continued on next page

Table 8 — Standard INQUIRY data fields (part 1 of 3)

Field	Description or reference
PERIPHERAL QUALIFIER	This field shall be set to 000b to indicate that the peripheral device is currently connected to this logical unit. ^a
PERIPHERAL DEVICE TYPE	This field shall be set to 00h to indicate that the peripheral device is a direct access block device. ^a
RMB	The SATL shall set this bit to the value of bit 7 of the GENERAL CONFIGURATION field of the IDENTIFY DEVICE data retrieved from the attached ATA device.
VERSION	The VERSION field indicates the version of SPC to which the SATL complies (see SPC-3) (e.g., 05h for SPC-3).
NORMACA	The SATL shall set this bit to zero to indicate the SATL does not support the NACA bit in the CONTROL byte (see 6.4).
HiSUP	Unspecified (see 3.4.3)
RESPONSE DATA FORMAT	The SATL shall set this field to 2h.
ADDITIONAL LENGTH	The SATL shall set this field to the length of the INQUIRY data that follows.
SCCS	Unspecified (see 3.4.3)
ACC	Unspecified (see 3.4.3)
TPGS	Unspecified (see 3.4.3)
3PC	Unspecified (see 3.4.3)
PROTECT	The SATL shall set this bit to zero to indicate that the peripheral device does not support protection information.
BQUE	Unspecified (see 3.4.3)
ENCSERV	Unspecified (see 3.4.3)
MULTIP	Unspecified (see 3.4.3)
MCHNGR	The SATL shall set this bit to zero to indicate the peripheral device is not attached to a medium transport element.
ADDR16	Unspecified (see 3.4.3)
WBUS16	Unspecified (see 3.4.3)
SYNC	Unspecified (see 3.4.3)
<p>^a If the INQUIRY command is issued to an unsupported logical unit the SATL shall set the PERIPHERAL QUALIFIER field to 011b and shall set the PERIPHERAL DEVICE TYPE field to 1Fh.</p> <p>^b The full ATA IDENTIFY DEVICE data MODEL NUMBER field contents and the REVISION NUMBER field contents are retrieved with the ATA Information VPD page (see 10.3.5).</p> <p>^c There can only be 6 total version descriptors. Normally e) and f) are not together so they fit. A FC to SAS bridge might have both, though.</p> <p>^d The encoding used by T10 for INQUIRY version descriptors (see SPC-3) and T13 for IDENTIFY DEVICE major and minor version numbers (see ATA/ATAPI-7) differ, and the two standards organizations may not define values for the same revisions.</p>	

Table 8 — Standard INQUIRY data fields (part 2 of 3)

Field	Description or reference
LINKED	The SATL shall set this field to 0 to indicate that this peripheral device does not support linked commands.
CMDQUE	Unspecified (see 3.4.3)
VENDOR IDENTIFICATION	The SATL shall set the VENDOR IDENTIFICATION field to 'ATA'.
PRODUCT IDENTIFICATION	The SATL shall set the PRODUCT IDENTIFICATION field to a representation of the first 16 bytes of the ATA device IDENTIFY DEVICE data MODEL NUMBER field, where each pair of bytes are swapped to create a valid ASCII string format ^b : 1) byte 0 contains IDENTIFY DEVICE word 27 bits 15:8 (i.e., byte 1); 2) byte 1 contains IDENTIFY DEVICE word 27 bits 7:0 (i.e., byte 0); 3) byte 2 contains IDENTIFY DEVICE word 28 bits 15:8 (i.e., byte 3); 4) byte 3 contains IDENTIFY DEVICE word 28 bits 7:0 (i.e., byte 2); ... 15) byte 14 contains IDENTIFY DEVICE word 34 bits 15:8 (i.e., byte 15); and 16) byte 15 contains IDENTIFY DEVICE word 34 bits 7:0 (i.e., byte 14).
PRODUCT REVISION LEVEL	The SATL shall set the PRODUCT REVISION LEVEL field to a four byte ASCII character representation of the ATA device IDENTIFY DEVICE data Firmware Revision field. Each pair of bytes are swapped to create a valid ASCII string format. Since the ATA device IDENTIFY DEVICE data Firmware Revision field contains eight ASCII characters and the Standard INQUIRY data PRODUCT REVISION LEVEL field is four ASCII characters, the SATL shall select four of the eight ASCII characters from the IDENTIFY DEVICE data Firmware Revision field to return in the PRODUCT REVISION LEVEL field as follows: a) If the IDENTIFY DEVICE data received in words 25 and 26 from the ATA device are ASCII spaces (20h), then the four ASCII characters selected shall be: 1) byte 0 contains IDENTIFY DEVICE data word 23 bits 15:8 (i.e., byte 1); 2) byte 1 contains IDENTIFY DEVICE data word 23 bits 7:0 (i.e., byte 0); 3) byte 2 contains IDENTIFY DEVICE data word 24 bits 15:8 (i.e., byte 3); and 4) byte 3 contains IDENTIFY DEVICE data word 24 bits 7:0 (i.e., byte 2); or b) If the IDENTIFY DEVICE data received in words 25 and 26 from the ATA device are not ASCII spaces (20h), then the four ASCII characters selected shall be: 1) byte 0 contains IDENTIFY DEVICE data word 25 bits 15:8 (i.e., byte 5); 2) byte 1 contains IDENTIFY DEVICE data word 25 bits 7:0 (i.e., byte 4); 3) byte 2 contains IDENTIFY DEVICE data word 26 bits 15:8 (i.e., byte 7); and 4) byte 3 contains IDENTIFY DEVICE data word 26 bits 7:0 (i.e., byte 6).
CLOCKING	Unspecified (see 3.4.3)
QAS	Unspecified (see 3.4.3)
IUS	Unspecified (see 3.4.3)
^a If the INQUIRY command is issued to an unsupported logical unit the SATL shall set the PERIPHERAL QUALIFIER field to 011b and shall set the PERIPHERAL DEVICE TYPE field to 1Fh. ^b The full ATA IDENTIFY DEVICE data MODEL NUMBER field contents and the REVISION NUMBER field contents are retrieved with the ATA Information VPD page (see 10.3.5). ^c There can only be 6 total version descriptors. Normally e) and f) are not together so they fit. A FC to SAS bridge might have both, though. ^d The encoding used by T10 for INQUIRY version descriptors (see SPC-3) and T13 for IDENTIFY DEVICE major and minor version numbers (see ATA/ATAPI-7) differ, and the two standards organizations may not define values for the same revisions.	

Table 8 — Standard INQUIRY data fields (part 2 of 3)

Field	Description or reference
LINKED	The SATL shall set this field to 0 to indicate that this peripheral device does not support linked commands.
CMDQUE	Unspecified (see 3.4.3)
VENDOR IDENTIFICATION	The SATL shall set the VENDOR IDENTIFICATION field to 'ATA'.
PRODUCT IDENTIFICATION	The SATL shall set the PRODUCT IDENTIFICATION field to a representation of the first 16 bytes of the ATA device IDENTIFY DEVICE data MODEL NUMBER field, where each pair of bytes are swapped to create a valid ASCII string format ^d : 1) byte 0 contains IDENTIFY DEVICE word 27 bits 15:8 (i.e., byte 1); 2) byte 1 contains IDENTIFY DEVICE word 27 bits 7:0 (i.e., byte 0); 3) byte 2 contains IDENTIFY DEVICE word 28 bits 15:8 (i.e., byte 3); 4) byte 3 contains IDENTIFY DEVICE word 28 bits 7:0 (i.e., byte 2); ... 15) byte 14 contains IDENTIFY DEVICE word 34 bits 15:8 (i.e., byte 15); and 16) byte 15 contains IDENTIFY DEVICE word 34 bits 7:0 (i.e., byte 14).
PRODUCT REVISION LEVEL	The SATL shall set the PRODUCT REVISION LEVEL field to a four byte ASCII character representation of the ATA device IDENTIFY DEVICE data Firmware Revision field. Each pair of bytes are swapped to create a valid ASCII string format. Since the ATA device IDENTIFY DEVICE data Firmware Revision field contains eight ASCII characters and the Standard INQUIRY data PRODUCT REVISION LEVEL field is four ASCII characters, the SATL shall select four of the eight ASCII characters from the IDENTIFY DEVICE data Firmware Revision field to return in the PRODUCT REVISION LEVEL field as follows: a) If the IDENTIFY DEVICE data received in words 25 and 26 from the ATA device are ASCII spaces (20h), then the four ASCII characters selected shall be: 1) byte 0 contains IDENTIFY DEVICE data word 23 bits 15:8 (i.e., byte 1); 2) byte 1 contains IDENTIFY DEVICE data word 23 bits 7:0 (i.e., byte 0); 3) byte 2 contains IDENTIFY DEVICE data word 24 bits 15:8 (i.e., byte 3); and 4) byte 3 contains IDENTIFY DEVICE data word 24 bits 7:0 (i.e., byte 2); or b) If the IDENTIFY DEVICE data received in words 25 and 26 from the ATA device are not ASCII spaces (20h), then the four ASCII characters selected shall be: 1) byte 0 contains IDENTIFY DEVICE data word 25 bits 15:8 (i.e., byte 5); 2) byte 1 contains IDENTIFY DEVICE data word 25 bits 7:0 (i.e., byte 4); 3) byte 2 contains IDENTIFY DEVICE data word 26 bits 15:8 (i.e., byte 7); and 4) byte 3 contains IDENTIFY DEVICE data word 26 bits 7:0 (i.e., byte 6).
CLOCKING	Unspecified (see 3.4.3)
QAS	Unspecified (see 3.4.3)
IUS	Unspecified (see 3.4.3)
<p>^a If the INQUIRY command is issued to an unsupported logical unit the SATL shall set the PERIPHERAL QUALIFIER field to 011b and shall set the PERIPHERAL DEVICE TYPE field to 1Fh.</p> <p>^b The full ATA IDENTIFY DEVICE data MODEL NUMBER field contents and the REVISION NUMBER field contents are retrieved with the ATA Information VPD page (see 10.3.5).</p> <p>^c There can only be 6 total version descriptors. Normally e) and f) are not together so they fit. A FC to SAS bridge might have both, though.</p> <p>^d The encoding used by T10 for INQUIRY version descriptors (see SPC-3) and T13 for IDENTIFY DEVICE major and minor version numbers (see ATA/ATAPI-7) differ, and the two standards organizations may not define values for the same revisions.</p>	

style guide. The ' ' represents an ASCII space. Putting actual ASCII spaces here would make it impossible for the reader to determine the correct number of them to include.

RESOLUTION: Added a table footnote.

Status
risheffi Completed 6/5/2006 10:33:22 AM

Sequence number: 7
Author: DELL[KMarks]
Subject: Highlight
Date: 2/1/2006 10:47:44 PM

T Table 8 — Standard INQUIRY data fields (part 2 of 3)

Row: PRODUCT IDENTIFICATION

change

"... the ATA device IDENTIFY DEVICE data MODEL NUMBER field, where..."

to

"... the ATA IDENTIFY DEVICE data Model number field, where..."

Status
risheffi Completed 6/5/2006 10:34:44 AM

Sequence number: 8
Author: DELL[KMarks]
Subject: Highlight
Date: 2/1/2006 11:05:37 PM

T Table 8 — Standard INQUIRY data fields (part 2 of 3)

Row: PRODUCT IDENTIFICATION

change

"1) byte 0 contains IDENTIFY DEVICE word 27 bits 15:8 (i.e., byte 1);

2) byte 1 contains IDENTIFY DEVICE word 27 bits 7:0 (i.e., byte 0);

3) byte 2 contains IDENTIFY DEVICE word 28 bits 15:8 (i.e., byte 3);

4) byte 3 contains IDENTIFY DEVICE word 28 bits 7:0 (i.e., byte 2);

...

15) byte 14 contains IDENTIFY DEVICE word 34 bits 15:8 (i.e., byte 15); and

16) byte 15 contains IDENTIFY DEVICE word 34 bits 7:0 (i.e., byte 14)."

to

"1) byte 0 contains ATA IDENTIFY DEVICE data word 27 bits 15:8 (i.e., byte 1);

2) byte 1 contains ATA IDENTIFY DEVICE data word 27 bits 7:0 (i.e., byte 0);

3) byte 2 contains ATA IDENTIFY DEVICE data word 28 bits 15:8 (i.e., byte 3);

4) byte 3 contains ATA IDENTIFY DEVICE data word 28 bits 7:0 (i.e., byte 2);

...

15) byte 14 contains ATA IDENTIFY DEVICE data word 34 bits 15:8 (i.e., byte 15); and

16) byte 15 contains ATA IDENTIFY DEVICE data word 34 bits 7:0 (i.e., byte 14)."

Status
risheffi Completed 6/5/2006 10:36:53 AM

Sequence number: 9
Author: DELL[KMarks]
Subject: Highlight
Date: 2/1/2006 10:59:31 PM

T Table 8 — Standard INQUIRY data fields (part 2 of 3)

Row: PRODUCT REVISION LEVEL

change

"The SATL shall set the PRODUCT REVISION LEVEL field to a four byte ASCII character representation of the ATA device IDENTIFY DEVICE data Firmware Revision field. Each pair of bytes are swapped to create a valid ASCII string format. Since the ATA device IDENTIFY DEVICE data Firmware Revision field contains eight ASCII characters and the Standard INQUIRY data PRODUCT REVISION LEVEL field is four ASCII characters, the SATL shall select four of the eight ASCII characters from the IDENTIFY DEVICE data Firmware Revision field to return in the PRODUCT REVISION LEVEL field as follows:"

to

"The SATL shall set the PRODUCT REVISION LEVEL field to a four byte ASCII character representation of the ATA IDENTIFY DEVICE data Firmware revision field. Each pair of bytes are swapped to create a valid ASCII string format. Since

Table 8 — Standard INQUIRY data fields (part 2 of 3)

Field	Description or reference
LINKED	The SATL shall set this field to 0 to indicate that this peripheral device does not support linked commands.
CMDQUE	Unspecified (see 3.4.3)
VENDOR IDENTIFICATION	The SATL shall set the VENDOR IDENTIFICATION field to 'ATA'.
PRODUCT IDENTIFICATION	The SATL shall set the PRODUCT IDENTIFICATION field to a representation of the first 16 bytes of the ATA device IDENTIFY DEVICE data MODEL NUMBER field, where each pair of bytes are swapped to create a valid ASCII string format ^d : <ol style="list-style-type: none"> 1) byte 0 contains IDENTIFY DEVICE word 27 bits 15:8 (i.e., byte 1); 2) byte 1 contains IDENTIFY DEVICE word 27 bits 7:0 (i.e., byte 0); 3) byte 2 contains IDENTIFY DEVICE word 28 bits 15:8 (i.e., byte 3); 4) byte 3 contains IDENTIFY DEVICE word 28 bits 7:0 (i.e., byte 2); ... 15) byte 14 contains IDENTIFY DEVICE word 34 bits 15:8 (i.e., byte 15); and 16) byte 15 contains IDENTIFY DEVICE word 34 bits 7:0 (i.e., byte 14).
PRODUCT REVISION LEVEL	The SATL shall set the PRODUCT REVISION LEVEL field to a four byte ASCII character representation of the ATA device IDENTIFY DEVICE data Firmware Revision field. Each pair of bytes are swapped to create a valid ASCII string format. Since the ATA device IDENTIFY DEVICE data Firmware Revision field contains eight ASCII characters and the Standard INQUIRY data PRODUCT REVISION LEVEL field is four ASCII characters, the SATL shall select four of the eight ASCII characters from the IDENTIFY DEVICE data Firmware Revision field to return in the PRODUCT REVISION LEVEL field as follows: <ol style="list-style-type: none"> a) If the IDENTIFY DEVICE data received in words 10 and 26 from the ATA device are ASCII spaces (20h), then the four ASCII characters selected shall 11: <ol style="list-style-type: none"> 1) byte 0 contains IDENTIFY DEVICE data word 23 bits 15:8 (i.e., byte 1); 2) byte 1 contains IDENTIFY DEVICE data word 23 bits 7:0 (i.e., byte 0); 3) byte 2 contains IDENTIFY DEVICE data word 24 bits 15:8 (i.e., byte 3); and 4) byte 3 contains IDENTIFY DEVICE data word 24 bits 7:0 (i.e., byte 2); or b) If the IDENTIFY DEVICE data received in words 25 and 26 from the ATA device are not ASCII spaces (20h), then the four ASCII characters selected shall 13: <ol style="list-style-type: none"> 1) byte 0 contains IDENTIFY DEVICE data word 25 bits 15:8 (i.e., byte 5); 2) byte 1 contains IDENTIFY DEVICE data word 25 bits 7:0 (i.e., byte 4); 3) byte 2 contains IDENTIFY DEVICE data word 26 bits 15:8 (i.e., byte 7); and 4) byte 3 contains IDENTIFY DEVICE data word 26 bits 7:0 (i.e., byte 6).
CLOCKING	Unspecified (see 3.4.3)
QAS	Unspecified (see 3.4.3)
IUS	Unspecified (see 3.4.3)
<p>^a If the INQUIRY command is issued to an unsupported logical unit the SATL shall set the PERIPHERAL QUALIFIER field to 011b and shall set the PERIPHERAL DEVICE TYPE field to 1Fh.</p> <p>^b The full ATA IDENTIFY DEVICE data MODEL NUMBER field contents and the REVISION NUMBER field contents are retrieved with the ATA Information VPD page (see 10.3.5).</p> <p>^c There can only be 6 total version descriptors. Normally e) and f) are not together so they fit. A FC to SAS bridge might have both, though.</p> <p>^d The encoding used by T10 for INQUIRY version descriptors (see SPC-3) and T13 for IDENTIFY DEVICE major and minor version numbers (see ATA/ATAPI-7) differ, and the two standards organizations may not define values for the same revisions.</p>	

the ATA IDENTIFY DEVICE data Firmware revision field contains eight ASCII characters and the standard INQUIRY data PRODUCT REVISION LEVEL field is four ASCII characters, the SATL shall select four of the eight ASCII characters from the ATA IDENTIFY DEVICE data Firmware revision field to return in the PRODUCT REVISION LEVEL field as follows:"

Status
risheffi Completed 6/5/2006 10:39:41 AM

Sequence number: 10
Author: HPQ[RElliott]
Subject: Highlight
Date: 5/18/2006 12:33:40 PM

T 8.1.2
table 8

"25 and 26" s/b "23 and 24"

RESOLUTION: change
"words 25 and 26 from the ATA device are ASCII spaces (20h)"
to
"words 26:25 from the ATA device are set to four ASCII spaces (i.e., 20202020h)"

Status
risheffi Completed 6/5/2006 10:41:02 AM

Sequence number: 11
Author: DELL[KMarks]
Subject: Highlight
Date: 2/16/2006 1:38:01 PM

T Table 8 — Standard INQUIRY data fields (part 2 of 3)
Row: PRODUCT REVISION LEVEL - in a) of a,b
change
"shall be:"
to
"shall contain:"

Status
risheffi Completed 6/5/2006 10:41:48 AM

Sequence number: 12
Author: HPQ[RElliott]
Subject: Highlight
Date: 5/18/2006 12:30:09 PM

T 8.1.2
table 8

"If the IDENTIFY DEVICE data received in words 25 and 26 from the ATA device are not ASCII spaces (20h)"

to
change to "If IDENTIFY DEVICE data words 26:25 are set to four ASCII spaces (i.e., 20202020h)"

and change preceding a) to follow (for words 24:23)

RESOLUTION: Change
"words 25 and 26 from the ATA device are not ASCII spaces (20h)"
to
"If IDENTIFY DEVICE data words 26:25 are not set to four ASCII spaces (i.e., 20202020h)"

Status
risheffi Completed 6/5/2006 11:38:27 AM

Sequence number: 13
Author: DELL[KMarks]
Subject: Highlight
Date: 2/16/2006 1:38:16 PM

T Table 8 — Standard INQUIRY data fields (part 2 of 3)

Comments from page 48 continued on next page

Table 8 — Standard INQUIRY data fields (part 2 of 3)

Field	Description or reference
LINKED	The SATL shall set this field to 0 to indicate that this peripheral device does not support linked commands.
CMDQUE	Unspecified (see 3.4.3)
VENDOR IDENTIFICATION	The SATL shall set the VENDOR IDENTIFICATION field to 'ATA'.
PRODUCT IDENTIFICATION	<p>The SATL shall set the PRODUCT IDENTIFICATION field to a representation of the first 16 bytes of the ATA device IDENTIFY DEVICE data MODEL NUMBER field, where each pair of bytes are swapped to create a valid ASCII string format ^b:</p> <ol style="list-style-type: none"> 1) byte 0 contains IDENTIFY DEVICE word 27 bits 15:8 (i.e., byte 1); 2) byte 1 contains IDENTIFY DEVICE word 27 bits 7:0 (i.e., byte 0); 3) byte 2 contains IDENTIFY DEVICE word 28 bits 15:8 (i.e., byte 3); 4) byte 3 contains IDENTIFY DEVICE word 28 bits 7:0 (i.e., byte 2); ... 15) byte 14 contains IDENTIFY DEVICE word 34 bits 15:8 (i.e., byte 15); and 16) byte 15 contains IDENTIFY DEVICE word 34 bits 7:0 (i.e., byte 14).
PRODUCT REVISION LEVEL	<p>The SATL shall set the PRODUCT REVISION LEVEL field to a four byte ASCII character representation of the ATA device IDENTIFY DEVICE data Firmware Revision field. Each pair of bytes are swapped to create a valid ASCII string format. Since the ATA device IDENTIFY DEVICE data Firmware Revision field contains eight ASCII characters and the Standard INQUIRY data PRODUCT REVISION LEVEL field is four ASCII characters, the SATL shall select four of the eight ASCII characters from the IDENTIFY DEVICE data Firmware Revision field to return in the PRODUCT REVISION LEVEL field as follows:</p> <ol style="list-style-type: none"> a) If the IDENTIFY DEVICE data received in words 25 and 26 from the ATA device are ASCII spaces (20h), then the four ASCII characters selected shall be: <ol style="list-style-type: none"> 1) byte 0 contains IDENTIFY DEVICE data word 23 bits 15:8 (i.e., byte 1); 2) byte 1 contains IDENTIFY DEVICE data word 23 bits 7:0 (i.e., byte 0); 3) byte 2 contains IDENTIFY DEVICE data word 24 bits 15:8 (i.e., byte 3); and 4) byte 3 contains IDENTIFY DEVICE data word 24 bits 7:0 (i.e., byte 2); or b) If the IDENTIFY DEVICE data received in words 25 and 26 from the ATA device are not ASCII spaces (20h), then the four ASCII characters selected shall be: <ol style="list-style-type: none"> 1) byte 0 contains IDENTIFY DEVICE data word 25 bits 15:8 (i.e., byte 5); 2) byte 1 contains IDENTIFY DEVICE data word 25 bits 7:0 (i.e., byte 4); 3) byte 2 contains IDENTIFY DEVICE data word 26 bits 15:8 (i.e., byte 7); and 4) byte 3 contains IDENTIFY DEVICE data word 26 bits 7:0 (i.e., byte 6).
CLOCKING	Unspecified (see 3.4.3)
QAS	Unspecified (see 3.4.3)
IUS	Unspecified (see 3.4.3)
<p>^a If the INQUIRY command is issued to an unsupported logical unit the SATL shall set the PERIPHERAL QUALIFIER field to 011b and shall set the PERIPHERAL DEVICE TYPE field to 1Fh.</p> <p>^b The full ATA IDENTIFY DEVICE data MODEL NUMBER field contents and the REVISION NUMBER field contents are retrieved with the ATA Information VPD page ¹⁴ (see 10.3.5).</p> <p>^c There can only be 6 total version descriptors. Normally e) and f) are not together so they fit. A FC to SAS bridge might have both, though.</p> <p>^d The encoding used by T10 for INQUIRY version descriptors (see SPC-3) and T13 for IDENTIFY DEVICE major and minor version numbers (see ATA/ATAPI-7) differ, and the two standards organizations may not define values for the same revisions.</p>	

Row: **PRODUCT REVISION LEVEL - in b) of a,b**
change
"shall be:"
to
"shall contain:"

Status
rlsheffi Completed 6/5/2006 11:38:48 AM

Sequence number: 14
Author: INTC[RSheffield]
Subject: Highlight
Date: 4/10/2006 1:16:37 PM
 Fix dead link

Status
rlsheffi Completed 6/5/2006 11:39:27 AM

Table 8 — Standard INQUIRY data fields (part 3 of 3)

Field	Description or reference
1 VERSION DESCRIPTOR 1 THROUGH VERSION DESCRIPTOR 6 ^c	The SATL shall include version descriptors as described in SPC-3 for: <ol style="list-style-type: none"> the SCSI architecture model standard (e.g., SAM-3); this standard; the SCSI primary commands standard (e.g., SPC-3); the SCSI block commands standard (e.g., SBC-2); if the SATL receives SCSI commands through a SCSI target port, the version of the transport protocol to which the SCSI target port was designed; if the SATL sends ATA commands through a SAS STP initiator port, the version of SAS (e.g., SAS-1.1) to which the SAS initiator port was designed; and 2 the version of ATA/ATAPI (e.g., ATA/ATAPI-7) to which the ATA device claims compliance in the 4 IDENTIFY 3 DEVICE data MAJOR VERSION NUMBER field (i.e., word 80) and MINOR VERSION NUMBER field (i.e., word 81).^d
Vendor specific parameters	Unspecified (see 3.4.3)
<p>^a If the INQUIRY command is issued to an unsupported logical unit the SATL shall set the PERIPHERAL QUALIFIER field to 011b and shall set the PERIPHERAL DEVICE TYPE field to 1Fh.</p> <p>^b The full ATA IDENTIFY DEVICE data MODEL NUMBER field contents and the REVISION NUMBER field contents are retrieved with the ATA Information VPD page (see 10.3.5).</p> <p>^c There can only be 6 total version descriptors. Normally e) and f) are not together so they fit. A FC to SAS bridge might have both, though.</p> <p>^d The encoding used by T10 for INQUIRY version descriptors (see SPC-3) and T13 for IDENTIFY DEVICE major and minor version numbers (see ATA/ATAPI-7) differ, and the two standards organizations may not define values for the same revisions.</p>	

8.2 LOG SENSE command

8.2.1 LOG SENSE command overview

The LOG SENSE command provides a mechanism an application may use to retrieve statistical or diagnostic results, or other operating information about a target or a logical unit. Table 9 shows the translation for fields specified in the LOG SENSE CDB (see SPC-3).

Table 9 — LOG SENSE command CDB fields

Field	Description or reference
OPERATION CODE	The SATL shall implement support for this field by returning the log page data for the particular page requested.
PPC	Unspecified (see 3.4.3)
SP	Unspecified (see 3.4.3)
PC	8.2.2
PAGE CODE	8.2.3
PARAMETER POINTER	Unspecified (see 3.4.3)
ALLOCATION LENGTH	The SATL shall implement support for this field as defined in SPC-3.
CONTROL	6.4

Sequence number: 1
Author: MXO[MEvans]
Subject: Highlight
Date: 2/9/2006 8:13:47 AM

T Table 8: change "VERSION DESCRIPTOR 1 THROUGH VERSION DESCRIPTOR 6" to "VERSION DESCRIPTOR 1 through VERSION DESCRIPTOR 8".

Status
rlsheffi Completed 6/5/2006 11:40:44 AM

Sequence number: 2
Author: ELX[KHirata]
Subject: Highlight
Date: 4/11/2006 4:31:29 PM

T Page 29, Version Descriptor field definitions, Item g

Comment:
Item 'g' seems to expose into the SCSI layer some ATA specific information that probably isn't very meaningful to SCSI. If the host were SATL aware, wouldn't it be better to get this information directly from the ATA Information VPD Page. Why duplicate it here.

Preferred resolution:
Agnostic. Doesn't make the translation harder or easier. Just seems misplaced so I wanted to ask the question.

REASON: SPC-3 table D.14 defines codes for all SCSI device types, including values for ATA/ATAPI. Some level of exposure of the ATA/ATAPI conformance version is already anticipated in SPC-3 for one reason or another, so it doesn't seem unreasonable to allow it here.

Status
rlsheffi Rejected 4/11/2006 4:27:12 PM

Sequence number: 3
Author: DELL[KMarks]
Subject: Highlight
Date: 6/5/2006 11:54:13 AM

T Table 8 — Standard INQUIRY data fields (part 3 of 3)
Row: VERSION DESCRIPTOR 1 THROUGH VERSION DESCRIPTOR 6c

Change

"...DEVICE data MAJOR VERSION NUMBER field (i.e., word 80) and MINOR VERSION NUMBER field ..."
to
"...DEVICE data Major version number field (i.e., word 80) and Minor version number field ..."
RESOLUTION: s/b
"ATA IDENTIFY DEVICE data word 80 (i.e., Major version number) and ATA IDENTIFY DEVICE data word 81 (i.e., Minor version number)."

Status
rlsheffi Completed 6/5/2006 11:50:10 AM

Sequence number: 4
Author: HPQ[RElliott]
Subject: Highlight
Date: 6/5/2006 11:54:51 AM

T 8.1.2
table 8

change "IDENTIFY DEVICE data MAJOR VERSION NUMBER field (i.e., word 80) and MINOR VERSION NUMBER field (i.e., word 81)"
to
"IDENTIFY DEVICE data word 80 (i.e., Major Version Number) and IDENTIFY DEVICE data word 81 (i.e., Minor Version Number)"

Table 8 — Standard INQUIRY data fields (part 3 of 3)

Field	Description or reference
VERSION DESCRIPTOR 1 THROUGH VERSION DESCRIPTOR 6 ^c	The SATL shall include version descriptors as described in SPC-3 for: <ul style="list-style-type: none"> a) the SCSI architecture model standard (e.g., SAM-3); b) this standard; c) the SCSI primary commands standard (e.g., SPC-3); d) the SCSI block commands standard (e.g., SBC-2); e) if the SATL receives SCSI commands through a SCSI target port, the version of the transport protocol to which the SCSI target port was designed; f) if the SATL sends ATA commands through a SAS STP initiator port, the version of SAS (e.g., SAS-1.1) to which the SAS initiator port was designed; and g) the version of ATA/ATAPI (e.g., ATA/ATAPI-7) to which the ATA device claims compliance in the IDENTIFY DEVICE data MAJOR VERSION NUMBER field (i.e., word 80) and MINOR VERSION NUMBER field (i.e., word 81).^d
Vendor specific parameters	Unspecified (see 3.4.3)
<p>^a If the INQUIRY command is issued to an unsupported logical unit the SATL shall set the PERIPHERAL QUALIFIER field to 011b and shall set the PERIPHERAL DEVICE TYPE field to 1Fh.</p> <p>^b The full ATA IDENTIFY DEVICE data MODEL NUMBER field contents and the REVISION NUMBER field contents are retrieved with the ATA Information VPD page (see 10.3.5).</p> <p>^c There can only be 6 total version descriptors. Normally e) and f) are not together so they fit. A FC to SAS bridge might have both, though.</p> <p>^d The encoding used by T10 for INQUIRY version descriptors (see SPC-3) and T13 for IDENTIFY DEVICE major and minor version numbers (see ATA/ATAPI-7) differ, and the two standards organizations may not define values for the same revisions.</p>	

8.2 LOG SENSE command

8.2.1 LOG SENSE command overview

The LOG SENSE command provides a mechanism an application may use to retrieve statistical or diagnostic results, or other operating information about a target or a logical unit. Table 9 shows the translation for fields specified in the LOG SENSE CDB. (see SPC-3).

Table 9 — LOG SENSE command CDB fields

Field	Description or reference
OPERATION CODE	The SATL shall implement support for this field by returning the log page data for the particular page requested.
PPC	Unspecified (see 3.4.3)
SP	Unspecified (see 3.4.3)
PC	9.2.2
PAGE CODE	8.2.3
PARAMETER POINTER	Unspecified (see 3.4.3)
ALLOCATION LENGTH	The SATL shall implement support for this field as defined in SPC-3.
CONTROL	6.4

RESOLUTION: s/b

"ATA IDENTIFY DEVICE data word 80 (i.e., Major version number) and ATA IDENTIFY DEVICE data word 81 (i.e., Minor version number)."

Status
rlsheffi Completed 6/5/2006 11:54:21 AM

Sequence number: 5
Author: MXO[MEvans]
Subject: Highlight
Date: 6/5/2006 11:56:35 AM

T Table 8, footnote item (c): change this to, "There may be up to eight version descriptors."
RESOLUTION: Deleted table footnote (c) and modified the field name column to read, "VERSION DESCRIPTOR 1 to VERSION DESCRIPTOR 8"

Status
rlsheffi Completed 6/5/2006 11:56:38 AM

Sequence number: 6
Author: MXO[MEvans]
Subject: Highlight
Date: 2/9/2006 10:06:57 AM

T 8.2.1 LOG SENSE command overview, first paragraph: change the first sentence to, "The LOG SENSE command provides a means for the application client to retrieve statistical or other operational information maintained by the SCSI target device about the SCSI target device or its logical units." These are the words in SPC-3.

Status
rlsheffi Completed 6/5/2006 12:02:53 PM

Sequence number: 7
Author: HPQ[RElliott]
Subject: Highlight
Date: 6/5/2006 12:03:35 PM

T 8.2.1
fix bare "target"
RESOLUTION: see MXO comment.

Status
rlsheffi Completed 6/5/2006 12:03:20 PM

Sequence number: 8
Author: DELL[KMarks]
Subject: Cross-Out
Date: 2/16/2006 1:39:19 PM

T 8.2.1 2nd sentence
remove
"(see SPC-3)."

None of the other commands in this SPC section say see SPC-3.

Status
rlsheffi Completed 6/5/2006 12:04:09 PM

Sequence number: 9
Author: MXO[MEvans]
Subject: Highlight
Date: 4/11/2006 4:39:58 PM

T Table 9 and global: change "8.2.2" to "See 8.2.2". This style was first noted in table 7 and thought to be an anomaly. It now appears to be a "style" -- an incorrect one. Change each "x.y" in subsequent tables to "See x.y".

REASON: All the stand-alone references under the column heading "Description or reference" were changed to the "8.2.2" format rather than the "See 8.2.2" format according to recommendations from T10 editors at earlier SAT editor's sessions. The SAT editor could still change them all back to the "See 8.2.2" format, but only if there's consensus among the current T10 editors.

Status
rlsheffi Rejected 4/11/2006 4:35:30 PM

4 The SATL shall return SMART data log page data. 2 the PAGE CODE is another value, the SATL shall terminate the command with CHECK CONDITION status with the sense key set to ILLEGAL REQUEST and the additional sense code set to INVALID FIELD IN CDB.

8.2.2 PC (page control) field

The SATL shall implement this field as defined in SPC-3. The SATL interpretation and support of the page control values is shown in table 10.

Table 10 — PC field values

Code	Description
00b	Threshold values: unspecified (see 3.4.3)
01b	Cumulative values: supported
10b	Default threshold values: unspecified (see 3.4.3)
11b	Default cumulative values: unspecified (see 3.4.3)

8.2.3 PAGE CODE field

The SATL shall support this field as defined in SPC-3. The SATL emulation for support of the PAGE CODE field is provided in table 11.

Table 11 — PAGE CODE field values

Code	Description
00h	Supported Log Pages log page: The SATL shall implement this page by returning a list of supported log pages (see 10.2.5).
10h	Self-Test Results log page: The SATL shall determine if the ATA SMART self test is supported from the ATA IDENTIFY DEVICE data word 84, bit 1. If the ATA SMART selftest is not supported the SATL shall return a CHECK CONDITION status with SENSE KEY set to ILLEGAL REQUEST and ADDITIONAL SENSE CODE set to INVALID FIELD IN CDB. If the ATA SMART self test is supported the SATL shall return the translated Self-Test Results log page to the application client (see 10.2.4).
2Fh	Informational Exceptions log page: The SATL shall determine if the ATA SMART feature set is supported from the ATA IDENTIFY DEVICE data word 82, bit 0. If the ATA SMART feature set is not supported the SATL shall return a CHECK CONDITION status with SENSE KEY set to ILLEGAL REQUEST and ADDITIONAL SENSE CODE set to INVALID FIELD IN CDB. If the ATA SMART feature set is supported the SATL shall determine if the ATA SMART feature set is enabled or disabled from the ATA IDENTIFY DEVICE data word 85, bit 0. If the ATA SMART feature set is disabled the SATL shall return a CHECK CONDITION status with SENSE KEY set to ABORTED COMMAND and ADDITIONAL SENSE CODE set to ATA-DEVICE FEATURE NOT ENABLED. If the ATA SMART feature set is enabled the SATL shall return the translated Informational Exceptions log page to the application client (see 10.2.3).
all others	Unspecified (see 3.4.3)

Sequence number: 1
Author: EDITOR[rlsheffi]
Subject: Cross-Out
Date: 4/11/2006 4:42:31 PM

T 8.2.1 LOG SENSE command overview
1st Paragraph after Table 9

Delete this paragraph (redundant with SPC-3, and wrong regarding SMART) - per SAT LB review 3/20/06.

Status
rlsheffi Completed 6/5/2006 12:06:33 PM

Sequence number: 2
Author: MXO[MEvans]
Subject: Highlight
Date: 4/11/2006 4:41:51 PM

T 8.2.1 LOG SENSE command overview, last paragraph: change the last sentence to, "If the value in the PAGE CODE field is not specified as being emulated by this standard (see 8.2.3), then the SATL shall terminate the command with CHECK CONDITION status with the sense key set to ILLEGAL REQUEST and the additional sense code set to INVALID FIELD IN CDB."
REASON: This paragraph is being deleted - see EDITOR's comment.

Status
rlsheffi Rejected 3/20/2006 2:24:34 PM

Sequence number: 3
Author: DELL[KMarks]
Subject: Highlight
Date: 4/11/2006 4:43:00 PM

T 8.2.1 LOG SENSE command overview
1st Paragraph after Table 9

Remove paragraph or change to

"The SATL shall return SMART data log page data. If the PAGE CODE is another value, the SATL shall terminate the command with CHECK CONDITION status with the sense key set to ILLEGAL REQUEST and the additional sense code set to INVALID FIELD IN CDB."

to

"If the PAGE CODE is set to an unsupported value, the SATL shall terminate the command with CHECK CONDITION status with the sense key set to ILLEGAL REQUEST and the additional sense code set to INVALID FIELD IN CDB."

RESOLUTION: Paragraph deleted (see EDITOR's comment)

Status
rlsheffi Completed 6/5/2006 12:06:33 PM

Sequence number: 4
Author: HPQ[WBellamy]
Subject: Highlight
Date: 2/19/2006 8:12:02 PM

T

Status
rlsheffi Completed 6/5/2006 12:06:33 PM

Sequence number: 5
Author: HPQ[WBellamy]
Subject: Note
Date: 4/11/2006 4:44:06 PM

 This statement is incorrect. It is not in proposal 05-142r4 which was approved by the W.G. Where did this come from and why is SMART mentioned here? This statement should be removed.

RESOLUTION: Remove paragraph.

Status
rlsheffi Completed 6/5/2006 12:06:33 PM

Sequence number: 6
Author: HPQ[RElliott]
Subject: Cross-Out
Date: 2/1/2006 3:33:49 PM

The SATL shall return SMART data log page data. If the PAGE CODE is another value, the SATL shall terminate the command with CHECK CONDITION status with the sense key set to ILLEGAL REQUEST and the additional sense code set to INVALID FIELD IN CDB.

8.2.2 PC (page control) field

The SATL shall implement this field as defined in SPC-3. The SATL interpretation and support of the page control values is shown in table 10.

Table 10 — PC field values

Code	Description
00b	Threshold values: unspecified (see 3.4.3)
01b	Cumulative values: supported
10b	Default threshold values: unspecified (see 3.4.3)
11b	Default cumulative values: unspecified (see 3.4.3)

8.2.3 PAGE CODE field

The SATL shall support this field as defined in SPC-3. The SATL emulation for support of the PAGE CODE field is provided in table 11.

Table 11 — PAGE CODE field values

Code	Description
00h	Supported Log Pages log page: The SATL shall implement this page by returning a list of supported log pages (see 10.2.5).
10h	Self Test Results log page: The SATL shall determine if the ATA SMART self test is supported from the ATA IDENTIFY DEVICE data word 84, bit 1. If the ATA SMART self test is not supported the SATL shall return a CHECK CONDITION status with SENSE KEY set to ILLEGAL REQUEST and ADDITIONAL SENSE CODE set to INVALID FIELD IN CDB. If the ATA SMART self test is supported the SATL shall return the translated Self Test Results log page to the application client (see 10.2.4).
2Fh	Informational Exceptions log page: The SATL shall determine if the ATA SMART feature set is supported from the ATA IDENTIFY DEVICE data word 82, bit 0. If the ATA SMART feature set is not supported the SATL shall return a CHECK CONDITION status with SENSE KEY set to ILLEGAL REQUEST and ADDITIONAL SENSE CODE set to INVALID FIELD IN CDB. If the ATA SMART feature set is supported the SATL shall determine if the ATA SMART feature set is enabled or disabled from the ATA IDENTIFY DEVICE data word 85, bit 0. If the ATA SMART feature set is disabled the SATL shall return a CHECK CONDITION status with SENSE KEY set to ABORTED COMMAND and ADDITIONAL SENSE CODE set to ATA DEVICE FEATURE NOT ENABLED. If the ATA SMART feature set is enabled the SATL shall return the translated Informational Exceptions log page to the application client (see 10.2.3).
all others	Unspecified (see 3.4.3)

T 8.2.2
Table 10

Delete values

Status
risheffi Completed 6/5/2006 12:07:52 PM

Sequence number: 7
Author: HPQ[RElliott]
Subject: Cross-Out
Date: 2/1/2006 3:33:57 PM

T 8.2.2
Table 10

Delete values

Status
risheffi Completed 6/5/2006 12:08:07 PM

Sequence number: 8
Author: LSI[OParry]
Subject: Cross-Out
Date: 4/11/2006 4:57:22 PM

T 8.2.3 PAGE CODE field
Table 11 - PAGE CODE field values

The text in Table 11, for codes 2Fh and 10h is not necessary because of the detailed description already given in table 76 in determining supported pages.

REASON: The detailed description in table 76 is there to define the conditions for whether the Self-Test Results log page is listed in the Supported Log Pages log page. This row in Table 11 describes the behavior when the Self-Test Results log page itself is requested. In both cases it is necessary to determine if the ATA device supports the corresponding function. There could be a common subclause to describe the heuristic for making that determination and then refer to it both from table 11 and table 76, but that would force the reader to bounce around. The editor's opinion is that the text is brief enough that duplicating it is not a problem.

Status
risheffi Rejected 4/11/2006 4:57:26 PM

Sequence number: 9
Author: DELL[KMarks]
Subject: Highlight
Date: 2/2/2006 10:35:54 AM

T Table 11 — PAGE CODE field values
Code value 10h

"Self-Test Results log page: The SATL shall determine if the ATA SMART self-test is supported from the ATA IDENTIFY DEVICE data word 84, bit 1. If the ATA SMART selftest is not supported the SATL shall return a CHECK CONDITION status with SENSE KEY set to ILLEGAL REQUEST and ADDITIONAL SENSE CODE set to INVALID FIELD IN CDB. If the ATA SMART self-test is supported the SATL shall return the translated Self-Test Results log page to the application client (see 10.2.4)."

to

"Self-Test Results log page: The SATL shall determine if the ATA SMART self-test is supported from the ATA IDENTIFY DEVICE data word 84, bit 1. If the ATA SMART self-test is not supported (i.e., word 84, bit 1 is set to zero) the SATL shall return a CHECK CONDITION status with the sense key set to ILLEGAL REQUEST and additional sense code set to INVALID FIELD IN CDB. If the ATA SMART self-test is supported (i.e., word 84, bit 1 is set to one) the SATL shall return the translated Self-Test Results log page to the application client (see 10.2.4)."

Status
risheffi Completed 6/5/2006 12:11:55 PM

Sequence number: 10
Author: HPQ[WBellamy]
Subject: Highlight
Date: 2/19/2006 8:28:29 PM

T

Status
risheffi Cancelled 4/11/2006 4:57:52 PM

Sequence number: 11

Comments from page 50 continued on next page

The SATL shall return SMART data log page data. If the PAGE CODE is another value, the SATL shall terminate the command with CHECK CONDITION status with the sense key set to ILLEGAL REQUEST and the additional sense code set to INVALID FIELD IN CDB.

8.2.2 PC (page control) field

The SATL shall implement this field as defined in SPC-3. The SATL interpretation and support of the page control values is shown in table 10.

Table 10 — PC field values

Code	Description
00b	Threshold values: unspecified (see 3.4.3)
01b	Cumulative values: supported
10b	Default threshold values: unspecified (see 3.4.3)
11b	Default cumulative values: unspecified (see 3.4.3)

8.2.3 PAGE CODE field

The SATL shall support this field as defined in SPC-3. The SATL emulation for support of the PAGE CODE field is provided in table 11.

Table 11 — PAGE CODE field values

Code	Description
00h	Supported Log Pages log page: The SATL shall implement this page by returning a list of supported log pages (see 10.2.5).
10h	Self Test Results log page: The SATL shall determine if the ATA SMART self test is supported from the ATA IDENTIFY DEVICE data word 84, bit 1. If the ATA SMART selftest is not supported the SATL shall return a CHECK CONDITION status with SENSE KEY set to ILLEGAL REQUEST and ADDITIONAL SENSE CODE set to INVALID FIELD IN CDB. If the ATA SMART self test is supported the SATL shall return the translated Self Test Results log page to the application client (see 10.2.4).
2Fh	Informational Exceptions log page: The SATL shall determine if the ATA SMART feature set is supported from the ATA IDENTIFY DEVICE data word 82, bit 0. If the ATA SMART feature set is not supported the SATL shall return a CHECK CONDITION status with SENSE KEY set to ILLEGAL REQUEST and ADDITIONAL SENSE CODE set to INVALID FIELD IN CDB. If the ATA SMART feature set is supported the SATL shall determine if the ATA SMART feature set is enabled or disabled from the ATA IDENTIFY DEVICE data word 85, bit 0. If the ATA SMART feature set is disabled the SATL shall return a CHECK CONDITION status with SENSE KEY set to ABORTED COMMAND and ADDITIONAL SENSE CODE set to ATA-DEVICE FEATURE NOT ENABLED. If the ATA SMART feature set is enabled the SATL shall return the translated Informational Exceptions log page to the application client (see 10.2.3).
all others	Unspecified (see 3.4.3)

Author: HPQ[WBellamy]

Subject: Note

Date: 2/19/2006 8:29:24 PM

"selftest" supposed to be "self-test"

Status

rlsheffi Completed 6/5/2006 12:12:07 PM

Sequence number: 12

Author: LSI[OParry]

Subject: Cross-Out

Date: 4/11/2006 4:59:46 PM

8.2.3 PAGE CODE field

Table 11 - PAGE CODE field values

The text in Table 11, for codes 2Fh and 10h is not necessary because of the detailed description already given in table 76 in determining supported pages.

REASON: The detailed description in table 76 is there to define the conditions for whether the Informational Exceptions log page is listed in the Supported Log Pages log page. This row in Table 11 describes the behavior when the Informational Exceptions log page itself is requested. In both cases it is necessary to determine if the ATA device supports the corresponding function. There could be a common subclause to describe the heuristic for making that determination and then refer to it both from table 11 and table 76, but that would force the reader to bounce around. The editor's opinion is that the text is brief enough that duplicating it is not a problem.

Status

rlsheffi Rejected 4/11/2006 5:05:55 PM

Sequence number: 13

Author: DELL[KMarks]

Subject: Highlight

Date: 2/2/2006 10:55:07 AM

Table 11 — PAGE CODE field values

Code value 2Fh

change

"Informational Exceptions log page: The SATL shall determine if the ATA SMART feature set is supported from the ATA IDENTIFY DEVICE data word 82, bit 0. If the ATA SMART feature set is not supported the SATL shall return a CHECK CONDITION status with SENSE KEY set to ILLEGAL REQUEST and ADDITIONAL SENSE CODE set to INVALID FIELD IN CDB. If the ATA SMART feature set is supported the SATL shall determine if the ATA SMART feature set is enabled or disabled from the ATA IDENTIFY DEVICE data word 85, bit 0. If the ATA SMART feature set is disabled the SATL shall return a CHECK CONDITION status with SENSE KEY set to ABORTED COMMAND and ADDITIONAL SENSE CODE set to ATA DEVICE FEATURE NOT ENABLED. If the ATA SMART feature set is enabled the SATL shall return the translated Informational Exceptions log page to the application client (see 10.2.3)."

to

"Informational Exceptions log page: The SATL shall determine if the ATA SMART feature set is supported from the ATA IDENTIFY DEVICE data word 82, bit 0. If the ATA SMART feature set is not supported (i.e., word 82, bit 0 is set to zero) the SATL shall return a CHECK CONDITION status with the sense key set to ILLEGAL REQUEST and additional sense code set to INVALID FIELD IN CDB. If the ATA SMART feature set is supported (i.e., word 82, bit 0 is set to one) the SATL shall determine if the ATA SMART feature set is enabled or disabled from the ATA IDENTIFY DEVICE data word 85, bit 0. If the ATA SMART feature set is disabled (i.e., word 85, bit 0 is set to zero) the SATL shall return a CHECK CONDITION status with the sense key set to ABORTED COMMAND and additional sense code set to ATA DEVICE FEATURE NOT ENABLED. If the ATA SMART feature set is enabled (i.e., word 85, bit 0 is set to one) the SATL shall return the translated Informational Exceptions log page to the application client (see 10.2.3)."

Status

rlsheffi Completed 6/5/2006 12:14:16 PM

8.3 MODE SELECT (6) command

1 3.1 MODE SELECT (6) command overview

2 The MODE SELECT (6) command provides a mechanism for application clients to change the operating
4 parameters of the 3 target or a logical unit. Parameters specified by the MODE SELECT (6) command may be
retrieved with the MODE SENSE (6) command. The application client should send a MODE SENSE (6)
command before issuing a MODE SELECT (6) command for the 5 same mode page, to determine the format,
length changeable field etc.



The Mode Page Policy VPD page (see 10.3) should be implemented. The MODE PAGE POLICY shall be set to
'Shared', and only one copy of 'current' mode page values shall maintained for all logical units of a target. After
a logical unit reset, the SATL shall set all mode page values to default values. See clause 10 for supported
mode pages.

8.3.2 MODE SELECT (6) CDB fields

The SATL shall support MODE SELECT (6) CDB fields as shown in Table 12.

Table 12 — MODE SELECT (6) command CDB fields

Field	Description or reference
OPERATION CODE	Some operational parameters in individual pages are provided via ATA. See clause 10 for specific requirements.
SP	Unspecified (see 3.4.3)
PF	The SATL shall not support 0b (indicating modes pages are vendor specific). The SATL shall support 1b (indicating all page formats correspond to SPC-3 and SBC-2 MODE PAGE formats). If this bit is set to 0b, the SATL shall terminate the command with CHECK CONDITION status with the sense key set to ILLEGAL REQUEST and the additional sense code set to INVALID FIELD IN CDB.
PARAMETER LIST LENGTH ^A	This field should be set to the length of the mode parameter list to be transferred from the application client.
CONTROL	6.4
^a The SATL shall recognize the differing PARAMETER LIST LENGTH field size in the MODE SELECT (10) command and the MODE SELECT (6) command.	

8.3.3 Mode parameter header

Table 13 shows the fields in the mode parameter header for MODE SELECT (6).

Table 13 — Mode parameter header (6) fields

Field	Description or reference
MODE DATA LENGTH	See SPC-3
MEDIUM TYPE	Unspecified (see 3.4.3)
DEVICE SPECIFIC PARAMETER	Unspecified (see 3.4.3)
BLOCK DESCRIPTOR LENGTH	See SPC-3. This value shall be obtained by multiplying the number of block descriptors by 8. The SATL shall support at most one mode parameter block descriptor, so this value should be set to 8 if a mode parameter block descriptor is provided.

Page: 51

Sequence number: 1
Author: IBM[GPenokie]
Subject: Underline
Date: 2/16/2006 1:39:36 PM
T 8.3.1 MODE SELECT (6) command overview

Status
risheffi Cancelled 4/11/2006 5:01:45 PM

Sequence number: 2
Author: MXO[MEvans]
Subject: Highlight
Date: 4/12/2006 7:54:38 AM

T 8.3.1 MODE SELECT (6) command overview, first paragraph: change to, "The MODE SELECT(6) command (see SPC-3) provides a means for an application client to specify medium, logical unit, or peripheral device parameters to a device server in the SATL. Device servers that implement the MODE SELECT (6) command shall also implement the MODE SENSE (6) command. Application clients should issue MODE SENSE (6) prior to each MODE SELECT (6) to determine supported mode pages, page lengths, and other parameters." These are the words in SPC-3 with the addition of "(see SPC-3)" and "in the SATL".
RESOLUTION (as suggested, but adding "command" where appropriate): "The MODE SELECT(6) command (see SPC-3) provides a means for an application client to specify medium, logical unit, or peripheral device parameters to a device server in the SATL. Device servers that implement the MODE SELECT (6) command shall also implement the MODE SENSE (6) command. Application clients should issue a MODE SENSE (6) command prior to each MODE SELECT (6) command to determine supported mode pages, page lengths, and other parameters."

Status
risheffi Completed 6/5/2006 12:21:18 PM

Sequence number: 3
Author: HPQ[RElliott]
Subject: Highlight
Date: 6/5/2006 12:21:52 PM

T 8.3.1
fix bare "target"
RESOLUTION: see MXO comment (discusses "device server").

Status
risheffi Completed 6/24/2006 8:30:59 AM

Sequence number: 4
Author: DELL[KMarks]
Subject: Highlight
Date: 4/12/2006 8:01:11 AM

T 8.3.1 MODE SELECT (6) command overview
1st Paragraph, 1st Sentence
change
"...parameters of the target or a logical unit."
to
"...parameters of the target device or logical unit(s)."
REASON: The command is processed by a device server which is in "a" logical unit. MXO comment (accepted) revises text for consistency with SPC-3.

Status
risheffi Rejected 4/12/2006 7:59:30 AM

Sequence number: 5
Author: DELL[KMarks]
Subject: Highlight
Date: 4/12/2006 8:34:34 AM

T 8.3.1 MODE SELECT (6) command overview
1st Paragraph, 3rd Sentence
change
"same mode page, to determine the format, length changeable field etc."
to
"same mode page, to determine the format, length, changeable field, etc."
RESOLUTION: See MXO comment.

8.3 MODE SELECT (6) command

8.3.1 MODE SELECT (6) command overview

The MODE SELECT (6) command provides a mechanism for application clients to change the operating parameters of the target or a logical unit. Parameters specified by the MODE SELECT (6) command may be retrieved with the MODE SENSE (6) command. The application client should send a MODE SENSE (6) command before issuing a MODE SELECT (6) command for the same mode page, to determine the format, length changeable field etc.

The Mode Page Policy VPD page (see 10.3) should be implemented. The MODE PAGE POLICY shall be set to 'Shared', and only one copy of current mode page values shall maintained for all logical units of a target. After a logical unit reset, the SATL shall set all mode page values to default values. See clause 10 for supported mode pages.

8.3.2 MODE SELECT (6) CDB fields

The SATL shall support MODE SELECT (6) CDB fields as shown in Table 12.

Table 12 — MODE SELECT (6) command CDB fields

Field	Description or reference
OPERATION CODE	Some operational parameters in individual pages are provided via ATA. See clause 10 for specific requirements.
SP	Unspecified (see 3.4.3)
PF	The SATL shall not support 0b (indicating modes pages are vendor specific). The SATL shall support 1b (indicating all page formats correspond to SPC-3 and SBC-2 MODE PAGE formats). If this bit is set to 0b, the SATL shall terminate the command with CHECK CONDITION status with the sense key set to ILLEGAL REQUEST and the additional sense code set to INVALID FIELD IN CDB.
PARAMETER LIST LENGTH ^A	This field should be set to the length of the mode parameter list to be transferred from the application client.
CONTROL	6.4
^a The SATL shall recognize the differing PARAMETER LIST LENGTH field size in the MODE SELECT (10) command and the MODE SELECT (6) command.	

8.3.3 Mode parameter header

Table 13 shows the fields in the mode parameter header for MODE SELECT (6).

Table 13 — Mode parameter header (6) fields

Field	Description or reference
MODE DATA LENGTH	See SPC-3
MEDIUM TYPE	Unspecified (see 3.4.3)
DEVICE SPECIFIC PARAMETER	Unspecified (see 3.4.3)
BLOCK DESCRIPTOR LENGTH	See SPC-3. This value shall be obtained by multiplying the number of block descriptors by 8. The SATL shall support at most one mode parameter block descriptor, so this value should be set to 8 if a mode parameter block descriptor is provided.

Status
risheffi Completed 6/5/2006 12:22:09 PM

Sequence number: 6
Author: LSI[OParry]
Subject: Highlight
Date: 6/5/2006 12:24:43 PM

T 8.3.1 MODE SELECT (6) command overview

There is a reference to the "Mode Page Policy VPD page (see 10.3)". However, 10.3 does not mention this page.
RESOLUTION: see 06-209

Status
risheffi Completed 6/5/2006 1:52:18 PM

Sequence number: 7
Author: DELL[KMarks]
Subject: Highlight
Date: 6/5/2006 1:55:04 PM

T 8.3.1 MODE SELECT (6) command overview
2nd Paragraph
change

"The Mode Page Policy VPD page (see 10.3) should be implemented. The MODE PAGE POLICY shall be set to 'Shared', and only one copy of 'current' mode page values shall maintained for all logical units of a target. After a logical unit reset, the SATL shall set all mode page values to default values. See clause 10 for supported mode pages."

to

"The Mode Page Policy VPD page (see 10.3) should be implemented. If implemented, the MODE PAGE POLICY field in each mode page policy descriptor shall be set to 00b (Shared) for each mode page and only one copy of mode page values shall be maintained for all logical units within a target device (.i.e., the MLUS bit is set to one in each mode page policy descriptor). After a logical unit reset, the SATL shall revert to saved values if supported or default values if saved values are not supported. See 10.1 for supported mode pages."

Because the SP is unspecified, if the SP is supported, then mode pages should go to saved values after a LUR. Also see comment in section 10.1

RESOLUTION: See 06-209. This paragraph in 8.3.1 will read:

"The Mode Page Policy VPD page should be implemented (see 10.3). After a logical unit reset, the SATL shall revert to saved or default values."

A subclause under 10.3 defining the Mode Page Policy VPD page will be added.

Status
risheffi Completed 6/5/2006 1:55:07 PM

Sequence number: 8
Author: IBM[GPenokie]
Subject: Comment on Text
Date: 6/5/2006 1:56:49 PM

T 2nd paragraph

This << The MODE PAGE POLICY shall be set to 'Shared', and only one copy of 'current' mode page values shall maintained for all logical units of a target. >> should be << The MODE PAGE POLICY shall be set to shared, and only one copy of current mode page values shall maintained for all logical units in a target device. >>. There are four changes 2 are removing the single quotes as those are defined by your conventions to be ASCII strings.

RESOLUTION: see 06-209.

Status
risheffi Completed 6/5/2006 1:56:52 PM

Sequence number: 9
Author: HPQ[RElliott]
Subject: Highlight
Date: 6/5/2006 1:57:39 PM

T 8.3.1

Comments from page 51 continued on next page

8.3 MODE SELECT (6) command

8.3.1 MODE SELECT (6) command overview

The MODE SELECT (6) command provides a mechanism for application clients to change the operating parameters of the target or a logical unit. Parameters specified by the MODE SELECT (6) command may be retrieved with the MODE SENSE (6) command. The application client should send a MODE SENSE (6) command before issuing a MODE SELECT (6) command for the same mode page, to determine the format, length changeable field etc.

The Mode Page Policy VPD page (see 10.3) should be implemented. The MODE PAGE POLICY shall be set to 'shared', and only one copy of 'current' mode page values shall maintained for all logical units of a target. After a logical unit reset, the SATL shall set all mode page values to default values. See clause 10 for supported mode pages.

11

8.3.2 MODE SELECT (6) CDB fields

The SATL shall support MODE SELECT (6) CDB fields as shown in Table 12.

13

Table 12 — MODE SELECT (6) command CDB fields

Field	Description or reference
OPERATION CODE	Some operational parameters in individual pages are provided via ATA. See clause 10 for specific requirements.
SP	Unspecified (see 3.4.3)
PF	The SATL shall not support 0b (indicating modes pages are vendor specific). The SATL shall support 1b (indicating all page formats correspond to SPC-3 and SBC-2 MODE PAGE formats). If this bit is set to 0b, the SATL shall terminate the command with CHECK CONDITION status with the sense key set to ILLEGAL REQUEST and the additional sense code set to INVALID FIELD IN CDB.
PARAMETER LIST LENGTH ^A	This field should be set to the length of the mode parameter list to be transferred from the application client.
CONTROL	6.4
^a The SATL shall recognize the differing PARAMETER LIST LENGTH field size in the MODE SELECT (10) command and the MODE SELECT (6) command.	

8.3.3 Mode parameter header

Table 13 shows the fields in the mode parameter header for MODE SELECT (6).

Table 13 — Mode parameter header (6) fields

Field	Description or reference
MODE DATA LENGTH	See SPC-3
MEDIUM TYPE	Unspecified (see 3.4.3)
DEVICE SPECIFIC PARAMETER	Unspecified (see 3.4.3)
BLOCK DESCRIPTOR LENGTH	See SPC-3. This value shall be obtained by multiplying the number of block descriptors by 8. The SATL shall support at most one mode parameter block descriptor, so this value should be set to 8 if a mode parameter block descriptor is provided.

remove quotes from 'current'
RESOLUTION: see 06-209.

Status
rlsheffi Completed 6/5/2006 1:57:42 PM

Sequence number: 10
Author: HPQ[RElliott]
Subject: Highlight
Date: 6/5/2006 1:58:06 PM
 8.3.1

Change 'Shared' to shared (no quotes or capitals)
RESOLUTION: see 06-209.

Status
rlsheffi Completed 6/5/2006 1:58:08 PM

Sequence number: 11
Author: HPQ[RElliott]
Subject: Note
Date: 6/5/2006 1:58:34 PM
 8.3.1

SAT shouldn't comment on mode pages across logical units. Restrict discussion to within one logical unit.

RESOLUTION: see 06-209.

Status
rlsheffi Completed 6/5/2006 1:58:37 PM

Sequence number: 12
Author: IBM[GPenokie]
Subject: Underline
Date: 2/16/2006 1:41:58 PM
 8.3.2 MODE SELECT (6) CDB fields

Status
rlsheffi Cancelled 4/12/2006 10:08:57 AM

Sequence number: 13
Author: IBM[GPenokie]
Subject: Oval
Date: 6/24/2006 4:27:45 AM
 Global

The capitalization of the references to tables is inconsistent. It should only be capitalized when it is the first word of a sentence.

Status
rlsheffi Completed 6/5/2006 4:05:19 PM

Sequence number: 14
Author: DELL[KMarks]
Subject: Highlight
Date: 4/13/2006 8:41:07 AM
 **Table 12 — MODE SELECT (6) command CDB fields**
Row: PF - 1st three sentences

"The SATL shall not support 0b (indicating modes pages are vendor specific). The SATL shall support 1b (indicating all page formats correspond to SPC-3 and SBC-2 MODE PAGE formats). If this bit is set to 0b, the"

to

"The SATL shall set this bit to one. If this bit is set to zero, the..."

REASON: This field is in a structure the SATL receives from the application client, and so the SATL is unable to set this bit to one.

Status
rlsheffi Rejected 4/13/2006 8:39:34 AM

Sequence number: 15
Author: IBM[GPenokie]
Subject: Comment on Text

Comments from page 51 continued on next page

8.3 MODE SELECT (6) command

8.3.1 MODE SELECT (6) command overview

The MODE SELECT (6) command provides a mechanism for application clients to change the operating parameters of the target or a logical unit. Parameters specified by the MODE SELECT (6) command may be retrieved with the MODE SENSE (6) command. The application client should send a MODE SENSE (6) command before issuing a MODE SELECT (6) command for the same mode page, to determine the format, length changeable field etc.



The Mode Page Policy VPD page (see 10.3) should be implemented. The MODE PAGE POLICY shall be set to 'Shared', and only one copy of 'current' mode page values shall maintained for all logical units of a target. After a logical unit reset, the SATL shall set all mode page values to default values. See clause 10 for supported mode pages.

8.3.2 MODE SELECT (6) CDB fields

The SATL shall support MODE SELECT (6) CDB fields as shown in Table 12.

Table 12 — MODE SELECT (6) command CDB fields

Field	Description or reference
OPERATION CODE	Some operational parameters in individual pages are provided via ATA. See clause 10 for specific requirements.
SP	Unspecified (see 3.4.3)
PF	The SATL shall not support 0b (indicating modes pages are vendor specific). The SATL shall support 1b (indicating all page formats correspond to SPC-3 and SBC-2 MODE PAGE formats). If this bit is set to 0b, the SATL shall terminate the command with CHECK CONDITION status with the sense key set to ILLEGAL REQUEST and the additional sense code set to INVALID FIELD IN CDB.
PARAMETER LIST LENGTH	This field should be set to the length of the mode parameter list to be transferred from the application client.
CONTROL	6.4
<p>^a The SATL shall recognize the differing PARAMETER LIST LENGTH field size in the MODE SELECT (10) command and the MODE SELECT (6) command.</p>	

8.3.3 Mode parameter header

Table 13 shows the fields in the mode parameter header for MODE SELECT (6).

Table 13 — Mode parameter header (6) fields

Field	Description or reference
MODE DATA LENGTH	See SPC-3
MEDIUM TYPE	Unspecified (see 3.4.3)
DEVICE SPECIFIC PARAMETER	Unspecified (see 3.4.3)
BLOCK DESCRIPTOR LENGTH	See SPC-3. This value shall be obtained by multiplying the number of block descriptors by 8. The SATL shall support at most one mode parameter block descriptor, so this value should be set to 8 if a mode parameter block descriptor is provided.

Date: 6/5/2006 4:12:04 PM

Table 12 - PF row

This << The SATL shall not support 0b (indicating modes pages are vendor specific). The SATL shall support 1b (indicating all page formats correspond to SPC-3 and SBC-2 MODE PAGE formats). >> should be << The SATL shall not support 0b (i.e., indicates modes pages are vendor specific). The SATL shall support 1b (i.e., indicates all page formats correspond to SPC-3 and SBC-2 MODE PAGE formats). >>.

RESOLUTION: s/b

"If this bit is set to zero (i.e., specifies that mode pages are vendor specific), then the SATL shall terminate the command with CHECK CONDITION status with the sense key set to ILLEGAL REQUEST and the additional sense code set to INVALID FIELD IN CDB. The SATL shall support this bit being set to one (i.e., specifies that all mode page formats correspond to SPC-3 and SBC-2 mode page formats)."

Status

risheffi Completed 6/5/2006 4:12:50 PM

Sequence number: 16

Author: MXO[MEvans]

Subject: Highlight

Date: 6/5/2006 4:12:25 PM

Table 12, description for the PF field: change to, "If this bit is set to zero (i.e., indicating that mode pages are vendor specific), then the SATL shall terminate the command with CHECK CONDITION status with the sense key set to ILLEGAL REQUEST and the additional sense code set to INVALID FIELD IN CDB. The SATL shall support this bit being set to one (i.e., specifying that all mode page formats correspond to SPC-3 and SBC-2 mode page formats)."

RESOLUTION: s/b

"If this bit is set to zero (i.e., specifies that mode pages are vendor specific), then the SATL shall terminate the command with CHECK CONDITION status with the sense key set to ILLEGAL REQUEST and the additional sense code set to INVALID FIELD IN CDB. The SATL shall support this bit being set to one (i.e., specifies that all mode page formats correspond to SPC-3 and SBC-2 mode page formats)."

Status

risheffi Completed 6/5/2006 4:12:37 PM

Sequence number: 17

Author: HPQ[RElliott]

Subject: Highlight

Date: 4/13/2006 8:47:56 AM

T8.3.2

table 12

remove ^ (or change to superscript a)

RESOLUTION: Delete table footnote A.

Status

risheffi Completed 6/5/2006 4:15:18 PM

Sequence number: 18

Author: ENDL[RWeber]

Date: 4/13/2006 8:47:47 AM

Table 12, row 4

The table footnote reference for a is capitalized. It should be lower case.

RESOLUTION: Delete table footnote A.

Status

risheffi Completed 6/5/2006 4:15:18 PM

Sequence number: 19

Author: DELL[KMarks]

Subject: Highlight

Date: 4/13/2006 8:47:37 AM

Table 12 — MODE SELECT (6) command CDB fields

Row: PARAMETER LIST LENGTHA

make superscript "A" lower case "a", if the footnote is kept, see next comment.

RESOLUTION: Delete table footnote A.

Status

Comments from page 51 continued on next page

8.3 MODE SELECT (6) command

8.3.1 MODE SELECT (6) command overview

The MODE SELECT (6) command provides a mechanism for application clients to change the operating parameters of the target or a logical unit. Parameters specified by the MODE SELECT (6) command may be retrieved with the MODE SENSE (6) command. The application client should send a MODE SENSE (6) command before issuing a MODE SELECT (6) command for the same mode page, to determine the format, length changeable field etc.



The Mode Page Policy VPD page (see 10.3) should be implemented. The MODE PAGE POLICY shall be set to 'Shared', and only one copy of 'current' mode page values shall maintained for all logical units of a target. After a logical unit reset, the SATL shall set all mode page values to default values. See clause 10 for supported mode pages.

8.3.2 MODE SELECT (6) CDB fields

The SATL shall support MODE SELECT (6) CDB fields as shown in Table 12.

Table 12 — MODE SELECT (6) command CDB fields

Field	Description or reference
OPERATION CODE	Some operational parameters in individual pages are provided via ATA. See clause 10 for specific requirements.
SP	Unspecified (see 3.4.3)
PF	The SATL shall not support 0b (indicating modes pages are vendor specific). The SATL shall support 1b (indicating all page formats correspond to SPC-3 and SBC-2 MODE PAGE formats). If this bit is set to 0b, the SATL shall terminate the command with CHECK CONDITION status with the sense key set to ILLEGAL REQUEST and the additional sense code set to INVALID FIELD IN CDB.
PARAMETER LIST LENGTH ^A	This field should be set to the length of the mode parameter list to be transferred from the application client.
CONTROL	6.4
²¹ The SATL shall recognize the differing PARAMETER LIST LENGTH field size in the MODE SELECT (10) command and the MODE SELECT (6) command.	

²² 8.3 Mode parameter header

Table 13 shows the fields in the mode parameter header for MODE SELECT (6).

Table 13 — Mode parameter header (6) fields

Field	Description or reference
MODE DATA LENGTH	²³ See SPC-3
MEDIUM TYPE	²⁴ specified (see 3.4.3)
DEVICE SPECIFIC PARAMETER	Unspecified (see 3.4.3)
BLOCK DESCRIPTOR LENGTH	See SPC-3. This value shall be obtained by multiplying the number of block descriptors by 8. The SATL shall support at most one mode parameter block descriptor, so this value should be set to 8 if a mode parameter block descriptor is provided.

risheffi Completed 6/5/2006 4:15:18 PM

Sequence number: 20
Author: DELL[KMarks]
Subject: Highlight
Date: 4/13/2006 8:46:32 AM

T Table 12 — MODE SELECT (6) command CDB fields
Footnote a

I see no need for this footnote, the MODE SELECT (10) should reference this subclause for field translations, except say parameter list length is different. The note is confusing, as the SATL should be recognized? The CDB is a different format, more than just long PLL.

Remove

"a The SATL shall recognize the differing PARAMETER LIST LENGTH field size in the MODE SELECT (10) command and the MODE SELECT (6) command."

RESOLUTION: Remove table footnote a.

Status
risheffi Completed 6/5/2006 4:15:18 PM

Sequence number: 21
Author: MXO[MEvans]
Subject: Highlight
Date: 2/16/2006 11:17:52 AM

T Table 12: delete the footnote (i.e., "a The SATL shall recognize the differing PARAMETER LIST LENGTH field size in the MODE SELECT (10)"). The SATL shall also recognize the differing operation code in the MODE SELECT (10) command and the MODE SELECT (6) command, but this standard doesn't need to state that, either. Deleting this also deletes the capital "A" reference after PARAMETER LIST LENGTH above.

Status
risheffi Completed 6/5/2006 4:15:18 PM

Sequence number: 22
Author: IBM[GPenokie]
Subject: Underline
Date: 2/16/2006 1:44:30 PM

T 8.3.3 Mode parameter header

Status
risheffi Cancelled 4/13/2006 8:48:27 AM

Sequence number: 23
Author: DELL[KMarks]
Subject: Highlight
Date: 4/13/2006 9:28:17 AM

T Table 13 — Mode parameter header (6) fields
Row: MODE DATA LENGTH

change

"See SPC-3"

to

"Reserved (See SPC-3)"

RESOLUTION: "Reserved (see SPC-3)"

Status
risheffi Completed 6/5/2006 4:21:26 PM

Sequence number: 24
Author: DELL[KMarks]
Subject: Highlight
Date: 4/13/2006 9:35:51 AM

T Table 13 — Mode parameter header (6) fields
Row: MEDIUM TYPE

Is there some reason this is unspecified, but in the header (10) it says should be 00h?

Change

"Unspecified (see 3.4.3)"

Comments from page 51 continued on next page

8.3 MODE SELECT (6) command

8.3.1 MODE SELECT (6) command overview

The MODE SELECT (6) command provides a mechanism for application clients to change the operating parameters of the target or a logical unit. Parameters specified by the MODE SELECT (6) command may be retrieved with the MODE SENSE (6) command. The application client should send a MODE SENSE (6) command before issuing a MODE SELECT (6) command for the same mode page, to determine the format, length changeable field etc.



The Mode Page Policy VPD page (see 10.3) should be implemented. The MODE PAGE POLICY shall be set to 'Shared', and only one copy of 'current' mode page values shall maintained for all logical units of a target. After a logical unit reset, the SATL shall set all mode page values to default values. See clause 10 for supported mode pages.

8.3.2 MODE SELECT (6) CDB fields

The SATL shall support MODE SELECT (6) CDB fields as shown in Table 12.

Table 12 — MODE SELECT (6) command CDB fields

Field	Description or reference
OPERATION CODE	Some operational parameters in individual pages are provided via ATA. See clause 10 for specific requirements.
SP	Unspecified (see 3.4.3)
PF	The SATL shall not support 0b (indicating modes pages are vendor specific). The SATL shall support 1b (indicating all page formats correspond to SPC-3 and SBC-2 MODE PAGE formats). If this bit is set to 0b, the SATL shall terminate the command with CHECK CONDITION status with the sense key set to ILLEGAL REQUEST and the additional sense code set to INVALID FIELD IN CDB.
PARAMETER LIST LENGTH ^A	This field should be set to the length of the mode parameter list to be transferred from the application client.
CONTROL	6.4
^a The SATL shall recognize the differing PARAMETER LIST LENGTH field size in the MODE SELECT (10) command and the MODE SELECT (6) command.	

8.3.3 Mode parameter header

Table 13 shows the fields in the mode parameter header for MODE SELECT (6).

Table 13 — Mode parameter header (6) fields

Field	Description or reference
MODE DATA LENGTH	See SPC-3
MEDIUM TYPE	Unspecified (see 3.4.3)
DEVICE SPECIFIC PARAMETER	Unspecified (see 3.4.3)
BLOCK DESCRIPTOR LENGTH	See SPC-3. This value shall be obtained by multiplying the number of block descriptors by 8. The SATL shall support at most one mode parameter block descriptor, so this value should be set to 8 if a mode parameter block descriptor is provided.

to
"Unspecified (see 3.4.3) For direct access block devices, this field shall be set to 00h."

RESOLUTION:

Change

"Unspecified (see 3.4.3)"

to

"This field should be set to 00h. If the "MEDIUM TYPE field is set to a value other than 00h, the SATL shall terminate the command with CHECK CONDITION status, with the sense key set to ILLEGAL REQUEST, and the additional sense code set to INVALID FIELD IN PARAMETER LIST."

Status

rlsheffi Completed 6/5/2006 4:23:16 PM

Sequence number: 25

Author: DELL[KMarks]

Subject: Highlight

Date: 6/5/2006 4:25:49 PM

T Table 13 — Mode parameter header (6) fields

Row: BLOCK DESCRIPTOR LENGTH

"See SPC-3. This value shall be obtained by multiplying the number of block descriptors by 8. The SATL shall support at most one mode parameter block descriptor, so this value should be set to 8 if a mode parameter block descriptor is provided."

to

"See SPC-3. This value is obtained by multiplying the number of block descriptors by 8. The SATL shall support zero or one mode parameter block descriptors."

RESOLUTION: Change to,

"This value is obtained by multiplying the number of block descriptors by eight (see SPC-3). The SATL shall support zero or one mode parameter block descriptors."

Status

rlsheffi Completed 6/5/2006 4:25:53 PM

Sequence number: 26

Author: IBM[GPenokie]

Subject: Comment on Text

Date: 4/13/2006 9:38:20 AM

T table 13 - last row

The << 8 >> should be << eight >> in two places.

RESOLUTION: See DELL comment.

Status

rlsheffi Completed 6/5/2006 4:26:02 PM

3.3.1 Mode parameter block descriptor fields

The SATL may support the direct-access mode parameter block descriptor. The SATL may support the long LBA mode parameter block descriptor. The SATL shall not support the general mode parameter block descriptor. The DENSITY CODE (see SPC-3) is reserved for SATL devices. Table 14 shows the fields in the mode parameter block descriptors supported by the SATL.

Table 14 — Mode parameter block descriptor fields

Field	Description or reference
NUMBER OF BLOCKS	The SATL shall not support changing its capacity by changing the NUMBER OF BLOCKS field using the MODE SELECT command, and the value in this field is ignored. ^a
BLOCK LENGTH	The SATL shall return the same block length for the entire LUN. For direct access devices, the SATL shall set this field to 200h.
^a This is because the ATA device provides no method to modify the capacity	

8.4 MODE SELECT (10) command

8.4.1 MODE SELECT (10) command overview

The SATL shall implement the MODE SELECT (10) command as described in 8.3, except that the SATL shall recognize the longer PARAMETER LIST LENGTH field in the CDB, and shall recognize the LONGLBA bit in the mode parameter header (10).

8.4.2 Mode parameter header (10)

Table 13 shows the fields in the mode parameter header (10).

Table 15 — Mode parameter header (10) fields

Field	Description or reference
MODE DATA LENGTH	8.3.3
MEDIUM TYPE	For direct access devices, this field should be set to 00h
DEVICE SPECIFIC PARAMETER	8.3.3
LONGLBA	Describes the length of the block descriptors. a) If set to 0b, the mode parameter block descriptor is 8 bytes long. b) If set to 1b, the mode parameter block descriptor is 16 bytes long.
BLOCK DESCRIPTOR LENGTH	This field indicates the length of the mode parameter block descriptor. This value shall be obtained by multiplying the number of block descriptors by 8 if LONGLBA bit is set to 0, or by 16 if LONGLBA bit is set to 1. No more than one mode parameter block descriptor shall be supported, so this value should be set to 8 or 16. (see 8.3.3)

Sequence number: 1
Author: IBM[GPenokie]
Subject: Underline
Date: 2/16/2006 1:29:51 PM
T 8.3.3.1 Mode parameter block descriptor fields

Status
rsheffi Cancelled 4/13/2006 9:50:53 AM

Sequence number: 2
Author: DELL[KMarks]
Subject: Highlight
Date: 6/24/2006 3:16:10 PM
T 8.3.3.1 Mode parameter block descriptor fields
1st Paragraph

"The SATL may support the direct-access mode parameter block descriptor. The SATL may support the long LBA mode parameter block descriptor. The SATL shall not support the general mode parameter block descriptor. The DENSITY CODE (see SPC-3) is reserved for SATL devices. Table 14 shows the fields in the mode parameter block descriptors supported by the SATL."

to

"The SATL may support the direct-access short LBA mode parameter block descriptor or the long LBA mode parameter block descriptor. Table 14 shows the fields in the short LBA mode parameter block descriptor and long LBA block descriptor supported by the SATL."

Text says SATL shall not support the general mode parameter block descriptor, but this descriptor is defined in the MODE SENSE section?
RESOLUTION: see 06-216

Status
rsheffi Completed 7/23/2006 11:08:30 AM

Sequence number: 3
Author: SIERLGC[BMartin]
Subject: Note
Date: 7/23/2006 11:15:27 AM
 Page 32, Table 14

NUMBER OF BLOCKS - While the ATA device cannot modify the capacity, there is no reason that the SATL cannot modify what is reachable on the medium, and it should be allowed for this parameter to be used to set this value.

RESOLUTION: See 06-216. Change description to "Unspecified (see 3.4.3)"

Status
rsheffi Completed 7/23/2006 11:15:32 AM

Sequence number: 4
Author: IBM[GPenokie]
Subject: Comment on Text
Date: 7/23/2006 11:13:00 AM
T table 14 - last row

The statement << block length for the entire LUN. >> should be << block length for the entire logical unit. >>

RESOLUTION: see 06-216.

Status
rsheffi Completed 7/23/2006 11:13:04 AM

Sequence number: 5
Author: DELL[KMarks]
Subject: Highlight
Date: 7/23/2006 11:09:51 AM
T Table 14 — Mode parameter block descriptor fields
Row: BLOCK LENGTH

change

"The SATL shall return the same block length for the entire LUN. For direct access devices, the SATL shall set this field to 200h."

8.3.3.1 Mode parameter block descriptor fields

The SATL may support the direct-access mode parameter block descriptor. The SATL may support the long LBA mode parameter block descriptor. The SATL shall not support the general mode parameter block descriptor. The DENSITY CODE (see SPC-3) is reserved for SATL devices. Table 14 shows the fields in the mode parameter block descriptors supported by the SATL.

Table 14 — Mode parameter block descriptor fields

Field	Description or reference
NUMBER OF BLOCKS	The SATL shall not support changing its capacity by changing the NUMBER OF BLOCKS field using the MODE SELECT command, and the value in this field is ignored. ^a
BLOCK LENGTH	The SATL shall return the same block length for the entire LUN. For direct access devices, the SATL shall set this field to 200h.
^a This is because the ATA device provides no method to modify the capacity.	

8.4 MODE SELECT (10) command

8.4.1 MODE SELECT (10) command overview

The SATL shall implement the MODE SELECT (10) command as described in 8.3, except that the SATL shall recognize the longer PARAMETER LIST LENGTH field in the CDB, and shall recognize the LONGLBA bit in the mode parameter header (10).

8.4.2 Mode parameter header (10)

Table 13 shows the fields in the mode parameter header (10).

Table 15 — Mode parameter header (10) fields

Field	Description or reference
MODE DATA LENGTH	8.3.3
MEDIUM TYPE	For direct access devices, this field should be set to 00h
DEVICE SPECIFIC PARAMETER	8.3.3
LONGLBA	Describes the length of the block descriptors. a) If set to 0b, the mode parameter block descriptor is 8 bytes long. b) If set to 1b, the mode parameter block descriptor is 16 bytes long.
BLOCK DESCRIPTOR LENGTH	This field indicates the length of the mode parameter block descriptor. This value shall be obtained by multiplying the number of block descriptors by 8 if LONGLBA bit is set to 0, or by 16 if LONGLBA bit is set to 1. No more than one mode parameter block descriptor shall be supported, so this value should be set to 8 or 16. (see 8.3.3)

to
"For direct access block devices, the SATL shall set this field to 200h (i.e., 512 bytes)."

RESOLUTION: Define both direct and indirect block mapping - see 06-216.

Status
risheffi Completed 7/23/2006 11:10:06 AM

Sequence number: 6
Author: ELX[KHirata]
Subject: Highlight
Date: 7/23/2006 11:11:24 AM

T Location: Page 32, Table 14, Block Length description.

Comment:
Shouldn't the Block Length be reported as per the sector size field in the IDENTIFY DEVICE data? (Defaulting to 512-bytes if the IDENTIFY DEVICE field isn't valid.) Why is this hard coded to 512 bytes?

Preferred resolution:
Clarification. If there is a good reason for this then I don't care.

RESOLUTION: Define both direct and indirect block mapping - See 06-216.

Status
risheffi Completed 7/23/2006 11:11:34 AM

Sequence number: 7
Author: DELL[KMarks]
Subject: Highlight
Date: 6/6/2006 2:27:27 PM

T **Table 14 — Mode parameter block descriptor fields footnote a is missing period**
Suggested resolution: see 06-216

Status
risheffi Completed 7/23/2006 11:07:41 AM

Sequence number: 8
Author: IBM[GPenokie]
Subject: Comment on Text
Date: 7/23/2006 11:14:06 AM

T table 14 - footnote
This << This is because the ATA device provides no method to modify the capacity >> should be << ATA devices provide no method to modify the capacity >>
RESOLUTION: Footnote deleted, but a new one added - see 06-216

Status
risheffi Completed 7/23/2006 11:14:13 AM

Sequence number: 9
Author: DELL[KMarks]
Subject: Highlight
Date: 2/3/2006 2:02:10 PM

T **8.4.1 MODE SELECT (10) command overview**
1st Paragraph, 1st Sentence
change

"The SATL shall implement the MODE SELECT (10) command as described in 8.3, except that the SATL shall recognize the longer PARAMETER LIST LENGTH field in the CDB, and shall recognize the LONGLBA bit in the mode parameter header (10)."

to
"The SATL shall implement the MODE SELECT (10) command using the translation described in 8.3"

The definition of the PLL does not change between (6) and (10), so why call it out. Additionally the LONGLBA bit translation is shown/described below.

Status
risheffi Completed 6/5/2006 4:45:33 PM

Sequence number: 10
Author: EDITOR[risheffi]

Comments from page 52 continued on next page

8.3.3.1 Mode parameter block descriptor fields

The SATL may support the direct-access mode parameter block descriptor. The SATL may support the long LBA mode parameter block descriptor. The SATL shall not support the general mode parameter block descriptor. The DENSITY CODE (see SPC-3) is reserved for SATL devices. Table 14 shows the fields in the mode parameter block descriptors supported by the SATL.

Table 14 — Mode parameter block descriptor fields

Field	Description or reference
NUMBER OF BLOCKS	The SATL shall not support changing its capacity by changing the NUMBER OF BLOCKS field using the MODE SELECT command, and the value in this field is ignored. ^a
BLOCK LENGTH	The SATL shall return the same block length for the entire LUN. For direct access devices, the SATL shall set this field to 200h.
^a This is because the ATA device provides no method to modify the capacity	

8.4 MODE SELECT (10) command

8.4.1 MODE SELECT (10) command overview

The SATL shall implement the MODE SELECT (10) command as described in 8.3, except that the SATL shall recognize the longer PARAMETER LIST LENGTH field in the CDB, and shall recognize the LONGLBA bit in the mode parameter header (10).

8.4.2 Mode parameter header (10)

Table 13 shows the fields in the mode parameter header (10).

Table 15 — Mode parameter header (10) fields

Field	Description or reference
MODE DATA LENGTH	8.3.3
MEDIUM TYPE	¹⁴ For direct access devices, this field should be set to 00h
DEVICE SPECIFIC PARAMETER	8.3.3
LONGLBA	¹⁵ describes the length of the block descriptors. a) If set to 0b, the mode parameter block descriptor is 8 bytes long. b) If set to 1b, the mode parameter block descriptor is 16 bytes long.
BLOCK DESCRIPTOR LENGTH	This field indicates the length of the mode parameter block descriptor. This value shall be obtained by multiplying the number of block descriptors by 8 if LONGLBA bit is set to 0, or by 16 if LONGLBA bit is set to 1. No more than one mode parameter block descriptor shall be supported, so this value should be set to 8 or 16. (see 8.3.3)

Subject: Highlight
Date: 7/24/2006 12:28:12 PM

T Make the description of the MODE SELECT (10) command consistent with the description of the MODE SENSE (10) command.

Replace the paragraph in the command overview with:

"The MODE SELECT (10) command (see SPC-3) provides a means for an application client to set parameters in the device server in a SATL. It is a complementary command to the MODE SENSE(10) command.

The SATL shall implement the MODE SELECT (10) command using the translation described in 8.3. Device servers that implement the MODE SELECT (10) command shall also implement the MODE SENSE (10) command. See 10.1 for supported mode pages."

Status
r/sheffi Completed 7/24/2006 12:28:26 PM

Sequence number: 11
Author: IBM[GPenokie]
Subject: Underline
Date: 2/16/2006 1:42:58 PM

T 8.4.2 Mode parameter header (10)

Status
r/sheffi Cancelled 4/13/2006 3:19:48 PM

Sequence number: 12
Author: IBM[GPenokie]
Subject: Comment on Text
Date: 4/13/2006 3:20:46 PM

T 8.4.2 Mode parameter header (10)

1st paragraph

This << Table 13 shows the fields in >> should be << Table 15 shows the fields in >>

Status
r/sheffi Completed 6/5/2006 4:46:34 PM

Sequence number: 13
Author: HPQ[RElliott]
Date: 2/3/2006 7:52:01 AM

T 8.4.2

Table 13 shows s/b 15

Status
r/sheffi Completed 6/5/2006 4:46:41 PM

Sequence number: 14
Author: DELL[KMarks]
Subject: Highlight
Date: 4/13/2006 3:24:37 PM

T Table 15 — Mode parameter header (10) fields

Row: MEDIUM TYPE
change

"For direct access devices, this field should be set to 00h"
to
"8.3.3"

see comment on mode parameter header (6) - MEDIUM TYPE

Status
r/sheffi Completed 6/5/2006 4:47:52 PM

Sequence number: 15
Author: DELL[KMarks]
Subject: Highlight
Date: 4/13/2006 3:26:36 PM

T Table 15 — Mode parameter header (10) fields

Row: LONGLBA

change

"Describes the length of the block descriptors.

a) If set to 0b, the mode parameter block descriptor is 8 bytes long.

b) If set to 1b, the mode parameter block descriptor is 16 bytes long."

to

Comments from page 52 continued on next page

8.3.3.1 Mode parameter block descriptor fields

The SATL may support the direct-access mode parameter block descriptor. The SATL may support the long LBA mode parameter block descriptor. The SATL shall not support the general mode parameter block descriptor. The DENSITY CODE (see SPC-3) is reserved for SATL devices. Table 14 shows the fields in the mode parameter block descriptors supported by the SATL.

Table 14 — Mode parameter block descriptor fields

Field	Description or reference
NUMBER OF BLOCKS	The SATL shall not support changing its capacity by changing the NUMBER OF BLOCKS field using the MODE SELECT command, and the value in this field is ignored. ^a
BLOCK LENGTH	The SATL shall return the same block length for the entire LUN. For direct access devices, the SATL shall set this field to 200h.
^a This is because the ATA device provides no method to modify the capacity	

8.4 MODE SELECT (10) command

8.4.1 MODE SELECT (10) command overview

The SATL shall implement the MODE SELECT (10) command as described in 8.3, except that the SATL shall recognize the longer PARAMETER LIST LENGTH field in the CDB, and shall recognize the LONGLBA bit in the mode parameter header (10).

8.4.2 Mode parameter header (10)

Table 13 shows the fields in the mode parameter header (10).

Table 15 — Mode parameter header (10) fields

Field	Description or reference
MODE DATA LENGTH	8.3.3
MEDIUM TYPE	For direct access devices, this field should be set to 00h
DEVICE SPECIFIC PARAMETER	8.3.3
LONGLBA	Describes the length of the block descriptors. a) If set to 0b, the mode parameter block descriptor is 8 bytes long. b) If set to 1b, the mode parameter block descriptor is 16 bytes long.
BLOCK DESCRIPTOR LENGTH	This field indicates the length of the mode parameter block descriptor. This value shall be obtained by multiplying the number of block descriptors by 8 if LONGLBA bit is set to 0, or by 16 if LONGLBA bit is set to 1. No more than one mode parameter block descriptor shall be supported, so this value should be set to 8 or 16. (see 8.3.3)

"Describes the length of the block descriptors:

- a) If set to zero, the mode parameter block descriptor is 8 bytes long; or
- b) If set to one, the mode parameter block descriptor is 16 bytes long."

RESOLUTION: change

"Describes the length of the block descriptors.

- a) If set to 0b, the mode parameter block descriptor is 8 bytes long.
- b) If set to 1b, the mode parameter block descriptor is 16 bytes long."

to

"Describes the length of the block descriptors:

- a) If set to zero, the mode parameter block descriptor is eight bytes long; or
- b) If set to one, the mode parameter block descriptor is 16 bytes long."

Status

risheffi Completed 6/5/2006 4:51:45 PM

Sequence number: 16

Author: IBM[GPenokie]

Subject: Comment on Text

Date: 4/13/2006 3:27:02 PM

Table 15 - LONGLBA row

This << descriptor is 8 bytes long. >> should be << descriptor is eight bytes long. >>

RESOLUTION: See DELL comment

Status

risheffi Completed 6/5/2006 4:52:07 PM

Sequence number: 17

Author: DELL[KMarks]

Subject: Highlight

Date: 4/13/2006 3:29:21 PM

Table 15 — Mode parameter header (10) fields

Row: BLOCK DESCRIPTOR LENGTH

change

"This field indicates the length of the mode parameter block descriptor. This value shall be obtained by multiplying the number of block descriptors by 8 if LONGLBA bit is set to 0, or by 16 if LONGLBA bit is set to 1. No more than one mode parameter block descriptor shall be supported, so this value should be set to 8 or 16. (see 8.3.3)"

to

"This field specifies the length of the mode parameter block descriptor. This value is obtained by multiplying the number of block descriptors by 8 if LONGLBA bit is set to zero or by 16 if LONGLBA bit is set to one. The SATL shall support zero or one mode parameter block descriptor."

Why should I see 8.3.3 for this field and the values can be 0,8 or 16.

RESOLUTION: change

"This field indicates the length of the mode parameter block descriptor. This value shall be obtained by multiplying the number of block descriptors by 8 if LONGLBA bit is set to 0, or by 16 if LONGLBA bit is set to 1. No more than one mode parameter block descriptor shall be supported, so this value should be set to 8 or 16. (see 8.3.3)"

to

"This field specifies the length of the mode parameter block descriptor. This value is obtained by multiplying the number of block descriptors by eight if LONGLBA bit is set to zero or by 16 if LONGLBA bit is set to one. The SATL shall support zero or one mode parameter block descriptors."

Status

risheffi Completed 6/5/2006 4:53:51 PM

Sequence number: 18

Author: IBM[GPenokie]

Subject: Comment on Text

Date: 4/13/2006 3:29:46 PM

Table 15 - last row

The << 8 >> should be << eight >> in two places, The << 0 >> should be << zero >> and the << 1 >> should be << one>>.

RESOLUTION: See DELL comment

Status

risheffi Completed 6/5/2006 4:54:07 PM

Comments from page 52 continued on next page

8.5 MODE SENSE (6) command

8.5.1 MODE SENSE (6) command overview

The MODE SENSE (6) command is used to query the SATL about operational parameters of the target device or logical unit(s). The SATL emulates the SCSI behavior for ATA devices. The MODE SENSE (6) command is the complementary command of the MODE SELSECT (6) command. See 10.1 for supported mode pages.

8.5.2 MODE SENSE (6) CDB fields

The SATL shall support MODE SENSE (6) CDB fields as shown in Table 16.

Table 16 — MODE SENSE (6) CDB fields

Field	Description or reference
OPERATION CODE	Mostly emulated. Some operational parameters in individual pages are gathered by issuing ATA commands. See 10.1. for more details.
DBD	value 0b indicates that one or more block descriptors may be returned in mode sense data. The SATL shall support only the mode parameter block descriptor format for direct-attach devices.
PC	8.5.3
PAGE CODE	This field identifies the particular page requested. See section on Mode pages for further details.
SUB PAGE CODE	This field identifies the sub page code within the page code specified by PAGE CODE field that is required by the client. See section on Mode pages for further details.
ALLOCATION LENGTH	The SATL shall return no more bytes of data than the number specified in this field, but any length fields in the returned data shall be consistent with the number of bytes that would have been returned if this field had specified at least as many bytes as required to transmit the information requested.
CONTROL	6.4

8.5.3 PC (Page Control)

Table 17 shows the values of the PC field.

Table 17 — PC values and their descriptions

Value	Type of Parameter	Supported
00b	Current Values	Yes
01b	Change Values	No
10b	Default Values	No
11b	Saved Values	No

8.5.4 Mode parameter header (6)

Table 18 shows the fields in the mode parameter header (6)

Sequence number: 1
Author: MXO[MEvans]
Subject: Highlight
Date: 2/9/2006 11:35:34 AM

T 8.5.1 MODE SENSE (6) command overview, first paragraph: change to, "The MODE SENSE (6) command (see SPC-3) provides a means for a device server in a SATL to report parameters to an application client. It is a complementary command to the MODE SELECT(6) command. Device servers that implement the MODE SENSE (6) command shall also implement the MODE SELECT (6) command. See 10.1 for supported mode pages." These are the words in SPC-3 with the addition of "(see SPC-3)" and "in the SATL".

Status
risheffi Completed 6/5/2006 4:58:04 PM

Sequence number: 2
Author: IBM[GPenokie]
Subject: Underline
Date: 2/16/2006 1:41:18 PM

T 8.5.2 MODE SENSE (6) CDB fields

Status
risheffi Cancelled 4/17/2006 8:39:06 AM

Sequence number: 3
Author: IBM[GPenokie]
Subject: Oval
Date: 2/16/2006 8:44:35 AM

 Global

The capitalization of the references to tables is inconsistent. It should only be capitalized when it is the first word of a sentence.

Status
risheffi Completed 6/5/2006 4:58:27 PM

Sequence number: 4
Author: DELL[KMarks]
Subject: Highlight
Date: 4/24/2006 1:11:43 PM

T Table 16 — MODE SENSE (6) CDB fields

Change table title to
"Table 16 — MODE SENSE (6) command CDB fields"

To match other command translation table titles, however I suppose this one is correct and all the others are wrong, and "command Command Descriptor Block" fields does seem strange.

RESOLUTION: Change all tables that describe the translation of fields found in CDBs to "COMMAND NAME CDB field translations".

Status
risheffi Completed 6/5/2006 5:05:22 PM

Sequence number: 5
Author: MXO[MEvans]
Subject: Highlight
Date: 2/9/2006 11:37:37 AM

T Table 16, row 1, description: change to, "Some operational parameters in individual pages are gathered by issuing ATA commands (see 10.1)."

Status
risheffi Completed 6/5/2006 5:06:43 PM

Sequence number: 6
Author: DELL[KMarks]
Subject: Highlight
Date: 6/5/2006 5:10:12 PM

T Table 16 — MODE SENSE (6) CDB fields

Row: DBD
change

8.5 MODE SENSE (6) command

8.5.1 MODE SENSE (6) command overview

The MODE SENSE (6) command is used to query the SATL about operational parameters of the target device or logical unit(s). The SATL emulates the SCSI behavior for ATA devices. The MODE SENSE (6) command is the complementary command of the MODE SELSECT (6) command. See 10.1 for supported mode pages.

8.5.2 MODE SENSE (6) CDB fields

The SATL shall support MODE SENSE (6) CDB fields as shown in Table 16.

Table 16 — MODE SENSE (6) CDB fields

Field	Description or reference
OPERATION CODE	Mostly emulated. Some operational parameters in individual pages are gathered by issuing ATA commands. See 10.1. for more details.
DBD	8 value 0b indicates that one or more block descriptors may be returned in mode sense data. The SATL shall support only the mode parameter block descriptor format for direct-attach devices.
PC	9 5.3
PAGE CODE	11 is field 10. identifies the particular page requested. See section on Mode pages for further details.
SUB PAGE CODE	This field identifies the sub page code within the page code specified by PAGE CODE field that is required by the client. See section on Mode pages for further details.
ALLOCATION LENGTH	The SATL shall return no more bytes of data than the number specified in this field, but any length fields in the returned data shall be consistent with the number of bytes that would have been returned if this field had specified at least as many bytes as required to transmit the information requested.
CONTROL	6.4

8.5.3 PC (Page Control)

Table 17 shows the values of the PC field.

Table 17 — PC values and their descriptions



Value	Type of Parameter	Supported
00b	Current Values	Yes
01b	Change Values	No
10b	Default Values	No
11b	Saved Values	No

8.5.4 Mode parameter header (6)

Table 18 shows the fields in the mode parameter header (6)

"A value 0b indicates that one or more block descriptors may be returned in mode sense data. The SATL shall support only the mode parameter block descriptor format for direct-attach devices."

to

"A value set to zero specifies that zero or more block descriptors may be returned in MODE SENSE data. The SATL shall support only the mode parameter block descriptor format for direct-access block devices."

RESOLUTION: s/b

"A DBD bit set to zero specifies that zero or more block descriptors may be returned in MODE SENSE data. The SATL shall support only the mode parameter block descriptor format for direct-access block devices."

Status
r/sheffi Completed 6/5/2006 5:09:43 PM

Sequence number: 7
Author: HPQ[RElliott]
Subject: Highlight
Date: 4/17/2006 8:50:10 AM

T 8.5.2
table 16
change "A value 0b indicates" to "A DBD bit set to zero specifies"
RESOLUTION: See DELL comment.

Status
r/sheffi Completed 6/5/2006 5:10:49 PM

Sequence number: 8
Author: IBM[GPenokie]
Subject: Comment on Text
Date: 4/17/2006 8:51:02 AM

T table 16 - PC row
This << A value 0b indicates that one
>> should be << This bit set to zero indicates that one
>>
RESOLUTION: See DELL comment.

Status
r/sheffi Completed 6/5/2006 5:10:30 PM

Sequence number: 9
Author: EDITOR[r/sheffi]
Subject: Highlight
Date: 4/17/2006 9:36:30 AM

T s/b
Current values (i.e., PC is set to 00b) shall be supported. Reporting changeable, saveable, and default values is unspecified (see 3.x.x).

Status
r/sheffi Completed 6/5/2006 5:13:07 PM

Sequence number: 10
Author: HPQ[RElliott]
Subject: Highlight
Date: 2/1/2006 3:27:43 PM

T 8.5.2
table 16

identifies s/b specifies

Status
r/sheffi Completed 6/5/2006 5:15:16 PM

Sequence number: 11
Author: DELL[KMarks]
Subject: Highlight
Date: 5/6/2006 1:12:45 PM

T Table 16 — MODE SENSE (6) CDB fields
Row: PAGE CODE
change
"This field identifies the particular page requested. See section on Mode pages for further details."
to
"This field specifies the particular mode page requested. See 10.1 for more details."

Comments from page 53 continued on next page

8.5 MODE SENSE (6) command

8.5.1 MODE SENSE (6) command overview

The MODE SENSE (6) command is used to query the SATL about operational parameters of the target device or logical unit(s). The SATL emulates the SCSI behavior for ATA devices. The MODE SENSE (6) command is the complementary command of the MODE SELSECT (6) command. See 10.1 for supported mode pages.

8.5.2 MODE SENSE (6) CDB fields

The SATL shall support MODE SENSE (6) CDB fields as shown in Table 16.

Table 16 — MODE SENSE (6) CDB fields

Field	Description or reference
OPERATION CODE	Mostly emulated. Some operational parameters in individual pages are gathered by issuing ATA commands. See 10.1. for more details.
DBD	A value 0b indicates that one or more block descriptors may be returned in mode sense data. The SATL shall support only the mode parameter block descriptor format for direct-attach devices.
PC	8.5.3
PAGE CODE	This field identifies the particular page requested. ¹² See the section on Mode pages for further details.
SUB PAGE CODE	¹³ This field identifies the sub page code within the page code specified by PAGE CODE field that is required by the client. ¹⁵ See the section on Mode pages for further details.
ALLOCATION LENGTH	¹⁶ The SATL shall return no more bytes of data than the number specified in this field, but any length fields in the returned data shall be consistent with the number of bytes that would have been returned if this field had specified at least as many bytes as required to transmit the information requested.
CONTROL	6.4

8.5.3 PC (Page Control)

Table 17 shows the values of the PC field.

Table 17 — PC values and their descriptions

Value	Type of Parameter	Supported
00b	Current Values	Yes
01b	Change Values	No
10b	Default Values	No
11b	Saved Values	No

8.5.4 Mode parameter header (6)

Table 18 shows the fields in the mode parameter header (6)

RESOLUTION: change to, "This field specifies the particular mode page requested (see 10.1). If the SATL does not support the specified mode page, the SATL shall terminate the command with CHECK CONDITION status, with the sense key set to ILLEGAL REQUEST and the additional sense code set to INVALID FIELD IN CDB"

Status
rlsheffi Completed 6/5/2006 5:14:34 PM

Sequence number: 12
Author: MXO[MEvans]
Subject: Highlight
Date: 4/17/2006 8:56:17 AM

T Table 16, row 4, description: change, "See section on Mode pages for further details." to "(see x.x)" as part of the previous sentence with the proper cross reference.
RESOLUTION: See DELL comment

Status
rlsheffi Completed 6/5/2006 5:14:48 PM

Sequence number: 13
Author: DELL[KMarks]
Subject: Highlight
Date: 4/17/2006 9:19:47 AM

T **Table 16 — MODE SENSE (6) CDB fields**
Row: SUB PAGE CODE

change

"This field identifies the sub page code within the page code specified by PAGE CODE field that is required by the client. See section on Mode pages for further details."

to

"This field specifies the sub page code within the page code specified by PAGE CODE field that is requested by the application client. See 10.1 for more details."

RESOLUTION: Change to, "This field specifies the sub page code within the page code specified by PAGE CODE field that is requested by the application client (see 10.1)."

Status
rlsheffi Completed 6/5/2006 5:17:43 PM

Sequence number: 14
Author: IBM[GPenokie]
Subject: Comment on Text
Date: 4/17/2006 9:20:05 AM

T table 16 - SUB PAGE CODE row

This << See section on Mode pages for further details. >> should be << See x.x on Mode pages for further details. >> where x.x is the subclause being referenced.

RESOLUTION: See DELL comment

Status
rlsheffi Completed 6/5/2006 5:17:59 PM

Sequence number: 15
Author: MXO[MEvans]
Subject: Highlight
Date: 4/17/2006 9:20:26 AM

T Table 16, row 5, description: change, "See section on Mode pages for further details." to "(see x.x)" as part of the previous sentence with the proper cross reference.

RESOLUTION: see DELL comment

Status
rlsheffi Completed 6/5/2006 5:18:12 PM

Sequence number: 16
Author: DELL[KMarks]
Subject: Highlight
Date: 4/17/2006 9:34:48 AM

T **Table 16 — MODE SENSE (6) CDB fields**
Row: ALLOCATION LENGTH

change

"The SATL shall return no more bytes of data than the number specified in this field, but any length fields in the returned data shall be consistent with the number of bytes that would have been returned if this field had specified at least as many bytes as required to transmit the information requested".

Comments from page 53 continued on next page

8.5 MODE SENSE (6) command

8.5.1 MODE SENSE (6) command overview

The MODE SENSE (6) command is used to query the SATL about operational parameters of the target device or logical unit(s). The SATL emulates the SCSI behavior for ATA devices. The MODE SENSE (6) command is the complementary command of the MODE SELECT (6) command. See 10.1 for supported mode pages.

8.5.2 MODE SENSE (6) CDB fields

The SATL shall support MODE SENSE (6) CDB fields as shown in Table 16.

Table 16 — MODE SENSE (6) CDB fields

Field	Description or reference
OPERATION CODE	Mostly emulated. Some operational parameters in individual pages are gathered by issuing ATA commands. See 10.1. for more details.
DBD	A value 0b indicates that one or more block descriptors may be returned in mode sense data. The SATL shall support only the mode parameter block descriptor format for direct-attach devices.
PC	8.5.3
PAGE CODE	This field identifies the particular page requested. See section on Mode pages for further details.
SUB PAGE CODE	This field identifies the sub page code within the page code specified by PAGE CODE field that is required by the client. See section on Mode pages for further details.
ALLOCATION LENGTH	The SATL shall return no more bytes of data than the number specified in this field, but any length fields in the returned data shall be consistent with the number of bytes that would have been returned if this field had specified at least as many bytes as required to transmit the information requested.
CONTROL	6.4

8.5.3 Page Control

Table 17 shows the values of the PC field.

Table 17 — PC values and their descriptions

Value	Type of Parameter	Supported
00b	Current Values	Yes
01b	Change Values	No
10b	Default Values	No
11b	Saved Values	No

8.5.4 Mode parameter header (6)

Table 18 shows the fields in the mode parameter header (6)

to
"The SATL shall implement support for this field as defined in SPC-3."

That or add the current text to the LOG SENSE command field translation, but this seems to be the definition of ALLOCATION LENGTH.

RESOLUTION: Add the following to the definitions in subclause 3.1,
"allocation length: A value in the ALLOCATION LENGTH field of a command descriptor block that specifies the maximum number of bytes that an application client has allocated in the Data-In Buffer, and that is used to limit the maximum amount of variable length data (e.g., mode data, log data, diagnostic data) returned to an application client (see SPC-3)."

and change the description in table 16 to,
"The SATL shall implement this field as defined in SPC-3 (see 3.1.x)."

Status
risheffi Completed 6/5/2006 5:23:29 PM

Sequence number: 17
Author: EDITOR[risheffi]
Subject: Rectangle
Date: 4/17/2006 9:35:29 AM
 8.5.3 pc (Page Control)
Delete this subclause)

Status
risheffi Completed 6/5/2006 5:26:02 PM

Sequence number: 18
Author: IBM[GPenokie]
Subject: Underline
Date: 2/16/2006 1:44:10 PM
 8.5.3 PC (Page Control)

Status
risheffi Cancelled 4/17/2006 9:36:59 AM

Sequence number: 19
Author: HPQ[RElliott]
Subject: Cross-Out
Date: 1/19/2006 9:39:41 AM
 8.5.3

Delete "(Page Control)"

Status
risheffi Completed 6/5/2006 5:26:03 PM

Sequence number: 20
Author: DELL[KMarks]
Subject: Highlight
Date: 4/17/2006 9:37:45 AM
 8.5.3 PC (Page Control) change section header to
"8.5.3 PC (Page Control) field"

RESOLUTION: Delete subclause 8.5.3 (see EDITOR's comment).

Status
risheffi Completed 6/5/2006 5:26:04 PM

Sequence number: 21
Author: HPQ[RElliott]
Subject: Highlight
Date: 4/17/2006 9:38:17 AM
 8.5.3

8.6.3 PC (Page Control)

Add "field" to the end of the title.

RESOLUTION: Delete subclause 8.5.3 (see EDITOR's comment)

Status
risheffi Completed 6/5/2006 5:26:04 PM

Comments from page 53 continued on next page

8.5 MODE SENSE (6) command

8.5.1 MODE SENSE (6) command overview

The MODE SENSE (6) command is used to query the SATL about operational parameters of the target device or logical unit(s). The SATL emulates the SCSI behavior for ATA devices. The MODE SENSE (6) command is the complementary command of the MODE SELSECT (6) command. See 10.1 for supported mode pages.

8.5.2 MODE SENSE (6) CDB fields

The SATL shall support MODE SENSE (6) CDB fields as shown in Table 16.

Table 16 — MODE SENSE (6) CDB fields

Field	Description or reference
OPERATION CODE	Mostly emulated. Some operational parameters in individual pages are gathered by issuing ATA commands. See 10.1. for more details.
DBD	A value 0b indicates that one or more block descriptors may be returned in mode sense data. The SATL shall support only the mode parameter block descriptor format for direct-attach devices.
PC	8.5.3
PAGE CODE	This field identifies the particular page requested. See section on Mode pages for further details.
SUB PAGE CODE	This field identifies the sub page code within the page code specified by PAGE CODE field that is required by the client. See section on Mode pages for further details.
ALLOCATION LENGTH	The SATL shall return no more bytes of data than the number specified in this field, but any length fields in the returned data shall be consistent with the number of bytes that would have been returned if this field had specified at least as many bytes as required to transmit the information requested.
CONTROL	6.4

8.5.3 PC (Page Control)

Table 17 shows the values of the PC field.

Table 17 — PC values and their descriptions

Value	Type of Parameter	Supported
00b	Current Values	Yes
01b	Change Values	No
10b	Default Values	No
11b	Saved Values	No

8.5.4 Mode parameter header (6)

Table 18 shows the fields in the mode parameter header (6)

Sequence number: 22
Author: DELL[KMarks]
Subject: Highlight
Date: 4/17/2006 9:38:38 AM

T 8.5.3 PC (Page Control)

1st Sentence
change

"Table 17 shows the values of the PC field."

to

"Table 17 shows the supported values of the PC field."

RESOLUTION: Delete subclause 8.5.3 (see EDITOR's comment)

Status
risheffi Completed 6/5/2006 5:26:03 PM

Sequence number: 23
Author: HPQ[RElliott]
Subject: Highlight
Date: 4/17/2006 9:38:50 AM

T 8.5.3

Table 17

Change "values and their descriptions" to "field"

RESOLUTION: Delete subclause 8.5.3 (see EDITOR's comment)

Status
risheffi Completed 6/5/2006 5:26:02 PM

Sequence number: 24
Author: IBM[GPenokie]
Subject: Comment on Text
Date: 4/17/2006 9:39:05 AM

T table 17 title

The title of this table should be << PC values >>

RESOLUTION: Delete subclause 8.5.3 (see EDITOR's comment)

Status
risheffi Completed 6/5/2006 5:26:03 PM

Sequence number: 25
Author: DELL[KMarks]
Subject: Highlight
Date: 4/17/2006 9:39:26 AM

T Table 17 — PC values and their descriptions

change title to "Table 17 — Supported PC values"

and

change first column title to "Code"

and change 2nd column title to make P in parameter lower case.

RESOLUTION: Delete subclause 8.5.3 (see EDITOR's comment)

Status
risheffi Completed 6/5/2006 5:26:04 PM

Sequence number: 26
Author: HPQ[RElliott]
Subject: Highlight
Date: 4/17/2006 9:39:40 AM

T 8.5.3

Table 17

Change Value to Code

RESOLUTION: Delete subclause 8.5.3 (see EDITOR's comment)

Status
risheffi Completed 6/5/2006 5:26:02 PM

Sequence number: 27
Author: ENDL[RWeber]
Date: 4/17/2006 9:43:35 AM

 table 17

T Does 'No' in the supported column mean 'unspecified' or does it mean the SATL is required to reject commands that specific the listed page code values? Clarify.

8.5 MODE SENSE (6) command

8.5.1 MODE SENSE (6) command overview

The MODE SENSE (6) command is used to query the SATL about operational parameters of the target device or logical unit(s). The SATL emulates the SCSI behavior for ATA devices. The MODE SENSE (6) command is the complementary command of the MODE SELSECT (6) command. See 10.1 for supported mode pages.

8.5.2 MODE SENSE (6) CDB fields

The SATL shall support MODE SENSE (6) CDB fields as shown in Table 16.

Table 16 — MODE SENSE (6) CDB fields

Field	Description or reference
OPERATION CODE	Mostly emulated. Some operational parameters in individual pages are gathered by issuing ATA commands. See 10.1. for more details.
DBD	A value 0b indicates that one or more block descriptors may be returned in mode sense data. The SATL shall support only the mode parameter block descriptor format for direct-attach devices.
PC	8.5.3
PAGE CODE	This field identifies the particular page requested. See section on Mode pages for further details.
SUB PAGE CODE	This field identifies the sub page code within the page code specified by PAGE CODE field that is required by the client. See section on Mode pages for further details.
ALLOCATION LENGTH	The SATL shall return no more bytes of data than the number specified in this field, but any length fields in the returned data shall be consistent with the number of bytes that would have been returned if this field had specified at least as many bytes as required to transmit the information requested.
CONTROL	6.4

8.5.3 PC (Page Control)

Table 17 shows the values of the PC field.

Table 17 — PC values and their descriptions



Value	Type of Parameter	Supported
00b	Current Values	Yes
01b	Change ²⁸ values	³⁰ No
10b	Default Values	No
11b	Saved Values	No

³¹ 8.5.4 Mode parameter header (6)

³² Table 18 shows the fields in the mode parameter header (6)

RESOLUTION: Delete subclause 8.5.3 (see EDITOR's comment). The description of the PC field in table 16 (see EDITOR's comment) is revised to clarify that the translations for changeable values, default values, and saved values are unspecified.

Status
rlsheffi Completed 6/5/2006 5:26:04 PM

Sequence number: 28
Author: DELL[KMarks]
Subject: Note
Date: 4/17/2006 9:44:57 AM
 In 8.5.3 PC (Page Control)

Not sure the value of this section/table 17. Seems a lot easier to say SATL shall support the field set to 00b in table 16 and if not 00b, then check condition/illegal request/invalid field in CDB?

However, since the SP bit in the MODE SELECT is unspecified, it would seem to me that Saved Values would be supported also if the device allowed for saving values.

The more I think about it, they should be set to unspecified for all the No values.

RESOLUTION: Delete subclause 8.5.3 (see EDITOR's comment). The description of the PC field in table-16 is revised to clarify that changeable values, default values, and saved values are unspecified.

Status
rlsheffi Completed 6/5/2006 5:26:04 PM

Sequence number: 29
Author: LSI[OParry]
Subject: Highlight
Date: 4/17/2006 9:46:16 AM

 8.5.3 PC (Page Control)
Table 17 - PC values and their descriptions

Support of changeable parameters should be left to the discretion of the SATL vendor.

RESOLUTION: Delete subclause 8.5.3 (see EDITOR's comment). The description of the PC field in table 16 (see EDITOR's comment) is revised to clarify that the translations for changeable values, default values, and saved values are unspecified.

Status
rlsheffi Completed 6/5/2006 5:26:03 PM

Sequence number: 30
Author: SIERLGC[BMartin]
Subject: Highlight
Date: 4/17/2006 9:45:55 AM

 Page 33, Table 17
Why are 01b, 10b, and 11b not supported? SPC requires that 10b be supported, and that this shall be returnable even if the LU is not ready. Change these to supported and support as specified in SPC.

RESOLUTION: Delete subclause 8.5.3 (see EDITOR's comment). The description of the PC field in table 16 (see EDITOR's comment) is revised to clarify that the translations for changeable values, default values, and saved values are unspecified.

Status
rlsheffi Completed 6/5/2006 5:26:02 PM

Sequence number: 31
Author: IBM[GPenokie]
Subject: Underline
Date: 2/16/2006 1:45:33 PM

 8.5.4 Mode parameter header (6)

Status
rlsheffi Cancelled 4/17/2006 9:46:33 AM

Sequence number: 32
Author: DELL[KMarks]
Subject: Highlight
Date: 2/16/2006 1:58:07 PM

 8.5.4 Mode parameter header (6)
1st Sentence

change
"Table 18 shows the fields in the mode parameter header (6)"
to

8.5 MODE SENSE (6) command

8.5.1 MODE SENSE (6) command overview

The MODE SENSE (6) command is used to query the SATL about operational parameters of the target device or logical unit(s). The SATL emulates the SCSI behavior for ATA devices. The MODE SENSE (6) command is the complementary command of the MODE SELECT (6) command. See 10.1 for supported mode pages.

8.5.2 MODE SENSE (6) CDB fields

The SATL shall support MODE SENSE (6) CDB fields as shown in Table 16.

Table 16 — MODE SENSE (6) CDB fields

Field	Description or reference
OPERATION CODE	Mostly emulated. Some operational parameters in individual pages are gathered by issuing ATA commands. See 10.1. for more details.
DBD	A value 0b indicates that one or more block descriptors may be returned in mode sense data. The SATL shall support only the mode parameter block descriptor format for direct-attach devices.
PC	8.5.3
PAGE CODE	This field identifies the particular page requested. See section on Mode pages for further details.
SUB PAGE CODE	This field identifies the sub page code within the page code specified by PAGE CODE field that is required by the client. See section on Mode pages for further details.
ALLOCATION LENGTH	The SATL shall return no more bytes of data than the number specified in this field, but any length fields in the returned data shall be consistent with the number of bytes that would have been returned if this field had specified at least as many bytes as required to transmit the information requested.
CONTROL	6.4

8.5.3 PC (Page Control)

Table 17 shows the values of the PC field.

Table 17 — PC values and their descriptions

Value	Type of Parameter	Supported
00b	Current Values	Yes
01b	Change Values	No
10b	Default Values	No
11b	Saved Values	No

8.5.4 Mode parameter header (6)

Table 18 shows the fields in the mode parameter header ³³

"Table 18 shows the fields in the mode parameter header (6) for a MODE SENSE (6) command."

Status
risheffi Completed 6/5/2006 5:28:28 PM

Sequence number: 33
Author: HPQ[RElliott]
Date: 2/3/2006 7:52:01 AM

T 8.5.4

after (6) add .

Status
risheffi Completed 6/5/2006 5:27:45 PM

Table 18 — Mode parameter header (6) fields

Field	Description or reference
MODE DATA LENGTH	2 indicates the number of bytes following this field that was transferred.
MEDIUM TYPE	3 for direct access devices, this field should be set to 00h.
DEVICE SPECIFIC PARAMETER	5 See SBC-2. If the DPOFUA bit is set to 0b it indicates that SATL does not support DPO and FUA bits. If the DPOFUA bit is set to 1b it indicates that the SATL supports DPO and FUA bits. If the WP bit is set to 0b, it indicates that the device is write enabled. This is the only supported value for this bit. If the WP bit is set to 1b, it indicates that the device is write protected. A WP bit set to 1b shall not be supported.
BLOCK DESCRIPTOR LENGTH	This field indicates the length of the mode parameter block descriptor. This value is obtained by multiplying the number of block descriptors by 8, for MODE SELECT (6) commands and MODE SELECT (10) commands, if LONGLBA bit is set to zero, or by 16 for MODE SELECT (10) commands and LONGLBA bit is set to one. Only one mode parameter block descriptor is supported, so this value should be set to 8 or 16.

8.5.5 General mode parameter block descriptor fields

Table 19 describes the translation of the general mode parameter block descriptor fields.

Table 19 — General mode parameter block descriptor fields

Field	Description or reference
NUMBER OF BLOCKS	Unspecified (see 3.4.3)
DENSITY CODE	For direct access devices, this field should be set to 00h.
BLOCK LENGTH	Describes the block length for the section of the LUN described by this mode parameter block descriptor. Since there is only one mode parameter block descriptor, this describes the block length of the entire LUN. For direct access devices, the block length is set to 200h or 512 bytes per block.

~~SATL shall support only the mode parameter block descriptor formats for direct access devices.~~

8.5.6 ~~Mode Sense Block Descriptor (8 byte format)~~

~~The general format used to return data for a MODE SENSE command contains a Mode Parameter header, followed by one or more BLOCK DESCRIPTORS, followed by a variable length mode page(s). Please refer SPC 3~~

Sequence number: 1
Author: DELL[KMarks]
Subject: Highlight
Date: 4/17/2006 10:47:25 AM

T Table 18 — Mode parameter header (6) fields

Row: **MORE DATA LENGTH**

change

"Indicates the number of bytes following this field that was transferred."

to

"Indicates the length in bytes of the following data that is available for transfer."

or

"see SPC-3"

RESOLUTION: s/b "See SPC-3"

Status
rlsheffi Completed 6/14/2006 10:59:53 AM

Sequence number: 2
Author: HPQ[RElliott]
Subject: Highlight
Date: 4/17/2006 10:47:53 AM

T 8.5.4
table 18

Indicates s/b "This field indicates"

RESOLUTION: s/b "See SPC-3"

Status
rlsheffi Completed 6/14/2006 11:00:10 AM

Sequence number: 3
Author: DELL[KMarks]
Subject: Highlight
Date: 4/17/2006 10:49:08 AM

T Table 18 — Mode parameter header (6) fields

Row: **MEDIUM TYPE**

change

"For direct access devices, this field should be set to 00h."

to

"Unspecified (see 3.4.3) For direct access block devices, this field shall be set to 00h."

RESOLUTION: s/b "Unspecified (see 3.4.3). For direct access block devices, this field shall be set to 00h." (added a period).

Status
rlsheffi Completed 6/14/2006 11:02:23 AM

Sequence number: 4
Author: EDITOR[rlsheffi]
Subject: Rectangle
Date: 5/1/2006 2:47:00 PM

T Table 18 — Mode parameter header (6) fields

Row: **DEVICE SPECIFIC PARAMETER**

Replace the text in the Description or reference column with:

"The DEVICE-SPECIFIC PARAMETER field for direct-access block devices contains the DPOFUA bit and the WP bit (see SBC-2)."

"A DPOFUA bit set to zero indicates that the SATL supports neither the DPO bit nor the FUA bit. A DPOFUA bit set to one indicates that the SATL supports both the DPO bit and the FUA bit."

"A WP bit set to zero indicates that the medium is not write-protected. A WP bit set to one indicates that the medium is write-protected."

Status
rlsheffi Completed 6/14/2006 11:08:07 AM

Sequence number: 5
Author: DELL[KMarks]

Table 18 — Mode parameter header (6) fields

Field	Description or reference
MODE DATA LENGTH	Indicates the number of bytes following this field that was transferred.
MEDIUM TYPE	For direct access devices, this field should be set to 00h.
DEVICE SPECIFIC PARAMETER	<p>See SBC-2.</p> <p>6 the DPOFUA bit is set to 0b it indicates that SATL does not support DPO and FUA bits. 7 the DPOFUA bit is set to 1b it indicates that the SATL supports DPO and FUA bits.</p> <p>9 the WP bit is set to 0b, it indicates that the device is write enabled. This is the only supported value for this bit. If the WP bit is set to 1b, it indicates that the device is write protected. A WP bit set to 1b shall not be supported.</p>
BLOCK DESCRIPTOR LENGTH	This field indicates the length of the mode parameter block descriptor. This value is obtained by multiplying the number of block descriptors by 8, for MODE SELECT (6) commands and MODE SELECT (10) commands, if LONGLBA bit is set to zero, or by 16 for MODE SELECT (10) commands and LONGLBA bit is set to one. Only one mode parameter block descriptor is supported, so this value should be set to 8 or 16.

8.5.5 General mode parameter block descriptor fields

Table 19 describes the translation of the general mode parameter block descriptor fields.

Table 19 — General mode parameter block descriptor fields

Field	Description or reference
NUMBER OF BLOCKS	Unspecified (see 3.4.3)
DENSITY CODE	For direct access devices, this field should be set to 00h.
BLOCK LENGTH	Describes the block length for the section of the LUN described by this mode parameter block descriptor. Since there is only one mode parameter block descriptor, this describes the block length of the entire LUN. For direct access devices, the block length is set to 200h or 512 bytes per block.

~~SATL shall support only the mode parameter block descriptor formats for direct access devices.~~

8.5.6 ~~Mode Sense Block Descriptor (8 byte format)~~

The general format used to return data for a MODE SENSE command contains a Mode Parameter header, followed by one or more BLOCK DESCRIPTORS, followed by a variable length mode page(s). Please refer SPC 3

Subject: Highlight
Date: 4/17/2006 11:31:34 AM

T Table 18 — Mode parameter header (6) fields

Row: DEVICE SPECIFIC PARAMETER
change

"See SBC-2.

If the DPOFUA bit is set to 0b it indicates that SATL does not support DPO and FUA bits. If the DPOFUA bit is set to 1b it indicates that the SATL supports DPO and FUA bits.

If the WP bit is set to 0b, it indicates that the device is write enabled. This is the only supported value for this bit. If the WP bit is set to 1b, it indicates that the device is write protected. A WP bit set to 1b shall not be supported."

to

"See SBC-2 for direct access block devices..

If the DPOFUA bit is set to zero, it indicates that the SATL does not support the DPO and FUA bits. If the DPOFUA bit is set to one it indicates that the SATL supports the DPO and FUA bits.

If the WP bit is set to zero, it indicates that the logical unit is write enabled. If the WP bit is set to one, it indicates that the logical unit is write protected. A WP bit set to one shall not be supported by the SATL."

RESOLUTION: See EDITOR's comment

Status
rlsheffi Completed 6/14/2006 11:08:20 AM

Sequence number: 6
Author: HPQ[RElliott]
Subject: Highlight
Date: 4/17/2006 11:32:00 AM

T 8.5.4
table 18

change "If the DPOFUA bit is set to 0b it indicates" to "A DPOFUA bit set to zero indicates"

RESOLUTION: See EDITOR's comment

Status
rlsheffi Completed 6/14/2006 11:08:38 AM

Sequence number: 7
Author: HPQ[RElliott]
Subject: Highlight
Date: 4/17/2006 11:32:15 AM

T 8.5.4
table 18

change "If the DPOFUA bit is set to 1b it indicates" to "A DPOFUA bit set to one indicates"

RESOLUTION: See EDITOR's comment

Status
rlsheffi Completed 6/14/2006 11:08:47 AM

Sequence number: 8
Author: IBM[GPenokie]
Subject: Comment on Text
Date: 4/17/2006 11:32:30 AM

T table 18 3rd row
All the << 0b >> should be << zero >> and all the << 1b >> should be << one >>.

RESOLUTION: See EDITOR's comment

Status
rlsheffi Completed 6/14/2006 11:08:56 AM

Sequence number: 9
Author: HPQ[RElliott]
Subject: Highlight
Date: 4/17/2006 11:33:31 AM

Comments from page 54 continued on next page

Table 18 — Mode parameter header (6) fields

Field	Description or reference
MODE DATA LENGTH	Indicates the number of bytes following this field that was transferred.
MEDIUM TYPE	For direct access devices, this field should be set to 00h.
DEVICE SPECIFIC PARAMETER	<p>See SBC-2.</p> <p>If the DPOFUA bit is set to 0b it indicates that SATL does not support DPO and FUA bits. If the DPOFUA bit is set to 1b it indicates that the SATL supports DPO and FUA bits.</p> <p>If the WP bit is set to 0b, it indicates that the device is write enabled. This is the only supported value for this bit.</p> <p>If the WP bit is set to 1b, it indicates that the device is write protected. A WP bit set to 1b shall not be supported.</p>
BLOCK DESCRIPTOR LENGTH	This field indicates the length of the mode parameter block descriptor. This value is obtained by multiplying the number of block descriptors by 8, for MODE SELECT (6) commands and MODE SELECT (10) commands, if LONGLBA bit is set to zero, or by 16 for MODE SELECT (10) commands and LONGLBA bit is set to one. Only one mode parameter block descriptor is supported, so this value should be set to 8 or 16.

8.5.5 General mode parameter block descriptor fields

Table 19 describes the translation of the general mode parameter block descriptor fields.

Table 19 — General mode parameter block descriptor fields

Field	Description or reference
NUMBER OF BLOCKS	Unspecified (see 3.4.3)
DENSITY CODE	For direct access devices, this field should be set to 00h.
BLOCK LENGTH	Describes the block length for the section of the LUN described by this mode parameter block descriptor. Since there is only one mode parameter block descriptor, this describes the block length of the entire LUN. For direct access devices, the block length is set to 200h or 512 bytes per block.

~~SATL shall support only the mode parameter block descriptor formats for direct access devices.~~

~~8.5.6 Mode Sense Block Descriptor (8 byte format)~~

~~The general format used to return data for a MODE SENSE command contains a Mode Parameter header, followed by one or more BLOCK DESCRIPTORS, followed by a variable length mode page(s). Please refer SPC-3~~

T 8.5.4
table 18

change "If the WP bit is set to 0b it indicates" to "A WP bit set to zero indicates"

RESOLUTION: See EDITOR's comment

Status
rlsheffi Completed 6/14/2006 11:09:07 AM

Sequence number: 10
Author: HPQ[RElliott]
Subject: Highlight
Date: 4/17/2006 11:33:45 AM

T 8.5.4
table 18

change "If the WP bit is set to 1b it indicates" to "A WP bit set to one indicates"

RESOLUTION: See EDITOR's comment

Status
rlsheffi Completed 6/14/2006 11:09:14 AM

Sequence number: 11
Author: DELL[KMarks]
Subject: Highlight
Date: 4/17/2006 11:36:43 AM

T Table 18 — Mode parameter header (6) fields
Row: BLOCK DESCRIPTOR LENGTH

change

"This field indicates the length of the mode parameter block descriptor. This value is obtained by multiplying the number of block descriptors by 8, for MODE SELECT (6) commands and MODE SELECT (10) commands, if LONGLBA bit is set to zero, or by 16 for MODE SELECT (10) commands and LONGLBA bit is set to one. Only one mode parameter block descriptor is supported, so this value should be set to 8 or 16."

to

"This field indicates the length of the mode parameter block descriptor. This value is obtained by multiplying the number of block descriptors by 8. The SATL shall return zero or one mode parameter block descriptors."

LONGLBA is not defined in the (6), so it can not return a 16 byte descriptor.

RESOLUTION: change the text in the description to,

"This field indicates the length of the mode parameter block descriptor. This value is obtained by multiplying the number of block descriptors by eight. The SATL shall return zero or one mode parameter block descriptors." (changed "8" to "eight")

Status
rlsheffi Completed 6/14/2006 12:18:42 PM

Sequence number: 12
Author: IBM[GPenokie]
Subject: Comment on Text
Date: 4/17/2006 11:37:15 AM

T table 18 - last row
All the << 8 >>s should be << eight >>.
RESOLUTION: See DELL comment

Status
rlsheffi Completed 6/14/2006 12:19:14 PM

Sequence number: 13
Author: DELL[KMarks]
Subject: Highlight
Date: 4/24/2006 1:17:24 PM

T 8.5.5 General mode parameter block descriptor fields

change section title to
"8.5.5 Mode parameter block descriptor"

Table 18 — Mode parameter header (6) fields

Field	Description or reference
MODE DATA LENGTH	Indicates the number of bytes following this field that was transferred.
MEDIUM TYPE	For direct access devices, this field should be set to 00h.
DEVICE SPECIFIC PARAMETER	<p>See SBC-2.</p> <p>If the DPOFUA bit is set to 0b it indicates that SATL does not support DPO and FUA bits. If the DPOFUA bit is set to 1b it indicates that the SATL supports DPO and FUA bits.</p> <p>If the WP bit is set to 0b, it indicates that the device is write enabled. This is the only supported value for this bit.</p> <p>If the WP bit is set to 1b, it indicates that the device is write protected. A WP bit set to 1b shall not be supported.</p>
BLOCK DESCRIPTOR LENGTH	This field indicates the length of the mode parameter block descriptor. This value is obtained by multiplying the number of block descriptors by 8, for MODE SELECT (6) commands and MODE SELECT (10) commands, if LONGLBA bit is set to zero, or by 16 for MODE SELECT (10) commands and LONGLBA bit is set to one. Only one mode parameter block descriptor is supported, so this value should be set to 8 or 16.

8.5.5 General mode parameter block descriptor fields

15 Table 19 describes the translation of the general mode parameter block descriptor fields.

16 Table 19 — General mode parameter block descriptor fields

Field	Description or reference
NUMBER OF BLOCKS	Unspecified (see 3.4.3)
DENSITY CODE	17 For direct access devices, this field should be set to 00h.
BLOCK LENGTH	Describes the block length for the section of the LUN described by this mode parameter block descriptor. Since there is only one mode parameter block descriptor, this describes the block length of the entire LUN. For direct access devices, the block length is set to 200h or 512 bytes per block.

SATL shall support only the mode parameter block descriptor formats for direct access devices.

8.5.6 Mode Sense Block Descriptor (8 byte format)

The general format used to return data for a MODE SENSE command contains a Mode Parameter header, followed by one or more BLOCK DESCRIPTORS, followed by a variable length mode page(s). Please refer SPC 3

based on comments in note

Status
rlsheffi Completed 6/14/2006 12:19:52 PM

Sequence number: 14
Author: DELL[KMarks]
Subject: Highlight
Date: 4/17/2006 11:39:59 AM

T 8.5.5 General mode parameter block descriptor fields

1st Sentence

change

"Table 19 describes the translation of the general mode parameter block descriptor fields."

to

"Table 19 describes the translation of the short LBA mode parameter block descriptor and long LBA mode parameter block descriptor fields."

RESOLUTION: s/b "Table 19 describes the translation of fields in the short LBA mode parameter block descriptor and the long LBA mode parameter block descriptor."

Status
rlsheffi Completed 6/24/2006 9:43:11 AM

Sequence number: 15
Author: DELL[KMarks]
Subject: Note
Date: 4/24/2006 1:18:21 PM

T 8.5.5 General mode parameter block descriptor fields

In Section 8.3.3.1, it states that the SATL shall not support the General mode parameter block descriptor. Yet it is shown here.

This comes back to the point of, is this standard(v1.0) only for block devices? If so, this should be changed to the Mode parameter descriptor section, defining the fields for the short and long LBA mpbd.

And Delete 8.5.6

RESOLUTION: Modify 8.5.5 to define the translation for the "Mode parameter block descriptor" per DELL comment on the subheading.

Also, move this subclause to clause 10.

Status
rlsheffi Completed 6/24/2006 9:42:39 AM

Sequence number: 16
Author: DELL[KMarks]
Subject: Highlight
Date: 2/3/2006 3:02:10 PM

T Table 19 — General mode parameter block descriptor fields

change title to

"Table 19 — Mode parameter block descriptor fields"

Status
rlsheffi Completed 6/14/2006 12:20:58 PM

Sequence number: 17
Author: DELL[KMarks]
Subject: Cross-Out
Date: 2/3/2006 3:02:39 PM

T Table 19 — General mode parameter block descriptor fields

Row: DENSITY CODE

remove DENITY CODE row.

As it is reserved in the short LBA and not defined in the Long LBA mode parameter block descriptor

Comments from page 54 continued on next page

Table 18 — Mode parameter header (6) fields

Field	Description or reference
MODE DATA LENGTH	Indicates the number of bytes following this field that was transferred.
MEDIUM TYPE	For direct access devices, this field should be set to 00h.
DEVICE SPECIFIC PARAMETER	<p>See SBC-2.</p> <p>If the DPOFUA bit is set to 0b it indicates that SATL does not support DPO and FUA bits. If the DPOFUA bit is set to 1b it indicates that the SATL supports DPO and FUA bits.</p> <p>If the WP bit is set to 0b, it indicates that the device is write enabled. This is the only supported value for this bit.</p> <p>If the WP bit is set to 1b, it indicates that the device is write protected. A WP bit set to 1b shall not be supported.</p>
BLOCK DESCRIPTOR LENGTH	This field indicates the length of the mode parameter block descriptor. This value is obtained by multiplying the number of block descriptors by 8, for MODE SELECT (6) commands and MODE SELECT (10) commands, if LONGLBA bit is set to zero, or by 16 for MODE SELECT (10) commands and LONGLBA bit is set to one. Only one mode parameter block descriptor is supported, so this value should be set to 8 or 16.

8.5.5 General mode parameter block descriptor fields

Table 19 describes the translation of the general mode parameter block descriptor fields.

Table 19 — General mode parameter block descriptor fields

Field	Description or reference
NUMBER OF BLOCKS	Unspecified (see 3.4.3)
DENSITY CODE	For direct access devices, this field should be set to 00h.
BLOCK LENGTH	¹⁹ describes the block length for the section of the LUN described by this mode parameter block descriptor. Since there is only one mode parameter block descriptor, this describes the block length of the entire LUN. For direct access devices, the block length is set to 200h or 512 bytes per block.

²⁰ ~~TL shall support only the mode parameter block descriptor formats for direct access devices.~~

~~5.6 Mode Sense Block Descriptor (8 byte format)~~

~~The general format used to return data for a MODE SENSE command contains a Mode Parameter header, followed by one or more BLOCK DESCRIPTORS, followed by a variable length mode page(s). Please refer SPC 3~~

Status
rlsheffi Completed 6/14/2006 12:47:15 PM

Sequence number: 18
Author: DELL[KMarks]
Subject: Highlight
Date: 7/23/2006 11:16:35 AM
T Table 19 — General mode parameter block descriptor fields

Row: BLOCK LENGTH
change

"Describes the block length for the section of the LUN described by this mode parameter block descriptor. Since there is only one mode parameter block descriptor, this describes the block length of the entire LUN. For direct access devices, the block length is set to 200h or 512 bytes per block."

to
"For direct access block devices, the SATL shall set this field to 200h (i.e., 512 bytes)."

RESOLUTION: Define both direct and indirect block mapping - see 06-216.

Status
rlsheffi Completed 7/23/2006 11:16:39 AM

Sequence number: 19
Author: ELX[KHirata]
Subject: Highlight
Date: 5/11/2006 12:54:25 PM
T Location: Page 34, Table 19, Block Length Description.

Comment:

Shouldn't the Block Length be reported as per the sector size field in the IDENTIFY DEVICE data? (Defaulting to 512-bytes if the IDENTIFY DEVICE field isn't valid.) Why is this hard coded to 512 bytes?

Preferred resolution:

Clarification. If there is a good reason for this then I don't care.

RESOLUTION: Specified in 06-216.

Status
rlsheffi Completed 7/23/2006 11:20:30 AM

Sequence number: 20
Author: DELL[KMarks]
Subject: Cross-Out
Date: 2/3/2006 2:01:22 PM
T 8.5.5 General mode parameter block descriptor fields
1st Sentence after Table 19

Remove sentence

"SATL shall support only the mode parameter block descriptor formats for direct access devices."

Status
rlsheffi Completed 6/14/2006 1:05:38 PM

Sequence number: 21
Author: DELL[KMarks]
Subject: Cross-Out
Date: 2/3/2006 1:19:17 PM
T 8.5.6 Mode Sense Block Descriptor (8 byte format)

Remove whole subclause 8.5.6, as it is redundant.

Status
rlsheffi Completed 6/14/2006 1:08:23 PM

Sequence number: 22
Author: IBM[GPenokie]
Subject: Underline
Date: 2/16/2006 1:44:58 PM
T 8.5.6 Mode Sense Block Descriptor (8 byte format)

Status

Comments from page 54 continued on next page

Table 18 — Mode parameter header (6) fields

Field	Description or reference
MODE DATA LENGTH	Indicates the number of bytes following this field that was transferred.
MEDIUM TYPE	For direct access devices, this field should be set to 00h.
DEVICE SPECIFIC PARAMETER	<p>See SBC-2.</p> <p>If the DPOFUA bit is set to 0b it indicates that SATL does not support DPO and FUA bits. If the DPOFUA bit is set to 1b it indicates that the SATL supports DPO and FUA bits.</p> <p>If the WP bit is set to 0b, it indicates that the device is write enabled. This is the only supported value for this bit.</p> <p>If the WP bit is set to 1b, it indicates that the device is write protected. A WP bit set to 1b shall not be supported.</p>
BLOCK DESCRIPTOR LENGTH	This field indicates the length of the mode parameter block descriptor. This value is obtained by multiplying the number of block descriptors by 8, for MODE SELECT (6) commands and MODE SELECT (10) commands, if LONGLBA bit is set to zero, or by 16 for MODE SELECT (10) commands and LONGLBA bit is set to one. Only one mode parameter block descriptor is supported, so this value should be set to 8 or 16.

8.5.5 General mode parameter block descriptor fields

Table 19 describes the translation of the general mode parameter block descriptor fields.

Table 19 — General mode parameter block descriptor fields

Field	Description or reference
NUMBER OF BLOCKS	Unspecified (see 3.4.3)
DENSITY CODE	For direct access devices, this field should be set to 00h.
BLOCK LENGTH	Describes the block length for the section of the LUN described by this mode parameter block descriptor. Since there is only one mode parameter block descriptor, this describes the block length of the entire LUN. For direct access devices, the block length is set to 200h or 512 bytes per block.

~~SATL shall support only the mode parameter block descriptor formats for direct access devices.~~

8.5.6 ~~Mode Sense Block Descriptor (8 byte format)~~

~~The general format used to return data for a MODE SENSE command contains a Mode Parameter header, followed by one or more BLOCK DESCRIPTORS, followed by a variable length mode page(s).~~ ²³ ~~base refer SPC 3~~ ²⁶

risheffi Cancelled 4/17/2006 1:50:40 PM

Sequence number: 23
Author: DELL[KMarks]
Subject: Cross-Out
Date: 2/3/2006 1:21:49 PM
T remove subclause 8.5.6

Status
risheffi Completed 6/14/2006 1:09:08 PM

Sequence number: 24
Author: ENDL[RWeber]
Date: 4/17/2006 1:51:51 PM
T p 1, s 1
Please refer SPC-3 [s/b] Please refer to SPC-3
RESOLUTION: Remove subclause 8.5.6 (see DELL comment)

Status
risheffi Completed 6/14/2006 1:09:18 PM

Sequence number: 25
Author: IBM[GPenokie]
Subject: Comment on Text
Date: 4/17/2006 1:52:20 PM
T 1st paragraph
This << Please refer SPC-3 >> should be << See SPC-3 >>
RESOLUTION: Remove subclause 8.5.6 (see DELL comment)

Status
risheffi Completed 6/14/2006 1:09:38 PM

Sequence number: 26
Author: MXO[MEvans]
Subject: Highlight
Date: 4/17/2006 1:52:52 PM
T 8.5.6 Mode Sense Block Descriptor (8 byte format), first paragraph: change, "Please refer SPC-3...[and the rest of the sentence on the following page]" to "(see SPC-3)", and include it as part of the previous sentence.
RESOLUTION: Remove subclause 8.5.6 (see DELL comment)

Status
risheffi Completed 6/14/2006 1:10:01 PM

For more details on the format of each of these sections, Table 20 describes the translation of the general mode parameter block descriptor fields.

Table 20 — Mode parameter block descriptor fields

Field	Description or reference
NUMBER OF BLOCKS	Unspecified (see 3.4.3)
DENSITY CODE	For direct access devices, the SATL shall set this field to 00h for direct access devices.
BLOCK LENGTH	Describes the block length for the section of the LUN described by this mode parameter block descriptor. Since there is only one mode parameter block descriptor, this describes the block length of the entire LUN. For direct access devices, this is set to 200h (i.e. 512) bytes per block.

SATL shall support only the mode parameter block descriptor formats for direct access devices.

Persistent saving of parameters shall not be supported.

Only one mode parameter block descriptor shall be supported and it shall describe the settings for the entire logical unit.

8.6 MODE SENSE (10) command

8.6.1 MODE SENSE (10) command overview

The MODE SENSE (10) shall be implemented according to clause 8.5, except that the SATL shall recognize the longer PARAMETER LIST LENGTH field in the CDB, and shall recognize the long lba bit in the mode parameter header (10). The translator emulates the SCSI behavior for ATA devices. The MODE SENSE (10) command is the complementary command of the MODE SELECT (10) command. See 10.1 for supported mode pages.

8.6.2 Mode parameter header (10)

Table 18 shows the fields in the mode parameter header (10).

Table 21 — Mode parameter header (10) fields

Field	Description or reference
MODE DATA LENGTH	8.5.4
MEDIUM TYPE	8.5.4
DEVICE SPECIFIC PARAMETER	8.5.4
LONGLBA	Describes the length of the block descriptors. a) If set to 0b, block descriptors are 8 bytes long. b) If set to 1b, block descriptors are 16 bytes long.
BLOCK DESCRIPTOR LENGTH	This field indicates the length of the mode parameter block descriptor. This value is obtained by multiplying the number of block descriptors by 8 if the LONGLBA bit is set to 0, or by 16 if the LONGLBA bit is set to 1. The SATL shall support no more than one mode parameter block descriptor, so this value should be set to 8 or 16 (see 8.5.4).

Sequence number: 1
Author: DELL[KMarks]
Subject: Cross-Out
Date: 2/3/2006 1:21:58 PM
T remove subclause 8.5.6

Status
r/sheffi Completed 6/14/2006 1:10:24 PM

Sequence number: 2
Author: IBM[GPenokie]
Subject: Comment on Text
Date: 4/17/2006 1:54:02 PM
T 1st paragraph

This << format of each of these sections. >> needs a valid reference to the correct clause or subclauses.
RESOLUTION: Remove subclause 8.5.6 (see DELL comment)

Status
r/sheffi Completed 6/14/2006 1:10:42 PM

Sequence number: 3
Author: MXO[MEvans]
Subject: Highlight
Date: 4/17/2006 1:54:22 PM

T 8.5.6 Mode Sense Block Descriptor (8 byte format), first paragraph: continuation of the previous comment.
RESOLUTION: Remove subclause 8.5.6 (see DELL comment)

Status
r/sheffi Completed 6/14/2006 1:10:53 PM

Sequence number: 4
Author: DELL[KMarks]
Subject: Cross-Out
Date: 2/3/2006 1:22:06 PM
T remove subclause 8.5.6

Status
r/sheffi Completed 6/14/2006 1:11:02 PM

Sequence number: 5
Author: DELL[KMarks]
Subject: Cross-Out
Date: 2/3/2006 1:22:15 PM
T remove subclause 8.5.6

Status
r/sheffi Completed 6/14/2006 1:11:10 PM

Sequence number: 6
Author: ENDL[RWeber]
Date: 4/17/2006 1:55:05 PM
T 2nd p after table 20, s 1

T Is 'Persistent saving of parameters' the same as saving parameters to non-volatile storage? If the answer is yes, does this paragraph correctly represent the current goals of SAT?
RESOLUTION: Remove subclause 8.5.6 (see DELL comment)

Status
r/sheffi Completed 6/14/2006 1:11:30 PM

Sequence number: 7
Author: SIERLGC[BMartin]
Subject: Highlight
Date: 4/17/2006 1:55:33 PM

T Page 35, 8.5.6, below table 20
Why is persistent saving of parameters not allowed? This should be optional.
The SATL can persistently save parameters.
RESOLUTION: Remove subclause 8.5.6 (see DELL comment)

Status
r/sheffi Completed 6/14/2006 1:11:42 PM

for more details on the format of each of these sections. Table 20 describes the translation of the general mode parameter block descriptor fields.

Table 20 — Mode parameter block descriptor fields

Field	Description or reference
NUMBER OF BLOCKS	Unspecified (see 3.4.3)
DENSITY CODE	For direct access devices, the SATL shall set this field to 00h for direct access devices.
BLOCK LENGTH	Describes the block length for the section of the LUN described by this mode parameter block descriptor. Since there is only one mode parameter block descriptor, this describes the block length of the entire LUN. For direct access devices, this is set to 200h (i.e. 512) bytes per block.

SATL shall support only the mode parameter block descriptor formats for direct access devices.

Persistent saving of parameters shall not be supported.

Only one mode parameter block descriptor shall be supported and it shall describe the settings for the entire logical unit.

8.6 MODE SENSE (10) command

8.6.1 MODE SENSE (10) command overview

The MODE SENSE (10) shall be implemented according to clause 8.5, except that the SATL shall recognize the longer PARAMETER LIST LENGTH field in the CDB, and shall recognize the long lba bit in the mode parameter header (10). The translator emulates the SCSI behavior for ATA devices. The MODE SENSE (10) command is the complementary command of the MODE SELECT (10) command. See 10.1 for supported mode pages.

8.6.2 Mode parameter header (10)

Table 18 shows the fields in the mode parameter header (10).

Table 21 — Mode parameter header (10) fields

Field	Description or reference
MODE DATA LENGTH	8.5.4
MEDIUM TYPE	8.5.4
DEVICE SPECIFIC PARAMETER	8.5.4
LONGLBA	Describes the length of the block descriptors. a) If set to 0b, block descriptors are 8 bytes long. b) If set to 1b, block descriptors are 16 bytes long.
BLOCK DESCRIPTOR LENGTH	This field indicates the length of the mode parameter block descriptor. This value is obtained by multiplying the number of block descriptors by 8 if the LONGLBA bit is set to 0, or by 16 if the LONGLBA bit is set to 1. The SATL shall support no more than one mode parameter block descriptor, so this value should be set to 8 or 16 (see 8.5.4).

Sequence number: 8
Author: IBM[GPenokie]
Subject: Underline
Date: 2/16/2006 1:42:44 PM
T 8.6.1 MODE SENSE (10) command overview

Status
rlsheffi Cancelled 4/17/2006 1:55:44 PM

Sequence number: 9
Author: EDITOR[rlsheffi]
Subject: Rectangle
Date: 4/17/2006 2:51:19 PM
■ 8.6.1 MODE SENSE (10) command overview

1st Paragraph

Replace paragraph with:

"The MODE SENSE (10) command (see SPC-3) provides a means for a device server in a SATL to report parameters to an application client. It is a complementary command to the MODE SELECT(10) command. Device servers that implement the MODE SENSE (10) command shall also implement the MODE SELECT(10) command. See 10.1 for supported mode pages."

Status
rlsheffi Completed 6/14/2006 1:14:30 PM

Sequence number: 10
Author: DELL[KMarks]
Subject: Highlight
Date: 4/17/2006 2:53:38 PM
T 8.6.1 MODE SENSE (10) command overview

1st Paragraph

"The MODE SENSE (10) shall be implemented according to clause 8.5, except that the SATL shall recognize the longer PARAMETER LIST LENGTH field in the CDB, and shall recognize the long lba bit in the mode parameter header (10). The translator emulates the SCSI behavior for ATA devices. The MODE SENSE (10) command is the complementary command of the MODE SELSECT (10) command. See 10.1 for supported mode pages."

to

"The MODE SENSE (10) shall be implemented according to the translation described in 8.5. The translator emulates the SCSI behavior for ATA devices. The MODE SENSE (10) command is the complementary command of the MODE SELSECT (10) command. See 10.1 for supported mode pages."

RESOLUTION: Paragraph rewritten (for consistency with MODE SENSE (6) - see EDITOR's comment.

Status
rlsheffi Completed 6/14/2006 1:14:42 PM

Sequence number: 11
Author: EDITOR[rlsheffi]
Subject: Highlight
Date: 7/24/2006 12:30:19 PM
T Make the description of the MODE SENSE (10) command consistent with the description of the MODE SELECT (10) command.

Replace the paragraph in the overview with:

"The MODE SENSE (10) command (see SPC-3) provides a means for a device server in a SATL to report parameters to an application client. It is a complementary command to the MODE SELECT(10) command.

The SATL shall implement the MODE SENSE (10) command using the translation described in 8.5. Device servers that implement the MODE SENSE (10) command shall also implement the MODE SELECT(10) command. See 10.1 for supported mode pages."

Status
rlsheffi Completed 7/24/2006 12:30:25 PM

Sequence number: 12
Author: IBM[GPenokie]
Subject: Comment on Text
Date: 4/17/2006 2:54:04 PM
T 1st paragraph

The << long lba >> term should be in small caps.

RESOLUTION: Paragraph rewritten (for consistency with MODE SENSE (6) - see EDITOR's comment.

Status
rlsheffi Completed 6/14/2006 1:14:49 PM

Sequence number: 13
Author: IBM[GPenokie]
Subject: Underline
Date: 2/16/2006 1:43:38 PM

Comments from page 55 continued on next page

for more details on the format of each of these sections. Table 20 describes the translation of the general mode parameter block descriptor fields.

Table 20 — Mode parameter block descriptor fields

Field	Description or reference
NUMBER OF BLOCKS	Unspecified (see 3.4.3)
DENSITY CODE	For direct access devices, the SATL shall set this field to 00h for direct access devices.
BLOCK LENGTH	Describes the block length for the section of the LUN described by this mode parameter block descriptor. Since there is only one mode parameter block descriptor, this describes the block length of the entire LUN. For direct access devices, this is set to 200h (i.e. 512) bytes per block.

SATL shall support only the mode parameter block descriptor formats for direct access devices.

Persistent saving of parameters shall not be supported.

Only one mode parameter block descriptor shall be supported and it shall describe the settings for the entire logical unit.

8.6 MODE SENSE (10) command

8.6.1 MODE SENSE (10) command overview

The MODE SENSE (10) shall be implemented according to clause 8.5, except that the SATL shall recognize the longer PARAMETER LIST LENGTH field in the CDB, and shall recognize the long lba bit in the mode parameter header (10). The translator emulates the SCSI behavior for ATA devices. The MODE SENSE (10) command is the complementary command of the MODE SELECT (10) command. See 10.1 for supported mode pages.

8.6.2 Mode parameter header (10)

Table 18 shows the fields in the mode parameter header (10).

Table 21 — Mode parameter header (10) fields

Field	Description or reference
MODE DATA LENGTH	8.5.4
MEDIUM TYPE	8.5.4
DEVICE SPECIFIC PARAMETER	8.5.4
LONGLBA	<p>17 describes the length of the block descriptors.</p> <ul style="list-style-type: none"> a) If set to 0b, block descriptors are 8 bytes long. b) If set to 1b, block descriptors are 16 bytes long.
BLOCK DESCRIPTOR LENGTH	<p>18 is field indicates the length of the mode parameter block descriptor. This value is obtained by multiplying the number of block descriptors by 8 if the LONGLBA bit is set to 0, or by 16 if the LONGLBA bit is set to 1. The SATL shall support no more than one mode parameter block descriptor, so this value should be set to 8 or 16 (see 8.5.4).</p>

T 8.6.2 Mode parameter header (10)

Status

risheffi Cancelled 4/17/2006 2:54:16 PM

Sequence number: 14
Author: IBM[GPenokie]
Subject: Highlight
Date: 2/16/2006 9:12:25 AM

T 1st paragraph

This << Table 18 shows the fields in the mode >> should be << Table 21 shows the fields in the mode >>

Status

risheffi Completed 6/14/2006 1:16:30 PM

Sequence number: 15
Author: HPQ[RElliott]
Date: 2/3/2006 7:52:01 AM

T 8.6.2

Table 18 shows s/b 21

Status

risheffi Completed 6/14/2006 1:16:44 PM

Sequence number: 16
Author: DELL[KMarks]
Subject: Highlight
Date: 4/17/2006 5:07:13 PM

T Table 21 — Mode parameter header (10) fields

Row: LONG LBA

change

"Describes the length of the block descriptors.

- a) If set to 0b, block descriptors are 8 bytes long.
- b) If set to 1b, block descriptors are 16 bytes long".

to

"Describes the length of the block descriptors:

- a) If set to zero, the mode parameter block descriptor is 8 bytes long; or
- b) If set to one, the mode parameter block descriptor is 16 bytes long."

RESOLUTION: s/b

"This field indicates the length of the block descriptors:

- a) If set to zero, the mode parameter block descriptor is eight bytes long; or
- b) If set to one, the mode parameter block descriptor is 16 bytes long."

Status

risheffi Completed 6/14/2006 1:20:13 PM

Sequence number: 17
Author: IBM[GPenokie]
Subject: Highlight
Date: 4/17/2006 5:07:39 PM

T table 21 - 4th row

The << 0b >> should be << zero >> and the << 1b >> should be << one >> and the << 8 >> should be << eight >>.

RESOLUTION: See DELL comment.

Status

risheffi Completed 6/14/2006 1:20:29 PM

Sequence number: 18
Author: DELL[KMarks]
Subject: Highlight
Date: 4/17/2006 5:10:10 PM

T Table 21 — Mode parameter header (10) fields

Row: BLOCK DESCRIPTOR LENGTH

change

"This field indicates the length of the mode parameter block descriptor. This value is obtained by multiplying the number of block descriptors by 8 if the LONGLBA bit is set to 0, or by 16 if the LONGLBA bit is set to 1. The SATL shall support no more than one mode parameter block descriptor, so this value should be set to 8 or 16 (see 8.5.4).

"

to

for more details on the format of each of these sections. Table 20 describes the translation of the general mode parameter block descriptor fields.

Table 20 — Mode parameter block descriptor fields

Field	Description or reference
NUMBER OF BLOCKS	Unspecified (see 3.4.3)
DENSITY CODE	For direct access devices, the SATL shall set this field to 00h for direct access devices.
BLOCK LENGTH	Describes the block length for the section of the LUN described by this mode parameter block descriptor. Since there is only one mode parameter block descriptor, this describes the block length of the entire LUN. For direct access devices, this is set to 200h (i.e. 512) bytes per block.

SATL shall support only the mode parameter block descriptor formats for direct access devices.

Persistent saving of parameters shall not be supported.

Only one mode parameter block descriptor shall be supported and it shall describe the settings for the entire logical unit.

8.6 MODE SENSE (10) command

8.6.1 MODE SENSE (10) command overview

The MODE SENSE (10) shall be implemented according to clause 8.5, except that the SATL shall recognize the longer PARAMETER LIST LENGTH field in the CDB, and shall recognize the long lba bit in the mode parameter header (10). The translator emulates the SCSI behavior for ATA devices. The MODE SENSE (10) command is the complementary command of the MODE SELECT (10) command. See 10.1 for supported mode pages.

8.6.2 Mode parameter header (10)

Table 18 shows the fields in the mode parameter header (10).

Table 21 — Mode parameter header (10) fields

Field	Description or reference
MODE DATA LENGTH	8.5.4
MEDIUM TYPE	8.5.4
DEVICE SPECIFIC PARAMETER	8.5.4
LONGLBA	Describes the length of the block descriptors. a) If set to 0b, block descriptors are 8 bytes long. b) If set to 1b, block descriptors are 16 bytes long.
BLOCK DESCRIPTOR LENGTH	This field indicates the length of the mode parameter block descriptor. This value is obtained by multiplying the number of block descriptors by 8 if the LONGLBA bit is set to 0, or by 16 if the LONGLBA bit is set to 1. The SATL shall support no more than one mode parameter block descriptor, so this value should be set to 8 or 16 (see 8.5.4).

"This field indicates the length of the mode parameter block descriptor. This value is obtained by multiplying the number of block descriptors by 8 if the LONGLBA bit is set to zero, or by 16 if the LONGLBA bit is set to one. The SATL shall return zero or one one mode parameter block descriptor."

RESOLUTION: s/b

"This field indicates the length of the mode parameter block descriptor. This value is obtained by multiplying the number of block descriptors by eight if the LONGLBA bit is set to zero, or by 16 if the LONGLBA bit is set to one. The SATL shall return zero or one one mode parameter block descriptor."

Status
rsheffi Completed 6/14/2006 1:22:17 PM

Sequence number: 19
Author: IBM[GPenokie]
Subject: Highlight
Date: 2/15/2006 5:22:41 PM

Table 21 - last row
The << 0 >> should be << zero >> and the << 1 >> should be << one >> and the << 8 >> should be << eight >>.

Status
rsheffi Completed 6/14/2006 1:22:33 PM

8.7 READ BUFFER command

17.1 READ BUFFER command overview

4 The READ BUFFER command is used with the write buffer command to determine the integrity of the target device's buffer memory and the physical interconnect that connects the target device and the initiator.

Table 22 — READ BUFFER command CDB fields

Field	Description or reference
OPERATION CODE	The SATL shall issue the ATA READ BUFFER command (E4h) to the attached ATA device.
MODE	8.7.2
BUFFER ID	Unspecified (see 3.4.3)
BUFFER OFFSET	Refers to the offset in the buffer to start reading data from. The BUFFER OFFSET should be less than the size of the buffer size, otherwise a CHECK CONDITION shall be sent back with sense key set to ILLEGAL REQUEST and additional sense code set to INVALID FIELD IN CDB.
ALLOCATION LENGTH	Refer to individual sections for the meaning of this term.
CONTROL	6.4

The logical sector buffer in a ATA device shall be used to emulate the READ BUFFER command, so the size of the buffer is limited to 512 bytes for data buffer and echo buffers.

8.7.2 MODE field

Table 23 describes modes supported. ~~Only data and data buffer descriptor shall be supported.~~

Table 23 — MODE field

Code	Translated ATA Opcode
02h (i.e., Data)	Translated to the ATA READ BUFFER command (see 8.7.3).
03h (i.e., Descriptor)	See 8.7.4.
All others	Unspecified (see 3.4.3)

8.7.3 Data Only mode (02h)

In this mode, data is read from the device's logical sector buffer and returned to the requestor. Note that logical sector buffer in the ATA device is being used to emulate the SCSI READ BUFFER command, so the maximum length of data that can be written is 512 bytes. Valid fields in the CDB, apart from the MODE field, are BUFFER ID, BUFFER OFFSET and ALLOCATION LENGTH. The BUFFER OFFSET shall be less than or equal to 512. The ALLOCATION LENGTH shall be less than or equal to 512. ~~write~~ buffer command may sent to the same BUFFER ID before it is read.

8.7.4 Descriptor mode (03h)

Four bytes of information shall be returned to the requestor describing the requested buffer. These four bytes include the OFFSET BOUNDARY and the BUFFER CAPACITY. The BUFFER ID should be set to 0. For all other BUFFER ID's, all zeros shall be returned. ALLOCATION LENGTH should be set to 4.

Sequence number: 1
Author: IBM[GPenokie]
Subject: Underline
Date: 2/16/2006 1:40:07 PM
T 8.7.1 READ BUFFER command overview

Status
rlsheffi Cancelled 4/17/2006 5:04:14 PM

Sequence number: 2
Author: HPQ[RElliott]
Date: 4/17/2006 5:03:58 PM
 8.7.1

need a reference to table 22
RESOLUTION: See MXO comment.

Status
rlsheffi Completed 6/14/2006 1:26:42 PM

Sequence number: 3
Author: DELL[KMarks]
Subject: Highlight
Date: 4/17/2006 5:03:32 PM
T 8.7.1 READ BUFFER command overview

**1st Sentence
change**

"The READ BUFFER command is used with the write buffer command to determine the integrity of the target device's buffer memory and the physical interconnect that connects the target device and the initiator."

to

"The READ BUFFER command is used with the WRITE BUFFER command to determine the integrity of the buffer memory in the target device and the physical interconnect that connects the target and initiator device. Table 22 shows the translation for fields specified in the READ BUFFER CDB."

"

RESOLUTION: See MXO comment.

Status
rlsheffi Completed 6/14/2006 1:26:28 PM

Sequence number: 4
Author: MXO[MEvans]
Subject: Highlight
Date: 4/17/2006 5:13:35 PM

T 8.7.1 READ BUFFER command overview: change to, "The READ BUFFER command (see SPC-3) is used in conjunction with the WRITE BUFFER command as a diagnostic function for testing memory in the SCSI device and the integrity of the service delivery subsystem. This command shall not alter the medium." These are the words in SPC-3 with the addition of "(see SPC-3)".

RESOLUTION: s/b

"The READ BUFFER command (see SPC-3) is used in conjunction with the WRITE BUFFER command as a diagnostic function for testing memory in the SCSI device and the integrity of the service delivery subsystem. This command shall not alter the medium. Table 22 shows the translation for fields specified in the CDB for the READ BUFFER command."

Status
rlsheffi Completed 6/14/2006 1:26:19 PM

Sequence number: 5
Author: SIERLGC[BMartin]
Subject: Note
Date: 4/18/2006 8:55:22 AM
 Page 36, 8.7.1

READ Buffer and WRITE Buffer can also be used to read and write to the SATL buffers. SPC allows for the vendor to map the BUFFER ID to a specific buffer in the device. This could be a buffer in the SATL in addition to a buffer on the device. Loosen up this definition to allow a buffer to reside in the SATL.

RESOLUTION: in 8.7.2 MODE field delete, "Only data and data buffer descriptor shall be supported." (see DELL comment)

Status
rlsheffi Completed 6/14/2006 1:28:44 PM

8.7 READ BUFFER command

8.7.1 READ BUFFER command overview

The READ BUFFER command is used with the write buffer command to determine the integrity of the target device's buffer memory and the physical interconnect that connects the target device and the initiator.

Table 22 — READ BUFFER command CDB fields

Field	Description or reference
OPERATION CODE	The SATL shall issue the ATA READ BUFFER command (E4h) to the attached ATA device.
MODE	8.7.2
BUFFER ID	Unspecified (see 3.4.3)
BUFFER OFFSET	Refers to the offset in the buffer to start reading data from. The BUFFER OFFSET should be less than the size of the buffer size, otherwise a CHECK CONDITION shall be sent back with sense key set to ILLEGAL REQUEST and additional sense code set to INVALID FIELD IN CDB.
ALLOCATION LENGTH	Refer to individual sections for the meaning of this term.
CONTROL	6.4

The logical sector buffer in a ATA device shall be used to emulate the READ BUFFER command, so the size of the buffer is limited to 512 bytes for data buffer and echo buffers.

8.7.2 MODE field

Table 23 describes modes supported. Only data and data buffer descriptor shall be supported.

Table 23 — MODE field

Code	Translated ATA Opcode
02h (i.e., Data)	Translated to the ATA READ BUFFER command (see 8.7.3).
03h (i.e., Descriptor)	See 8.7.4.
All others	Unspecified (see 3.4.3)

8.7.3 Data Only mode (02h)

In this mode, data is read from the device's logical sector buffer and returned to the requestor. Note that logical sector buffer in the ATA device is being used to emulate the SCSI READ BUFFER command, so the maximum length of data that can be written is 512 bytes. Valid fields in the CDB, apart from the MODE field, are BUFFER ID, BUFFER OFFSET and ALLOCATION LENGTH. The BUFFER OFFSET shall be less than or equal to 512. The ALLOCATION LENGTH shall be less than or equal to 512. A write buffer command may sent to the same BUFFER ID before it is read.

8.7.4 Descriptor mode (03h)

Four bytes of information shall be returned to the requestor describing the requested buffer. These four bytes include the OFFSET BOUNDARY and the BUFFER CAPACITY. The BUFFER ID should be set to 0. For all other BUFFER ID's, all zeros shall be returned. ALLOCATION LENGTH should be set to 4.

Sequence number: 6
Author: IBM[GPenokie]
Subject: Highlight
Date: 4/18/2006 9:37:40 AM

T There is no reference to table 22. This needs to be fixed as all tables have to be referenced.
RESOLUTION: See MXO comment.

Status
rlsheffi Completed 6/14/2006 1:29:21 PM

Sequence number: 7
Author: DELL[KMarks]
Subject: Cross-Out
Date: 2/16/2006 2:06:06 PM

T **Table 22 — READ BUFFER command CDB fields**

T **Row: OPERATION CODE**
remove
"(E4h)"

Status
rlsheffi Completed 6/14/2006 1:29:46 PM

Sequence number: 8
Author: EDITOR[rlsheffi]
Subject: Highlight
Date: 4/24/2006 9:37:06 AM

T **8.7.1 READ BUFFER command overview**
Table 22 — READ BUFFER command CDB fields

BUFFER ID row

The text in the description or reference column should be changed to:

"If the the BUFFER ID field is set to 00h then the SATL shall return information describing or data read from the sector buffer in the ATA device, depending on the value in the MODE field (see 8.7.2). If the the BUFFER ID field is set to a value other than 00h then the translation is unspecified (see 3.4.3), and the SATL shall process the READ BUFFER command as defined in SPC-3."

Status
rlsheffi Completed 6/14/2006 1:33:32 PM

Sequence number: 9
Author: DELL[KMarks]
Subject: Highlight
Date: 4/18/2006 9:20:43 PM

T **Table 22 — READ BUFFER command CDB fields**

T **Row: BUFFER OFFSET**
change

"Refers to the offset in the buffer to start reading data from. The BUFFER OFFSET should be less than the size of the buffer size, otherwise a CHECK CONDITION shall be sent back with sense key set to ILLEGAL REQUEST and additional sense code set to INVALID FIELD IN CDB."

to

"This value refers to the offset in the buffer specified by the BUFFER ID field to start reading data from. The BUFFER OFFSET field should be less than the size of the buffer , otherwise a CHECK CONDITION status shall be returned with sense key set to ILLEGAL REQUEST and additional sense code set to INVALID FIELD IN CDB."

Wondering about the should ..., then shall ...

RESOLUTION: See MXO comment (it's consistent in that it makes the definition less restrictive - albeit much less restrictive).

Status
rlsheffi Completed 6/14/2006 1:35:26 PM

Sequence number: 10
Author: MXO[MEvans]
Subject: Highlight
Date: 2/16/2006 11:20:40 AM

T Table 22, row 4, description: change to, "The meaning of this field depends on the contents of the MODE field (see 8.7.2)."

Status
rlsheffi Completed 6/14/2006 1:35:14 PM

Sequence number: 11
Author: WDC[CStevens]

Comments from page 56 continued on next page

8.7 READ BUFFER command

8.7.1 READ BUFFER command overview

The READ BUFFER command is used with the write buffer command to determine the integrity of the target device's buffer memory and the physical interconnect that connects the target device and the initiator.

Table 22 — READ BUFFER command CDB fields

Field	Description or reference
OPERATION CODE	The SATL shall issue the ATA READ BUFFER command (E4h) to the attached ATA device.
MODE	8.7.2
BUFFER ID	Unspecified (see 3.4.3)
BUFFER OFFSET	Refers to the offset in the buffer to start reading data from. The BUFFER OFFSET should be less than the size of the buffer size, otherwise a CHECK CONDITION shall be sent back with sense key set to ILLEGAL REQUEST and additional sense code set to INVALID FIELD IN CDB.
ALLOCATION LENGTH	¹³ Refer to individual sections for the meaning of this term.
CONTROL	6.4

The logical sector buffer in a ATA device shall be used to emulate the READ BUFFER command, so the size of the buffer is limited to 512 bytes for data buffer and echo buffers.

8.7.2 MODE field

¹⁵ Table 23 describes modes supported. ¹⁴ ~~Only data and data buffer descriptor shall be supported.~~

Table 23 — MODE field

Code	Translated ATA Opcode
02h (i.e., Data)	Translated to the ATA READ BUFFER command (see 8.7.3).
03h (i.e., Descriptor)	See 8.7.4.
All others	Unspecified (see 3.4.3)

8.7.3 Data Only mode (02h)

In this mode, data is read from the device's logical sector buffer and returned to the requestor. Note that logical sector buffer in the ATA device is being used to emulate the SCSI READ BUFFER command, so the maximum length of data that can be written is 512 bytes. Valid fields in the CDB, apart from the MODE field, are BUFFER ID, BUFFER OFFSET and ALLOCATION LENGTH. The BUFFER OFFSET shall be less than or equal to 512. The ALLOCATION LENGTH shall be less than or equal to 512. ~~write~~ buffer command may sent to the same BUFFER ID before it is read.

8.7.4 Descriptor mode (03h)

Four bytes of information shall be returned to the requestor describing the requested buffer. These four bytes include the OFFSET BOUNDARY and the BUFFER CAPACITY. The BUFFER ID should be set to 0. For all other BUFFER ID's, all zeros shall be returned. ALLOCATION LENGTH should be set to 4.

Subject: Comment on Text
Date: 4/18/2006 9:38:15 PM

T Since an ATA device only has one buffer and a full 512 bytes shall be written, if the buffer offset is non-zero, doesn't an illegal request result.

REASON: Seems most are leaning towards a less restrictive definition which allows things like reading and writing a buffer implemented in the SATL itself. In this case, a SATL could implement anything a SCSI device could implement. The 512 byte limit will be captured in the description of the "data mode" in subclause 8.7.3.

Status
risheffi Rejected 4/18/2006 9:16:42 PM

Sequence number: 12
Author: DELL[KMarks]
Subject: Highlight
Date: 6/14/2006 1:40:14 PM

T Table 22 — READ BUFFER command CDB fields
Row: ALLOCATION LENGTH

change

"Refer to individual sections for the meaning of this term."

to

"This value is dependent on the value in the MODE field (see 8.7.3 and 8.7.4)

RESOLUTION: s/b

"The meaning of this field depends on the contents of the MODE field (see 8.7.2)."

Note - the editor will demote subclause headings 8.7.3 and 8.7.4 to 8.7.2.2 and 8.7.2.3, respectively.

Status
risheffi Completed 6/14/2006 1:40:18 PM

Sequence number: 13
Author: MXO[MEvans]
Subject: Highlight
Date: 4/18/2006 9:23:23 PM

T Table 22, row 5, description: "The meaning of this field depends on the contents of the MODE field (see 8.7.2)."

RESOLUTION: s/b

"The meaning of this field depends on the contents of the MODE field (see 8.7.2, 8.7.3, and 8.7.4)."

Status
risheffi Completed 6/14/2006 1:41:32 PM

Sequence number: 14
Author: EDITOR[risheffi]
Subject: Cross-Out
Date: 4/20/2006 10:19:23 AM

T 8.7.2 MODE field

1st Paragraph

Delete the text, "Only data and data buffer descriptor shall be supported."

Status
risheffi Completed 6/14/2006 1:29:05 PM

Sequence number: 15
Author: DELL[KMarks]
Subject: Highlight
Date: 6/14/2006 1:46:40 PM

T 8.7.2 MODE field

1st Paragraph

change

"Table 23 describes modes supported. Only data and data buffer descriptor shall be supported."

to

"Table 23 describes required supported MODE field values."

The second sentence contradicts the "all others = unspecified"

RESOLUTION: s/b "Table 24 describes values of the mode field that shall be supported."

Delete, "Only data and data buffer descriptor shall be supported", per EDITOR comment.

Status
risheffi Completed 6/14/2006 1:46:47 PM

Sequence number: 16
Author: EDITOR[risheffi]
Subject: Rectangle
Date: 4/18/2006 9:28:24 PM

Comments from page 56 continued on next page

8.7 READ BUFFER command

8.7.1 READ BUFFER command overview

The READ BUFFER command is used with the write buffer command to determine the integrity of the target device's buffer memory and the physical interconnect that connects the target device and the initiator.

Table 22 — READ BUFFER command CDB fields

Field	Description or reference
OPERATION CODE	The SATL shall issue the ATA READ BUFFER command (E4h) to the attached ATA device.
MODE	8.7.2
BUFFER ID	Unspecified (see 3.4.3)
BUFFER OFFSET	Refers to the offset in the buffer to start reading data from. The BUFFER OFFSET should be less than the size of the buffer size, otherwise a CHECK CONDITION shall be sent back with sense key set to ILLEGAL REQUEST and additional sense code set to INVALID FIELD IN CDB.
ALLOCATION LENGTH	Refer to individual sections for the meaning of this term.
CONTROL	6.4

The logical sector buffer in a ATA device shall be used to emulate the READ BUFFER command, so the size of the buffer is limited to 512 bytes for data buffer and echo buffers.

8.7.2 MODE field

Table 23 describes modes supported. ~~Only data and data buffer descriptor shall be supported.~~

Table 23 — MODE field

Code	Translated ATA Opcode
02h (i.e., Data)	Translated to the ATA READ BUFFER command (see 8.7.3).
03h (i.e., Descriptor)	See 8.7.4.
All others	Unspecified (see 3.4.3)

8.7.3 Data Only mode (02h)

In this mode, data is read from the device's logical sector buffer and returned to the requestor. Note that logical sector buffer in the ATA device is being used to emulate the SCSI READ BUFFER command, so the maximum length of data that can be written is 512 bytes. Valid fields in the CDB, apart from the MODE field, are BUFFER ID, BUFFER OFFSET and ALLOCATION LENGTH. The BUFFER OFFSET shall be less than or equal to 512. The ALLOCATION LENGTH shall be less than or equal to 512. A write buffer command may sent to the same BUFFER ID before it is read.

8.7.4 Descriptor mode (03h)

Four bytes of information shall be returned to the requestor describing the requested buffer. These four bytes include the OFFSET BOUNDARY and the BUFFER CAPACITY. The BUFFER ID should be set to 0. For all other BUFFER ID's, all zeros shall be returned. ALLOCATION LENGTH should be set to 4.

 **Table 23 — MODE field**
2nd column title

change
"Translated ATA Opcode"
to
"Description or reference"
(for consistency with other tables)

Status
rlsheffi Completed 6/14/2006 1:50:01 PM

Sequence number: 17
Author: DELL[KMarks]
Subject: Highlight
Date: 4/18/2006 9:29:13 PM

 **Table 23 — MODE field**
2nd column title

change
"Translated ATA Opcode"
to
"Translated ATA command"
REASON: Accepted EDITOR's comment instead (change to "Description or reference" for consistency with other tables).

Status
rlsheffi Rejected 4/18/2006 9:28:37 PM

Sequence number: 18
Author: EDITOR[rlsheffi]
Subject: Highlight
Date: 4/24/2006 1:42:30 PM

 s/b: If the BUFFER ID field is set to 00h, then the translation shall be to the ATA READ BUFFER command (see 8.7.2.1). Otherwise, the translation is unspecified (see 3.4.3).

Status
rlsheffi Completed 6/14/2006 1:53:58 PM

Sequence number: 19
Author: EDITOR[rlsheffi]
Subject: Highlight
Date: 6/14/2006 1:54:38 PM

 **Table 23 — MODE field**
Row: 02h (i.e., Data), second column
Demote subclause headings 8.7.3 and 8.7.4 one heading level to 8.7.2.2 and 8.7.2.3, respectively, and change "8.7.3" to "8.7.2.2".

Status
rlsheffi Completed 6/14/2006 1:54:44 PM

Sequence number: 20
Author: ENDL[RWeber]
Date: 6/14/2006 1:55:10 PM

 table 23, row 2
See 8.7.4. [s/b] 8.7.4
RESOLUTION:
Demote 8.7.3 and 8.7.4 one heading level to 8.7.2.2 and 8.7.2.3, respectively, and change this reference to "8.7.2.3".

Status
rlsheffi Completed 6/14/2006 1:55:13 PM

Sequence number: 21
Author: HPQ[WBellamy]
Subject: Note
Date: 4/18/2006 9:34:09 PM

 Remove the (02h) here, and add it to the text below identifying this code.
RESOLUTION: Removing the "(02h)", but not adding it to the text because the association is made in table 23.

Status
rlsheffi Completed 6/14/2006 1:56:22 PM

Sequence number: 22
Author: IBM[GPenokie]

Comments from page 56 continued on next page

8.7 READ BUFFER command

8.7.1 READ BUFFER command overview

The READ BUFFER command is used with the write buffer command to determine the integrity of the target device's buffer memory and the physical interconnect that connects the target device and the initiator.

Table 22 — READ BUFFER command CDB fields

Field	Description or reference
OPERATION CODE	The SATL shall issue the ATA READ BUFFER command (E4h) to the attached ATA device.
MODE	8.7.2
BUFFER ID	Unspecified (see 3.4.3)
BUFFER OFFSET	Refers to the offset in the buffer to start reading data from. The BUFFER OFFSET should be less than the size of the buffer size, otherwise a CHECK CONDITION shall be sent back with sense key set to ILLEGAL REQUEST and additional sense code set to INVALID FIELD IN CDB.
ALLOCATION LENGTH	Refer to individual sections for the meaning of this term.
CONTROL	6.4

The logical sector buffer in a ATA device shall be used to emulate the READ BUFFER command, so the size of the buffer is limited to 512 bytes for data buffer and echo buffers.

8.7.2 MODE field

Table 23 describes modes supported. ~~Only data and data buffer descriptor shall be supported.~~

Table 23 — MODE field

Code	Translated ATA Opcode
02h (i.e., Data)	Translated to the ATA READ BUFFER command (see 8.7.3).
03h (i.e., Descriptor)	See 8.7.4.
All others	Unspecified (see 3.4.3)

8.7.3 Data Only mode (02h)

²³ In this mode, data is read from the device's logical sector buffer and returned to the requestor. ²⁵ Note that logical sector buffer in the ATA device is being used to emulate the SCSI READ BUFFER command, so the maximum length of data that can be written is 512 bytes. Valid fields in the CDB, apart from the MODE field, are BUFFER ID, BUFFER OFFSET and ALLOCATION LENGTH. The BUFFER OFFSET shall be less than or equal to 512. The ALLOCATION LENGTH shall be less than or equal to 512. ~~write~~ buffer command may sent to the same BUFFER ID before it is read.

8.7.4 Descriptor mode (03h)

Four bytes of information shall be returned to the requestor describing the requested buffer. These four bytes include the OFFSET BOUNDARY and the BUFFER CAPACITY. The BUFFER ID should be set to 0. For all other BUFFER ID's, all zeros shall be returned. ALLOCATION LENGTH should be set to 4.

Subject: Underline
Date: 2/16/2006 1:44:26 PM
T 8.7.3 Data Only mode (02h)

Status
rlsheffi Cancelled 4/18/2006 9:30:04 PM

Sequence number: 23
Author: DELL[KMarks]
Subject: Highlight
Date: 6/14/2006 1:57:10 PM
T 8.7.3 Data Only mode (02h)
change
subclause title to
"8.7.3 Data mode (02h)"
RESOLUTION: s/b
"8.7.2.2 Data mode"

Status
rlsheffi Completed 6/14/2006 1:56:44 PM

Sequence number: 24
Author: DELL[KMarks]
Subject: Highlight
Date: 8/28/2006 1:28:56 PM
T 8.7.3 Data Only mode (02h)

1st Paragraph
change

"In this mode, data is read from the device's logical sector buffer and returned to the requestor. Note that logical sector buffer in the ATA device is being used to emulate the SCSI READ BUFFER command, so the maximum length of data that can be written is 512 bytes. Valid fields in the CDB, apart from the MODE field, are BUFFER ID, BUFFER OFFSET and ALLOCATION LENGTH. The BUFFER OFFSET shall be less than or equal to 512. The ALLOCATION LENGTH shall be less than or equal to 512. A write buffer command may sent to the same BUFFER ID before it is read."

to

"In this mode, data is read from the logical sector buffer of the device and returned to the application client. The logical sector buffer in an ATA device is being used to emulate the READ BUFFER command, so the maximum length of data that may be read is 512 bytes. Valid fields in the CDB, apart from the MODE field, are BUFFER ID, BUFFER OFFSET and ALLOCATION LENGTH fields. The BUFFER OFFSET field shall be less than or equal to 512. The ALLOCATION LENGTH shall be less than or equal to 512. A WRITE BUFFER command may be sent to the same buffer ID before it is read with the READ BUFFER command."

RESOLUTION: s/b

"If the BUFFER ID field is set to 00h, the BUFFER OFFSET field is set to 00h, and the ALLOCATION LENGTH field is set to 512, then the SATL shall return 512 bytes of data.

If the BUFFER ID field is set to 00h, the BUFFER OFFSET field is set to 00h, and the ALLOCATION LENGTH field is set to a value other than 512, then the SATL shall either:

- a) return the the lesser of 512 bytes of data or the number of bytes specified in the ALLOCATION LENGTH field from the buffer in the ATA device by sending an ATA READ BUFFER command to the ATA device; or
- b) terminate the command with CHECK CONDITION status with the sense key set to ILLEGAL REQUEST with the additional sense code set to INVALID FIELD IN CDB.

If the BUFFER ID field is set to 00h and the BUFFER OFFSET field is set to a value other than 00h then the SATL shall terminate the command with CHECK CONDITION status with the sense key set to ILLEGAL REQUEST with the additional sense code set to INVALID FIELD IN CDB.

The SATL may support a value other than 00h in the BUFFER ID field. If the SATL supports a value other than 00h in the BUFFER ID field the implementation shall be as defined in SPC-3.

A WRITE BUFFER command may be sent to the same buffer ID before it is read with the READ BUFFER command."

Status
rlsheffi Completed 8/29/2006 3:34:50 PM

Sequence number: 25
Author: IBM[GPenokie]
Subject: Highlight
Date: 8/29/2006 3:35:24 PM

Comments from page 56 continued on next page

8.7 READ BUFFER command

8.7.1 READ BUFFER command overview

The READ BUFFER command is used with the write buffer command to determine the integrity of the target device's buffer memory and the physical interconnect that connects the target device and the initiator.

Table 22 — READ BUFFER command CDB fields

Field	Description or reference
OPERATION CODE	The SATL shall issue the ATA READ BUFFER command (E4h) to the attached ATA device.
MODE	8.7.2
BUFFER ID	Unspecified (see 3.4.3)
BUFFER OFFSET	Refers to the offset in the buffer to start reading data from. The BUFFER OFFSET should be less than the size of the buffer size, otherwise a CHECK CONDITION shall be sent back with sense key set to ILLEGAL REQUEST and additional sense code set to INVALID FIELD IN CDB.
ALLOCATION LENGTH	Refer to individual sections for the meaning of this term.
CONTROL	6.4

The logical sector buffer in a ATA device shall be used to emulate the READ BUFFER command, so the size of the buffer is limited to 512 bytes for data buffer and echo buffers.

8.7.2 MODE field

Table 23 describes modes supported. ~~Only data and data buffer descriptor shall be supported.~~

Table 23 — MODE field

Code	Translated ATA Opcode
02h (i.e., Data)	Translated to the ATA READ BUFFER command (see 8.7.3).
03h (i.e., Descriptor)	See 8.7.4.
All others	Unspecified (see 3.4.3)

8.7.3 Data Only mode (02h)

In this mode, data is read from the device's logical sector buffer and returned to the requestor. Note that logical sector buffer in the ATA device is being used to emulate the SCSI READ BUFFER command, so the maximum length of data that can be written is 512 bytes. Valid fields in the CDB, apart from the MODE field, are BUFFER ID, BUFFER OFFSET and ALLOCATION LENGTH. The BUFFER OFFSET shall be less than or equal to 512. The ALLOCATION LENGTH shall be less than or equal to 512. ~~Write buffer command shall be sent to the same BUFFER ID before it is read.~~

8.7.4 Descriptor mode (03h)

Four bytes of information shall be returned to the requestor describing the requested buffer. These four bytes include the OFFSET BOUNDARY and the BUFFER CAPACITY. The BUFFER ID should be set to 0. For all other BUFFER ID's, all zeros shall be returned. ALLOCATION LENGTH should be set to 4.

T This << Note that logical sector buffer in the ATA device is being used to emulate the SCSI READ BUFFER command, so the maximum length of data that can be written is 512 bytes. >> should either be made into a real note or changed to << The logical sector buffer in the ATA device is being used to emulate the SCSI READ BUFFER command, so the maximum length of data that is allowed to be written is 512 bytes. >> but in either case the evil << can >> needs to be removed.
RESOLUTION: See DELL comment.

Status
rlsheffi Completed 8/29/2006 3:35:30 PM

Sequence number: 26
Author: MXO[MEvans]
Subject: Highlight
Date: 8/29/2006 3:35:53 PM
T 8.7.3 Data only mode: change "can" to "may".
RESOLUTION: See Dell comment

Status
rlsheffi Completed 8/29/2006 3:35:59 PM

Sequence number: 27
Author: SIERLGC[BMartin]
Subject: Highlight
Date: 9/13/2006 8:24:39 AM
T Page 36, 8.7.3, second sentence
"can" s.b. "may"
RESOLUTION: See Dell comment

Status
rlsheffi Completed 9/13/2006 8:24:23 AM

Sequence number: 28
Author: IBM[GPenokie]
Subject: Note
Date: 6/24/2006 1:57:02 PM
 The term << device >> should not stand alone. I believe in this paragraph it should be << target device >>.
DISCUSS FLAG
RESOLUTION: See DELL comment, but I believe the intent in this paragraph is to use an actual 512-byte buffer in the ATA device, so the term << device >> will appear as << ATA device >>.

Status
rlsheffi Completed 8/29/2006 3:37:01 PM

Sequence number: 29
Author: MXO[MEvans]
Subject: Note
Date: 8/28/2006 1:35:37 PM
 8.7.3 Data only mode: before the last sentence add, "If the value in either the BUFFER OFFSET field or the ALLOCATION LENGTH field is greater than 512, then the SATL shall terminate the command with CHECK CONDITION status with the sense key set to ILLEGAL REQUEST with the additional sense code set to INVALID FIELD IN CDB."

RESOLUTION: See DELL comment.

Status
rlsheffi Completed 8/29/2006 3:37:23 PM

Sequence number: 30
Author: SIERLGC[BMartin]
Subject: Highlight
Date: 8/28/2006 1:36:22 PM
T Page 36, 8.7.3, last sentence
"may sent" s.b. "may be sent"
RESOLUTION: See DELL comment.

Status
rlsheffi Completed 8/29/2006 3:37:40 PM

Sequence number: 31
Author: WDC[CStevens]
Subject: Comment on Text
Date: 8/28/2006 1:36:35 PM
T command may be sent.
RESOLUTION: See DELL comment.

Status

Comments from page 56 continued on next page

8.7 READ BUFFER command

8.7.1 READ BUFFER command overview

The READ BUFFER command is used with the write buffer command to determine the integrity of the target device's buffer memory and the physical interconnect that connects the target device and the initiator.

Table 22 — READ BUFFER command CDB fields

Field	Description or reference
OPERATION CODE	The SATL shall issue the ATA READ BUFFER command (E4h) to the attached ATA device.
MODE	8.7.2
BUFFER ID	Unspecified (see 3.4.3)
BUFFER OFFSET	Refers to the offset in the buffer to start reading data from. The BUFFER OFFSET should be less than the size of the buffer size, otherwise a CHECK CONDITION shall be sent back with sense key set to ILLEGAL REQUEST and additional sense code set to INVALID FIELD IN CDB.
ALLOCATION LENGTH	Refer to individual sections for the meaning of this term.
CONTROL	6.4

The logical sector buffer in a ATA device shall be used to emulate the READ BUFFER command, so the size of the buffer is limited to 512 bytes for data buffer and echo buffers.

8.7.2 MODE field

Table 23 describes modes supported. ~~Only data and data buffer descriptor shall be supported.~~

Table 23 — MODE field

Code	Translated ATA Opcode
02h (i.e., Data)	Translated to the ATA READ BUFFER command (see 8.7.3).
03h (i.e., Descriptor)	See 8.7.4.
All others	Unspecified (see 3.4.3)

8.7.3 Data Only mode (02h)

In this mode, data is read from the device's logical sector buffer and returned to the requestor. Note that logical sector buffer in the ATA device is being used to emulate the SCSI READ BUFFER command, so the maximum length of data that can be written is 512 bytes. Valid fields in the CDB, apart from the MODE field, are BUFFER ID, BUFFER OFFSET and ALLOCATION LENGTH. The BUFFER OFFSET shall be less than or equal to 512. The ALLOCATION LENGTH shall be less than or equal to 512. ~~write~~ command may sent to the same BUFFER ID before it is read.

8.7.4 Descriptor mode (03h)

Four bytes of information shall be returned to the requestor describing the requested buffer. These four bytes include the OFFSET BOUNDARY and the BUFFER CAPACITY. The BUFFER ID should be set to 0. For all other BUFFER ID's, all zeros shall be returned. ALLOCATION LENGTH should be set to 4.

rlsheffi Completed 8/29/2006 3:38:27 PM

Sequence number: 32
Author: IBM[GPenokie]
Subject: Note
Date: 8/28/2006 1:36:48 PM

 All the field names in this paragraph needs to have the term << field >> placed after them.
RESOLUTION: See Dell comment

Status
rlsheffi Completed 8/28/2006 1:36:53 PM

Sequence number: 33
Author: HPQ[WBellamy]
Subject: Note
Date: 4/18/2006 10:04:25 PM

 Remove the (03h) here, and add it to the text below identifying this code.
RESOLUTION: Removing the "(03h)", but omitting it from text because the association is made in table 23.

Status
rlsheffi Completed 6/14/2006 2:00:51 PM

Sequence number: 34
Author: IBM[GPenokie]
Subject: Underline
Date: 2/16/2006 1:45:20 PM
T 8.7.4 Descriptor mode (03h)

Status
rlsheffi Cancelled 4/18/2006 10:04:43 PM

Sequence number: 35
Author: DELL[KMarks]
Subject: Highlight
Date: 8/28/2006 1:59:35 PM

T 8.7.4 Descriptor mode (03h)
1st Paragraph

change

"Four bytes of information shall be returned to the requestor describing the requested buffer. These four bytes include the OFFSET BOUNDARY and the BUFFER CAPACITY. The BUFFER ID should be set to 0. For all other BUFFER ID's, all zeros shall be returned. ALLOCATION LENGTH should be set to 4."

to

"Four bytes of data shall be returned to the application client describing the requested buffer. These four bytes include the OFFSET BOUNDARY and BUFFER CAPACITY fields. The BUFFER ID field should be set to zero. For all other BUFFER ID's, all zeros shall be returned. The BUFFER OFFSET field is Reserved in the this mode. The ALLOCATION LENGTH should be set to 4h."

RESOLUTION: s/b

"If the allocation length field is set to less than four, the SATL shall return CHECK CONDITION status with the sense key set to ILLEGIAL REQUEST and the additional sense code set to INVALID FIELD IN CDB.

If the allocation length field is set to four or greater, the SATL shall return four bytes of data describing the requested buffer, including the OFFSET BOUNDARY field and the BUFFER CAPACITY field.

If the BUFFER ID field is set to zero then the SATL shall return values in the OFFSET BOUNDARY field and the BUFFER CAPACITY field describing the buffer in the ATA device that is accessible using the ATA READ BUFFER command and the ATA WRITE BUFFER command by returning a value of FFh in the OFFSET BOUNDARY field (i.e., zero is the only supported value in the BUFFER OFFSET field) and a value of 200h (i.e., 512 bytes) in the BUFFER CAPACITY field.

The SATL may support a value other than zero in the BUFFER ID field. If the SATL supports a value other than zero in the BUFFER ID field the implementation shall be as defined in SPC-3."

Status
rlsheffi Completed 8/29/2006 3:45:12 PM

Sequence number: 36
Author: IBM[GPenokie]
Subject: Highlight
Date: 8/28/2006 1:59:00 PM

T The << 0 >> should be << zero >> and the << 4 >> should be << four >>.
RESOLUTION: See Dell comment

Comments from page 56 continued on next page

8.7 READ BUFFER command

8.7.1 READ BUFFER command overview

The READ BUFFER command is used with the write buffer command to determine the integrity of the target device's buffer memory and the physical interconnect that connects the target device and the initiator.

Table 22 — READ BUFFER command CDB fields

Field	Description or reference
OPERATION CODE	The SATL shall issue the ATA READ BUFFER command (E4h) to the attached ATA device.
MODE	8.7.2
BUFFER ID	Unspecified (see 3.4.3)
BUFFER OFFSET	Refers to the offset in the buffer to start reading data from. The BUFFER OFFSET should be less than the size of the buffer size, otherwise a CHECK CONDITION shall be sent back with sense key set to ILLEGAL REQUEST and additional sense code set to INVALID FIELD IN CDB.
ALLOCATION LENGTH	Refer to individual sections for the meaning of this term.
CONTROL	6.4

The logical sector buffer in a ATA device shall be used to emulate the READ BUFFER command, so the size of the buffer is limited to 512 bytes for data buffer and echo buffers.

8.7.2 MODE field

Table 23 describes modes supported. ~~Only data and data buffer descriptor shall be supported.~~

Table 23 — MODE field

Code	Translated ATA Opcode
02h (i.e., Data)	Translated to the ATA READ BUFFER command (see 8.7.3).
03h (i.e., Descriptor)	See 8.7.4.
All others	Unspecified (see 3.4.3)

8.7.3 Data Only mode (02h)

In this mode, data is read from the device's logical sector buffer and returned to the requestor. Note that logical sector buffer in the ATA device is being used to emulate the SCSI READ BUFFER command, so the maximum length of data that can be written is 512 bytes. Valid fields in the CDB, apart from the MODE field, are BUFFER ID, BUFFER OFFSET and ALLOCATION LENGTH. The BUFFER OFFSET shall be less than or equal to 512. The ALLOCATION LENGTH shall be less than or equal to 512. ~~write~~ buffer command may sent to the same BUFFER ID before it is read.

8.7.4 Descriptor mode (03h)

Four bytes of information shall be returned to the requestor describing the requested buffer. These four bytes include the OFFSET BOUNDARY and the BUFFER CAPACITY. The BUFFER ID should be set to 0. For all other BUFFER ID's, all zeros shall be returned. ALLOCATION LENGTH should be set to 4.

Status
risheffi Completed 8/29/2006 3:45:32 PM

Sequence number: 37
Author: IBM[GPenokie]
Subject: Note
Date: 8/28/2006 1:59:06 PM

 All the field names in this paragraph needs to have the term << field >> placed after them.
RESOLUTION: See Dell comment

Status
risheffi Completed 8/29/2006 3:45:48 PM

8.8 READ MEDIA SERIAL NUMBER command

8.8.1 READ MEDIA SERIAL NUMBER command overview

READ MEDIA SERIAL NUMBER returns the serial number of the currently mounted media, as returned by the device. This command is emulated in the ATA environment as ATA provides no direct corresponding command to the device.



Table 24 — READ MEDIA SERIAL NUMBER command CDB fields

Field	Description or reference
OPERATION CODE	See 8.8.2
SERVICE ACTION	As defined in SPC-3
ALLOCATION LENGTH	As defined in SPC-3
CONTROL	6.4

8.8.2 READ MEDIA SERIAL NUMBER emulation

A SATL emulating the READ MEDIA SERIAL NUMBER command shall issue an IDENTIFY DEVICE (ECh) ATA opcode to the attached ATA device. If the IDENTIFY DEVICE command completes with success, the SATL shall return a media serial number to the application client as defined in SPC-3. The media serial number shall be generated as follows:

1) If IDENTIFY DEVICE data, word 87, bit 2 is set, the SATL shall return the media serial number located in words 176-205. The data from the media serial number shall be treated as an ASCII string, defined in ATA/ATAPI-7.

2) If IDENTIFY DEVICE data, word 87, bit 2 is not set, the SATL shall issue a READ VERIFY SECTOR(S) or READ VERIFY SECTOR(S) EX to LBA 0. Alternatively, if the ATA device indicates support for the Removable Media Status Notification feature set, the SATL may issue a GET MEDIA STATUS command to verify presence of the media. If the READ VERIFY SECTOR(S) or READ VERIFY SECTOR(S) EX commands complete successfully, or the GET MEDIA STATUS command completes successfully without the NM bit set, the SATL shall return a media serial number of zero as defined in SPC-3. Otherwise, the SATL shall terminate the command with CHECK CONDITION status, with the sense key set to NOT READY, and the additional sense code set to MEDIUM NOT PRESENT.

8.9 REQUEST SENSE command

8.9.1 REQUEST SENSE command overview

The REQUEST SENSE command requests any available sense data to be returned to the application client. A SATL may implement sense data processing as defined SAM-2 and not support autosense (see 3.1.21). If the SCSI transport protocol for the SATL supports autosense (see 3.1.21) the SATL shall support autosense (see SAM-3). The SATL shall implement the REQUEST SENSE command as specified in SPC-3.

The SATL shall determine if any of the conditions listed in table 25 exist. If none of these conditions exist and the SATL has no status other than GOOD to return, the SATL shall complete this command with GOOD status

Sequence number: 1
Author: EDITOR[risheffi]
Subject: Rectangle
Date: 5/11/2006 1:17:21 PM

 **8.8 READ MEDIA SERIAL NUMBER command**

Remove subclause 8.8 because SAT reports as device-type zero (block commands device), and this command is not a supported command for block devices (as listed in subclause 5.1 in SBC-2). Need to fix SBC-3, and this can be added back in SAT-2.

Status
risheffi Completed 6/14/2006 3:15:31 PM

Sequence number: 2
Author: IBM[GPenokie]
Subject: Underline
Date: 2/16/2006 1:39:40 PM

 **8.8.1 READ MEDIA SERIAL NUMBER command overview**

Status
risheffi Cancelled 4/19/2006 1:34:58 PM

Sequence number: 3
Author: DELL[KMarks]
Subject: Highlight
Date: 6/14/2006 3:12:45 PM

 **8.8.1 READ MEDIA SERIAL NUMBER command overview**

1st Paragraph change

"READ MEDIA SERIAL NUMBER returns the serial number of the currently mounted media, as returned by the device. This command is emulated in the ATA environment as ATA provides no direct corresponding command to the device."

to

"READ MEDIA SERIAL NUMBER returns the serial number of the currently mounted media, as returned by the ATA device. This command is emulated in the ATA environment as ATA provides no direct corresponding command to the ATA device. Table 24 shows the translation for fields specified in the READ MEDIA SERIAL NUMBER CDB."

Suggested: s/b

"The READ MEDIA SERIAL NUMBER command returns the serial number of the currently mounted media, as returned by the ATA device. This command is emulated in the by the SATL, as ATA8-ACS defines no direct corresponding command to the ATA device. Table 24 shows the translation for fields specified in the READ MEDIA SERIAL NUMBER CDB."

RESOLUTION: Remove subclause 8.8 (see EDITOR's comment)

Status
risheffi Completed 6/14/2006 3:15:56 PM

Sequence number: 4
Author: IBM[GPenokie]
Subject: Highlight
Date: 6/14/2006 3:12:58 PM

 There is no reference to table 24. This needs to be fixed as all tables have to be referenced.

RESOLUTION: Remove subclause 8.8 (see EDITOR's comment)

Status
risheffi Completed 6/14/2006 3:16:03 PM

Sequence number: 5
Author: HPQ[RElliott]
Date: 6/14/2006 3:13:11 PM

 **8.8.1**

need a reference to table 24

RESOLUTION: Remove subclause 8.8 (see EDITOR's comment)

Status
risheffi Completed 6/14/2006 3:16:09 PM

Sequence number: 6
Author: IBM[GPenokie]
Subject: Note

8.8 READ MEDIA SERIAL NUMBER command

8.8.1 READ MEDIA SERIAL NUMBER command overview

READ MEDIA SERIAL NUMBER returns the serial number of the currently mounted media, as returned by the device. This command is emulated in the ATA environment as ATA provides no direct corresponding command to the device.



Table 24 — READ MEDIA SERIAL NUMBER command CDB fields

Field	Description or reference
OPERATION CODE	See 8.8.2
SERVICE ACTION	As defined in SPC-3
ALLOCATION LENGTH	7s defined in SPC-3
CONTROL	6.4

10.2 READ 9 MEDIAL SERIAL NUMBER emulation

12 SATL emulating the READ MEDIA SERIAL NUMBER command shall issue an 11 IDENTIFY DEVICE (ECh) ATA opcode to the attached ATA device. If the IDENTIFY DEVICE command completes with success, the SATL shall return a media serial number to the application client as defined in SPC-3. The media serial number shall be generated as follows:

1) If IDENTIFY DEVICE data, word 87, bit 2 is set, the SATL shall return the media serial number located in words 176-205. The data from the medial serial number shall be treated as an ASCII string, defined in ATA/ATAPI-7.



2) If IDENTIFY DEVICE data, word 87, bit 2 is not set, the SATL shall issue a READ VERIFY SECTOR(S) or READ VERIFY SECTOR(S) EX to LBA 0. Alternatively, if the ATA device indicates support for the Removable Media Status Notification feature set, the SATL may issue a GET MEDIA STATUS command to verify presence of the medial. If the READ VERIFY SECTOR(S) or READ VEIRFY SECTOR(S) EX commands complete successfully, or the GET MEDIA STATUS command completes successfully without the NM bit set, the SATL shall return a media serial number of zero as defined in SPC-3. Otherwise, the SATL shall terminate the command with CHECK CONDITION status, with the sense key set to NOT READY, and the additional sense code set to MEDIUM NOT PRESENT.

8.9 REQUEST SENSE command

8.9.1 REQUEST SENSE command overview

The REQUEST SENSE command requests any available sense data to be returned to the application client. A SATL may implement sense data processing as defined SAM-2 and not support autosense (see 3.1.21). If the SCSI transport protocol for the SATL supports autosense (see 3.1.21) the SATL shall support autosense (see SAM-3). The SATL shall implement the REQUEST SENSE command as specified in SPC-3.

The SATL shall determine if any of the conditions listed in table 25 exist. If none of these conditions exist and the SATL has no status other than GOOD to return, the SATL shall complete this command with GOOD status

Date: 6/14/2006 3:13:22 PM

 The term << device >> should not stand alone. I believe in this paragraph it should be << target device >>. RESOLUTION: Remove subclause 8.8 (see EDITOR's comment)

Status
rlsheffi Completed 6/14/2006 3:16:16 PM

Sequence number: 7
Author: DELL[KMarks]
Subject: Highlight
Date: 6/14/2006 3:09:31 PM

 Table 24
change

"As defined in SPC-3"
to

"This field specifies the number bytes allocated for the returned media serial number. This field shall be implemented as described in SPC-3."

To match other commands.

RESOLUTION: Remove subclause 8.8 (see EDITOR's comment)

Status
rlsheffi Completed 6/14/2006 3:16:24 PM

Sequence number: 8
Author: IBM[GPenokie]
Subject: Underline
Date: 2/16/2006 1:42:14 PM

 8.8.2 READ MEDIAL SERIAL NUMBER emulation

Status
rlsheffi Cancelled 4/26/2006 2:02:46 PM

Sequence number: 9
Author: QDSS[PSuhler]
Subject: Highlight
Date: 6/14/2006 3:09:48 PM

 Page: 57
8.8.2

Editorial

"READ MEDIAL SERIAL NUMBER emulation"

s/b "READ MEDIA SERIAL NUMBER emulation"

RESOLUTION: Remove subclause 8.8 (see EDITOR's comment)

Status
rlsheffi Completed 6/14/2006 3:16:30 PM

Sequence number: 10
Author: MXO[MEvans]
Subject: Highlight
Date: 6/14/2006 3:09:52 PM

 8.8.2 READ MEDIAL SERIAL NUMBER emulation: change to, "8.8.2 READ MEDIA SERIAL NUMBER emulation".

RESOLUTION: Remove subclause 8.8 (see EDITOR's comment)

Status
rlsheffi Completed 6/14/2006 3:16:36 PM

Sequence number: 11
Author: HPQ[RElliott]
Subject: Highlight
Date: 6/14/2006 3:13:41 PM

 8.8.2

"IDENTIFY DEVICE (ECh) ATA opcode" s/b "IDENTIFY DEVICE command"

RESOLUTION: Remove subclause 8.8 (see EDITOR's comment)

Status
rlsheffi Completed 6/14/2006 3:16:44 PM

Sequence number: 12
Author: DELL[KMarks]
Subject: Highlight
Date: 6/14/2006 3:10:01 PM

Comments from page 57 continued on next page

8.8 READ MEDIA SERIAL NUMBER command

8.8.1 READ MEDIA SERIAL NUMBER command overview

READ MEDIA SERIAL NUMBER returns the serial number of the currently mounted media, as returned by the device. This command is emulated in the ATA environment as ATA provides no direct corresponding command to the device.



Table 24 — READ MEDIA SERIAL NUMBER command CDB fields

Field	Description or reference
OPERATION CODE	See 8.8.2
SERVICE ACTION	As defined in SPC-3
ALLOCATION LENGTH	As defined in SPC-3
CONTROL	6.4

8.8.2 READ MEDIA SERIAL NUMBER emulation

A SATL emulating the READ MEDIA SERIAL NUMBER command shall issue an IDENTIFY DEVICE (ECh) ATA opcode to the attached ATA device. If the IDENTIFY DEVICE command completes with success, the SATL shall return a media serial number to the application client as defined in SPC-3. The media serial number shall be generated as follows:

1) If IDENTIFY DEVICE data, word 87, bit 2 is set, the SATL shall return the media serial number located in words 176-205. The data from the media serial number shall be treated as an ASCII string, defined in ATA/ATAPI-7.

2) If IDENTIFY DEVICE data, word 87, bit 2 is not set, the SATL shall issue a READ VERIFY SECTOR(S) or READ VERIFY SECTOR(S) EX to LBA 0. Alternatively, if the ATA device indicates support for the Removable Media Status Notification feature set, the SATL may issue a GET MEDIA STATUS command to verify presence of the media. If the READ VERIFY SECTOR(S) or READ VERIFY SECTOR(S) EX commands complete successfully, or the GET MEDIA STATUS command completes successfully without the NM bit set, the SATL shall return a media serial number of zero as defined in SPC-3. Otherwise, the SATL shall terminate the command with CHECK CONDITION status, with the sense key set to NOT READY, and the additional sense code set to MEDIUM NOT PRESENT.

8.9 REQUEST SENSE command

8.9.1 REQUEST SENSE command overview

The REQUEST SENSE command requests any available sense data to be returned to the application client. A SATL may implement sense data processing as defined SAM-2 and not support autosense (see 3.1.21). If the SCSI transport protocol for the SATL supports autosense (see 3.1.21) the SATL shall support autosense (see SAM-3). The SATL shall implement the REQUEST SENSE command as specified in SPC-3.

The SATL shall determine if any of the conditions listed in table 25 exist. If none of these conditions exist and the SATL has no status other than GOOD to return, the SATL shall complete this command with GOOD status

T 8.8.2 READ MEDIAL SERIAL NUMBER emulation
1st Paragraph

"A SATL emulating the READ MEDIA SERIAL NUMBER command shall issue an IDENTIFY DEVICE (ECh) ATA opcode to the attached ATA device. If the IDENTIFY DEVICE command completes with success, the SATL shall return a media serial number to the application client as defined in SPC-3. The media serial number shall be generated as follows:"

to

"A SATL emulating the READ MEDIA SERIAL NUMBER command shall issue an ATA IDENTIFY DEVICE command to the ATA device. If the ATA IDENTIFY DEVICE command completes with no error, the SATL shall return a media serial number to the application client in the format defined in SPC-3. The media serial number shall be generated as follows:"

RESOLUTION: Remove subclause 8.8 (see EDITOR's comment)

Status
rlsheffi Completed 6/14/2006 3:16:52 PM

Sequence number: 13
Author: HPQ[RElliott]
Subject: Highlight
Date: 6/14/2006 3:10:07 PM

T 8.8.2

set s/b "set to one"

RESOLUTION: Remove subclause 8.8 (see EDITOR's comment)

Status
rlsheffi Completed 6/14/2006 3:16:59 PM

Sequence number: 14
Author: DELL[KMarks]
Subject: Highlight
Date: 6/14/2006 3:13:54 PM

T 8.8.2 READ MEDIAL SERIAL NUMBER emulation
1st Paragraph , 1) in 1,2 list.

"1) If IDENTIFY DEVICE data, word 87, bit 2 is set, the SATL shall return the media serial number located in words 176-205. The data from the medial serial number shall be treated as an ASCII string, defined in ATA/ATAPI-7"

to

"a) If ATA IDENTIFY DEVICE data, word 87, bit 2 is set to one, the SATL shall return the media serial number located in words 176-205. The data from the medial serial number shall be treated as an ASCII string, defined in ATA/ATAPI-7; or"

Don't see why this is an ordered list?

Any requirements on endian when returning from ATA to SCSI?

Suggested (as suggested, but change "medial" to "media" and "defined" to "as defined"):

"a) If ATA IDENTIFY DEVICE data, word 87, bit 2 is set to one, the SATL shall return the media serial number located in words 205:176. The data from the media serial number shall be treated as an ASCII string (see ATA8-ACS); or"

RESOLUTION: Remove subclause 8.8 (see EDITOR's comment)

Status
rlsheffi Completed 6/14/2006 3:17:07 PM

Sequence number: 15
Author: ELX[KHirata]
Subject: Highlight
Date: 6/14/2006 3:10:20 PM
T Location: Page 37, 8.8.2, Numbered item 1, Second sentence

Comment:

Typo. "medial" should be "media"

RESOLUTION: Remove subclause 8.8 (see EDITOR's comment)

Status
rlsheffi Completed 6/14/2006 3:17:14 PM

Sequence number: 16
Author: HPQ[RElliott]
Subject: Highlight

Comments from page 57 continued on next page

8.8 READ MEDIA SERIAL NUMBER command

8.8.1 READ MEDIA SERIAL NUMBER command overview

READ MEDIA SERIAL NUMBER returns the serial number of the currently mounted media, as returned by the device. This command is emulated in the ATA environment as ATA provides no direct corresponding command to the device.



Table 24 — READ MEDIA SERIAL NUMBER command CDB fields

Field	Description or reference
OPERATION CODE	See 8.8.2
SERVICE ACTION	As defined in SPC-3
ALLOCATION LENGTH	As defined in SPC-3
CONTROL	6.4

8.8.2 READ MEDIA SERIAL NUMBER emulation

A SATL emulating the READ MEDIA SERIAL NUMBER command shall issue an IDENTIFY DEVICE (ECh) ATA opcode to the attached ATA device. If the IDENTIFY DEVICE command completes with success, the SATL shall return a media serial number to the application client as defined in SPC-3. The media serial number shall be generated as follows:

- 1) If IDENTIFY DEVICE data, word 87, bit 2 is set, the SATL shall return the media serial number located in words 176-205. The data from the medial serial number¹⁷ shall be treated as an ASCII¹⁸ string, defined in ATA/ATAPI-7.



- 2) If IDENTIFY DEVICE data, word 87, bit 2 is not set, the SATL shall issue a READ VERIFY SECTOR(S) or READ VERIFY SECTOR(S) EX to LBA 0. Alternatively, if the ATA device indicates support for the Removable Media Status Notification feature set, the SATL may issue a GET MEDIA STATUS command to verify presence of the medial. If the READ VERIFY SECTOR(S) or READ VEIRFY SECTOR(S) EX commands complete successfully, or the GET MEDIA STATUS command completes successfully without the NM bit set, the SATL shall return a media serial number of zero as defined in SPC-3. Otherwise, the SATL shall terminate the command with CHECK CONDITION status, with the sense key set to NOT READY, and the additional sense code set to MEDIUM NOT PRESENT.

8.9 REQUEST SENSE command

8.9.1 REQUEST SENSE command overview

The REQUEST SENSE command requests any available sense data to be returned to the application client. A SATL may implement sense data processing as defined SAM-2 and not support autosense (see 3.1.21). If the SCSI transport protocol for the SATL supports autosense (see 3.1.21) the SATL shall support autosense (see SAM-3). The SATL shall implement the REQUEST SENSE command as specified in SPC-3.

The SATL shall determine if any of the conditions listed in table 25 exist. If none of these conditions exist and the SATL has no status other than GOOD to return, the SATL shall complete this command with GOOD status

Date: 6/14/2006 3:10:25 PM

T 8.8.2

Change "words 176-205" to "words 205:176"

RESOLUTION: Remove subclause 8.8 (see EDITOR's comment)

Status

risheffi Completed 6/14/2006 3:17:21 PM

Sequence number: 17

Author: IBM[GPenokie]

Subject: Comment on Text

Date: 6/14/2006 3:10:29 PM

T item 1

This << shall be treated as an ASCII string, defined in ATA/ATAPI-7 >> should be << shall be an ASCII string as defined in ATA/ATAPI-7; and >>

RESOLUTION: See DELL comment (changed to an unordered list with "or" rather than an ordered list with "and". Took ENDL comment "... string (see ATA/ATAPI-7).", and changed "ATA/ATAPI-7" to "ATA8-ACS".

RESOLUTION: Remove subclause 8.8 (see EDITOR's comment)

Status

risheffi Completed 6/14/2006 3:17:28 PM

Sequence number: 18

Author: ENDL[RWeber]

Date: 6/14/2006 3:10:34 PM

T 1,2 list, entry 1, s 2

string, defined in ATA/ATAPI-7. [s/b] string (see ATA/ATAPI-7).

RESOLUTION: Remove subclause 8.8 (see EDITOR's comment)

Status

risheffi Completed 6/14/2006 3:17:35 PM

Sequence number: 19

Author: ENDL[RWeber]

Date: 6/14/2006 3:10:43 PM

T 1,2 list

This list is not properly structured. Entry 1 ends with a period. There is no conjunction between entries 1 and 2.

RESOLUTION: Remove subclause 8.8 (see EDITOR's comment)

Status

risheffi Completed 6/14/2006 3:17:41 PM

Sequence number: 20

Author: HPQ[RElliott]

Subject: Highlight

Date: 6/14/2006 3:10:49 PM

T 8.8.2

"not set" s/b "set to zero"

RESOLUTION: Remove subclause 8.8 (see EDITOR's comment)

Status

risheffi Completed 6/14/2006 3:17:50 PM

Sequence number: 21

Author: IBM[GPenokie]

Subject: Comment on Text

Date: 6/14/2006 3:10:56 PM

T item 2

This << word 87, bit 2 is not set, the SATL shall >> should be << word 87, bit 2 is not set to one, the SATL shall >>

RESOLUTION: Remove subclause 8.8 (see EDITOR's comment)

Status

risheffi Completed 6/14/2006 3:17:57 PM

Sequence number: 22

Author: DELL[KMarks]

Subject: Highlight

Date: 6/14/2006 3:14:14 PM

T 8.8.2 READ MEDIAL SERIAL NUMBER emulation

1st Paragraph , 2) in 1,2 list.

Comments from page 57 continued on next page

8.8 READ MEDIA SERIAL NUMBER command

8.8.1 READ MEDIA SERIAL NUMBER command overview

READ MEDIA SERIAL NUMBER returns the serial number of the currently mounted media, as returned by the device. This command is emulated in the ATA environment as ATA provides no direct corresponding command to the device.



Table 24 — READ MEDIA SERIAL NUMBER command CDB fields

Field	Description or reference
OPERATION CODE	See 8.8.2
SERVICE ACTION	As defined in SPC-3
ALLOCATION LENGTH	As defined in SPC-3
CONTROL	6.4

8.8.2 READ MEDIA SERIAL NUMBER emulation

A SATL emulating the READ MEDIA SERIAL NUMBER command shall issue an IDENTIFY DEVICE (ECh) ATA opcode to the attached ATA device. If the IDENTIFY DEVICE command completes with success, the SATL shall return a media serial number to the application client as defined in SPC-3. The media serial number shall be generated as follows:

1) If IDENTIFY DEVICE data, word 87, bit 2 is set, the SATL shall return the media serial number located in words 176-205. The data from the media serial number shall be treated as an ASCII string, defined in ATA/ATAPI-7.

2) If IDENTIFY DEVICE data, word 87, bit 2 is not set, the SATL shall issue a READ VERIFY SECTOR(S) or READ VERIFY SECTOR(S) to LBA 0. Alternatively, if the ATA device indicates support for the Removable Media Status Notification feature set, the SATL may issue a GET MEDIA STATUS command to verify presence of the media. If the READ VERIFY SECTOR(S) or READ VEIRFY SECTOR(S) EX commands complete successfully, or the GET MEDIA STATUS command completes successfully without the NM bit set, the SATL shall return a media serial number of zero as defined in SPC-3. Otherwise, the SATL shall terminate the command with CHECK CONDITION status, with the sense key set to NOT READY, and the additional sense code set to MEDIUM NOT PRESENT.

8.9 REQUEST SENSE command

8.9.1 REQUEST SENSE command overview

The REQUEST SENSE command requests any available sense data to be returned to the application client. A SATL may implement sense data processing as defined SAM-2 and not support autosense (see 3.1.21). If the SCSI transport protocol for the SATL supports autosense (see 3.1.21) the SATL shall support autosense (see SAM-3). The SATL shall implement the REQUEST SENSE command as specified in SPC-3.

The SATL shall determine if any of the conditions listed in table 25 exist. If none of these conditions exist and the SATL has no status other than GOOD to return, the SATL shall complete this command with GOOD status

"2) If IDENTIFY DEVICE data, word 87, bit 2 is not set, the SATL shall issue a READ VERIFY SECTOR(S) or READ VERIFY SECTOR(S) EX to LBA 0. Alternatively, if the ATA device indicates support for the Removable Media Status Notification feature set, the SATL may issue a GET MEDIA STATUS command to verify presence of the medial. If the READ VERIFY SECTOR(S) or READ VEIRFY SECTOR(S) EX commands complete successfully, or the GET MEDIA STATUS command completes successfully without the NM bit set, the SATL shall return a media serial number of zero as defined in SPC-3. Otherwise, the SATL shall terminate the command with CHECK CONDITION status, with the sense key set to NOT READY, and the additional sense code set to MEDIUM NOT PRESENT."

to

"b) If ATA IDENTIFY DEVICE data, word 87, bit 2 is set to zero, the SATL shall issue an ATA READ VERIFY SECTOR(S) or READ VERIFY SECTOR(S) EX command to LBA 0. Alternatively, if the ATA device indicates support for the Removable Media Status Notification feature set (i.e., ATA IDENTIFY DEVICE data, word 127, bits (1:0) is set to 01b), the SATL may issue an ATA GET MEDIA STATUS command to verify presence of media. If the ATA READ VERIFY SECTOR(S) or READ VERIFY SECTOR(S) EXT command complete without error, or the ATA GET MEDIA STATUS command completes with the NM bit set to zero in the Error register, the SATL shall return a media serial number of zero as defined in SPC-3. Otherwise, the SATL shall terminate the command with CHECK CONDITION status, with the sense key set to NOT READY, and the additional sense code set to MEDIUM NOT PRESENT."

Suggested: s/b

"b) If ATA IDENTIFY DEVICE data, word 87, bit 2 is set to zero, the SATL shall issue an ATA READ VERIFY SECTOR(S) or READ VERIFY SECTOR(S) EXT command to LBA 0. Alternatively, if the ATA device indicates support for the Removable Media Status Notification feature set (i.e., ATA IDENTIFY DEVICE data, word 127, bits (1:0) is set to 01b), the SATL may issue an ATA GET MEDIA STATUS command to verify presence of media. If the ATA READ VERIFY SECTOR(S) or READ VERIFY SECTOR(S) EXT command complete without error, or the ATA GET MEDIA STATUS command completes with the NM bit set to zero in the Error register, the SATL shall return a media serial number of zero as defined in SPC-3. Otherwise, the SATL shall terminate the command with CHECK CONDITION status, with the sense key set to NOT READY, and the additional sense code set to MEDIUM NOT PRESENT."
RESOLUTION: Remove subclause 8.8 (see EDITOR's comment)

Status
rlsheffi Completed 6/14/2006 3:18:10 PM

Sequence number: 23
Author: HPQ[RElliott]
Subject: Highlight
Date: 6/14/2006 3:11:10 PM
 8.8.2

EX s/b EXT
RESOLUTION: Remove subclause 8.8 (see EDITOR's comment)

Status
rlsheffi Completed 6/14/2006 3:18:21 PM

Sequence number: 24
Author: ENDL[RWeber]
Date: 6/14/2006 3:11:14 PM
 1,2 list, entry 2, multiple places
READ VERIFY SECTOR(S) EX [s/b] READ VERIFY SECTOR(S) EXT
RESOLUTION: Remove subclause 8.8 (see EDITOR's comment)

Status
rlsheffi Completed 6/14/2006 3:18:30 PM

Sequence number: 25
Author: STX[GHoulder]
Subject: Note
Date: 6/14/2006 3:11:21 PM
 PDF page 57

section 8.8.2, bullet 2
If the Removeable Media Status Notification feature set is not supported, why not return the DRIVE's serial number from IDENTIFY DEVICE ?

RESOLUTION: Remove subclause 8.8 (see EDITOR's comment)

Status
rlsheffi Completed 6/14/2006 3:18:37 PM

Comments from page 57 continued on next page

8.8 READ MEDIA SERIAL NUMBER command

8.8.1 READ MEDIA SERIAL NUMBER command overview

READ MEDIA SERIAL NUMBER returns the serial number of the currently mounted media, as returned by the device. This command is emulated in the ATA environment as ATA provides no direct corresponding command to the device.



Table 24 — READ MEDIA SERIAL NUMBER command CDB fields

Field	Description or reference
OPERATION CODE	See 8.8.2
SERVICE ACTION	As defined in SPC-3
ALLOCATION LENGTH	As defined in SPC-3
CONTROL	6.4

8.8.2 READ MEDIA SERIAL NUMBER emulation

A SATL emulating the READ MEDIA SERIAL NUMBER command shall issue an IDENTIFY DEVICE (ECh) ATA opcode to the attached ATA device. If the IDENTIFY DEVICE command completes with success, the SATL shall return a media serial number to the application client as defined in SPC-3. The media serial number shall be generated as follows:

1) If IDENTIFY DEVICE data, word 87, bit 2 is set, the SATL shall return the media serial number located in words 176-205. The data from the media serial number shall be treated as an ASCII string, defined in ATA/ATAPI-7.

2) If IDENTIFY DEVICE data, word 87, bit 2 is not set, the SATL shall issue a READ VERIFY SECTOR(S) or READ VERIFY SECTOR(S) EX to LBA 0. Alternatively, if the ATA device indicates support for the Removable Media Status Notification feature set, the SATL may issue a GET MEDIA STATUS command to verify presence of the media. The READ VERIFY SECTOR(S) or READ VERIFY SECTOR(S) commands complete successfully, or the GET MEDIA STATUS command completes successfully without the NM bit set, the SATL shall return a media serial number of zero as defined in SPC-3. Otherwise, the SATL shall terminate the command with CHECK CONDITION status, with the sense key set to NOT READY, and the additional sense code set to MEDIUM NOT PRESENT.

8.9 REQUEST SENSE command

8.9.1 REQUEST SENSE command overview

The REQUEST SENSE command requests any available sense data to be returned to the application client. A SATL may implement sense data processing as defined SAM-2 and not support autosense (see 3.1.21). If the SCSI transport protocol for the SATL supports autosense (see 3.1.21) the SATL shall support autosense (see SAM-3). The SATL shall implement the REQUEST SENSE command as specified in SPC-3.

The SATL shall determine if any of the conditions listed in table 25 exist. If none of these conditions exist and the SATL has no status other than GOOD to return, the SATL shall complete this command with GOOD status

Sequence number: 26
Author: ELX[KHirata]
Subject: Highlight
Date: 6/14/2006 3:11:24 PM

T Location: Page 37, 8.8.2, Numbered item 2, Second sentence

Comment:

Typo. "medial" should be "media"

RESOLUTION: Remove subclause 8.8 (see EDITOR's comment)

Status
risheffi Completed 6/14/2006 3:18:43 PM

Sequence number: 27
Author: IBM[GPenokie]
Subject: Comment on Text
Date: 6/14/2006 3:11:30 PM

T item 2

I'm not sure what this means << verify presence of the medial. >> What is a medial?

RESOLUTION: Remove subclause 8.8 (see EDITOR's comment)

Status
risheffi Completed 6/14/2006 3:18:49 PM

Sequence number: 28
Author: STX[GHolder]
Subject: Highlight
Date: 6/14/2006 3:11:34 PM

T PDF page 57

section 8.8.2, bullet 2: "... verify presence of the medial."

change 'medial' to 'media'

RESOLUTION: Remove subclause 8.8 (see EDITOR's comment)

Status
risheffi Completed 6/14/2006 3:18:56 PM

Sequence number: 29
Author: MXO[MEvans]
Subject: Highlight
Date: 6/14/2006 3:11:41 PM

T 8.8.2 READ MEDIAL SERIAL NUMBER emulation, list item 2: in two places change "successfully" to "without error".

RESOLUTION: Remove subclause 8.8 (see EDITOR's comment)

Status
risheffi Completed 6/14/2006 3:19:01 PM

Sequence number: 30
Author: ENDL[RWeber]
Date: 6/14/2006 3:11:47 PM

T EX

RESOLUTION: Remove subclause 8.8 (see EDITOR's comment)

Status
risheffi Completed 6/14/2006 3:19:10 PM

Sequence number: 31
Author: ELX[KHirata]
Subject: Highlight
Date: 6/14/2006 3:11:51 PM

T Location: Page 37, 8.8.2, Numbered item 1, Second sentence

Comment:

Typo. "medial" should be "media"

RESOLUTION: Remove subclause 8.8 (see EDITOR's comment)

Status
risheffi Completed 6/24/2006 1:24:29 PM

Sequence number: 32
Author: ENDL[RWeber]
Date: 6/14/2006 3:11:54 PM

T 1,2 list, entry 2, s 3
VEIRFY [s/b] VERIFY

Comments from page 57 continued on next page

8.8 READ MEDIA SERIAL NUMBER command

8.8.1 READ MEDIA SERIAL NUMBER command overview

READ MEDIA SERIAL NUMBER returns the serial number of the currently mounted media, as returned by the device. This command is emulated in the ATA environment as ATA provides no direct corresponding command to the device.



Table 24 — READ MEDIA SERIAL NUMBER command CDB fields

Field	Description or reference
OPERATION CODE	See 8.8.2
SERVICE ACTION	As defined in SPC-3
ALLOCATION LENGTH	As defined in SPC-3
CONTROL	6.4

8.8.2 READ MEDIA SERIAL NUMBER emulation

A SATL emulating the READ MEDIA SERIAL NUMBER command shall issue an IDENTIFY DEVICE (ECh) ATA opcode to the attached ATA device. If the IDENTIFY DEVICE command completes with success, the SATL shall return a media serial number to the application client as defined in SPC-3. The media serial number shall be generated as follows:

1) If IDENTIFY DEVICE data, word 87, bit 2 is set, the SATL shall return the media serial number located in words 176-205. The data from the media serial number shall be treated as an ASCII string, defined in ATA/ATAPI-7.



2) If IDENTIFY DEVICE data, word 87, bit 2 is not set, the SATL shall issue a READ VERIFY SECTOR(S) or READ VERIFY SECTOR(S) EX to LBA 0. Alternatively, if the ATA device indicates support for the Removable Media Status Notification feature set, the SATL may issue a GET MEDIA STATUS command to verify presence of the media. If the READ VERIFY SECTOR(S) or READ VERIFY SECTOR(S) EX commands complete successfully, or the GET MEDIA STATUS command completes successfully³³ without the NM bit set, the SATL shall return a media serial number of zero as defined in SPC-3. Otherwise, the SATL shall terminate the command with CHECK CONDITION status, with the sense key set to NOT READY, and the additional sense code set to MEDIUM NOT PRESENT.

8.9 REQUEST SENSE command

³⁴ 8.9.1 REQUEST SENSE command overview

The REQUEST SENSE command requests any available sense data to be returned to the application client. ³⁶ SATL may implement sense data processing as defined SAM-2 and not support autosense (see 3.1.21). If the SCSI transport protocol for the SATL supports autosense (see 3.1.21) the SATL shall support autosense (see SAM-3). The SATL shall implement the REQUEST SENSE command as specified in SPC-3.

³⁷ The SATL shall determine if any of the conditions listed in table 25 exist. If none of these conditions exist and the SATL has no status other than GOOD to return, the SATL shall complete this command with GOOD status

RESOLUTION: Remove subclause 8.8 (see EDITOR's comment)

Status
rlsheffi Completed 6/14/2006 3:19:28 PM

Sequence number: 33
Author: IBM[GPenokie]
Subject: Comment on Text
Date: 6/14/2006 3:14:31 PM

T item 2
This << without the NM bit set, the >> should be << without the NM bit set to one, the >>
Suggested: "... with the NM bit set to zero..." (see DELL comment).
RESOLUTION: Remove subclause 8.8 (see EDITOR's comment)

Status
rlsheffi Completed 6/14/2006 3:19:54 PM

Sequence number: 34
Author: IBM[GPenokie]
Subject: Underline
Date: 2/16/2006 1:44:18 PM

T 8.9.1 REQUEST SENSE command overview

Status
rlsheffi Cancelled 2/28/2006 4:08:45 PM

Sequence number: 35
Author: DELL[KMarks]
Subject: Highlight
Date: 6/14/2006 4:10:55 PM

T 8.9.1 REQUEST SENSE command overview

1st Paragraph, 2nd Sentence
change

"A SATL may implement sense data processing as defined SAM-2 and not support autosense (see 3.1.21). If the SCSI transport protocol for the SATL supports autosense (see 3.1.21) the SATL shall support autosense (see SAM-3). The SATL shall implement the REQUEST SENSE command as specified in SPC-3."

to

"A SATL may implement sense data processing as defined in SAM-2 and not support autosense (see 3.1.21). If a SCSI transport protocol of the target port for the SATL supports autosense the SATL shall support autosense (see SAM-3). The SATL shall implement the REQUEST SENSE command as defined in SPC-3."

REASON: The transport, by definition, applies to both the target port and the initiator port, so it is the transport protocol that determines whether or not autosense is supported. It is implicit that a SATL attached to a defined SCSI transport via a SCSI target port. See HP comment for the resolution.

Status
rlsheffi Rejected 4/26/2006 2:34:55 PM

Sequence number: 36
Author: HPQ[RElliott]
Subject: Highlight
Date: 2/28/2006 4:42:59 PM

T 8.9.1

"A SATL may implement sense data processing as defined SAM-2 and not support autosense" is incomplete. This is only true if the transport protocol does not support autosense.

RESOLUTION:

If the SCSI transport protocol for the SATL supports autosense (see 3.1.21), the SATL shall return sense data using autosense. Otherwise, the SATL shall return sense data in response to the REQUEST SENSE command (see SAM-2).

Status
rlsheffi Completed 6/14/2006 4:08:41 PM

Sequence number: 37
Author: DELL[KMarks]
Subject: Highlight
Date: 8/29/2006 3:50:20 PM

T 8.9.1 REQUEST SENSE command overview

2nd Paragraph
change

"The SATL shall determine if any of the conditions listed in table 25 exist. If none of these conditions exist and the SATL

Comments from page 57 continued on next page

8.8 READ MEDIA SERIAL NUMBER command

8.8.1 READ MEDIA SERIAL NUMBER command overview

READ MEDIA SERIAL NUMBER returns the serial number of the currently mounted media, as returned by the device. This command is emulated in the ATA environment as ATA provides no direct corresponding command to the device.



Table 24 — READ MEDIA SERIAL NUMBER command CDB fields

Field	Description or reference
OPERATION CODE	See 8.8.2
SERVICE ACTION	As defined in SPC-3
ALLOCATION LENGTH	As defined in SPC-3
CONTROL	6.4

8.8.2 READ MEDIA SERIAL NUMBER emulation

A SATL emulating the READ MEDIA SERIAL NUMBER command shall issue an IDENTIFY DEVICE (ECh) ATA opcode to the attached ATA device. If the IDENTIFY DEVICE command completes with success, the SATL shall return a media serial number to the application client as defined in SPC-3. The media serial number shall be generated as follows:

1) If IDENTIFY DEVICE data, word 87, bit 2 is set, the SATL shall return the media serial number located in words 176-205. The data from the media serial number shall be treated as an ASCII string, defined in ATA/ATAPI-7.

2) If IDENTIFY DEVICE data, word 87, bit 2 is not set, the SATL shall issue a READ VERIFY SECTOR(S) or READ VERIFY SECTOR(S) EX to LBA 0. Alternatively, if the ATA device indicates support for the Removable Media Status Notification feature set, the SATL may issue a GET MEDIA STATUS command to verify presence of the media. If the READ VERIFY SECTOR(S) or READ VEIRFY SECTOR(S) EX commands complete successfully, or the GET MEDIA STATUS command completes successfully without the NM bit set, the SATL shall return a media serial number of zero as defined in SPC-3. Otherwise, the SATL shall terminate the command with CHECK CONDITION status, with the sense key set to NOT READY, and the additional sense code set to MEDIUM NOT PRESENT.

8.9 REQUEST SENSE command

8.9.1 REQUEST SENSE command overview

The REQUEST SENSE command requests any available sense data to be returned to the application client. A SATL may implement sense data processing as defined SAM-2 and not support autosense (see 3.1.21). If the SCSI transport protocol for the SATL supports autosense (see 3.1.21) the SATL shall support autosense (see SAM-3). The SATL shall implement the REQUEST SENSE command as specified in SPC-3.

The SATL shall determine if any of the conditions listed in table 25 exist. If none of these conditions exist and the SATL has no status other than GOOD to return, the SATL shall complete this command with GOOD status

has no status other than GOOD to return, the SATL shall complete this command with GOOD status..."
to

"If the SATL receives a REQUEST SENSE command, the SATL shall determine if any of the conditions listed in table 25 exist. If none of the conditions listed in Table 25 exist and the SATL has GOOD status to return, the SATL shall complete the command with GOOD status..."

RESOLUTION: s/b

"The SATL shall determine if there is sense data to return to the application client. If the SATL has no sense data to return, then the SATL shall complete the REQUEST SENSE command with GOOD status with the sense key set to NO SENSE and the additional sense code set to NO ADDITIONAL SENSE DATA (see SPC-3). Table 25 lists examples of conditions where the SATL has sense data to return."

Status

rlsheffi Completed

8/29/2006 3:50:27 PM

¹With the sense key set to NO SENSE and the additional sense code set to NO ADDITIONAL SENSE DATA. Otherwise, the SATL shall take the actions ²specified in the subclause for that condition specified in table 25.

Table 25 — Special Request Sense behavior reference

⁴ ATA Device Condition	Reference
Status other than GOOD to return	SPC-3
FORMAT UNIT in progress	8.9.2
SMART Threshold Exceeded Condition	8.9.3
ATA Device in Low Power State	8.9.4



Table 26 shows the fields in the REQUEST SENSE CDB.

Table 26 — REQUEST SENSE command CDB fields

Field	Description or reference
OPERATION CODE	If autosense is supported and no condition from table 25 exists the SATL shall return GOOD status with the sense key set to NO SENSE with the additional sense code set to NO ADDITIONAL SENSE DATA.
DESC	A SATL may support returning fixed format sense data, descriptor format sense data, or both. This bit shall be implemented as described in SPC-3.
ALLOCATION LENGTH	This field specifies the number bytes allocated for the returned sense data. This field shall be implemented as described in SPC-3.
CONTROL	6.4

8.9.2 FORMAT UNIT In Progress

If a FORMAT UNIT command is in progress, and the SATL receives a REQUEST SENSE command, the SATL shall return GOOD status with the sense key set to NOT READY with the additional sense code set to LOGICAL UNIT NOT READY, FORMAT IN PROGRESS. The sense key specific bytes shall be set to progress indication as defined in SBC-2 and SPC-3.

8.9.3 SMART Threshold Exceeded Condition

If the ATA device has the SMART feature set enabled, the MRIE field in the Informational Exceptions Control mode page is set to 6h (see 10.1.7.2), and the most recent SMART RETURN STATUS command to the device indicates that the error threshold has been reached, then the SATL shall return GOOD status with the sense key set to NO SENSE with the additional sense code set to HARDWARE IMPENDING FAILURE GENERAL HARD DRIVE FAILURE.

8.9.4 ATA Device in Low Power State

If the ATA device is in a low power state (i.e., ATA state of STANDBY) the SATL shall return GOOD status with the sense key set to NO SENSE with the additional sense code set to LOW POWER CONDITION ON.

Sequence number: 1
Author: EDITOR[risheffi]
Subject: Cross-Out
Date: 5/11/2006 2:06:20 PM
 8.9.1 REQUEST SENSE command overview

Last paragraph before table 25

Remove "with the sense key set to NO SENSE and the additional sense code set to NO ADDITIONAL SENSE DATA. Otherwise, the SATL shall take the actions specified in the subclause for that condition specified in table 25"

Status
risheffi Completed 6/14/2006 4:15:15 PM

Sequence number: 2
Author: IBM[GPenokie]
Subject: Comment on Text
Date: 5/11/2006 2:02:58 PM

 2nd paragraph

This << specified in the subclause for that condition specified in table 25. >> should be << specified in the reference indicated in table 25. >>

RESOLUTION: removed / modified (see EDITOR's comment and DELL comment above).

Status
risheffi Completed 6/14/2006 4:15:27 PM

Sequence number: 3
Author: EDITOR[risheffi]
Subject: Rectangle
Date: 6/14/2006 4:55:51 PM

 **Table 25 — Special Request Sense behavior reference**

Modify table 25 to read as follows:

Emulated device state	Reference
Status other than GOOD to return	SPC-3
FORMAT UNIT in progress	8.9.2
SMART threshold exceeded condition	8.9.3
Stopped power condition (i.e., ATA device in standby power management state)	8.9.4
Unit attention condition established	8.8.5

Status
risheffi Completed 6/14/2006 4:55:32 PM

Sequence number: 4
Author: DELL[KMarks]
Subject: Highlight
Date: 5/1/2006 12:14:28 PM

 **Table 25 — Special Request Sense behavior reference**

1st column title

The column title "ATA Device Condition" does not seem to cover the first to rows, as the Format Unit, or some status other than good are not ATA Device Conditions. Need another title.

RESOLUTION: 0 s/b "Emulated device state"

Status
risheffi Completed 6/14/2006 4:17:32 PM

Sequence number: 5
Author: HPQ[RElliott]
Subject: Note
Date: 6/14/2006 4:56:29 PM

 8.9.1
table 25

The first 2 entries are not ATA device conditions
RESOLUTION: see Editor's comment

Status

with the sense key set to NO SENSE and the additional sense code set to NO ADDITIONAL SENSE DATA. Otherwise, the SATL shall take the actions specified in the subclause for that condition specified in table 25.

Table 25 — Special Request Sense behavior reference

ATA Device Condition	Reference
Status other than GOOD to return	SPC-3
FORMAT UNIT in progress	8.9.2
SMART Threshold Exceeded Condition	8.9.3
ATA Device in Low Power State	8.9.4



Table 26 shows the fields in the REQUEST SENSE CDB.

Table 26 — REQUEST SENSE command CDB fields

Field	Description or reference
OPERATION CODE	6 autosense is supported and no condition from table 25 exists the SATL shall return GOOD status with the sense key set to NO SENSE with the additional sense code set to NO ADDITIONAL SENSE DATA.
DESC 8	7 SATL may support returning fixed format sense data, descriptor format sense data, or both. This bit shall be implemented as described in SPC-3.
ALLOCATION LENGTH	9 This field specifies the number bytes allocated for the returned sense data. This field shall be implemented as described in SPC-3.
CONTROL	6.4

8.9.2 FORMAT UNIT In Progress

If a FORMAT UNIT command is in progress, and the SATL receives a REQUEST SENSE command, the SATL shall return GOOD status with the sense key set to NOT READY with the additional sense code set to LOGICAL UNIT NOT READY, FORMAT IN PROGRESS. The sense key specific bytes shall be set to progress indication as defined in SBC-2 and SPC-3.

8.9.3 SMART Threshold Exceeded Condition

If the ATA device has the SMART feature set enabled, the MRIE field in the Informational Exceptions Control mode page is set to 6h (see 10.1.7.2), and the most recent SMART RETURN STATUS command to the device indicates that the error threshold has been reached, then the SATL shall return GOOD status with the sense key set to NO SENSE with the additional sense code set to HARDWARE IMPENDING FAILURE GENERAL HARD DRIVE FAILURE.

8.9.4 ATA Device in Low Power State

If the ATA device is in a low power state (i.e., ATA state of STANDBY) the SATL shall return GOOD status with the sense key set to NO SENSE with the additional sense code set to LOW POWER CONDITION ON.

risheffi Completed 6/14/2006 4:17:48 PM

Sequence number: 6
Author: HPQ[RElliott]
Subject: Highlight
Date: 6/14/2006 4:47:08 PM
T 8.9.1
table 26

If autosense is supported and no condition from table 25 exists" is incomplete.

If the SATL has established a unit attention condition, that is returned as parameter data for this command with GOOD status

RESOLUTION:
Change the description of the operation code field to:
"Set to 03h"

Move the rest of the text (modified) into the paragraph above table 25 (see DELL comment),

Add a row to table 25:

" Emulated device state Reference
Unit attention condition established 8.9.5"

and add a new subclause:

"8.9.5 Unit attention condition established

The SATL shall return:

- a) parameter data containing sense data describing the unit attention condition (see SPC-3); and
- b) GOOD status for the command."

Status
risheffi Completed 6/14/2006 4:48:57 PM

Sequence number: 7
Author: HPQ[RElliott]
Subject: Highlight
Date: 2/1/2006 12:46:47 PM
T 8.9.1
table 26

Change "A SATL may support returning fixed format sense data, descriptor format sense data, or both. This bit shall be implemented as described in SPC-3." to "Unspecified (see 3.4.3)"

Status
risheffi Completed 6/14/2006 4:59:09 PM

Sequence number: 8
Author: DELL[KMarks]
Subject: Note
Date: 6/14/2006 5:15:14 PM
T Table 26 — REQUEST SENSE command CDB fields
Row: DESC

Does a footnote need to be added, that the descriptor format shall be supported if supporting ATA PASSTHROUGH commands?

RESOLUTION:

Add the following table footnote -

"If the SATL supports the ATA PASS-THROUGH command (see 12.2), then the SATL shall support returning descriptor format sense data (i.e., specified by the desc bit set to one)."

Status
risheffi Completed 6/14/2006 5:15:17 PM

Sequence number: 9
Author: HPQ[RElliott]
Subject: Highlight
Date: 2/1/2006 12:46:20 PM
T 8.9.1
table 26

Change "This field specifies the number bytes allocated for the returned sense data. This field shall be implemented as described in SPC-3." to "Unspecified (see 3.4.3)"

Comments from page 58 continued on next page

with the sense key set to NO SENSE and the additional sense code set to NO ADDITIONAL SENSE DATA. Otherwise, the SATL shall take the actions specified in the subclause for that condition specified in table 25.

Table 25 — Special Request Sense behavior reference

ATA Device Condition	Reference
Status other than GOOD to return	SPC-3
FORMAT UNIT in progress	8.9.2
SMART Threshold Exceeded Condition	8.9.3
ATA Device in Low Power State	8.9.4

Table 26 shows the fields in the REQUEST SENSE CDB.

Table 26 — REQUEST SENSE command CDB fields

Field	Description or reference
OPERATION CODE	If autosense is supported and no condition from table 25 exists the SATL shall return GOOD status with the sense key set to NO SENSE with the additional sense code set to NO ADDITIONAL SENSE DATA.
DESC	A SATL may support returning fixed format sense data, descriptor format sense data, or both. This bit shall be implemented as described in SPC-3.
ALLOCATION LENGTH	This field specifies the number bytes allocated for the returned sense data. This field shall be implemented as described in SPC-3.
CONTROL	6.4

8.9.2 FORMAT UNIT ¹⁰Progress

¹¹ FORMAT UNIT command is in progress, and the SATL receives a REQUEST SENSE command, the SATL shall return GOOD status with the sense key set to NOT READY with the additional sense code set to LOGICAL UNIT NOT READY, FORMAT IN PROGRESS. ¹² The sense key specific bytes shall be set to progress indication as defined in SBC-2 and SPC-3.

8.9.3 SMART Threshold Exceeded Condition

¹⁴ The ATA device has the SMART feature set enabled, the ¹³RIE field in the Informational Exceptions Control mode page is set to 6h (see 10.1.7.2), and the most recent SMART RETURN STATUS command to the device indicates that the error threshold has been reached, then the SATL shall return GOOD status with the sense key set to NO SENSE with the additional sense code set to HARDWARE IMPENDING FAILURE GENERAL HARD DRIVE FAILURE.

8.9.4 ATA Device in Low Power State

If the ATA device is in a low power state (i.e., ATA state of STANDBY) the SATL shall return GOOD status with the sense key set to NO SENSE with the additional sense code set to LOW POWER CONDITION ON.

Status
rlsheffi Completed 6/14/2006 5:15:50 PM

Sequence number: 10
Author: HPQ[RElliott]
Subject: Highlight
Date: 1/19/2006 9:40:42 AM
T 8.9.3

"In Progress" s/b lowercase

Status
rlsheffi Completed 6/14/2006 5:16:15 PM

Sequence number: 11
Author: DELL[KMarks]
Subject: Highlight
Date: 5/1/2006 12:15:27 PM
T 8.9.2 **FORMAT UNIT In Progress**
1st Paragraph, 1st Sentence
change

"If a **FORMAT UNIT** command is in progress, ..."
to

"If the emulation of a **FORMAT UNIT** command is in progress ..."

RESOLUTION: proposed resolution s/b
"If the SATL is processing a **FORMAT UNIT command..."**

Status
rlsheffi Completed 6/14/2006 5:17:03 PM

Sequence number: 12
Author: STX[GHolder]
Subject: Highlight
Date: 2/28/2006 5:10:49 PM
T PDF page 59
section 8.9.2, last sentence

How should/shall the device report the progress indicator to the SATL ?

REASON: SBC-2 defines what to return to the initiator for progress indication. How the SATL emulates that function is out of scope.

Status
rlsheffi Rejected 2/28/2006 5:10:57 PM

Sequence number: 13
Author: HPQ[RElliott]
Subject: Highlight
Date: 2/1/2006 12:47:42 PM
T 8.9.3

MRIE s/b smallcaps

Status
rlsheffi Completed 6/14/2006 5:18:08 PM

Sequence number: 14
Author: DELL[KMarks]
Subject: Highlight
Date: 6/15/2006 9:19:35 AM
T 8.9.3 **SMART Threshold Exceeded Condition**
1st Paragraph
change

"If the ATA device has the **SMART** feature set enabled, the **MRIE** field in the Informational Exceptions Control mode page is set to 6h (see 10.1.7.2), and the most recent **SMART RETURN STATUS** command to the device indicates that the error threshold has been reached, then the SATL shall return **GOOD** status with the sense key set to **NO SENSE** with the additional sense code set to **HARDWARE IMPENDING FAILURE GENERAL HARD DRIVE FAILURE**."
to

"If the ATA device has the **SMART** feature set enabled (i.e., **IDENTIFY DEVICE** data word 85 bit 0 is set to one), the **MRIE** field in the Informational Exceptions Control mode page of the SATL is set to 6h (see 10.1.7.2), and the most recent ATA

Comments from page 58 continued on next page

with the sense key set to NO SENSE and the additional sense code set to NO ADDITIONAL SENSE DATA. Otherwise, the SATL shall take the actions specified in the subclause for that condition specified in table 25.

Table 25 — Special Request Sense behavior reference

ATA Device Condition	Reference
Status other than GOOD to return	SPC-3
FORMAT UNIT in progress	8.9.2
SMART Threshold Exceeded Condition	8.9.3
ATA Device in Low Power State	8.9.4

Table 26 shows the fields in the REQUEST SENSE CDB.

Table 26 — REQUEST SENSE command CDB fields

Field	Description or reference
OPERATION CODE	If autosense is supported and no condition from table 25 exists the SATL shall return GOOD status with the sense key set to NO SENSE with the additional sense code set to NO ADDITIONAL SENSE DATA.
DESC	A SATL may support returning fixed format sense data, descriptor format sense data, or both. This bit shall be implemented as described in SPC-3.
ALLOCATION LENGTH	This field specifies the number bytes allocated for the returned sense data. This field shall be implemented as described in SPC-3.
CONTROL	6.4

8.9.2 FORMAT UNIT In Progress

If a FORMAT UNIT command is in progress, and the SATL receives a REQUEST SENSE command, the SATL shall return GOOD status with the sense key set to NOT READY with the additional sense code set to LOGICAL UNIT NOT READY, FORMAT IN PROGRESS. The sense key specific bytes shall be set to progress indication as defined in SBC-2 and SPC-3.

8.9.3 SMART Threshold Exceeded Condition

If the ATA device has the SMART feature set enabled, the MRIE field in the Informational Exceptions Control mode page is set to 6h (see 10.1.7.2), and the most recent SMART RETURN STATUS command to the device indicates that the error threshold has been reached, then the SATL shall return GOOD status with the sense key set to NO SENSE with the additional sense code set to HARDWARE IMPENDING FAILURE GENERAL HARD DRIVE FAILURE.

8.9.4 ATA Device in Low Power State

The ATA device is in a low power state (i.e., ATA state of STANDBY) the SATL shall return GOOD status with the sense key set to NO SENSE with the additional sense code set to LOW POWER CONDITION ON.

SMART RETURN STATUS command to the ATA device indicates that the error threshold has been exceeded, then the SATL shall return GOOD status with the sense key set to NO SENSE with the additional sense code set to HARDWARE IMPENDING FAILURE GENERAL HARD DRIVE FAILURE."

Does the DEXCPT bit need to be added here, i.e. and DEXCPT bit =0

RESOLUTION:

"If:

- a) the ATA device has the SMART feature set enabled (i.e., IDENTIFY DEVICE data word 85 bit 0 is set to one);
- b) the MRIE field in the Informational Exceptions Control mode page of the SATL is set to 6h (see 10.1.7.2);
- c) the DEXCPT bit in the Informational Exceptions Control mode page is set to zero; and
- d) the most recent ATA SMART RETURN STATUS command to the ATA device indicates that the error threshold has been exceeded;

then the SATL shall:

- a) return parameter data containing sense data with the sense key set to NO SENSE with the additional sense code set to HARDWARE IMPENDING FAILURE GENERAL HARD DRIVE FAILURE; and
- b) return GOOD status for the command."

Status
rlsheffi Completed 6/15/2006 9:27:33 AM

Sequence number: 15
Author: HPQ[RElliott]
Subject: Highlight
Date: 2/1/2006 12:48:09 PM

T 8.9.3

device s/b ATA device

Status
rlsheffi Completed 6/15/2006 9:28:26 AM

Sequence number: 16
Author: HPQ[RElliott]
Subject: Highlight
Date: 6/15/2006 9:31:43 AM

T 8.9.4

"Low Power State" s/b lowercase

RESOLUTION:

"8.9.4 ATA Device in Low Power State"

s/b

"Stopped power condition"

This is because table 25 (->24) now associates these subclauses with "Emulated device states".

Status
rlsheffi Completed 6/15/2006 9:31:52 AM

Sequence number: 17
Author: DELL[KMarks]
Subject: Highlight
Date: 6/15/2006 11:32:06 AM

T 8.9.4 ATA Device in Low Power State

1st Paragraph
change

"If the ATA device is in a low power state (i.e., ATA state of STANDBY) the SATL shall return GOOD status with the sense key set to NO SENSE with the additional sense code set to LOW POWER CONDITION ON."

to

"If the ATA device is in the Standby power management state, the SATL shall return GOOD status with the sense key set to NO SENSE with the additional sense code set to LOW POWER CONDITION ON."

Suggested resolution: s/b

"If the ATA device is in the Standby power management state for the purpose of emulating the SCSI stopped power condition, the SATL shall return GOOD status with the sense key set to NOT READY with the additional sense code set to

with the sense key set to NO SENSE and the additional sense code set to NO ADDITIONAL SENSE DATA. Otherwise, the SATL shall take the actions specified in the subclause for that condition specified in table 25.

Table 25 — Special Request Sense behavior reference

ATA Device Condition	Reference
Status other than GOOD to return	SPC-3
FORMAT UNIT in progress	8.9.2
SMART Threshold Exceeded Condition	8.9.3
ATA Device in Low Power State	8.9.4

Table 26 shows the fields in the REQUEST SENSE CDB.

Table 26 — REQUEST SENSE command CDB fields

Field	Description or reference
OPERATION CODE	If autosense is supported and no condition from table 25 exists the SATL shall return GOOD status with the sense key set to NO SENSE with the additional sense code set to NO ADDITIONAL SENSE DATA.
DESC	A SATL may support returning fixed format sense data, descriptor format sense data, or both. This bit shall be implemented as described in SPC-3.
ALLOCATION LENGTH	This field specifies the number bytes allocated for the returned sense data. This field shall be implemented as described in SPC-3.
CONTROL	6.4

8.9.2 FORMAT UNIT In Progress

If a FORMAT UNIT command is in progress, and the SATL receives a REQUEST SENSE command, the SATL shall return GOOD status with the sense key set to NOT READY with the additional sense code set to LOGICAL UNIT NOT READY, FORMAT IN PROGRESS. The sense key specific bytes shall be set to progress indication as defined in SBC-2 and SPC-3.

8.9.3 SMART Threshold Exceeded Condition

If the ATA device has the SMART feature set enabled, the MRIE field in the Informational Exceptions Control mode page is set to 6h (see 10.1.7.2), and the most recent SMART RETURN STATUS command to the device indicates that the error threshold has been reached, then the SATL shall return GOOD status with the sense key set to NO SENSE with the additional sense code set to HARDWARE IMPENDING FAILURE GENERAL HARD DRIVE FAILURE.

8.9.4 ATA Device in Low Power State

If the ATA device is in a low power state (i.e., ATA state of STANDBY) the SATL shall return GOOD status with the sense key set to NO SENSE with the additional sense code set to LOW POWER CONDITION ON.

LOGICAL UNIT NOT READY, INITIALIZING COMMAND REQUIRED. If the ATA device is in the Standby power management state for any other reason, the SATL shall return GOOD status with the sense key set to NO SENSE with the additional sense code set to NO ADDITIONAL SENSE DATA."

Note - SPC-3 and SBC-2 do not specify what to return when the device is in the stopped power condition, but the following resolution represents what REQUEST SENSE normally returns when the device server uses auto-sense to return sense data for a CHECK CONDITION, or when the device server does normally return sense data for a prior CHECK CONDITION in REQUEST SENSE parameter data (i.e., no autosense), but there is no sense data for a prior CHECK CONDITION to return.

RESOLUTION:

"If the emulated logical unit is in the stopped power condition (i.e., the ATA device is in the Standby power management state) and there is no sense data to return for a previously returned CHECK CONDITION status, then the SATL shall return:

- a) parameter data containing sense data with the sense key set to NO SENSE with the additional sense code set to NO ADDITIONAL SENSE DATA; and
- b) GOOD status for the command.

Sense data returned for a previously returned CHECK CONDITION status resulting from a media access command or a TEST UNIT READY command received when the logical unit is in the stopped power condition is described in 8.10 (i.e., the TEST UNIT READY command) and 9.11 (i.e., the START STOP UNIT command)."

Status
risheffi Completed 6/15/2006 9:56:18 AM

Sequence number: 18
Author: HPQ[RElliott]
Subject: Highlight
Date: 6/15/2006 11:34:34 AM

T 8.9.4

LOW POWER CONDITION ON

Could STANDBY CONDITION ACTIVATED BY COMMAND be returned?

RESOLUTION: see Dell comment.

Status
risheffi Completed 6/15/2006 10:00:25 AM

8.10 SEND DIAGNOSTIC command

10.1 SEND DIAGNOSTIC command overview

The SEND DIAGNOSTIC command provides a mechanism for an application client to request diagnostic operations to be performed on the SCSI target device, SCSI logical unit, or both. The SATL shall implement the default self-test feature (see SPC-3).

Table 27 — SEND DIAGNOSTIC command CDB fields

Field	Description or reference
OPERATION CODE	Set to 1Dh. This field value is specific to the SEND DIAGNOSTIC command.
SELF-TEST CODE	8.10.2 and 8.10.3.
PF	If the PF bit is set to zero, then the SATL shall process the command as specified in SPC-3. If the PF bit is set to one, then the SATL shall terminate the command with CHECK CONDITION status with the sense key set to ILLEGAL REQUEST and the additional sense code set to INVALID FIELD IN CDB.
SELFTEST	8.10.3
DEVOFFL	If the DEVOFFL bit is set to zero, then the SATL shall process the command as specified in SPC-3. If the DEVOFFL bit is set to one, then the SATL shall terminate the command with CHECK CONDITION status with the sense key set to ILLEGAL REQUEST and the additional sense code set to INVALID FIELD IN CDB.
UNITOFFL	If the UNITOFFL bit is set to zero, then the SATL shall process the command as specified in SPC-3. If the UNITOFFL bit is set to one, then the SATL shall terminate the command with CHECK CONDITION status with the sense key set to ILLEGAL REQUEST and the additional sense code set to INVALID FIELD IN CDB.
PARAMETER LIST LENGTH	If the PARAMETER LIST LENGTH field is set to zero, then the SATL shall process the command as specified in SPC-3. If the PARAMETER LIST LENGTH field is not set to zero, then the SATL shall terminate the command with a CHECK CONDITION status with sense key set to ILLEGAL REQUEST and additional sense code set to INVALID FIELD IN CDB.
CONTROL	6.4

8.10.2 SELF-TEST CODE field

The SATL shall determine if the contents of this field are valid depending on the value of the SELFTEST bit and what is reported by the attached ATA device with respect to the SMART EXECUTE OFF-LINE IMMEDIATE command (see 8.10.3).

If the contents of the SELF-TEST CODE field are valid, then the SATL shall process the command as described in table 28.

Sequence number: 1
Author: IBM[GPenokie]
Subject: Underline
Date: 2/16/2006 1:40:03 PM
T 8.10.1 SEND DIAGNOSTIC command overview

Status
rlsheffi Cancelled 4/27/2006 10:10:37 AM

Sequence number: 2
Author: HPQ[WBellamy]
Subject: Note
Date: 2/20/2006 10:03:47 AM
 delete the term "SCSI" from this statement. It was not in proposal 05-245r4.

Status
rlsheffi Completed 6/15/2006 11:41:25 AM

Sequence number: 3
Author: DELL[KMarks]
Subject: Highlight
Date: 6/15/2006 11:41:13 AM
T 8.10.1 SEND DIAGNOSTIC command overview
1st Paragraph

"The SEND DIAGNOSTIC command provides a mechanism for an application client to request diagnostic operations to be performed on the SCSI target device, SCSI logical unit, or both. The SATL shall implement the default self-test feature (see SPC-3)."

to

"The SEND DIAGNOSTIC command provides a mechanism for an application client to request diagnostic operations to be performed on the SCSI target device, logical unit, or both. The SATL shall implement the default self-test feature (see SPC-3). Table 27 shows the translation for fields specified in the SEND DIAGNOSTIC CDB."

RESOLUTION: s/b

"The SEND DIAGNOSTIC command provides a mechanism for an application client to request diagnostic operations to be performed on the target device, logical unit, or both. The SATL shall implement the default self-test feature (see SPC-3). Table 27 shows the translation for fields specified in the SEND DIAGNOSTIC CDB."

Status
rlsheffi Completed 6/15/2006 11:41:16 AM

Sequence number: 4
Author: HPQ[WBellamy]
Subject: Cross-Out
Date: 4/27/2006 10:14:11 AM
T RESOLUTION:
Delete "SCSI"

Status
rlsheffi Completed 6/15/2006 11:41:39 AM

Sequence number: 5
Author: HPQ[WBellamy]
Subject: Cross-Out
Date: 4/27/2006 10:14:14 AM
T RESOLUTION:
Delete "SCSI"

Status
rlsheffi Completed 6/15/2006 11:41:49 AM

Sequence number: 6
Author: HPQ[WBellamy]
Subject: Highlight
Date: 4/27/2006 10:14:15 AM
T RESOLUTION:
Delete "SCSI"

8.10 SEND DIAGNOSTIC command

8.10.1 SEND DIAGNOSTIC command overview

The SEND DIAGNOSTIC command provides a mechanism for an application client to request diagnostic operations to be performed on the SCSI target device, SCSI logical unit, or both. The SATL shall implement the default self-test feature (see SPC-3).

Table 27 — SEND DIAGNOSTIC command CDB fields

Field	Description or reference
OPERATION CODE	Set to 1Dh. This field value is specific to the SEND DIAGNOSTIC command.
SELF-TEST CODE	8.10.2 and 8.10.3.
PF	If the PF bit is set to zero, then the SATL shall process the command as specified in SPC-3. If the PF bit is set to one, then the SATL shall terminate the command with CHECK CONDITION status with the sense key set to ILLEGAL REQUEST and the additional sense code set to INVALID FIELD IN CDB.
SELFTEST	8.10.3
DEVOFFL	If the DEVOFFL bit is set to zero, then the SATL shall process the command as specified in SPC-3. If the DEVOFFL bit is set to one, then the SATL shall terminate the command with CHECK CONDITION status with the sense key set to ILLEGAL REQUEST and the additional sense code set to INVALID FIELD IN CDB.
UNITOFFL	If the UNITOFFL bit is set to zero, then the SATL shall process the command as specified in SPC-3. If the UNITOFFL bit is set to one, then the SATL shall terminate the command with CHECK CONDITION status with the sense key set to ILLEGAL REQUEST and the additional sense code set to INVALID FIELD IN CDB.
PARAMETER LIST LENGTH	If the PARAMETER LIST LENGTH field is set to zero, then the SATL shall process the command as specified in SPC-3. If the PARAMETER LIST LENGTH field is not set to zero, then the SATL shall terminate the command with a CHECK CONDITION status with sense key set to ILLEGAL REQUEST and additional sense code set to INVALID FIELD IN CDB.
CONTROL	6.4

8.10.2 SELF-TEST CODE field

The SATL shall determine the contents of this field are valid depending on the value of the SELFTEST bit and what is reported by the attached ATA device with respect to the SMART EXECUTE OFF-LINE IMMEDIATE command (see 8.10.3).

If the contents of the SELF-TEST CODE field are valid, then the SATL shall process the command as described in table 28.

Status
rlsheffi Completed 6/15/2006 11:42:18 AM

Sequence number: 7
Author: HPQ[WBellamy]
Subject: Highlight
Date: 4/27/2006 10:14:18 AM
T RESOLUTION:
Delete "SCSI"

Status
rlsheffi Completed 6/15/2006 11:42:18 AM

Sequence number: 8
Author: HPQ[RElliott]
Date: 4/27/2006 10:13:33 AM
T 8.10.1

need a reference to table 27
RESOLUTION: See DELL comment

Status
rlsheffi Completed 6/15/2006 11:42:51 AM

Sequence number: 9
Author: IBM[GPenokie]
Subject: Highlight
Date: 4/27/2006 10:14:39 AM
T There is no reference to table 27. This needs to be fixed as all tables have to be referenced.
RESOLUTION: See DELL comment

Status
rlsheffi Completed 6/15/2006 11:42:45 AM

Sequence number: 10
Author: SIERLGC[BMartin]
Subject: Highlight
Date: 5/11/2006 2:19:26 PM
T Page 39, Table 27
PF bit - why is the standard SEND Diagnostic defined in SPC with the PF bit set to one not supported. This should be supported.
The PF bit is optional in SPC, and should not be prohibited in SAT.

RESOLUTION: The description for the PF bit - s/b
"Unspecified (see 3.4.3)"

Status
rlsheffi Completed 6/15/2006 11:45:13 AM

Sequence number: 11
Author: IBM[GPenokie]
Subject: Underline
Date: 2/16/2006 1:44:38 PM
T 8.10.2 SELF-TEST CODE field

Status
rlsheffi Cancelled 4/27/2006 10:21:31 AM

Sequence number: 12
Author: IBM[GPenokie]
Subject: Comment on Text
Date: 4/27/2006 11:52:36 AM
T 1st paragraph
This << if the contents of this field are valid depending on the >> should be << if the contents of the SELF-TEST CODE field are valid depending on the >>
RESOLUTION: see DELL comment

Status
rlsheffi Completed 6/15/2006 11:50:25 AM

Sequence number: 13
Author: DELL[KMarks]
Subject: Highlight
Date: 4/27/2006 11:52:27 AM
T 8.10.2 SELF-TEST CODE field
1st & 2nd Paragraph

Comments from page 59 continued on next page

8.10 SEND DIAGNOSTIC command

8.10.1 SEND DIAGNOSTIC command overview

The SEND DIAGNOSTIC command provides a mechanism for an application client to request diagnostic operations to be performed on the SCSI target device, SCSI logical unit, or both. The SATL shall implement the default self-test feature (see SPC-3).

Table 27 — SEND DIAGNOSTIC command CDB fields

Field	Description or reference
OPERATION CODE	Set to 1Dh. This field value is specific to the SEND DIAGNOSTIC command.
SELF-TEST CODE	8.10.2 and 8.10.3.
PF	If the PF bit is set to zero, then the SATL shall process the command as specified in SPC-3. If the PF bit is set to one, then the SATL shall terminate the command with CHECK CONDITION status with the sense key set to ILLEGAL REQUEST and the additional sense code set to INVALID FIELD IN CDB.
SELFTEST	8.10.3
DEVOFFL	If the DEVOFFL bit is set to zero, then the SATL shall process the command as specified in SPC-3. If the DEVOFFL bit is set to one, then the SATL shall terminate the command with CHECK CONDITION status with the sense key set to ILLEGAL REQUEST and the additional sense code set to INVALID FIELD IN CDB.
UNITOFFL	If the UNITOFFL bit is set to zero, then the SATL shall process the command as specified in SPC-3. If the UNITOFFL bit is set to one, then the SATL shall terminate the command with CHECK CONDITION status with the sense key set to ILLEGAL REQUEST and the additional sense code set to INVALID FIELD IN CDB.
PARAMETER LIST LENGTH	If the PARAMETER LIST LENGTH field is set to zero, then the SATL shall process the command as specified in SPC-3. If the PARAMETER LIST LENGTH field is not set to zero, then the SATL shall terminate the command with a CHECK CONDITION status with sense key set to ILLEGAL REQUEST and additional sense code set to INVALID FIELD IN CDB.
CONTROL	6.4

8.10.2 SELF-TEST CODE field

The SATL shall determine if the contents of this field are valid depending on the value of the SELFTEST bit and what is reported by the attached ATA device with respect to the SMART EXECUTE OFF-LINE IMMEDIATE command (see 8.10.3).

If the contents of the SELF-TEST CODE field are valid, then the SATL shall process the command as described in table 28.

change

"The SATL shall determine if the contents of this field are valid depending on the value of the SELFTEST bit and what is reported by the attached ATA device with respect to the SMART EXECUTE OFF-LINE IMMEDIATE command (see 8.10.3).

If the contents of the SELF-TEST CODE field are valid, then the SATL shall process the command as described in table 28."

to

"The SATL shall determine if the value in this field is valid depending on the value of the SELFTEST bit and what is reported by the ATA device with respect to the ATA SMART EXECUTE OFF-LINE IMMEDIATE command (see 8.10.3).

If the value of the SELF-TEST CODE field is valid, then the SATL shall process the command as described in table 28."

RESOLUTION: s/b

"The SATL shall determine if the value in the SELF-TEST CODE field is valid depending on the value of the SELFTEST bit and what is reported by the ATA device with respect to the ATA SMART EXECUTE OFF-LINE IMMEDIATE command (see 8.10.3).

If the value of the SELF-TEST CODE field is valid, then the SATL shall process the command as described in table 28."

Status

risheffi Completed

6/15/2006 11:50:09 AM

Table 28 — SELF-TEST CODE field ⁴ ~~code~~ ¹

Code	Name of test	Description of test
000b	Default self-test	Used when the SELFTEST bit is set to one.
001b	Background short self-test	The SATL shall perform the following: <ol style="list-style-type: none"> 1) return status for ⁶ the command as soon as the CDB has been validated and initialize the Self-Test Results log page (see 10.2.4 and SPC-3); and 2) issue an ATA SMART EXECUTE OFF-LINE IMMEDIATE command with the LBA Low register set to 1 (i.e., Execute SMART Short self-test routine immediately in off-line mode) to the ATA device.
010b	Background extended self-test	The SATL shall perform the following: <ol style="list-style-type: none"> 1) return status for ⁷ the command as soon as the CDB has been validated and initialize the Self-Test Results log page (see 10.2.4 and SPC-3); and 2) issue an ATA SMART EXECUTE OFF-LINE IMMEDIATE command with the LBA Low register set to 2 (i.e., Execute SMART Extended self-test routine immediately in off-line mode) to the ATA device.
011b	Reserved	Unspecified (see 3.4.3)
100b	Abort background self-test	If a previous SEND DIAGNOSTIC command specified a background self-test function and that self-test has not completed (see SPC-3), then the SATL shall issue an ATA SMART EXECUTE OFF-LINE IMMEDIATE command with the LBA Low register set to 7Fh (i.e., Abort off-line mode self-test routine) to the ATA device. If the command completes successfully, the SATL shall return GOOD status. If the command fails the SATL shall respond as defined in SPC-3.
101b	Foreground short self-test	The SATL shall issue an ATA SMART EXECUTE OFF-LINE IMMEDIATE command with the LBA Low register set to 81h (i.e., Execute SMART Short self-test routine immediately in captive mode) to the ATA device. If the command completes successfully, the SATL shall update the Self-Test Results log page prior to returning GOOD status. If the command fails the SATL shall first update the Self-Test Results log page (if capable, see SPC-3) then return a CHECK CONDITION status with sense ⁸ key set to HARDWARE ERROR and additional sense code set to LOGICAL UNIT FAILED SELF-TEST.
110b	Foreground extended self-test	The SATL shall issue an ATA SMART EXECUTE OFF-LINE IMMEDIATE command with the LBA Low register set to 82h (i.e., Execute SMART Extended self-test routine immediately in captive mode) to the ATA device. If the command completes successfully, the SATL shall update the Self-Test Results log page prior to returning GOOD status. If the command fails the SATL shall first update the Self-Test Results log page (if capable, see SPC-3) then return a CHECK CONDITION status with sense key set to HARDWARE ERROR and additional sense code set to LOGICAL UNIT FAILED SELF-TEST.
111b	Reserved	Unspecified (see 3.4.3)

Sequence number: 1
Author: HPQ[WBellamy]
Subject: Note
Date: 2/20/2006 12:23:11 PM
 change "decode" to "translation"

Status
rsheffi Completed 6/15/2006 11:52:06 AM

Sequence number: 2
Author: HPQ[WBellamy]
Subject: Cross-Out
Date: 4/27/2006 11:53:49 AM
 RESOLUTION: change "decode" to "translation"

Status
rsheffi Completed 6/15/2006 11:52:06 AM

Sequence number: 3
Author: HPQ[WBellamy]
Subject: Cross-Out
Date: 4/27/2006 11:53:45 AM
 RESOLUTION: change "decode" to "translation"

Status
rsheffi Completed 6/15/2006 11:52:06 AM

Sequence number: 4
Author: HPQ[WBellamy]
Subject: Highlight
Date: 4/27/2006 11:53:55 AM
 RESOLUTION: change "decode" to "translation"

Status
rsheffi Completed 6/15/2006 11:52:06 AM

Sequence number: 5
Author: DELL[KMarks]
Subject: Highlight
Date: 2/16/2006 2:39:59 PM
 Table 28 — SELF-TEST CODE field decode

change title to
"Table 28 — SELF-TEST CODE field translation"

Status
rsheffi Completed 6/15/2006 11:52:54 AM

Sequence number: 6
Author: DELL[KMarks]
Subject: Highlight
Date: 2/5/2006 8:48:21 PM
 Table 28 — SELF-TEST CODE field decode

Row: 001b
In 1) in 1,2 list
change
"the command as"
to
"the SEND DIAGNOSTIC command as"

Status
rsheffi Completed 6/15/2006 12:02:49 PM

Sequence number: 7
Author: DELL[KMarks]
Subject: Highlight
Date: 2/5/2006 8:48:31 PM
 Table 28 — SELF-TEST CODE field decode

Row: 010b
In 1) in 1,2 list

Table 28 — SELF-TEST CODE field decode

Code	Name of test	Description of test
000b	Default self-test	Used when the SELFTEST bit is set to one.
001b	Background short self-test	The SATL shall perform the following: <ol style="list-style-type: none"> 1) return status for the command as soon as the CDB has been validated and initialize the Self-Test Results log page (see 10.2.4 and SPC-3); and 2) issue an ATA SMART EXECUTE OFF-LINE IMMEDIATE command with the LBA Low register set to 1 (i.e., Execute SMART Short self-test routine immediately in off-line mode) to the ATA device.
010b	Background extended self-test	The SATL shall perform the following: <ol style="list-style-type: none"> 1) return status for the command as soon as the CDB has been validated and initialize the Self-Test Results log page (see 10.2.4 and SPC-3); and 2) issue an ATA SMART EXECUTE OFF-LINE IMMEDIATE command with the LBA Low register set to 2 (i.e., Execute SMART Extended self-test routine immediately in off-line mode) to the ATA device.
011b	Reserved	8 Unspecified (see 3.4.3)
100b	Abort background self-test	9 a previous SEND DIAGNOSTIC command specified a background self-test function and that self-test has not completed (see SPC-3), then the SATL shall issue an ATA SMART EXECUTE OFF-LINE IMMEDIATE command with the LBA Low register set to 7Fh (i.e., Abort off-line mode self-test routine) to the ATA device. If the command completes 10 successfully, the SATL shall return GOOD status. If the command fails the SATL shall respond as defined in SPC-3.
101b	Foreground short self-test	11 The SATL shall issue an ATA SMART EXECUTE OFF-LINE IMMEDIATE command with the LBA Low register set to 81h (i.e., Execute SMART Short self-test routine immediately in captive mode) to the ATA device. If the command completes successfully, the SATL shall update the Self-Test Results log page prior to returning GOOD status. If the command fails the SATL shall first update the Self-Test Results log page (if capable, see SPC-3) then return a CHECK CONDITION status with sense  set to HARDWARE ERROR and additional sense code set to LOGICAL UNIT FAILED SELF-TEST.
110b	Foreground extended self-test	The SATL shall issue an ATA SMART EXECUTE OFF-LINE IMMEDIATE command with the LBA Low register set to 82h (i.e., Execute SMART Extended self-test routine immediately in captive mode) to the ATA device. If the command completes successfully, the SATL shall update the Self-Test Results log page prior to returning GOOD status. If the command fails the SATL shall first update the Self-Test Results log page (if capable, see SPC-3) then return a CHECK CONDITION status with sense key set to HARDWARE ERROR and additional sense code set to LOGICAL UNIT FAILED SELF-TEST.
111b	Reserved	Unspecified (see 3.4.3)

change
"the command as"
to
"the SEND DIAGNOSTIC command as"

Status
risheffi Completed 6/15/2006 12:03:14 PM

Sequence number: 8
Author: DELL[KMarks]
Subject: Cross-Out
Date: 2/16/2006 2:46:40 PM

T Table 28 — SELF-TEST CODE field decode
Row: 011b
remove
"Unspecified (see 3.4.3)"

Status
risheffi Completed 6/15/2006 12:05:07 PM

Sequence number: 9
Author: DELL[KMarks]
Subject: Highlight
Date: 4/27/2006 12:52:57 PM

T Table 28 — SELF-TEST CODE field decode
Row: 100b

1st Paragraph
change

"If a previous SEND DIAGNOSTIC command specified a background self-test function and that self-test has not completed (see SPC-3), then the SATL shall issue an ATA SMART EXECUTE OFF-LINE IMMEDIATE command with the LBA Low register set to 7Fh (i.e., Abort off-line mode self-test routine) to the ATA device. If the command completes successfully, the SATL shall return GOOD status. If the command fails the SATL shall respond as defined in SPC-3."

to

"If a previous SEND DIAGNOSTIC command specified a background self-test function and that self-test has not completed (see SPC-3), then the SATL shall issue an ATA SMART EXECUTE OFF-LINE IMMEDIATE command with the LBA Low register set to 127 (i.e., Abort off-line mode self-test routine) to the ATA device. If the ATA command completes with no error, the SATL shall return GOOD status. If the ATA command completes with an error the SATL shall respond as defined in SPC-3."

RESOLUTION (as suggested, but "with no" changed to "without"): s/b

"If a previous SEND DIAGNOSTIC command specified a background self-test function and that self-test has not completed (see SPC-3), then the SATL shall issue an ATA SMART EXECUTE OFF-LINE IMMEDIATE command with the LBA Low register set to 127 (i.e., Abort off-line mode self-test routine) to the ATA device. If the ATA SMART EXECUTE OFF-LINE IMMEDIATE command completes without error, the SATL shall return GOOD status. If the ATA command completes with an error the SATL shall respond as defined in SPC-3."

Status
risheffi Completed 6/15/2006 12:07:32 PM

Sequence number: 10
Author: MXO[MEvans]
Subject: Highlight
Date: 4/27/2006 12:52:23 PM

T Table 28, fifth row, description: change "successfully" to "without error".
RESOLUTION: see DELL comment

Status
risheffi Completed 6/15/2006 12:07:44 PM

Sequence number: 11
Author: DELL[KMarks]
Subject: Highlight
Date: 4/27/2006 12:55:52 PM

T Table 28 — SELF-TEST CODE field decode
Row: 101b

1st Paragraph

"The SATL shall issue an ATA SMART EXECUTE OFF-LINE IMMEDIATE command with the LBA Low register set to 81h (i.e., Execute SMART Short self-test routine immediately in captive mode) to the ATA device. If the command completes successfully, the SATL shall update the Self-Test Results log page prior to returning GOOD status. If the command fails the SATL shall first update the Self-Test Results log page (if capable, see SPC-3) then return a CHECK CONDITION status

Table 28 — SELF-TEST CODE field decode

Code	Name of test	Description of test
000b	Default self-test	Used when the SELFTEST bit is set to one.
001b	Background short self-test	The SATL shall perform the following: <ol style="list-style-type: none"> 1) return status for the command as soon as the CDB has been validated and initialize the Self-Test Results log page (see 10.2.4 and SPC-3); and 2) issue an ATA SMART EXECUTE OFF-LINE IMMEDIATE command with the LBA Low register set to 1 (i.e., Execute SMART Short self-test routine immediately in off-line mode) to the ATA device.
010b	Background extended self-test	The SATL shall perform the following: <ol style="list-style-type: none"> 1) return status for the command as soon as the CDB has been validated and initialize the Self-Test Results log page (see 10.2.4 and SPC-3); and 2) issue an ATA SMART EXECUTE OFF-LINE IMMEDIATE command with the LBA Low register set to 2 (i.e., Execute SMART Extended self-test routine immediately in off-line mode) to the ATA device.
011b	Reserved	Unspecified (see 3.4.3)
100b	Abort background self-test	If a previous SEND DIAGNOSTIC command specified a background self-test function and that self-test has not completed (see SPC-3), then the SATL shall issue an ATA SMART EXECUTE OFF-LINE IMMEDIATE command with the LBA Low register set to 7Fh (i.e., Abort off-line mode self-test routine) to the ATA device. If the command completes successfully, the SATL shall return GOOD status. If the command fails the SATL shall respond as defined in SPC-3.
101b	Foreground short self-test	The SATL shall issue an ATA SMART EXECUTE OFF-LINE IMMEDIATE command with the LBA Low register set to 81h (i.e., Execute SMART Short self-test routine immediately in captive mode) to the ATA device. If the command completes ¹² successfully, the SATL shall update the Self-Test Results log page prior to returning GOOD status. If the command fails the SATL shall first update the Self-Test Results log page (if capable, see SPC-3) then return a CHECK CONDITION status with sense  ¹³ to HARDWARE ERROR and additional sense code set to LOGICAL UNIT FAILED SELF-TEST.
110b	Foreground extended self-test	¹⁴ The SATL shall issue an ATA SMART EXECUTE OFF-LINE IMMEDIATE command with the LBA Low register set to 82h (i.e., Execute SMART Extended self-test routine immediately in captive mode) to the ATA device. If the command completes successfully, the SATL shall update the Self-Test Results log page prior to returning GOOD status. If the command fails the SATL shall first update the Self-Test Results log page (if capable, see SPC-3) then return a CHECK CONDITION status with sense key set to HARDWARE ERROR and additional sense code set to LOGICAL UNIT FAILED SELF-TEST.
111b	Reserved	Unspecified (see 3.4.3)

with sense key set to **HARDWARE ERROR** and additional sense codeset to **LOGICAL UNIT FAILED SELF-TEST.**"

to

"The SATL shall issue an **ATA SMART EXECUTE OFF-LINE IMMEDIATE** command with the LBA Low register set to 129 (i.e., Execute **SMART Short self-test routine** immediately in captive mode) to the ATA device. If the ATA command completes with no error, the SATL shall update the Self-Test Results log page prior to returning **GOOD** status. If the ATA command completes with an error the SATL shall first update the Self-Test Results log page (if capable, see SPC-3) then return a **CHECK CONDITION** status with the sense key set to **HARDWARE ERROR** and additional sense code set to **LOGICAL UNIT FAILED SELF-TEST.**"

RESOLUTION: s/b

"The SATL shall issue an **ATA SMART EXECUTE OFF-LINE IMMEDIATE** command with the LBA Low register set to 129 (i.e., Execute **SMART Short self-test routine** immediately in captive mode) to the ATA device. If the **ATA SMART EXECUTE OFF-LINE IMMEDIATE** command completes without error, the SATL shall update the Self-Test Results log page prior to returning **GOOD** status. If the ATA command completes with an error the SATL shall first update the Self-Test Results log page (i.e., if supported, see SPC-3), and terminate the command with **CHECK CONDITION** status with the sense key set to **HARDWARE ERROR** and the additional sense code set to **LOGICAL UNIT FAILED SELF-TEST.**"

Status
r/sheffi Completed 6/15/2006 12:08:48 PM

Sequence number: 12
Author: MXO[MEvans]
Subject: Highlight
Date: 4/27/2006 12:56:18 PM

 Table 28, sixth row, description: change "successfully" to "without error".

RESOLUTION: See DELL comment

Status
r/sheffi Completed 6/15/2006 12:08:58 PM

Sequence number: 13
Author: HPQ[WBellamy]
Subject: Note
Date: 2/20/2006 1:08:23 PM

 A space between these two words is needed.

Status
r/sheffi Completed 6/15/2006 12:09:13 PM

Sequence number: 14
Author: DELL[KMarks]
Subject: Highlight
Date: 4/27/2006 12:58:02 PM

 **Table 28 — SELF-TEST CODE field decode**

Row: 110b

1st Paragraph

change

"The SATL shall issue an **ATA SMART EXECUTE OFF-LINE IMMEDIATE** command with the LBA Low register set to 82h (i.e., Execute **SMART Extended self-test routine** immediately in captive mode) to the ATA device. If the command completes successfully, the SATL shall update the Self-Test Results log page prior to returning **GOOD** status. If the command fails the SATL shall first update the Self-Test Results log page (if capable, see SPC-3) then return a **CHECK CONDITION** status with sense key set to **HARDWARE ERROR** and additional sense code set to **LOGICAL UNIT FAILED SELF-TEST.**"

to

"The SATL shall issue an **ATA SMART EXECUTE OFF-LINE IMMEDIATE** command with the LBA Low register set to 130 (i.e., Execute **SMART Extended self-test routine** immediately in captive mode) to the ATA device. If the ATA command completes with no error, the SATL shall update the Self-Test Results log page prior to returning **GOOD** status. If the ATA command completes with an error the SATL shall first update the Self-Test Results log page (if capable, see SPC-3) then return a **CHECK CONDITION** status with the sense key set to **HARDWARE ERROR** and additional sense code set to **LOGICAL UNIT FAILED SELF-TEST.**"

RESOLUTION: s/b

"The SATL shall issue an **ATA SMART EXECUTE OFF-LINE IMMEDIATE** command with the LBA Low register set to 130 (i.e., Execute **SMART Extended self-test routine** immediately in captive mode) to the ATA device. If the **ATA SMART EXECUTE OFF-LINE IMMEDIATE** command completes without error, the SATL shall update the Self-Test Results log page prior to returning **GOOD** status. If the ATA command completes with an error, the SATL shall first update the Self-Test Results log page (i.e., if supported, see SPC-3), and then terminate the command with **CHECK CONDITION** status with the sense key set to **HARDWARE ERROR** and additional sense code set to **LOGICAL UNIT FAILED SELF-TEST.**"

Status
r/sheffi Completed 6/15/2006 12:23:44 PM

Comments from page 60 continued on next page

Table 28 — SELF-TEST CODE field decode

Code	Name of test	Description of test
000b	Default self-test	Used when the SELFTEST bit is set to one.
001b	Background short self-test	The SATL shall perform the following: <ol style="list-style-type: none"> 1) return status for the command as soon as the CDB has been validated and initialize the Self-Test Results log page (see 10.2.4 and SPC-3); and 2) issue an ATA SMART EXECUTE OFF-LINE IMMEDIATE command with the LBA Low register set to 1 (i.e., Execute SMART Short self-test routine immediately in off-line mode) to the ATA device.
010b	Background extended self-test	The SATL shall perform the following: <ol style="list-style-type: none"> 1) return status for the command as soon as the CDB has been validated and initialize the Self-Test Results log page (see 10.2.4 and SPC-3); and 2) issue an ATA SMART EXECUTE OFF-LINE IMMEDIATE command with the LBA Low register set to 2 (i.e., Execute SMART Extended self-test routine immediately in off-line mode) to the ATA device.
011b	Reserved	Unspecified (see 3.4.3)
100b	Abort background self-test	If a previous SEND DIAGNOSTIC command specified a background self-test function and that self-test has not completed (see SPC-3), then the SATL shall issue an ATA SMART EXECUTE OFF-LINE IMMEDIATE command with the LBA Low register set to 7Fh (i.e., Abort off-line mode self-test routine) to the ATA device. If the command completes successfully, the SATL shall return GOOD status. If the command fails the SATL shall respond as defined in SPC-3.
101b	Foreground short self-test	The SATL shall issue an ATA SMART EXECUTE OFF-LINE IMMEDIATE command with the LBA Low register set to 81h (i.e., Execute SMART Short self-test routine immediately in captive mode) to the ATA device. If the command completes successfully, the SATL shall update the Self-Test Results log page prior to returning GOOD status. If the command fails the SATL shall first update the Self-Test Results log page (if capable, see SPC-3) then return a CHECK CONDITION status with sense  set to HARDWARE ERROR and additional sense code set to LOGICAL UNIT FAILED SELF-TEST.
110b	Foreground extended self-test	The SATL shall issue an ATA SMART EXECUTE OFF-LINE IMMEDIATE command with the LBA Low register set to 82h (i.e., Execute SMART Extended self-test routine immediately in captive mode) to the ATA device. If the command completes ¹⁵ successfully, the SATL shall update the Self-Test Results log page prior to returning GOOD status. If the command fails the SATL shall first update the Self-Test Results log page (if capable, see SPC-3) then return a CHECK CONDITION status with sense key set to HARDWARE ERROR and additional sense code set to LOGICAL UNIT FAILED SELF-TEST.
111b	Reserved	Unspecified (see 3.4.3)

Sequence number: 15
Author: MXO[MEvans]
Subject: Highlight
Date: 4/27/2006 12:58:12 PM

T Table 28, seventh row, description: change "successfully" to "without error".
RESOLUTION: See DELL comment

Status
risheffi Completed 6/15/2006 12:24:06 PM

Sequence number: 16
Author: DELL[KMarks]
Subject: Cross-Out
Date: 2/16/2006 2:46:32 PM

T Table 28 — SELF-TEST CODE field decode

T Row: 111b
remove
"Unspecified (see 3.4.3)"

Status
risheffi Completed 6/15/2006 12:25:49 PM

10.3 SELFTEST bit 





The SATL shall  code the SELFTEST bit according to whether or not the  attached ATA device  supports and has enabled the  SMART EXECUTE OFF-LINE IMMEDIATE command as shown in Table 29.

Table 29 — SELFTEST bit

Code	SMART EXECUTE OFF-LINE IMMEDIATE command ^a		SATL emulation
	supported	enabled	
0	no	n/a	The SATL shall terminate the command with CHECK CONDITION status with the sense key set to ILLEGAL REQUEST and the additional sense code set to INVALID FIELD IN CDB.
0	yes	no	The SATL shall terminate the command with CHECK CONDITION status with the sense key set to ABORTED COMMAND and the additional sense code set to ATA DEVICE FEATURE NOT ENABLED.
0	yes	yes	The SATL shall process the command according to the value specified in the SELF-TEST CODE field as defined in 8.10.2.
	no	n/a	The SATL shall disregard the contents of the SELF-TEST CODE FIELD. The SATL shall send three ATA verify commands (see 3.1.17) to the attached ATA device with with the LBA set as follows: <ul style="list-style-type: none"> a) an ATA verify command with the Sector Count set to one and the LBA set to zero; b) an ATA verify command with the Sector Count set to one and the LBA set to the maximum LBA; and c) an ATA verify command with the Sector Count set to one and the LBA set to a random number between zero and the maximum LBA. If any of the three ATA verify commands fails, then the SATL shall terminate the command with CHECK CONDITION status with the sense key set to HARDWARE ERROR and the additional sense code set to LOGICAL UNIT FAILED SELF-TEST. If all three commands complete successfully, then the SATL shall return GOOD status.
	yes	no	
1	yes	yes	The SATL shall issue a SMART EXECUTE OFF-LINE IMMEDIATE command with the LBA Low register set to 81h (i.e., Execute SMART Short self-test routine immediately in captive mode) to the ATA device. If the command completes successfully, the SATL shall return GOOD status. If the command fails the SATL shall terminate the command with CHECK CONDITION status with the sense key set to HARDWARE ERROR and the additional sense code set to LOGICAL UNIT FAILED SELF-TEST.

^a The SATL shall determine if the SMART EXECUTE OFF-LINE IMMEDIATE command is supported and enabled from the ATA device IDENTIFY DEVICE data word 84, bit 1, and word 85, bit 0 (see ATA/ATAPI-7).

Page: 61

Sequence number: 1
Author: IBM[GPenokie]
Subject: Underline
Date: 2/16/2006 1:29:56 PM
T 8.10.3 SELFTEST bit

Status
rsheffi Cancelled 4/27/2006 12:58:36 PM

Sequence number: 2
Author: HPQ[WBellamy]
Subject: Note
Date: 2/20/2006 12:21:55 PM
 change decode to "translate"

Status
rsheffi Completed 6/15/2006 12:26:14 PM

Sequence number: 3
Author: DELL[KMarks]
Subject: Cross-Out
Date: 2/16/2006 10:15:28 PM
T attached

Status
rsheffi Completed 6/15/2006 12:26:34 PM

Sequence number: 4
Author: HPQ[WBellamy]
Subject: Cross-Out
Date: 4/27/2006 1:14:28 PM
T Duplicate

Status
rsheffi Cancelled 4/27/2006 1:14:33 PM

Sequence number: 5
Author: HPQ[WBellamy]
Subject: Highlight
Date: 4/27/2006 1:14:21 PM
T Duplicate

Status
rsheffi Cancelled 4/27/2006 1:14:09 PM

Sequence number: 6
Author: IBM[GPenokie]
Subject: Oval
Date: 2/16/2006 8:45:15 AM
 Global

The capitalization of the references to tables is inconsistent. It should only be capitalized when it is the first word of a sentence.

Status
rsheffi Completed 6/15/2006 12:27:00 PM

Sequence number: 7
Author: DELL[KMarks]
Subject: Highlight
Date: 2/16/2006 9:58:43 PM
T 8.10.3 SELFTEST bit

1st Paragraph, 1st Sentence
change
"SMART EXECUTE OFF-LINE IMMEDIATE"
to
"ATA SMART EXECUTE OFF-LINE IMMEDIATE"

Status
rsheffi Completed 6/15/2006 12:27:49 PM

Sequence number: 8
Author: DELL[KMarks]
Subject: Highlight

Comments from page 61 continued on next page

8.10.3 SELFTEST bit

The SATL shall **decode** the SELFTEST bit according to whether or not the **attached ATA device** supports and has enabled the **SMART EXECUTE OFF-LINE IMMEDIATE** command as shown in Table 29.

Table 29 — SELFTEST bit

Code	SMART EXECUTE OFF-LINE IMMEDIATE command ^a		SATL emulation
	supported	enabled	
0	no	n/a	The SATL shall terminate 9 the command with CHECK CONDITION status with the sense key set to ILLEGAL REQUEST and the additional sense code set to INVALID FIELD IN CDB.
0	yes	no	The SATL shall terminate 10 the command with CHECK CONDITION status with 11 the sense key set to ABORTED COMMAND and the additional sense code set to ATA DEVICE FEATURE NOT ENABLED.
0	yes	yes	12 The SATL shall process the command according to the value specified in the SELF-TEST CODE field as defined in 8.10.2.
1	no	n/a	<p>The SATL shall disregard the contents of the SELF-TEST CODE FIELD.</p> <p>The SATL shall send three ATA verify commands (see 3.1.17) to the attached ATA device with with the LBA set as follows:</p> <ul style="list-style-type: none"> a) an ATA verify command with the Sector Count set to one and the LBA set to zero; b) an ATA verify command with the Sector Count set to one and the LBA set to the maximum LBA; and c) an ATA verify command with the Sector Count set to one and the LBA set to a random number between zero and the maximum LBA. <p>If any of the three ATA verify commands fails, then the SATL shall terminate the command with CHECK CONDITION status with the sense key set to HARDWARE ERROR and the additional sense code set to LOGICAL UNIT FAILED SELF-TEST.</p> <p>If all three commands complete successfully, then the SATL shall return GOOD status.</p>
	yes	no	
1	yes	yes	The SATL shall issue a SMART EXECUTE OFF-LINE IMMEDIATE command with the LBA Low register set to 81h (i.e., Execute SMART Short self-test routine immediately in captive mode) to the ATA device. If the command completes successfully, the SATL shall return GOOD status. If the command fails the SATL shall terminate the command with CHECK CONDITION status with the sense key set to HARDWARE ERROR and the additional sense code set to LOGICAL UNIT FAILED SELF-TEST.

^a The SATL shall determine if the SMART EXECUTE OFF-LINE IMMEDIATE command is supported and enabled from the ATA device IDENTIFY DEVICE data word 84, bit 1, and word 85, bit 0 (see ATA/ATAPI-7).

Date: 2/4/2006 10:33:27 PM

T Table 29 — SELFTEST bit
2nd Column title
change
"SMART EXECUTE OFF-LINE
IMMEDIATE command a"
to
"ATA SMART EXECUTE OFF-LINE
IMMEDIATE command a"

Status
risheffi Completed 6/15/2006 12:28:34 PM

Sequence number: 9
Author: DELL[KMarks]
Subject: Highlight
Date: 4/27/2006 1:17:09 PM

T Table 29 — SELFTEST bit
Row: 0 no n/a
change
"the command with"
to
"the SEND DIAGNOSTIC command with a"
RESOLUTION: s/b
"the SEND DIAGNOSTIC command with"

Status
risheffi Completed 6/15/2006 12:29:54 PM

Sequence number: 10
Author: DELL[KMarks]
Subject: Highlight
Date: 4/27/2006 1:17:48 PM

T Table 29 — SELFTEST bit
Row: 0 yes no
change
"the command with"
to
"the SEND DIAGNOSTIC command with a"
RESOLUTION: s/b
"the SEND DIAGNOSTIC command with"

Status
risheffi Completed 6/15/2006 12:30:08 PM

Sequence number: 11
Author: DELL[KMarks]
Subject: Note
Date: 5/11/2006 2:58:32 PM

T Table 29 — SELFTEST bit
Row: Code 0, Yes, No

Have a little problem with this, in that if informational exception reporting is disabled (i.e. DEXCPT=1), then one can not run a self-test. Would almost say for this row, enable SMART OPS run test then disable SMART OPS..
RESOLUTION: Fix MODE SELECT specifying DEXCPT so that it doesn't affect whether SMART OPS are enabled or not, and leave the text here unchanged.

Status
risheffi Completed 6/15/2006 12:37:30 PM

Sequence number: 12
Author: HPQ[WBellamy]
Subject: Note
Date: 4/27/2006 1:28:36 PM

T Earlier information indicates that another cdb field's validity depends on this bit value and device configuration. I suggest that because of the stressing of another field's dependent "validity" that the editor add the following statement prior the existing statement here to help alleviate confusion for developers and also readers:
add: "SELF-TEST CODE field is valid."
RESOLUTION: change
"The SATL shall process the command according to the value specified in the SELF-TEST CODE field as defined in 8.10.2."

Comments from page 61 continued on next page

8.10.3 SELFTEST bit

The SATL shall ~~decode~~ the SELFTEST bit according to whether or not the ~~attached~~ ATA device supports and has enabled the SMART EXECUTE OFF-LINE IMMEDIATE command as shown in Table 29.

Table 29 — SELFTEST bit

Code	SMART EXECUTE OFF-LINE IMMEDIATE command ^a		SATL emulation
	supported	enabled	
0	no	n/a	The SATL shall terminate the command with CHECK CONDITION status with the sense key set to ILLEGAL REQUEST and the additional sense code set to INVALID FIELD IN CDB.
0	yes	no	The SATL shall terminate the command with CHECK CONDITION status with the sense key set to ABORTED COMMAND and the additional sense code set to ATA DEVICE FEATURE NOT ENABLED.
0	yes	yes	The SATL shall process the command according to the value specified in the SELF-TEST CODE field as defined in 8.10.2.
1	no	n/a	<p>The SATL shall disregard the contents of the SELF-TEST CODE FIELD.</p> <p>The SATL shall send three ATA verify commands (see 3.1.17) to the attached ATA device with with the LBA set as follows:</p> <ul style="list-style-type: none"> a) an ATA verify command with the Sector Count set to one and the LBA set to zero; b) an ATA verify command with the Sector Count set to one and the LBA set to the maximum LBA; and c) an ATA verify command with the Sector Count set to one and the LBA set to a random number between zero and the maximum LBA. <p>If any of the three ATA verify commands fails, then the SATL shall terminate the command with CHECK CONDITION status with the sense key set to HARDWARE ERROR and the additional sense code set to LOGICAL UNIT FAILED SELF-TEST.</p> <p>If all three commands complete successfully, then the SATL shall return GOOD status.</p>
	yes	no	
1	yes	yes	The SATL shall issue a SMART EXECUTE OFF-LINE IMMEDIATE command with the LBA Low register set to 81h (i.e., Execute SMART Short self-test routine immediately in captive mode) to the ATA device. If the command completes successfully, the SATL shall return GOOD status. If the command fails the SATL shall terminate the command with CHECK CONDITION status with the sense key set to HARDWARE ERROR and the additional sense code set to LOGICAL UNIT FAILED SELF-TEST.

^a The SATL shall determine if the SMART EXECUTE OFF-LINE IMMEDIATE command is supported and enabled from the ATA device IDENTIFY DEVICE data word 84, bit 1, and word 85, bit 0 (see ATA/ATAPI-7).

to
"The SELF-TEST CODE field is valid and SATL shall process the SEND DIAGNOSTIC command according to the value specified in the SELF-TEST CODE field as defined in 8.10.2."

Status
risheffi Completed 6/15/2006 12:43:37 PM

Sequence number: 13
Author: DELL[KMarks]
Subject: Highlight
Date: 4/27/2006 1:28:49 PM

T Table 29 — SELFTEST bit
Row: 0 yes yes
change
"process the command"
to
"process the SEND DIAGNOSTIC command"
RESOLUTION: See HPQ comment

Status
risheffi Completed 6/15/2006 12:43:46 PM

Sequence number: 14
Author: DELL[KMarks]
Subject: Highlight
Date: 6/15/2006 1:21:54 PM

T Table 29 — SELFTEST bit
Row: 1 no N/a
change

"The SATL shall disregard the contents of the SELF-TEST CODE FIELD.

The SATL shall send three ATA verify commands (see 3.1.17) to the attached ATA device with with the LBA set as follows:

- a) an ATA verify command with the Sector Count set to one and the LBA set to zero;
- b) an ATA verify command with the Sector Count set to one and the LBA set to the maximum LBA; and
- c) an ATA verify command with the Sector Count set to one and the LBA set to a random number between zero

and the maximum LBA.

If any of the three ATA verify commands fails, then the SATL shall terminate the command with CHECK CONDITION status with the sense key set to HARDWARE ERROR and the additional sense code set to LOGICAL UNIT FAILED SELF-TEST.

If all three commands complete successfully, then the SATL shall return GOOD status."

to

"The SATL shall send three ATA verify commands (see 3.1.17) to the ATA device with the Sector Count set to one and the LBA set to:

- a) zero;
- b) the maximum LBA; and
- c) a random number between zero and the maximum LBA.

If any of the three ATA verify commands end with an error, then the SATL shall terminate the SEND DIAGNOSTIC command with a CHECK CONDITION status with the sense key set to HARDWARE ERROR and the additional sense code set to LOGICAL UNIT FAILED SELF-TEST.

If all three ATA verify commands complete with no error, then the SATL shall return GOOD status."

RESOLUTION (added "user-addressable"):

"The SATL shall send three ATA verify commands (see 3.1.17) to the ATA device with the Sector Count set to one and the LBA set to:

- a) zero;
- b) the maximum user-addressable LBA; and
- c) an arbitrary number between zero and the maximum user-addressable LBA.

If any of the three ATA verify commands end with an error, then the SATL shall terminate the SEND DIAGNOSTIC command with a CHECK CONDITION status with the sense key set to HARDWARE ERROR and the additional sense code set to LOGICAL UNIT FAILED SELF-TEST.

Comments from page 61 continued on next page

8.10.3 SELFTEST bit

The SATL shall **decode** the SELFTEST bit according to whether or not the **attached ATA device** supports and has enabled the **SMART EXECUTE OFF-LINE IMMEDIATE** command as shown in Table 29.

Table 29 — SELFTEST bit

Code	SMART EXECUTE OFF-LINE IMMEDIATE command ^a		SATL emulation
	supported	enabled	
0	no	n/a	The SATL shall terminate the command with CHECK CONDITION status with the sense key set to ILLEGAL REQUEST and the additional sense code set to INVALID FIELD IN CDB.
0	yes	no	The SATL shall terminate the command with CHECK CONDITION status with the sense key set to ABORTED COMMAND and the additional sense code set to ATA DEVICE FEATURE NOT ENABLED.
0	yes	yes	The SATL shall process the command according to the value specified in the SELF-TEST CODE field as defined in 8.10.2.
1	15	n/a	<p>The SATL shall disregard the contents of the SELF-TEST CODE FIELD.</p> <p>The SATL shall send three ATA verify commands (see 3.1.17) to the attached ATA device with with the LBA set as follows:</p> <ul style="list-style-type: none"> a) an ATA verify command with the Sector Count set to one and the LBA set to zero; b) an ATA verify command with the Sector Count set to one and the LBA set to the maximum LBA; and c) an ATA verify command with the Sector Count set to one and the LBA set to a random number between zero and the maximum LBA. <p>If any of the three ATA verify commands fails, then the SATL shall terminate the command with CHECK CONDITION status with the sense key set to HARDWARE ERROR and the additional sense code set to LOGICAL UNIT FAILED SELF-TEST.</p> <p>If all three commands complete¹⁷ successfully, then the SATL shall return GOOD status.</p>
	16	yes	no
1	yes	yes	The SATL shall issue ¹⁸ SMART EXECUTE OFF-LINE IMMEDIATE command with the LBA Low register set to 81h (i.e., Execute SMART Short self-test routine immediately in captive mode) to the ATA device. If the command completes successfully, the SATL shall return GOOD status. If the command fails the SATL shall terminate the command with CHECK CONDITION status with the sense key set to HARDWARE ERROR and the additional sense code set to LOGICAL UNIT FAILED SELF-TEST.

^a The SATL shall determine if the SMART EXECUTE OFF-LINE IMMEDIATE command is supported and enabled from the ATA device IDENTIFY DEVICE data word 84, bit 1, and word 85, bit 0 (see ATA/ATAPI-7).

If all three ATA verify commands complete without error, then the SATL shall return GOOD status."

DISCUSS (is this too draconian?) Suggestion - to ATA verify to two arbitrary sectors and only return HARDWARE ERROR if both arbitrary sectors fail - or DF bit set on any command.

TODO: Put this out on the T10 and T13 reflectors.

Status
rsheffi Completed 6/15/2006 1:03:54 PM

Sequence number: 15
Author: LSI[OParry]
Subject: Highlight
Date: 6/15/2006 1:26:21 PM
 Section 8.10.3 SELFTEST bit
Table 29 - SELFTEST bit

Self-Test bit set to 1, SMART EXECUTE OFF-LINE IMMEDIATE not supported.

The mechanism of issuing ATA Verify commands to the first, last and a middle random LBA seems fickle. A Verify command can fail but it's possible that a block can be reallocated. We could be potentially failing a self test for a condition that is remediable. I read in the Minutes from a previous meeting and there was a statement that Execute Device Diagnostics command may potentially have dire consequences. So my suggestions for this case is to *remove the SHALL and make it more of a suggestion*, include the option for *simply returning GOOD status in this case without performing any activities*, or possibly leaving it *unspecified* such that a vendor may implement as they wish but put in place some informative text.

RESOLUTION: Add a table footnote as follows:

"The SATL may retry any of the three Verify commands if a Verify command fails on the first attempt, and the retry may specify an alternate LBA. If the retry completes without error, the SATL may consider the Verify command as completed without error."

Status
rsheffi Completed 6/15/2006 1:07:12 PM

Sequence number: 16
Author: ELX[KHirata]
Subject: Note
Date: 6/15/2006 1:23:56 PM
 Location: Page 41, 8.10.3, Table 29, Row 4 & 5.

Comment:

If the attached ATA device doesn't implement a basic diagnostic routine then why is the SATL trying to emulate this with VERIFY commands? Perhaps it's a value-add, but it seems like work that is beyond the scope of a translation layer.

Preferred resolution:

We can make the existing approach work, but it seems like work that the SATL perhaps shouldn't be doing. Why not just fail the command as per some of the surrounding table entries.

Note: Those at the May 11, 2006 SAT WG felt the need to do some form of verification was sufficiently crucial to products that a "shall" is warranted, and allowing it to be optional would cause non-interoperability problems.

RESOLUTION: Add a footnote as follows -

"The SATL may retry any of the three Verify commands if a Verify command fails on the first attempt, and the retry may specify an alternate LBA. If the retry completes without error, the SATL may consider the Verify command as completed without error."

Status
rsheffi Completed 6/15/2006 1:23:58 PM

Sequence number: 17
Author: MXO[MEvans]
Subject: Highlight
Date: 2/13/2006 9:30:09 AM
 Table 29, fourth row, description: change "successfully" to "without error".

Status
rsheffi Completed 6/15/2006 1:24:27 PM

Sequence number: 18

Comments from page 61 continued on next page

8.10.3 SELFTEST bit

The SATL shall ~~decode~~ the SELFTEST bit according to whether or not the ~~attached~~ ATA device supports and has enabled the SMART EXECUTE OFF-LINE IMMEDIATE command as shown in Table 29.

Table 29 — SELFTEST bit

Code	SMART EXECUTE OFF-LINE IMMEDIATE command ^a		SATL emulation
	supported	enabled	
0	no	n/a	The SATL shall terminate the command with CHECK CONDITION status with the sense key set to ILLEGAL REQUEST and the additional sense code set to INVALID FIELD IN CDB.
0	yes	no	The SATL shall terminate the command with CHECK CONDITION status with the sense key set to ABORTED COMMAND and the additional sense code set to ATA DEVICE FEATURE NOT ENABLED.
0	yes	yes	The SATL shall process the command according to the value specified in the SELF-TEST CODE field as defined in 8.10.2.
1	no	n/a	<p>The SATL shall disregard the contents of the SELF-TEST CODE FIELD.</p> <p>The SATL shall send three ATA verify commands (see 3.1.17) to the attached ATA device with with the LBA set as follows:</p> <ul style="list-style-type: none"> a) an ATA verify command with the Sector Count set to one and the LBA set to zero; b) an ATA verify command with the Sector Count set to one and the LBA set to the maximum LBA; and c) an ATA verify command with the Sector Count set to one and the LBA set to a random number between zero and the maximum LBA. <p>If any of the three ATA verify commands fails, then the SATL shall terminate the command with CHECK CONDITION status with the sense key set to HARDWARE ERROR and the additional sense code set to LOGICAL UNIT FAILED SELF-TEST.</p> <p>If all three commands complete successfully, then the SATL shall return GOOD status.</p>
	yes	no	
1	yes	yes	The SATL shall issue a SMART EXECUTE OFF-LINE IMMEDIATE command with the LBA Low register ¹⁹ to 81h (i.e., Execute SMART Short self-test routine immediately in captive mode) to the ATA device. ²⁰ The command completes ²¹ successfully, the SATL shall return GOOD status. If the command fails the SATL shall terminate the command with CHECK CONDITION status with the sense key set to HARDWARE ERROR and the additional sense code set to LOGICAL UNIT FAILED SELF-TEST.

^a ²² The SATL shall determine if the SMART EXECUTE OFF-LINE IMMEDIATE command is supported and enabled from the ATA device IDENTIFY DEVICE data word 84, bit 1, and word 85, bit 0 (see ATA/ATAPI-7).

Author: DELL[KMarks]
Subject: Highlight
Date: 2/16/2006 10:03:24 PM

T Table 29 — SELFTEST bit

Row: 1 yes yes

1st Sentence
change

"a SMART EXECUTE OFF-LINE
IMMEDIATE"

to

"an ATA SMART EXECUTE OFF-LINE
IMMEDIATE"

Status
rlsheffi Completed 6/15/2006 1:24:49 PM

Sequence number: 19
Author: DELL[KMarks]
Subject: Highlight
Date: 2/5/2006 8:19:59 PM

T Table 29 — SELFTEST bit

Row: 1 yes yes

1st Sentence
change

"... set to 81h (i.e.,"

to

"... set to 129 (i.e.,"

Status
rlsheffi Completed 6/15/2006 1:25:32 PM

Sequence number: 20
Author: DELL[KMarks]
Subject: Highlight
Date: 4/27/2006 2:14:15 PM

T Table 29 — SELFTEST bit

Row: 1 yes yes

2nd Sentence
change

"If the command completes successfully, the SATL shall return GOOD status. If the command fails the SATL shall terminate the command with CHECK CONDITION status with the sense key set to HARDWARE ERROR and the additional sense code set to LOGICAL UNIT FAILED SELF-TEST."

to

"If the ATA command completes with no error, the SATL shall return GOOD status. If the ATA command completes with an error, the SATL shall terminate the SEND DIAGNOSITC command with a CHECK CONDITION status with the sense key set to HARDWARE ERROR and the additional sense code set to LOGICAL UNIT FAILED SELF-TEST."

RESOLUTION: s/b

"If the ATA EXECUTE OFF-LINE IMMEDIATE command completes without error, the SATL shall return GOOD status. If the ATA EXECUTE OFF-LINE IMMEDIATE command completes with an error, the SATL shall terminate the SEND DIAGNOSITC command with a CHECK CONDITION status with the sense key set to HARDWARE ERROR and the additional sense code set to LOGICAL UNIT FAILED SELF-TEST."

Status
rlsheffi Completed 6/15/2006 1:48:55 PM

Sequence number: 21
Author: MXO[MEvans]
Subject: Highlight
Date: 2/13/2006 9:30:29 AM

T Table 29, fifth row, description: change "successfully" to "without error".

Status
rlsheffi Completed 6/15/2006 1:49:13 PM

Sequence number: 22
Author: DELL[KMarks]
Subject: Highlight
Date: 5/25/2006 12:13:32 PM

T Table 29 — SELFTEST bit
footnote a

Comments from page 61 continued on next page

8.10.3 SELFTEST bit

The SATL shall **decode** the SELFTEST bit according to whether or not the **attached ATA device** supports and has enabled the **SMART EXECUTE OFF-LINE IMMEDIATE** command as shown in Table 29.

Table 29 — SELFTEST bit

Code	SMART EXECUTE OFF-LINE IMMEDIATE command ^a		SATL emulation
	supported	enabled	
0	no	n/a	The SATL shall terminate the command with CHECK CONDITION status with the sense key set to ILLEGAL REQUEST and the additional sense code set to INVALID FIELD IN CDB.
0	yes	no	The SATL shall terminate the command with CHECK CONDITION status with the sense key set to ABORTED COMMAND and the additional sense code set to ATA DEVICE FEATURE NOT ENABLED.
0	yes	yes	The SATL shall process the command according to the value specified in the SELF-TEST CODE field as defined in 8.10.2.
1	no	n/a	<p>The SATL shall disregard the contents of the SELF-TEST CODE FIELD.</p> <p>The SATL shall send three ATA verify commands (see 3.1.17) to the attached ATA device with with the LBA set as follows:</p> <ul style="list-style-type: none"> a) an ATA verify command with the Sector Count set to one and the LBA set to zero; b) an ATA verify command with the Sector Count set to one and the LBA set to the maximum LBA; and c) an ATA verify command with the Sector Count set to one and the LBA set to a random number between zero and the maximum LBA. <p>If any of the three ATA verify commands fails, then the SATL shall terminate the command with CHECK CONDITION status with the sense key set to HARDWARE ERROR and the additional sense code set to LOGICAL UNIT FAILED SELF-TEST.</p> <p>If all three commands complete successfully, then the SATL shall return GOOD status.</p>
	yes	no	
1	yes	yes	The SATL shall issue a SMART EXECUTE OFF-LINE IMMEDIATE command with the LBA Low register set to 81h (i.e., Execute SMART Short self-test routine immediately in captive mode) to the ATA device. If the command completes successfully, the SATL shall return GOOD status. If the command fails the SATL shall terminate the command with CHECK CONDITION status with the sense key set to HARDWARE ERROR and the additional sense code set to LOGICAL UNIT FAILED SELF-TEST.

^a The SATL shall determine if the SMART EXECUTE OFF-LINE IMMEDIATE command is supported and enabled from the ATA device IDENTIFY DEVICE data word 84, bit 1, and word 85, bit 0 (see ATA/ATAPI-7).

change

"The SATL shall determine if the SMART EXECUTE OFF-LINE IMMEDIATE command is supported and enabled from the ATA device IDENTIFY DEVICE data word 84, bit 1, and word 85, bit 0 (see ATA/ATAPI-7)."

to

"The SATL shall determine if the ATA SMART EXECUTE OFF-LINE IMMEDIATE command is supported and enabled based on the ATA IDENTIFY DEVICE data word 84, bit 1, and word 85, bit 0 (see ATA/ATAPI-7)."

RESOLUTION: change to,

"The SATL shall determine if the ATA SMART EXECUTE OFF-LINE IMMEDIATE command is supported and enabled based on the ATA IDENTIFY DEVICE data word 84, bit 1, and word 85, bit 0 (see ATA8-ACS)."

Status

risheffi Completed

6/15/2006 1:50:22 PM

8.11 TEST UNIT READY command

11.1 TEST UNIT READY command overview

The TEST UNIT READY command is used to determine whether the device is ready (see table 30).

Table 30 — TEST UNIT READY command CDB fields

Field	Description or reference
OPERATION CODE	8.11.2. ²
CONTROL	6.4

11.2 TEST UNIT READY OPERATION CODE

The SATL shall:

- 1) If the device was previously stopped through a START STOP UNIT command (see 9.11), then the SATL shall terminate the TEST UNIT READY command with CHECK CONDITION status with the sense key set to NOT READY and the additional sense code of LOGICAL UNIT NOT READY, INITIALIZING COMMAND REQUIRED;
- 2) If the device is being formatted (see 9.2), then the SATL shall terminate the TEST UNIT READY command with CHECK CONDITION status with the sense key set to NOT READY and the additional sense code set to LOGICAL UNIT NOT READY, FORMAT IN PROGRESS;
- 3) If the ATA device supports the removable media feature set, then the SATL shall issue a GET MEDIA STATUS command to the attached ATA device. If the device reports an error with the NM bit set to one, then the SATL shall terminate the TEST UNIT READY command with CHECK CONDITION status with the sense key set to NOT READY and the additional sense code of MEDIUM NOT PRESENT;
- 4) If an ATA command was previously issued to the ATA device and that command completed with an error with the DF bit in the status register set to one, then the SATL shall terminate the TEST UNIT READY command with CHECK CONDITION status with the sense key set to HARDWARE ERROR and the additional sense code of LOGICAL UNIT FAILURE;
- 5) If none of the previous conditions exist, then the SATL shall issue an ATA CHECK POWER MODE command;
- 6) If the ATA CHECK POWER MODE command completes with an error the SATL shall terminate the TEST UNIT READY command with CHECK CONDITIOIN status with the sense key set to NOT READY, and the additional sense code set to LOGICAL UNIT DOES NOT RESPOND TO SELECTION; and
- 7) If the ATA CHECK POWER MODE command completes without error, then the SATL shall complete the TEST UNIT READY command with GOOD status.

If any other condition exists that prevents the SATL from issuing commands to the ATA device, the SATL should terminate the command with CHECK CONDITION status with the sense key set to NOT READY with the additional sense code of LOGICAL UNIT NOT READY, CAUSE NOT REPORTABLE.

Sequence number: 1
Author: IBM[GPenokie]
Subject: Underline
Date: 2/16/2006 1:39:48 PM
T 8.11.1 TEST UNIT READY command overview

Status
rlsheffi Cancelled 6/15/2006 1:50:41 PM

Sequence number: 2
Author: IBM[GPenokie]
Subject: Oval
Date: 2/16/2006 8:27:04 AM
 Table 30 - 1st row

There is an extra period in the subclause reference.

Status
rlsheffi Completed 6/15/2006 1:51:26 PM

Sequence number: 3
Author: EDITOR[rlsheffi]
Subject: Rectangle
Date: 8/29/2006 3:59:44 PM
 8.11.2 TEST UNIT READY OPERATION CODE

DISCUSS FLAG (proposed resolution): Replace the entire subclause as follows:

"8.11.2 TEST UNIT READY command translation

The SATL processes the TEST UNIT READY command as follows:

- 1) If any condition exists that prevents the SATL from issuing commands to the ATA device, the SATL should terminate the TEST UNIT READY command with CHECK CONDITION status with the sense key set to NOT READY with the additional sense code of LOGICAL UNIT NOT READY, CAUSE NOT REPORTABLE;
- 2) If the device is in the stopped state as the result of processing a START STOP UNIT command (see 9.11), then the SATL shall terminate the TEST UNIT READY command with CHECK CONDITION status with the sense key set to NOT READY and the additional sense code of LOGICAL UNIT NOT READY, INITIALIZING COMMAND REQUIRED;
- 3) If the ATA device is performing a self-test in the foreground mode, the SATL shall terminate the command with CHECK CONDITION status, with the sense key set to NOT READY, and the additional sense code set to LOGICAL UNIT NOT READY, SELF-TEST IN PROGRESS;
- 4) If the SATL is processing a FORMAT UNIT command for the emulated device (see 9.2), then the SATL shall terminate the TEST UNIT READY command with CHECK CONDITION status with the sense key set to NOT READY and the additional sense code set to LOGICAL UNIT NOT READY, FORMAT IN PROGRESS;
- 5) If the ATA device supports the Removable Media feature set (i.e., ATA IDENTIFY DEVICE data word 82 bit 2 is set to one), then the SATL shall issue an ATA GET MEDIA STATUS command to the ATA device. If the ATA device completes the command with the NM bit set to one in the Error register, then the SATL shall terminate the TEST UNIT READY command with CHECK CONDITION status with the sense key set to NOT READY and the additional sense code of MEDIUM NOT PRESENT; and
- 6) If the ATA device completed the most recent ATA command with the DF bit set to one in the Status register, then the SATL shall terminate the TEST UNIT READY command with CHECK CONDITION status with the sense key set to HARDWARE ERROR and the additional sense code of LOGICAL UNIT FAILURE.

If none of the conditions defined in items 1 through 6 exist, then the SATL shall issue an ATA CHECK POWER MODE command to the ATA device, and:

- a) If the ATA CHECK POWER MODE command completes with an error, then the SATL shall terminate the TEST UNIT READY command with CHECK CONDITION status with the sense key set to NOT READY, and the additional sense code set to LOGICAL UNIT DOES NOT RESPOND TO SELECTION; or
- b) If the ATA CHECK POWER MODE command completes without error, then the SATL shall complete the TEST UNIT READY command with GOOD status.

Status
rlsheffi Completed 8/29/2006 4:00:07 PM

Sequence number: 4
Author: IBM[GPenokie]
Subject: Underline
Date: 2/16/2006 1:42:10 PM

8.11 TEST UNIT READY command

8.11.1 TEST UNIT READY command overview

The TEST UNIT READY command is used to determine whether the device is ready (see table 30).

Table 30 — TEST UNIT READY command CDB fields

Field	Description or reference
OPERATION CODE	8.11.2.
CONTROL	6.4

8.11.2 TEST UNIT READY OPERATION CODE

The SATL shall:

- 1) If the device was previously stopped through a START STOP UNIT command (see 9.11), then the SATL shall terminate the TEST UNIT READY command with CHECK CONDITION status with the sense key set to NOT READY and the additional sense code of LOGICAL UNIT NOT READY, INITIALIZING COMMAND REQUIRED;
- 2) If the device is being formatted (see 9.2), then the SATL shall terminate the TEST UNIT READY command with CHECK CONDITION status with the sense key set to NOT READY and the additional sense code set to LOGICAL UNIT NOT READY, FORMAT IN PROGRESS;
- 3) If the ATA device supports the removable media feature set, then the SATL shall issue a GET MEDIA STATUS command to the attached ATA device. If the device reports an error with the NM bit set to one, then the SATL shall terminate the TEST UNIT READY command with CHECK CONDITION status with the sense key set to NOT READY and the additional sense code of MEDIUM NOT PRESENT;
- 4) If an ATA command was previously issued to the ATA device and that command completed with an error with the DF bit in the status register set to one, then the SATL shall terminate the TEST UNIT READY command with CHECK CONDITION status with the sense key set to HARDWARE ERROR and the additional sense code of LOGICAL UNIT FAILURE;
- 5) If none of the previous conditions exist, then the SATL shall issue an ATA CHECK POWER MODE command;
- 6) If the ATA CHECK POWER MODE command completes with an error the SATL shall terminate the TEST UNIT READY command with CHECK CONDITIOIN status with the sense key set to NOT READY, and the additional sense code set to LOGICAL UNIT DOES NOT RESPOND TO SELECTION; and
- 7) If the ATA CHECK POWER MODE command completes without error, then the SATL shall complete the TEST UNIT READY command with GOOD status.

If any other condition exists that prevents the SATL from issuing commands to the ATA device, the SATL should terminate the command with CHECK CONDITION status with the sense key set to NOT READY with the additional sense code of LOGICAL UNIT NOT READY, CAUSE NOT REPORTABLE.

T 8.11.2 TEST UNIT READY OPERATION CODE

Status

rlsheffi Cancelled 4/10/2006 1:43:21 PM

Sequence number: 5
Author: DELL[KMarks]
Subject: Highlight
Date: 4/27/2006 3:28:22 PM

T 8.11.2 TEST UNIT READY OPERATION CODE

change subclause title to
"8.11.2 TEST UNIT READYcommand translation"
RESOLUTION: See EDITOR's comment

Status

rlsheffi Completed 8/29/2006 4:00:26 PM

Sequence number: 6
Author: DELL[KMarks]
Subject: Highlight
Date: 8/28/2006 2:27:41 PM

T 8.11.2 TEST UNIT READY OPERATION CODE

1st paragraph
"The SATL shall:"

Reword or remove SATL shall from each of the numbered list entries below.
RESOLUTION: See EDITOR's comment

Status

rlsheffi Completed 8/29/2006 4:00:45 PM

Sequence number: 7
Author: MXO[MEvans]
Subject: Highlight
Date: 8/28/2006 2:30:36 PM

T 8.11.2 TEST UNIT READY OPERATION CODE, list item 1: change, "If the device was previously stopped through a START STOP UNIT command..." to, "If the device is in the stopped state as the result of receiving a START STOP UNIT command..."

RESOLUTION: See EDITOR's comment

Status

rlsheffi Completed 8/29/2006 4:00:58 PM

Sequence number: 8
Author: DELL[KMarks]
Subject: Highlight
Date: 8/28/2006 2:30:47 PM

T 8.11.2 TEST UNIT READY OPERATION CODE

2) in 1,2,..7 list
change
"2) If the device is being formatted ("
to
"2) If the device is emulating a formatted operation ("

And would the device be the SATL device? for 1) and 2)?
RESOLUTION: See EDITOR's comment

Status

rlsheffi Completed 8/29/2006 4:01:11 PM

Sequence number: 9
Author: DELL[KMarks]
Subject: Highlight
Date: 8/28/2006 2:31:34 PM

T 8.11.2 TEST UNIT READY OPERATION CODE

3) in 1,2,..7 list
change
"3) If the ATA device supports the removable media feature set, then the SATL shall issue a GET MEDIA STATUS command to the attached ATA device. If the device reports an error with the NM bit set to one, then the SATL shall terminate the TEST UNIT READY command with CHECK CONDITION status with the sense key set to NOT READY and the

8.11 TEST UNIT READY command

8.11.1 TEST UNIT READY command overview

The TEST UNIT READY command is used to determine whether the device is ready (see table 30).

Table 30 — TEST UNIT READY command CDB fields

Field	Description or reference
OPERATION CODE	8.11.2.
CONTROL	6.4

8.11.2 TEST UNIT READY OPERATION CODE

The SATL shall:

- 1) If the device was previously stopped through a START STOP UNIT command (see 9.11), then the SATL shall terminate the TEST UNIT READY command with CHECK CONDITION status with the sense key set to NOT READY and the additional sense code of LOGICAL UNIT NOT READY, INITIALIZING COMMAND REQUIRED;
- 2) If the device is being formatted (see 9.2), then the SATL shall terminate the TEST UNIT READY command with CHECK CONDITION status with the sense key set to NOT READY and the additional sense code set to LOGICAL UNIT NOT READY, FORMAT IN PROGRESS;
- 3) If the ATA device supports the ¹⁰movable media feature set, then the SATL shall issue a GET MEDIA STATUS command to the attached ATA device. If the device reports an error with the NM bit set to one, then the SATL shall terminate the TEST UNIT READY command with CHECK CONDITION status with the sense key set to NOT READY and the additional sense code of MEDIUM NOT PRESENT;
- 4) ¹¹If an ATA command was previously issued to the ATA device and that command completed with an error with the DF bit in the status register set to one, then the SATL shall terminate the TEST UNIT READY command with CHECK CONDITION status with the sense key set to HARDWARE ERROR and the additional sense code of LOGICAL UNIT FAILURE; ¹²
- 5) ¹³If none of the previous conditions exist, then the SATL shall issue an ATA CHECK POWER MODE command;
- 6) If the ATA CHECK POWER MODE command completes with an error the SATL shall terminate the TEST UNIT READY command with ¹⁴CHECK CONDITIOIN status with the sense key set to NOT READY, and the additional sense code set to LOGICAL UNIT DOES NOT RESPOND TO SELECTION; and
- 7) If the ATA CHECK POWER MODE command completes without error, then the SATL shall complete the TEST UNIT READY command with GOOD status.

If any other condition exists that prevents the SATL from issuing commands to the ATA device, the SATL should terminate the command with CHECK CONDITION status with the sense key set to NOT READY with the additional sense code of LOGICAL UNIT NOT READY, CAUSE NOT REPORTABLE.

additional sense code of MEDIUM NOT PRESENT;"

to

"3) If the ATA device supports the Removable Media feature set (ATA IDENTIFY DEVICE data word 82 bit 2 is set to one), then the SATL shall issue an ATA GET MEDIA STATUS command to the ATA device. If the ATA device completes the command with the NM bit set to one in the Error register, then the SATL shall terminate the TEST UNIT READY command with CHECK CONDITION status with the sense key set to NOT READY and the additional sense code of MEDIUM NOT PRESENT;"

RESOLUTION: See EDITOR's comment

Status
risheffi Completed 8/29/2006 4:01:27 PM

Sequence number: 10
Author: HPQ[RElliott]
Date: 8/28/2006 2:32:00 PM

 8.11.2

removable media s/b
Removeable Media
RESOLUTION:
s/b "Removable Media" See EDITOR's comment

Status
risheffi Completed 8/29/2006 4:01:51 PM

Sequence number: 11
Author: MXO[MEvans]
Subject: Highlight
Date: 8/28/2006 2:32:54 PM

 8.11.2 TEST UNIT READY OPERATION CODE, list item 1: change, "If an ATA command was previously issued to the ATA device and that command completed with an error with the DF bit in the status register set to one..." to, "If the device completed the most recent ATA command with the DF bit set to one in the Status register...".

RESOLUTION: See EDITOR's comment

Status
risheffi Completed 8/29/2006 4:02:02 PM

Sequence number: 12
Author: LSI[OParry]
Subject: Note
Date: 4/27/2006 3:07:31 PM
 8.11.2 TEST UNIT READY operation code
(general)

Following along the lines of item 4, perhaps there should be a general comment that all IO's received after a command completes with the DF bit set in the status register should be failed with CHECK CONDITION / HARDWARE FAILURE / LOGICAL UNIT FAILURE

REASON: This is (should be) covered in clause 11. See EDITOR's comment on the DF bit in clause 11.

Status
risheffi Rejected 4/27/2006 2:55:35 PM

Sequence number: 13
Author: IBM[GPenokie]
Subject: Comment on Text
Date: 8/28/2006 2:33:46 PM

 Item 5
This << If none of the previous conditions exist, then the SATL shall issue an ATA >> should be << If none of the conditions defined in items 1 through 4 do not exist, then the SATL shall issue an ATA >>

RESOLUTION: See EDITOR's comment

Status
risheffi Completed 8/29/2006 4:02:28 PM

Sequence number: 14
Author: INTC[RSheffield]
Subject: Highlight
Date: 8/28/2006 2:34:06 PM

 s/b
CHECK CONDITION

Comments from page 62 continued on next page

8.11 TEST UNIT READY command

8.11.1 TEST UNIT READY command overview

The TEST UNIT READY command is used to determine whether the device is ready (see table 30).

Table 30 — TEST UNIT READY command CDB fields

Field	Description or reference
OPERATION CODE	8.11.2.
CONTROL	6.4

8.11.2 TEST UNIT READY OPERATION CODE

The SATL shall:

- 1) If the device was previously stopped through a START STOP UNIT command (see 9.11), then the SATL shall terminate the TEST UNIT READY command with CHECK CONDITION status with the sense key set to NOT READY and the additional sense code of LOGICAL UNIT NOT READY, INITIALIZING COMMAND REQUIRED;
- 2) If the device is being formatted (see 9.2), then the SATL shall terminate the TEST UNIT READY command with CHECK CONDITION status with the sense key set to NOT READY and the additional sense code set to LOGICAL UNIT NOT READY, FORMAT IN PROGRESS;
- 3) If the ATA device supports the removable media feature set, then the SATL shall issue a GET MEDIA STATUS command to the attached ATA device. If the device reports an error with the NM bit set to one, then the SATL shall terminate the TEST UNIT READY command with CHECK CONDITION status with the sense key set to NOT READY and the additional sense code of MEDIUM NOT PRESENT;
- 4) If an ATA command was previously issued to the ATA device and that command completed with an error with the DF bit in the status register set to one, then the SATL shall terminate the TEST UNIT READY command with CHECK CONDITION status with the sense key set to HARDWARE ERROR and the additional sense code of LOGICAL UNIT FAILURE;
- 5) If none of the previous conditions exist, then the SATL shall issue an ATA CHECK POWER MODE command;
- 6) If the ATA CHECK POWER MODE command completes with an error the SATL shall terminate the TEST UNIT READY command with CHECK CONDITIOIN status with the sense key set to NOT READY, and the additional sense code set to LOGICAL UNIT DOES NOT RESPOND TO SELECTION; and
- 15) If the ATA CHECK POWER MODE command completes without error, then the SATL shall complete the TEST UNIT READY command with GOOD status.

If any other condition exists that prevents the SATL from issuing commands to the ATA device, the SATL should 16) terminate the command with CHECK CONDITION status with the sense key set to NOT READY with the additional sense code of LOGICAL UNIT NOT READY, CAUSE NOT REPORTABLE.

RESOLUTION: See EDITOR's comment

Status
rlsheffi Completed 8/29/2006 4:02:49 PM

Sequence number: 15
Author: DELL[KMarks]
Subject: Highlight
Date: 4/27/2006 3:11:08 PM

T 8.11.2 TEST UNIT READY OPERATION CODE
7) in 1,2,..7 list
change

"7) If the ATA CHECK POWER MODE command completes without error, then the SATL shall complete the TEST UNIT READY command with GOOD status."
to

"7) If the ATA CHECK POWER MODE command completes with no error, then the SATL shall complete the TEST UNIT READY command with GOOD status."
REASON: Editor is adopting the convention of "without error" instead of "with no error".

Status
rlsheffi Rejected 4/27/2006 3:10:38 PM

Sequence number: 16
Author: DELL[KMarks]
Subject: Highlight
Date: 8/28/2006 2:34:49 PM

T 8.11.2 TEST UNIT READY OPERATION CODE
2nd Paragraph, 1st Sentence
change

"terminate the command"

to

"terminate the TEST UNIT READY command"

RESOLUTION: See EDITOR's comment

Status
rlsheffi Completed 8/29/2006 4:03:09 PM

8.12 WRITE BUFFER command

12.1 WRITE BUFFER command overview

The WRITE BUFFER command is used with the read buffer command to determine the integrity of the target device's buffer memory and the physical interconnect that connects the target device and the initiator.

Table 31 — WRITE BUFFER command CDB fields

Field	Description or reference
OPERATION CODE	The SATL shall issue either an ATA WRITE BUFFER command or an ATA DOWNLOAD MICROCODE command to the attached ATA device, depending on the setting of MODE.
MODE	8.12.2
BUFFER ID ^a	Unspecified (see 3.4.3)
BUFFER OFFSET	Refers to the offset in the buffer to start reading data from. The BUFFER OFFSET should be less than the size of the buffer, otherwise a CHECK CONDITION shall be sent back with sense key set to ILLEGAL REQUEST and additional sense code set to INVALID FIELD IN CDB. This applies to modes 06h and 07h.
PARAMETER LIST LENGTH	Refer to individual sections for the meaning of this term.
CONTROL	6.4
^a The logical sector buffer in a ATA device shall be used to emulate the WRITE BUFFER command, therefore the size of the buffer is limited to 512 bytes for data buffer and echo buffers.	

8.12.2 MODE field

The MODE field specifies the function to be performed by the SATL. If the MODE is 02h, the SATL shall issue an ATA WRITE BUFFER command to the attached ATA device. If the MODE is 05h, 6h, or 07h, the SATL shall issue a DOWNLOAD MICROCODE command to the attached ATA device as specified in table 32.

Table 32 — MODE field

Code	Translated ATA Opcode
02h (i.e., Write data)	Translated to ATA WRITE BUFFER command (see 8.12.3).
05h (i.e., Download microcode and save)	Translated to the ATA DOWNLOAD MICROCODE command. The features register shall be set to 07h indicating downloaded microcode is saved for immediate and future use (see 8.12.4).
All others ^a	Unspecified (see 3.4.3)
^a This standard does not define other download microcode modes because ATA devices generally support only modes that save the downloaded code image, and because the SATL has no means to determine the size of the microcode image to support offset modes. Application clients may use the ATA PASS THROUGH command (see 12.2) to access ATA MICROCODE DOWNLOAD commands not referenced in this standard.	

Sequence number: 1
Author: IBM[GPenokie]
Subject: Underline
Date: 2/16/2006 1:39:59 PM
T 8.12.1 WRITE BUFFER command overview

Status
rsheffi Cancelled 6/15/2006 1:55:00 PM

Sequence number: 2
Author: DELL[KMarks]
Subject: Highlight
Date: 4/19/2006 9:22:43 PM
T 8.12.1 WRITE BUFFER command overview
1st Paragraph

"The WRITE BUFFER command is used with the read buffer command to determine the integrity of the target device's buffer memory and the physical interconnect that connects the target device and the initiator. "

to

"The WRITE BUFFER command is used with the read buffer command to determine the integrity of the buffer memory in target device and the physical interconnect that connects the target and initiator device.

Table 31 shows the translation for fields specified in the WRITE BUFFER CDB."

RESOLUTION: See MXO comment

Status
rsheffi Completed 6/15/2006 1:57:41 PM

Sequence number: 3
Author: MXO[MEvans]
Subject: Highlight
Date: 4/19/2006 9:24:23 PM
T 8.12.1 WRITE BUFFER command overview, first paragraph: change to, "The WRITE BUFFER command (see SPC-3) is used in conjunction with the READ BUFFER command as a diagnostic function for testing logical unit memory in the SCSI target device and the integrity of the service delivery subsystem. An additional mode is provided for downloading and saving microcode."
RESOLUTION: As suggested, with the additional sentence in a new paragraph that follows:
"Table 31 shows the translation for fields specified in the WRITE BUFFER CDB."

Status
rsheffi Completed 6/15/2006 1:57:14 PM

Sequence number: 4
Author: IBM[GPenokie]
Subject: Highlight
Date: 2/16/2006 9:09:20 AM
T There is no reference to table 31. This needs to be fixed as all tables have to be referenced.

Status
rsheffi Completed 6/15/2006 1:57:55 PM

Sequence number: 5
Author: HPQ[RElliott]
Date: 2/3/2006 7:52:01 AM
 8.12.1

need a reference to table 31

Status
rsheffi Completed 6/15/2006 1:58:02 PM

Sequence number: 6
Author: DELL[KMarks]
Subject: Highlight
Date: 6/15/2006 1:59:25 PM

8.12 WRITE BUFFER command

8.12.1 WRITE BUFFER command overview

The WRITE BUFFER command is used with the read buffer command to determine the integrity of the target device's buffer memory and the physical interconnect that connects the target device and the initiator.

Table 31 — WRITE BUFFER command CDB fields

Field	Description or reference
OPERATION CODE	The SATL shall issue either an ATA WRITE BUFFER command or an ATA DOWNLOAD MICROCODE command to the attached ATA device, depending on the setting of MODE.
MODE	8.12.2
BUFFER ID ^a	Unspecified (see 3.4.3)
BUFFER OFFSET	Refers to the offset in the buffer to start reading data from. The BUFFER OFFSET should be less than the size of the buffer, otherwise a CHECK CONDITION shall be sent back with sense key set to ILLEGAL REQUEST and additional sense code set to INVALID FIELD IN CDB. This applies to modes 06h and 07h.
PARAMETER LIST LENGTH	Refer to individual sections for the meaning of this term.
CONTROL	6.4
^a The logical sector buffer in a ATA device shall be used to emulate the WRITE BUFFER command, therefore the size of the buffer is limited to 512 bytes for data buffer and echo buffers.	

8.12.2 MODE field

The MODE field specifies the function to be performed by the SATL. If the MODE is 02h, the SATL shall issue an ATA WRITE BUFFER command to the attached ATA device. If the MODE is 05h, 6h, or 07h, the SATL shall issue a DOWNLOAD MICROCODE command to the attached ATA device as specified in table 32.

Table 32 — MODE field

Code	Translated ATA Opcode
02h (i.e., Write data)	Translated to ATA WRITE BUFFER command (see 8.12.3).
05h (i.e., Download microcode and save)	Translated to the ATA DOWNLOAD MICROCODE command. The features register shall be set to 07h indicating downloaded microcode is saved for immediate and future use (see 8.12.4).
All others ^a	Unspecified (see 3.4.3)
^a This standard does not define other download microcode modes because ATA devices generally support only modes that save the downloaded code image, and because the SATL has no means to determine the size of the microcode image to support offset modes. Application clients may use the ATA PASS THROUGH command (see 12.2) to access ATA MICROCODE DOWNLOAD commands not referenced in this standard.	

T Table 31 — WRITE BUFFER command CDB fields

Row: OPERATION CODE

1st Sentence

"The SATL shall issue either an ATA WRITE BUFFER command or an ATA DOWNLOAD MICROCODE command to the attached ATA device, depending on the setting of MODE."

to

"The SATL shall issue either an ATA WRITE BUFFER command or an ATA DOWNLOAD MICROCODE command to the ATA device, depending on the value in the MODE field in the WRITE BUFFER CDB."

RESOLUTION:

"The SATL shall:

- a) issue an ATA WRITE BUFFER command to the ATA device;
- b) issue an ATA DOWNLOAD MICROCODE command to the ATA device; or
- c) emulate the specified function (i.e., if supported);

depending on the values in the BUFFER ID field and MODE field (see 8.12.2)."

Status

risheffi Completed 6/15/2006 2:03:14 PM

Sequence number: 7

Author: EDITOR[risheffi]

Subject: Highlight

Date: 8/28/2006 2:45:38 PM

T 8.12.1 WRITE BUFFER command overview

Table 22 — WRITE BUFFER command CDB fields

Row: BUFFER ID

RESOLUTION: Change the text in the description or reference column to:

"If the the BUFFER ID field is set to 00h then the SATL shall transfer data to the buffer in the ATA device, download microcode to the ATA device, or emulate the specified WRITE BUFFER function depending on the value set in the MODE field (see 8.12.2). If the the BUFFER ID field is set to a value other than 00h then the translation is unspecified (see 3.4.3), and the SATL shall process the WRITE BUFFER command as defined in SPC-3."

Status

risheffi Completed 8/29/2006 4:14:06 PM

Sequence number: 8

Author: DELL[KMarks]

Subject: Highlight

Date: 4/20/2006 7:22:27 PM

T Table 31 — WRITE BUFFER command CDB fields

Row: BUFFER ID

1st Sentence

"Refers to the offset in the buffer to start reading data from. The BUFFER OFFSET should be less than the size of the buffer, otherwise a CHECK CONDITION shall be sent back with sense key set to ILLEGAL REQUEST and additional sense code set to INVALID FIELD IN CDB.
This applies to modes 06h and 07h."

to

"This value refers to the offset in the buffer specified by the BUFFER ID field to start writing data to. The BUFFER OFFSET field should be less than the size of the buffer, otherwise a CHECK CONDITION status shall be returned with sense key set to ILLEGAL REQUEST and additional sense code set to INVALID FIELD IN CDB."

Wondering about the should ..., then shall ...

Also wondering why it refers to 06h and 07h modes, when they are not specified in this section?

REASON: Accepted MXO comment instead (see). Implications of the BUFFER OFFSET field will be covered in 8.12.2.

Status

risheffi Completed 6/15/2006 2:07:16 PM

Sequence number: 9

Author: MXO[MEvans]

Subject: Highlight

Date: 2/16/2006 11:24:24 AM

8.12 WRITE BUFFER command

8.12.1 WRITE BUFFER command overview

The WRITE BUFFER command is used with the read buffer command to determine the integrity of the target device's buffer memory and the physical interconnect that connects the target device and the initiator.

Table 31 — WRITE BUFFER command CDB fields

Field	Description or reference
OPERATION CODE	The SATL shall issue either an ATA WRITE BUFFER command or an ATA DOWNLOAD MICROCODE command to the attached ATA device, depending on the setting of MODE.
MODE	8.12.2
BUFFER ID ^a	Unspecified (see 3.4.3)
BUFFER OFFSET	¹⁰ refers to the offset in the buffer to start reading data from. The BUFFER OFFSET should be less than the size of the buffer, otherwise a CHECK CONDITION shall be sent back with sense key set to ILLEGAL REQUEST and additional sense code set to INVALID FIELD IN CDB. This applies to modes 06h and 07h.
PARAMETER LIST LENGTH	¹³ refer to individual sections for the meaning of this term.
CONTROL	6.4
¹⁴ The logical sector buffer in a ATA device shall be used to emulate the WRITE BUFFER command, therefore the size of the buffer is limited to 512 bytes for data buffer and echo buffers.	

8.12.2 MODE field

The MODE field specifies the function to be performed by the SATL. If the MODE is 02h, the SATL shall issue an ATA WRITE BUFFER command to the attached ATA device. If the MODE is 05h, 6h, or 07h, the SATL shall issue a DOWNLOAD MICROCODE command to the attached ATA device as specified in table 32.

Table 32 — MODE field

Code	Translated ATA Opcode
02h (i.e., Write data)	Translated to ATA WRITE BUFFER command (see 8.12.3).
05h (i.e., Download microcode and save)	Translated to the ATA DOWNLOAD MICROCODE command. The features register shall be set to 07h indicating downloaded microcode is saved for immediate and future use (see 8.12.4).
All others ^a	Unspecified (see 3.4.3)
^a This standard does not define other download microcode modes because ATA devices generally support only modes that save the downloaded code image, and because the SATL has no means to determine the size of the microcode image to support offset modes. Application clients may use the ATA PASS THROUGH command (see 12.2) to access ATA MICROCODE DOWNLOAD commands not referenced in this standard.	

T Table 31, row 4, description: change to, "The meaning of this field depends on the contents of the MODE field (see 8.12.2)."

Status
rsheffi Completed 6/15/2006 2:07:08 PM

Sequence number: 10
Author: WDC[CStevens]
Subject: Comment on Text
Date: 6/15/2006 2:24:33 PM

T Limits are implied here due to the 512 byte size of ATA buffers.
RESOLUTION: Agreed - Error reporting for Data mode with the BUFFER ID field set to a value other than zero, or with the BUFFER ID field set to zero and the BUFFER OFFSET field set to a non-zero value or the PARAMETER LIST LENGTH field set to a value greater than 512 will be covered in subclause 8.12.2.2 (see - will replace subclause 8.12.3).

Status
rsheffi Completed 6/15/2006 2:24:56 PM

Sequence number: 11
Author: DELL[KMarks]
Subject: Highlight
Date: 4/20/2006 7:23:34 PM

T Table 22 — READ BUFFER command CDB fields
Row: PARAMETER LIST LENGTH

change

"Refer to individual sections for the meaning of this term."

to

"This value is dependent on the value in the MODE field (see 8.12.3 and 8.12.4)"

RESOLUTION: Accepted MXO comment (slight variation)

Status
rsheffi Completed 6/15/2006 2:26:38 PM

Sequence number: 12
Author: IBM[GPenokie]
Subject: Comment on Text
Date: 4/20/2006 7:30:17 PM

T table 31 2nd to last row

This << Refer to individual sections for the meaning of this term. >> should be << See x.x.x, x.x.x, and x.x.x. >>. In other words the actual references need to be listed.

RESOLUTION: See MXO comment (slight variation of this recommendation).

Status
rsheffi Completed 6/15/2006 2:26:38 PM

Sequence number: 13
Author: MXO[MEvans]
Subject: Highlight
Date: 2/16/2006 11:26:23 AM

T Table 31, row 5, description: change to, "The meaning of this field depends on the contents of the MODE field (see 8.12.2)."

Status
rsheffi Completed 6/15/2006 2:26:38 PM

Sequence number: 14
Author: DELL[KMarks]
Subject: Highlight
Date: 6/15/2006 2:27:43 PM

T Table 31 — WRITE BUFFER command CDB fields

Footnote a

"a The logical sector buffer in a ATA device shall be used to emulate the WRITE BUFFER command, therefore the size of the buffer is limited to 512 bytes for data buffer and echo buffers."

to

"a The logical sector buffer in a ATA device is used to emulate the WRITE BUFFER command, therefore the size of the buffer is limited to 512 bytes for data buffer and echo buffers."

Seems strange to have a shall in a table footnote.

RESOLUTION: Delete the footnote and describe the constraints for accessing the 512-byte sector buffer in the description of the Data mode in subclause 8.12.2.2

Status

Comments from page 63 continued on next page

8.12 WRITE BUFFER command

8.12.1 WRITE BUFFER command overview

The WRITE BUFFER command is used with the read buffer command to determine the integrity of the target device's buffer memory and the physical interconnect that connects the target device and the initiator.

Table 31 — WRITE BUFFER command CDB fields

Field	Description or reference
OPERATION CODE	The SATL shall issue either an ATA WRITE BUFFER command or an ATA DOWNLOAD MICROCODE command to the attached ATA device, depending on the setting of MODE.
MODE	8.12.2
BUFFER ID ^a	Unspecified (see 3.4.3)
BUFFER OFFSET	Refers to the offset in the buffer to start reading data from. The BUFFER OFFSET should be less than the size of the buffer, otherwise a CHECK CONDITION shall be sent back with sense key set to ILLEGAL REQUEST and additional sense code set to INVALID FIELD IN CDB. This applies to modes 06h and 07h.
PARAMETER LIST LENGTH	Refer to individual sections for the meaning of this term.
CONTROL	6.4
^a The logical sector buffer in a ATA device shall be used to emulate the WRITE BUFFER command, therefore the size of the buffer is limited to 512 bytes for data buffer and echo buffers.	

8.12.2 MODE field

The MODE field specifies the function to be performed by the SATL. If the MODE is 02h, the SATL shall issue an ATA WRITE BUFFER command to the attached ATA device. If the MODE is 05h, 6h, or 07h, the SATL shall issue a DOWNLOAD MICROCODE command to the attached ATA device as specified in table 32.

Table 32 — MODE field

Code	Translated ATA Opcode
02h (i.e., Write data)	Translated to ATA WRITE BUFFER command (see 8.12.3).
05h (i.e., Download microcode and save)	Translated to the ATA DOWNLOAD MICROCODE command. The features register shall be set to 07h indicating downloaded microcode is saved for immediate and future use (see 8.12.4).
All others ^a	Unspecified (see 3.4.3)
^a This standard does not define other download microcode modes because ATA devices generally support only modes that save the downloaded code image, and because the SATL has no means to determine the size of the microcode image to support offset modes. Application clients may use the ATA PASS THROUGH command (see 12.2) to access ATA MICROCODE DOWNLOAD commands not referenced in this standard.	

risheffi Completed 6/15/2006 2:29:42 PM

Sequence number: 15
Author: IBM[GPenokie]
Subject: Underline
Date: 2/16/2006 1:43:34 PM
T 8.12.2 MODE field

Status
risheffi Cancelled 4/20/2006 7:34:30 PM

Sequence number: 16
Author: DELL[KMarks]
Subject: Highlight
Date: 2/16/2006 3:41:59 PM

T 8.12.2 MODE field
1st paragraph

"The MODE field specifies the function to be performed by the SATL. If the MODE is 02h, the SATL shall issue an ATA WRITE BUFFER command to the attached ATA device. If the MODE is 05h, 6h, or 07h, the SATL shall issue a DOWNLOAD MICROCODE command to the attached ATA device as specified in table 32."

to

"The MODE field specifies the function to be performed by the SATL. If the MODE field is set to 02h, the SATL shall issue an ATA WRITE BUFFER command to the ATA device. If the MODE field is set to 05h the SATL shall issue a DOWNLOAD MICROCODE command to the ATA device as specified in table 32."

Since table 32 shows 06h, and 07h as unspecified, paragraph should not define a translation.

Status
risheffi Completed 6/15/2006 2:32:09 PM

Sequence number: 17
Author: IBM[GPenokie]
Subject: Comment on Text
Date: 4/20/2006 7:45:13 PM

T 1st paragraph

This << If the MODE is 05h, 6h, or 07h, the SATL shall >> should be << If the MODE is 05h, 06h, or 07h, the SATL shall >>
REASON: Accepted DELL comment instead (see), which discusses only mode values of 02h and 05h.

Status
risheffi Rejected 4/20/2006 7:42:17 PM

Sequence number: 18
Author: DELL[KMarks]
Subject: Highlight
Date: 4/20/2006 7:46:03 PM

T Table 32 — MODE field
2nd column title

change

"Translated ATA Opcode"

to

"Translated ATA command"

RESOLUTION:

s/b "Description or reference", for consistency with other tables.

Status
risheffi Completed 6/15/2006 2:32:44 PM

Sequence number: 19
Author: EDITOR[risheffi]
Subject: Highlight
Date: 4/20/2006 7:51:59 PM

T Table 32 — MODE field

Row: 05h (i.e., Download microcode and save)

Second column

"(see 8.12.4)" s/b "(see 8.12.2.2)". Demote subclause headings accordingly.

Comments from page 63 continued on next page

8.12 WRITE BUFFER command

8.12.1 WRITE BUFFER command overview

The WRITE BUFFER command is used with the read buffer command to determine the integrity of the target device's buffer memory and the physical interconnect that connects the target device and the initiator.

Table 31 — WRITE BUFFER command CDB fields

Field	Description or reference
OPERATION CODE	The SATL shall issue either an ATA WRITE BUFFER command or an ATA DOWNLOAD MICROCODE command to the attached ATA device, depending on the setting of MODE.
MODE	8.12.2
BUFFER ID ^a	Unspecified (see 3.4.3)
BUFFER OFFSET	Refers to the offset in the buffer to start reading data from. The BUFFER OFFSET should be less than the size of the buffer, otherwise a CHECK CONDITION shall be sent back with sense key set to ILLEGAL REQUEST and additional sense code set to INVALID FIELD IN CDB. This applies to modes 06h and 07h.
PARAMETER LIST LENGTH	Refer to individual sections for the meaning of this term.
CONTROL	6.4
^a The logical sector buffer in a ATA device shall be used to emulate the WRITE BUFFER command, therefore the size of the buffer is limited to 512 bytes for data buffer and echo buffers.	

8.12.2 MODE field

The MODE field specifies the function to be performed by the SATL. If the MODE is 02h, the SATL shall issue an ATA WRITE BUFFER command to the attached ATA device. If the MODE is 05h, 6h, or 07h, the SATL shall issue a DOWNLOAD MICROCODE command to the attached ATA device as specified in table 32.

Table 32 — MODE field

Code	Translated ATA Opcode
02h (i.e., Write data)	Translated to ATA WRITE BUFFER command (see 8.12.3).
05h (i.e., Download microcode and save)	Translated to the ATA DOWNLOAD MICROCODE command. The features register shall be set to 07h indicating downloaded microcode is saved for immediate and future use (see 8.12.4).
All others ^a	Unspecified (see 3.4.3)
^a 21 is standard does not define other download microcode modes because ATA devices generally support only modes that save the downloaded code image, and because the SATL has no means to determine the size of the microcode image to support offset modes. 23 Application clients may use the ATA PASS THROUGH command (see 12.2) to access ATA MICROCODE DOWNLOAD commands not referenced in this standard.	

Status
risheffi Completed 6/15/2006 2:34:53 PM

Sequence number: 20
Author: EDITOR[risheffi]
Subject: Highlight
Date: 6/15/2006 2:35:27 PM

T Table 32 — MODE field
Row: 02h (i.e., Write data)

Second column
"(see 8.12.3)" s/b "(see 8.12.2.3)". Demote subclause headings accordingly.

Status
risheffi Completed 6/15/2006 2:35:56 PM

Sequence number: 21
Author: IBM[GPenokie]
Subject: Cross-Out
Date: 2/16/2006 9:19:57 AM

T table 32 footnote

This << This standard does not define other download microcode modes because ATA devices generally support only modes that save the downloaded code image, and because the SATL has no means to determine the size of the microcode image to support offset modes. >> should be deleted as there is no value or need to justify the actions defined by the standard.

Status
risheffi Completed 6/15/2006 2:42:44 PM

Sequence number: 22
Author: MXO[MEvans]
Subject: Highlight
Date: 4/20/2006 7:58:27 PM

T Table 32, footnote: change "...generally support only..." to "...may only support...".
RESOLUTION: The first sentence of the table footnote is deleted per IBM comment (see).

Status
risheffi Completed 6/15/2006 2:42:54 PM

Sequence number: 23
Author: EDITOR[risheffi]
Subject: Cross-Out
Date: 5/23/2006 9:58:40 AM

T This is informational and not necessary. Rob Elliott [HPQ] recommends removing it.

Status
risheffi Completed 6/15/2006 2:43:03 PM

12.3 Data Only mode (02h)

4 this mode, data is written to the device's logical sector buffer. Note that the logical sector buffer in the ATA device is being used to emulate the SCSI WRITE BUFFER command, so the maximum length of data that can be written is 512 bytes.

When the MODE field is set to 02h, the BUFFER ID field, the BUFFER OFFSET field, and the PARAMETER LIST LENGTH field are valid. If the values of these fields do not meet any of the conditions shown in table 33, then the SATL shall terminate the command with CHECK CONDITION status with the sense key set to ILLEGAL REQUEST with the additional sense code set to INVALID FIELD IN CDB.

Table 33 — Constraints for fields in the WRITE BUFFER command CDB

Field	Constraint
BUFFER ID	Should be set to zero
BUFFER OFFSET	Should be less than or equal to 512
PARAMETER LIST LENGTH	Should be less than or equal to 512

8.12.4 Download microcode mode (5h)

In this mode, data transferred from the application client is transmitted to the device using the ATA DOWNLOAD MICROCODE command.

The SATL shall issue an ATA DOWNLOAD MICROCODE command when it receives a WRITE BUFFER command specifying mode 05h. The SATL shall transfer the microcode image or control information from the application client to the attached ATA device, and then complete the WRITE BUFFER command with GOOD status. The SATL shall check the attached ATA device for any returned errors, or confirmation that the ATA DOWNLOAD MICROCODE command has completed. If the ATA DOWNLOAD MICROCODE command terminates with an error returned, the SATL shall generate a unit attention condition and return a deferred error (see SPC-3).

After the attached ATA device reinitializes successfully, running the new microcode image, the SATL shall generate a unit attention condition (see SAM-3) for the initiator port associated with all I_T nexuses except the I_T nexus on which the set of WRITE BUFFER commands was received, with the additional sense code set to MICROCODE HAS BEEN CHANGED

Sequence number: 1
Author: HPQ[WBellamy]
Subject: Note
Date: 4/20/2006 7:59:41 PM

 Remove the (02h) here, and add it to the text below identifying this code.
RESOLUTION: Remove (02h), but it is not added to the text below because table 32 identifies the association.

Status
rlsheffi Completed 6/15/2006 2:43:17 PM

Sequence number: 2
Author: IBM[GPenokie]
Subject: Underline
Date: 2/16/2006 1:30:02 PM
T 8.12.3 Data Only mode (02h)

Status
rlsheffi Cancelled 4/20/2006 7:59:56 PM

Sequence number: 3
Author: DELL[KMarks]
Subject: Highlight
Date: 6/15/2006 2:12:07 PM
T 8.12.3 Data Only mode (02h)

change subclause title to
"8.12.3 Write data mode (02h)"
RESOLUTION: s/b "8.12.2.2 Write data mode"

Status
rlsheffi Completed 6/15/2006 2:12:10 PM

Sequence number: 4
Author: DELL[KMarks]
Subject: Highlight
Date: 4/24/2006 2:42:18 PM
T 8.12.3 Data Only mode (02h)

1st Paragraph

change

"In this mode, data is written to the device's logical sector buffer. Note that the logical sector buffer in the ATA device is being used to emulate the SCSI WRITE BUFFER command, so the maximum length of data that can be written is 512 bytes."

to

"In this mode, data is written to the logical sector buffer of the device. The logical sector buffer in the ATA device is being used to emulate the WRITE BUFFER command, so the maximum length of data that may be written is 512 bytes."

RESOLUTION:

"If:

- a) the BUFFER ID field is set to 00h;
- b) the BUFFER OFFSET field is set to 00h; and
- c) the PARAMETER LIST LENGTH field is set to 512;

then the SATL shall write the specified number of bytes to the buffer in the ATA device by sending an ATA WRITE BUFFER command to the ATA device.

If the BUFFER ID field is set to 00h and either:

- a) the BUFFER OFFSET field is set to a value other than 00h; or
- b) the PARAMETER LIST LENGTH field is set to a value other than 512;

then the SATL shall terminate the command with CHECK CONDITION status with the sense key set to ILLEGAL REQUEST with the additional sense code set to INVALID FIELD IN CDB.

The SATL may support a value other than 00h in the BUFFER ID field. If the SATL supports a value other than 00h in the BUFFER ID field the implementation shall be as defined in SPC-3."

Status
rlsheffi Completed 6/15/2006 2:17:09 PM

8.12.3 Data Only mode (02h)

In this mode, data is written to the device's logical sector buffer. Note that the logical sector buffer in the ATA device is being used to emulate the SCSI WRITE BUFFER command, so the maximum length of data that can be written is 512 bytes.

When the MODE field is set to 02h, the BUFFER ID field, the BUFFER OFFSET field, and the PARAMETER LIST LENGTH field are valid. If the values of these fields do not meet any of the conditions shown in table 33, then the SATL shall terminate the command with CHECK CONDITION status with the sense key set to ILLEGAL REQUEST with the additional sense code set to INVALID FIELD IN CDB.

Table 33 — Constraints for fields in the WRITE BUFFER command CDB

Field	Constraint
BUFFER ID	Should be set to zero
BUFFER OFFSET	Should be less than or equal to 512
PARAMETER LIST LENGTH	Should be less than or equal to 512

8.12.4 Download microcode mode (5h)

In this mode, data transferred from the application client is transmitted to the device using the ATA DOWNLOAD MICROCODE command.

The SATL shall issue an ATA DOWNLOAD MICROCODE command when it receives a WRITE BUFFER command specifying mode 05h. The SATL shall transfer the microcode image or control information from the application client to the attached ATA device, and then complete the WRITE BUFFER command with GOOD status. The SATL shall check the attached ATA device for any returned errors, or confirmation that the ATA DOWNLOAD MICROCODE command has completed. If the ATA DOWNLOAD MICROCODE command terminates with an error returned, the SATL shall generate a unit attention condition and return a deferred error (see SPC-3).

After the attached ATA device reinitializes successfully, running the new microcode image, the SATL shall generate a unit attention condition (see SAM-3) for the initiator port associated with all I_T nexuses except the I_T nexus on which the set of WRITE BUFFER commands was received, with the additional sense code set to MICROCODE HAS BEEN CHANGED

Sequence number: 5
Author: IBM[GPenokie]
Subject: Highlight
Date: 4/23/2006 12:16:34 PM

T 1st paragraph

This << Note that logical sector buffer in the ATA device is being used to emulate the SCSI WRITE BUFFER command, so the maximum length of data that can be written is 512 bytes. >> should either made into a real note or changed to << The logical sector buffer in the ATA device is being used to emulate the SCSI WRITE BUFFER command, so the maximum length of data that is allowed to be written is 512 bytes. >> but in either case the evil << can >> needs to be removed.
RESOLUTION: See DELL comment.

Status
risheffi Completed 6/15/2006 2:17:28 PM

Sequence number: 6
Author: MXO[MEvans]
Subject: Highlight
Date: 4/23/2006 12:17:31 PM

T 8.12.3 Data only mode: change "can" to "may".
RESOLUTION: See DELL comment

Status
risheffi Completed 6/15/2006 2:17:45 PM

Sequence number: 7
Author: SIERLGC[BMartin]
Subject: Highlight
Date: 4/23/2006 12:17:47 PM

T Page 44, 8.12.3, first paragraph last sentence
"can" s.b. "may"
RESOLUTION: See DELL comment

Status
risheffi Completed 6/15/2006 2:17:54 PM

Sequence number: 8
Author: EDITOR[risheffi]
Subject: Rectangle
Date: 4/24/2006 2:46:12 PM

Table 33 — Constraints for fields in the WRITE BUFFER command CDB
Delete everything in this box (second paragraph and table-33)

Status
risheffi Completed 6/15/2006 2:21:42 PM

Sequence number: 9
Author: DELL[KMarks]
Subject: Note
Date: 6/15/2006 2:19:02 PM

8.12.3 Data Only mode (02h)
2nd Paragraph

Paragraph says 'shall' terminate command, when fields do not meet conditions in Table 33, which says Buffer ID should be set to zero (which should be 00h). , but Buffer ID is unspecified above.

RESOLUTION: See EDITOR's comment. The definition of the BUFFER ID field above is being modified to provide the SAT-defined behavior when the value is zero, and to refer to SPC-3 when the value is not zero. Delete this paragraph and Table-33.

Status
risheffi Completed 6/15/2006 2:21:33 PM

Sequence number: 10
Author: DELL[KMarks]
Subject: Highlight
Date: 4/24/2006 2:50:16 PM

Table 33 — Constraints for fields in the WRITE BUFFER command CDB
Row: BUFFER ID
change
"zero"
to

Comments from page 64 continued on next page

8.12.3 Data Only mode (02h)

In this mode, data is written to the device's logical sector buffer. Note that the logical sector buffer in the ATA device is being used to emulate the SCSI WRITE BUFFER command, so the maximum length of data that can be written is 512 bytes.

When the MODE field is set to 02h, the BUFFER ID field, the BUFFER OFFSET field, and the PARAMETER LIST LENGTH field are valid. If the values of these fields do not meet any of the conditions shown in table 33, then the SATL shall terminate the command with CHECK CONDITION status with the sense key set to ILLEGAL REQUEST with the additional sense code set to INVALID FIELD IN CDB.

Table 33 — Constraints for fields in the WRITE BUFFER command CDB

Field	Constraint
BUFFER ID	Should be set to zero
BUFFER OFFSET	Should be less than or equal to 512
PARAMETER LIST LENGTH	Should be less than or equal to 512

8.12.4 Download microcode mode (5h)

In this mode, data is transferred from the application client is transmitted to the device using the ATA DOWNLOAD MICROCODE command.

The SATL shall issue an ATA DOWNLOAD MICROCODE command when it receives a WRITE BUFFER command specifying mode 05h. The SATL shall transfer the microcode image or control information from the application client to the attached ATA device, and then complete the WRITE BUFFER command with GOOD status. The SATL shall check the attached ATA device for any returned errors, or confirmation that the ATA DOWNLOAD MICROCODE command has completed. If the ATA DOWNLOAD MICROCODE command terminates with an error returned, the SATL shall generate a unit attention condition and return a deferred error (see SPC-3).

After the attached ATA device reinitializes successfully, running the new microcode image, the SATL shall generate a unit attention condition (see SAM-3) for the initiator port associated with all I_T nexuses except the I_T nexus on which the set of WRITE BUFFER commands was received, with the additional sense code set to MICROCODE HAS BEEN CHANGED

"00h"

RESOLUTION: Delete table

Status
rlsheffi Completed 6/15/2006 2:21:03 PM

Sequence number: 11
Author: EDITOR[rlsheffi]
Subject: Highlight
Date: 4/24/2006 2:49:49 PM

T 8.12.3 Data Only mode (02h)
Table 33 — Constraints for fields in the WRITE BUFFER command CDB

Row: BUFFER OFFSET

Second column

"Should be less than or equal to 512"

s/b

"Should be set to zero"

RESOLUTION: Accept suggested change. When the mode for a READ BUFFER command specifies to return a Descriptor, a value of FFh returned in the OFFSET BOUNDARY field indicates the the device server only supports a value of zero in the BUFFER OFFSET field. The ATA READ BUFFER command provides no means to request data at an offset, so it is reasonable for the SATL to support only a value of zero in the BUFFER OFFSET field. This is captured in the resolution of the first paragraph of this subclause. This table is being deleted.

Status
rlsheffi Completed 6/15/2006 2:20:52 PM

Sequence number: 12
Author: HPQ[WBellamy]
Subject: Note
Date: 4/20/2006 8:26:03 PM

 Remove the (05h) here, and add it to the text below identifying this code.

RESOLUTION: Remove (05h), but it is not added to the text below because table 32 identifies the association.

Status
rlsheffi Completed 6/15/2006 2:44:42 PM

Sequence number: 13
Author: IBM[GPenokie]
Subject: Underline
Date: 2/16/2006 1:42:17 PM

T 8.12.4 Download microcode mode (5h)

Status
rlsheffi Cancelled 4/23/2006 12:56:35 PM

Sequence number: 14
Author: DELL[KMarks]
Subject: Highlight
Date: 6/15/2006 2:45:22 PM

T 8.12.4 Download microcode mode (5h)

Subclause title

change to

"8.12.4 Download microcode mode (05h)"

RESOLUTION: Accepted HP comment to delete (05h), and changing subclause heading to 8.12.2.3.

Status
rlsheffi Completed 6/15/2006 2:46:02 PM

Sequence number: 15
Author: DELL[KMarks]
Subject: Highlight
Date: 2/16/2006 3:50:02 PM

T 8.12.4 Download microcode mode (5h)

1st Paragraph

change

"In this mode, data is transferred from the application client is transmitted to the device using the ATA DOWNLOAD MICROCODE command."

to

8.12.3 Data Only mode (02h)

In this mode, data is written to the device's logical sector buffer. Note that the logical sector buffer in the ATA device is being used to emulate the SCSI WRITE BUFFER command, so the maximum length of data that can be written is 512 bytes.

When the MODE field is set to 02h, the BUFFER ID field, the BUFFER OFFSET field, and the PARAMETER LIST LENGTH field are valid. If the values of these fields do not meet any of the conditions shown in table 33, then the SATL shall terminate the command with CHECK CONDITION status with the sense key set to ILLEGAL REQUEST with the additional sense code set to INVALID FIELD IN CDB.

Table 33 — Constraints for fields in the WRITE BUFFER command CDB

Field	Constraint
BUFFER ID	Should be set to zero
BUFFER OFFSET	Should be less than or equal to 512
PARAMETER LIST LENGTH	Should be less than or equal to 512

8.12.4 Download microcode mode (5h)

In this mode, data transferred from the application client is transmitted to the device using the ATA DOWNLOAD MICROCODE command.

¹⁶ The SATL shall issue an ATA DOWNLOAD MICROCODE command when it receives a WRITE BUFFER command specifying mode 05h. The SATL shall transfer the microcode image or control information from the application client to the attached ATA device, and then complete the WRITE BUFFER command with GOOD status. The SATL shall check the attached ATA device for any returned errors, or confirmation that the ATA DOWNLOAD MICROCODE command has completed. If the ATA DOWNLOAD MICROCODE command terminates with an error returned, the SATL shall generate a unit attention condition and return a deferred error (see SPC-3).

After the attached ATA device reinitializes successfully, running the new microcode image, the SATL shall ¹⁷ generate a unit attention condition (see SAM-3) for the initiator port associated with all I_T nexuses except the I_T nexus on which the set of WRITE BUFFER commands was received, with the ¹⁸ additional sense code set to MICROCODE HAS BEEN CHANGED

"In this mode, data transferred to the SATL from the application client is transmitted to the ATA device using the ATA DOWNLOAD MICROCODE command."

Status
rlsheffi Completed 6/15/2006 2:47:23 PM

Sequence number: 16
Author: DELL[KMarks]
Subject: Highlight
Date: 6/15/2006 2:51:19 PM

T 8.12.4 Download microcode mode (5h)
2nd Paragraph
change

"The SATL shall issue an ATA DOWNLOAD MICROCODE command when it receives a WRITE BUFFER command specifying mode 05h. The SATL shall transfer the microcode image or control information from the application client to the attached ATA device, and then complete the WRITE BUFFER command with GOOD status. The SATL shall check the attached ATA device for any returned errors, or confirmation that the ATA DOWNLOAD MICROCODE command has completed. If the ATA DLOWNLOAD MICROCODE command terminates with an error returned, the SATL shall generate a unit attention condition and return a deferred error (see SPC-3)."

to

"The SATL shall issue an ATA DOWNLOAD MICROCODE command to the ATA device when it receives a WRITE BUFFER command with the MODE field set to 05h. The SATL shall transfer the microcode image or control information from the application client to the ATA device, and then complete the WRITE BUFFER command with GOOD status. The SATL shall check if the ATA DOWNLOAD MICROCODE command completed with an error. If the ATA DLOWNLOAD MICROCODE command completed with an error, the SATL shall generate a unit attention condition and return a deferred error (see SPC-3)."

What is ASC for the deferred error, or is this one where you follow clause 11.

RESOLUTION: Accept the suggested text, but change "generate a unit attention condition" to "establish a unit attention condition". The error code translation defined in clause 11 should apply. Change "(see SPC-3)" to "(see SPC-3 and clause 11)".

Status
rlsheffi Completed 6/15/2006 2:53:32 PM

Sequence number: 17
Author: DELL[KMarks]
Subject: Highlight
Date: 2/16/2006 3:55:52 PM

T 8.12.4 Download microcode mode (5h)
3rd paragraph, 1st Sentence
change
"generate"
to
"establish"

Status
rlsheffi Completed 6/15/2006 2:54:29 PM

Sequence number: 18
Author: IBM[GPenokie]
Subject: Comment on Text
Date: 2/16/2006 9:26:01 AM

T last paragraph - last sentence
This last sentence is missing a period.

Status
rlsheffi Completed 6/15/2006 2:55:00 PM

9 SCSI Block Commands (SBC) ¹ Mapping

9.1 Translating LBA and transfer length and ATA command use constraints

A SATL emulates SCSI logical blocks. The ⁴SCSI BLOCK LENGTH IN BYTES field in the READ CAPACITY data ³ (see 9.8.2 and 9.9.2) may not be equal to the Logical Sector Size of the ATA device ⁵ (see ATA/ATAPI-7).

NOTE 6 - The Logical Sector Size indicated by an ATA device is the number of words in a logical sector. The number of bytes in an ATA device logical sector is twice the value indicated in the Logical Sector Size.

The ATA commands the SATL may use to implement the functions specified by SCSI block commands depend upon:

- a) the value of the LOGICAL BLOCK ADDRESS and TRANSFER LENGTH fields specified in the SCSI CDB; and
- b) the capabilities of the ~~attached~~ ATA device and the ATA host within the SATL.

Sequence number: 1
Author: HPQ[RElliott]
Subject: Highlight
Date: 6/20/2006 5:05:29 PM

T⁹

Mapping s/b mapping
RESOLUTION: see 06-216

Status
risheffi Completed 6/15/2006 2:56:17 PM

Sequence number: 2
Author: IBM[GPenokie]
Subject: Underline
Date: 2/16/2006 1:39:26 PM

T9.1 Translating LBA and transfer length and ATA command use constraints

Status
risheffi Cancelled 4/24/2006 10:38:09 AM

Sequence number: 3
Author: EDITOR[risheffi]
Subject: Rectangle
Date: 5/11/2006 4:11:39 PM

 Replace the selected text with: "The logical block size indicated by the BLOCK LENGTH IN BYTES field in the READ CAPACITY data (see 9.8.2 and 9.9.2) may or may not be equal to the Logical Sector Size of the ATA device (see ATA/ATAPI-7) (e.g., SCSI logical block size of 520 bytes with an ATA Logical Sector Size of 512 bytes). The SATL translates between the SCSI LOGICAL BLOCK ADDRESS field and the ATA LBA in a vendor-specific manner, but so that the result of a logical block address translated in one direction and then translated in the reverse direction yields the original logical block address."

Modify every instance that specifies a direct translation to read, "The logical block address shall be used to set the ATA LBA (see 3.1.11) as defined in 9.1."

RESOLUTION: The resolution is documented in 06-216.

Status
risheffi Completed 7/23/2006 11:31:06 AM

Sequence number: 4
Author: DELL[KMarks]
Subject: Cross-Out
Date: 6/16/2006 9:57:54 AM

T9.1 Translating LBA and transfer length and ATA command use constraints

1st Paragraph, 2nd Sentence

remove

"SCSI"

from

"The SCSI BLOCK LENGTH IN..."

RESOLUTION: The resolution is documented in 06-216.

Status
risheffi Completed 7/23/2006 11:22:56 AM

Sequence number: 5
Author: EDITOR[risheffi]
Subject: Highlight
Date: 6/20/2006 5:10:56 PM

T9.1 Translating LBA and transfer length and ATA command use constraints

First sentence

change

"(see ATA/ATAPI-7)"

to

"(see ATA8-ACS)"

RESOLUTION: see 06-216

9 SCSI Block Commands (SBC) Mapping

9.1 Translating LBA and transfer length and ATA command use constraints

A SATL emulates SCSI logical blocks. The ~~SCSI~~ BLOCK LENGTH IN BYTES field in the READ CAPACITY data (see 9.8.2 and 9.9.2) may not be equal to the Logical Sector Size of the ATA device (see ATA/ATAPI-7).

NOTE 6 - The Logical Sector Size indicated by an ATA device is the number of words in a logical sector. The number of bytes in an ATA device logical sector is twice the value indicated in the Logical Sector Size.

The ATA commands the SATL may use to implement the functions specified by SCSI block commands depend upon:

- a) the value of the LOGICAL BLOCK ADDRESS and TRANSFER LENGTH fields specified in the SCSI CDB; and
- b) the capabilities of the ~~attached~~ ATA device and the ATA host within the SATL.

Status
rlsheffi Completed 6/16/2006 9:58:08 AM

Sequence number: 6
Author: HPQ[RElliott]
Date: 7/23/2006 11:25:24 AM

T9.1

Is the point of this "may not" statement that units of bytes are different from units of words? In that case, "are not" would be correct.

If the point is that the SATL might expose 4096 byte SCSI logical blocks based on 512 byte ATA logical sectors, then I think more discussion is warranted.

Note: I (the editor) believe the intent is that the SATL might expose 4096-byte SCSI logical blocks based on 512-byte ATA logical sectors, or the SATL might expose 512-byte SCSI logical blocks based on 4096-byte ATA logical sectors, or various other mappings (e.g., with protection information taking part of a 512-byte increment in ATA logical sector size, etc.). The spectrum of options seemed too broad to attempt to define them all, so the "may not" is intended to allow flexibility to accommodate a variety of options and avoid leaving the impression that SCSI logical block size must match ATA logical sector size.

RESOLUTION: Define direct and indirect block mapping - see 06-216

Status
rlsheffi Completed 7/23/2006 11:25:27 AM

Sequence number: 7
Author: SIERLGC[BMartin]
Subject: Highlight
Date: 7/23/2006 11:30:22 AM

TPage 45, NOTE 6

ATA/ATAPI-7 has a different definition for logical sector size. "number of logical sectors in a physical sector or if the logical sector is larger than a physical sector .."

re-phrase to "NOTE 6 - The Logical Sector Size indicated by an ATA device is represented in words; therefore, the number of bytes in an ATA device logical sector is twice the value indicated in the Logical Sector Size."

RESOLUTION: Clarified by defining new terms, revised note moved with the definition of "ATA logical sector size" in SAT-r08a - See 06-216

Status
rlsheffi Completed 7/23/2006 11:30:25 AM

Sequence number: 8
Author: DELL[KMarks]
Subject: Cross-Out
Date: 6/20/2006 5:12:10 PM

Tattached

RESOLUTION: see 06-216

Status
rlsheffi Completed 6/19/2006 5:51:47 AM

Table 34 relates selection conditions to allowable ATA commands used to implement SCSI block storage data transfer commands.

Table 34 — Read and write type command translation selection

Selection Prerequisites ^a					Allowed ATA commands ⁴
³ CSI CDB	² TA feature sets supported and enabled ^d				
(transfer length + LBA) ≤ 2 ²⁸	⁵ 8-bit Address ^b	DMA ^c	Overlap	SATA 2.5 NCQ	
n/a	n/a	n/a	n/a	n/a	FLUSH CACHE ^f FLUSH CACHE EXT ^g
yes ^{b, e}	n/a	n/a	n/a	n/a	READ MULTIPLE READ SECTOR(S) READ VERIFY SECTOR(S) WRITE MULTIPLE WRITE SECTOR(S)
yes ^{b, e}	n/a	yes	n/a	n/a	READ DMA WRITE DMA
yes ^{b, e}	n/a	yes	yes	n/a	READ DMA QUEUED WRITE DMA QUEUED
n/a	yes	yes	n/a	n/a	READ DMA EXT WRITE DMA EXT WRITE DMA FUA EXT
n/a	yes	yes	yes	n/a	READ DMA QUEUED EXT WRITE DMA QUEUED EXT WRITE DMA QUEUED FUA EXT
n/a	yes	n/a	n/a	n/a	READ MULTIPLE EXT READ SECTOR(S) EXT READ VERIFY SECTOR(S) EXT WRITE MULTIPLE EXT WRITE MULTIPLE FUA EXT WRITE SECTOR(S) EXT
n/a	n/a	n/a	n/a	yes	READ FPDMA QUEUED WRITE FPDMA QUEUED

^a An ATA command may be used to implement a SCSI block command only if all the prerequisites in the prerequisite columns for that command marked as yes are satisfied.

^b If the attached ATA device does not support the 48-bit Address feature set (see ATA/ATAPI-7) or NCQ (see SATA 2.5) and the SATL receives a request to access an LBA beyond (2²⁸-1), the SATL shall terminate the command with CHECK CONDITION status with the sense key set to ILLEGAL REQUEST and the sense code set to LOGICAL BLOCK ADDRESS OUT OF RANGE.

^c The DMA prerequisite requires both the ATA host in the SATL and the attached ATA device to have the same DMA transfer mode enabled (i.e., bit 8 of word 49 in the IDENTIFY DEVICE data is set to one and at least one DMA mode is enabled in word 63 or word 88 of the IDENTIFY DEVICE data).

^d See ATA/ATAPI-7.

^e The SATL may transfer the number of logical blocks requested in the TRANSFER LENGTH field by sending multiple ATA commands, each time incrementing the ATA LBA by the ATA Sector Count transferred.

^f ~~The FLUSH CACHE command may be used if ATA IDENTIFY DEVICE data indicates the command is supported in word 83 bit 12, and the command is enabled in word 86 bit 12 (see ATA/ATAPI 7).~~

^g ~~The FLUSH CACHE EXT command may be used if ATA IDENTIFY DEVICE data indicates the command is supported in word 83 bit 13, and the command is enabled in word 86 bit 13 (see ATA/ATAPI 7).~~

Sequence number: 1
Author: EDITOR[rlsheffi]
Subject: Inserted Text
Date: 6/19/2006 5:58:33 AM

T 9.1 Translating LBA and transfer length and ATA command use constraints

Last paragraph before Table 34:

Add to the end of the last sentence:

"ATA commands listed in the Allowed ATA commands column shall not be used in the emulation of a SCSI block command if the prerequisite conditions listed in Selection Prerequisites columns are not met (i.e., the word 'yes' in a Selection Prerequisites column means the prerequisite shall be met before the SATL may use an ATA command listed in that row, and the word 'no' indicates the prerequisite need not be met for the SATL to use the ATA command listed)."

RESOLUTION: See 06-216

Status
rlsheffi Completed 7/23/2006 12:09:08 PM

Sequence number: 2
Author: WDC[CStevens]
Subject: Comment on Text
Date: 6/19/2006 5:58:25 AM

T I am not sure what this table is trying to communicate... If I have 48-Bit enabled, it may still be more efficient for me to use 28-Bit commands.

RESOLUTION: change

"ATA feature sets supported and enabled"

to

"ATA feature sets required to be supported and enabled"

and change all entries that are "n/a" to "no"

RESOLUTION: See 06-216

Status
rlsheffi Completed 7/23/2006 12:09:24 PM

Sequence number: 3
Author: EDITOR[rlsheffi]
Subject: Highlight
Date: 6/19/2006 5:58:14 AM

T 9.1 Translating LBA and transfer length and ATA command use constraints

Table 34, first column heading,

"SCSI CDB"

s/b

"Highest ATA logical sector accessed"

RESOLUTION: See 06-216

Status
rlsheffi Completed 7/23/2006 12:09:37 PM

Sequence number: 4
Author: IBM[GPenokie]
Subject: Oval
Date: 6/20/2006 5:13:35 PM

 Table 34

The center headings should be centered.

RESOLUTION: see 06-216

Status
rlsheffi Completed 6/19/2006 6:03:21 AM

Sequence number: 5
Author: WDC[CStevens]
Subject: Comment on Text
Date: 7/12/2006 8:23:47 PM

T Most of my readers do not see N/A as Yes or No, They see it as Not Applicable; meaning that the commands in the allowed ATA column do not apply if the 48-bit address feature set is supported. I do not think this is the intention of the table, but I believe that the statement is ambiguous.

Table 34 relates selection conditions to allowable ATA commands used to implement SCSI block storage data transfer commands.

Table 34 — Read and write type command translation selection

Selection Prerequisites ^a					Allowed ATA commands
SCSI CDB	ATA feature sets supported and enabled ^d				
$(\text{Transfer length} + \text{LBA}) \leq 2^{28}$	48-bit Address ^b	DMA ^c	Overlap	SATA 2.5 NCQ	
n/a	n/a	n/a	n/a	n/a	FLUSH CACHE ^f FLUSH CACHE EXT ^g
yes ^{b, e}	n/a	n/a	n/a	n/a	READ MULTIPLE READ SECTOR(S) READ VERIFY SECTOR(S) WRITE MULTIPLE WRITE SECTOR(S)
yes ^{b, e}	n/a	yes	n/a	n/a	READ DMA WRITE DMA
yes ^{b, e}	n/a	yes	yes	n/a	READ DMA QUEUED WRITE DMA QUEUED
n/a	yes	yes	n/a	n/a	READ DMA EXT WRITE DMA EXT WRITE DMA FUA EXT
n/a	yes	yes	yes	n/a	READ DMA QUEUED EXT WRITE DMA QUEUED EXT WRITE DMA QUEUED FUA EXT
n/a	yes	n/a	n/a	n/a	READ MULTIPLE EXT READ SECTOR(S) EXT READ VERIFY SECTOR(S) EXT WRITE MULTIPLE EXT WRITE MULTIPLE FUA EXT WRITE SECTOR(S) EXT
n/a	n/a	n/a	n/a	yes	READ FPDMA QUEUED WRITE FPDMA QUEUED

^a An ATA command may be used to implement a SCSI block command only if all the prerequisites in the prerequisite columns for that command marked as yes are satisfied.

^b If the attached ATA device does not support the 48-bit Address feature set (see ATA/ATAPI-7) or NCQ (see SATA 2.5) and the SATL receives a request to access an LBA beyond $(2^{28}-1)$, the SATL shall terminate the command with CHECK CONDITION status with the sense key set to ILLEGAL REQUEST and the sense code set to LOGICAL BLOCK ADDRESS OUT OF RANGE.

^c The DMA prerequisite requires both the ATA host in the SATL and the attached ATA device to have the same DMA transfer mode enabled (i.e., bit 8 of word 49 in the IDENTIFY DEVICE data is set to one and at least one DMA mode is enabled in word 63 or word 88 of the IDENTIFY DEVICE data).

^d See ATA/ATAPI-7.

^e The SATL may transfer the number of logical blocks requested in the TRANSFER LENGTH field by sending multiple ATA commands, each time incrementing the ATA LBA by the ATA Sector Count transferred.

~~^f The FLUSH CACHE command may be used if ATA IDENTIFY DEVICE data indicates the command is supported in word 83 bit 12, and the command is enabled in word 86 bit 12 (see ATA/ATAPI-7).~~

~~^g The FLUSH CACHE EXT command may be used if ATA IDENTIFY DEVICE data indicates the command is supported in word 83 bit 13, and the command is enabled in word 86 bit 13 (see ATA/ATAPI-7).~~

RESOLUTION: Change occurrences of "n/a" in table 34 to "no" (see 06-216)

Status
rlsheffi Completed 7/23/2006 12:09:53 PM

Sequence number: 6
Author: EDITOR[rlsheffi]
Subject: Highlight
Date: 6/20/2006 5:15:01 PM

T 9.1 Translating LBA and transfer length and ATA command use constraints

Table 34, first column heading,
s/b

"(transfer length + LBA) 2^28"

s/b

"Required that logical sector address is < 2^28"

RESOLUTION: see 06-216

Status
rlsheffi Completed 7/23/2006 12:10:08 PM

Sequence number: 7
Author: EDITOR[rlsheffi]
Subject: Inserted Text
Date: 6/20/2006 5:16:53 PM

T 9.1 Translating LBA and transfer length and ATA command use constraints

Table 34, first column heading

Add a table footnote:

(x) If there is a one-to-one mapping between ATA logical sectors and SCSI logical blocks, then this represents the last block transferred. If the mapping between ATA logical sectors and SCSI logical blocks is not a simple one-to-one relationship, then this constraint is vendor-specific.

RESOLUTION: see 06-216 (uses definitions of indirect block mapping and direct block mapping).

Status
rlsheffi Completed 7/23/2006 12:10:38 PM

Sequence number: 8
Author: DELL[KMarks]
Subject: Cross-Out
Date: 6/19/2006 6:39:36 AM

T Table 34 — Read and write type command translation selection

remove 1st Row and footnotes f & g

"n/a n/a n/a n/a n/a FLUSH CACHE f
FLUSH CACHE EXT g"

They are not R/W commands as title says.

If not removing row, FLUSH CACHE EXT needs to be moved to row 7, as it requires 48-bit feature set.

RESOLUTION:

Change table title to "Table 34 — ATA commands used for SCSI block command translations"

Move the FLUSH CACHE EXT command to the row: (n/a, yes, n/a, n/a, n/a) that lists non-DMA EX commands.

Leave the FLUSH CACHE command by itself in the row it's in.

See 06-216

Status
rlsheffi Completed 7/23/2006 11:32:30 AM

Sequence number: 9
Author: DELL[KMarks]
Subject: Highlight
Date: 6/19/2006 6:46:12 AM

T Table 34 — Read and write type command translation selection

footnote b

change

"b If the attached ATA device does not support the 48-bit Address feature set (see ATA/ATAPI-7) or NCQ (see SATA 2.5) and the SATL receives a request to access an LBA beyond (228-1), the SATL shall terminate the command with CHECK CONDITION status with the sense key set to ILLEGAL REQUEST and the sense code set to LOGICAL BLOCK ADDRESS OUT OF RANGE."

Table 34 relates selection conditions to allowable ATA commands used to implement SCSI block storage data transfer commands.

Table 34 — Read and write type command translation selection

Selection Prerequisites ^a					Allowed ATA commands
SCSI CDB	ATA feature sets supported and enabled ^d				
(transfer length + LBA) ≤ 2 ²⁸	48-bit Address ^b	DMA ^c	Overlap	SATA 2.5 NCQ	
n/a	n/a	n/a	n/a	n/a	FLUSH CACHE ^f FLUSH CACHE EXT ^g
yes ^{b, e}	n/a	n/a	n/a	n/a	READ MULTIPLE READ SECTOR(S) READ VERIFY SECTOR(S) WRITE MULTIPLE WRITE SECTOR(S)
yes ^{b, e}	n/a	yes	n/a	n/a	READ DMA WRITE DMA
yes ^{b, e}	n/a	yes	yes	n/a	READ DMA QUEUED WRITE DMA QUEUED
n/a	yes	yes	n/a	n/a	READ DMA EXT WRITE DMA EXT WRITE DMA FUA EXT
n/a	yes	yes	yes	n/a	READ DMA QUEUED EXT WRITE DMA QUEUED EXT WRITE DMA QUEUED FUA EXT
n/a	yes	n/a	n/a	n/a	READ MULTIPLE EXT READ SECTOR(S) EXT READ VERIFY SECTOR(S) EXT WRITE MULTIPLE EXT WRITE MULTIPLE FUA EXT WRITE SECTOR(S) EXT
n/a	n/a	n/a	n/a	yes	READ FPDMA QUEUED WRITE FPDMA QUEUED

^a An ATA command may be used to implement a SCSI block command only if all the prerequisites in the prerequisite columns for that command marked as yes are satisfied.

^b If the attached ATA device does not support the 48-bit Address feature set (see ATA/ATAPI-7) or NCQ (see SATA 2.5) and the SATL receives a request to access an LBA beyond (2²⁸-1), the SATL shall terminate the command with CHECK CONDITION status with the sense key set to ILLEGAL REQUEST and the sense code set to LOGICAL BLOCK ADDRESS OUT OF RANGE.

¹⁰ The DMA prerequisite requires both the ATA host in the SATL and the attached ATA device to have the same DMA transfer mode enabled (i.e. ¹¹ 8 of word 49 in the IDENTIFY DEVICE data is set to one and at least one DMA mode is enabled in ¹² word 63 or word 88 of the IDENTIFY DEVICE data).

^d ¹³ ATA/ATAPI-7.

^e The SATL may transfer the number of logical blocks requested in the TRANSFER LENGTH field by sending multiple ATA commands, each time incrementing the ATA LBA by the ATA Sector Count transferred.

~~^f The FLUSH CACHE command may be used if ATA IDENTIFY DEVICE data indicates the command is supported in word 83 bit 12, and the command is enabled in word 86 bit 12 (see ATA/ATAPI-7).~~

~~^g The FLUSH CACHE EXT command may be used if ATA IDENTIFY DEVICE data indicates the command is supported in word 83 bit 13, and the command is enabled in word 86 bit 13 (see ATA/ATAPI-7).~~

to

"b If the ATA device does not support the 48-bit Address feature set (ATA IDENTIFY DEVICE data word 83, bit 10 is set to zero) nor NCQ (see SATA 2.5) and the SATL receives a request to access an LBA beyond (228-1), the SATL shall terminate the command with CHECK CONDITION status with the sense key set to ILLEGAL REQUEST and the additional sense code set to LOGICAL BLOCK ADDRESS OUT OF RANGE."

RESOLUTION: s/b

"b If the ATA device supports neither the 48-bit Address feature set (i.e., ATA IDENTIFY DEVICE data word 83, bit 10 is set to zero) nor NCQ (see SATA 2.5), and the LBA of the logical sector is greater than (228-1), the SATL shall terminate the command with CHECK CONDITION status with the sense key set to ILLEGAL REQUEST and the additional sense code set to LOGICAL BLOCK ADDRESS OUT OF RANGE."

See 06-216

Status
risheffi Completed 7/23/2006 11:34:02 AM

Sequence number: 10
Author: DELL[KMarks]
Subject: Highlight
Date: 6/24/2006 7:15:57 AM

T Table 34 — Read and write type command translation selection

footnote c
change

"c The DMA prerequisite requires both the ATA host in the SATL and the attached ATA device to have the same DMA transfer mode enabled (i.e., bit 8 of word 49 in the IDENTIFY DEVICE data is set to one and at least one DMA mode is enabled in word 63 or word 88 of the IDENTIFY DEVICE data)."

to

"c The DMA prerequisite requires both the ATA host in the SATL and the ATA device to have the same DMA transfer mode enabled (i.e., ATA IDENTIFY DEVICE data word 49, bit 8 is set to one and at least one DMA mode is enabled in the ATA IDENTIFY DEVICE data word 63 or word 88)."

RESOLUTION: see 06-216

Status
risheffi Completed 7/23/2006 11:55:34 AM

Sequence number: 11
Author: HPQ[RElliott]
Subject: Highlight
Date: 6/24/2006 7:16:33 AM

T 9.1
table 34

change "bit 8 of word 49 in the IDENTIFY DEVICE data" to "IDENTIFY DEVICE data word 49 bit 8"

RESOLUTION: see 06-216

Status
risheffi Completed 7/23/2006 11:57:10 AM

Sequence number: 12
Author: HPQ[RElliott]
Subject: Highlight
Date: 6/24/2006 7:16:48 AM

T 9.1
table 34

change "word 63 or word 88 of the IDENTIFY DEVICE data" to "IDENTIFY DEVICE data word 63 or word 88"

RESOLUTION: see 06-216

Status
risheffi Completed 7/23/2006 11:57:25 AM

Sequence number: 13
Author: EDITOR[risheffi]
Subject: Highlight
Date: 6/24/2006 7:17:09 AM

T Table 34 — Read and write type command translation selection

Table footnote d

change

"See ATA/ATAPI-7."

to

Comments from page 66 continued on next page

Table 34 relates selection conditions to allowable ATA commands used to implement SCSI block storage data transfer commands.

Table 34 — Read and write type command translation selection

Selection Prerequisites ^a					Allowed ATA commands
SCSI CDB	ATA feature sets supported and enabled ^d				
(transfer length + LBA) ≤ 2 ²⁸	48-bit Address ^b	DMA ^c	Overlap	SATA 2.5 NCQ	
n/a	n/a	n/a	n/a	n/a	FLUSH CACHE ^f FLUSH CACHE EXT ^g
yes ^{b, e}	n/a	n/a	n/a	n/a	READ MULTIPLE READ SECTOR(S) READ VERIFY SECTOR(S) WRITE MULTIPLE WRITE SECTOR(S)
yes ^{b, e}	n/a	yes	n/a	n/a	READ DMA WRITE DMA
yes ^{b, e}	n/a	yes	yes	n/a	READ DMA QUEUED WRITE DMA QUEUED
n/a	yes	yes	n/a	n/a	READ DMA EXT WRITE DMA EXT WRITE DMA FUA EXT
n/a	yes	yes	yes	n/a	READ DMA QUEUED EXT WRITE DMA QUEUED EXT WRITE DMA QUEUED FUA EXT
n/a	yes	n/a	n/a	n/a	READ MULTIPLE EXT READ SECTOR(S) EXT READ VERIFY SECTOR(S) EXT WRITE MULTIPLE EXT WRITE MULTIPLE FUA EXT WRITE SECTOR(S) EXT
n/a	n/a	n/a	n/a	yes	READ FPDMA QUEUED WRITE FPDMA QUEUED

^a An ATA command may be used to implement a SCSI block command only if all the prerequisites in the prerequisite columns for that command marked as yes are satisfied.

^b If the attached ATA device does not support the 48-bit Address feature set (see ATA/ATAPI-7) or NCQ (see SATA 2.5) and the SATL receives a request to access an LBA beyond (2²⁸-1), the SATL shall terminate the command with CHECK CONDITION status with the sense key set to ILLEGAL REQUEST and the sense code set to LOGICAL BLOCK ADDRESS OUT OF RANGE.

^c The DMA prerequisite requires both the ATA host in the SATL and the attached ATA device to have the same DMA transfer mode enabled (i.e., bit 8 of word 49 in the IDENTIFY DEVICE data is set to one and at least one DMA mode is enabled in word 63 or word 88 of the IDENTIFY DEVICE data).

^d See ATA/ATAPI-7.

¹⁴ The SATL may transfer the number of logical blocks requested in the TRANSFER LENGTH field by sending multiple ATA commands, each time incrementing the ATA LBA by the ATA Sector Count transferred.

¹⁵ ~~The FLUSH CACHE command may be used if ATA IDENTIFY DEVICE data indicates the command is supported in word 83 bit 12, and the command is enabled in word 86 bit 12 (see ATA/ATAPI-7).~~

⁹ ~~The FLUSH CACHE EXT command may be used if ATA IDENTIFY DEVICE data indicates the command is supported in word 83 bit 13, and the command is enabled in word 86 bit 13 (see ATA/ATAPI-7).~~

**"See ATA8-ACS."
RESOLUTION: see 06-216**

Status
rlsheffi Completed 7/23/2006 12:10:54 PM

Sequence number: 14
Author: DELL[KMarks]
Subject: Highlight
Date: 6/19/2006 6:59:31 AM

T Table 34 — Read and write type command translation selection
footnote e
change

"e The SATL may transfer the number of logical blocks requested in the TRANSFER LENGTH field by sending multiple ATA commands, each time incrementing the ATA LBA by the ATA Sector Count transferred."

to

"e The SATL may transfer the number of logical blocks requested in the TRANSFER LENGTH field of the SCSI CDB by sending multiple ATA commands, each time incrementing the ATA LBA by the ATA Sector Count transferred."

RESOLUTION: see 06-216

Status
rlsheffi Completed 7/23/2006 11:56:45 AM

Sequence number: 15
Author: DELL[KMarks]
Subject: Cross-Out
Date: 7/23/2006 11:53:15 AM

T Table 34 — Read and write type command translation selection

Remove footnotes f & g, per prior comment removing flush commands.

"f The FLUSH CACHE command may be used if ATA IDENTIFY DEVICE data indicates the command is supported in word 83 bit 12, and the command is enabled in word 86 bit 12 (see ATA/ATAPI-7).

g The FLUSH CACHE EXT command may be used if ATA IDENTIFY DEVICE data indicates the command is supported in word 83 bit 13, and the command is enabled in word 86 bit 13 (see ATA/ATAPI-7)."

Additionally f is not needed, ATA FLUSH CACHE is mandatory.

RESOLUTION: Remove table footnotes f and g since they are required commands in ATA8-ACS. See 06-216

Status
rlsheffi Completed 7/23/2006 11:53:20 AM

The SATL may use the ATA commands listed in table 34 in the translation of SCSI read commands (see 3.1.64), SCSI write commands (see 3.1.68), SCSI write and verify commands (see 3.1.69), SCSI verify commands (see 3.1.67), and SCSI synchronize cache commands (see 3.1.65) if the prerequisites defined for the command as shown in table 34 are satisfied. The translations for specific SCSI block commands in clause 9 further constrain the use of the available ATA commands in implementing the translation.

The SATL emulation of ¹ six-byte SCSI read command, SCSI verify command, SCSI write command, or SCSI write and verify command in which the TRANSFER LENGTH field ² VERIFICATION LENGTH field is set to zero, shall translate the transfer length or verification length to 256, and issue ATA commands that operate on the ATA logical sectors corresponding to the specified 256 SCSI logical blocks.

In all other cases, the SATL shall transfer or operate on the ATA logical sectors corresponding to the number of logical blocks specified by the SCSI command.

9.2 FORMAT UNIT command

³ 9.2.1 FORMAT UNIT command overview

⁴ The FORMAT UNIT command verifies that all logical block addresses accessible to SCSI application clients are formatted and ready for data transfers.

⁶ Table 35 — FORMAT UNIT command CDB fields

Field	Description or reference
OPERATION CODE	If no defect list header is provided or a defect list header is provided with the DCRT bit set to one, then the SATL shall return GOOD status without issuing any commands to the ATA device. If the SATL supports certification of media and a defect list header is provided with the DCRT bit set to zero, then the SATL shall certify the media as described in 9.2.5
DEFECT LIST FORMAT	If the DEFECT LIST FORMAT field is the mandatory format (000b) or the vendor specific format (110b) the defect list length shall be zero (see SBC-2). If the DEFECT LIST FORMAT field is any other value the SATL shall terminate the command with CHECK CONDITION status with the sense key set to ILLEGAL REQUEST and the additional sense code set to INVALID FIELD IN CDB.
CMPLIST	If a cmplist is specified, the FMTDATA bit is set to one, and the CMPLIST bit is set to one, then the SATL shall terminate the command with a CHECK CONDITION status with sense key set to ILLEGAL REQUEST and additional sense code set to INVALID FIELD IN CDB.
FMTDATA	If set to zero no data shall be transferred from the data-out buffer. If set to one the FORMAT UNIT parameter list shall be transferred from the client's data out buffer. The SATL may accept a FORMAT UNIT parameter list specifying the IMMED bit and an initialization pattern. The SATL shall ignore any defect list descriptors and any other fields provided in the FORMAT UNIT parameter list (see 9.2.2).
LONGLIST	Unspecified (see 3.4.3)
FMTINFO	Unspecified (see 3.4.3)
CONTROL	6.4

The SATL shall process commands received during the processing of the FORMAT UNIT command as specified in SBC-2.

9.2.2 FORMAT UNIT parameter list

If the FORMAT command CDB specifies a FMTDATA bit of one, the SATL shall accept a FORMAT UNIT parameter list consisting of a short or long defect list header and may accept an initialization pattern

Sequence number: 1
Author: INTC[RSheffield]
Subject: Highlight
Date: 6/19/2006 7:13:04 AM

T 9.1 Translating LBA and transfer length and ATA command use constraints

Second paragraph following Table 34.

"a six-byte SCSI read command, SCSI verify command, SCSI write command, or SCSI write and verify command"
s/b

"the READ (6) command and the WRITE (6) command"

RESOLUTION: see 06-216

Status
risheffi Completed 7/23/2006 12:11:39 PM

Sequence number: 2
Author: INTC[RSheffield]
Subject: Cross-Out
Date: 6/19/2006 7:13:24 AM

T 9.1 Translating LBA and transfer length and ATA command use constraints

Second paragraph following Table 34.

Delete "or VERIFICATION LENGTH field"

RESOLUTION: see 06-216

Status
risheffi Completed 7/23/2006 12:11:53 PM

Sequence number: 3
Author: IBM[GPenokie]
Subject: Underline
Date: 2/16/2006 1:42:03 PM
T 9.2.1 FORMAT UNIT command overview

Status
risheffi Cancelled 4/27/2006 4:53:05 PM

Sequence number: 4
Author: DELL[KMarks]
Subject: Highlight
Date: 6/20/2006 5:33:22 PM

T 9.2.1 FORMAT UNIT command overview

1st Paragraph
change

"The FORMAT UNIT command verifies that all logical block addresses accessible to SCSI application clients are formatted and ready for data transfers."

to

"The FORMAT UNIT command verifies that all logical block addresses accessible to an application client are formatted and ready for data transfers. Table 35 shows the translation for fields specified in the FORMAT UNIT CDB."

RESOLUTION: see 06-216

Status
risheffi Completed 7/23/2006 12:12:34 PM

Sequence number: 5
Author: HPQ[RElliott]
Date: 6/20/2006 5:33:44 PM

 9.2.1

need a reference to table 35

RESOLUTION: see 06-216

Status
risheffi Completed 7/23/2006 12:12:48 PM

Sequence number: 6
Author: IBM[GPenokie]

The SATL may use the ATA commands listed in table 34 in the translation of SCSI read commands (see 3.1.64), SCSI write commands (see 3.1.68), SCSI write and verify commands (see 3.1.69), SCSI verify commands (see 3.1.67), and SCSI synchronize cache commands (see 3.1.65) if the prerequisites defined for the command as shown in table 34 are satisfied. The translations for specific SCSI block commands in clause 9 further constrain the use of the available ATA commands in implementing the translation.

The SATL emulation of a six-byte SCSI read command, SCSI verify command, SCSI write command, or SCSI write and verify command in which the TRANSFER LENGTH field ~~or VERIFICATION LENGTH field~~ is set to zero, shall translate the transfer length or verification length to 256, and issue ATA commands that operate on the ATA logical sectors corresponding to the specified 256 SCSI logical blocks.

In all other cases, the SATL shall transfer or operate on the ATA logical sectors corresponding to the number of logical blocks specified by the SCSI command.

9.2 FORMAT UNIT command

9.2.1 FORMAT UNIT command overview

The FORMAT UNIT command verifies that all logical block addresses accessible to SCSI application clients are formatted and ready for data transfers.

Table 35 — FORMAT UNIT command CDB fields

Field	Description or reference
OPERATION CODE	If no defect list header is provided or a defect list header is provided with the DCRT bit set to one, then the SATL shall return GOOD status without issuing any commands to the ATA device. If the SATL supports certification of media and a defect list header is provided with the DCRT bit set to zero, then the SATL shall certify the media as described in 9.2.5
DEFECT LIST FORMAT	If the DEFECT LIST FORMAT field is the mandatory format (000b) or the vendor specific format (110b) the defect list length shall be zero (see SBC-2). If the DEFECT LIST FORMAT field is any other value the SATL shall terminate the command with CHECK CONDITION status with the sense key set to ILLEGAL REQUEST and the additional sense code set to INVALID FIELD IN CDB.
CMPLIST	⁷ If a cmplist is specified, the FMTDATA bit is set to one, and the CMPLIST bit is set to one, then the SATL shall terminate the command with a CHECK CONDITION status with sense key set to ILLEGAL REQUEST and additional sense code set to INVALID FIELD IN CDB.
FMTDATA	⁹ set to zero no data shall be transferred from the data-out buffer. If set to one the FORMAT UNIT parameter list shall be transferred from the client's data out buffer. The SATL may accept a FORMAT UNIT parameter list specifying the IMMED bit and an initialization pattern. The SATL shall ignore any defect list descriptors and any other fields provided in the FORMAT UNIT parameter list (see 9.2.2).
LONGLIST	Unspecified (see 3.4.3)
FMTINFO	Unspecified (see 3.4.3)
CONTROL	6.4

The SATL shall process commands received during the processing of the FORMAT UNIT command as specified in SBC-2.

9.2.2 FORMAT UNIT parameter list

If the FORMAT command CDB specifies a FMTDATA bit of one, the SATL shall accept a FORMAT UNIT parameter list consisting of a short or long defect list header and may accept an initialization pattern

Subject: Highlight
Date: 6/20/2006 5:33:58 PM

T There is no reference to table 35. This needs to be fixed as all tables have to be referenced.

RESOLUTION: see 06-216

Status
rsheffi Completed 7/23/2006 12:12:55 PM

Sequence number: 7
Author: IBM[GPenokie]
Subject: Comment on Text
Date: 6/20/2006 5:36:45 PM

T table 35 - cmlist row

This << If a cmlist is specified, the FMTDATA bit is set to one, and the CMLIST bit is set to one, then the SATL >> should be << If a complete list is specified (i.e., the FMTDATA bit is set to one and the CMLIST bit is set to one), then the SATL >> or the cmlist term needs to be in small caps.

RESOLUTION: s/b

" If a complete list is specified (i.e., the FMTDATA bit is set to one and the CMLIST bit is set to one), then the SATL..."

RESOLUTION: see 06-216

Status
rsheffi Completed 7/23/2006 12:13:19 PM

Sequence number: 8
Author: DELL[KMarks]
Subject: Note
Date: 6/20/2006 5:39:07 PM

Table 35 — FORMAT UNIT command CDB fields

The translation for RTO_REQ is missing from the table.

Add RTO_REQ as set to zero if you accept change on FMTPINFO comment, or unspecified if changing PROTECT bit in INQUIRY data.

RESOLUTION: Add a row for RTO_REQ to table 35 with an appropriate description
See 06-216.

Status
rsheffi Completed 7/23/2006 12:13:39 PM

Sequence number: 9
Author: DELL[KMarks]
Subject: Highlight
Date: 6/20/2006 5:45:12 PM

Table 35 — FORMAT UNIT command CDB fields

**Row: FMTDATA
change**

"If set to zero no data shall be transferred from the data-out buffer. If set to one the FORMAT UNIT parameter list shall be transferred from the client's data out buffer. The SATL may accept a FORMAT UNIT parameter list specifying the IMMEDIATE bit and an initialization pattern. The SATL shall ignore any defect list descriptors and any other fields provided in the FORMAT UNIT parameter list (see 9.2.2)."

to

"If set to zero, no data shall be transferred from the application client. If set to one the FORMAT UNIT parameter list shall be transferred from the application client. The SATL may accept a FORMAT UNIT parameter list specifying the IMMEDIATE bit and an initialization pattern. The SATL shall ignore any defect list descriptors and any other fields provided in the FORMAT UNIT parameter list (see 9.2.2)."

Should it say IMMEDIATE bit set to one?

Thoughts: SAT allows both settings of the IMMEDIATE bit, so the description of the FMTDATA bit shouldn't qualify the IMMEDIATE bit one way or the other. Perhaps the description of the FMTDATA bit should say nothing about the IMMEDIATE bit since there is a reference to the FORMAT UNIT parameter list and the IMMEDIATE bit is described there.

RESOLUTION: see 06-216

Status
rsheffi Completed 7/23/2006 12:14:27 PM

Comments from page 67 continued on next page

The SATL may use the ATA commands listed in table 34 in the translation of SCSI read commands (see 3.1.64), SCSI write commands (see 3.1.68), SCSI write and verify commands (see 3.1.69), SCSI verify commands (see 3.1.67), and SCSI synchronize cache commands (see 3.1.65) if the prerequisites defined for the command as shown in table 34 are satisfied. The translations for specific SCSI block commands in clause 9 further constrain the use of the available ATA commands in implementing the translation.

The SATL emulation of a six-byte SCSI read command, SCSI verify command, SCSI write command, or SCSI write and verify command in which the TRANSFER LENGTH field ~~or VERIFICATION LENGTH field~~ is set to zero, shall translate the transfer length or verification length to 256, and issue ATA commands that operate on the ATA logical sectors corresponding to the specified 256 SCSI logical blocks.

In all other cases, the SATL shall transfer or operate on the ATA logical sectors corresponding to the number of logical blocks specified by the SCSI command.

9.2 FORMAT UNIT command

9.2.1 FORMAT UNIT command overview

The FORMAT UNIT command verifies that all logical block addresses accessible to SCSI application clients are formatted and ready for data transfers.

Table 35 — FORMAT UNIT command CDB fields

Field	Description or reference
OPERATION CODE	If no defect list header is provided or a defect list header is provided with the DCRT bit set to one, then the SATL shall return GOOD status without issuing any commands to the ATA device. If the SATL supports certification of media and a defect list header is provided with the DCRT bit set to zero, then the SATL shall certify the media as described in 9.2.5
DEFECT LIST FORMAT	If the DEFECT LIST FORMAT field is the mandatory format (000b) or the vendor specific format (110b) the defect list length shall be zero (see SBC-2). If the DEFECT LIST FORMAT field is any other value the SATL shall terminate the command with CHECK CONDITION status with the sense key set to ILLEGAL REQUEST and the additional sense code set to INVALID FIELD IN CDB.
CMPLIST	If a cmplist is specified, the FMTDATA bit is set to one, and the CMPLIST bit is set to one, then the SATL shall terminate the command with a CHECK CONDITION status with sense key set to ILLEGAL REQUEST and additional sense code set to INVALID FIELD IN CDB.
FMTDATA	If set to zero no data shall be transferred from the data-out buffer. If set to one the FORMAT UNIT parameter list shall be transferred from the client's data out buffer. The SATL may accept a FORMAT UNIT parameter list specifying the IMMED bit and an initialization pattern. The SATL shall ignore any defect list descriptors and any other fields provided in the FORMAT UNIT parameter list (see 9.2.2).
LONGLIST	Unspecified (see 3.4.3)
FMTPINFO	10 specified (see 3.4.3)
CONTROL	6.4

The SATL shall process commands received during the processing of the FORMAT UNIT command as specified in SBC-2.

9.2.2 FORMAT UNIT parameter list

If the FORMAT command CDB specifies a FMTDATA bit of one, the SATL shall accept a FORMAT UNIT parameter list consisting of a short or long defect list header and may accept an initialization pattern

Sequence number: 10
Author: DELL[KMarks]
Subject: Highlight
Date: 4/28/2006 1:03:56 PM

T Table 35 — FORMAT UNIT command CDB fields
Row: FMTPINFO

This field can not be set to Unspecified, because the PROTECT bit in the INQUIRY data is a shall be set to zero. Change the PROTECT bit to Unspecified or change this field to if not zero, then CHECK CONDITION/IR/IFIC.

RESOLUTION: Changing the PROTECT bit in INQUIRY data to "Unspecified" (per comment from SIERLGC in subclause 8.1.2).

Status
risheffi Completed 6/20/2006 5:46:35 PM

descriptor. The SATL shall ignore any defect descriptors provided. Table 36 defines the SATL handling of fields in the FORMAT UNIT defect list header.

Table 36 — SATL defect list header

Field	Description or reference
FOV	9.2.3 and 9.2.4
DPRY	The SATL shall ignore this field.
DCRT	9.2.3 and 9.2.5
STPF	Unspecified (see 3.4.3)
IP	9.2.3 and 9.2.6
IMMED	9.2.3
DEFECT LIST LENGTH	The SATL shall ignore any defect descriptors provided.

9.2.3 SATL defect list header field combinations

Table 37 describes the actions the SATL takes depending on the values set in the IMMED bit, the FOV bit, the DCRT bit, and the IP bit.

Table 37 — SATL defect list header field combinations

IMMED	FOV	DCRT	IP	Description of SATL processing
one	n/a	n/a	n/a	The SATL may complete the FORMAT UNIT command immediately with GOOD status.
n/a	zero	n/a	n/a	
n/a	one	one	zero	
zero	one	zero	zero	If the SATL does not support media certification, then the SATL may terminate the command with CHECK CONDITION status with the sense key set to ILLEGAL REQUEST with the additional sense code set to INVALID FIELD PARAMETER LIST. Otherwise, the SATL shall issue the required read and write commands to certify and initialize the media as specified by DCRT bit and IP bit, and shall then return GOOD status if no unrecoverable write errors occur.
		zero	one	
		one	one	

9.2.4 FOV bit

The FOV bit may be set to one to include an initialization pattern descriptor and no defect descriptors, otherwise the SATL may terminate the command with CHECK CONDITION status with the sense key set to ILLEGAL REQUEST with the additional sense code set to INVALID FIELD PARAMETER LIST.

2.5 DCRT bit

4 the DCRT bit is set to zero and media certification is supported by the SATL, then the SATL shall issue ATA verify commands (see 3.1.17) to access all the logical sectors on the ATA device's medium that comprise every SCSI logical block emulated by the SATL. For every unrecoverable read error that is encountered, the SATL shall issue an ATA write command (see 3.1.18) to the defective logical sector to attempt to cause logical sector reallocation. The data written shall be the data pattern specified by the initialization pattern descriptor, if any, or vendor-specific. After writing the affected logical sector, the SATL shall again issue an ATA verify command to the same logical sector to verify the alternate logical sector is not defective. **5** The process (verify, write, verify, write,...) shall repeat until the logical sector is verified successfully or the disk returns a fatal error other than an unrecoverable read error (e.g., device fault). See 5.3 for a description of error handling for multiple ATA command sequences.

Sequence number: 1
Author: IBM[GPenokie]
Subject: Comment on Text
Date: 6/20/2006 5:48:52 PM

T Table 37

All the << one >>s should be << 1 >> and all the << zero >>s should be << 0 >>.
RESOLUTION: see 06-216

Status
rlsheffi Completed 7/23/2006 12:14:48 PM

Sequence number: 2
Author: HPQ[RElliott]
Subject: Highlight
Date: 6/20/2006 5:50:35 PM

T 9.2.3 table 37

"read and write commands" s/b "ATA read and ATA write commands"
RESOLUTION: see 06-216

Status
rlsheffi Completed 7/23/2006 12:15:03 PM

Sequence number: 3
Author: IBM[GPenokie]
Subject: Underline
Date: 2/16/2006 1:44:45 PM

T 9.2.5 DCRT bit

Status
rlsheffi Cancelled 4/28/2006 1:21:58 PM

Sequence number: 4
Author: DELL[KMarks]
Subject: Highlight
Date: 6/20/2006 5:53:50 PM

T 9.2.5 DCRT bit 1st Paragraph, 1st Sentence

change

"If the DCRT bit is set to zero and media certification is supported by the SATL, then the SATL shall issue ATA verify commands (see 3.1.17) to access all the logical sectors on the ATA device's medium that comprise every SCSI logical block emulated by the SATL."

to

"If the DCRT bit is set to zero and media certification is supported by the SATL, then the SATL shall issue ATA verify commands (see 3.1.17) to access all the logical sectors on the medium of the ATA device that comprise every logical block emulated by the SATL."

RESOLUTION: see 06-216

Status
rlsheffi Completed 7/23/2006 12:15:52 PM

Sequence number: 5
Author: IBM[GPenokie]
Subject: Comment on Text
Date: 6/20/2006 5:55:47 PM

T 1st paragraph

This << defective. The process (verify, write, verify, write,...) shall repeat until >> should be << defective. The process (e.g., verify, write, verify, write, etc.) shall repeat until >>

RESOLUTION: see 06-216

Status
rlsheffi Completed 7/23/2006 12:16:12 PM

9.2.6 IP bit

If the SATL supports an IP bit value of one and the IP bit is set to one, the SATL shall process the command as follows:

- a) If the attached ATA device supports the SCT LBA Segment Access (see SCT) command and the value of the INITIALIZATION PATTERN LENGTH field in the initialization pattern descriptor is four, and the value of the IP MODIFIER field in the initialization pattern descriptor is zero, then the SATL should issue an SCT LBA Segment Access command to the attached ATA device with the Function Code field set to 0001b (i.e., Repeat Write Pattern), with the Start field and the Count field set to initialize the area of the media accessible by the application client, and with the Pattern field set to the value of the INITIALIZATION PATTERN field from the FORMAT command initialization pattern descriptor; and
- b) if the SCT LBA Segment Access command is not used to write the initialization pattern, then the SATL shall write the specified pattern by issuing ATA write commands (see 3.1.18 and 9.1) to the attached ATA device.

If the IP bit is set to zero, then the SATL shall return GOOD status.

1 NOTE 7 The SATL should reverse the order of the bytes between the Pattern field in the SCT LBA Segment Access command and the value stored in the INITIALIZATION PATTERN field in the FORMAT command initialization pattern descriptor to adjust for the translation from little-endian to big-endian byte ordering.

9.3 READ commands overview

9.3.1 READ commands operation code translation

This subclause applies to the translation of ~~2~~ SCSI READ(6), READ(10), READ(12), and READ(16) commands.

The SATL shall issue ATA read commands (see 3.1.15) in accordance with the constraints specified in 9.1 to cause the ATA device to transfer the logical blocks specified in the SCSI read command (see 3.1.64).

3 the SATL returns an error other than an ILLEGAL REQUEST while processing the command the SATL may transfer a vendor-specific amount of data before terminating the command.

4 3.2 READ commands with FUA

If the SATL does not support FUA and the FUA bit is set to one, the SATL shall terminate the READ (10), READ (12) or READ (16) command with CHECK CONDITION status with the sense key set to ILLEGAL REQUEST and the additional sense code set to INVALID FIELD IN CDB.

6 the SATL shall process a SCSI read command with the FUA bit set to one as follows depending on whether or not the attached ATA device supports NCQ:

- a) If the attached device supports NCQ (i.e., bit-8 in word 77 of ATA IDENTIFY DEVICE data is set to one) the SATL shall issue a READ FPDMA QUEUED command (see SATA 2.5) with the FUA bit in the Device field set to one;
- b) otherwise, the SATL shall,
 - 1) if the ATA device's write cache is enabled (see ATA/ATAPI-7), issue an ATA verify command (see 3.1.17); and,
 - 2) issue an ATA read command as specified in 9.3.1.



Sequence number: 1
Author: DELL[KMarks]
Subject: Highlight
Date: 6/24/2006 8:57:08 AM

T 9.2.6 IP bit
Note 7 after 2nd Paragraph
change
"NOTE 7 The SATL should..."
to
"NOTE 7 - The SATL should..."
TODO: Fix every NOTE to add "-"

Status
rlsheffi Completed 7/23/2006 12:17:09 PM

Sequence number: 2
Author: DELL[KMarks]
Subject: Cross-Out
Date: 2/6/2006 7:09:11 PM

T SCSI

Status
rlsheffi Completed 6/24/2006 9:38:20 AM

Sequence number: 3
Author: DELL[KMarks]
Subject: Highlight
Date: 2/16/2006 4:05:19 PM

T 9.3.1 READ commands operation code translation
3rd Paragraph

change
"If the SATL returns an error other than an ILLEGAL REQUEST while processing the command the SATL may transfer a vendor-specific amount of data before terminating the command."
to
"If the SATL returns a CHECK CONDITION status with a sense key set to a value other than ILLEGAL REQUEST while processing the command, the SATL may transfer a vendor-specific amount of data before terminating the command."

Status
rlsheffi Completed 8/29/2006 4:16:11 PM

Sequence number: 4
Author: IBM[GPenokie]
Subject: Underline
Date: 2/16/2006 1:44:06 PM

T 9.3.2 READ commands with FUA

Status
rlsheffi Cancelled 4/28/2006 1:53:29 PM

Sequence number: 5
Author: DELL[KMarks]
Subject: Highlight
Date: 2/6/2006 7:30:53 PM

T 9.3.2 READ commands with FUA
2nd Paragraph, 1st Sentence

"The SATL shall process a SCSI read command with the FUA bit set to one as follows depending on whether or not the attached ATA device supports NCQ:"
to
"The SATL shall process a SCSI read command with the FUA bit set to one as follows:"

Status
rlsheffi Completed 9/13/2006 8:28:39 AM

Sequence number: 6
Author: MXO[MEvans]
Subject: Highlight

9.2.6 IP bit

If the SATL supports an IP bit value of one and the IP bit is set to one, the SATL shall process the command as follows:

- a) If the attached ATA device supports the SCT LBA Segment Access (see SCT) command and the value of the INITIALIZATION PATTERN LENGTH field in the initialization pattern descriptor is four, and the value of the IP MODIFIER field in the initialization pattern descriptor is zero, then the SATL should issue an SCT LBA Segment Access command to the attached ATA device with the Function Code field set to 0001b (i.e., Repeat Write Pattern), with the Start field and the Count field set to initialize the area of the media accessible by the application client, and with the Pattern field set to the value of the INITIALIZATION PATTERN field from the FORMAT command initialization pattern descriptor; and
- b) if the SCT LBA Segment Access command is not used to write the initialization pattern, then the SATL shall write the specified pattern by issuing ATA write commands (see 3.1.18 and 9.1) to the attached ATA device.

If the IP bit is set to zero, then the SATL shall return GOOD status.

NOTE 7 The SATL should reverse the order of the bytes between the Pattern field in the SCT LBA Segment Access command and the value stored in the INITIALIZATION PATTERN field in the FORMAT command initialization pattern descriptor to adjust for the translation from little-endian to big-endian byte ordering.

9.3 READ commands overview

9.3.1 READ commands operation code translation

This subclause applies to the translation of ~~SCSI~~ READ(6), READ(10), READ(12), and READ(16) commands.

The SATL shall issue ATA read commands (see 3.1.15) in accordance with the constraints specified in 9.1 to cause the ATA device to transfer the logical blocks specified in the SCSI read command (see 3.1.64).

If the SATL returns an error other than an ILLEGAL REQUEST while processing the command the SATL may transfer a vendor-specific amount of data before terminating the command.

9.3.2 READ commands with FUA

If the SATL does not support FUA and the FUA bit is set to one, the SATL shall terminate the READ (10), READ (12) or READ (16) command with CHECK CONDITION status with the sense key set to ILLEGAL REQUEST and the additional sense code set to INVALID FIELD IN CDB.

The SATL shall process a SCSI read command with the FUA bit set to one as follows depending on whether or not the attached ATA device supports NCQ:

- 7) If the attached device supports NCQ (i.e., bit-8 in word 77 of ATA IDENTIFY DEVICE data is set to one) the SATL shall issue a READ FPDMA QUEUED command (see SATA 2.5) with the FUA bit in the Device field set to one;
- 8) otherwise, the SATL shall,
 - 1) if the ATA device's write cache is enabled (see ATA/ATAPI-7), issue an ATA verify command (see 3.1.17); and,
 - 2) issue an ATA read command as specified in 9.3.1.

Date: 8/28/2006 2:53:56 PM

T 9.3.2 READ commands with FUA: change the second paragraph to:

The SATL shall process a SCSI read command with the FUA bit set to one as follows:

- a) If the attached ATA device supports NCQ (i.e., bit 8 in word 77 of ATA IDENTIFY DEVICE data is set to one) the SATL shall issue a READ FPDMA QUEUED command (see SATA 2.5) with the FUA bit in the Device field set to one;
- b) If the attached ATA device supports the Overlapped feature set and there are outstanding ATA queued commands, then the SATL shall:
 - 1) wait until all ATA queued commands have completed;
 - 2) if the ATA device's write cache is enabled (see ATA/ATAPI-7), issue an ATA verify command (see 3.1.17); and,
 - 3) issue an ATA read command as specified in 9.3.1;or
- c) If the attached ATA device does not support the Overlapped feature set or there are no outstanding ATA queued commands, then the SATL shall:
 - 1) if the ATA device's write cache is enabled (see ATA/ATAPI-7), issue an ATA verify command (see 3.1.17); and,
 - 2) issue an ATA read command as specified in 9.3.1.

RESOLUTION: s/b

"The SATL shall process a SCSI read command with the FUA bit set to one as follows:

- a) If the ATA device supports NCQ (i.e., ATA IDENTIFY DEVICE data word 76 bit 8 is set to one) the SATL shall issue a READ FPDMA QUEUED command (see SATA 2.5) with the FUA bit in the Device register set to one;
- b) If the ATA device supports the TCQ (see ATA8-ACS) and there are outstanding ATA queued commands, then the SATL shall:
 - 1) wait until all ATA queued commands have completed;
 - 2) if the write cache is enabled (ATA8-ACS) on the ATA device, issue an ATA verify command (see 3.1.17); and,
 - 3) issue an ATA read command as specified in 9.3.1;or
- c) If the ATA device supports neither NCQ nor TCQ, or there are no outstanding ATA queued commands, then the SATL shall:
 - 1) if the write cache is enabled on the ATA device, issue an ATA verify command (see 3.1.17); and,
 - 2) issue an ATA read command as specified in 9.3.1."

Status

rlsheffi Completed 8/29/2006 4:27:58 PM

Sequence number: 7

Author: DELL[KMarks]

Subject: Highlight

Date: 4/28/2006 2:12:36 PM

T 9.3.2 READ commands with FUA
2nd Paragraph a) in a,b list

"a) If the attached device supports NCQ (i.e., bit-8 in word 77 of ATA IDENTIFY DEVICE data is set to one) the SATL shall issue a READ FPDMA QUEUED command (see SATA 2.5) with the FUA bit in the Device field set to one;"

to

"a) If the ATA device supports NCQ (i.e., ATA IDENTIFY DEVICE data word 76, bit 8 is set to one) the SATL shall issue a READ FPDMA QUEUED command (see SATA 2.5) with the FUA bit in the Device register set to one; or"

RESOLUTION: see MXO comment

Status

rlsheffi Completed 8/29/2006 4:28:31 PM

Sequence number: 8

Author: ENDL[RWeber]

Date: 4/28/2006 2:13:26 PM

 a,b list

There is no conjunction between entries a and b in this list.

RESOLUTION: see MXO comment.

Status

rlsheffi Completed 8/29/2006 4:28:41 PM

Sequence number: 9

Author: DELL[KMarks]

Subject: Highlight

Date: 4/28/2006 2:13:00 PM

T 9.3.2 READ commands with FUA

Comments from page 69 continued on next page

9.2.6 IP bit

If the SATL supports an IP bit value of one and the IP bit is set to one, the SATL shall process the command as follows:

- a) If the attached ATA device supports the SCT LBA Segment Access (see SCT) command and the value of the INITIALIZATION PATTERN LENGTH field in the initialization pattern descriptor is four, and the value of the IP MODIFIER field in the initialization pattern descriptor is zero, then the SATL should issue an SCT LBA Segment Access command to the attached ATA device with the Function Code field set to 0001b (i.e., Repeat Write Pattern), with the Start field and the Count field set to initialize the area of the media accessible by the application client, and with the Pattern field set to the value of the INITIALIZATION PATTERN field from the FORMAT command initialization pattern descriptor; and
- b) if the SCT LBA Segment Access command is not used to write the initialization pattern, then the SATL shall write the specified pattern by issuing ATA write commands (see 3.1.18 and 9.1) to the attached ATA device.

If the IP bit is set to zero, then the SATL shall return GOOD status.

NOTE 7 The SATL should reverse the order of the bytes between the Pattern field in the SCT LBA Segment Access command and the value stored in the INITIALIZATION PATTERN field in the FORMAT command initialization pattern descriptor to adjust for the translation from little-endian to big-endian byte ordering.

9.3 READ commands overview

9.3.1 READ commands operation code translation

This subclause applies to the translation of ~~SCSI~~ READ(6), READ(10), READ(12), and READ(16) commands.

The SATL shall issue ATA read commands (see 3.1.15) in accordance with the constraints specified in 9.1 to cause the ATA device to transfer the logical blocks specified in the SCSI read command (see 3.1.64).

If the SATL returns an error other than an ILLEGAL REQUEST while processing the command the SATL may transfer a vendor-specific amount of data before terminating the command.

9.3.2 READ commands with FUA

If the SATL does not support FUA and the FUA bit is set to one, the SATL shall terminate the READ (10), READ (12) or READ (16) command with CHECK CONDITION status with the sense key set to ILLEGAL REQUEST and the additional sense code set to INVALID FIELD IN CDB.

The SATL shall process a SCSI read command with the FUA bit set to one as follows depending on whether or not the attached ATA device supports NCQ:

- a) If the attached device supports NCQ (i.e., bit-8 in word 77 of ATA IDENTIFY DEVICE data is set to one) the SATL shall issue a READ FPDMA QUEUED command (see SATA 2.5) with the FUA bit in the Device field set to one;
 - 1) if the ATA device's write cache is enabled (see ATA/ATAPI-7), issue an ATA verify command (see 3.1.17); and,
 - 2) issue an ATA read command as specified in 9.3.1.



10

2nd Paragraph b) in a,b list

change

"b) otherwise, the SATL shall,

- 1) if the ATA device's write cache is enabled (see ATA/ATAPI-7), issue an ATA verify command (see 3.1.17); and
- 2) issue an ATA read command as specified in 9.3.1."

"b) otherwise, the SATL shall:

- 1) if the write cache is enabled (see ATA/ATAPI-7) on the ATA device, issue an ATA verify command (see 3.1.17);

and

- 2) issue an ATA read command as specified in 9.3.1."

RESOLUTION: see MXO comment

Status

rlsheffi Completed 8/29/2006 4:28:53 PM

Sequence number: 10

Author: IBM[GPenokie]

Subject: Comment on Text

Date: 4/28/2006 2:17:45 PM

T item b

This << b) otherwise, the SATL shall, >> should be << b) IF the attached device does not support NCQ, then the SATL shall, >>

REASON: see MXO comment for resolution - it's a 3-step unordered list with "or". (a) applies if NCQ is supported, so (b) and (c) only apply if (a) does not apply (i.e., the ATA device does not support NCQ).

Status

rlsheffi Rejected 4/28/2006 2:14:14 PM

9.4 READ (6) command

The READ (6) command is used to request the device to transfer logical blocks of user data to the requester. Data may be read from ATA device's medium or, data may be read from the ATA device's cache if the most recent copy is in the ATA device's cache (see SBC-2)

Table 38 — READ (6) command CDB fields

Field	Description or reference
OPERATION CODE	9.3.1
LOGICAL BLOCK ADDRESS	The logical block address shall be used to set the ATA LBA (see 3.1.11).
TRANSFER LENGTH	The transfer length shall be used to set the ATA sector count (see 3.1.16) ^a
CONTROL	6.4
^a A transfer length of zero specifies to transfer 256 data blocks from the attached ATA device to the application client (see SBC-2).	

9.5 READ (10) command

The SATL shall process the READ (10) command the same as the READ (6) command (see 9.3.1), with the additional fields in the CDB implemented as described in the table 39 and 9.3.2.

Table 39 — READ (10) command CDB fields

Field	Description or reference
OPERATION CODE	9.3.1 and 9.3.2
RDPROTECT	Unspecified (see 3.4.3)
DPO	Unspecified (see 3.4.3)
FUA	The SATL may support the FUA bit as defined in SBC-2 (see 9.3.2).
FUA_NV	If the FUA_NV bit is set to one the SATL shall terminate the command with CHECK CONDITION status with the sense key set to ILLEGAL REQUEST and the additional sense code set to INVALID FIELD IN CDB.
LOGICAL BLOCK ADDRESS	The logical block address shall be used to set the ATA LBA (see 3.1.11).
GROUP NUMBER	Unspecified (see 3.4.3)
TRANSFER LENGTH	The transfer length is used to set the ATA sector count (see 3.1.16). ^a The SATL shall issue as many ATA read commands (see 3.1.15) as needed to satisfy the transfer length specified by the READ (10) command.
CONTROL	6.4
^a A transfer length of zero indicates that a data transfer shall not take place.	

Sequence number: 1
Author: IBM[GPenokie]
Subject: Underline
Date: 2/16/2006 1:29:18 PM
T9.4 READ (6) command

Status
rlsheffi Cancelled 4/28/2006 2:21:41 PM

Sequence number: 2
Author: DELL[KMarks]
Subject: Highlight
Date: 6/24/2006 7:17:54 AM
T9.4 READ (6) command
1st Paragraph

"The READ (6) command is used to request the device to transfer logical blocks of user data to the requester
Data may be read from ATA device's medium or, data may be read from the ATA device's cache if the most recent copy is
in the ATA device's cache (see SBC-2)"

to

"The READ (6) command is used to request the device to transfer logical blocks of user data to the application client. The
requested data may be read from the medium or cache of the ATA device, if the most recent copy is in the cache (see
SBC-2)

Table 38 shows the translation for fields specified in the READ (6) CDB."

This kind of prohibits the SATL from having cache?
RESOLUTION: s/b

"The READ (6) command is used to request the device to transfer logical blocks of user data to the application client (see
SBC-2).

Table 38 shows the translation for fields specified in the READ (6) CDB."

More thoughts:

The SATL may not have any control over whether the data is retrieved from the media or cache of the ATA device. If the
translation is specifying command for command translations, perhaps it shouldn't say anything about the ATA device
cache.

Do we want this standard to discuss a SATL that has its own cache? At some point it becomes a full-blown storage
controller with SBC-2 and the other SCSI command sets governing the behavior. (SAT WG 6/19/06: "No").

See resolution in 06-216.

Status
rlsheffi Completed 7/23/2006 12:29:11 PM

Sequence number: 3
Author: MXO[MEvans]
Subject: Highlight
Date: 6/21/2006 12:28:19 PM
TREAD (6) command, first paragraph: delete the comma between "medium or" and "data may".
RESOLUTION: see 06-216

Status
rlsheffi Completed 7/23/2006 12:29:49 PM

Sequence number: 4
Author: HPQ[RElliott]
Date: 6/21/2006 12:28:31 PM

9.4 READ (6) command

The READ (6) command is used to request the device to transfer logical blocks of user data to the requester. Data may be read from ATA device's medium or, data may be read from the ATA device's cache if the most recent copy is in the ATA device's cache (see SBC-2)

Table 38 — READ (6) command CDB fields

Field	Description or reference
OPERATION CODE	9.3.1
LOGICAL BLOCK ADDRESS	The logical block address shall be used to set the ATA LBA (see 3.1.11).
TRANSFER LENGTH	The transfer length shall be used to set the ATA sector count (see 3.1.16) ^a
CONTROL	6.4
^a A transfer length of zero specifies to transfer 256 data blocks from the attached ATA device to the application client (see SBC-2).	

9.5 READ (10) command

The SATL shall process the READ (10) command the same as the READ (6) command (see 9.3.1), with the additional fields in the CDB implemented as described in the table 39 and 9.3.2.

Table 39 — READ (10) command CDB fields

Field	Description or reference
OPERATION CODE	9.3.1 and 9.3.2
RDPROTECT	Unspecified (see 3.4.3)
DPO	Unspecified (see 3.4.3)
FUA	The SATL may support the FUA bit as defined in SBC-2 (see 9.3.2).
FUA_NV	If the FUA_NV bit is set to one the SATL shall terminate the command with CHECK CONDITION status with the sense key set to ILLEGAL REQUEST and the additional sense code set to INVALID FIELD IN CDB.
LOGICAL BLOCK ADDRESS	The logical block address shall be used to set the ATA LBA (see 3.1.11).
GROUP NUMBER	Unspecified (see 3.4.3)
TRANSFER LENGTH	The transfer length is used to set the ATA sector count (see 3.1.16). ^a The SATL shall issue as many ATA read commands (see 3.1.15) as needed to satisfy the transfer length specified by the READ (10) command.
CONTROL	6.4
^a A transfer length of zero indicates that a data transfer shall not take place.	

9.4

need a reference to table 38

RESOLUTION: see 06-216

Status
rlsheffi Completed 7/23/2006 12:30:00 PM

Sequence number: 5
Author: IBM[GPenokie]
Subject: Highlight
Date: 6/21/2006 12:28:40 PM

T There is no reference to table 38. This needs to be fixed as all tables have to be referenced.

RESOLUTION: see 06-216

Status
rlsheffi Completed 7/23/2006 12:30:06 PM

Sequence number: 6
Author: EDITOR[rlsheffi]
Subject: Highlight
Date: 6/19/2006 10:58:36 AM

T Modify to provide more concise text describing the direct block mapping model and the indirect block mapping model.

RESOLUTION: see 06-216

Status
rlsheffi Completed 7/23/2006 12:30:27 PM

Sequence number: 7
Author: EDITOR[rlsheffi]
Subject: Inserted Text
Date: 6/21/2006 2:14:13 PM

T insert:
"A" as defined by 9.1"

RESOLUTION: see 06-216

Status
rlsheffi Completed 7/23/2006 12:30:43 PM

Sequence number: 8
Author: INTC[RSheffield]
Subject: Highlight
Date: 6/21/2006 2:14:23 PM

T **9.4 READ (6) command**

Table 38 — READ (6) command CDB fields

Row: TRANSFER LENGTH

"ATA sector count" s/b "ATA Sector Count"

RESOLUTION: see 06-216

Status
rlsheffi Completed 7/23/2006 12:31:01 PM

Sequence number: 9
Author: DELL[KMarks]
Subject: Highlight
Date: 6/21/2006 2:28:04 PM

T **Table 38 — READ (6) command CDB fields**

**footnote a
change**

**"a A transfer length of zero specifies to transfer 256 data blocks from the attached ATA device to the application client
(see SBC-2)."**

to

**"a A transfer length of zero specifies that 256 logical blocks shall be read from the ATA device and transferred to the
application client (see SBC-2)."**

RESOLUTION (see HPQ comment): s/b change

"specifies to transfer 256 data blocks" to "specifies a transfer of 256 logical blocks"

see 06-216

Status
rlsheffi Completed 7/23/2006 12:31:25 PM

Comments from page 70 continued on next page

9.4 READ (6) command

The READ (6) command is used to request the device to transfer logical blocks of user data to the requester. Data may be read from ATA device's medium or, data may be read from the ATA device's cache if the most recent copy is in the ATA device's cache (see SBC-2)

Table 38 — READ (6) command CDB fields

Field	Description or reference
OPERATION CODE	9.3.1
LOGICAL BLOCK ADDRESS	The logical block address shall be used to set the ATA LBA (see 3.1.11).
TRANSFER LENGTH	The transfer length shall be used to set the ATA sector count (see 3.1.16) ^a
CONTROL	6.4
^a A transfer length of zero ¹⁰ specifies to transfer 256 data blocks from the attached ATA device to the application client (see SBC-2).	

9.5 READ (10) command

The SATL shall process the READ (10) command the same as the READ (6) command (see 9.3.1), with the additional fields in the CDB implemented as described in the table 39 and 9.3.2.

Table 39 — READ (10) command CDB fields

Field	Description or reference
OPERATION CODE	9.3.1 and 9.3.2
RDPROTECT	¹¹ specified (see 3.4.3)
DPO	Unspecified (see 3.4.3)
FUA	The SATL may support the FUA bit as defined in SBC-2 (see 9.3.2).
FUA_NV	¹³ The FUA_NV bit is set to one the SATL shall terminate ¹² command with CHECK CONDITION status with the sense key set to ILLEGAL REQUEST and the additional sense code set to INVALID FIELD IN CDB.
LOGICAL BLOCK ADDRESS	The logical block address shall be used to set the ATA LBA (see 3.1.11).
GROUP NUMBER	Unspecified (see 3.4.3)
TRANSFER LENGTH	The transfer length is used to set the ATA sector count (see 3.1.16). ^a The SATL shall issue as many ATA read commands (see 3.1.15) as needed to satisfy the transfer length specified by the READ (10) command.
CONTROL	6.4
^a A transfer length of zero ¹⁴ indicates that a data transfer shall not take place.	

Sequence number: 10
Author: HPQ[RElliott]
Subject: Highlight
Date: 6/21/2006 2:28:24 PM

T9.4
table 38

change "specifies to transfer 256 data blocks" to "specifies a transfer of 256 logical blocks"
RESOLUTION: see 06-216

Status
rlsheffi Completed 7/23/2006 12:31:39 PM

Sequence number: 11
Author: DELL[KMarks]
Subject: Highlight
Date: 4/9/2006 11:42:43 AM

TTable 39 — READ (10) command CDB fields
Row: RDPROTECT

This field can not be set to Unspecified, because the PROTECT bit in the INQUIRY data is a shall be set to zero. Change the PROTECT bit to Unspecified or change this field to if not 000b, then CHECK CONDITION/IR/IFIC.

REASON: Changed the PROTECT bit in INQUIRY data to "Unspecified (see 3.4.3)" instead - consistent with the rest of the document.

Status
rlsheffi Rejected 4/9/2006 11:41:21 AM

Sequence number: 12
Author: DELL[KMarks]
Subject: Highlight
Date: 6/21/2006 2:29:40 PM

TTable 39 — READ (10) command CDB fields
Row: FUA_NV

"...the command with ..."
to

"...the READ (10) command with ..."

RESOLUTION: see 06-216

Status
rlsheffi Completed 7/23/2006 12:32:18 PM

Sequence number: 13
Author: INTC[RSheffield]
Subject: Highlight
Date: 6/21/2006 2:33:57 PM

T9.5 READ (10) command
Table 39 - FUA_NV bit

"If the FUA_NV bit is set to one the SATL shall terminate the command with CHECK CONDITION status with the sense key set to ILLEGAL REQUEST and the additional sense code set to INVALID FIELD IN CDB."

s/b

"The SATL may ignore the FUA_NV bit, or the SATL may implement the FUA_NV bit as defined in SBC-2."

RESOLUTION: see 06-216

Status
rlsheffi Completed 7/23/2006 12:32:28 PM

Sequence number: 14
Author: HPQ[RElliott]
Subject: Highlight
Date: 6/21/2006 2:39:32 PM

T9.5
table 39

indicates s/b specifies
RESOLUTION: see 06-216

Comments from page 70 continued on next page

9.4 READ (6) command

The READ (6) command is used to request the device to transfer logical blocks of user data to the requester. Data may be read from ATA device's medium or, data may be read from the ATA device's cache if the most recent copy is in the ATA device's cache (see SBC-2)

Table 38 — READ (6) command CDB fields

Field	Description or reference
OPERATION CODE	9.3.1
LOGICAL BLOCK ADDRESS	The logical block address shall be used to set the ATA LBA (see 3.1.11).
TRANSFER LENGTH	The transfer length shall be used to set the ATA sector count (see 3.1.16) ^a
CONTROL	6.4
^a A transfer length of zero specifies to transfer 256 data blocks from the attached ATA device to the application client (see SBC-2).	

9.5 READ (10) command

The SATL shall process the READ (10) command the same as the READ (6) command (see 9.3.1), with the additional fields in the CDB implemented as described in the table 39 and 9.3.2.

Table 39 — READ (10) command CDB fields

Field	Description or reference
OPERATION CODE	9.3.1 and 9.3.2
RDPROTECT	Unspecified (see 3.4.3)
DPO	Unspecified (see 3.4.3)
FUA	The SATL may support the FUA bit as defined in SBC-2 (see 9.3.2).
FUA_NV	If the FUA_NV bit is set to one the SATL shall terminate the command with CHECK CONDITION status with the sense key set to ILLEGAL REQUEST and the additional sense code set to INVALID FIELD IN CDB.
LOGICAL BLOCK ADDRESS	The logical block address shall be used to set the ATA LBA (see 3.1.11).
GROUP NUMBER	Unspecified (see 3.4.3)
TRANSFER LENGTH	The transfer length is used to set the ATA sector count (see 3.1.16). ^a The SATL shall issue as many ATA read commands (see 3.1.15) as needed to satisfy the transfer length specified by the READ (10) command.
CONTROL	6.4
^a A transfer length of zero indicates that a data transfer shall not take place.	

Status

risheffi Completed

7/23/2006 12:32:37 PM

9.6 READ (12) command

The SATL shall process the READ (12) command the same as the READ (10) command (see 9.3.1), with the fields in the CDB implemented as described in table 40 and 9.3.2.

Table 40 — READ (12) command CDB fields

Field	Description or reference
OPERATION CODE	9.3.1 and 9.3.2
RDPROTECT	1 Unspecified (see 3.4.3)
DPO	Unspecified (see 3.4.3)
FUA	The SATL may support the FUA bit as defined in SBC-2 (see 9.3.2).
FUA_NV	3 the FUA_NV bit is set to one the SATL shall terminate 2 the command with CHECK CONDITION status with the sense key set to ILLEGAL REQUEST and the additional sense code set to INVALID FIELD IN CDB.
LOGICAL BLOCK ADDRESS	The logical block address shall be used to set the ATA LBA (see 3.1.11).
GROUP NUMBER	Unspecified (see 3.4.3)
TRANSFER LENGTH	The transfer length is used to set the ATA sector count (see 3.1.16). ^a The SATL shall issue as many ATA read commands (see 3.1.15) as needed to satisfy the transfer length specified by the 4 READ (10) command.
CONTROL	6.4
^a A transfer length of zero indicates that a data transfer shall not take place.	

9.7 READ (16) command

The SATL shall process the READ (16) command the same as the READ (10) command (see 9.3.1), with the fields in the CDB implemented as described in table 41 and 9.3.2.

Table 41 — READ (16) command CDB fields

Field	Description or reference
OPERATION CODE	9.3.1 and 9.3.2
RDPROTECT	Unspecified (see 3.4.3)
DPO	Unspecified (see 3.4.3)
FUA	The SATL may support the FUA bit as defined in SBC-2 (see 9.3.2).
FUA_NV	If the FUA_NV bit is set to one the SATL shall terminate the command with CHECK CONDITION status with the sense key set to ILLEGAL REQUEST and the additional sense code set to INVALID FIELD IN CDB.
LOGICAL BLOCK ADDRESS	The logical block address shall be used to set the ATA LBA (see 3.1.11).
GROUP NUMBER	Unspecified (see 3.4.3)
TRANSFER LENGTH	The transfer length is used to set the ATA sector count (see 3.1.16). ^a The SATL shall issue as many ATA read commands (see 3.1.15) as needed to satisfy the transfer length specified by the READ (10) command.
CONTROL	6.4
^a A transfer length of zero indicates that a data transfer shall not take place.	

Sequence number: 1
Author: DELL[KMarks]
Subject: Highlight
Date: 4/9/2006 11:43:25 AM

T Table 40 — READ (12) command CDB fields
Row: RDPROTECT

This field can not be set to Unspecified, because the PROTECT bit in the INQUIRY data is a shall be set to zero. Change the PROTECT bit to Unspecified or change this field to if not 000b, then CHECK CONDITION/IR/IFIC.

REASON: Changed the PROTECT bit in INQUIRY data to "Unspecified (see 3.4.3)" instead - consistent with the rest of the document.

Status
rlsheffi Rejected 4/29/2006 3:12:04 PM

Sequence number: 2
Author: DELL[KMarks]
Subject: Highlight
Date: 4/29/2006 3:09:50 PM

T Table 40 — READ (12) command CDB fields
Row: FUA_NV

"...the command with ..."

to

"...the READ (12) command with ..."

REASON: see INTC comment - SATL should ignore FUA_NV bit, not terminate the command.

Status
rlsheffi Rejected 4/29/2006 3:09:54 PM

Sequence number: 3
Author: INTC[RSheffield]
Subject: Highlight
Date: 6/21/2006 2:42:15 PM

T 9.6 READ (12) command
Table 40 - FUA_NV bit

"If the FUA_NV bit is set to one the SATL shall terminate the command with CHECK CONDITION status with the sense key set to ILLEGAL REQUEST and the additional sense code set to INVALID FIELD IN CDB."

s/b

"The SATL may ignore the FUA_NV bit, or the SATL may implement the FUA_NV bit as defined in SBC-2."

RESOLUTION: Accept suggested change, see 06-216.

REASON: SBC-2 says that if the NV_SUP bit is set to zero in the Extended INQUIRY Data VPD page (i.e., the logical unit doesn't support NV cache), the device server responds as it would considering only the FUA bit (i.e., ignoring the FUA_NV bit), so it is in direct conflict with SBC-2 to return CHECK CONDITION status.

Status
rlsheffi Completed 7/23/2006 12:33:05 PM

Sequence number: 4
Author: QDSS[PSuhler]
Subject: Highlight
Date: 6/21/2006 2:43:22 PM

T Page: 71
9.6 Table 40

Editorial

Description of TRANSFER LENGTH field: "...specified by the READ (10) command."

s/b "specified by the READ (12) command."

RESOLUTION: see 06-216

Status
rlsheffi Completed 7/23/2006 12:33:27 PM

9.6 READ (12) command

The SATL shall process the READ (12) command the same as the READ (10) command (see 9.3.1), with the fields in the CDB implemented as described in table 40 and 9.3.2.

Table 40 — READ (12) command CDB fields

Field	Description or reference
OPERATION CODE	9.3.1 and 9.3.2
RDPROTECT	Unspecified (see 3.4.3)
DPO	Unspecified (see 3.4.3)
FUA	The SATL may support the FUA bit as defined in SBC-2 (see 9.3.2).
FUA_NV	If the FUA_NV bit is set to one the SATL shall terminate the command with CHECK CONDITION status with the sense key set to ILLEGAL REQUEST and the additional sense code set to INVALID FIELD IN CDB.
LOGICAL BLOCK ADDRESS	The logical block address shall be used to set the ATA LBA (see 3.1.11).
GROUP NUMBER	Unspecified (see 3.4.3)
TRANSFER LENGTH	The transfer length is used to set the ATA sector count (see 3.1.16). ^a The SATL shall issue as many ATA read commands (see 3.1.15) as needed to satisfy the transfer length specified by the READ (10) command.
CONTROL	6.4
^a A transfer length of zero indicates that a data transfer shall not take place.	

9.7 READ (16) command

The SATL shall process the READ (16) command the same as the READ (10) command (see 9.3.1), with the fields in the CDB implemented as described in table 41 and 9.3.2.

Table 41 — READ (16) command CDB fields

Field	Description or reference
OPERATION CODE	9.3.1 and 9.3.2
RDPROTECT	Unspecified (see 3.4.3)
DPO	Unspecified (see 3.4.3)
FUA	The SATL may support the FUA bit as defined in SBC-2 (see 9.3.2).
FUA_NV	If the FUA_NV bit is set to one the SATL shall terminate the command with CHECK CONDITION status with the sense key set to ILLEGAL REQUEST and the additional sense code set to INVALID FIELD IN CDB.
LOGICAL BLOCK ADDRESS	The logical block address shall be used to set the ATA LBA (see 3.1.11).
GROUP NUMBER	Unspecified (see 3.4.3)
TRANSFER LENGTH	The transfer length is used to set the ATA sector count (see 3.1.16). ^a The SATL shall issue as many ATA read commands (see 3.1.15) as needed to satisfy the transfer length specified by the READ (10) command.
CONTROL	6.4
^a A transfer length of zero indicates that a data transfer shall not take place.	

Sequence number: 5
Author: HPQ[RElliott]
Date: 6/21/2006 2:43:31 PM

T9.6
table 40

READ (10) s/b READ (12)
RESOLUTION: see 06-216

Status
risheffi Completed 7/23/2006 12:33:47 PM

Sequence number: 6
Author: HPQ[RElliott]
Subject: Highlight
Date: 6/21/2006 2:43:42 PM

T9.6
table 40

indicates s/b specifies
RESOLUTION: see 06-216

Status
risheffi Completed 7/23/2006 12:34:13 PM

Sequence number: 7
Author: DELL[KMarks]
Subject: Highlight
Date: 4/9/2006 11:43:56 AM

TTable 41 — READ (16) command CDB fields
Row: RDPROTECT

This field can not be set to Unspecified, because the PROTECT bit in the INQUIRY data is a shall be set to zero. Change the PROTECT bit to Unspecified or change this field to if not 000b, then CHECK CONDITION/IR/IFIC.

REASON: Changed the PROTECT bit in INQUIRY data to "Unspecified (see 3.4.3)" instead - consistent with the rest of the document.

Status
risheffi Rejected 4/9/2006 11:44:01 AM

Sequence number: 8
Author: DELL[KMarks]
Subject: Highlight
Date: 4/29/2006 3:13:11 PM

TTable 41 — READ (16) command CDB fields
Row: FUA_NV

"...the command with ..."

to

"...the READ (16) command with ..."

REASON: see INTC comment - SATL should ignore FUA_NV bit, not terminate the command.

Status
risheffi Rejected 4/29/2006 3:13:15 PM

Sequence number: 9
Author: INTC[RSheffield]
Subject: Highlight
Date: 6/21/2006 2:44:37 PM

T9.7 READ (16) command
Table 41 - FUA_NV bit

"If the FUA_NV bit is set to one the SATL shall terminate the command with CHECK CONDITION status with the sense key set to ILLEGAL REQUEST and the additional sense code set to INVALID FIELD IN CDB."

s/b

"The SATL may ignore the FUA_NV bit, or the SATL may implement the FUA_NV bit as defined in SBC-2."

RESOLUTION: Accept suggested change, see 06-216.

REASON: SBC-2 says that if the NV_SUP bit is set to zero in the Extended INQUIRY Data VPD page (i.e., the logical unit

Comments from page 71 continued on next page

9.6 READ (12) command

The SATL shall process the READ (12) command the same as the READ (10) command (see 9.3.1), with the fields in the CDB implemented as described in table 40 and 9.3.2.

Table 40 — READ (12) command CDB fields

Field	Description or reference
OPERATION CODE	9.3.1 and 9.3.2
RDPROTECT	Unspecified (see 3.4.3)
DPO	Unspecified (see 3.4.3)
FUA	The SATL may support the FUA bit as defined in SBC-2 (see 9.3.2).
FUA_NV	If the FUA_NV bit is set to one the SATL shall terminate the command with CHECK CONDITION status with the sense key set to ILLEGAL REQUEST and the additional sense code set to INVALID FIELD IN CDB.
LOGICAL BLOCK ADDRESS	The logical block address shall be used to set the ATA LBA (see 3.1.11).
GROUP NUMBER	Unspecified (see 3.4.3)
TRANSFER LENGTH	The transfer length is used to set the ATA sector count (see 3.1.16). ^a The SATL shall issue as many ATA read commands (see 3.1.15) as needed to satisfy the transfer length specified by the READ (10) command.
CONTROL	6.4
^a A transfer length of zero indicates that a data transfer shall not take place.	

9.7 READ (16) command

The SATL shall process the READ (16) command the same as the READ (10) command (see 9.3.1), with the fields in the CDB implemented as described in table 41 and 9.3.2.

Table 41 — READ (16) command CDB fields

Field	Description or reference
OPERATION CODE	9.3.1 and 9.3.2
RDPROTECT	Unspecified (see 3.4.3)
DPO	Unspecified (see 3.4.3)
FUA	The SATL may support the FUA bit as defined in SBC-2 (see 9.3.2).
FUA_NV	If the FUA_NV bit is set to one the SATL shall terminate the command with CHECK CONDITION status with the sense key set to ILLEGAL REQUEST and the additional sense code set to INVALID FIELD IN CDB.
LOGICAL BLOCK ADDRESS	The logical block address shall be used to set the ATA LBA (see 3.1.11).
GROUP NUMBER	Unspecified (see 3.4.3)
TRANSFER LENGTH	The transfer length is used to set the ATA sector count (see 3.1.16). ^a The SATL shall issue as many ATA read commands (see 3.1.15) as needed to satisfy the transfer length specified by the READ (10) command.
CONTROL	6.4
^a A transfer length of zero indicates that a data transfer shall not take place.	

doesn't support NV cache), the device server responds as it would considering only the FUA bit (i.e., ignoring the FUA_NV bit), so it is in direct conflict with SBC-2 to return CHECK CONDITION status.

Status
r/sheffi Completed 7/23/2006 12:34:40 PM

Sequence number: 10
Author: QDSS[PSuhler]
Subject: Highlight
Date: 6/21/2006 2:45:14 PM

T Page: 71
9.7 Table 41
Editorial
Description of TRANSFER LENGTH field: "...specified by the READ (10) command."
s/b "specified by the READ (16) command."
RESOLUTION: see 06-216

Status
r/sheffi Completed 7/23/2006 12:35:04 PM

Sequence number: 11
Author: HPQ[RElliott]
Date: 6/21/2006 2:45:22 PM

T 9.7
table 41

READ (10) s/b READ (16)
RESOLUTION: see 06-216

Status
r/sheffi Completed 7/23/2006 12:35:14 PM

Sequence number: 12
Author: HPQ[RElliott]
Subject: Highlight
Date: 6/21/2006 2:45:31 PM

T 9.7
table 41

indicates s/b specifies
RESOLUTION: see 06-216

Status
r/sheffi Completed 7/23/2006 12:35:21 PM

9.8 READ CAPACITY (10) command

9.8.1 READ CAPACITY command overview

The READ CAPACITY (10) command shall request information about the capacity of the block device being addressed.

Table 42 — READ CAPACITY(10) command CDB fields

Field	Description or reference
OPERATION CODE	The SATL shall use ATA IDENTIFY DEVICE information to compute the ATA device's maximum user addressable medium capacity.
LOGICAL BLOCK ADDRESS	If the LOGICAL BLOCK ADDRESS field is not set to zero the SATL shall terminate the command with CHECK CONDITION status with the sense key set to ILLEGAL REQUEST and the additional sense code set to INVALID FIELD IN CDB.
PMI	If the PMI bit is not zero the SATL shall terminate the command with CHECK CONDITION status with the sense key set to ILLEGAL REQUEST and the additional sense code set to INVALID FIELD IN CDB.
CONTROL	6.4

9.8.2 READ CAPACITY data

The SATL shall return READ CAPACITY data as defined by SBC-2. Table 45 describes the translation of fields in the READ CAPACITY data.

Table 43 — READ CAPACITY (10) data

Field	Description or reference
RETURNED LOGICAL BLOCK ADDRESS	Unspecified (see 3.4.3)
BLOCK LENGTH IN BYTES	Unspecified (see 3.4.3)

9.9 READ CAPACITY (16) command

9.9.1 READ CAPACITY (16) command overview

The READ CAPACITY (16) command shall request information about the capacity of the block device being addressed.

Table 44 — READ CAPACITY(16) command CDB fields

Field	Description or reference
OPERATION CODE	The SATL shall use ATA IDENTIFY DEVICE information to compute the ATA device's maximum user addressable medium capacity.
LOGICAL BLOCK ADDRESS	If the LOGICAL BLOCK ADDRESS field is not set to 0000000h the SATL shall terminate the command with CHECK CONDITION status with the sense key set to ILLEGAL REQUEST and the additional sense code set to INVALID FIELD IN CDB.
PMI	If the PMI bit is not zero the SATL shall terminate the command with CHECK CONDITION status with the sense key set to ILLEGAL REQUEST and the additional sense code set to INVALID FIELD IN CDB.
CONTROL	6.4

Sequence number: 1
Author: IBM[GPenokie]
Subject: Underline
Date: 2/16/2006 1:39:55 PM
T9.8.1 READ CAPACITY command overview

Status
rlsheffi Cancelled 4/10/2006 1:40:21 PM

Sequence number: 2
Author: DELL[KMarks]
Subject: Highlight
Date: 6/21/2006 2:46:40 PM
T9.8.1 READ CAPACITY command overview

change subclause title to
"9.8.1 READ CAPACITY (10) command overview"
RESOLUTION: see 06-216

Status
rlsheffi Completed 7/23/2006 12:35:36 PM

Sequence number: 3
Author: HPQ[RElliott]
Subject: Highlight
Date: 6/21/2006 2:54:29 PM
T9.8.1

Change "shall request" to "requests"

RESOLUTION: see 06-216

Status
rlsheffi Completed 7/23/2006 12:36:01 PM

Sequence number: 4
Author: DELL[KMarks]
Subject: Highlight
Date: 6/21/2006 2:54:48 PM
T9.8.1 READ CAPACITY command overview

1st Paragraph
change
"The READ CAPACITY (10) command shall request information about the capacity of the block device being addressed."
to
"The READ CAPACITY (10) command requests information about the capacity of the block device being addressed."

Table 42 shows the translation for fields specified in the READ CAPACITY(10) CDB."

RESOLUTION: see 06-216

Status
rlsheffi Completed 7/23/2006 12:36:18 PM

Sequence number: 5
Author: MXO[MEvans]
Subject: Highlight
Date: 6/21/2006 2:55:05 PM
T9.8.1 READ CAPACITY (10) command overview: change to, "The READ CAPACITY (10) command (see SBC-2) requests that the device server transfer 8 bytes of parameter data describing the capacity and medium format of the direct-access block device to the data-in buffer."
RESOLUTION: s/b
"The READ CAPACITY (10) command (see SBC-2) requests that the device server transfer 8 bytes of parameter data describing the capacity and medium format of the direct-access block device to the application client.

Table 42 shows the translation for fields specified in the READ CAPACITY(10) CDB."
RESOLUTION: see 06-216

9.8 READ CAPACITY (10) command

9.8.1 READ CAPACITY command overview

The READ CAPACITY (10) command shall request information about the capacity of the block device being addressed.

Table 42 — READ CAPACITY(10) command CDB fields

Field	Description or reference
OPERATION CODE	The SATL shall use ATA IDENTIFY DEVICE information to compute the ATA device's maximum user addressable medium capacity.
LOGICAL BLOCK ADDRESS	If the LOGICAL BLOCK ADDRESS field is not set to 11 the SATL shall terminate the command with CHECK CONDITION status with the sense key set to ILLEGAL REQUEST and the additional sense code set to INVALID FIELD IN CDB.
PMI	If the PMI bit is not zero the SATL shall terminate the command with CHECK CONDITION status with the sense key set to ILLEGAL REQUEST and the additional sense code set to INVALID FIELD IN CDB.
CONTROL	6.4

9.8.2 READ CAPACITY data

The SATL shall return READ CAPACITY data as defined by SBC-2. Table 45 describes the translation of fields in the READ CAPACITY data.

Table 43 — READ CAPACITY (10) data

Field	Description or reference
RETURNED LOGICAL BLOCK ADDRESS	Unspecified (see 3.4.3)
BLOCK LENGTH IN BYTES	Unspecified (see 3.4.3)

9.9 READ CAPACITY (16) command

9.9.1 READ CAPACITY (16) command overview

The READ CAPACITY (16) command shall request information about the capacity of the block device being addressed.

Table 44 — READ CAPACITY(16) command CDB fields

Field	Description or reference
OPERATION CODE	The SATL shall use ATA IDENTIFY DEVICE information to compute the ATA device's maximum user addressable medium capacity.
LOGICAL BLOCK ADDRESS	If the LOGICAL BLOCK ADDRESS field is not set to 0000000h the SATL shall terminate the command with CHECK CONDITION status with the sense key set to ILLEGAL REQUEST and the additional sense code set to INVALID FIELD IN CDB.
PMI	If the PMI bit is not zero the SATL shall terminate the command with CHECK CONDITION status with the sense key set to ILLEGAL REQUEST and the additional sense code set to INVALID FIELD IN CDB.
CONTROL	6.4

Status
risheffi Completed 7/23/2006 12:36:36 PM

Sequence number: 6
Author: HPQ[RElliott]
Subject: Note
Date: 6/21/2006 2:55:18 PM
9.8.1

Add a reference to table 42

RESOLUTION: see 06-216

Status
risheffi Completed 7/23/2006 12:36:48 PM

Sequence number: 7
Author: HPQ[RElliott]
Subject: Highlight
Date: 7/23/2006 12:38:05 PM
9.8.1

use space or not
RESOLUTION: Add a space. see 06-216 (done in SAT-r08c)

Status
risheffi Completed 7/23/2006 12:38:09 PM

Sequence number: 8
Author: IBM[GPenokie]
Subject: Highlight
Date: 6/21/2006 2:56:12 PM
There is no reference to table 42. This needs to be fixed as all tables have to be referenced.

RESOLUTION: see 06-216

Status
risheffi Completed 7/23/2006 12:38:21 PM

Sequence number: 9
Author: HPQ[RElliott]
Subject: Highlight
Date: 6/21/2006 3:05:10 PM
9.8.1

table 42

"IDENTIFY DEVICE information" s/b "IDENTIFY DEVICE data"

RESOLUTION: see 06-216

Status
risheffi Completed 7/23/2006 12:38:53 PM

Sequence number: 10
Author: DELL[KMarks]
Subject: Highlight
Date: 6/21/2006 3:05:00 PM
Table 42 — READ CAPACITY(10) command CDB fields

Row: OPERATION CODE
change
"The SATL shall use ATA IDENTIFY DEVICE information to compute the ATA device's maximum user addressable medium capacity."
to
"The SATL shall use ATA IDENTIFY DEVICE data to compute the maximum user addressable medium capacity of the ATA device"
RESOLUTION: see 06-216

Status
risheffi Completed 7/23/2006 12:39:10 PM

Sequence number: 11
Author: HPQ[RElliott]

9.8 READ CAPACITY (10) command

9.8.1 READ CAPACITY command overview

The READ CAPACITY (10) command shall request information about the capacity of the block device being addressed.



Table 42 — READ CAPACITY(10) command CDB fields

Field	Description or reference
OPERATION CODE	The SATL shall use ATA IDENTIFY DEVICE information to compute the ATA device's maximum user addressable medium capacity.
LOGICAL BLOCK ADDRESS	If the LOGICAL BLOCK ADDRESS field is not ¹² to zero the SATL shall terminate the command with CHECK CONDITION status with the sense key set to ILLEGAL REQUEST and the additional sense code set to INVALID FIELD IN CDB.
PMI	¹⁴ If the PMI bit is ¹³ zero the SATL shall terminate the command with CHECK CONDITION status with the sense key set to ILLEGAL REQUEST and the additional sense code set to INVALID FIELD IN CDB.
CONTROL	6.4

¹⁵3.2 READ CAPACITY data

The SATL shall return READ CAPACITY data as defined by SBC-2. Table 45 describes the translation of fields in the READ CAPACITY data.

Table 43 — READ CAPACITY (10) data

Field	Description or reference
RETURNED LOGICAL BLOCK ADDRESS	Unspecified (see 3.4.3)
BLOCK LENGTH IN BYTES	Unspecified (see 3.4.3)

9.9 READ CAPACITY (16) command

9.9.1 READ CAPACITY (16) command overview

The READ CAPACITY (16) command shall request information about the capacity of the block device being addressed.



Table 44 — READ CAPACITY(16) command CDB fields

Field	Description or reference
OPERATION CODE	The SATL shall use ATA IDENTIFY DEVICE information to compute the ATA device's maximum user addressable medium capacity.
LOGICAL BLOCK ADDRESS	If the LOGICAL BLOCK ADDRESS field is not set to 0000000h the SATL shall terminate the command with CHECK CONDITION status with the sense key set to ILLEGAL REQUEST and the additional sense code set to INVALID FIELD IN CDB.
PMI	If the PMI bit is not zero the SATL shall terminate the command with CHECK CONDITION status with the sense key set to ILLEGAL REQUEST and the additional sense code set to INVALID FIELD IN CDB.
CONTROL	6.4



Subject: Highlight
Date: 6/21/2006 3:09:16 PM

T9.9.1
Table 44

Change "zero" to "0000000h", if numbers are chosen for table 44 for READ CAPACITY (16) parameter data. If "zero" is chosen there, then leave this as is.

RESOLUTION: Leave as is, and change the "000000h" in table 44 to "zero", see 06-216

Status
rlsheffi Completed 7/23/2006 12:39:49 PM

Sequence number: 12
Author: DELL[KMarks]
Subject: Highlight
Date: 6/21/2006 3:08:54 PM

TTable 42 — READ CAPACITY(10) command CDB fields
Row: LOGICAL BLOCK ADDRESS

1st Sentence
"...set to zero the SATL..."
to
"...set to 0h the SATL..."

REASON: See HPQ comment
RESOLUTION: see 06-216

Status
rlsheffi Rejected 4/29/2006 4:58:56 PM

Sequence number: 13
Author: HPQ[RElliott]
Subject: Highlight
Date: 6/21/2006 3:24:28 PM

T9.8.1
table 42

"not zero" s/b "not set to zero"
RESOLUTION: see 06-216

Status
rlsheffi Completed 7/23/2006 12:40:10 PM

Sequence number: 14
Author: DELL[KMarks]
Subject: Highlight
Date: 6/21/2006 3:11:54 PM

TTable 42 — READ CAPACITY(10) command CDB fields
Row: PMI

change
"If the PMI bit is not zero the SATL shall terminate the command with CHECK CONDITION status with the sense key set to ILLEGAL REQUEST and the additional sense code set to INVALID FIELD IN CDB."
to
"If the PMI bit is not set to zero the SATL shall terminate the command with CHECK CONDITION status with the sense key set to ILLEGAL REQUEST and the additional sense code set to INVALID FIELD IN CDB."
or
"Shall be set to zero"

RESOLUTION: see 06-216, s/b
"If the PMI bit is not set to zero the SATL shall terminate the command with CHECK CONDITION status with the sense key set to ILLEGAL REQUEST and the additional sense code set to INVALID FIELD IN CDB."

Status
rlsheffi Completed 7/23/2006 12:40:34 PM

Sequence number: 15
Author: IBM[GPenokie]
Subject: Underline
Date: 2/16/2006 1:42:24 PM
T9.8.2 READ CAPACITY data

Comments from page 72 continued on next page

9.8 READ CAPACITY (10) command

9.8.1 READ CAPACITY command overview

The READ CAPACITY (10) command shall request information about the capacity of the block device being addressed.

Table 42 — READ CAPACITY(10) command CDB fields

Field	Description or reference
OPERATION CODE	The SATL shall use ATA IDENTIFY DEVICE information to compute the ATA device's maximum user addressable medium capacity.
LOGICAL BLOCK ADDRESS	If the LOGICAL BLOCK ADDRESS field is not set to zero the SATL shall terminate the command with CHECK CONDITION status with the sense key set to ILLEGAL REQUEST and the additional sense code set to INVALID FIELD IN CDB.
PMI	If the PMI bit is not zero the SATL shall terminate the command with CHECK CONDITION status with the sense key set to ILLEGAL REQUEST and the additional sense code set to INVALID FIELD IN CDB.
CONTROL	6.4

9.8.2 READ CAPACITY data

The SATL shall return READ CAPACITY data as defined by SBC-1420. Table 45 describes the translation of fields in the READ CAPACITY data.

Table 43 — READ CAPACITY (10) data

Field	Description or reference
RETURNED LOGICAL BLOCK ADDRESS	21 specified (see 3.4.3)
BLOCK LENGTH IN BYTES	Unspecified (see 3.4.3)

9.9 READ CAPACITY (16) command

9.9.1 READ CAPACITY (16) command overview

The READ CAPACITY (16) command shall request information about the capacity of the block device being addressed.

Table 44 — READ CAPACITY(16) command CDB fields

Field	Description or reference
OPERATION CODE	The SATL shall use ATA IDENTIFY DEVICE information to compute the ATA device's maximum user addressable medium capacity.
LOGICAL BLOCK ADDRESS	If the LOGICAL BLOCK ADDRESS field is not set to 0000000h the SATL shall terminate the command with CHECK CONDITION status with the sense key set to ILLEGAL REQUEST and the additional sense code set to INVALID FIELD IN CDB.
PMI	If the PMI bit is not zero the SATL shall terminate the command with CHECK CONDITION status with the sense key set to ILLEGAL REQUEST and the additional sense code set to INVALID FIELD IN CDB.
CONTROL	6.4

Status
rlsheffi Cancelled 4/29/2006 5:00:35 PM

Sequence number: 16
Author: HPQ[RElliott]
Subject: Highlight
Date: 6/21/2006 3:12:34 PM
T 9.8.2

"READ CAPACITY data" s/b "READ CAPACITY (10) parameter data" in the header, paragraph, and table 33 title

RESOLUTION: see 06-216

Status
rlsheffi Completed 7/23/2006 12:40:56 PM

Sequence number: 17
Author: HPQ[RElliott]
Subject: Highlight
Date: 6/21/2006 3:24:45 PM
T 9.8.2

"Table 45 describes" s/b "Table 43 describes"

RESOLUTION: see 06-216

Status
rlsheffi Completed 7/23/2006 12:41:22 PM

Sequence number: 18
Author: STX[GHolder]
Subject: Highlight
Date: 6/21/2006 3:24:57 PM
T PDF page 72

section 9.8.2, sentence 2
change 'Table 45' to 'Table 43'

RESOLUTION: see 06-216

Status
rlsheffi Completed 7/23/2006 12:41:36 PM

Sequence number: 19
Author: IBM[GPenokie]
Subject: Highlight
Date: 6/21/2006 3:25:10 PM
T 1st paragraph

This << SBC-2. Table 45 describes the translation of >> should be << SBC-2. Table 43 describes the translation of >>

RESOLUTION: see 06-216

Status
rlsheffi Completed 7/23/2006 12:41:59 PM

Sequence number: 20
Author: DELL[KMarks]
Subject: Highlight
Date: 6/21/2006 3:25:46 PM
T 9.8.2 READ CAPACITY data

1st Paragraph, 2nd Sentence
change

"Table 45 describes the translation of fields in the READ CAPACITY data."

to

"Table 43 describes the translation of fields in the READ CAPACITY data."

RESOLUTION: see 06-216

Status
rlsheffi Completed 7/23/2006 12:42:07 PM

Sequence number: 21
Author: HPQ[RElliott]
Subject: Highlight
Date: 6/21/2006 3:39:33 PM
T 9.8.2

Table 43

Comments from page 72 continued on next page

9.8 READ CAPACITY (10) command

9.8.1 READ CAPACITY command overview

The READ CAPACITY (10) command shall request information about the capacity of the block device being addressed.

Table 42 — READ CAPACITY(10) command CDB fields

Field	Description or reference
OPERATION CODE	The SATL shall use ATA IDENTIFY DEVICE information to compute the ATA device's maximum user addressable medium capacity.
LOGICAL BLOCK ADDRESS	If the LOGICAL BLOCK ADDRESS field is not set to zero the SATL shall terminate the command with CHECK CONDITION status with the sense key set to ILLEGAL REQUEST and the additional sense code set to INVALID FIELD IN CDB.
PMI	If the PMI bit is not zero the SATL shall terminate the command with CHECK CONDITION status with the sense key set to ILLEGAL REQUEST and the additional sense code set to INVALID FIELD IN CDB.
CONTROL	6.4

9.8.2 READ CAPACITY data

The SATL shall return READ CAPACITY data as defined by SBC-2. Table 45 describes the translation of fields in the READ CAPACITY data.

Table 43 — READ CAPACITY (10) data

Field	Description or reference
RETURNED LOGICAL BLOCK ADDRESS	Unspecified (see 3.4.3)
BLOCK LENGTH IN BYTES	²³ specified (see 3.4.3)

9.9 READ CAPACITY (16) command

²⁴9.9.1 READ CAPACITY (16) command overview

²⁶The READ CAPACITY (16) command ²⁵shall request information about the capacity of the block device being addressed.

Table 44 — READ CAPACITY(16) command CDB fields

Field	Description or reference
OPERATION CODE	The SATL shall use ATA IDENTIFY DEVICE information to compute the ATA device's maximum user addressable medium capacity.
LOGICAL BLOCK ADDRESS	If the LOGICAL BLOCK ADDRESS field is not set to 0000000h the SATL shall terminate the command with CHECK CONDITION status with the sense key set to ILLEGAL REQUEST and the additional sense code set to INVALID FIELD IN CDB.
PMI	If the PMI bit is not zero the SATL shall terminate the command with CHECK CONDITION status with the sense key set to ILLEGAL REQUEST and the additional sense code set to INVALID FIELD IN CDB.
CONTROL	6.4

For RETURNED LOGICAL BLOCK ADDRESS, change "Unspecified (see 3.4.3)" to "The SATL shall set this field based on IDENTIFY DEVICE data words 61:60 (i.e., Total number of user addressable sectors) and words 103:100 (i.e., Maximum user LBA for 48-bit Address feature set)"

Include a description of what to do if the value is too big to fit in the field.

RESOLUTION: see 06-216

Status
risheffi Completed 7/23/2006 12:43:43 PM

Sequence number: 22
Author: DELL[KMarks]
Subject: Highlight
Date: 6/21/2006 4:02:42 PM

T Table 43 — READ CAPACITY (10) data
Row: BLOCK LENGTH IN BYTES

The mode page block descriptors says that the BLOCK LENGTH field shall be 512, how can this be Unspecified then?

RESOLUTION: see 06-216

Status
risheffi Completed 7/23/2006 12:44:08 PM

Sequence number: 23
Author: HPQ[RElliott]
Subject: Highlight
Date: 6/21/2006 4:03:13 PM

T 9.8.2
Table 43

For BLOCK LENGTH IN BYTES, change "Unspecified (see 3.4.3)" to "The SATL shall set this field based on IDENTIFY DEVICE words 117-118 (i.e., Logical Sector Size)" perhaps noting how the ATA field is in units of words while the SCSI field is in units of bytes.

RESOLUTION: see 06-216

Status
risheffi Completed 7/23/2006 12:44:29 PM

Sequence number: 24
Author: IBM[GPenokie]
Subject: Underline
Date: 2/16/2006 1:44:14 PM

T 9.9.1 READ CAPACITY (16) command overview

Status
risheffi Cancelled 5/1/2006 9:26:38 AM

Sequence number: 25
Author: HPQ[RElliott]
Subject: Highlight
Date: 6/21/2006 4:08:38 PM

T 9.9.1

Change "shall request" to "requests"

RESOLUTION: see 06-216

Status
risheffi Completed 7/23/2006 12:45:07 PM

Sequence number: 26
Author: DELL[KMarks]
Subject: Highlight
Date: 6/21/2006 4:09:03 PM

T 9.9.1 READ CAPACITY command overview

1st Paragraph
change

"The READ CAPACITY (16) command shall request information about the capacity of the block device being addressed."

Comments from page 72 continued on next page

9.8 READ CAPACITY (10) command

9.8.1 READ CAPACITY command overview

The READ CAPACITY (10) command shall request information about the capacity of the block device being addressed.



Table 42 — READ CAPACITY(10) command CDB fields

Field	Description or reference
OPERATION CODE	The SATL shall use ATA IDENTIFY DEVICE information to compute the ATA device's maximum user addressable medium capacity.
LOGICAL BLOCK ADDRESS	If the LOGICAL BLOCK ADDRESS field is not set to zero the SATL shall terminate the command with CHECK CONDITION status with the sense key set to ILLEGAL REQUEST and the additional sense code set to INVALID FIELD IN CDB.
PMI	If the PMI bit is not zero the SATL shall terminate the command with CHECK CONDITION status with the sense key set to ILLEGAL REQUEST and the additional sense code set to INVALID FIELD IN CDB.
CONTROL	6.4

9.8.2 READ CAPACITY data

The SATL shall return READ CAPACITY data as defined by SBC-2. Table 45 describes the translation of fields in the READ CAPACITY data.

Table 43 — READ CAPACITY (10) data

Field	Description or reference
RETURNED LOGICAL BLOCK ADDRESS	Unspecified (see 3.4.3)
BLOCK LENGTH IN BYTES	Unspecified (see 3.4.3)

9.9 READ CAPACITY (16) command

9.9.1 READ CAPACITY (16) command overview

The READ CAPACITY (16) command shall request information about the capacity of the block device being addressed.



Table 44 — READ CAPACITY(16) command CDB fields

Field	Description or reference
OPERATION CODE	The SATL shall use ATA IDENTIFY DEVICE information to compute the ATA device's maximum user addressable medium capacity.
LOGICAL BLOCK ADDRESS	If the LOGICAL BLOCK ADDRESS field is not set to 0000000h the SATL shall terminate the command with CHECK CONDITION status with the sense key set to ILLEGAL REQUEST and the additional sense code set to INVALID FIELD IN CDB.
PMI	If the PMI bit is not zero the SATL shall terminate the command with CHECK CONDITION status with the sense key set to ILLEGAL REQUEST and the additional sense code set to INVALID FIELD IN CDB.
CONTROL	6.4



to
"The READ CAPACITY (16) command requests information about the capacity of the block device being addressed.

Table 44 shows the translation for fields specified in the READ CAPACITY(16) CDB."
RESOLUTION: see 06-216

Status
risheffi Completed 7/23/2006 12:45:21 PM

Sequence number: 27
Author: MXO[MEvans]
Subject: Highlight
Date: 6/21/2006 4:09:26 PM

T 9.9.1 READ CAPACITY (16) command overview: change to, "The READ CAPACITY (16) command (see SBC-2) requests that the device server transfer parameter data describing the capacity and medium format of the direct-access block device to the data-in buffer."
RESOLUTION: s/b
"The READ CAPACITY (16) command (see SBC-2) requests that the device server transfer parameter data describing the capacity and medium format of the direct-access block device to the data-in buffer.

Table 44 shows the translation for fields specified in the READ CAPACITY(16) CDB."
RESOLUTION: see 06-216

Status
risheffi Completed 7/23/2006 12:45:31 PM

Sequence number: 28
Author: HPQ[RElliott]
Subject: Note
Date: 6/21/2006 4:09:41 PM

T 9.8.1

Add a reference to table 44

RESOLUTION: see 06-216

Status
risheffi Completed 7/23/2006 12:45:40 PM

Sequence number: 29
Author: IBM[GPenokie]
Subject: Highlight
Date: 6/21/2006 4:09:57 PM

T There is no reference to table 44. This needs to be fixed as all tables have to be referenced.
RESOLUTION: see 06-216

Status
risheffi Completed 7/23/2006 12:45:49 PM

Sequence number: 30
Author: HPQ[RElliott]
Subject: Highlight
Date: 6/21/2006 4:20:11 PM

T 9.9.1
table 44

"IDENTIFY DEVICE information" s/b "IDENTIFY DEVICE data"

RESOLUTION: see 06-216

Status
risheffi Completed 7/23/2006 12:46:03 PM

Sequence number: 31
Author: DELL[KMarks]
Subject: Highlight
Date: 6/21/2006 4:20:18 PM

T Table 44 — READ CAPACITY(16) command CDB fields
Row: OPERATION CODE
change

"The SATL shall use ATA IDENTIFY DEVICE information to compute the ATA device's maximum user addressable medium

9.8 READ CAPACITY (10) command

9.8.1 READ CAPACITY command overview

The READ CAPACITY (10) command shall request information about the capacity of the block device being addressed.



Table 42 — READ CAPACITY(10) command CDB fields

Field	Description or reference
OPERATION CODE	The SATL shall use ATA IDENTIFY DEVICE information to compute the ATA device's maximum user addressable medium capacity.
LOGICAL BLOCK ADDRESS	If the LOGICAL BLOCK ADDRESS field is not set to zero the SATL shall terminate the command with CHECK CONDITION status with the sense key set to ILLEGAL REQUEST and the additional sense code set to INVALID FIELD IN CDB.
PMI	If the PMI bit is not zero the SATL shall terminate the command with CHECK CONDITION status with the sense key set to ILLEGAL REQUEST and the additional sense code set to INVALID FIELD IN CDB.
CONTROL	6.4

9.8.2 READ CAPACITY data

The SATL shall return READ CAPACITY data as defined by SBC-2. Table 45 describes the translation of fields in the READ CAPACITY data.

Table 43 — READ CAPACITY (10) data

Field	Description or reference
RETURNED LOGICAL BLOCK ADDRESS	Unspecified (see 3.4.3)
BLOCK LENGTH IN BYTES	Unspecified (see 3.4.3)

9.9 READ CAPACITY (16) command

9.9.1 READ CAPACITY (16) command overview

The READ CAPACITY (16) command shall request information about the capacity of the block device being addressed.



Table 44 — READ CAPACITY(16) command CDB fields



Field	Description or reference
³² OPERATION CODE	The SATL shall use ATA IDENTIFY DEVICE information to compute the ATA device's maximum user addressable medium capacity.
LOGICAL BLOCK ADDRESS	If the LOGICAL BLOCK ADDRESS field is not set to ³⁵ 00000h the SATL shall terminate the command with CHECK CONDITION status with the sense key set to ILLEGAL REQUEST and the additional sense code set to INVALID FIELD IN CDB.
PMI	If the PMI bit is not zero the SATL shall terminate the command with CHECK CONDITION status with the sense key set to ILLEGAL REQUEST and the additional sense code set to INVALID FIELD IN CDB.
CONTROL	6.4

capacity."

to

"The SATL shall use ATA IDENTIFY DEVICE data to compute the maximum user addressable medium capacity of the ATA device"

RESOLUTION: see 06-216

Status
risheffi Completed 7/23/2006 12:46:30 PM

Sequence number: 32
Author: HPQ[RElliott]
Subject: Note
Date: 6/21/2006 4:23:39 PM
9.9.1
Table 44

Add row for ALLOCATION LENGTH field, as "Unspecified (see 3.4.3)"
RESOLUTION: see 06-216

Status
risheffi Completed 7/23/2006 12:46:44 PM

Sequence number: 33
Author: HPQ[RElliott]
Subject: Highlight
Date: 6/21/2006 4:41:14 PM
9.9.1
table 44

OPERATION CODE is actually a combination of two fields for this command: OPERATION CODE (9Eh) and SERVICE ACTION (10h). Since they are closely related, put them in the same cell, or leave them in separate rows but straddle the description so it is shared between them.

RESOLUTION: see 06-216

Status
risheffi Completed 7/23/2006 12:47:20 PM

Sequence number: 34
Author: DELL[KMarks]
Subject: Highlight
Date: 6/21/2006 4:41:48 PM
Table 44 — READ CAPACITY(16) command CDB fields
Row: LOGICAL BLOCK ADDRESS

"0000000h"
to
"0h"
or
"0000_0000h"

RESOLUTION: see 06-216 "0000000h" s/b "zero"

Status
risheffi Completed 7/23/2006 12:47:35 PM

Sequence number: 35
Author: HPQ[RElliott]
Subject: Highlight
Date: 6/21/2006 4:42:03 PM
9.9.1
Table 44

Change "0000000h" to "00000000_00000000h" or "zero". Match the style used in table 42 for READ CAPACITY (10) parameter data.

RESOLUTION: see 06-216 - change to "zero"

Status

9.8 READ CAPACITY (10) command

9.8.1 READ CAPACITY command overview

The READ CAPACITY (10) command shall request information about the capacity of the block device being addressed.

Table 42 — READ CAPACITY(10) command CDB fields

Field	Description or reference
OPERATION CODE	The SATL shall use ATA IDENTIFY DEVICE information to compute the ATA device's maximum user addressable medium capacity.
LOGICAL BLOCK ADDRESS	If the LOGICAL BLOCK ADDRESS field is not set to zero the SATL shall terminate the command with CHECK CONDITION status with the sense key set to ILLEGAL REQUEST and the additional sense code set to INVALID FIELD IN CDB.
PMI	If the PMI bit is not zero the SATL shall terminate the command with CHECK CONDITION status with the sense key set to ILLEGAL REQUEST and the additional sense code set to INVALID FIELD IN CDB.
CONTROL	6.4

9.8.2 READ CAPACITY data

The SATL shall return READ CAPACITY data as defined by SBC-2. Table 45 describes the translation of fields in the READ CAPACITY data.

Table 43 — READ CAPACITY (10) data

Field	Description or reference
RETURNED LOGICAL BLOCK ADDRESS	Unspecified (see 3.4.3)
BLOCK LENGTH IN BYTES	Unspecified (see 3.4.3)

9.9 READ CAPACITY (16) command

9.9.1 READ CAPACITY (16) command overview

The READ CAPACITY (16) command shall request information about the capacity of the block device being addressed.

Table 44 — READ CAPACITY(16) command CDB fields

Field	Description or reference
OPERATION CODE	The SATL shall use ATA IDENTIFY DEVICE information to compute the ATA device's maximum user addressable medium capacity.
LOGICAL BLOCK ADDRESS	If the LOGICAL BLOCK ADDRESS field is not set to 0000000h the SATL shall terminate the command with CHECK CONDITION status with the sense key set to ILLEGAL REQUEST and the additional sense code set to INVALID FIELD IN CDB.
PMI	If the PMI bit is zero the SATL shall terminate the command with CHECK CONDITION status with the sense key set to ILLEGAL REQUEST and the additional sense code set to INVALID FIELD IN CDB.
CONTROL	6.4

risheffi Completed

7/23/2006 12:47:56 PM

Sequence number: 36
Author: HPQ[RElliott]
Subject: Highlight
Date: 6/24/2006 2:28:39 PM

T 9.9.1

Table 44

"not zero" s/b "not set to zero"

RESOLUTION: see 06-216 and DELL comment

Status

risheffi Completed

7/23/2006 12:48:11 PM

Sequence number: 37
Author: DELL[KMarks]
Subject: Highlight
Date: 6/21/2006 4:42:34 PM

T Table 44 — READ CAPACITY(16) command CDB fields

Row: PMI

change

"If the PMI bit is not zero the SATL shall terminate the command with CHECK CONDITION status with the sense key set to ILLEGAL REQUEST and the additional sense code set to INVALID FIELD IN CDB."

to

"If the PMI bit is not set to zero the SATL shall terminate the command with CHECK CONDITION status with the sense key set to ILLEGAL REQUEST and the additional sense code set to INVALID FIELD IN CDB."

or

"Shall be set to zero"

RESOLUTION: see 06-216

Status

risheffi Completed

7/23/2006 12:48:43 PM

9.9.2 **1** READ CAPACITY data

The SATL shall return READ CAPACITY data as defined by SBC-2. Table 45 describes the translation of fields in the READ CAPACITY data.

Table 45 — READ CAPACITY (16) data

Field	Description or reference
RETURNED LOGICAL BLOCK ADDRESS	2 Unspecified (see 3.4.3)
BLOCK LENGTH IN BYTES	4 Unspecified (see 3.4.3)
RTO_EN	5 Unspecified (see 3.4.3)
PROT_EN	Unspecified (see 3.4.3)

9.10 REASSIGN BLOCKS command

9.10.1 REASSIGN BLOCKS command overview

The REASSIGN BLOCKS command requests that the SATL reassign defective logical blocks (see SBC-2). ATA devices do not support or have a direct translation for the REASSIGN BLOCKS command. The SATL shall emulate the ~~SCSI~~ REASSIGN BLOCKS command as defined in table 46.

Table 46 — REASSIGN BLOCKS command CDB fields

Field	Description or reference
OPERATION CODE	9.10.2
LONGLBA	See SBC-2
LONGLIST	See SBC-2
CONTROL	6.4

The REASSIGN BLOCKS command parameter list provided in the data-out buffer contains the LBAs to be reassigned. The LBAs provided in the parameter list shall be utilized for the LBAs in any ATA verify commands (see 3.1.17) or ATA write commands (see 3.1.18) issued by the SATL.

The SATL shall support the LONGLBA field and the LONGLIST field (see SBC-2).

9.10.2 REASSIGN BLOCKS operation code

The SATL shall accept a parameter list specifying LBAs to be reassigned (see SBC-2). For each LBA in the parameter list, the SATL shall:

- 1) issue an ATA verify command (see 3.1.17) to the specified LBA;
- 2) if the ATA verify command completes successfully, then the SATL shall return GOOD status for the REASSIGN BLOCKS command;
- 3) if the ATA verify command does not complete successfully, then the SATL shall Issue an ATA write command (see 3.1.18) with vendor-specific data to the LBA that failed the ATA verify command;
- 4) if the ATA write command fails, then the SATL shall terminate the REASSIGN BLOCKS command with CHECK CONDITION status with the sense key set to HARDWARE ERROR and the additional sense code set to WRITE ERROR – AUTO REALLOCATION FAILED;
- 5) if the write command completes successfully, then the SATL shall issue a second ATA verify command to the same LBA;
- 6) if the second ATA verify command completes successfully, then the SATL shall return GOOD status for the REASSIGN BLOCKS command; and
- 7) if the second ATA verify command does not complete successfully, then the SATL shall terminate the REASSIGN BLOCKS command with CHECK CONDITION status with the sense key set to MEDIUM

Page: 73

Sequence number: 1
Author: HPQ[RElliott]
Subject: Highlight
Date: 6/21/2006 4:42:50 PM

T 9.9.2

"READ CAPACITY data" s/b "READ CAPACITY (16) parameter data" in the header, paragraph, and table 45 title

RESOLUTION: see 06-216

Status
risheffi Completed 7/23/2006 12:48:59 PM

Sequence number: 2
Author: HPQ[RElliott]
Subject: Highlight
Date: 6/21/2006 4:43:43 PM

T 9.9.2
table 45

Apply same changes as done to the RETURNED LOGICAL BLOCK ADDRESS row in table 42

Note - (May '06): Could base on the total byte capacity (i.e., calculated capacity in bytes reported here s/b less than or equal to the capacity in bytes calculated from IDENTIFY DEVICE data).

RESOLUTION: see 06-216

Status
risheffi Completed 7/23/2006 12:51:23 PM

Sequence number: 3
Author: DELL[KMarks]
Subject: Highlight
Date: 6/21/2006 4:44:15 PM

T Table 43 — READ CAPACITY (16) data
Row: BLOCK LENGTH IN BYTES

The mode page block descriptors say that the BLOCK LENGTH shall be 512, how can this be Unspecified then?

RESOLUTION: see 06-216

Status
risheffi Completed 7/23/2006 12:51:43 PM

Sequence number: 4
Author: HPQ[RElliott]
Subject: Highlight
Date: 7/12/2006 8:27:03 PM

T 9.9.2
table 45

Apply same changes as done to the BLOCK LENGTH IN BYTES row in table 42

RESOLUTION: see 06-216

Status
risheffi Completed 7/23/2006 12:51:55 PM

Sequence number: 5
Author: DELL[KMarks]
Subject: Highlight
Date: 5/3/2006 12:26:34 PM

T Table 45 — READ CAPACITY (16) data
Row: RTO_EN

This field can not be set to Unspecified, because the PROTECT bit in the INQUIRY data is a shall be set to zero. Change

Comments from page 73 continued on next page

9.9.2 READ CAPACITY data

The SATL shall return READ CAPACITY data as defined by SBC-2. Table 45 describes the translation of fields in the READ CAPACITY data.

Table 45 — READ CAPACITY (16) data

Field	Description or reference
RETURNED LOGICAL BLOCK ADDRESS	Unspecified (see 3.4.3)
BLOCK LENGTH IN BYTES	Unspecified (see 3.4.3)
RTO_EN	Unspecified (see 3.4.3)
PROT_EN	Unspecified (see 3.4.3)

9.10 REASSIGN BLOCKS command

9.10.1 REASSIGN BLOCKS command overview

The REASSIGN BLOCKS command requests that the SATL reassign defective logical blocks (see SBC-2). ATA devices do not support or have a direct translation for the REASSIGN BLOCKS command. The SATL shall emulate the ~~ZCSI~~ REASSIGN BLOCKS command as defined in table 46.

Table 46 — REASSIGN BLOCKS command CDB fields

Field	Description or reference
OPERATION CODE	9.10.2
LONGLBA	See SBC-2
LONGLIST	See SBC-2
CONTROL	6.4

The REASSIGN BLOCKS command parameter list provided in the data-out buffer contains the LBAs to be reassigned. The LBAs provided in the parameter list shall be utilized for the LBAs in any ATA verify commands (see 3.1.17) or ATA write commands (see 3.1.18) issued by the SATL.

The SATL shall support the LONGLBA field and the LONGLIST field (see SBC-2).

9.10.2 REASSIGN BLOCKS operation code

The SATL shall accept a parameter list specifying LBAs to be reassigned (see SBC-2). For each LBA in the parameter list, the SATL shall:

- 1) issue an ATA verify command (see 3.1.17) to the specified LBA;
- 2) if the ATA verify command completes successfully, then the SATL shall return GOOD status for the REASSIGN BLOCKS command;
- 3) if the ATA verify command does not complete successfully, then the SATL shall issue an ATA write command (see 3.1.18) with vendor-specific data to the LBA that failed the ATA verify command;
- 4) if the ATA write command fails, then the SATL shall terminate the REASSIGN BLOCKS command with CHECK CONDITION status with the sense key set to HARDWARE ERROR and the additional sense code set to WRITE ERROR – AUTO REALLOCATION FAILED;
- 5) if the write command completes successfully, then the SATL shall issue a second ATA verify command to the same LBA;
- 6) if the second ATA verify command completes successfully, then the SATL shall return GOOD status for the REASSIGN BLOCKS command; and
- 7) if the second ATA verify command does not complete successfully, then the SATL shall terminate the REASSIGN BLOCKS command with CHECK CONDITION status with the sense key set to MEDIUM

the PROTECT bit to Unspecified or change this field to shall be set to zero.

RESOLUTION: Change the PROTECT bit in the INQUIRY data to "Unspecified (see 3.4.3) per SIERLGC comment in 8.1.2.

Status
risheffi Completed 6/21/2006 4:45:29 PM

Sequence number: 6
Author: DELL[KMarks]
Subject: Highlight
Date: 5/3/2006 12:26:57 PM

T Table 45 — READ CAPACITY (16) data
Row: PROT_EN

This field can not be set to Unspecified, because the PROTECT bit in the INQUIRY data is a shall be set to zero. Change the PROTECT bit to Unspecified or change this field to shall be set to zero.

RESOLUTION: Change the PROTECT bit in the INQUIRY data to "Unspecified (see 3.4.3) per SIERLGC comment in 8.1.2.

Status
risheffi Completed 6/21/2006 4:45:40 PM

Sequence number: 7
Author: DELL[KMarks]
Subject: Cross-Out
Date: 6/21/2006 4:46:12 PM

T SCSI
RESOLUTION: see 06-216

Status
risheffi Completed 7/23/2006 12:52:42 PM

Sequence number: 8
Author: DELL[KMarks]
Subject: Highlight
Date: 7/23/2006 12:55:22 PM

T 1st two paragraphs after Table 46 — REASSIGN BLOCKS command CDB fields

change

"The REASSIGN BLOCKS command parameter list provided in the data-out buffer contains the LBAs to be reassigned. The LBAs provided in the parameter list shall be utilized for the LBAs in any ATA verify commands(see 3.1.17) or ATA write commands (see 3.1.18) issued by the SATL.

The SATL shall support the LONGLBA field and the LONGLIST field (see SBC-2)."

to

"The REASSIGN BLOCKS command parameter list transferred from the application client contains the LBAs to be reassigned. The LBAs provided in the parameter list shall be utilized for the ATA LBAs in any ATA verify commands(see 3.1.17) or ATA write commands (see 3.1.18) issued by the SATL.

The SATL shall support the LONGLBA and LONGLIST bits (see SBC-2)."

data-out /data-in buffer is not used in all the other commands, so why here.

RESOLUTION: see 06-216 - s/b

"The REASSIGN BLOCKS command parameter list transferred from the application client contains the LBAs of logical blocks to be reassigned.

<text for direct and indirect block mapping - see 06-216r2>

The SATL shall support the LONGLBA bit and the LONGLIST bit (see SBC-2)."

Status
risheffi Completed 7/23/2006 12:55:27 PM

Sequence number: 9

Comments from page 73 continued on next page

9.9.2 READ CAPACITY data

The SATL shall return READ CAPACITY data as defined by SBC-2. Table 45 describes the translation of fields in the READ CAPACITY data.

Table 45 — READ CAPACITY (16) data

Field	Description or reference
RETURNED LOGICAL BLOCK ADDRESS	Unspecified (see 3.4.3)
BLOCK LENGTH IN BYTES	Unspecified (see 3.4.3)
RTO_EN	Unspecified (see 3.4.3)
PROT_EN	Unspecified (see 3.4.3)

9.10 REASSIGN BLOCKS command

9.10.1 REASSIGN BLOCKS command overview

The REASSIGN BLOCKS command requests that the SATL reassign defective logical blocks (see SBC-2). ATA devices do not support or have a direct translation for the REASSIGN BLOCKS command. The SATL shall emulate the ~~SCSI~~ REASSIGN BLOCKS command as defined in table 46.

Table 46 — REASSIGN BLOCKS command CDB fields

Field	Description or reference
OPERATION CODE	9.10.2
LONGLBA	See SBC-2
LONGLIST	See SBC-2
CONTROL	6.4

The REASSIGN BLOCKS command parameter list provided in the data-out buffer contains the LBAs to be reassigned. The LBAs provided in the parameter list shall be utilized for the LBAs in any ATA verify commands (see 3.1.17) or ATA write commands (see 3.1.18) issued by the SATL.

The SATL shall support the LONGLBA field and the LONGLIST field (see SBC-2).

9.10.2 REASSIGN BLOCKS operation code

The SATL shall accept a parameter list specifying LBAs to be reassigned (see SBC-2). For each LBA in the parameter list, the SATL shall:

- 1) issue an ATA verify command (see 3.1.17) to the specified LBA;
- 2) if the ATA verify command completes successfully, then the SATL shall return GOOD status for the REASSIGN BLOCKS command;
- 3) if the ATA verify command does not complete successfully, then the SATL shall Issue an ATA write command (see 3.1.18) with vendor-specific data to the LBA that failed the ATA verify command;
- 4) if the ATA write command fails, then the SATL shall terminate the REASSIGN BLOCKS command with CHECK CONDITION status with the sense key set to HARDWARE ERROR and the additional sense code set to WRITE ERROR – AUTO REALLOCATION FAILED;
- 5) if the write command completes successfully, then the SATL shall issue a second ATA verify command to the same LBA;
- 6) if the second ATA verify command completes successfully, then the SATL shall return GOOD status for the REASSIGN BLOCKS command; and
- 7) if the second ATA verify command does not complete successfully, then the SATL shall terminate the REASSIGN BLOCKS command with CHECK CONDITION status with the sense key set to MEDIUM

Author: EDITOR[risheffi]
Subject: Rectangle
Date: 6/22/2006 8:51:25 AM

9.10.2 REASSIGN BLOCKS operation code
RESOLUTION: see 06-216 - Replace the subclause as follows:
"9.10.2 REASSIGN BLOCKS operation code

The SATL shall accept a parameter list specifying LBAs to be reassigned (see SBC-2).
The SATL shall process each LBA specified in the parameter list according to the process shown in figure xx."
(insert flow-chart)

The flow chart has the following algorithm depicted:

- 1) Issue an ATA verify command (see 3.1.17) to the current LBA;
- 2) If the ATA verify command completes without error, the SATL shall either:
 - a) if there are one or more LBAs specified in the parameter list remaining to process, continue with step-1 to process the next LBA in the parameter list; or
 - b) return GOOD status for the REASSIGN BLOCKS command if there are no more LBAs remaining to process;
- 3) Issue an ATA write command (see 3.1.18) with vendor-specific data to the current LBA;
- 4) If the ATA write command completes with an error, the SATL shall terminate the REASSIGN BLOCKS command with CHECK CONDITION status with the sense key set to HARDWARE ERROR and the additional sense code set to WRITE ERROR – AUTO REALLOCATION FAILED;
- 5) Issue a second ATA verify command to the current LBA;
- 6) If the second ATA verify command completes without error, the SATL shall:
 - a) if there are one or more LBAs specified in the parameter list remaining to process, continue with step-1 to process the next LBA in the parameter list; and
 - b) If there are no more LBAs remaining to process, then return GOOD status for the REASSIGN BLOCKS command;and
- 7) Terminate the REASSIGN BLOCKS command with CHECK CONDITION status with the sense key set to MEDIUM ERROR and the additional sense code set to UNRECOVERED READ ERROR - AUTO REALLOCATE FAILED.

Status
risheffi Completed 7/23/2006 12:55:45 PM

Sequence number: 10
Author: DELL[KMarks]
Subject: Highlight
Date: 6/22/2006 8:52:13 AM

T **9.10.2 REASSIGN BLOCKS operation code**
1,2,..7 list

change

- "1) issue an ATA verify command (see 3.1.17) to the specified LBA;
2) if the ATA verify command completes successfully, then the SATL shall return GOOD status for the REASSIGN BLOCKS command;
3) if the ATA verify command does not complete successfully, then the SATL shall Issue an ATA write command (see 3.1.18) with vendor-specific data to the LBA that failed the ATA verify command;
4) if the ATA write command fails, then the SATL shall terminate the REASSIGN BLOCKS command with CHECK CONDITION status with the sense key set to HARDWARE ERROR and the additional sense code set to WRITE ERROR – AUTO REALLOCATION FAILED;
5) if the write command completes successfully, then the SATL shall issue a second ATA verify command to the same LBA;
6) if the second ATA verify command completes successfully, then the SATL shall return GOOD status for the REASSIGN BLOCKS command; and
7) if the second ATA verify command does not complete successfully, then the SATL shall terminate the REASSIGN BLOCKS command with CHECK CONDITION status with the sense key set to MEDIUM..."
to

- "1) issue an ATA verify command (see 3.1.17) to the specified LBA;
2) if the ATA verify command completes with no error, the SATL shall return GOOD status for the REASSIGN BLOCKS command;
3) if the ATA verify command completes with an error, the SATL shall issue an ATA write command (see 3.1.18) with vendor-specific data to the LBA of the ATA verify command that completed with an error;

Comments from page 73 continued on next page

9.9.2 READ CAPACITY data

The SATL shall return READ CAPACITY data as defined by SBC-2. Table 45 describes the translation of fields in the READ CAPACITY data.

Table 45 — READ CAPACITY (16) data

Field	Description or reference
RETURNED LOGICAL BLOCK ADDRESS	Unspecified (see 3.4.3)
BLOCK LENGTH IN BYTES	Unspecified (see 3.4.3)
RTO_EN	Unspecified (see 3.4.3)
PROT_EN	Unspecified (see 3.4.3)

9.10 REASSIGN BLOCKS command

9.10.1 REASSIGN BLOCKS command overview

The REASSIGN BLOCKS command requests that the SATL reassign defective logical blocks (see SBC-2). ATA devices do not support or have a direct translation for the REASSIGN BLOCKS command. The SATL shall emulate the ~~SCSI~~ REASSIGN BLOCKS command as defined in table 46.

Table 46 — REASSIGN BLOCKS command CDB fields

Field	Description or reference
OPERATION CODE	9.10.2
LONGLBA	See SBC-2
LONGLIST	See SBC-2
CONTROL	6.4

The REASSIGN BLOCKS command parameter list provided in the data-out buffer contains the LBAs to be reassigned. The LBAs provided in the parameter list shall be utilized for the LBAs in any ATA verify commands (see 3.1.17) or ATA write commands (see 3.1.18) issued by the SATL.

The SATL shall support the LONGLBA field and the LONGLIST field (see SBC-2).

9.10.2 REASSIGN BLOCKS operation code

The SATL shall accept a parameter list specifying LBAs to be reassigned (see SBC-2). For each LBA in the parameter list, the SATL shall:

- 1) issue an ATA verify command (see 3.1.17) to the specified LBA;
- 13) 12) if the ATA verify command completes 11) successfully, then the SATL shall return GOOD status for the REASSIGN BLOCKS command;
- 3) 14) if the ATA verify command does not complete successfully, then the SATL shall issue an ATA write command (see 3.1.18) with vendor-specific data to the LBA that failed the ATA verify command;
- 4) if the ATA write command fails, then the SATL shall terminate the REASSIGN BLOCKS command with CHECK CONDITION status with the sense key set to HARDWARE ERROR and the additional sense code set to WRITE ERROR – AUTO REALLOCATION FAILED;
- 5) if the 16) write command completes 15) successfully, then the SATL shall issue a second ATA verify command to the same LBA;
- 6) if the second ATA verify command completes successfully, then the SATL shall return GOOD status for the REASSIGN BLOCKS command; and
- 7) if the second ATA verify command does not complete successfully, then the SATL shall terminate the REASSIGN BLOCKS command with CHECK CONDITION status with the sense key set to MEDIUM

- 4) if the ATA write command completes with an error, the SATL shall terminate the REASSIGN BLOCKS command with CHECK CONDITION status with the sense key set to HARDWARE ERROR and the additional sense code set to WRITE ERROR – AUTO REALLOCATION FAILED;
- 5) if the ATA write command completes with no error, the SATL shall issue a second ATA verify command to the same LBA;
- 6) if the second ATA verify command completes with no error, the SATL shall return GOOD status for the REASSIGN BLOCKS command; and
- 7) if the second ATA verify command completes with an error, the SATL shall terminate the REASSIGN BLOCKS command with CHECK CONDITION status with the sense key set to MEDIUM..."

RESOLUTION: see 06-216

Status
rlsheffi Completed 7/23/2006 12:56:03 PM

Sequence number: 11
Author: MXO[MEvans]
Subject: Highlight
Date: 6/22/2006 8:52:36 AM

 9.10.2 REASSIGN BLOCKS operation code, list item 2: change "successfully" to "without error".

RESOLUTION: see 06-216

Status
rlsheffi Completed 7/23/2006 12:56:20 PM

Sequence number: 12
Author: HPQ[WBellamy]
Subject: Highlight
Date: 2/17/2006 4:54:18 AM



Status
rlsheffi Cancelled 5/3/2006 12:34:47 PM

Sequence number: 13
Author: HPQ[WBellamy]
Subject: Note
Date: 6/22/2006 8:53:09 AM

 This is not correct and does not comply with proposal 05-136r2. The command may have more than one LBA to reassign in its parameter list. Thus, this statement as it stands is incorrect. It should probably have something like "if the ATA verify command for each LBA in the parameter list completes successfully, then...."

RESOLUTION: see 06-216

Status
rlsheffi Completed 7/23/2006 12:56:28 PM

Sequence number: 14
Author: MXO[MEvans]
Subject: Highlight
Date: 6/22/2006 8:53:20 AM

 9.10.2 REASSIGN BLOCKS operation code, list item 3: change "if the ATA verify command does not complete successfully..." to "if the ATA verify command completes with an error..."

RESOLUTION: see 06-216

Status
rlsheffi Completed 7/23/2006 12:56:47 PM

Sequence number: 15
Author: MXO[MEvans]
Subject: Highlight
Date: 6/22/2006 8:53:28 AM

 9.10.2 REASSIGN BLOCKS operation code, list item 5: change "successfully" to "without error".

RESOLUTION: see 06-216

Status
rlsheffi Completed 7/23/2006 12:56:55 PM

Sequence number: 16
Author: HPQ[RElliott]

9.9.2 READ CAPACITY data

The SATL shall return READ CAPACITY data as defined by SBC-2. Table 45 describes the translation of fields in the READ CAPACITY data.

Table 45 — READ CAPACITY (16) data

Field	Description or reference
RETURNED LOGICAL BLOCK ADDRESS	Unspecified (see 3.4.3)
BLOCK LENGTH IN BYTES	Unspecified (see 3.4.3)
RTO_EN	Unspecified (see 3.4.3)
PROT_EN	Unspecified (see 3.4.3)

9.10 REASSIGN BLOCKS command

9.10.1 REASSIGN BLOCKS command overview

The REASSIGN BLOCKS command requests that the SATL reassign defective logical blocks (see SBC-2). ATA devices do not support or have a direct translation for the REASSIGN BLOCKS command. The SATL shall emulate the ~~SCSI~~ REASSIGN BLOCKS command as defined in table 46.

Table 46 — REASSIGN BLOCKS command CDB fields

Field	Description or reference
OPERATION CODE	9.10.2
LONGLBA	See SBC-2
LONGLIST	See SBC-2
CONTROL	6.4

The REASSIGN BLOCKS command parameter list provided in the data-out buffer contains the LBAs to be reassigned. The LBAs provided in the parameter list shall be utilized for the LBAs in any ATA verify commands (see 3.1.17) or ATA write commands (see 3.1.18) issued by the SATL.

The SATL shall support the LONGLBA field and the LONGLIST field (see SBC-2).

9.10.2 REASSIGN BLOCKS operation code

The SATL shall accept a parameter list specifying LBAs to be reassigned (see SBC-2). For each LBA in the parameter list, the SATL shall:

- 1) issue an ATA verify command (see 3.1.17) to the specified LBA;
- 2) if the ATA verify command completes successfully, then the SATL shall return GOOD status for the REASSIGN BLOCKS command;
- 3) if the ATA verify command does not complete successfully, then the SATL shall issue an ATA write command (see 3.1.18) with vendor-specific data to the LBA that failed the ATA verify command;
- 4) if the ATA write command fails, then the SATL shall terminate the REASSIGN BLOCKS command with CHECK CONDITION status with the sense key set to HARDWARE ERROR and the additional sense code set to WRITE ERROR – AUTO REALLOCATION FAILED;
- 5) if the write command completes successfully, then the SATL shall issue a second ATA verify command to the same LBA;
- 6) if the second ATA verify command completes successfully, then the SATL shall return GOOD status for the REASSIGN BLOCKS command; and
- 7) if the second ATA verify command does not complete successfully, then the SATL shall terminate the REASSIGN BLOCKS command with CHECK CONDITION status with the sense key set to MEDIUM

Subject: Highlight
Date: 6/22/2006 8:53:43 AM
T 9.10.2.

"write command" s/b "ATA write command"

RESOLUTION: see 06-216

Status
rsheffi Completed 7/23/2006 12:57:02 PM

Sequence number: 17
Author: MXO[MEvans]
Subject: Highlight
Date: 6/22/2006 8:53:53 AM

T 9.10.2 REASSIGN BLOCKS operation code, list item 6: change "successfully" to "without error".

RESOLUTION: see 06-216

Status
rsheffi Completed 7/23/2006 12:57:13 PM

Sequence number: 18
Author: HPQ[WBellamy]
Subject: Highlight
Date: 2/17/2006 7:42:47 AM

T

Status
rsheffi Cancelled 5/3/2006 12:34:16 PM

Sequence number: 19
Author: HPQ[WBellamy]
Subject: Note
Date: 6/22/2006 8:54:10 AM

This is incorrect. (Similar type of mistake here as for 2) above). This is not following 05-136r2. There could be more than one LBA to be reassigned and this verbiage is incorrect for such a situation. The SATL has to perform this complete routine on the next LBA in the parameter list, i. e., "return GOOD status for the REASSIGN BLOCKS command" is not correct.
TO DO: Get with Wayne and craft a rewrite in a new comment.

RESOLUTION: see 06-216

Status
rsheffi Completed 7/23/2006 12:57:20 PM

Sequence number: 20
Author: MXO[MEvans]
Subject: Highlight
Date: 6/22/2006 8:54:53 AM

T 9.10.2 REASSIGN BLOCKS operation code, list item 7: change "if the second ATA verify command does not complete successfully..." to "if the second ATA verify command completes with an error...".

RESOLUTION: see 06-216

Status
rsheffi Completed 7/23/2006 12:57:26 PM

ERROR and the additional sense code set to UNRECOVERED READ ERROR – AUTO REALLOCATE FAILED.

9.11 START STOP UNIT command

11.1.1 START STOP UNIT command overview

The START STOP UNIT command provides a method for controlling the power state of a logical unit.

Table 47 — START/STOP UNIT command CDB fields

Field	Description or reference
OPERATION CODE	Commands issued to the attached device depend upon the other values in the CDB as described in 9.11.3.
IMMED	The SATL shall implement this field as defined in 9.11.3.
POWER CONDITIONS	The SATL shall ignore this field.
LOEJ	The SATL shall implement this field as defined in 9.11.3.
START	The SATL shall implement this field as defined in 9.11.3.
CONTROL	6.4

If a SATL receives a command other than a START STOP UNIT command for a device that is in the Stopped state (see SBC-2), then the SATL shall return CHECK CONDITION status, with the sense key set to NOT READY and the additional sense code set to LOGICAL UNIT NOT READY, INITIALIZING COMMAND REQUIRED.

9.11.2 IMMED bit processing for the START STOP UNIT command

9.11.2.1 Before processing the START STOP UNIT command

The SATL shall:

- 1) return GOOD status if the IMMED bit is set to one, and
- 2) continue processing the START STOP UNIT command.

9.11.2.2 After START STOP UNIT completes with no error

If no error occurs during the processing of the START STOP UNIT command and the IMMED bit is set to zero, then the SATL shall return GOOD status.

9.11.2.3 After START STOP UNIT completes with an error

If an error occurs during the processing of the START STOP UNIT command and the IMMED bit is set to zero, the SATL shall terminate the command with CHECK CONDITION status with a sense key of ABORTED COMMAND, and the additional sense code for specified for the error being reported.

If an error occurs during the processing of the START STOP UNIT command and the IMMED bit is set to one, the SATL shall terminate the command and return CHECK CONDITION status as a deferred error (see SPC-3) with a sense key of ABORTED COMMAND, and the additional sense code set to the value specified for the error being reported.

Sequence number: 1
Author: IBM[GPenokie]
Subject: Underline
Date: 2/16/2006 1:41:10 PM
T 9.11.1 START STOP UNIT command overview

Status
rlsheffi Cancelled 5/3/2006 2:31:33 PM

Sequence number: 2
Author: DELL[KMarks]
Subject: Highlight
Date: 6/22/2006 10:40:01 AM
T 9.11.1 START STOP UNIT command overview
1st Sentence

"The START STOP UNIT command provides a method for controlling the power state of a logical unit."

to

"The START STOP UNIT command provides a method for controlling the power state of a logical unit."

Table 47 shows the translation for fields specified in the START STOP UNIT CDB."

RESOLUTION: see 06-216

Status
rlsheffi Completed 7/23/2006 12:58:25 PM

Sequence number: 3
Author: HPQ[RElliott]
Date: 6/22/2006 10:40:09 AM
 9.11.1

need a reference to table 47

RESOLUTION: see 06-216

Status
rlsheffi Completed 7/23/2006 12:58:33 PM

Sequence number: 4
Author: IBM[GPenokie]
Subject: Highlight
Date: 6/22/2006 10:40:16 AM
T There is no reference to table 47. This needs to be fixed as all tables have to be referenced.
RESOLUTION: see 06-216

Status
rlsheffi Completed 7/23/2006 12:58:39 PM

Sequence number: 5
Author: DELL[KMarks]
Subject: Highlight
Date: 6/22/2006 10:41:34 AM
T **Table 47 — START/STOP UNIT command CDB fields**
Row: OPERATION CODE
change

"Commands issued to the attached device depend upon the other values in the CDB as described in 9.11.3."

to

"Commands issued to the ATA device depend upon the other values in the CDB as described in 9.11.3."

RESOLUTION: see 06-216

Status
rlsheffi Completed 7/23/2006 12:58:57 PM

Sequence number: 6
Author: DELL[KMarks]
Subject: Highlight

ERROR and the additional sense code set to UNRECOVERED READ ERROR – AUTO REALLOCATE FAILED.

9.11 START STOP UNIT command

9.11.1 START STOP UNIT command overview

The START STOP UNIT command provides a method for controlling the power state of a logical unit.

Table 47 — START/STOP UNIT command CDB fields

Field	Description or reference
OPERATION CODE	Commands issued to the attached device depend upon the other values in the CDB as described in 9.11.3.
IMMED	The SATL shall implement this field as defined in 9.11.3.
POWER CONDITIONS	The SATL shall ignore this field.
LOEJ	The SATL shall implement this field as defined in 9.11.3.
START	The SATL shall implement this field as defined in 9.11.3.
CONTROL	6.4

10. SATL receives a command other than a START STOP UNIT command for a device that is in the Stopped state (see SBC-2), then the SATL shall return CHECK CONDITION status, with the sense key set to NOT READY and the additional sense code set to LOGICAL UNIT NOT READY, INITIALIZING COMMAND REQUIRED.

9.11.2 IMMED bit processing for the START STOP UNIT command

9.11.2.1 Before processing the START STOP UNIT command

The SATL shall:

- 1) return GOOD status if the IMMED bit is set to one, and
- 2) continue processing the START STOP UNIT command.

9.11.2.2 After START STOP UNIT completes with no error

If no error occurs during the processing of the START STOP UNIT command and the IMMED bit is set to zero, then the SATL shall return GOOD status.

9.11.2.3 After START STOP UNIT completes with an error

If an error occurs during the processing of the START STOP UNIT command and the IMMED bit is set to zero, the SATL shall terminate the command with CHECK CONDITION status with a sense key of ABORTED COMMAND, and the additional sense code for specified for the error being reported.

If an error occurs during the processing of the START STOP UNIT command and the IMMED bit is set to one, the SATL shall terminate the command and return CHECK CONDITION status as a deferred error (see SPC-3) with a sense key of ABORTED COMMAND, and the additional sense code set to the value specified for the error being reported.

Date: 6/22/2006 10:43:13 AM

T Table 47 — START/STOP UNIT command CDB fields

Row: IMMED

change

"The SATL shall implement this field as defined in 9.11.3."

to

"The SATL shall implement this field as defined in 9.11.2 and 9.11.3."

RESOLUTION: see 06-216

Status

rlsheffi Completed 7/23/2006 12:59:13 PM

Sequence number: 7

Author: HPQ[RElliott]

Subject: Highlight

Date: 7/12/2006 8:28:29 PM

T 9.11.1

"ignore" is not what SCSI expects from defined fields set to unsupported values. It should return CHECK CONDITION/ILLEGAL REQUEST/INVALID FIELD IN CDB.

Suggested resolution: s/b

"If the POWER CONDITIONS field is not set to zero, the SATL shall terminate the command with CHECK CONDITION status, with the sense key set to ILLEGAL REQUEST and the additional sense code set to INVALID FIELD IN CDB."

RESOLUTION: see 06-216

Status

rlsheffi Completed 7/23/2006 12:59:32 PM

Sequence number: 8

Author: DELL[KMarks]

Subject: Highlight

Date: 6/22/2006 10:45:38 AM

T Table 47 — START/STOP UNIT command CDB fields

Row: POWER CONDITIONS

change

"The SATL shall ignore this field."

to

"The field shall be set to 000b."

The way SBC-2 reads to me is that if the POWER CONDITIONS field is not set to zero, the the LEOF and START bits are ignored.

REASON: "shall be set to 000b" is a requirement on the application client, which isn't the norm for SCSI standards, and would place special requirements on application clients that work with SATLs. A better approach is to define the SATL's behavior when the application client sets a value the SATL doesn't support. See HPQ comment.

RESOLUTION: see 06-216

Status

rlsheffi Rejected 5/4/2006 9:15:25 AM

Sequence number: 9

Author: HPQ[RElliott]

Subject: Highlight

Date: 6/22/2006 10:46:40 AM

T 9.11.1

table 47

CONDITIONS s/b CONDITION

RESOLUTION: see 06-216

Status

rlsheffi Completed 7/23/2006 1:00:01 PM

Sequence number: 10

Author: DELL[KMarks]

Subject: Highlight

Date: 7/23/2006 1:01:15 PM

T 9.11.1 START STOP UNIT command overview

1st Paragraph after Table 47 — START/STOP UNIT command CDB fields

change

Comments from page 74 continued on next page

ERROR and the additional sense code set to UNRECOVERED READ ERROR – AUTO REALLOCATE FAILED.

9.11 START STOP UNIT command

9.11.1 START STOP UNIT command overview

The START STOP UNIT command provides a method for controlling the power state of a logical unit.

Table 47 — START/STOP UNIT command CDB fields

Field	Description or reference
OPERATION CODE	Commands issued to the attached device depend upon the other values in the CDB as described in 9.11.3.
IMMED	The SATL shall implement this field as defined in 9.11.3.
POWER CONDITIONS	The SATL shall ignore this field.
LOEJ	The SATL shall implement this field as defined in 9.11.3.
START	The SATL shall implement this field as defined in 9.11.3.
CONTROL	6.4

¹¹ SATL receives a command other than a START STOP UNIT command for a device that is in the Stopped state (see SBC-2), then the SATL shall return CHECK CONDITION status, with the sense key set to NOT READY and the additional sense code set to LOGICAL UNIT NOT READY, INITIALIZING COMMAND REQUIRED.

¹² 9.11.2 IMMED bit processing for the START STOP UNIT command

9.11.2.1 Before processing the START STOP UNIT command

The SATL shall:

- 1) return GOOD status if the IMMED bit is set to one, and
- 2) continue processing the START STOP UNIT command.

9.11.2.2 After START STOP UNIT completes with no error

If no error occurs during the processing of the START STOP UNIT command and the IMMED bit is set to zero, then the SATL shall return GOOD status.

9.11.2.3 After START STOP UNIT completes with an error

If an error occurs during the processing of the START STOP UNIT command and the IMMED bit is set to zero, the SATL shall terminate the command with CHECK CONDITION status with a sense key of ABORTED COMMAND, and the additional sense code for specified for the error being reported.

If an error occurs during the processing of the START STOP UNIT command and the IMMED bit is set to one, the SATL shall terminate the command and return CHECK CONDITION status as a deferred error (see SPC-3) with a sense key of ABORTED COMMAND, and the additional sense code set to the value specified for the error being reported.

"If a SATL receives a command other than a START STOP UNIT command for a device that is in the Stopped state (see SBC-2), then the SATL shall return CHECK CONDITION status, with the sense key set to NOT READY and the additional sense code set to LOGICAL UNIT NOT READY, INITIALIZING COMMAND REQUIRED."

to

"If a SATL receives a command that requires medium access while the device is in the Stopped state (see SBC-2), the SATL shall return CHECK CONDITION status, with the sense key set to NOT READY and the additional sense code set to LOGICAL UNIT NOT READY, INITIALIZING COMMAND REQUIRED."

Shouldn't this be "receives a medium access command", not any command. To my knowledge, in standby mode, an ATA device will still response to commands that do not require media access.

RESOLUTION: see 06-216 - reword as suggested, though not because an ATA device in standby mode responds to non-media access commands, but because a SCSI device in the stopped state responds to non-media access commands, per SBC-2.

Status
r/sheffi Completed 7/23/2006 1:01:19 PM

Sequence number: 11
Author: SIERLGC[BMartin]
Subject: Highlight
Date: 6/22/2006 10:50:48 AM
Page 54, 9.11.1, after table 47

This should be "If a SATL receives any medium access command ..."

RESOLUTION: see 06-216

Status
r/sheffi Completed 7/23/2006 1:01:35 PM

Sequence number: 12
Author: MXO[MEvans]
Subject: Highlight
Date: 6/24/2006 7:20:27 AM

9.11.2 IMMEDIATE bit processing for the START STOP UNIT command: much has been changed in this and the following table from the accepted proposal (05-226r3). It appears this has been done to make the table smaller. This is a laudable goal. Make the following changes to do this better. First, replace 9.11.2 and its subclauses with the following:

9.11.2 Processing ending status if an error occurs

If an error occurs during the processing of the START STOP UNIT command and the IMMEDIATE bit is set to zero, then the SATL shall terminate the command with CHECK CONDITION status with a sense key of ABORTED COMMAND, and the additional sense code specified for the error being reported (see table 48).

If an error occurs during the processing of the START STOP UNIT command and the IMMEDIATE bit is set to one, then the SATL shall terminate the command and return CHECK CONDITION status as a deferred error (see SPC-3) with a sense key of ABORTED COMMAND, and the additional sense code set to the value specified for the error being reported (see table 48).

RESOLUTION: see 06-216 - s/b

"9.11.2 Processing ending status if an error occurs

If an error occurs during the processing of the START STOP UNIT command and the IMMEDIATE bit is set to zero, then the SATL shall terminate the command with CHECK CONDITION status with the sense key set to ABORTED COMMAND, and the additional sense code specified for the error being reported (see table 48).

If an error occurs during the processing of the START STOP UNIT command and the IMMEDIATE bit is set to one, then the SATL shall terminate the START STOP UNIT command with CHECK CONDITION status as a deferred error (see SPC-3) with the sense key set to ABORTED COMMAND, and the additional sense code set to the value specified for the error being reported (see table 48)."

Status
r/sheffi Completed 7/23/2006 1:02:29 PM

Sequence number: 13
Author: HPQ[RElliott]
Subject: Note

Comments from page 74 continued on next page

ERROR and the additional sense code set to UNRECOVERED READ ERROR – AUTO REALLOCATE FAILED.

9.11 START STOP UNIT command

9.11.1 START STOP UNIT command overview

The START STOP UNIT command provides a method for controlling the power state of a logical unit.

Table 47 — START/STOP UNIT command CDB fields

Field	Description or reference
OPERATION CODE	Commands issued to the attached device depend upon the other values in the CDB as described in 9.11.3.
IMMED	The SATL shall implement this field as defined in 9.11.3.
POWER CONDITIONS	The SATL shall ignore this field.
LOEJ	The SATL shall implement this field as defined in 9.11.3.
START	The SATL shall implement this field as defined in 9.11.3.
CONTROL	6.4

If a SATL receives a command other than a START STOP UNIT command for a device that is in the Stopped state (see SBC-2), then the SATL shall return CHECK CONDITION status, with the sense key set to NOT READY and the additional sense code set to LOGICAL UNIT NOT READY, INITIALIZING COMMAND REQUIRED.

9.11.2 IMMED bit processing for the START STOP UNIT command

9.11.2.1 Before processing the START STOP UNIT command

The SATL shall:

- 1) return GOOD status if the IMMED bit is set to one, and
- 2) continue processing the START STOP UNIT command.

9.11.2.2 After START STOP UNIT completes with no error

If no error occurs during the processing of the START STOP UNIT command and the IMMED bit is set to zero, then the SATL shall return GOOD status.

9.11.2.3 After START STOP UNIT completes with an error

If an error occurs during the processing of the START STOP UNIT command and the IMMED bit is set to zero, the SATL shall terminate the command with CHECK CONDITION status with a sense key of ABORTED COMMAND, and the additional sense code specified for the error being reported.

If an error occurs during the processing of the START STOP UNIT command and the IMMED bit is set to one, the SATL shall terminate the command and return CHECK CONDITION status as a deferred error (see SPC-3) with a sense key of ABORTED COMMAND, and the additional sense code set to the value specified for the error being reported.

Date: 6/22/2006 11:07:42 AM

 9.11.2.1

This section requires concatenating the section title with the text for the rules to be in context. Make the text stand alone.

RESOLUTION: see 06-216

Status
risheffi Completed 7/23/2006 1:03:27 PM

Sequence number: 14
Author: ENDL[RWeber]
Date: 6/22/2006 11:07:56 AM

 The introductory text for the 1,2 list should be more clear about when the SATL shall do what the list says.

RESOLUTION: see 06-216

Status
risheffi Completed 7/23/2006 1:04:11 PM

Sequence number: 15
Author: HPQ[RElliott]
Subject: Highlight
Date: 6/22/2006 11:08:18 AM

 9.11.2.1

, s/b ;

RESOLUTION: see 06-216 (non-error behavior moved back into table 48 in 9.11.3)

Status
risheffi Completed 7/23/2006 1:04:26 PM

Sequence number: 16
Author: HPQ[RElliott]
Subject: Highlight
Date: 7/23/2006 1:06:37 PM

 9.11.2.3

of s/b set to

RESOLUTION: fixed in SAT-r08c

Status
risheffi Completed 7/23/2006 1:06:41 PM

Sequence number: 17
Author: DELL[KMarks]
Subject: Highlight
Date: 6/22/2006 11:08:44 AM

 **9.11.2.3 After START STOP UNIT completes with an error
1st Paragraph, 1st Sentence**

change

"...key of ABORTED COMMAND, and the additional sense code for specified for the error being reported."

to

"...key of ABORTED COMMAND, and the additional sense code set to the value specified for the error being reported."

RESOLUTION: see 06-216

Status
risheffi Completed 7/23/2006 1:07:10 PM

Sequence number: 18
Author: HPQ[RElliott]
Subject: Highlight
Date: 6/22/2006 11:08:55 AM

 9.11.2.3

reword "for specified for the error being reported." using "set to..." phrasing

RESOLUTION: see 06-216

Comments from page 74 continued on next page

ERROR and the additional sense code set to UNRECOVERED READ ERROR – AUTO REALLOCATE FAILED.

9.11 START STOP UNIT command

9.11.1 START STOP UNIT command overview

The START STOP UNIT command provides a method for controlling the power state of a logical unit.

Table 47 — START/STOP UNIT command CDB fields

Field	Description or reference
OPERATION CODE	Commands issued to the attached device depend upon the other values in the CDB as described in 9.11.3.
IMMED	The SATL shall implement this field as defined in 9.11.3.
POWER CONDITIONS	The SATL shall ignore this field.
LOEJ	The SATL shall implement this field as defined in 9.11.3.
START	The SATL shall implement this field as defined in 9.11.3.
CONTROL	6.4

If a SATL receives a command other than a START STOP UNIT command for a device that is in the Stopped state (see SBC-2), then the SATL shall return CHECK CONDITION status, with the sense key set to NOT READY and the additional sense code set to LOGICAL UNIT NOT READY, INITIALIZING COMMAND REQUIRED.

9.11.2 IMMED bit processing for the START STOP UNIT command

9.11.2.1 Before processing the START STOP UNIT command

The SATL shall:

- 1) return GOOD status if the IMMED bit is set to one, and
- 2) continue processing the START STOP UNIT command.

9.11.2.2 After START STOP UNIT completes with no error

If no error occurs during the processing of the START STOP UNIT command and the IMMED bit is set to zero, then the SATL shall return GOOD status.

9.11.2.3 After START STOP UNIT completes with an error

If an error occurs during the processing of the START STOP UNIT command and the IMMED bit is set to zero, the SATL shall terminate the command with CHECK CONDITION status with a sense key of ABORTED COMMAND, and the additional sense code for specified for the error being reported.

If an error occurs during the processing of the START STOP UNIT command and the IMMED bit is set to one, the SATL shall terminate the command and return CHECK CONDITION status as a deferred error (see SPC-3) with a sense key of ABORTED COMMAND, and the additional sense code set to the value specified for the error being reported.

Status
risheffi Completed 7/23/2006 1:07:41 PM

Sequence number: 19
Author: DELL[KMarks]
Subject: Highlight
Date: 6/22/2006 11:09:09 AM

T 9.11.2.3 After START STOP UNIT completes with an error

2st Paragraph, 1st Sentence

change

"...terminate the command and..."

to

"...terminate the START STOP UNIT command and..."

RESOLUTION: see 06-216

Status
risheffi Completed 7/23/2006 1:08:00 PM

9.11.3 START STOP UNIT START bit LOEJ bit combinations

The SATL shall perform the actions shown in table 48 in response to a START STOP UNIT command.

Table 48 — Definition of IMMED, LOEJ, and START bits in the START STOP UNIT CDB

START	LOEJ	Definition
0	0	<p>The SATL shall:</p> <ol style="list-style-type: none"> 1) Process the IMMED bit (see 9.11.2.1); 3) Issue a FLUSH CACHE or FLUSH CACHE EXT command to the attached ATA device; 3) If the FLUSH CACHE or FLUSH CACHE EXTENDED command completes with any error, then process ending status according to the IMMED bit (see 9.11.2.3) with the additional sense code set to COMMAND SEQUENCE ERROR; 4) If the FLUSH CACHE or FLUSH CACHE EXT command completes with no error, then issue a STANDBY command to the attached ATA device with zero in Sector Count; 5) If the STANDBY command completes with any error, then process ending status according to the IMMED bit (see 9.11.2.3) with the additional sense code set to COMMAND SEQUENCE ERROR; and 6) If the STANDBY command completes with no error ^a, then process GOOD status according to the IMMED bit (see 9.11.2.2) ^b.
1	0	<p>The SATL shall:</p> <ol style="list-style-type: none"> 1) Process the IMMED bit (see 9.11.2.1); 2) Issue an ATA verify command (see 3.1.17) to the attached ATA device with one in Sector Count and a value in LBA from zero to the maximum LBA supported by the ATA device in its current configuration ^d; and 3) When command completion is received for the ATA verify command (see 3.1.17) process GOOD status according to the IMMED bit (see 9.11.2.2) ^c.
0	1	<p>If the attached ATA device supports the Removable Media feature set, then the SATL shall:</p> <ol style="list-style-type: none"> 1) Process the IMMED bit (see 9.11.2.1); 2) Issue a MEDIA EJECT command to the attached ATA device; 3) If the MEDIA EJECT command completes with any error, then process ending status according to the IMMED bit (see 9.11.2.3) with the additional sense code set to MEDIA LOAD OR EJECT FAILED; and 4) If the MEDIA EJECT command completes with no error, then process GOOD status according to the IMMED bit (see 9.11.2.2). <p>If the attached ATA device does not support the Removable Media feature set, then the SATL shall return CHECK CONDITION status with the sense key set to ILLEGAL REQUEST and the additional sense code set to INVALID FIELD IN CDB.</p>
1	1	<p>The SATL shall return CHECK CONDITION status with the sense key set to ILLEGAL REQUEST, with the additional sense code set to INVALID FIELD IN CDB.</p>
<p>^a An ATA device may return completion status for a STANDBY command before removal of the ATA device may be accomplished without damaging the ATA device.</p> <p>^b After returning GOOD status for a START STOP UNIT command with the START bit set to zero, the SATL shall consider the ATA device to be in the Stopped power state (see SBC-2).</p> <p>^c After returning GOOD status for a START STOP UNIT command with the START bit set to one, the SATL shall consider the ATA device to be in the Active power state (see SBC-2).</p> <p>^d An ATA device medium access occurs when an LBA is specified whose data is not contained in ATA device's cache memory. If a value in LBA is specified for an ATA verify command where the data is contained in ATA device's cache memory, then an ATA device may not be in the Active power mode (see ATA/ATAPI-7) after completion of the ATA verify command.</p>		

Sequence number: 1
Author: STX[GHoulder]
Subject: Cross-Out
Date: 6/22/2006 11:14:03 AM

T PDF page 74

table 48

Remove "IMMED," from the table title, as it is not one of the columns

RESOLUTION: see 06-216

Status

risheffi Completed 7/23/2006 1:08:23 PM

Sequence number: 2
Author: MXO[MEvans]
Subject: Highlight
Date: 6/22/2006 11:27:22 AM

T Table 48, row 1, definition: change as follows:

The SATL shall:

- 1) If the IMMED bit is set to one, then return GOOD status;
- 2) Issue a FLUSH CACHE or FLUSH CACHE EXT command to the attached ATA device;
- 3) If the FLUSH CACHE or FLUSH CACHE EXTENDED command completes with any error, then process ending status as specified in 9.11.2 with the additional sense code set to COMMAND SEQUENCE ERROR;
- 4) If the FLUSH CACHE or FLUSH CACHE EXT command completes with no error, then issue a STANDBY command to the attached ATA device with zero in Sector Count;
- 5) If the STANDBY command completes with any error, then process ending status as specified in 9.11.2 with the additional sense code set to COMMAND SEQUENCE ERROR; and
- 6) If the STANDBY command completes with no error <superscript a>, and the IMMED bit is set to zero, then return GOOD status <superscript b>.

RESOLUTION: s/b

"The SATL shall:

- 1) If the IMMED bit is set to one, then return GOOD status;
- 2) Issue an ATA flush command (see 3.1.8) to the ATA device;
- 3) If the ATA flush command completes with an error, then process ending status according to the IMMED bit(see 9.11.2) with the additional sense code set to COMMAND SEQUENCE ERROR;
- 4) If the ATA flush command completes without error, then issue an ATA STANDBY command to the ATA device with the Sector Count set to zero;
- 5) If the ATA STANDBY command completes with an error, then process ending status according to the IMMED bit (see 9.11.2) with the additional sense code set to COMMAND SEQUENCE ERROR; and
- 6) If the ATA STANDBY command completes without error <superscript a>, and the IMMED bit is set to zero, then return GOOD status <superscript b>."

RESOLUTION: see 06-216

Status

risheffi Completed 7/23/2006 1:08:39 PM

Sequence number: 3
Author: DELL[KMarks]
Subject: Highlight
Date: 6/22/2006 11:27:31 AM

T Table 48 — Definition of IMMED, LOEJ, and START bits in the START STOP UNIT CDB

Row: 0 0 In Definition column 2) in 1,2..6 list

change

"2) Issue a FLUSH CACHE or FLUSH CACHE EXT command to the attached ATA device;"

to

"2) Issue an ATA flush command (see 3.1.8) command to the ATA device;"

RESOLUTION: see 06-216

Status

risheffi Completed 7/23/2006 1:09:05 PM

9.11.3 START STOP UNIT START bit LOEJ bit combinations

The SATL shall perform the actions shown in table 48 in response to a START STOP UNIT command.

Table 48 — Definition of ~~IMMED~~, LOEJ, and START bits in the START STOP UNIT CDB

START	LOEJ	Definition
0	0	<p>The SATL shall:</p> <ol style="list-style-type: none"> 1) Process the IMMED bit (see 9.11.2.1); 2) Issue a FLUSH CACHE or FLUSH CACHE EXT command to the attached ATA device; 5) If the FLUSH CACHE or FLUSH CACHE EXTENDED command completes with any error, then process ending status according to the IMMED bit (see 9.11.2.3) with the additional sense code set to COMMAND SEQUENCE ERROR; 7) If the FLUSH CACHE or FLUSH CACHE EXT command completes with no error, then issue a STANDBY command to the attached ATA device with zero in Sector Count; 5) If the STANDBY command completes with any error, then process ending status according to the IMMED bit (see 9.11.2.3) with the additional sense code set to COMMAND SEQUENCE ERROR; and 6) If the STANDBY command completes with no error ^a, then process GOOD status according to the IMMED bit (see 9.11.2.2) ^b.
1	0	<p>The SATL shall:</p> <ol style="list-style-type: none"> 1) Process the IMMED bit (see 9.11.2.1); 2) Issue an ATA verify command (see 3.1.17) to the attached ATA device with one in Sector Count and a value in LBA from zero to the maximum LBA supported by the ATA device in its current configuration ^d; and 3) When command completion is received for the ATA verify command (see 3.1.17) process GOOD status according to the IMMED bit (see 9.11.2.2) ^c.
0	1	<p>If the attached ATA device supports the Removable Media feature set, then the SATL shall:</p> <ol style="list-style-type: none"> 1) Process the IMMED bit (see 9.11.2.1); 2) Issue a MEDIA EJECT command to the attached ATA device; 3) If the MEDIA EJECT command completes with any error, then process ending status according to the IMMED bit (see 9.11.2.3) with the additional sense code set to MEDIA LOAD OR EJECT FAILED; and 4) If the MEDIA EJECT command completes with no error, then process GOOD status according to the IMMED bit (see 9.11.2.2). <p>If the attached ATA device does not support the Removable Media feature set, then the SATL shall return CHECK CONDITION status with the sense key set to ILLEGAL REQUEST and the additional sense code set to INVALID FIELD IN CDB.</p>
1	1	The SATL shall return CHECK CONDITION status with the sense key set to ILLEGAL REQUEST, with the additional sense code set to INVALID FIELD IN CDB.
<p>^a An ATA device may return completion status for a STANDBY command before removal of the ATA device may be accomplished without damaging the ATA device.</p> <p>^b After returning GOOD status for a START STOP UNIT command with the START bit set to zero, the SATL shall consider the ATA device to be in the Stopped power state (see SBC-2).</p> <p>^c After returning GOOD status for a START STOP UNIT command with the START bit set to one, the SATL shall consider the ATA device to be in the Active power state (see SBC-2).</p> <p>^d An ATA device medium access occurs when an LBA is specified whose data is not contained in ATA device's cache memory. If a value in LBA is specified for an ATA verify command where the data is contained in ATA device's cache memory, then an ATA device may not be in the Active power mode (see ATA/ATAPI-7) after completion of the ATA verify command.</p>		

Sequence number: 4
Author: STX[GHolder]
Subject: Highlight
Date: 6/22/2006 11:28:02 AM

T PDF page 74
table 48, start=0/leoj=0, bullet 3
Change "FLUSH CACHE EXTENDED" to "FLUSH CACHE EXT"

RESOLUTION: see 06-216 - Changed to "ATA flush command" (see MXO and DELL comments - yes this is in the definitions).

Status
rlsheffi Completed 7/23/2006 1:09:17 PM

Sequence number: 5
Author: DELL[KMarks]
Subject: Highlight
Date: 6/22/2006 11:28:14 AM

T **Table 48 — Definition of IMMED, LOEJ, and START bits in the START STOP UNIT CDB**
Row: 0 0 In Definition column 3) in 1,2..6 list
change

"3) If the FLUSH CACHE or FLUSH CACHE EXTENDED command completes with any error, then process ending status according to the IMMED bit (see 9.11.2.3) with the additional sense code set to COMMAND SEQUENCE ERROR;"

to

"3) If the ATA flush command (see 3.1.8) completes with an error, process ending status according to the IMMED bit (see 9.11.2.3) with the additional sense code set to COMMAND SEQUENCE ERROR;"

RESOLUTION: see 06-216

Status
rlsheffi Completed 7/23/2006 1:09:48 PM

Sequence number: 6
Author: SIERLGC[BMartin]
Subject: Note
Date: 7/12/2006 4:41:49 PM

Page 55, Table 48
We have experienced problems with devices going into the STANDBY state and would prefer to see the SLEEP state specified, or specify either state as

REASON: SAT WG (7/11/06) rejected the idea because a link reset (or equivalent) is required to bring the device out of SLEEP and that may or may not affect persistent settings in the drive.

Status
rlsheffi Rejected 7/12/2006 4:40:16 PM

Sequence number: 7
Author: DELL[KMarks]
Subject: Highlight
Date: 6/22/2006 11:31:17 AM

T **Table 48 — Definition of IMMED, LOEJ, and START bits in the START STOP UNIT CDB**
Row: 0 0 In Definition column 4) in 1,2..6 list
change

"4) If the FLUSH CACHE or FLUSH CACHE EXT command completes with no error, then issue a STANDBY command to the attached ATA device with zero in Sector Count;"

to

"4) If the ATA flush command (see 3.1.8) completes with no error, issue an ATA STANDBY command to the ATA device with the Sector Count set to 0;"

RESOLUTION: see 06-216

Status

Comments from page 75 continued on next page

9.11.3 START STOP UNIT START bit LOEJ bit combinations

The SATL shall perform the actions shown in table 48 in response to a START STOP UNIT command.

Table 48 — Definition of IMMED, LOEJ, and START bits in the START STOP UNIT CDB

START	LOEJ	Definition
0	0	<p>The SATL shall:</p> <ol style="list-style-type: none"> 1) Process the IMMED bit (see 9.11.2.1); 2) Issue a FLUSH CACHE or FLUSH CACHE EXT command to the attached ATA device; 3) If the FLUSH CACHE or FLUSH CACHE EXTENDED command completes with any error, then process ending status according to the IMMED bit (see 9.11.2.3) with the additional sense code set to COMMAND SEQUENCE ERROR; 4) If the FLUSH CACHE or FLUSH CACHE EXT command completes with no error, then issue a ⁸STANDBY command to the attached ATA device with zero in Sector Count; 5) If the STANDBY command completes with any error, then process ending status according to the IMMED bit (see 9.11.2.3) with the additional sense code set to COMMAND SEQUENCE ERROR; and 6) If the STANDBY command completes with no error ¹⁰, then process GOOD status according to the IMMED bit (see 9.11.2.2) ^b.
1	0	<p>¹¹The SATL shall:</p> <ol style="list-style-type: none"> 1) Process the IMMED bit (see 9.11.2.1); 2) Issue an ATA verify command (see 3.1.17) to the attached ATA device with one in Sector Count and a value in LBA from zero to the maximum LBA supported by the ATA device in its current configuration ^d; and 3) When command completion is received for the ATA verify command (see 3.1.17) process GOOD status according to the IMMED bit (see 9.11.2.2) ^c.
0	1	<p>If the attached ATA device supports the Removable Media feature set, then the SATL shall:</p> <ol style="list-style-type: none"> 1) Process the IMMED bit (see 9.11.2.1); 2) Issue a MEDIA EJECT command to the attached ATA device; 3) If the MEDIA EJECT command completes with any error, then process ending status according to the IMMED bit (see 9.11.2.3) with the additional sense code set to MEDIA LOAD OR EJECT FAILED; and 4) If the MEDIA EJECT command completes with no error, then process GOOD status according to the IMMED bit (see 9.11.2.2). <p>If the attached ATA device does not support the Removable Media feature set, then the SATL shall return CHECK CONDITION status with the sense key set to ILLEGAL REQUEST and the additional sense code set to INVALID FIELD IN CDB.</p>
1	1	<p>The SATL shall return CHECK CONDITION status with the sense key set to ILLEGAL REQUEST, with the additional sense code set to INVALID FIELD IN CDB.</p>
<p>^a An ATA device may return completion status for a STANDBY command before removal of the ATA device may be accomplished without damaging the ATA device.</p> <p>^b After returning GOOD status for a START STOP UNIT command with the START bit set to zero, the SATL shall consider the ATA device to be in the Stopped power state (see SBC-2).</p> <p>^c After returning GOOD status for a START STOP UNIT command with the START bit set to one, the SATL shall consider the ATA device to be in the Active power state (see SBC-2).</p> <p>^d An ATA device medium access occurs when an LBA is specified whose data is not contained in ATA device's cache memory. If a value in LBA is specified for an ATA verify command where the data is contained in ATA device's cache memory, then an ATA device may not be in the Active power mode (see ATA/ATAPI-7) after completion of the ATA verify command.</p>		

rlsheffi Completed 7/23/2006 1:10:24 PM

Sequence number: 8
Author: STX[GHolder]
Subject: Highlight
Date: 7/12/2006 4:48:56 PM

T REVISIT: w/ Mark Evans, Curtis Stevens, and Bill Martin
PDF page 74
table 48, start=0/leoj=0, bullet 4
Why use STANDBY instead of STANDBY IMMEDIATE ?

Proposed: Change to STANDBY IMMEDIATE - post to T10 and T13 reflectors. If the SECTOR COUNT is zero for STANDBY, it disables the timer - which is the equivalent of "vendor-specific"?
RESOLUTION: see 06-216r2

Status
rlsheffi Completed 7/23/2006 1:10:50 PM

Sequence number: 9
Author: DELL[KMarks]
Subject: Highlight
Date: 6/22/2006 11:35:09 AM

T Table 48 — Definition of IMMED, LOEJ, and START bits in the START STOP UNIT CDB
Row: 0 0 In Definition column 5) in 1,2..6 list
change

"5) If the STANDBY command completes with any error, then process ending status according to the IMMED bit (see 9.11.2.3) with the additional sense code set to COMMAND SEQUENCE ERROR; and"

to

"5) If the ATA STANDBY command completes with an error, process ending status according to the IMMED bit (see 9.11.2.3) with the additional sense code set to COMMAND SEQUENCE ERROR; and"

RESOLUTION: see 06-216

Status
rlsheffi Completed 7/23/2006 1:11:11 PM

Sequence number: 10
Author: DELL[KMarks]
Subject: Highlight
Date: 6/22/2006 11:35:43 AM

T Table 48 — Definition of IMMED, LOEJ, and START bits in the START STOP UNIT CDB
Row: 0 0 In Definition column 6) in 1,2..6 list
change

"6) If the STANDBY command completes with no error a, then process GOOD status according to the IMMED bit (see 9.11.2.2) b."

to

"6) If the ATA STANDBY command completes with no error a, and the IMMED bit is set to zero, return GOOD status (see 9.11.2.2) b."

6) is kind of strange, in that if the IMMED bit was one, then GOOD status is already returned, and 9.11.2.2 only deals with IMMED set to zero. This applied to Rows: 0 0, 1 0 and 0 1.

RESOLUTION: see 06-216 - Don't need to deal with the IMMED bit set to zero because there's nothing left to do - processing is complete. Also, left off the reference to 9.11.2.2 because that subclause (dealing with non-error IMMED bit processing) is being removed and covered in-line in the table.

Status
rlsheffi Completed 7/23/2006 1:11:24 PM

Sequence number: 11
Author: MXO[MEvans]
Subject: Highlight
Date: 6/22/2006 11:44:22 AM

Comments from page 75 continued on next page

9.11.3 START STOP UNIT START bit LOEJ bit combinations

The SATL shall perform the actions shown in table 48 in response to a START STOP UNIT command.

Table 48 — Definition of ~~IMMED~~, LOEJ, and START bits in the START STOP UNIT CDB

START	LOEJ	Definition
0	0	<p>The SATL shall:</p> <ol style="list-style-type: none"> 1) Process the IMMED bit (see 9.11.2.1); 2) Issue a FLUSH CACHE or FLUSH CACHE EXT command to the attached ATA device; 3) If the FLUSH CACHE or FLUSH CACHE EXTENDED command completes with any error, then process ending status according to the IMMED bit (see 9.11.2.3) with the additional sense code set to COMMAND SEQUENCE ERROR; 4) If the FLUSH CACHE or FLUSH CACHE EXT command completes with no error, then issue a STANDBY command to the attached ATA device with zero in Sector Count; 5) If the STANDBY command completes with any error, then process ending status according to the IMMED bit (see 9.11.2.3) with the additional sense code set to COMMAND SEQUENCE ERROR; and 6) If the STANDBY command completes with no error ^a, then process GOOD status according to the IMMED bit (see 9.11.2.2) ^b.
1	0	<p>The SATL shall:</p> <ol style="list-style-type: none"> 1) Process the IMMED bit (see 9.11.2.1); 13) Issue an ATA verify command (see 3.1.17) to the attached ATA device with one in Sector Count and a value in LBA from zero to the maximum LBA supported by the ATA device in its current configuration ^d; and 3) When command completion is received for the ATA verify command (see 3.1.17) process GOOD status according to the IMMED bit (see 9.11.2.2) ^c.
0	1	<p>14) If the attached ATA device supports the Removable Media feature set, then the SATL shall:</p> <ol style="list-style-type: none"> 1) Process the IMMED bit (see 9.11.2.1); 2) Issue a MEDIA EJECT command to the attached ATA device; 3) If the MEDIA EJECT command completes with any error, then process ending status according to the IMMED bit (see 9.11.2.3) with the additional sense code set to MEDIA LOAD OR EJECT FAILED; and 4) If the MEDIA EJECT command completes with no error, then process GOOD status according to the IMMED bit (see 9.11.2.2). <p>If the attached ATA device does not support the Removable Media feature set, then the SATL shall return CHECK CONDITION status with the sense key set to ILLEGAL REQUEST and the additional sense code set to INVALID FIELD IN CDB.</p>
1	1	<p>The SATL shall return CHECK CONDITION status with the sense key set to ILLEGAL REQUEST, with the additional sense code set to INVALID FIELD IN CDB.</p>
<p>^a An ATA device may return completion status for a STANDBY command before removal of the ATA device may be accomplished without damaging the ATA device.</p> <p>^b After returning GOOD status for a START STOP UNIT command with the START bit set to zero, the SATL shall consider the ATA device to be in the Stopped power state (see SBC-2).</p> <p>^c After returning GOOD status for a START STOP UNIT command with the START bit set to one, the SATL shall consider the ATA device to be in the Active power state (see SBC-2).</p> <p>^d An ATA device medium access occurs when an LBA is specified whose data is not contained in ATA device's cache memory. If a value in LBA is specified for an ATA verify command where the data is contained in ATA device's cache memory, then an ATA device may not be in the Active power mode (see ATA/ATAPI-7) after completion of the ATA verify command.</p>		

T Table 48, row 2, definition: change as follows:

The SATL shall:

- 1) If the IMMED bit is set to one, then return GOOD status;
- 2) Issue an ATA verify command (see 3.1.17) to the attached ATA device with one in Sector Count and a value in LBA from zero to the maximum LBA supported by the ATA device in its current configuration <superscript d>; and
- 3) If the IMMED bit is set to zero, return GOOD status when command completion is received for the ATA verify command (see 3.1.17) <superscript c>.

RESOLUTION: s/b

"The SATL shall:

- 1) If the bit is set to one, then return GOOD status;
- 2) Issue an ATA verify command (see 3.1.17) to the ATA device with the Sector Count set to one and the LBA set to a value between zero to the maximum LBA supported by the ATA device in its current configuration <superscript d>; and
- 3) If the IMMED bit is set to zero, return GOOD status when command completion is received for the ATA verify command (see 3.1.17) <superscript c>."

RESOLUTION: see 06-216

Status

risheffi Completed 7/23/2006 1:11:58 PM

Sequence number: 12

Author: SIERLGC[BMartin]

Subject: Note

Date: 7/12/2006 8:30:05 PM

 Page 5, Table 48

When starting a device, any command that causes a medium access will start the device. We would prefer that this operation specify ATA verify or ATA read command (with the appropriate references) change

"ATA verify command (see 3.1.17)" to "ATA verify command (see 3.1.17) or an ATA read command (see 3.1.xx) f".

Add a table footnote (replace "f" with appropriate letter):

f The SATL shall discard any data transferred.

Another suggestion - send IDLE IMMEDIATE.

Might check result with CHECK POWER MODE?

REASON: ATA verify has a higher probability of causing media access (SAT WG 7/11/06)

Status

risheffi Rejected 7/12/2006 7:53:43 PM

Sequence number: 13

Author: DELL[KMarks]

Subject: Highlight

Date: 6/22/2006 11:46:37 AM

T Table 48 — Definition of IMMED, LOEJ, and START bits in the START STOP UNIT CDB

Row: 1 0 In Definition column 2) in 1,2,3 list change

"2) Issue an ATA verify command (see 3.1.17) to the ATA device with one in Sector Count and a value in LBA from zero to the maximum LBA supported by the ATA device in its current configuration d; and"

to

"2) Issue an ATA verify command (see 3.1.17) to the ATA device with the Sector Count set to 1 and the ATA LBA set to a value between 0 and the maximum ATA LBA supported by the ATA device in its current configuration d; and"

RESOLUTION: see 06-216

Status

risheffi Completed 7/23/2006 1:12:32 PM

Sequence number: 14

Author: DELL[KMarks]

Subject: Highlight

Date: 6/22/2006 12:12:18 PM

T Table 48 — Definition of IMMED, LOEJ, and START bits in the START STOP UNIT CDB

Comments from page 75 continued on next page

9.11.3 START STOP UNIT START bit LOEJ bit combinations

The SATL shall perform the actions shown in table 48 in response to a START STOP UNIT command.

Table 48 — Definition of ~~IMMED~~, LOEJ, and START bits in the START STOP UNIT CDB

START	LOEJ	Definition
0	0	<p>The SATL shall:</p> <ol style="list-style-type: none"> 1) Process the IMMED bit (see 9.11.2.1); 2) Issue a FLUSH CACHE or FLUSH CACHE EXT command to the attached ATA device; 3) If the FLUSH CACHE or FLUSH CACHE EXTENDED command completes with any error, then process ending status according to the IMMED bit (see 9.11.2.3) with the additional sense code set to COMMAND SEQUENCE ERROR; 4) If the FLUSH CACHE or FLUSH CACHE EXT command completes with no error, then issue a STANDBY command to the attached ATA device with zero in Sector Count; 5) If the STANDBY command completes with any error, then process ending status according to the IMMED bit (see 9.11.2.3) with the additional sense code set to COMMAND SEQUENCE ERROR; and 6) If the STANDBY command completes with no error ^a, then process GOOD status according to the IMMED bit (see 9.11.2.2) ^b.
1	0	<p>The SATL shall:</p> <ol style="list-style-type: none"> 1) Process the IMMED bit (see 9.11.2.1); 2) Issue an ATA verify command (see 3.1.17) to the attached ATA device with one in Sector Count and a value in LBA from zero to the maximum LBA supported by the ATA device in its current configuration ^d; and 3) When command completion is received for the ATA verify command (see 3.1.17) process GOOD status according to the IMMED bit (see 9.11.2.2) ^c.
0	1	<p>¹⁵ If the attached ATA device supports the Removable Media feature set, then the SATL shall:</p> <ol style="list-style-type: none"> 1) Process the IMMED bit (see 9.11.2.1); 2) Issue a MEDIA EJECT command to the attached ATA device; 3) If the MEDIA EJECT command completes with any error, then process ending status according to the IMMED bit (see 9.11.2.3) with the additional sense code set to MEDIA LOAD OR EJECT FAILED; and 4) If the MEDIA EJECT command completes with no error, then process GOOD status according to the IMMED bit (see 9.11.2.2). <p>If the attached ATA device does not support the Removable Media feature set, then the SATL shall return CHECK CONDITION status with the sense key set to ILLEGAL REQUEST and the additional sense code set to INVALID FIELD IN CDB.</p>
1	1	<p>The SATL shall return CHECK CONDITION status with the sense key set to ILLEGAL REQUEST, with the additional sense code set to INVALID FIELD IN CDB.</p>
<p>¹⁶ An ATA device may return completion status for a STANDBY command before removal of the ATA device may be accomplished without damaging the ATA device.</p> <p>^b After returning GOOD status for a START STOP UNIT command with the START bit set to zero, the SATL shall consider the ATA device to be in the Stopped power state (see SBC-2).</p> <p>^c After returning GOOD status for a START STOP UNIT command with the START bit set to one, the SATL shall consider the ATA device to be in the Active power state (see SBC-2).</p> <p>^d An ATA device medium access occurs when an LBA is specified whose data is not contained in ATA device's cache memory. If a value in LBA is specified for an ATA verify command where the data is contained in ATA device's cache memory, then an ATA device may not be in the Active power mode (see ATA/ATAPI-7) after completion of the ATA verify command.</p>		

Row: 0 1 In Definition column

change

"If the attached ATA device supports the Removable Media feature set, then the SATL shall:

- 1) Process the IMMEDIATE bit (see 9.11.2.1);
- 2) Issue a MEDIA EJECT command to the attached ATA device;
- 3) If the MEDIA EJECT command completes with any error, then process ending status according to the IMMEDIATE bit (see 9.11.2.3) with the additional sense code set to MEDIA LOAD OR EJECT FAILED; and
- 4) If the MEDIA EJECT command completes with no error, then process GOOD status according to the IMMEDIATE bit (see 9.11.2.2).

If the attached ATA device does not support the Removable Media feature set, then the SATL shall return CHECK CONDITION status with the sense key set to ILLEGAL REQUEST and the additional sense code set to INVALID FIELD IN CDB."

to

"If the ATA device supports the Removable Media feature set (i.e., ATA IDENTIFY DEVICE data word 82, bit 2 is set to one), then the SATL shall:

- 1) Process the IMMEDIATE bit (see 9.11.2.1);
- 2) Issue an ATA MEDIA EJECT command to the ATA device;
- 3) If the ATA MEDIA EJECT command completes with an error, process ending status according to the IMMEDIATE bit (see 9.11.2.3) with the additional sense code set to MEDIA LOAD OR EJECT FAILED; and
- 4) If the ATA MEDIA EJECT command completes with no error, process GOOD status according to the IMMEDIATE bit (see 9.11.2.2).

If the ATA device does not support the Removable Media feature set, then the SATL shall return CHECK CONDITION status with the sense key set to ILLEGAL REQUEST and the additional sense code set to INVALID FIELD IN CDB."

RESOLUTION: see 06-216

Status

risheffi Completed 7/23/2006 1:12:48 PM

Sequence number: 15

Author: MXO[MEvans]

Subject: Highlight

Date: 6/22/2006 12:09:57 PM

T Table 48, row 1, definition: change as follows:

If the attached ATA device supports the Removable Media feature set, then the SATL shall:

- 1) If the IMMEDIATE bit is set to one, then return GOOD status;
- 2) Issue a MEDIA EJECT command to the attached ATA device;
- 3) If the MEDIA EJECT command completes with any error, then process ending status as specified in 9.11.2 with the additional sense code set to MEDIA LOAD OR EJECT FAILED; and
- 4) If the MEDIA EJECT command completes with no error, and the IMMEDIATE bit is set to zero, then return GOOD status.

If the attached ATA device does not support the Removable Media feature set, then the SATL shall return CHECK CONDITION status with the sense key set to ILLEGAL REQUEST and the additional sense code set to INVALID FIELD IN CDB.

RESOLUTION: s/b

"If the attached ATA device supports the Removable Media feature set, then the SATL shall:

- 1) If the IMMEDIATE bit is set to one, then return GOOD status;
- 2) Issue an ATA MEDIA EJECT command to the ATA device;
- 3) If the ATA MEDIA EJECT command completes with an error, then process ending status according to the IMMEDIATE bit (see 9.11.2) with the additional sense code set to MEDIA LOAD OR EJECT FAILED; and
- 4) If the ATA MEDIA EJECT command completes without error, and the IMMEDIATE bit is set to zero, then return GOOD status.

If the ATA device does not support the Removable Media feature set, then the SATL shall return CHECK CONDITION status with the sense key set to ILLEGAL REQUEST and the additional sense code set to INVALID FIELD IN CDB.

RESOLUTION: see 06-216

Status

risheffi Completed 7/23/2006 1:12:55 PM

Sequence number: 16

Comments from page 75 continued on next page

9.11.3 START STOP UNIT START bit LOEJ bit combinations

The SATL shall perform the actions shown in table 48 in response to a START STOP UNIT command.

Table 48 — Definition of ~~IMMED~~, LOEJ, and START bits in the START STOP UNIT CDB

START	LOEJ	Definition
0	0	<p>The SATL shall:</p> <ol style="list-style-type: none"> 1) Process the IMMED bit (see 9.11.2.1); 2) Issue a FLUSH CACHE or FLUSH CACHE EXT command to the attached ATA device; 3) If the FLUSH CACHE or FLUSH CACHE EXTENDED command completes with any error, then process ending status according to the IMMED bit (see 9.11.2.3) with the additional sense code set to COMMAND SEQUENCE ERROR; 4) If the FLUSH CACHE or FLUSH CACHE EXT command completes with no error, then issue a STANDBY command to the attached ATA device with zero in Sector Count; 5) If the STANDBY command completes with any error, then process ending status according to the IMMED bit (see 9.11.2.3) with the additional sense code set to COMMAND SEQUENCE ERROR; and 6) If the STANDBY command completes with no error ^a, then process GOOD status according to the IMMED bit (see 9.11.2.2) ^b.
1	0	<p>The SATL shall:</p> <ol style="list-style-type: none"> 1) Process the IMMED bit (see 9.11.2.1); 2) Issue an ATA verify command (see 3.1.17) to the attached ATA device with one in Sector Count and a value in LBA from zero to the maximum LBA supported by the ATA device in its current configuration ^d; and 3) When command completion is received for the ATA verify command (see 3.1.17) process GOOD status according to the IMMED bit (see 9.11.2.2) ^c.
0	1	<p>If the attached ATA device supports the Removable Media feature set, then the SATL shall:</p> <ol style="list-style-type: none"> 1) Process the IMMED bit (see 9.11.2.1); 2) Issue a MEDIA EJECT command to the attached ATA device; 3) If the MEDIA EJECT command completes with any error, then process ending status according to the IMMED bit (see 9.11.2.3) with the additional sense code set to MEDIA LOAD OR EJECT FAILED; and 4) If the MEDIA EJECT command completes with no error, then process GOOD status according to the IMMED bit (see 9.11.2.2). <p>If the attached ATA device does not support the Removable Media feature set, then the SATL shall return CHECK CONDITION status with the sense key set to ILLEGAL REQUEST and the additional sense code set to INVALID FIELD IN CDB.</p>
1	1	<p>The SATL shall return CHECK CONDITION status with the sense key set to ILLEGAL REQUEST, with the additional sense code set to INVALID FIELD IN CDB.</p>
<p>^a An ATA device may return completion status for a STANDBY command before removal of the ATA device may be accomplished without damaging the ATA device.</p> <p>^b After returning GOOD status for a START STOP UNIT command with the START bit set to zero, the SATL shall consider the ATA device to be in the Stopped power state (see SBC-2).</p> <p>^c After returning GOOD status for a START STOP UNIT command with the START bit set to one, the SATL shall consider the ATA device to be in the Active power state (see SBC-2).</p> <p>^d An ATA device medium access occurs when an LBA is specified whose data is not contained in ATA device's cache memory. If a value in LBA is specified for an ATA verify command where the data is contained in ATA device's cache memory, then an ATA device may not be in the Active power mode ¹⁷ after completion of the ATA verify command.</p>		

Author: DELL[KMarks]
Subject: Highlight
Date: 7/23/2006 1:13:41 PM

T **Table 48 — Definition of IMMED, LOEJ, and START bits in the START STOP UNIT CDB**

footnote a
change

"a An ATA device may return completion status for a STANDBY command before removal of the ATA device may be accomplished without damaging the ATA device."

to

"a An ATA device may return completion status for an ATA STANDBY command before removal of the ATA device may be accomplished without damaging the ATA device."

RESOLUTION: see 06-216 (delete table footnote a)

Status
risheffi Completed 7/23/2006 1:13:45 PM

Sequence number: 17
Author: EDITOR[risheffi]
Subject: Highlight
Date: 6/22/2006 12:23:26 PM

T **Table 48 — Definition of IMMED, LOEJ, and START bits in the START STOP UNIT CDB**

Table footnote d)
change

"(see ATA/ATAPI-7)"

to

"(see ATA8-ACS)"

RESOLUTION: see 06-216

Status
risheffi Completed 7/23/2006 1:14:00 PM

9.12 SYNCHRONIZE CACHE (10) command

12.1 SYNCHRONIZE CACHE (10) command overview

The SYNCHRONIZE CACHE (10) command is used to flush the most recent data values in the ATA device's cache to physical medium. Unlike in SCSI, ATA does not provide a way to specify a particular LBA to start flushing the ATA device's cache.

Table 49 — SYNCHRONIZE CACHE (10) command CDB fields

Field	Description or reference
OPERATION CODE	The SATL shall issue an ATA flush command (see 3.1.8) in accordance with the constraints described in 9.1
SYNC_NV	Unspecified (see 3.4.3)
IMMED	If the IMMED bit is set to one the SATL shall return GOOD status and then issue an ATA flush command. If the IMMED bit is set to zero the SATL shall issue an ATA flush command and return status upon completion.
LOGICAL BLOCK ADDRESS	The SATL shall ignore this field and shall process this command as though this field contained zero.
GROUP NUMBER	Unspecified (see 3.4.3)
NUMBER OF BLOCKS	The SATL shall ignore this field and shall process this command as though this field contained zero (i.e., synchronize all logical blocks starting with the one specified in the LOGICAL BLOCK ADDRESS field to the last logical block on the ATA device's medium).
CONTROL	6.4

Sequence number: 1
Author: HPQ[RElliott]
Subject: Cross-Out
Date: 6/22/2006 12:24:15 PM

T9.12.1 SYNCHRONIZE CACHE (10) command overview

Delete this header - no need for an additional layer of hierarchy as there is no 9.12.2
RESOLUTION: see 06-216

Status
rlsheffi Completed 7/23/2006 1:14:52 PM

Sequence number: 2
Author: IBM[GPenokie]
Subject: Underline
Date: 2/16/2006 1:39:52 PM

T9.12.1 SYNCHRONIZE CACHE (10) command overview

Status
rlsheffi Cancelled 5/4/2006 2:19:25 PM

Sequence number: 3
Author: DELL[KMarks]
Subject: Highlight
Date: 6/22/2006 12:31:54 PM

T9.12.1 SYNCHRONIZE CACHE (10) command overview

**1st Paragraph
change**

"The SYNCHRONIZE CACHE (10) command is used to flush the most recent data values in the ATA device's cache to physical medium. Unlike in SCSI, ATA does not provide a way to specify a particular LBA to start flushing the ATA device's cache."

to

"The SYNCHRONIZE CACHE (10) command is used to flush the most recent data in the cache of the ATA device to physical medium. Unlike in SCSI, ATA protocol does not provide a way to specify a particular LBA to start flushing the cache of the ATA device."

Table 49 shows the translation for fields specified in the SYNCHRONIZE CACHE(10) CDB."

RESOLUTION: s/b

"The SYNCHRONIZE CACHE (10) command is used to flush the most recent data in the cache of the ATA device to physical medium."

Table 49 shows the translation for fields specified in the SYNCHRONIZE CACHE(10) CDB."

RESOLUTION: see 06-216

Status
rlsheffi Completed 7/23/2006 1:15:09 PM

Sequence number: 4
Author: IBM[GPenokie]
Subject: Comment on Text
Date: 7/23/2006 1:15:29 PM

T1st paragraph
This << Unlike in SCSI, ATA does not provide a way to specify a particular LBA to start flushing the ATA device's cache. >> should be deleted as there is no value or need to justify the actions defined by the standard.

RESOLUTION: see 06-216 (deleted)

Status
rlsheffi Completed 7/23/2006 1:15:32 PM

Sequence number: 5
Author: HPQ[RElliott]

9.12 SYNCHRONIZE CACHE (10) command

9.12.1 SYNCHRONIZE CACHE (10) command overview

The SYNCHRONIZE CACHE (10) command is used to flush the most recent data values in the ATA device's cache to physical medium. Unlike in SCSI, ATA does not provide a way to specify a particular LBA to start flushing the ATA device's cache.



Table 49 — SYNCHRONIZE CACHE (10) command CDB fields

Field	Description or reference
OPERATION CODE	The SATL shall issue an ATA flush command (see 3.1.8) in accordance with the constraints described in 9.1
SYNC_NV	Unspecified (see 3.4.3)
IMMED	If the IMMED bit is set to one the SATL shall return GOOD status and then issue an ATA flush command. If the IMMED bit is set to zero the SATL shall issue an ATA flush command and return status upon completion.
LOGICAL BLOCK ADDRESS	The SATL shall ignore this field and shall process this command as though this field contained zero.
GROUP NUMBER	Unspecified (see 3.4.3)
NUMBER OF BLOCKS	The SATL shall ignore this field and shall process this command as though this field contained zero. <i>i.e.</i> , synchronize all logical blocks starting with the one specified in the LOGICAL BLOCK ADDRESS field to the last logical block on the ATA device's medium).
CONTROL	6.4

Date: 6/22/2006 12:35:11 PM

9.12.1

need a reference to table 49

RESOLUTION: see 06-216

Status

rlsheffi Completed 7/23/2006 1:15:44 PM

Sequence number: 6
Author: IBM[GPenokie]
Subject: Highlight
Date: 6/22/2006 12:35:04 PM

T There is no reference to table 49. This needs to be fixed as all tables have to be referenced.

RESOLUTION: see 06-216

Status

rlsheffi Completed 7/23/2006 1:15:51 PM

Sequence number: 7
Author: DELL[KMarks]
Subject: Note
Date: 6/22/2006 12:34:57 PM

T **Table 49 — SYNCHRONIZE CACHE (10) command CDB fields**
Row: OPERATION CODE

Per comment on Table 34 - FLUSH CACHE and FLUSH CACHE EXT are removed from table, and there are no constraints described for these.

REASON: Rejected comment to remove FLUSH CACHE and FLUSH CACHE EXT form table 34, but fixed the problem in table-34 by other means (see comment resolutions for table 34).

RESOLUTION: see 06-216

Status

rlsheffi Rejected 5/4/2006 2:42:29 PM

Sequence number: 8
Author: DELL[KMarks]
Subject: Highlight
Date: 6/22/2006 12:34:51 PM

T **Table 49 — SYNCHRONIZE CACHE (10) command CDB fields**
Row: NUMBER OF BLOCKS

change

"The SATL shall ignore this field and shall process this command as though this field contained zero (i.e., synchronize all logical blocks starting with the one specified in the LOGICAL BLOCK ADDRESS field to the last logical block on the ATA device's medium)."

to

"The SATL shall ignore this field and shall process this command as though this field contained zero (see SBC-2)."

RESOLUTION: see 06-216

Status

rlsheffi Completed 7/23/2006 1:16:13 PM

Sequence number: 9
Author: HPQ[RElliott]
Subject: Highlight
Date: 6/22/2006 12:34:44 PM

T 9.12
table 49

"(i.e., synchronize all logical blocks starting with the one specified in the LOGICAL BLOCK ADDRESS field to the last logical block on the ATA device's medium)."

Although that's the correct meaning in SCSI, 2 rows above this entry stated that the logical block address of 0 is always used as the first. So, the meaning in SAT is that the entire medium is synchronized.

RESOLUTION: see 06-216

Status

Comments from page 76 continued on next page

9.12 SYNCHRONIZE CACHE (10) command

9.12.1 SYNCHRONIZE CACHE (10) command overview

The SYNCHRONIZE CACHE (10) command is used to flush the most recent data values in the ATA device's cache to physical medium. Unlike in SCSI, ATA does not provide a way to specify a particular LBA to start flushing the ATA device's cache.



Table 49 — SYNCHRONIZE CACHE (10) command CDB fields

Field	Description or reference
OPERATION CODE	The SATL shall issue an ATA flush command (see 3.1.8) in accordance with the constraints described in 9.1
SYNC_NV	Unspecified (see 3.4.3)
IMMED	If the IMMED bit is set to one the SATL shall return GOOD status and then issue an ATA flush command. If the IMMED bit is set to zero the SATL shall issue an ATA flush command and return status upon completion.
LOGICAL BLOCK ADDRESS	The SATL shall ignore this field and shall process this command as though this field contained zero.
GROUP NUMBER	Unspecified (see 3.4.3)
NUMBER OF BLOCKS	The SATL shall ignore this field and shall process this command as though this field contained zero (i.e., synchronize all logical blocks starting with the one specified in the LOGICAL BLOCK ADDRESS field to the last logical block on the ATA device's medium).
CONTROL	6.4

9.13 SYNCHRONIZE CACHE (16) command

9.13.1 SYNCHRONIZE CACHE (16) command overview

The SYNCHRONIZE CACHE(16) command is used to flush the most recent data values in the ATA device's cache to ATA device's physical medium. Unlike in SCSI, ATA does not provide a way to specify a particular LBA to start flushing the device cache.

Table 50 — SYNCHRONIZE CACHE(10) command CDB fields

Field	Description or reference
OPERATION CODE	The SATL shall issue an ATA flush command (see 3.1.8) in accordance with the constraints described in 9.1.
SYNC_NV	Unspecified (see 3.4.3)
IMMED	If one return GOOD status immediately then issue an ATA flush command. If zero, issue an ATA flush command and return status upon completion.
LOGICAL BLOCK ADDRESS	The SATL shall ignore this field and shall process this command as though this field contained zero.
GROUP NUMBER	Unspecified (see 3.4.3)
NUMBER OF BLOCKS	The SATL shall ignore this field and shall process this command as though this field contained zero (i.e., synchronize all logical blocks starting with the one specified in the LOGICAL BLOCK ADDRESS field to the last logical block on the ATA device's medium).
CONTROL	6.4

9.14 VERIFY (10) command

The VERIFY (10) command is used to verify data on the ATA device's medium. Table 51 describes the translation of fields in the VERIFY (10) CDB.

Table 51 — VERIFY (10) command CDB fields

Field	Description or reference
OPERATION CODE	The SATL shall issue an ATA verify command (see 3.1.17) in accordance with the constraints defined in 9.1.
VRPROTECT	Unspecified (see 3.4.3)
DPO	Unspecified (see 3.4.3)
BYTCHK	If the SATL supports a bytchk value of one and the CDB specifies one in the BYTCHK field, the SATL perform a byte by byte comparison of the data transferred from the SCSI application client to the SATL with data read from the ATA device by the SATL, and shall return the results of that comparison as described in SBC-2.
LOGICAL BLOCK ADDRESS	The logical block address shall be used to set the ATA LBA (see 3.1.11).
GROUP NUMBER	Unspecified (see 3.4.3)
VERIFICATION LENGTH	The verification length shall be used to set the ATA Sector Count (see 9.1).
CONTROL	6.4

Sequence number: 1
Author: HPQ[RElliott]
Subject: Cross-Out
Date: 6/22/2006 12:35:53 PM
T9.13.1 SYNCHRONIZE CACHE (16) command overview

Delete this header - no need for an additional layer of hierarchy as there is no 9.13.2

RESOLUTION: see 06-216

Status
rlsheffi Completed 7/23/2006 1:16:32 PM

Sequence number: 2
Author: IBM[GPenokie]
Subject: Underline
Date: 2/16/2006 1:40:10 PM
T9.13.1 SYNCHRONIZE CACHE (16) command overview

Status
rlsheffi Cancelled 5/5/2006 1:35:33 PM

Sequence number: 3
Author: DELL[KMarks]
Subject: Highlight
Date: 6/22/2006 12:43:15 PM
T9.13.1 SYNCHRONIZE CACHE (16) command overview
1st Paragraph change

"The SYNCHRONIZE CACHE(16) command is used to flush the most recent data values in the ATA device's cache to ATA device's physical medium. Unlike in SCSI, ATA does not provide a way to specify a particular LBA to start flushing the device cache."

to

"The SYNCHRONIZE CACHE (16) command is used to flush the most recent data in the cache of the ATA device to physical medium. Unlike in SCSI, ATA protocol does not provide a way to specify a particular LBA to start flushing the cache of the ATA device.

Table 50 shows the translation for fields specified in the SYNCHRONIZE CACHE(16) CDB."

RESOLUTION: s/b

"The SYNCHRONIZE CACHE (16) command is used to flush the most recent data in the cache of the ATA device to physical medium.

Table 50 shows the translation for fields specified in the SYNCHRONIZE CACHE(16) CDB."

RESOLUTION: see 06-216

Status
rlsheffi Completed 7/23/2006 1:16:47 PM

Sequence number: 4
Author: HPQ[RElliott]
Date: 6/22/2006 12:43:27 PM
 9.13.1

need a reference to table 50

RESOLUTION: see 06-216

Status
rlsheffi Completed 7/23/2006 1:17:08 PM

9.13 SYNCHRONIZE CACHE (16) command

9.13.1 SYNCHRONIZE CACHE (16) command overview

The SYNCHRONIZE CACHE(16) command is used to flush the most recent data values in the ATA device's cache to ATA device's physical medium. Unlike in SCSI, ATA does not provide a way to specify a particular LBA to start flushing the device cache.

Table 60 — SYNCHRONIZE CACHE(16) command CDB fields

Field	Description or reference
OPERATION CODE	The SATL shall issue an ATA flush command (see 3.1.8) in accordance with the constraints described in 9.1.
SYNC_NV	Unspecified (see 3.4.3)
IMMED	If one return GOOD status immediately then issue an ATA flush command. If zero, issue an ATA flush command and return status upon completion.
LOGICAL BLOCK ADDRESS	The SATL shall ignore this field and shall process this command as though this field contained zero.
GROUP NUMBER	Unspecified (see 3.4.3)
NUMBER OF BLOCKS	The SATL shall ignore this field and shall process this command as though this field contained zero (i.e., synchronize all logical blocks starting with the one specified in the LOGICAL BLOCK ADDRESS field to the last logical block on the ATA device's medium).
CONTROL	6.4

9.14 VERIFY (10) command

The VERIFY (10) command is used to verify data on the ATA device's medium. Table 51 describes the translation of fields in the VERIFY (10) CDB.

Table 51 — VERIFY (10) command CDB fields

Field	Description or reference
OPERATION CODE	The SATL shall issue an ATA verify command (see 3.1.17) in accordance with the constraints defined in 9.1.
VRPROTECT	Unspecified (see 3.4.3)
DPO	Unspecified (see 3.4.3)
BYTCHK	If the SATL supports a bytchk value of one and the CDB specifies one in the BYTCHK field, the SATL perform a byte by byte comparison of the data transferred from the SCSI application client to the SATL with data read from the ATA device by the SATL, and shall return the results of that comparison as described in SBC-2.
LOGICAL BLOCK ADDRESS	The logical block address shall be used to set the ATA LBA (see 3.1.11).
GROUP NUMBER	Unspecified (see 3.4.3)
VERIFICATION LENGTH	The verification length shall be used to set the ATA Sector Count (see 9.1).
CONTROL	6.4

Sequence number: 5
Author: IBM[GPenokie]
Subject: Highlight
Date: 7/23/2006 1:17:38 PM

 1st paragraph

This << Unlike in SCSI, ATA does not provide a way to specify a particular LBA to start flushing the ATA device's cache. >> should be deleted as there is no value or need to justify the actions defined by the standard.

RESOLUTION: see 06-216 (deleted)

Status
risheffi Completed 7/23/2006 1:17:47 PM

Sequence number: 6
Author: QDSS[PSuhler]
Subject: Highlight
Date: 6/22/2006 12:44:22 PM

 Page: 77

9.14

Editorial

Table 50 caption.

Numerals 5 and 0 are in different font sizes.

REASON: Looks OK on editor's PC, and source document has same font characteristics (10 pt. ARIAL bold) for all digit locations.

Tables are auto-numbered, so there's no way to specify different font characteristics for different digit locations in the first place.

Status
risheffi Rejected 5/5/2006 1:27:58 PM

Sequence number: 7
Author: DELL[KMarks]
Subject: Highlight
Date: 7/23/2006 1:18:57 PM

 Table 50 — SYNCHRONIZE CACHE(10) command CDB fields

change table 50 title to

"Table 50 — SYNCHRONIZE CACHE(16) command CDB fields"

RESOLUTION: see 06-216 s/b (fixed in SAT-r08c)

"Table 50 — SYNCHRONIZE CACHE(16) CDB field translations"

Status
risheffi Completed 7/23/2006 1:19:12 PM

Sequence number: 8
Author: DELL[KMarks]
Subject: Note
Date: 5/5/2006 1:42:28 PM

 **Table 50 — SYNCHRONIZE CACHE (10) command CDB fields**
Row: OPERATION CODE

Per comment on Table 34 - FLUSH CACHE and FLUSH CACHE EXT are removed from table, and there are no constraints described for these.

REASON: Rejected comment to remove FLUSH CACHE and FLUSH CACHE EXT form table 34, but fixed the problem in table-34 by other means (see comment resolutions for table 34).

Status
risheffi Rejected 5/5/2006 1:42:15 PM

Sequence number: 9
Author: HPQ[RElliott]
Subject: Note
Date: 6/22/2006 1:08:09 PM

 9.13

table 50

Make all these descriptions match those in table 49

RESOLUTION: see 06-216

Status

Comments from page 77 continued on next page

rlsheffi Completed 7/23/2006 1:19:31 PM

Sequence number: 10
Author: WDC[CStevens]
Subject: Comment on Text
Date: 7/12/2006 7:59:52 PM

T This is a very strong statement. If the SATL was caching, couldn't it honor this field correctly? This should be a should.

REASON: Rejected by SAT WG straw-poll (7/11/06) - see 06-216r2

Status
rlsheffi Rejected 7/12/2006 7:59:36 PM

Sequence number: 11
Author: DELL[KMarks]
Subject: Highlight
Date: 6/22/2006 1:12:43 PM

T **Table 50 — SYNCHRONIZE CACHE (10) command CDB fields**
Row: NUMBER OF BLOCKS

change

"The SATL shall ignore this field and shall process this command as though this field contained zero (i.e., synchronize all logical blocks starting with the one specified in the LOGICAL BLOCK ADDRESS field to the last logical block on the ATA device's medium)."

to

"The SATL shall ignore this field and shall process this command as though this field contained zero (see SBC-2)."

RESOLUTION: see 06-216

Status
rlsheffi Completed 7/23/2006 1:20:02 PM

Sequence number: 12
Author: MXO[MEvans]
Subject: Highlight
Date: 6/22/2006 1:13:04 PM

T Table 50, row 6, description: change the "i.e." to be, "(i.e., synchronize all logical blocks starting with the one specified in the LOGICAL BLOCK ADDRESS field to the last logical block on the ATA device's medium)"

RESOLUTION: see 06-216 - remove entire parenthetical statement (see DELL comment)

Status
rlsheffi Completed 7/23/2006 1:20:16 PM

Sequence number: 13
Author: IBM[GPenokie]
Subject: Comment on Text
Date: 6/22/2006 1:13:19 PM

T table 50 2nd to last row
The red cross-out text needs to be removed.

RESOLUTION: see 06-216 - remove entire parenthetical statement (see DELL comment)

Status
rlsheffi Completed 7/23/2006 1:20:31 PM

Sequence number: 14
Author: ENDL[RWeber]
Date: 6/22/2006 1:13:33 PM

T table 50, row 6
Remove the red strikeout text.

RESOLUTION: see 06-216

Status
rlsheffi Completed 7/23/2006 1:20:47 PM

Sequence number: 15
Author: HPQ[RElliott]
Subject: Highlight
Date: 6/22/2006 1:13:46 PM

T 9.13.1
table 50

Remove red and underline from "LOGICAL BLOCK ADDRESS"

Comments from page 77 continued on next page

9.13 SYNCHRONIZE CACHE (16) command

9.13.1 SYNCHRONIZE CACHE (16) command overview

The SYNCHRONIZE CACHE(16) command is used to flush the most recent data values in the ATA device's cache to ATA device's physical medium. Unlike in SCSI, ATA does not provide a way to specify a particular LBA to start flushing the device cache.

Table 50 — SYNCHRONIZE CACHE(10) command CDB fields

Field	Description or reference
OPERATION CODE	The SATL shall issue an ATA flush command (see 3.1.8) in accordance with the constraints described in 9.1.
SYNC_NV	Unspecified (see 3.4.3)
IMMED	If one return GOOD status immediately then issue an ATA flush command. If zero, issue an ATA flush command and return status upon completion.
LOGICAL BLOCK ADDRESS	The SATL shall ignore this field and shall process this command as though this field contained zero.
GROUP NUMBER	Unspecified (see 3.4.3)
NUMBER OF BLOCKS	The SATL shall ignore this field and shall process this command as though this field contained zero (i.e., synchronize all logical blocks starting with the one specified in the LOGICAL BLOCK ADDRESS field to the last logical block on the ATA device's medium).
CONTROL	6.4

9.14 VERIFY (10) command

The VERIFY (10) command is used to verify data on the ATA device's medium. Table 51 describes the translation of fields in the VERIFY (10) CDB.

Table 51 — VERIFY (10) command CDB fields

Field	Description or reference
OPERATION CODE	The SATL shall issue an ATA verify command (see 3.1.17) in accordance with the constraints defined in 9.1.
VRPROTECT	Unspecified (see 3.4.3)
DPO	Unspecified (see 3.4.3)
BYTCHK	If the SATL supports a BYTCHK value of one and the CDB specifies one in the BYTCHK field, the SATL perform a byte by byte comparison of the data transferred from the SCSI application client to the SATL with data read from the ATA device by the SATL, and shall return the results of that comparison as described in SBC-2.
LOGICAL BLOCK ADDRESS	The logical block address shall be used to set the ATA LBA (see 3.1.11).
GROUP NUMBER	Unspecified (see 3.4.3)
VERIFICATION LENGTH	The verification length shall be used to set the ATA Sector Count (see 9.1).
CONTROL	6.4

RESOLUTION: see 06-216

Status
rlsheffi Completed 7/23/2006 1:21:07 PM

Sequence number: 16
Author: STX[GHolder]
Subject: Highlight
Date: 6/22/2006 1:14:34 PM

T PDF page 76
table 50, NUMBER OF BLOCKS description field
When printed, "LOGICAL BLOCK ADDRESS" has a strike-through

RESOLUTION: see 06-216 - remove entire parenthetical statement (see DELL comment)

Status
rlsheffi Completed 7/23/2006 1:21:29 PM

Sequence number: 17
Author: WDC[CStevens]
Subject: Comment on Text
Date: 6/22/2006 1:14:06 PM

T What field?

RESOLUTION: see 06-216: remove entire parenthetical statement (see DELL comment)

Status
rlsheffi Completed 7/23/2006 1:21:19 PM

Sequence number: 18
Author: IBM[GPenokie]
Subject: Underline
Date: 2/16/2006 1:43:27 PM

T 9.14 VERIFY (10) command

Status
rlsheffi Cancelled 5/5/2006 1:51:17 PM

Sequence number: 19
Author: QDSS[PSuhler]
Subject: Highlight
Date: 5/5/2006 1:52:31 PM

T Page: 77
9.14
Editorial
Second sentence begins "Table 51 describes..."
Numerals 5 and 1 are in different font sizes. Same for table caption.
REASON: Editor doesn't see the difference, and doesn't know how to fix it if he did.

Status
rlsheffi Rejected 5/5/2006 1:52:36 PM

Sequence number: 20
Author: DELL[KMarks]
Subject: Highlight
Date: 4/9/2006 11:44:18 AM

T Table 51 — VERIFY (10) command CDB fields
Row: VRPROTECT

This field can not be set to Unspecified, because the PROTECT bit in the INQUIRY data is a shall be set to zero. Change the PROTECT bit to Unspecified or change this field to if not 000b, then CHECK CONDITION/IR/IFIC.

REASON: Changed the PROTECT bit in INQUIRY data to "Unspecified (see 3.4.3)" instead - consistent with the rest of the document.

Status
rlsheffi Rejected 5/5/2006 1:53:30 PM

Sequence number: 21
Author: STX[GHolder]
Subject: Highlight
Date: 6/22/2006 1:28:41 PM

T PDF page 76, table 51, BYTCHK description field

Comments from page 77 continued on next page

9.13 SYNCHRONIZE CACHE (16) command

9.13.1 SYNCHRONIZE CACHE (16) command overview

The SYNCHRONIZE CACHE(16) command is used to flush the most recent data values in the ATA device's cache to ATA device's physical medium. Unlike in SCSI, ATA does not provide a way to specify a particular LBA to start flushing the device cache.

Table 50 — SYNCHRONIZE CACHE(10) command CDB fields

Field	Description or reference
OPERATION CODE	The SATL shall issue an ATA flush command (see 3.1.8) in accordance with the constraints described in 9.1.
SYNC_NV	Unspecified (see 3.4.3)
IMMED	If one return GOOD status immediately then issue an ATA flush command. If zero, issue an ATA flush command and return status upon completion.
LOGICAL BLOCK ADDRESS	The SATL shall ignore this field and shall process this command as though this field contained zero.
GROUP NUMBER	Unspecified (see 3.4.3)
NUMBER OF BLOCKS	The SATL shall ignore this field and shall process this command as though this field contained zero (i.e., synchronize all logical blocks starting with the one specified in the LOGICAL BLOCK ADDRESS field to the last logical block on the ATA device's medium).
CONTROL	6.4

9.14 VERIFY (10) command

The VERIFY (10) command is used to verify data on the ATA device's medium. Table 51 describes the translation of fields in the VERIFY (10) CDB.

Table 51 — VERIFY (10) command CDB fields

Field	Description or reference
OPERATION CODE	The SATL shall issue an ATA verify command (see 3.1.17) in accordance with the constraints defined in 9.1.
VRPROTECT	Unspecified (see 3.4.3)
DPO	Unspecified (see 3.4.3)
BYTCHK	The SATL supports a bytchk value of one and the CDB specifies one in the BYTCHK field, the SATL perform a byte by byte comparison of the data transferred from the SCSI application client to the SATL with data read from the ATA device by the SATL, and shall return the results of that comparison as described in SBC-2.
LOGICAL BLOCK ADDRESS	The logical block address shall be used to set the ATA LBA (see 3.1.11).
GROUP NUMBER	Unspecified (see 3.4.3)
VERIFICATION LENGTH	The verification length shall be used to set the ATA Sector Count (see 9.1).
CONTROL	6.4

"If the SATA supports a bytchk value..."
Should 'bytchk' be in small-caps ?
RESOLUTION: see 06-216

Status
risheffi Completed 7/23/2006 1:23:04 PM

Sequence number: 22
Author: DELL[KMarks]
Subject: Highlight
Date: 6/22/2006 1:28:19 PM

T Table 51 — VERIFY (10) command CDB fields
Row: BYTCHK
change

"If the SATL supports a bytchk value of one and the CDB specifies one in the BYTCHK field, the SATL perform a byte by byte comparison of the data transferred from the SCSI application client to the SATL with data read from the ATA device by the SATL, and shall return the results of that comparison as described in SBC-2."

to

"If the SATL supports a BYTCHK bit set to one and the CDB specifies one in the BYTCHK field, the SATL shall perform a byte by byte comparison of the data transferred from the application client to the SATL with data read from the ATA device by the SATL and return the results of that comparison as described in SBC-2."

RESOLUTION: see 06-216 - s/b

"If the SATL supports a BYTCHK bit set to one and if the BYTCHK bit is set to one, then the SATL shall perform a byte-by-byte comparison of the data transferred from the application client to the SATL with data read from the ATA device by the SATL, and return completion status reflecting the results of the comparison (see SBC-2)."

Status
risheffi Completed 7/23/2006 1:23:27 PM

Sequence number: 23
Author: IBM[GPenokie]
Subject: Comment on Text
Date: 6/22/2006 1:28:30 PM

T table 51 - bytchk row
This << If the SATL supports a bytchk value of one and >> should be << If the SATL supports a BYTCHK bit set to one and >>
RESOLUTION: see 06-216

Status
risheffi Completed 7/23/2006 1:23:40 PM

9.15 VERIFY (12) command

Table 52 describes the translation of fields in the VERIFY (12) CDB.

Table 52 — VERIFY (12) command CDB fields

Field	Description or reference
OPERATION CODE	The SATL shall issue an ATA verify command (see 3.1.17) in accordance with the constraints defined in 9.1.
VRPROTECT	Unspecified (see 3.4.3)
DPO	Unspecified (see 3.4.3)
BYTCHK	If the SATL supports a bytchk value of one and the CDB specifies one in the BYTCHK field, the SATL perform a byte by byte comparison of the data transferred from the SCSI application client to the SATL with data read from the ATA device by the SATL, and shall return the results of that comparison as described in SBC-2.
LOGICAL BLOCK ADDRESS	The logical block address shall be used to set the ATA LBA (see 3.1.11).
GROUP NUMBER	Unspecified (see 3.4.3)
VERIFICATION LENGTH	The verification length shall be used to set the ATA Sector Count (see 9.1).
CONTROL	6.4

9.16 VERIFY (16) command

Table 53 describes the translation of fields in the VERIFY (16) CDB.

Table 53 — VERIFY (16) command CDB fields

Field	Description or reference
OPERATION CODE	The SATL shall issue an ATA verify command (see 3.1.17) in accordance with the constraints defined in 9.1.
VRPROTECT	Unspecified (see 3.4.3)
DPO	Unspecified (see 3.4.3)
BYTCHK	If the SATL supports a bytchk value of one and the CDB specifies one in the BYTCHK field, the SATL perform a byte by byte comparison of the data transferred from the SCSI application client to the SATL with data read from the ATA device by the SATL, and shall return the results of that comparison as described in SBC-2.
LOGICAL BLOCK ADDRESS	The logical block address shall be used to set the ATA LBA (see 3.1.11).
GROUP NUMBER	Unspecified (see 3.4.3)
VERIFICATION LENGTH	The verification length shall be used to set the ATA Sector Count (see 3.1.16).
CONTROL	6.4

9.17 WRITE commands overview

9.17.1 WRITE commands OPERATION CODE translation

The SATL shall transfer the logical blocks specified in the SCSI write command (see 3.1.68) from the SCSI application client and shall issue ATA write commands (see 3.1.18) in accordance with the constraints specified in 9.1 to transfer the specified logical blocks through the ATA host in the SATL to the ATA device.

Sequence number: 1
Author: IBM[GPenokie]
Subject: Underline
Date: 2/16/2006 1:29:22 PM
T 9.15 VERIFY (12) command

Status
rlsheffi Cancelled 5/5/2006 3:05:03 PM

Sequence number: 2
Author: QDSS[PSuhler]
Subject: Highlight
Date: 5/5/2006 3:05:37 PM

T Page: 78
9.15
Editorial
First sentence begins "Table 52 describes..."
Numerals 5 and 2 are in different font sizes. Same for table caption.
REASON: Don't know how to fix this.

Status
rlsheffi Rejected 5/5/2006 3:05:19 PM

Sequence number: 3
Author: DELL[KMarks]
Subject: Highlight
Date: 4/9/2006 11:44:43 AM
T Table 52 — VERIFY (12) command CDB fields
Row: VRPROTECT

This field can not be set to Unspecified, because the PROTECT bit in the INQUIRY data is a shall be set to zero. Change the PROTECT bit to Unspecified or change this field to if not 000b, then CHECK CONDITION/IR/IFIC.

REASON: Changed the PROTECT bit in INQUIRY data to "Unspecified (see 3.4.3)" instead - consistent with the rest of the document.

Status
rlsheffi Rejected 4/9/2006 11:44:48 AM

Sequence number: 4
Author: STX[GHoulder]
Subject: Highlight
Date: 6/22/2006 1:31:22 PM
T PDF page 77, table 52, BYTCHK description field
"If the SATA supports a bytchk value..."
Should 'bytchk' be in small-caps ?
RESOLUTION: see 06-216

Status
rlsheffi Completed 7/23/2006 1:24:01 PM

Sequence number: 5
Author: DELL[KMarks]
Subject: Highlight
Date: 6/22/2006 1:31:49 PM
T Table 52 — VERIFY (12) command CDB fields
Row: BYTCHK
change

"If the SATL supports a bytchk value of one and the CDB specifies one in the BYTCHK field, the SATL perform a byte by byte comparison of the data transferred from the SCSI application client to the SATL with data read from the ATA device by the SATL, and shall return the results of that comparison as described in SBC-2."

to

"If the SATL supports a BYTCHK bit set to one and the CDB specifies one in the BYTCHK field, the SATL shall perform a

9.15 VERIFY (12) command

Table 52 describes the translation of fields in the VERIFY (12) CDB.

Table 52 — VERIFY (12) command CDB fields

Field	Description or reference
OPERATION CODE	The SATL shall issue an ATA verify command (see 3.1.17) in accordance with the constraints defined in 9.1.
VRPROTECT	Unspecified (see 3.4.3)
DPO	Unspecified (see 3.4.3)
BYTCHK	If the SATL supports a bytchk value of one and the CDB specifies one in the BYTCHK field, the SATL perform a byte by byte comparison of the data transferred from the SCSI application client to the SATL with data read from the ATA device by the SATL, and shall return the results of that comparison as described in SBC-2.
LOGICAL BLOCK ADDRESS	The logical block address shall be used to set the ATA LBA (see 3.1.11).
GROUP NUMBER	Unspecified (see 3.4.3)
VERIFICATION LENGTH	The verification length shall be used to set the ATA Sector Count (see 9.1).
CONTROL	6.4

9.16 VERIFY (16) command

Table 53 describes the translation of fields in the VERIFY (16) CDB.

Table 10 — VERIFY (16) command CDB fields

Field	Description or reference
OPERATION CODE	The SATL shall issue an ATA verify command (see 3.1.17) in accordance with the constraints defined in 9.1.
VRPROTECT	Unspecified (see 3.4.3)
DPO	Unspecified (see 3.4.3)
BYTCHK	If the SATL supports a bytchk value of one and the CDB specifies one in the BYTCHK field, the SATL perform a byte by byte comparison of the data transferred from the SCSI application client to the SATL with data read from the ATA device by the SATL, and shall return the results of that comparison as described in SBC-2.
LOGICAL BLOCK ADDRESS	The logical block address shall be used to set the ATA LBA (see 3.1.11).
GROUP NUMBER	Unspecified (see 3.4.3)
VERIFICATION LENGTH	The verification length shall be used to set the ATA Sector Count (see 3.1.16).
CONTROL	6.4

9.17 WRITE commands overview

9.17.1 WRITE commands OPERATION CODE translation

The SATL shall transfer the logical blocks specified in the SCSI write command (see 3.1.68) from the SCSI application client and shall issue ATA write commands (see 3.1.18) in accordance with the constraints specified in 9.1 to transfer the specified logical blocks through the ATA host in the SATL to the ATA device.

byte by byte comparison of the data transferred from the application client to the SATL with data read from the ATA device by the SATL and return the results of that comparison as described in SBC-2."

RESOLUTION: see 06-216 - s/b

"If the SATL supports a BYTCHK bit set to one and if the BYTCHK bit is set to one, then the SATL shall perform a byte-by-byte comparison of the data transferred from the application client to the SATL with data read from the ATA device by the SATL, and return completion status reflecting the results of the comparison (see SBC-2)."

Status
risheffi Completed 7/23/2006 1:24:20 PM

Sequence number: 6
Author: IBM[GPenokie]
Subject: Comment on Text
Date: 6/22/2006 1:31:58 PM

Table 52 - bytchk row
This << If the SATL supports a bytchk value of one and >> should be << If the SATL supports a BYTCHK bit set to one and >>

RESOLUTION: see 06-216

Status
risheffi Completed 7/23/2006 1:24:31 PM

Sequence number: 7
Author: ELX[KHirata]
Subject: Note
Date: 6/22/2006 1:52:00 PM

TLocation: Page 58, 9.15 and 9.16, Table 52 and 53, Verification Length description.

Comment:

Shouldn't the language used to describe the setting of the verification length field be similar to the language used for the length fields in the READ and WRITE command descriptions?

RESOLUTION: see 06-216

Status
risheffi Completed 7/23/2006 1:25:11 PM

Sequence number: 8
Author: INTC[RSheffield]
Subject: Highlight
Date: 6/22/2006 1:54:37 PM

Table 52 — VERIFY (12) command CDB fields

Row: VERIFICATION LENGTH
"(see 9.1)." s/b "(see 3.1.16)."

RESOLUTION: see 06-216

Status
risheffi Completed 7/23/2006 1:25:35 PM

Sequence number: 9
Author: IBM[GPenokie]
Subject: Underline
Date: 2/16/2006 1:42:40 PM

T9.16 VERIFY (16) command

Status
risheffi Cancelled 5/5/2006 3:24:36 PM

Sequence number: 10
Author: QDSS[PSuhler]
Subject: Highlight
Date: 5/5/2006 3:25:11 PM

TPage: 78
9.16

Editorial

First sentence begins "Table 53 describes..."

Numerals 5 and 3 are in different font sizes. Same for table caption. This applies to later tables, as well.

REASON: Don't know how to fix this.

Status

Comments from page 78 continued on next page

9.15 VERIFY (12) command

Table 52 describes the translation of fields in the VERIFY (12) CDB.

Table 52 — VERIFY (12) command CDB fields

Field	Description or reference
OPERATION CODE	The SATL shall issue an ATA verify command (see 3.1.17) in accordance with the constraints defined in 9.1.
VRPROTECT	Unspecified (see 3.4.3)
DPO	Unspecified (see 3.4.3)
BYTCHK	If the SATL supports a bytchk value of one and the CDB specifies one in the BYTCHK field, the SATL perform a byte by byte comparison of the data transferred from the SCSI application client to the SATL with data read from the ATA device by the SATL, and shall return the results of that comparison as described in SBC-2.
LOGICAL BLOCK ADDRESS	The logical block address shall be used to set the ATA LBA (see 3.1.11).
GROUP NUMBER	Unspecified (see 3.4.3)
VERIFICATION LENGTH	The verification length shall be used to set the ATA Sector Count (see 9.1).
CONTROL	6.4

9.16 VERIFY (16) command

Table 53 describes the translation of fields in the VERIFY (16) CDB.

Table 53 — VERIFY (16) command CDB fields

Field	Description or reference
OPERATION CODE	The SATL shall issue an ATA verify command (see 3.1.17) in accordance with the constraints defined in 9.1.
VRPROTECT	¹¹ Unspecified (see 3.4.3)
DPO	Unspecified (see 3.4.3)
BYTCHK	¹⁴ If the SATL supports a ¹² bychk value of one and the CDB specifies one in the BYTCHK field, the SATL perform a byte by byte comparison of the data transferred from the SCSI application client to the SATL with data read from the ATA device by the SATL, and shall return the results of that comparison as described in SBC-2.
LOGICAL BLOCK ADDRESS	The logical block address shall be used to set the ATA LBA (see 3.1.11).
GROUP NUMBER	Unspecified (see 3.4.3)
VERIFICATION LENGTH	The verification length shall be used to set the ATA Sector Count (see 3.1.16).
CONTROL	6.4

9.17 WRITE commands overview

9.17.1 WRITE commands OPERATION CODE translation

The SATL shall transfer the logical blocks specified in the SCSI write command (see 3.1.68) from the SCSI application client and shall issue ATA write commands (see 3.1.18) in accordance with the constraints specified in 9.1 to transfer the specified logical blocks through the ATA host in the SATL to the ATA device.

rlsheffi Rejected 5/5/2006 3:24:56 PM

Sequence number: 11
Author: DELL[KMarks]
Subject: Highlight
Date: 4/9/2006 11:45:22 AM

T Table 53 — VERIFY (16) command CDB fields
Row: VRPROTECT

This field can not be set to Unspecified, because the PROTECT bit in the INQUIRY data is a shall be set to zero. Change the PROTECT bit to Unspecified or change this field to if not 000b, then CHECK CONDITION/IR/IFIC.

REASON: Changed the PROTECT bit in INQUIRY data to "Unspecified (see 3.4.3)" instead - consistent with the rest of the document.

Status
rlsheffi Rejected 5/5/2006 3:25:50 PM

Sequence number: 12
Author: STX[GHolder]
Subject: Highlight
Date: 6/22/2006 1:56:20 PM

T PDF page 77, table 53, BYTCHK description field
"If the SATA supports a bytchk value..."
Should 'bytchk' be in small-caps ?PDF page 76, table 51, BYTCHK description field

RESOLUTION: see 06-216

Status
rlsheffi Completed 7/23/2006 1:26:01 PM

Sequence number: 13
Author: DELL[KMarks]
Subject: Highlight
Date: 6/22/2006 1:56:47 PM

T Table 53 — VERIFY (16) command CDB fields
Row: BYTCHK
change

"If the SATL supports a bytchk value of one and the CDB specifies one in the BYTCHK field, the SATL perform a byte by byte comparison of the data transferred from the SCSI application client to the SATL with data read from the ATA device by the SATL, and shall return the results of that comparison as described in SBC-2."

to

"If the SATL supports a BYTCHK bit set to one and the CDB specifies one in the BYTCHK field, the SATL shall perform a byte by byte comparison of the data transferred from the application client to the SATL with data read from the ATA device by the SATL and return the results of that comparison as described in SBC-2."

RESOLUTION: see 06-216 - s/b

"If the SATL supports a BYTCHK bit set to one and if the BYTCHK bit is set to one, then the SATL shall perform a byte-by-byte comparison of the data transferred from the application client to the SATL with data read from the ATA device by the SATL, and return completion status reflecting the results of the comparison (see SBC-2)."

Status
rlsheffi Completed 7/23/2006 1:28:22 PM

Sequence number: 14
Author: IBM[GPenokie]
Subject: Comment on Text
Date: 6/22/2006 1:56:56 PM

T table 53 - bytchk row
This << If the SATL supports a bytchk value of one and >> should be << If the SATL supports a BYTCHK bit set to one and >>

RESOLUTION: see 06-216

Status
rlsheffi Completed 7/23/2006 1:28:36 PM

Comments from page 78 continued on next page

9.15 VERIFY (12) command

Table 52 describes the translation of fields in the VERIFY (12) CDB.

Table 52 — VERIFY (12) command CDB fields

Field	Description or reference
OPERATION CODE	The SATL shall issue an ATA verify command (see 3.1.17) in accordance with the constraints defined in 9.1.
VRPROTECT	Unspecified (see 3.4.3)
DPO	Unspecified (see 3.4.3)
BYTCHK	If the SATL supports a bytchk value of one and the CDB specifies one in the BYTCHK field, the SATL perform a byte by byte comparison of the data transferred from the SCSI application client to the SATL with data read from the ATA device by the SATL, and shall return the results of that comparison as described in SBC-2.
LOGICAL BLOCK ADDRESS	The logical block address shall be used to set the ATA LBA (see 3.1.11).
GROUP NUMBER	Unspecified (see 3.4.3)
VERIFICATION LENGTH	The verification length shall be used to set the ATA Sector Count (see 9.1).
CONTROL	6.4

9.16 VERIFY (16) command

Table 53 describes the translation of fields in the VERIFY (16) CDB.

Table 53 — VERIFY (16) command CDB fields

Field	Description or reference
OPERATION CODE	The SATL shall issue an ATA verify command (see 3.1.17) in accordance with the constraints defined in 9.1.
VRPROTECT	Unspecified (see 3.4.3)
DPO	Unspecified (see 3.4.3)
BYTCHK	If the SATL supports a bytchk value of one and the CDB specifies one in the BYTCHK field, the SATL perform a byte by byte comparison of the data transferred from the SCSI application client to the SATL with data read from the ATA device by the SATL, and shall return the results of that comparison as described in SBC-2.
LOGICAL BLOCK ADDRESS	The logical block address shall be used to set the ATA LBA (see 3.1.11).
GROUP NUMBER	Unspecified (see 3.4.3)
VERIFICATION LENGTH	The verification length shall be used to set the ATA Sector Count (see 3.1.16).
CONTROL	6.4

9.17 WRITE commands overview

9.17.1 WRITE commands OPERATION CODE translation

The SATL shall transfer the logical blocks specified in the SCSI write command (see 3.1.68) from the SCSI application client and shall issue ATA write commands (see 3.1.18) in accordance with the constraints specified in 9.1 to transfer the specified logical blocks through the ATA host in the SATL to the ATA device.

Sequence number: 15
Author: ELX[KHirata]
Subject: Note
Date: 6/22/2006 1:57:18 PM
 Location: Page 58, 9.15 and 9.16, Table 52 and 53, Verification Length description.

Comment:

Shouldn't the language used to describe the setting of the verification length field be similar to the language used for the length fields in the READ and WRITE command descriptions?

RESOLUTION: see 06-216

Status
risheffi Completed 7/23/2006 1:28:46 PM

Sequence number: 16
Author: QDSS[PSuhler]
Subject: Note
Date: 5/5/2006 3:29:00 PM
 Page: Various

Heading: Various
Editorial

Third-level heading numbers have numerals in different sizes. Examples:
9.17.1 and 9.17.2 have the "7" smaller.

REASON: Don't know how to fix this

Status
risheffi Rejected 5/5/2006 3:29:03 PM

Sequence number: 17
Author: DELL[KMarks]
Subject: Highlight
Date: 6/22/2006 2:06:21 PM
 9.17.1 WRITE commands OPERATION CODE translation

change subclause title to
"9.17.1 WRITE commands operation code translation"

or if supposed to be in small caps, fix 9.3.1 title
RESOLUTION: see 06-216

Status
risheffi Completed 7/23/2006 1:29:49 PM

Sequence number: 18
Author: DELL[KMarks]
Subject: Highlight
Date: 6/22/2006 2:16:16 PM

 9.17.1 WRITE commands OPERATION CODE translation

1st paragraph

Change
"The SATL shall transfer the logical blocks specified in the SCSI write command (see 3.1.68) from the SCSI application client and shall issue ATA write commands (see 3.1.18) in accordance with the constraints specified in 9.1 to transfer the specified logical blocks through the ATA host in the SATL to the ATA device."

to
"The SATL shall transfer the logical blocks specified in the SCSI write command (see 3.1.68) from the application client to the ATA device. The SATL shall issue ATA write commands (see 3.1.18) in accordance with the constraints specified in 9.1 to accomplish the SCSI write command (see 3.1.68.)"

RESOLUTION: see 06-216 - s/b

"The SATL shall transfer the logical blocks specified in the SCSI write command (see 3.1.68) from the application client to the ATA device. The SATL shall issue ATA write commands (see 3.1.18) in accordance with the constraints specified in 9.1."

Status
risheffi Completed 7/23/2006 1:30:15 PM

~~1 data blocks specified in the LOGICAL_BLOCK_ADDRESS field shall be transferred to the specified ATA device, and the ATA device may transfer the data to its cache or medium.~~

9.17.2 WRITE commands with FUA

This subclause applies to the translation of SCSI WRITE (10), WRITE (12), and WRITE (16) commands.

2 the FUA bit is zero the SATL shall process this command as described in 9.17.1.

If the FUA bit is one the SATL shall issue an ATA write FUA command sequence (see 3.1.19) to the attached ATA device in accordance with the constraints described in 9.1.

3 9.18 WRITE (6) command

The WRITE (6) command is used to request the ATA device to transfer user data to the ATA device's medium or to the ATA device's cache. Data may be written to the ATA device's medium or to the ATA device's cache.

Table 54 — WRITE (6) command CDB fields

Field	Description or reference
OPERATION CODE	9.17.1
TRANSFER LENGTH	The transfer length shall be used to set the ATA Sector Count (see 3.1.16). ^a
LOGICAL BLOCK ADDRESS	The logical block address shall be used to set the ATA LBA (see 3.1.11).
CONTROL	6.4
^a A transfer length of zero specifies to transfer 256 data blocks from the application client to the attached ATA device (see SBC-2).	

9.19 WRITE (10) command

The WRITE (10) command is used to request the ATA device to transfer user data to the ATA device's medium or to the ATA device's cache. Data may be written to the ATA device's medium or to the ATA device's cache.

Table 55 — WRITE (10) command CDB fields

Field	Description or reference
OPERATION CODE	9.17.1 and 9.17.2
WRPROTECT	Unspecified (see 3.4.3)
DPO	Unspecified (see 3.4.3)
FUA	The SATL may support the FUA bit as defined in SBC-2 (see 9.17.2).
FUA_NV	If the FUA_NV bit is set to one the SATL shall terminate the command with CHECK CONDITION status with the sense key set to ILLEGAL REQUEST and the additional sense code set to INVALID FIELD IN CDB.
LOGICAL BLOCK ADDRESS	The logical block address shall be used to set the ATA LBA (see 3.1.11).
GROUP NUMBER	Unspecified (see 3.4.3)
TRANSFER LENGTH	The transfer length shall be used to set the ATA Sector Count (see 3.1.16). ^a The SATL shall issue as many ATA write commands (see 3.1.18) as needed to satisfy the transfer length specified by the WRITE (10) command.
CONTROL	6.4
^a A transfer length of zero indicates that a data transfer shall not take place.	

Sequence number: 1
Author: DELL[KMarks]
Subject: Cross-Out
Date: 6/22/2006 2:16:32 PM

T 9.17.1 WRITE commands OPERATION CODE translation

2nd Paragraph

change

remove

"Data blocks specified in the LOGICAL BLOCK ADDRESS field shall be transferred to the specified ATA device, and the ATA device may transfer the data to its cache or medium."

Sentence does not add to what is stated above and in the CDB translation fields, additionally whether the data has the possibility to go in cache or directly to medium is dependent on the state of the write cache.

RESOLUTION: see 06-216

Status
risheffi Completed 7/23/2006 1:30:37 PM

Sequence number: 2
Author: DELL[KMarks]
Subject: Highlight
Date: 6/22/2006 2:27:47 PM

T 9.17.2 WRITE commands with FUA

2nd & 3rd paragraphs

change

"If the FUA bit is zero the SATL shall process this command as described in 9.17.1.

If the FUA bit is one the SATL shall issue an ATA write FUA command sequence (see 3.1.19) to the attached ATA device in accordance with the constraints described in 9.1."

to

"If the FUA bit is set to zero in the SCSI write command CDB, the SATL shall process this command as described in 9.17.1.

If the FUA bit is set to one in the SCSI write command CDB, the SATL shall issue an ATA write FUA command sequence (see 3.1.19) to the ATA device in accordance with the constraints described in 9.1."

RESOLUTION: see 06-216 - s/b

If the FUA bit is set to zero in the SCSI write command CDB, then the SATL shall process this command as described in 9.17.1.

If the FUA bit is set to one in the SCSI write command CDB, then the SATL shall issue, in accordance with the constraints described in 9.1:

a) two ATA commands as follows:

- 1) an ATA write command (see 3.1.xx) excluding WRITE DMA FUA EXT, WRITE DMA QUEUED FUA EXT, WRITE MULTIPLE FUA EXT, and WRITE FPDMA QUEUE; and
- 2) an ATA verify command (see 3.1.xx);

b) one of the following ATA commands (see ATA8-ACS):

- A) WRITE DMA FUA EXT;
- B) WRITE DMA QUEUED FUA EXT; or
- C) WRITE MULTIPLE FUA EXT;

or

c) an ATA WRITE FPDMA QUEUED command (see SATA 2.5) with the FUA bit in the Device register set to one.

See 5.3 for a description of multiple command sequence error handling.

Status
risheffi Completed 7/23/2006 1:32:11 PM

Sequence number: 3

~~Data blocks specified in the LOGICAL BLOCK ADDRESS field shall be transferred to the specified ATA device, and the ATA device may transfer the data to its cache or medium.~~

9.17.2 WRITE commands with FUA

This subclause applies to the translation of SCSI WRITE (10), WRITE (12), and WRITE (16) commands.

If the FUA bit is zero the SATL shall process this command as described in 9.17.1.

If the FUA bit is one the SATL shall issue an ATA write FUA command sequence (see 3.1.19) to the attached ATA device in accordance with the constraints described in 9.1.

9.18 WRITE (6) command

The WRITE (6) command is used to request the ATA device to transfer user data to the ATA device's medium or to the ATA device's cache. Data may be written to the ATA device's medium or to the ATA device's cache.

Table 54 — WRITE (6) command CDB fields

Field	Description or reference
OPERATION CODE	9.17.1
TRANSFER LENGTH	The transfer length shall be used to set the ATA Sector Count (see 3.1.16). ^a
LOGICAL BLOCK ADDRESS	The logical block address shall be used to set the ATA LBA (see 3.1.11).
CONTROL	6.4
^a A transfer length of zero specifies to transfer 256 data blocks from the application client to the attached ATA device (see SBC-2).	

9.19 WRITE (10) command

The WRITE (10) command is used to request the ATA device to transfer user data to the ATA device's medium or to the ATA device's cache. Data may be written to the ATA device's medium or to the ATA device's cache.

Table 55 — WRITE (10) command CDB fields

Field	Description or reference
OPERATION CODE	9.17.1 and 9.17.2
WRPROTECT	Unspecified (see 3.4.3)
DPO	Unspecified (see 3.4.3)
FUA	The SATL may support the FUA bit as defined in SBC-2 (see 9.17.2).
FUA_NV	If the FUA_NV bit is set to one the SATL shall terminate the command with CHECK CONDITION status with the sense key set to ILLEGAL REQUEST and the additional sense code set to INVALID FIELD IN CDB.
LOGICAL BLOCK ADDRESS	The logical block address shall be used to set the ATA LBA (see 3.1.11).
GROUP NUMBER	Unspecified (see 3.4.3)
TRANSFER LENGTH	The transfer length shall be used to set the ATA Sector Count (see 3.1.16). ^a The SATL shall issue as many ATA write commands (see 3.1.18) as needed to satisfy the transfer length specified by the WRITE (10) command.
CONTROL	6.4
^a A transfer length of zero indicates that a data transfer shall not take place.	

Author: IBM[GPenokie]
Subject: Underline
Date: 2/16/2006 1:41:46 PM
T 9.18 WRITE (6) command

Status
rlsheffi Cancelled 5/5/2006 3:32:03 PM

Sequence number: 4
Author: DELL[KMarks]
Subject: Highlight
Date: 6/22/2006 2:35:45 PM
T 9.18 WRITE (6) command

1st Paragraph
change

"The WRITE (6) command is used to request the ATA device to transfer user data to the ATA device's medium or to the ATA device's cache. Data may be written to the ATA device's medium or to the ATA device's cache."

to

"The WRITE (6) command is used to request the SATL transfer user data from the application client to the ATA device. Data may be written to the medium or cache of the ATA device.

Table 54 shows the translation for fields specified in the WRITE(6) CDB."

Do we need to add depending on the state of the write cache?

RESOLUTION: see 06-216

Status
rlsheffi Completed 7/23/2006 1:32:52 PM

Sequence number: 5
Author: HPQ[RElliott]
Date: 6/22/2006 2:35:55 PM
9.18

need a reference to table 54

RESOLUTION: see 06-216

Status
rlsheffi Completed 7/23/2006 1:33:00 PM

Sequence number: 6
Author: IBM[GPenokie]
Subject: Highlight
Date: 6/22/2006 2:36:02 PM
T There is no reference to table 54. This needs to be fixed as all tables have to be referenced.

RESOLUTION: see 06-216

Status
rlsheffi Completed 7/23/2006 1:33:06 PM

Sequence number: 7
Author: DELL[KMarks]
Subject: Highlight
Date: 6/22/2006 2:41:09 PM
T Table 54 — WRITE (6) command CDB fields

Footbote a
change

"a A transfer length of zero specifies to transfer 256 data blocks from the application client to the attached ATA device (see SBC-2)."

to

"a A TRANSFER LENGTH field set to 0h specifies a transfer length of 256 logical blocks (see SBC-2)."

RESOLUTION: s/b

Comments from page 79 continued on next page

~~Data blocks specified in the LOGICAL_BLOCK_ADDRESS field shall be transferred to the specified ATA device, and the ATA device may transfer the data to its cache or medium.~~

9.17.2 WRITE commands with FUA

This subclause applies to the translation of SCSI WRITE (10), WRITE (12), and WRITE (16) commands.

If the FUA bit is zero the SATL shall process this command as described in 9.17.1.

If the FUA bit is one the SATL shall issue an ATA write FUA command sequence (see 3.1.19) to the attached ATA device in accordance with the constraints described in 9.1.

9.18 WRITE (6) command

The WRITE (6) command is used to request the ATA device to transfer user data to the ATA device's medium or to the ATA device's cache. Data may be written to the ATA device's medium or to the ATA device's cache.

Table 54 — WRITE (6) command CDB fields

Field	Description or reference
OPERATION CODE	9.17.1
TRANSFER LENGTH	The transfer length shall be used to set the ATA Sector Count (see 3.1.16). ^a
LOGICAL BLOCK ADDRESS	The logical block address shall be used to set the ATA LBA (see 3.1.11).
CONTROL	6.4
⁸ A transfer length of zero ⁹ specifies to transfer 256 data blocks from the application client to the attached ATA device (see SBC-2).	

9.19 WRITE (10) command

¹⁰ The WRITE (10) command is used to request the ATA device to transfer user data to the ATA device's medium or to the ATA device's cache. Data may be written to the ATA device's medium or to the ATA device's cache.

Table 55 — WRITE (10) command CDB fields

Field	Description or reference
OPERATION CODE	9.17.1 and 9.17.2
WRPROTECT	Unspecified (see 3.4.3)
DPO	Unspecified (see 3.4.3)
FUA	The SATL may support the FUA bit as defined in SBC-2 (see 9.17.2).
FUA_NV	If the FUA_NV bit is set to one the SATL shall terminate the command with CHECK CONDITION status with the sense key set to ILLEGAL REQUEST and the additional sense code set to INVALID FIELD IN CDB.
LOGICAL BLOCK ADDRESS	The logical block address shall be used to set the ATA LBA (see 3.1.11).
GROUP NUMBER	Unspecified (see 3.4.3)
TRANSFER LENGTH	The transfer length shall be used to set the ATA Sector Count (see 3.1.16). ^a The SATL shall issue as many ATA write commands (see 3.1.18) as needed to satisfy the transfer length specified by the WRITE (10) command.
CONTROL	6.4
^a A transfer length of zero indicates that a data transfer shall not take place.	

"a A TRANSFER LENGTH field set to zero specifies a transfer of 256 logical blocks (see SBC-2)."

RESOLUTION: see 06-216

Status
rlsheffi Completed 7/23/2006 1:33:26 PM

Sequence number: 8
Author: WDC[CStevens]
Subject: Comment on Text
Date: 6/22/2006 2:41:16 PM

T I am just guessing here, but I think the footnote is talking about a SCSI field definition. Shouldn't the footnote be attached to the field column?

RESOLUTION: see 06-216

Status
rlsheffi Completed 7/23/2006 1:33:49 PM

Sequence number: 9
Author: HPQ[RElliott]
Subject: Highlight
Date: 6/22/2006 2:41:27 PM

T 9.18
table 54

change "specifies to transfer 256 data blocks" to "specifies a transfer of 256 logical blocks"

RESOLUTION: see 06-216

Status
rlsheffi Completed 7/23/2006 1:33:59 PM

Sequence number: 10
Author: DELL[KMarks]
Subject: Highlight
Date: 7/12/2006 8:07:38 PM

T **9.19 WRITE (10) command**
1st Paragraph
change

"The **WRITE (10) command** is used to request the ATA device to transfer user data to the ATA device's medium or to the ATA device's cache. Data may be written to the ATA device's medium or to the ATA device's cache."

to

"The **WRITE (10) command** is used to request the SATL transfer user data from the application client to the ATA device. Data may be written to the medium or cache of the ATA device.

Table 55 shows the translation for fields specified in the **WRITE(10) CDB.**"

Do we need to add depending on the state of the write cache?

Resolution: See 06-216r2. SAT specifies that when **MODE SELECT** clears the **WCE** bit, that the SATL shall issue a **SET FEATURES** to disable write cache, so the write will go to media if **WCE** is zero. (SAT WG 7/11/06)

Status
rlsheffi Completed 7/23/2006 1:34:16 PM

Sequence number: 11
Author: HPQ[RElliott]
Date: 6/22/2006 2:44:01 PM

 9.19

need a reference to table 55

RESOLUTION: see 06-216

Status
rlsheffi Completed 7/23/2006 1:34:26 PM

Sequence number: 12
Author: IBM[GPenokie]

Comments from page 79 continued on next page

~~Data blocks specified in the LOGICAL_BLOCK_ADDRESS field shall be transferred to the specified ATA device, and the ATA device may transfer the data to its cache or medium.~~

9.17.2 WRITE commands with FUA

This subclause applies to the translation of SCSI WRITE (10), WRITE (12), and WRITE (16) commands.

If the FUA bit is zero the SATL shall process this command as described in 9.17.1.

If the FUA bit is one the SATL shall issue an ATA write FUA command sequence (see 3.1.19) to the attached ATA device in accordance with the constraints described in 9.1.

9.18 WRITE (6) command

The WRITE (6) command is used to request the ATA device to transfer user data to the ATA device's medium or to the ATA device's cache. Data may be written to the ATA device's medium or to the ATA device's cache.

Table 54 — WRITE (6) command CDB fields

Field	Description or reference
OPERATION CODE	9.17.1
TRANSFER LENGTH	The transfer length shall be used to set the ATA Sector Count (see 3.1.16). ^a
LOGICAL BLOCK ADDRESS	The logical block address shall be used to set the ATA LBA (see 3.1.11).
CONTROL	6.4
^a A transfer length of zero specifies to transfer 256 data blocks from the application client to the attached ATA device (see SBC-2).	

9.19 WRITE (10) command

The WRITE (10) command is used to request the ATA device to transfer user data to the ATA device's medium or to the ATA device's cache. Data may be written to the ATA device's medium or to the ATA device's cache.

Table 55 — WRITE (10) command CDB fields

Field	Description or reference
OPERATION CODE	9.17.1 and 9.17.2
WRPROTECT	13 specified (see 3.4.3)
DPO	Unspecified (see 3.4.3)
FUA	The SATL 14 may support the FUA bit as defined in SBC-2 (see 9.17.2).
FUA_NV	16 The FUA_NV bit is set to one the SATL shall terminate 15 command with CHECK CONDITION status with the sense key set to ILLEGAL REQUEST and the additional sense code set to INVALID FIELD IN CDB.
LOGICAL BLOCK ADDRESS	The logical block address shall be used to set the ATA LBA (see 3.1.11).
GROUP NUMBER	Unspecified (see 3.4.3)
TRANSFER LENGTH	The transfer length shall be used to set the ATA Sector Count (see 3.1.16). ^a The SATL shall issue as many ATA write commands (see 3.1.18) as needed to satisfy the transfer length specified by the WRITE (10) command.
CONTROL	6.4
^a A transfer length of zero indicates that a data transfer shall not take place.	

Subject: Highlight
Date: 6/22/2006 2:44:07 PM

T There is no reference to table 55. This needs to be fixed as all tables have to be referenced.

RESOLUTION: see 06-216

Status
rlsheffi Completed 7/23/2006 1:34:31 PM

Sequence number: 13
Author: DELL[KMarks]
Subject: Highlight
Date: 4/9/2006 11:46:13 AM

T Table 55 — WRITE (10) command CDB fields
Row: WRPROTECT

This field can not be set to Unspecified, because the PROTECT bit in the INQUIRY data is a shall be set to zero. Change the PROTECT bit to Unspecified or change this field to if not 000b, then CHECK CONDITION/IR/IFIC.

REASON: Changed the PROTECT bit in INQUIRY data to "Unspecified (see 3.4.3)" instead - consistent with the rest of the document.

Status
rlsheffi Rejected 4/9/2006 11:46:07 AM

Sequence number: 14
Author: STX[GHolder]
Subject: Highlight
Date: 6/22/2006 2:57:44 PM

T PDF page 79, table 55, FUA description field
"The SATL may support..." should be changed to
"The SATL shall support..." because section 9.17.2
contains 'shall' language.

RESOLUTION: see 06-216 s/b

"If the SATL supports an FUA bit set to one (see 8.5.4), then the SATL shall implement the FUA bit as defined in SBC-2 (see 9.17.2)."

Status
rlsheffi Completed 7/23/2006 1:34:49 PM

Sequence number: 15
Author: DELL[KMarks]
Subject: Highlight
Date: 6/22/2006 2:59:49 PM

T Table 55 — WRITE (10) command CDB fields
Row: FUA_NV

change

"...the command with..."

to

"...the WRITE (10) command with..."

RESOLUTION: see 06-216

Status
rlsheffi Completed 7/23/2006 1:35:08 PM

Sequence number: 16
Author: INTC[RSheffield]
Subject: Highlight
Date: 6/22/2006 2:59:16 PM

T 9.19 WRITE (10) command
Table 55 - FUA_NV bit

"If the FUA_NV bit is set to one the SATL shall terminate the command with CHECK CONDITION status with the sense key set to ILLEGAL REQUEST and the additional sense code set to INVALID FIELD IN CDB."

RESOLUTION: see 06-216 s/b

"The SATL may ignore the FUA_NV bit, or the SATL may implement the FUA_NV bit as defined in SBC-2."

Comments from page 79 continued on next page

~~Data blocks specified in the LOGICAL_BLOCK_ADDRESS field shall be transferred to the specified ATA device, and the ATA device may transfer the data to its cache or medium.~~

9.17.2 WRITE commands with FUA

This subclause applies to the translation of SCSI WRITE (10), WRITE (12), and WRITE (16) commands.

If the FUA bit is zero the SATL shall process this command as described in 9.17.1.

If the FUA bit is one the SATL shall issue an ATA write FUA command sequence (see 3.1.19) to the attached ATA device in accordance with the constraints described in 9.1.

9.18 WRITE (6) command

The WRITE (6) command is used to request the ATA device to transfer user data to the ATA device's medium or to the ATA device's cache. Data may be written to the ATA device's medium or to the ATA device's cache.

Table 54 — WRITE (6) command CDB fields

Field	Description or reference
OPERATION CODE	9.17.1
TRANSFER LENGTH	The transfer length shall be used to set the ATA Sector Count (see 3.1.16). ^a
LOGICAL BLOCK ADDRESS	The logical block address shall be used to set the ATA LBA (see 3.1.11).
CONTROL	6.4
^a A transfer length of zero specifies to transfer 256 data blocks from the application client to the attached ATA device (see SBC-2).	

9.19 WRITE (10) command

The WRITE (10) command is used to request the ATA device to transfer user data to the ATA device's medium or to the ATA device's cache. Data may be written to the ATA device's medium or to the ATA device's cache.

Table 55 — WRITE (10) command CDB fields

Field	Description or reference
OPERATION CODE	9.17.1 and 9.17.2
WRPROTECT	Unspecified (see 3.4.3)
DPO	Unspecified (see 3.4.3)
FUA	The SATL may support the FUA bit as defined in SBC-2 (see 9.17.2).
FUA_NV	If the FUA_NV bit is set to one the SATL shall terminate the command with CHECK CONDITION status with the sense key set to ILLEGAL REQUEST and the additional sense code set to INVALID FIELD IN CDB.
LOGICAL BLOCK ADDRESS	The logical block address shall be used to set the ATA LBA (see 3.1.11).
GROUP NUMBER	Unspecified (see 3.4.3)
TRANSFER LENGTH	The transfer length shall be used to set the ATA Sector Count (see 3.1.16). ^a The SATL shall issue as many ATA write commands (see 3.1.18) as needed to satisfy the transfer length specified by the WRITE (10) command.
CONTROL	6.4
^a transfer length of zero indicates that a data transfer shall not take place.	

Note: SBC-2 says that if the nv_sup bit is set to zero in the Extended INQUIRY Data VPD page (i.e., the logical unit doesn't support NV cache), the device server responds as it would considering only the FUA bit (i.e., ignoring the FUA_nv bit), so it is in direct conflict with SBC-2 to return CHECK CONDITION status.

Status
rlsheffi Completed 7/23/2006 1:35:24 PM

Sequence number: 17
Author: DELL[KMarks]
Subject: Highlight
Date: 6/24/2006 2:32:41 PM

T Table 55 — WRITE (10) command CDB fields
footnote a
change

"a A transfer length of zero indicates that a data transfer shall not take place."
to

"a A TRANSFER LENGTH set to 0h specifies that a data transfer shall not take place."

RESOLUTION: see 06-216 s/b

"a A TRANSFER LENGTH field set to zero specifies that a data transfer shall not take place."

Status
rlsheffi Completed 7/23/2006 1:35:38 PM

Sequence number: 18
Author: HPQ[RElliott]
Subject: Highlight
Date: 6/22/2006 3:00:24 PM

T 9.19
table 55

indicates s/b specifies

RESOLUTION: see 06-216

Status
rlsheffi Completed 7/23/2006 1:35:51 PM

Sequence number: 19
Author: WDC[CStevens]
Subject: Comment on Text
Date: 6/22/2006 3:01:27 PM

T ATA devices use a transfer length of 0 to be a maximum transfer. If this statement is a note relative to SBC-2, then the footnote should be in the field column.

RESOLUTION: see 06-216

Status
rlsheffi Completed 7/23/2006 1:36:03 PM

9.20 WRITE (12) command

The WRITE (12) command is used to request the ATA device to transfer user data to the ATA device's medium or to the ATA device's cache. Data may be written to the ATA device's medium or to the ATA device's cache.

Table 56 — WRITE (12) command CDB fields

Field	Description or reference
OPERATION CODE	9.17.1 and 9.17.2
WRPROTECT	Unspecified (see 3.4.3)
DPO	Unspecified (see 3.4.3)
FUA	The SATL may support the FUA bit as defined in SBC-2 (see 9.17.2).
FUA_NV	If the FUA_NV bit is set to one the SATL shall terminate the command with CHECK CONDITION status with the sense key set to ILLEGAL REQUEST and the additional sense code set to INVALID FIELD IN CDB.
LOGICAL BLOCK ADDRESS	The logical block address shall be used to set the ATA LBA (see 3.1.11).
GROUP NUMBER	Unspecified (see 3.4.3)
TRANSFER LENGTH	The transfer length shall be used to set the ATA Sector Count (see 3.1.16). ^a SATL shall issue as many ATA write commands (see 3.1.18) as needed to satisfy the transfer length specified by the WRITE (12) command.
CONTROL	6.4
^a A transfer length of zero indicates that a data transfer shall not take place.	

Sequence number: 1
Author: IBM[GPenokie]
Subject: Underline
Date: 2/16/2006 1:40:48 PM
T 9.20 WRITE (12) command

Status
risheffi Cancelled 5/5/2006 4:03:58 PM

Sequence number: 2
Author: DELL[KMarks]
Subject: Highlight
Date: 7/23/2006 1:42:50 PM
T 9.20 WRITE (12) command
1st Paragraph
change

"The WRITE (12) command is used to request the ATA device to transfer user data to the ATA device's medium or to the ATA device's cache. Data may be written to the ATA device's medium or to the ATA device's cache."

to

"The WRITE (12) command is used to request the SATL transfer user data from the application client to the ATA device. Data may be written to the medium or cache of the ATA device.

Table 56 shows the translation for fields specified in the WRITE(12) CDB."

Do we need to add depending on the state of the write cache?

RESOLUTION: see 06-216 (no contingency on write cache setting, the Caching mode page translation takes care of that).

Status
risheffi Completed 7/23/2006 1:43:04 PM

Sequence number: 3
Author: HPQ[RElliott]
Date: 6/22/2006 3:04:00 PM
 9.20

need a reference to table 56

RESOLUTION: see 06-216

Status
risheffi Completed 7/23/2006 1:43:13 PM

Sequence number: 4
Author: IBM[GPenokie]
Subject: Highlight
Date: 6/22/2006 3:04:08 PM
T There is no reference to table 56. This needs to be fixed as all tables have to be referenced.

RESOLUTION: see 06-216

Status
risheffi Completed 7/23/2006 1:43:18 PM

Sequence number: 5
Author: DELL[KMarks]
Subject: Highlight
Date: 4/9/2006 11:46:32 AM
T Table 56 — WRITE (12) command CDB fields
Row: WRPROTECT

This field can not be set to Unspecified, because the PROTECT bit in the INQUIRY data is a shall be set to zero. Change the PROTECT bit to Unspecified or change this field to if not 000b, then CHECK CONDITION/IR/IFIC.

9.20 WRITE (12) command

The WRITE (12) command is used to request the ATA device to transfer user data to the ATA device's medium or to the ATA device's cache. Data may be written to the ATA device's medium or to the ATA device's cache.

Table 56 — WRITE (12) command CDB fields

Field	Description or reference
OPERATION CODE	9.17.1 and 9.17.2
WRPROTECT	Unspecified (see 3.4.3)
DPO	Unspecified (see 3.4.3)
FUA	The SATL ⁶ ay support the FUA bit as defined in SBC-2 (see 9.17.2).
FUA_NV	⁸ the FUA_NV bit is set to one the SATL shall terminate ⁷ the command with CHECK CONDITION status with the sense key set to ILLEGAL REQUEST and the additional sense code set to INVALID FIELD IN CDB.
LOGICAL BLOCK ADDRESS	The logical block address shall be used to set the ATA LBA (see 3.1.11).
GROUP NUMBER	Unspecified (see 3.4.3)
TRANSFER LENGTH	The transfer length shall be used to set the ATA Sector Count (see 3.1.16). ^a ⁹ SATL shall issue as many ATA write commands (see 3.1.18) as needed to satisfy the transfer length specified by the WRITE (12) command.
CONTROL	6.4
¹⁰	A transfer length of zero indicates that a data transfer shall not take place.

REASON: Changed the PROTECT bit in INQUIRY data to "Unspecified (see 3.4.3)" instead - consistent with the rest of the document.

Status
rlsheffi Rejected 4/9/2006 11:46:39 AM

Sequence number: 6
Author: STX[GHolder]
Subject: Highlight
Date: 6/22/2006 3:04:47 PM

T PDF page 80, table 56, FUA description field
"The SATL may support..." should be changed to
"The SATL shall support..." because section 9.17.2
contains 'shall' language.

RESOLUTION: see 06-216 s/b
"If the SATL supports an FUA bit set to one (see 8.5.4), then the SATL shall implement the FUA bit as defined in SBC-2 (see 9.17.2)."

Status
rlsheffi Completed 7/23/2006 1:43:27 PM

Sequence number: 7
Author: DELL[KMarks]
Subject: Highlight
Date: 6/22/2006 3:04:59 PM

T **Table 56 — WRITE (12) command CDB fields**
Row: FUA_NV
change
"...the command with..."
to
"...the WRITE (10) command with..."

RESOLUTION: see 06-216

Status
rlsheffi Completed 7/23/2006 1:43:35 PM

Sequence number: 8
Author: INTC[RSheffield]
Subject: Highlight
Date: 6/22/2006 3:05:20 PM

T **9.20 WRITE (12) command**
Table 56 FUA_NV bit
"If the FUA_NV bit is set to one the SATL shall terminate the command with
CHECK CONDITION status with the sense key set to **ILLEGAL REQUEST** and
the additional sense code set to **INVALID FIELD IN CDB.**"
s/b

"The SATL may ignore the FUA_NV bit, or the SATL may implement the FUA_NV bit as defined in SBC-2."

RESOLUTION: see 06-216 s/b
"The SATL may ignore the FUA_NV bit, or the SATL may implement the FUA_NV bit as defined in SBC-2."

Status
rlsheffi Completed 7/23/2006 1:43:43 PM

Sequence number: 9
Author: WDC[CStevens]
Subject: Note
Date: 7/23/2006 1:44:19 PM

 This should be attached to TRANSFER LENGTH.
RESOLUTION: see 06-216 - move table footnote reference to the left column. Done in SAT-r08c.

Status
rlsheffi Completed 7/23/2006 1:44:22 PM

Sequence number: 10
Author: DELL[KMarks]
Subject: Highlight
Date: 6/22/2006 3:06:38 PM

Comments from page 80 continued on next page

9.20 WRITE (12) command

The WRITE (12) command is used to request the ATA device to transfer user data to the ATA device's medium or to the ATA device's cache. Data may be written to the ATA device's medium or to the ATA device's cache.

Table 56 — WRITE (12) command CDB fields

Field	Description or reference
OPERATION CODE	9.17.1 and 9.17.2
WRPROTECT	Unspecified (see 3.4.3)
DPO	Unspecified (see 3.4.3)
FUA	The SATL may support the FUA bit as defined in SBC-2 (see 9.17.2).
FUA_NV	If the FUA_NV bit is set to one the SATL shall terminate the command with CHECK CONDITION status with the sense key set to ILLEGAL REQUEST and the additional sense code set to INVALID FIELD IN CDB.
LOGICAL BLOCK ADDRESS	The logical block address shall be used to set the ATA LBA (see 3.1.11).
GROUP NUMBER	Unspecified (see 3.4.3)
TRANSFER LENGTH	The transfer length shall be used to set the ATA Sector Count (see 3.1.16). ^a SATL shall issue as many ATA write commands (see 3.1.18) as needed to satisfy the transfer length specified by the WRITE (12) command.
CONTROL	6.4
^a A transfer length of zero indicates that a data transfer shall not take place.	

T Table 56 — WRITE (12) command CDB fields
footnote a
change

"a A transfer length of zero indicates that a data transfer shall not take place."
to

"a A TRANSFER LENGTH set to 0h specifies that a data transfer shall not take place."

RESOLUTION: s/b

"a A TRANSFER LENGTH field set to zero specifies that a data transfer shall not take place."

RESOLUTION: see 06-216

Status
rlsheffi Completed 7/23/2006 1:44:43 PM

Sequence number: 11
Author: HPQ[RElliott]
Subject: Highlight
Date: 6/22/2006 3:06:45 PM

T 9.20
table 56

indicates s/b specifies

RESOLUTION: see 06-216

Status
rlsheffi Completed 7/23/2006 1:44:49 PM

9.21 WRITE (16) command

The WRITE (16) command is used to request the ATA device to transfer user data to the ATA device's medium or to the ATA device's cache. Data may be written to the ATA device's medium or to the ATA device's cache.

Table 57 — WRITE (16) command CDB fields

Field	Description or reference
OPERATION CODE	9.17.1 and 9.17.2
WRPROTECT	Unspecified (see 3.4.3)
DPO	Unspecified (see 3.4.3)
FUA	The SATL may support the FUA bit as defined in SBC-2 (see 9.17.2).
FUA_NV	If the FUA_NV bit is set to one the SATL shall terminate the command with CHECK CONDITION status with the sense key set to ILLEGAL REQUEST and the additional sense code set to INVALID FIELD IN CDB.
LOGICAL BLOCK ADDRESS	The logical block address shall be used to set the ATA LBA (see 3.1.11).
GROUP NUMBER	Unspecified (see 3.4.3)
TRANSFER LENGTH	The transfer length shall be used to set the ATA Sector Count (see 3.1.16). ^a SATL shall issue as many ATA write commands (see 3.1.18) as needed to satisfy the transfer length specified by the WRITE (16) command.
CONTROL	6.4
^a A transfer length of zero indicates that a data transfer shall not take place.	

9.22 WRITE AND VERIFY commands overview

This subclause applies to the translation of ~~SCSI~~ WRITE AND VERIFY (10), WRITE AND VERIFY (12), and WRITE AND VERIFY (16) commands.

The SATL shall issue:

- 1) an ATA write command (see 3.1.18) in accordance with the constraints defined in 9.1; and
- 2) an ATA verify command (see 3.1.17).

Sequence number: 1
Author: IBM[GPenokie]
Subject: Underline
Date: 2/16/2006 1:28:14 PM
T 9.21 WRITE (16) command

Status
risheffi Cancelled 5/5/2006 4:15:06 PM

Sequence number: 2
Author: DELL[KMarks]
Subject: Highlight
Date: 6/22/2006 3:08:09 PM
T 9.19 WRITE (16) command
1st Paragraph
change

"The WRITE (16) command is used to request the ATA device to transfer user data to the ATA device's medium or to the ATA device's cache. Data may be written to the ATA device's medium or to the ATA device's cache."

to

"The WRITE (16) command is used to request the SATL transfer user data from the application client to the ATA device. Data may be written to the medium or cache of the ATA device.

Table 57 shows the translation for fields specified in the WRITE(16) CDB."

Do we need to add depending on the state of the write cache?

RESOLUTION: see 06-216

Status
risheffi Completed 7/23/2006 1:45:07 PM

Sequence number: 3
Author: HPQ[RElliott]
Date: 6/22/2006 3:08:17 PM
 9.21

need a reference to table 57

RESOLUTION: see 06-216

Status
risheffi Completed 7/23/2006 1:45:16 PM

Sequence number: 4
Author: IBM[GPenokie]
Subject: Highlight
Date: 6/22/2006 3:08:23 PM
T There is no reference to table 57. This needs to be fixed as all tables have to be referenced.

RESOLUTION: see 06-216

Status
risheffi Completed 7/23/2006 1:45:20 PM

Sequence number: 5
Author: DELL[KMarks]
Subject: Highlight
Date: 4/9/2006 11:47:03 AM
T Table 57 — WRITE (16) command CDB fields
Row: WRPROTECT

This field can not be set to Unspecified, because the PROTECT bit in the INQUIRY data is a shall be set to zero. Change the PROTECT bit to Unspecified or change this field to if not 000b, then CHECK CONDITION/IR/IFIC.

9.21 WRITE (16) command

The WRITE (16) command is used to request the ATA device to transfer user data to the ATA device's medium or to the ATA device's cache. Data may be written to the ATA device's medium or to the ATA device's cache.

Table 57 — WRITE (16) command CDB fields

Field	Description or reference
OPERATION CODE	9.17.1 and 9.17.2
WRPROTECT	Unspecified (see 3.4.3)
DPO	Unspecified (see 3.4.3)
FUA	The SATL ⁶ ay support the FUA bit as defined in SBC-2 (see 9.17.2).
FUA_NV	⁸ the FUA_NV bit is set to one the SATL shall terminate ⁷ the command with CHECK CONDITION status with the sense key set to ILLEGAL REQUEST and the additional sense code set to INVALID FIELD IN CDB.
LOGICAL BLOCK ADDRESS	The logical block address shall be used to set the ATA LBA (see 3.1.11).
GROUP NUMBER	Unspecified (see 3.4.3)
TRANSFER LENGTH	The transfer length shall be used to set the ATA Sector Count (see 3.1.16). ^a SATL shall issue as many ATA write commands (see 3.1.18) as needed to satisfy the transfer length specified by the WRITE (16) command. ⁹
CONTROL	6.4
¹⁰	A transfer length of zero indicates that a data transfer shall not take place.

9.22 WRITE AND VERIFY commands overview

This subclause applies to the translation of ~~SCSI~~ WRITE AND VERIFY (10), WRITE AND VERIFY (12), and WRITE AND VERIFY (16) commands.

The SATL shall issue:

- 1) an ATA write command (see 3.1.18) in accordance with the constraints defined in 9.1; and
- 2) an ATA verify command (see 3.1.17).

REASON: Changed the PROTECT bit in INQUIRY data to "Unspecified (see 3.4.3)" instead - consistent with the rest of the document.

Status
rlsheffi Rejected 4/9/2006 11:47:08 AM

Sequence number: 6
Author: STX[GHolder]
Subject: Highlight
Date: 6/22/2006 3:08:41 PM

T PDF page 81, table 57, FUA description field
"The SATL may support..." should be changed to
"The SATL shall support..." because section 9.17.2
contains 'shall' language.

RESOLUTION: s/b

"If the SATL supports an FUA bit set to one (see 8.5.4), then the SATL shall implement the FUA bit as defined in SBC-2 (see 9.17.2)."

RESOLUTION: see 06-216

Status
rlsheffi Completed 7/23/2006 1:45:27 PM

Sequence number: 7
Author: DELL[KMarks]
Subject: Highlight
Date: 6/22/2006 3:08:52 PM

T **Table 57 — WRITE (16) command CDB fields**
Row: FUA_NV
change
"...the command with..."
to
"...the WRITE (10) command with..."

RESOLUTION: see 06-216

Status
rlsheffi Completed 7/23/2006 1:45:38 PM

Sequence number: 8
Author: INTC[RSheffield]
Subject: Highlight
Date: 6/22/2006 3:09:02 PM

T **9.21 WRITE (16) command**
Table 57 - FUA_NV bit

"If the FUA_NV bit is set to one the SATL shall terminate the command with
CHECK CONDITION status with the sense key set to **ILLEGAL REQUEST** and
the additional sense code set to **INVALID FIELD IN CDB.**"

s/b

"The SATL may ignore the FUA_NV bit, or the SATL may implement the FUA_NV bit as defined in SBC-2."

RESOLUTION: see 06-216

Status
rlsheffi Completed 7/23/2006 1:45:54 PM

Sequence number: 9
Author: WDC[CStevens]
Subject: Note
Date: 7/23/2006 1:46:28 PM

 Should this be attached to TRANSFER LENGTH?
RESOLUTION: see 06-216 - move table footnote reference to left column (fixed in SAT-r08c)

Status
rlsheffi Completed 7/23/2006 1:46:40 PM

Sequence number: 10
Author: DELL[KMarks]
Subject: Highlight

Comments from page 81 continued on next page

9.21 WRITE (16) command

The WRITE (16) command is used to request the ATA device to transfer user data to the ATA device's medium or to the ATA device's cache. Data may be written to the ATA device's medium or to the ATA device's cache.

Table 57 — WRITE (16) command CDB fields

Field	Description or reference
OPERATION CODE	9.17.1 and 9.17.2
WRPROTECT	Unspecified (see 3.4.3)
DPO	Unspecified (see 3.4.3)
FUA	The SATL may support the FUA bit as defined in SBC-2 (see 9.17.2).
FUA_NV	If the FUA_NV bit is set to one the SATL shall terminate the command with CHECK CONDITION status with the sense key set to ILLEGAL REQUEST and the additional sense code set to INVALID FIELD IN CDB.
LOGICAL BLOCK ADDRESS	The logical block address shall be used to set the ATA LBA (see 3.1.11).
GROUP NUMBER	Unspecified (see 3.4.3)
TRANSFER LENGTH	The transfer length shall be used to set the ATA Sector Count (see 3.1.16). ^a SATL shall issue as many ATA write commands (see 3.1.18) as needed to satisfy the transfer length specified by the WRITE (16) command.
CONTROL	6.4
^a A transfer length of zero ¹¹ indicates that a data transfer shall not take place.	

9.22 WRITE AND VERIFY commands overview

This subclause applies to the translation of ¹²SI WRITE AND VERIFY (10), WRITE AND VERIFY (12), and WRITE AND VERIFY (16) commands.

The SATL shall issue:

- 1) an ATA write command (see 3.1.18) in accordance with the constraints defined in 9.1; and
- 2) an ATA verify command (see 3.1.17).

Date: 6/22/2006 3:09:43 PM

T Table 57 — WRITE (16) command CDB fields
footnote a
change

"a A transfer length of zero indicates that a data transfer shall not take place."
to

"a A TRANSFER LENGTH set to 0h specifies that a data transfer shall not take place."

RESOLUTION: s/b

"a A TRANSFER LENGTH field set to zero specifies that a data transfer shall not take place."

RESOLUTION: see 06-216

Status

risheffi Completed 7/23/2006 1:46:51 PM

Sequence number: 11

Author: HPQ[RElliott]

Subject: Highlight

Date: 6/22/2006 3:09:49 PM

T 9.21

table 57

indicates s/b specifies

RESOLUTION: see 06-216

Status

risheffi Completed 7/23/2006 1:46:57 PM

Sequence number: 12

Author: DELL[KMarks]

Subject: Cross-Out

Date: 6/22/2006 3:10:13 PM

T SCSI

RESOLUTION: see 06-216

Status

risheffi Completed 7/23/2006 1:47:36 PM

9.23 WRITE AND VERIFY (10) command

The WRITE AND VERIFY (10) command is used to transfer application data to the ATA device's medium and then to verify that data was written correctly.

Table 58 — WRITE AND VERIFY (10) command CDB fields

Field	Description or reference
OPERATION CODE	9.22
WRPROTECT	Unspecified (see 3.4.3)
DPO	Unspecified (see 3.4.3)
BYTCHK	If the application client specifies a value other than zero in this field, the SATL shall terminate the command with CHECK CONDITION status with the sense key set to ILLEGAL REQUEST and the additional sense code set to INVALID FIELD IN CDB.
LOGICAL BLOCK ADDRESS	The logical block address shall be used to set the ATA LBA (see 3.1.11).
GROUP NUMBER	Unspecified (see 3.4.3)
TRANSFER LENGTH	The transfer length shall be used to set the ATA Sector Count (see 3.1.16). ^a The SATL shall issue as many ATA write commands (see 3.1.18) as needed to satisfy the transfer length specified by the WRITE AND VERIFY (10) command.
CONTROL	6.4
^a A transfer length of zero indicates that a data transfer shall not take place.	

9.24 WRITE AND VERIFY (12) command

The WRITE AND VERIFY (12) command is used to transfer application data to the ATA device's medium and then to verify that data was written correctly.

Table 59 — WRITE AND VERIFY (12) command CDB fields

Field	Description or reference
OPERATION CODE	9.22
WRPROTECT	Unspecified (see 3.4.3)
DPO	Unspecified (see 3.4.3)
BYTCHK	If the application client specifies a value other than zero in this field, the SATL shall terminate the command with CHECK CONDITION status with the sense key set to ILLEGAL REQUEST and the additional sense code set to INVALID FIELD IN CDB.
LOGICAL BLOCK ADDRESS	The logical block address shall be used to set the ATA LBA (see 3.1.11).
GROUP NUMBER	Unspecified (see 3.4.3)
TRANSFER LENGTH	The transfer length shall be used to set the ATA Sector Count (see 3.1.16). ^a The SATL shall issue as many ATA write commands (see 3.1.18) as needed to satisfy the transfer length specified by the WRITE AND VERIFY (12) command.
CONTROL	6.4
^a A transfer length of zero indicates that a data transfer shall not take place.	

Sequence number: 1
Author: IBM[GPenokie]
Subject: Underline
Date: 2/16/2006 1:29:13 PM
T9.23 WRITE AND VERIFY (10) command

Status
r/sheffi Cancelled 5/6/2006 8:12:22 AM

Sequence number: 2
Author: DELL[KMarks]
Subject: Highlight
Date: 6/22/2006 3:33:29 PM
T9.23 WRITE AND VERIFY (10) command

1st Paragraph
change

"The WRITE AND VERIFY (10) command is used to transfer application data to the ATA device's medium and then to verify that data was written correctly."

to

"The WRITE AND VERIFY (10) command is used to transfer user data from the application client to the medium of the ATA device and then to verify that data was written correctly."

Table 58 shows the translation for fields specified in the WRITE AND VERIFY (10) CDB"

RESOLUTION: see 06-216

Status
r/sheffi Completed 7/23/2006 1:48:21 PM

Sequence number: 3
Author: MXO[MEvans]
Subject: Highlight
Date: 6/22/2006 3:33:21 PM
T9.23 WRITE AND VERIFY (10) command first paragraph: change to, "The WRITE AND VERIFY (10) command requests that the SATL transfer the specified logical block(s) to the ATA device, and then verify that the data was written correctly to the ATA device's medium."

RESOLUTION: s/b

"The WRITE AND VERIFY (10) command requests that the SATL transfer the specified logical block(s) from the application client to the ATA device, and then verify that the data was written correctly to the medium of the ATA device .

Table 58 shows the translation for fields specified in the WRITE AND VERIFY (10) CDB."

RESOLUTION: see 06-216

Status
r/sheffi Completed 7/23/2006 1:48:30 PM

Sequence number: 4
Author: LSI[JLohmeyer]
Subject: Highlight
Date: 6/22/2006 3:34:08 PM
T9.23 WRITE AND VERIFY (10) command

Change "that data" to "that the data".

RESOLUTION: see 06-216

Status
r/sheffi Completed 7/23/2006 1:48:42 PM

Sequence number: 5
Author: HPQ[RElliott]
Date: 6/22/2006 3:34:18 PM

9.23 WRITE AND VERIFY (10) command

The WRITE AND VERIFY (10) command is used to transfer application data to the ATA device's medium and then to verify that data was written correctly.

Table 58 — WRITE AND VERIFY (10) command CDB fields

Field	Description or reference
OPERATION CODE	9.22
WRPROTECT	Unspecified (see 3.4.3)
DPO	Unspecified (see 3.4.3)
10 TCHK	If the application client specifies a value other than zero in this field, the SATL shall terminate the command with CHECK CONDITION status with the sense key set to ILLEGAL REQUEST and the additional sense code set to INVALID FIELD IN CDB.
LOGICAL BLOCK ADDRESS	The logical block address shall be used to set the ATA LBA (see 3.1.11).
GROUP NUMBER	Unspecified (see 3.4.3)
TRANSFER LENGTH	The transfer length shall be used to set the ATA Sector Count (see 3.1.16). ^a The SATL shall issue as many ATA write commands (see 3.1.18) as needed to satisfy the transfer length specified by the WRITE AND VERIFY (10) command.
CONTROL	6.4
^a A transfer length of zero indicates that a data transfer shall not take place.	

9.24 WRITE AND VERIFY (12) command

The WRITE AND VERIFY (12) command is used to transfer application data to the ATA device's medium and then to verify that data was written correctly.

Table 59 — WRITE AND VERIFY (12) command CDB fields

Field	Description or reference
OPERATION CODE	9.22
WRPROTECT	Unspecified (see 3.4.3)
DPO	Unspecified (see 3.4.3)
BYTCHK	If the application client specifies a value other than zero in this field, the SATL shall terminate the command with CHECK CONDITION status with the sense key set to ILLEGAL REQUEST and the additional sense code set to INVALID FIELD IN CDB.
LOGICAL BLOCK ADDRESS	The logical block address shall be used to set the ATA LBA (see 3.1.11).
GROUP NUMBER	Unspecified (see 3.4.3)
TRANSFER LENGTH	The transfer length shall be used to set the ATA Sector Count (see 3.1.16). ^a The SATL shall issue as many ATA write commands (see 3.1.18) as needed to satisfy the transfer length specified by the WRITE AND VERIFY (12) command.
CONTROL	6.4
^a A transfer length of zero indicates that a data transfer shall not take place.	

 9.23

need a reference to table 58

RESOLUTION: see 06-216

Status
rlsheffi Completed 7/23/2006 1:48:49 PM

Sequence number: 6
Author: IBM[GPenokie]
Subject: Highlight
Date: 6/22/2006 3:34:25 PM

 There is no reference to table 58. This needs to be fixed as all tables have to be referenced.

RESOLUTION: see 06-216

Status
rlsheffi Completed 7/23/2006 1:48:55 PM

Sequence number: 7
Author: DELL[KMarks]
Subject: Highlight
Date: 4/9/2006 11:47:27 AM

 **Table 58 — WRITE AND VERIFY (10) command CDB fields**
Row: WRPROTECT

This field can not be set to Unspecified, because the PROTECT bit in the INQUIRY data is a shall be set to zero. Change the PROTECT bit to Unspecified or change this field to if not 000b, then CHECK CONDITION/IR/IFIC.

REASON: Changed the PROTECT bit in INQUIRY data to "Unspecified (see 3.4.3)" instead - consistent with the rest of the document.

Status
rlsheffi Rejected 4/9/2006 11:47:31 AM

Sequence number: 8
Author: SIERLGC[BMartin]
Subject: Note
Date: 6/22/2006 3:44:58 PM

 Page 62, Table 58
Why are we choosing not to do bytchk here?

RESOLUTION: see 06-216

Status
rlsheffi Completed 7/23/2006 1:49:26 PM

Sequence number: 9
Author: DELL[KMarks]
Subject: Note
Date: 6/22/2006 3:45:19 PM

 **Table 58 — WRITE AND VERIFY (10) command CDB fields**
Row: BYTCHK

Why is BYTCHK not supported here, but is supported in a VERIFY command?

RESOLUTION: see 06-216

Status
rlsheffi Completed 7/23/2006 1:49:36 PM

Sequence number: 10
Author: LSI[OParry]
Subject: Highlight
Date: 6/22/2006 3:45:38 PM

 9.23 WRITE AND VERIFY (10) command
Table 58 - WRITE AND VERIFY (10) command CDB fields
(global for 12- and 16-byte versions of these commands)

The VERIFY commands allow BYTCHK support and the WRITE AND VERIFY commands do not. We should be consistent on both sets of commands.

Comments from page 82 continued on next page

9.23 WRITE AND VERIFY (10) command

The WRITE AND VERIFY (10) command is used to transfer application data to the ATA device's medium and then to verify that data was written correctly.

Table 58 — WRITE AND VERIFY (10) command CDB fields

Field	Description or reference
OPERATION CODE	9.22
WRPROTECT	Unspecified (see 3.4.3)
DPO	Unspecified (see 3.4.3)
BYTCHK	If the application client specifies a value other than zero in this field, the SATL shall terminate the command with CHECK CONDITION status with the sense key set to ILLEGAL REQUEST and the additional sense code set to INVALID FIELD IN CDB.
LOGICAL BLOCK ADDRESS	The logical block address shall be used to set the ATA LBA (see 3.1.11).
GROUP NUMBER	Unspecified (see 3.4.3)
TRANSFER LENGTH	The transfer length shall be used to set the ATA Sector Count (see 3.1.16). ^a The SATL shall issue as many ATA write commands (see 3.1.18) as needed to satisfy the transfer length specified by the WRITE AND VERIFY (10) command.
CONTROL	6.4
¹¹ A transfer length of zero ¹² indicates that a data transfer shall not take place.	

9.24 WRITE AND VERIFY (12) command

The WRITE AND VERIFY (12) command is used to transfer application data to the ATA device's medium and then to verify that data was written correctly.

Table 59 — WRITE AND VERIFY (12) command CDB fields

Field	Description or reference
OPERATION CODE	9.22
WRPROTECT	Unspecified (see 3.4.3)
DPO	Unspecified (see 3.4.3)
BYTCHK	If the application client specifies a value other than zero in this field, the SATL shall terminate the command with CHECK CONDITION status with the sense key set to ILLEGAL REQUEST and the additional sense code set to INVALID FIELD IN CDB.
LOGICAL BLOCK ADDRESS	The logical block address shall be used to set the ATA LBA (see 3.1.11).
GROUP NUMBER	Unspecified (see 3.4.3)
TRANSFER LENGTH	The transfer length shall be used to set the ATA Sector Count (see 3.1.16). ^a The SATL shall issue as many ATA write commands (see 3.1.18) as needed to satisfy the transfer length specified by the WRITE AND VERIFY (12) command.
CONTROL	6.4
^a A transfer length of zero indicates that a data transfer shall not take place.	

RESOLUTION: see 06-216

Status
rlsheffi Completed 7/23/2006 1:49:50 PM

Sequence number: 11
Author: DELL[KMarks]
Subject: Highlight
Date: 6/22/2006 3:45:48 PM

T **Table 58 — WRITE AND VERIFY (10) command CDB fields**
footnote a
change

"a A transfer length of zero indicates that a data transfer shall not take place."
to
"a A TRANSFER LENGTH set to 0h specifies that a data transfer shall not take place."

RESOLUTION: s/b
"a A TRANSFER LENGTH field set to zero specifies that a data transfer shall not take place."
RESOLUTION: see 06-216

Status
rlsheffi Completed 7/23/2006 1:50:06 PM

Sequence number: 12
Author: HPQ[RElliott]
Subject: Highlight
Date: 6/22/2006 3:45:54 PM

T 9.23
table 58

indicates s/b specifies

RESOLUTION: see 06-216

Status
rlsheffi Completed 7/23/2006 1:50:20 PM

Sequence number: 13
Author: IBM[GPenokie]
Subject: Underline
Date: 2/16/2006 1:43:21 PM

T 9.24 WRITE AND VERIFY (12) command

Status
rlsheffi Cancelled 5/6/2006 8:24:08 AM

Sequence number: 14
Author: DELL[KMarks]
Subject: Highlight
Date: 6/22/2006 3:47:24 PM

T **9.24 WRITE AND VERIFY (12) command**
1st Paragraph
change

"The WRITE AND VERIFY (12) command is used to transfer application data to the ATA device's medium and then to verify that data was written correctly."

to

"The WRITE AND VERIFY (12) command is used to transfer user data from the application client to the medium of the ATA device and then to verify that data was written correctly."

Table 59 shows the translation for fields specified in the WRITE AND VERIFY (12) CDB"

RESOLUTION: s/b
"The WRITE AND VERIFY (12) command requests that the SATL transfer the specified logical block(s) from the application client to the the ATA device, and then verify that the data was written correctly to the medium of the ATA device."

9.23 WRITE AND VERIFY (10) command

The WRITE AND VERIFY (10) command is used to transfer application data to the ATA device's medium and then to verify that data was written correctly.

Table 58 — WRITE AND VERIFY (10) command CDB fields

Field	Description or reference
OPERATION CODE	9.22
WRPROTECT	Unspecified (see 3.4.3)
DPO	Unspecified (see 3.4.3)
BYTCHK	If the application client specifies a value other than zero in this field, the SATL shall terminate the command with CHECK CONDITION status with the sense key set to ILLEGAL REQUEST and the additional sense code set to INVALID FIELD IN CDB.
LOGICAL BLOCK ADDRESS	The logical block address shall be used to set the ATA LBA (see 3.1.11).
GROUP NUMBER	Unspecified (see 3.4.3)
TRANSFER LENGTH	The transfer length shall be used to set the ATA Sector Count (see 3.1.16). ^a The SATL shall issue as many ATA write commands (see 3.1.18) as needed to satisfy the transfer length specified by the WRITE AND VERIFY (10) command.
CONTROL	6.4
^a A transfer length of zero indicates that a data transfer shall not take place.	

9.24 WRITE AND VERIFY (12) command

The WRITE AND VERIFY (12) command is used to transfer application data to the ATA device's medium and then to verify that data was written correctly.

Table 59 — WRITE AND VERIFY (12) command CDB fields

Field	Description or reference
OPERATION CODE	9.22
WRPROTECT	Unspecified (see 3.4.3)
DPO	Unspecified (see 3.4.3)
BYTCHK	If the application client specifies a value other than zero in this field, the SATL shall terminate the command with CHECK CONDITION status with the sense key set to ILLEGAL REQUEST and the additional sense code set to INVALID FIELD IN CDB.
LOGICAL BLOCK ADDRESS	The logical block address shall be used to set the ATA LBA (see 3.1.11).
GROUP NUMBER	Unspecified (see 3.4.3)
TRANSFER LENGTH	The transfer length shall be used to set the ATA Sector Count (see 3.1.16). ^a The SATL shall issue as many ATA write commands (see 3.1.18) as needed to satisfy the transfer length specified by the WRITE AND VERIFY (12) command.
CONTROL	6.4
^a A transfer length of zero indicates that a data transfer shall not take place.	

**Table 59 shows the translation for fields specified in the WRITE AND VERIFY (12) CDB"
RESOLUTION: see 06-216**

Status
rIsheffi Completed 7/23/2006 1:50:57 PM

Sequence number: 15
Author: MXO[MEvans]
Subject: Highlight
Date: 6/22/2006 3:47:41 PM

T 9.24 WRITE AND VERIFY (12) command, first paragraph: change to, "The WRITE AND VERIFY (12) command requests that the SATL transfer the specified logical block(s) to the ATA device, and then verify that the data was written correctly to the ATA device's medium."

RESOLUTION: see 06-216

Status
rIsheffi Completed 7/23/2006 1:51:01 PM

Sequence number: 16
Author: LSI[JLohmeyer]
Subject: Highlight
Date: 6/24/2006 1:28:23 PM

T 9.24 WRITE AND VERIFY (12) command

Change "that data" to "that the data".

RESOLUTION: see 06-216

Status
rIsheffi Completed 7/23/2006 1:50:58 PM

Sequence number: 17
Author: HPQ[RElliott]
Date: 6/22/2006 3:48:01 PM



9.24
need a reference to table 59

RESOLUTION: see 06-216

Status
rIsheffi Completed 7/23/2006 1:51:00 PM

Sequence number: 18
Author: IBM[GPenokie]
Subject: Highlight
Date: 6/22/2006 3:48:08 PM

T There is no reference to table 59. This needs to be fixed as all tables have to be referenced.

RESOLUTION: see 06-216

Status
rIsheffi Completed 7/23/2006 1:50:56 PM

Sequence number: 19
Author: DELL[KMarks]
Subject: Highlight
Date: 4/9/2006 11:47:49 AM

T Table 59 — WRITE AND VERIFY (12) command CDB fields
Row: WRPROTECT

This field can not be set to Unspecified, because the PROTECT bit in the INQUIRY data is a shall be set to zero. Change the PROTECT bit to Unspecified or change this field to if not 000b, then CHECK CONDITION/IR/IFIC.

REASON: Changed the PROTECT bit in INQUIRY data to "Unspecified (see 3.4.3)" instead - consistent with the rest of the document.

Status
rIsheffi Rejected 4/9/2006 11:47:53 AM

Sequence number: 20
Author: DELL[KMarks]

9.23 WRITE AND VERIFY (10) command

The WRITE AND VERIFY (10) command is used to transfer application data to the ATA device's medium and then to verify that data was written correctly.

Table 58 — WRITE AND VERIFY (10) command CDB fields

Field	Description or reference
OPERATION CODE	9.22
WRPROTECT	Unspecified (see 3.4.3)
DPO	Unspecified (see 3.4.3)
BYTCHK	If the application client specifies a value other than zero in this field, the SATL shall terminate the command with CHECK CONDITION status with the sense key set to ILLEGAL REQUEST and the additional sense code set to INVALID FIELD IN CDB.
LOGICAL BLOCK ADDRESS	The logical block address shall be used to set the ATA LBA (see 3.1.11).
GROUP NUMBER	Unspecified (see 3.4.3)
TRANSFER LENGTH	The transfer length shall be used to set the ATA Sector Count (see 3.1.16). ^a The SATL shall issue as many ATA write commands (see 3.1.18) as needed to satisfy the transfer length specified by the WRITE AND VERIFY (10) command.
CONTROL	6.4
^a A transfer length of zero indicates that a data transfer shall not take place.	

9.24 WRITE AND VERIFY (12) command

The WRITE AND VERIFY (12) command is used to transfer application data to the ATA device's medium and then to verify that data was written correctly.

Table 59 — WRITE AND VERIFY (12) command CDB fields

Field	Description or reference
OPERATION CODE	9.22
WRPROTECT	Unspecified (see 3.4.3)
DPO	Unspecified (see 3.4.3)
BYTCHK	If the application client specifies a value other than zero in this field, the SATL shall terminate the command with CHECK CONDITION status with the sense key set to ILLEGAL REQUEST and the additional sense code set to INVALID FIELD IN CDB.
LOGICAL BLOCK ADDRESS	The logical block address shall be used to set the ATA LBA (see 3.1.11).
GROUP NUMBER	Unspecified (see 3.4.3)
TRANSFER LENGTH	The transfer length shall be used to set the ATA Sector Count (see 3.1.16). ^a The SATL shall issue as many ATA write commands (see 3.1.18) as needed to satisfy the transfer length specified by the WRITE AND VERIFY (12) command.
CONTROL	6.4
^a A transfer length of zero indicates that a data transfer shall not take place.	

Subject: Note
Date: 6/22/2006 3:48:23 PM

 **Table 59 — WRITE AND VERIFY (12) command CDB fields**
Row: BYTCHK

Why is BYTCHK not supported here, but is supported in a VERIFY command?

RESOLUTION: see 06-216

Status
rlsheffi Completed 7/23/2006 1:50:59 PM

Sequence number: 21
Author: WDC[CStevens]
Subject: Note
Date: 7/23/2006 1:51:29 PM

 This should be attached to TRANSFER LENGTH.

RESOLUTION: see 06-216 Move table footnote reference to the left-most column. (fixed in SAT-r08c)

Status
rlsheffi Completed 7/23/2006 1:51:36 PM

Sequence number: 22
Author: DELL[KMarks]
Subject: Highlight
Date: 6/22/2006 3:49:03 PM

 **Table 59 — WRITE AND VERIFY (12) command CDB fields**
footnote a
change

"a A transfer length of zero indicates that a data transfer shall not take place."
to
"a A TRANSFER LENGTH set to 0h specifies that a data transfer shall not take place."

RESOLUTION: see 06-216 s/b

"a A TRANSFER LENGTH field set to zero specifies that a data transfer shall not take place."

Status
rlsheffi Completed 7/23/2006 1:51:44 PM

Sequence number: 23
Author: HPQ[RElliott]
Subject: Highlight
Date: 6/22/2006 3:49:10 PM

 9.24
table 59

indicates s/b specifies

RESOLUTION: see 06-216

Status
rlsheffi Completed 7/23/2006 1:51:43 PM

9.25 WRITE AND VERIFY (16) command

The WRITE AND VERIFY (16) command is used to transfer application data to the ATA device's medium and then to verify that data was written correctly.

Table 60 — WRITE AND VERIFY (16) command CDB fields

Field	Description or reference
OPERATION CODE	9.22
WRPROTECT	Unspecified (see 3.4.3)
DPO	Unspecified (see 3.4.3)
BYTCHK	If the application client specifies a value other than zero in this field, the SATL shall terminate the command with CHECK CONDITION status with the sense key set to ILLI LEGAL REQUEST and the additional sense code set to INVALID FIELD IN CDB.
LOGICAL BLOCK ADDRESS	The logical block address shall be used to set the ATA LBA (see 3.1.11).
GROUP NUMBER	Unspecified (see 3.4.3)
TRANSFER LENGTH	The transfer length shall be used to set the ATA Sector Count (see 3.1.16). ^a The SATL shall issue as many ATA write commands (see 3.1.18) as needed to satisfy the transfer length specified by the WRITE AND VERIFY (16) command.
CONTROL	6.4

^a A transfer length of zero indicates that a data transfer shall not take place.

Sequence number: 1
Author: IBM[GPenokie]
Subject: Underline
Date: 2/16/2006 1:28:07 PM
T9.25 WRITE AND VERIFY (16) command

Status
rlsheffi Cancelled 5/6/2006 8:37:02 AM

Sequence number: 2
Author: DELL[KMarks]
Subject: Highlight
Date: 6/22/2006 3:49:47 PM
T9.25 WRITE AND VERIFY (16) command

1st Paragraph
change

"The WRITE AND VERIFY (16) command is used to transfer application data to the ATA device's medium and then to verify that data was written correctly."

to

"The WRITE AND VERIFY (16) command is used to transfer user data from the application client to the medium of the ATA device and then to verify that data was written correctly."

Table 60 shows the translation for fields specified in the WRITE AND VERIFY (16) CDB"

RESOLUTION: see 06-216 s/b

"The WRITE AND VERIFY (16) command requests that the SATL transfer the specified logical block(s) from the application client to the the ATA device, and then verify that the data was written correctly to the medium of the ATA device."

Table 60 shows the translation for fields specified in the WRITE AND VERIFY (16) CDB"

Status
rlsheffi Completed 7/23/2006 1:52:31 PM

Sequence number: 3
Author: MXO[MEvans]
Subject: Highlight
Date: 6/22/2006 3:49:57 PM
T9.25 WRITE AND VERIFY (16) command, first paragraph: change to, "The WRITE AND VERIFY (16) command requests that the SATL transfer the specified logical block(s) to the ATA device, and then verify that the data was written correctly to the ATA device's medium."

RESOLUTION: see 06-216

Status
rlsheffi Completed 7/23/2006 1:52:31 PM

Sequence number: 4
Author: LS[JLohmeyer]
Subject: Highlight
Date: 6/22/2006 3:50:08 PM
T9.25 WRITE AND VERIFY (16) command

Change "that data" to "that the data".

RESOLUTION: see 06-216

Status
rlsheffi Completed 7/23/2006 1:52:30 PM

Sequence number: 5
Author: HPQ[RElliott]
Date: 6/22/2006 3:50:14 PM
9.25

9.25 WRITE AND VERIFY (16) command

The WRITE AND VERIFY (16) command is used to transfer application data to the ATA device's medium and then to verify that data was written correctly.

Table 60 — WRITE AND VERIFY (16) command CDB fields

Field	Description or reference
OPERATION CODE	9.22
WRPROTECT	Unspecified (see 3.4.3)
DPO	Unspecified (see 3.4.3)
BYTCHK	If the application client specifies a value other than zero in this field, the SATL shall terminate the command with CHECK CONDITION status with the sense key set to ILLI LEGAL REQUEST and the additional sense code set to INVALID FIELD IN CDB.
LOGICAL BLOCK ADDRESS	The logical block address shall be used to set the ATA LBA (see 3.1.11).
GROUP NUMBER	Unspecified (see 3.4.3)
TRANSFER LENGTH	The transfer length shall be used to set the ATA Sector Count (see 3.1.16). The SATL shall issue as many ATA write commands (see 3.1.18) as needed to satisfy the transfer length specified by the WRITE AND VERIFY (16) command.
CONTROL	6.4
A transfer length of zero indicates that a data transfer shall not take place.	

need a reference to table 60

RESOLUTION: see 06-216

Status
rlsheffi Completed 7/23/2006 1:52:29 PM

Sequence number: 6
Author: IBM[GPenokie]
Subject: Highlight
Date: 6/22/2006 3:50:21 PM

T There is no reference to table 60. This needs to be fixed as all tables have to be referenced.

RESOLUTION: see 06-216

Status
rlsheffi Completed 7/23/2006 1:52:31 PM

Sequence number: 7
Author: DELL[KMarks]
Subject: Highlight
Date: 4/9/2006 11:48:10 AM

T **Table 60 — WRITE AND VERIFY (16) command CDB fields**
Row: WRPROTECT

This field can not be set to Unspecified, because the PROTECT bit in the INQUIRY data is a shall be set to zero. Change the PROTECT bit to Unspecified or change this field to if not 000b, then CHECK CONDITION/IR/IFIC.

REASON: Changed the PROTECT bit in INQUIRY data to "Unspecified (see 3.4.3)" instead - consistent with the rest of the document.

Status
rlsheffi Rejected 4/9/2006 11:48:13 AM

Sequence number: 8
Author: DELL[KMarks]
Subject: Note
Date: 7/12/2006 8:30:29 PM

T **Table 60 — WRITE AND VERIFY (16) command CDB fields**
Row: BYTCHK

Why is BYTCHK not supported here, but is supported in a VERIFY command?

RESOLUTION: see 06-216

Status
rlsheffi Completed 7/23/2006 1:52:30 PM

Sequence number: 9
Author: WDC[CStevens]
Subject: Note
Date: 7/23/2006 1:52:09 PM

T This should be attached to TRANSFER LENGTH.

RESOLUTION: see 06-216 Move table footnote reference to the left-most column. (Fixed in SAT-r08c)

Status
rlsheffi Completed 7/23/2006 1:52:13 PM

Sequence number: 10
Author: DELL[KMarks]
Subject: Highlight
Date: 6/22/2006 3:51:09 PM

T **Table 60 — WRITE AND VERIFY (16) command CDB fields**
footnote a
change

"a A transfer length of zero indicates that a data transfer shall not take place."

to

"a A TRANSFER LENGTH set to 0h specifies that a data transfer shall not take place."

9.25 WRITE AND VERIFY (16) command

The WRITE AND VERIFY (16) command is used to transfer application data to the ATA device's medium and then to verify that data was written correctly.

Table 60 — WRITE AND VERIFY (16) command CDB fields

Field	Description or reference
OPERATION CODE	9.22
WRPROTECT	Unspecified (see 3.4.3)
DPO	Unspecified (see 3.4.3)
BYTCHK	If the application client specifies a value other than zero in this field, the SATL shall terminate the command with CHECK CONDITION status with the sense key set to ILLI LEGAL REQUEST and the additional sense code set to INVALID FIELD IN CDB.
LOGICAL BLOCK ADDRESS	The logical block address shall be used to set the ATA LBA (see 3.1.11).
GROUP NUMBER	Unspecified (see 3.4.3)
TRANSFER LENGTH	The transfer length shall be used to set the ATA Sector Count (see 3.1.16). ^a The SATL shall issue as many ATA write commands (see 3.1.18) as needed to satisfy the transfer length specified by the WRITE AND VERIFY (16) command.
CONTROL	6.4
^a A transfer length of zero ¹¹ indicates that a data transfer shall not take place.	

RESOLUTION: see 06-216 s/b

"a A TRANSFER LENGTH field set to zero specifies that a data transfer shall not take place."

Status
risheffi Completed 7/23/2006 1:52:28 PM

Sequence number: 11
Author: HPQ[RElliott]
Subject: Highlight
Date: 6/22/2006 3:51:17 PM

T9.25
table 60

indicates s/b specifies

RESOLUTION: see 06-216

Status
risheffi Completed 7/23/2006 1:52:28 PM

9.26 WRITE SAME (10) command

9.26.1 WRITE SAME (10) command overview

The WRITE SAME (10) command (see table 61) requests that the SATL transfer a single logical block from the data-out buffer and write the contents of that single logical block, with modifications based on the LBDATA bit and the PBDATA bit, to the specified range of logical block addresses.

Table 61 — WRITE SAME (10) command CDB fields

Field	Description or reference
OPERATION CODE	If the ATA device supports SCT LBA Segment Access (see SCT), the SATL should issue SCT LBA Segment Access to repeatedly write the data in the buffer to the device. If the device does not implement SCT then the SATL shall issue ATA write commands as defined in 9.17.1.
WRPROTECT	Unspecified (see 3.4.3)
LBDATA	9.26.2
PBDATA	9.26.2
LOGICAL BLOCK ADDRESS	The logical block address shall be used to set the ATA LBA (see 3.1.11).
GROUP NUMBER	Unspecified (see 3.4.3)
NUMBER OF BLOCKS	A number of blocks of zero indicates that the data-out buffer shall be repeatedly written from the specified logical block address through the last user addressable logical sector on the media. If the number of blocks is not zero, the SATL shall repeatedly write the data-out buffer for the number of logical sectors specified to the device. The SATL shall send as many ATA commands as required to satisfy the number of logical blocks specified by the WRITE SAME (10) command.
CONTROL	6.4

9.26.2 LBDATA bit and PBDATA bit

The SATL shall write data to the specified logical block addresses according to the values in the LBDATA and PBDATA bits as shown in table 62.

Table 62 — LBDATA and PBDATA fields

LBDATA	PBDATA	Description
0	0	The SATL shall transfer the single block of data from the data output buffer to the range of blocks specified in LOGICAL BLOCK ADDRESS and NUMBER OF BLOCKS repeatedly on the media. If the ATA device supports the SCT LBA Segment Access capability, then this should be used for the data transfer. Otherwise, write commands shall be used as documented in 9.12.2. See SBC-2
0	1	The SATL shall terminate the command with CHECK CONDITION status with the sense key set to ILLEGAL REQUEST and the additional sense code set to INVALID FIELD IN CDB.
1	0	The SATL shall replace the first four bytes of the logical block received from the data-out buffer with the least significant four bytes of the LBA of the logical block being written to the media, ending with the least significant byte (e.g., if the LBA is 77665544_33221100h, 33221100h is written with 33h written first and 00h written last).
1	1	The SATL shall terminate the command with CHECK CONDITION status with the sense key set to ILLEGAL REQUEST and the additional sense code set to INVALID FIELD IN CDB.

Sequence number: 1
Author: DELL[KMarks]
Subject: Highlight
Date: 6/22/2006 4:01:26 PM

T 9.26.1 WRITE SAME (10) command overview
1st Paragraph

change

"The WRITE SAME (10) command (see table 61) requests that the SATL transfer a single logical block from the data-out buffer and write the contents of that single logical block, with modifications based on the LBDATA bit and the PBDATA bit, to the specified range of logical block addresses."

to

"The WRITE SAME (10) command (see table 61) requests that the SATL transfer a single logical block from the application client and write the contents of that single logical block, with modifications based on the LBDATA bit and the PBDATA bit, to the specified range of logical block addresses on the ATA device."

If you are going to start using data-out buffer then most of the command overviews need to be changed to a data-in and data-out buffer type explanations.

RESOLUTION: see 06-216

Status
rlsheffi Completed 7/23/2006 1:53:40 PM

Sequence number: 2
Author: WDC[CStevens]
Subject: Comment on Text
Date: 6/22/2006 4:07:36 PM

T ATA8-ACS now documents SCT. The name of the command has been changed to WRITE SAME. Since this document is wrapping up for letter ballot, it might be reasonable to reference the draft instead of a technical report.

RESOLUTION: see 06-216

Status
rlsheffi Completed 7/23/2006 1:53:58 PM

Sequence number: 3
Author: DELL[KMarks]
Subject: Highlight
Date: 6/22/2006 4:07:26 PM

T Table 61 — WRITE SAME (10) command CDB fields
Row: OPERATION CODE

"If the ATA device supports SCT LBA Segment Access (see SCT), the SATL should issue SCT LBA Segment Access to repeatedly write the data in the buffer to the device. If the device does not implement SCT then the SATL shall issue ATA write commands as defined in 9.17.1."

to

"If the ATA device supports SCT LBA Segment Access (see SCT), the SATL should issue SCT LBA Segment Access to repeatedly write the data block transferred from the application client to the ATA device. If the ATA device does not implement SCT then the SATL shall issue ATA write commands as defined in 9.17.1."

RESOLUTION: see 06-216 - s/b

"If the ATA device supports the ATA WRITE SAME command (see ATA8-ACS), then the SATL should issue the ATA WRITE SAME command to repeatedly write the data block transferred from the application client to the ATA device. If the ATA device does not implement the ATA WRITE SAME COMMAND then the SATL shall issue ATA write commands as defined in 9.17.1."

Status
rlsheffi Completed 7/23/2006 1:54:11 PM

9.26 WRITE SAME (10) command

9.26.1 WRITE SAME (10) command overview

The WRITE SAME (10) command (see table 61) requests that the SATL transfer a single logical block from the data-out buffer and write the contents of that single logical block, with modifications based on the LBDATA bit and the PBDATA bit, to the specified range of logical block addresses.

Table 61 — WRITE SAME (10) command CDB fields

Field	Description or reference
OPERATION CODE	If the ATA device supports SCT LBA Segment Access (see SCT), the SATL should issue SCT LBA Segment Access to repeatedly write the data in the buffer to the device. If the device does not implement SCT then the SATL shall issue ATA write commands as defined in 9.17.1.
WRPROTECT	4 Unspecified (see 3.4.3)
LBDATA	9.26.2
PBDATA	9.26.2
LOGICAL BLOCK ADDRESS	The logical block address shall be used to set the ATA LBA (see 3.1.11).
GROUP NUMBER	Unspecified (see 3.4.3)
NUMBER OF BLOCKS	6 number of blocks of zero 5 indicates that the data-out buffer shall be repeatedly written from the specified logical block address through the last user addressable logical sector on the media. If the number of blocks is not zero, the SATL shall repeatedly write the data-out buffer for the number of logical sectors specified to the device. The SATL shall send as many ATA commands as required to satisfy the number of logical blocks specified by the WRITE SAME (10) command.
CONTROL	6.4

9.26.2 LBDATA bit and PBDATA bit

The SATL shall write data to the specified logical block addresses according to the values in the LBDATA and PBDATA bits as shown in table 62.

Table 62 — LBDATA and PBDATA fields

LBDATA	PBDATA	Description
0	0	7 The SATL shall transfer the single block of data from the data output buffer to the range of blocks specified in LOGICAL BLOCK ADDRESS and NUMBER OF BLOCKS repeatedly on the media. If the ATA device supports the SCT LBA Segment Access capability, then this should be used for the data transfer. Otherwise, write commands shall be used as documented in 9.12.2. See SBC-2
0	1	The SATL shall terminate the command with CHECK CONDITION status with the sense key set to ILLEGAL REQUEST and the additional sense code set to INVALID FIELD IN CDB.
1	0	The SATL shall replace the first four bytes of the logical block received from the data-out buffer with the least significant four bytes of the LBA of the logical block being written to the media, ending with the least significant byte (e.g., if the LBA is 77665544_33221100h, 33221100h is written with 33h written first and 00h written last).
1	1	The SATL shall terminate the command with CHECK CONDITION status with the sense key set to ILLEGAL REQUEST and the additional sense code set to INVALID FIELD IN CDB.

Sequence number: 4
Author: DELL[KMarks]
Subject: Highlight
Date: 4/9/2006 11:48:30 AM

T Table 61 — WRITE SAME (10) command CDB fields
Row: WRPROTECT

This field can not be set to Unspecified, because the PROTECT bit in the INQUIRY data is a shall be set to zero. Change the PROTECT bit to Unspecified or change this field to if not 000b, then CHECK CONDITION/IR/IFIC.

REASON: Changed the PROTECT bit in INQUIRY data to "Unspecified (see 3.4.3)" instead - consistent with the rest of the document.

Status
rlsheffi Rejected 4/9/2006 11:48:34 AM

Sequence number: 5
Author: HPQ[RElliott]
Subject: Highlight
Date: 6/24/2006 9:04:45 AM

T 9.26.1
table 61

indicates s/b specifies

RESOLUTION: see 06-216

Status
rlsheffi Completed 7/23/2006 1:54:34 PM

Sequence number: 6
Author: DELL[KMarks]
Subject: Highlight
Date: 6/22/2006 4:21:59 PM

T Table 61 — WRITE SAME (10) command CDB fields
Row: NUMBER OF BLOCKS
change

"A number of blocks of zero indicates that the data-out buffer shall be repeatedly written from the specified logical block address through the last user addressable logical sector on the media. If the number of blocks is not zero, the SATL shall repeatedly write the data-out buffer for the number of logical sectors specified to the device. The SATL shall send as many ATA commands as required to satisfy the number of logical blocks specified by the WRITE SAME (10) command."

to

"A NUMBER OF BLOCKS field set to 0h specifies that the SATL shall repeatedly write the data block transferred from the application client to the value specified in the LOGICAL BLOCK ADDRESS field through the last user addressable logical sector on the medium of the ATA device. If the value in the NUMBER OF BLOCKS field is non-zero, the SATL shall repeatedly write the data block transferred from the application client for the number of logical sectors specified to the ATA device. The SATL shall send as many ATA write commands as required to satisfy the number of blocks specified by the WRITE SAME (10) command."

RESOLUTION: see 06-216: s/b

"A NUMBER OF BLOCKS field set to zero specifies that the SATL shall repeatedly write the logical block transferred from the application client to the location specified in the LOGICAL BLOCK ADDRESS field through the last user addressable logical sector on the medium of the ATA device. If the value in the NUMBER OF BLOCKS field is set to a value other than zero, the SATL shall repeatedly write the data block transferred from the application client for the number of logical sectors specified to the ATA device. The SATL shall send as many ATA write commands as required to satisfy the number of blocks specified by the WRITE SAME (10) command."

Status
rlsheffi Completed 7/23/2006 1:54:42 PM

Sequence number: 7
Author: DELL[KMarks]
Subject: Highlight
Date: 7/23/2006 1:58:09 PM

Comments from page 84 continued on next page

9.26 WRITE SAME (10) command

9.26.1 WRITE SAME (10) command overview

The WRITE SAME (10) command (see table 61) requests that the SATL transfer a single logical block from the data-out buffer and write the contents of that single logical block, with modifications based on the LBDATA bit and the PBDATA bit, to the specified range of logical block addresses.

Table 61 — WRITE SAME (10) command CDB fields

Field	Description or reference
OPERATION CODE	If the ATA device supports SCT LBA Segment Access (see SCT), the SATL should issue SCT LBA Segment Access to repeatedly write the data in the buffer to the device. If the device does not implement SCT then the SATL shall issue ATA write commands as defined in 9.17.1.
WRPROTECT	Unspecified (see 3.4.3)
LBDATA	9.26.2
PBDATA	9.26.2
LOGICAL BLOCK ADDRESS	The logical block address shall be used to set the ATA LBA (see 3.1.11).
GROUP NUMBER	Unspecified (see 3.4.3)
NUMBER OF BLOCKS	A number of blocks of zero indicates that the data-out buffer shall be repeatedly written from the specified logical block address through the last user addressable logical sector on the media. If the number of blocks is not zero, the SATL shall repeatedly write the data-out buffer for the number of logical sectors specified to the device. The SATL shall send as many ATA commands as required to satisfy the number of logical blocks specified by the WRITE SAME (10) command.
CONTROL	6.4

9.26.2 LBDATA bit and PBDATA bit

The SATL shall write data to the specified logical block addresses according to the values in the LBDATA and PBDATA bits as shown in table 62.

Table 62 — LBDATA and PBDATA fields

LBDATA	PBDATA	Description
0	0	The SATL shall transfer the single block of data from the data output buffer to the range of blocks specified in LOGICAL BLOCK ADDRESS and NUMBER OF BLOCKS repeatedly on the media. If the ATA device supports the SCT LBA Segment Access capability, then this should be used for the data transfer. Otherwise, write commands shall be used as documented in 9.12.2. See SBC-2
0	1	The SATL shall terminate the command with CHECK CONDITION status with the sense key set to ILLEGAL REQUEST and the additional sense code set to INVALID FIELD IN CDB.
1	0	The SATL shall replace the first four bytes of the logical block received from the data-out buffer with the least significant four bytes of the LBA of the logical block being written to the media, ending with the least significant byte (e.g., if the LBA is 77665544_33221100h, 33221100h is written with 33h written first and 00h written last).
1	1	The SATL shall terminate the command with CHECK CONDITION status with the sense key set to ILLEGAL REQUEST and the additional sense code set to INVALID FIELD IN CDB.

T Table 62 — LBDATA and PBDATA fields
Row: 0 0 in Description column
change

"The SATL shall transfer the single block of data from the data output buffer to the range of blocks specified in LOGICAL BLOCK ADDRESS and NUMBER OF BLOCKS repeatedly on the media. If the ATA device supports the SCT LBA Segment Access capability, then this should be used for the data transfer. Otherwise, write commands shall be used as documented in 9.12.2. See SBC-2"

to

"The SATL shall write the block of data transferred from the application client to the range of blocks specified in LOGICAL BLOCK ADDRESS and NUMBER OF BLOCKS repeatedly on the medium of the ATA device. If the ATA device supports the SCT LBA Segment Access capability, then the SATL should use the SCT LBA Segment Access for writing the data. Otherwise, the SATL shall use ATA write commands as defined in 9.17.2. See SBC-2"

Not sure if the link should be 9.17.2, but 9.12.2 does not exist.

RESOLUTION: see 06-216 s/b

"The SATL shall write the block of data transferred from the application client to the range of blocks specified in LOGICAL BLOCK ADDRESS field and the NUMBER OF BLOCKS field, repeatedly, on the medium of the ATA device. If the ATA device supports the ATA WRITE SAME command, then the SATL should use the ATA WRITE SAME command for writing the data. Otherwise, the SATL shall use ATA write commands as defined in 9.17.2 (see SBC-2)"

Note: 06-216r2 began, "The SATL shall transfer the block of data transferred...", but it should be "The SATL shall write the block of data transferred..." SAT-r08b reflects 06-216r2. It is corrected in SAT-r08c.

Status
risheffi Completed 7/23/2006 1:58:13 PM

Sequence number: 8
Author: HPQ[RElliott]
Subject: Highlight
Date: 6/22/2006 4:34:15 PM

T 9.26.2
table 62

"write commands" s/b "ATA write commands"

RESOLUTION: see 06-216

Status
risheffi Completed 7/23/2006 1:58:39 PM

Sequence number: 9
Author: DELL[KMarks]
Subject: Highlight
Date: 6/22/2006 4:56:56 PM

T Table 62 — LBDATA and PBDATA fields
Row: 1 0 in Description column
change

"The SATL shall replace the first four bytes of the logical block received from the data-out buffer with the least significant four bytes of the LBA of the logical block being written to the media, ending with the least significant byte (e.g., if the LBA is 77665544_33221100h, 33221100h is written with 33h written first and 00h written last)."

to

"The SATL shall replace the first four bytes of the logical block received from the application client with the least significant four bytes of the LBA of the logical block being written to the media, ending with the least significant byte (e.g., if the LBA is 77665544_33221100h, 33221100h is written with 33h written first and 00h written last)."

Does a comment about SCT need to be added here?

RESOLUTION: see 06-216

9.26 WRITE SAME (10) command

9.26.1 WRITE SAME (10) command overview

The WRITE SAME (10) command (see table 61) requests that the SATL transfer a single logical block from the data-out buffer and write the contents of that single logical block, with modifications based on the LBDATA bit and the PBDATA bit, to the specified range of logical block addresses.

Table 61 — WRITE SAME (10) command CDB fields

Field	Description or reference
OPERATION CODE	If the ATA device supports SCT LBA Segment Access (see SCT), the SATL should issue SCT LBA Segment Access to repeatedly write the data in the buffer to the device. If the device does not implement SCT then the SATL shall issue ATA write commands as defined in 9.17.1.
WRPROTECT	Unspecified (see 3.4.3)
LBDATA	9.26.2
PBDATA	9.26.2
LOGICAL BLOCK ADDRESS	The logical block address shall be used to set the ATA LBA (see 3.1.11).
GROUP NUMBER	Unspecified (see 3.4.3)
NUMBER OF BLOCKS	A number of blocks of zero indicates that the data-out buffer shall be repeatedly written from the specified logical block address through the last user addressable logical sector on the media. If the number of blocks is not zero, the SATL shall repeatedly write the data-out buffer for the number of logical sectors specified to the device. The SATL shall send as many ATA commands as required to satisfy the number of logical blocks specified by the WRITE SAME (10) command.
CONTROL	6.4

9.26.2 LBDATA bit and PBDATA bit

The SATL shall write data to the specified logical block addresses according to the values in the LBDATA and PBDATA bits as shown in table 62.

Table 62 — LBDATA and PBDATA fields

LBDATA	PBDATA	Description
0	0	The SATL shall transfer the single block of data from the data output buffer to the range of blocks specified in LOGICAL BLOCK ADDRESS and NUMBER OF BLOCKS repeatedly on the media. If the ATA device supports the SCT LBA Segment Access capability, then this should be used for the data transfer. Otherwise, write commands shall be used as documented in 9.12.2. See SBC-2
0	1	The SATL shall terminate the command with CHECK CONDITION status with the sense key set to ILLEGAL REQUEST and the additional sense code set to INVALID FIELD IN CDB.
1	0	The SATL shall replace the first four bytes of the logical block received from the data-out buffer with the least significant four bytes of the LBA of the logical block being written to the media, ending with the least significant byte (e.g., if the LBA is 77665544_33221100h, 33221100h is written with 33h written first and 00h written last).
1	1	The SATL shall terminate the command with CHECK CONDITION status with the sense key set to ILLEGAL REQUEST and the additional sense code set to INVALID FIELD IN CDB.

Status
risheffi Completed

7/23/2006 1:59:07 PM

9.27 WRITE SAME (16) command

¹The WRITE SAME (16) command (see table 63) requests that the SATL transfer a single logical block from the data-out buffer and write the contents of that single logical block, with modifications based on the LBDATA bit and the PBDATA bit, to the specified range of logical block addresses.

Table 63 — WRITE SAME (16) command CDB fields

Field	Description or reference
OPERATION CODE	² the ATA device supports SCT LBA Segment Access (see SCT), the SATL should issue SCT LBA Segment Access to repeatedly write the data in the buffer to the ATA device. If the ATA device does not implement SCT then the SATL shall issue ATA write commands as defined in 9.17.1.
WRPROTECT	³ Unspecified (see 3.4.3)
LBDATA	9.26.2
PBDATA	9.26.2
LOGICAL BLOCK ADDRESS	The logical block address shall be used to set the ATA LBA (see 3.1.11).
GROUP NUMBER	Unspecified (see 3.4.3)
NUMBER OF BLOCKS	A number of blocks of zero ⁴ indicates that the data-out buffer shall be repeatedly written from logical block address through the last user addressable logical sector on the media. If the number of blocks is not zero, the SATL shall repeatedly write the data-out buffer for the number of sectors specified to the device. The SATL shall send as many ATA commands as required to satisfy the number of logical blocks specified by the WRITE SAME (16) command.
CONTROL	6.4

Sequence number: 1
Author: DELL[KMarks]
Subject: Highlight
Date: 6/22/2006 5:21:06 PM

T 9.27 WRITE SAME (16) command
1st Paragraph

change

"The WRITE SAME (16) command (see table 63) requests that the SATL transfer a single logical block from the data-out buffer and write the contents of that single logical block, with modifications based on the LBDATA bit and the PBDATA bit, to the specified range of logical block addresses."

to

"The WRITE SAME (16) command (see table 63) requests that the SATL transfer a single logical block from the application client and write the contents of that single logical block, with modifications based on the LBDATA bit and the PBDATA bit, to the specified range of logical block addresses on the ATA device."

If you are going to start using data-out buffer then most of the command overviews need to be changed to a data-in and data-out buffer type explanations.

RESOLUTION: see 06-216

Status
rsheffi Completed 7/23/2006 1:59:38 PM

Sequence number: 2
Author: DELL[KMarks]
Subject: Highlight
Date: 6/22/2006 5:21:37 PM

T Table 63 — WRITE SAME (16) command CDB fields
Row: OPERATION CODE

"If the ATA device supports SCT LBA Segment Access (see SCT), the SATL should issue SCT LBA Segment Access to repeatedly write the data in the buffer to the device. If the device does not implement SCT then the SATL shall issue ATA write commands as defined in 9.17.1."

to

"If the ATA device supports SCT LBA Segment Access (see SCT), the SATL should issue SCT LBA Segment Access to repeatedly write the data block transferred from the application client to the ATA device. If the ATA device does not implement SCT then the SATL shall issue ATA write commands as defined in 9.17.1."

RESOLUTION: see 06-216

Status
rsheffi Completed 7/23/2006 1:59:56 PM

Sequence number: 3
Author: DELL[KMarks]
Subject: Highlight
Date: 4/9/2006 11:48:51 AM

T Table 63 — WRITE SAME (16) command CDB fields
Row: WRPROTECT

This field can not be set to Unspecified, because the PROTECT bit in the INQUIRY data is a shall be set to zero. Change the PROTECT bit to Unspecified or change this field to if not 000b, then CHECK CONDITION/IR/IFIC.

REASON: Changed the PROTECT bit in INQUIRY data to "Unspecified (see 3.4.3)" instead - consistent with the rest of the document.

Status
rsheffi Rejected 4/9/2006 11:48:54 AM

Sequence number: 4

9.27 WRITE SAME (16) command

The WRITE SAME (16) command (see table 63) requests that the SATL transfer a single logical block from the data-out buffer and write the contents of that single logical block, with modifications based on the LBDATA bit and the PBDATA bit, to the specified range of logical block addresses.

Table 63 — WRITE SAME (16) command CDB fields

Field	Description or reference
OPERATION CODE	If the ATA device supports SCT LBA Segment Access (see SCT), the SATL should issue SCT LBA Segment Access to repeatedly write the data in the buffer to the ATA device. If the ATA device does not implement SCT then the SATL shall issue ATA write commands as defined in 9.17.1.
WRPROTECT	Unspecified (see 3.4.3)
LBDATA	9.26.2
PBDATA	9.26.2
LOGICAL BLOCK ADDRESS	The logical block address shall be used to set the ATA LBA (see 3.1.11).
GROUP NUMBER	Unspecified (see 3.4.3)
NUMBER OF BLOCKS	5 number of blocks of zero indicates that the data-out buffer shall be repeatedly written from logical block address through the last user addressable logical sector on the media. If the number of blocks is not zero, the SATL shall repeatedly write the data-out buffer for the number of sectors specified to the device. The SATL shall send as many ATA commands as required to satisfy the number of logical blocks specified by the WRITE SAME (16) command.
CONTROL	6.4

Author: HPQ[RElliott]
Subject: Highlight
Date: 6/22/2006 5:21:49 PM

T9.27
table 63

indicates s/b specifies

RESOLUTION: see 06-216

Status
risheffi Completed 7/23/2006 2:00:09 PM

Sequence number: 5
Author: DELL[KMarks]
Subject: Highlight
Date: 6/22/2006 5:22:04 PM

TTable 63 — WRITE SAME (16) command CDB fields
Row: NUMBER OF BLOCKS
change

"A number of blocks of zero indicates that the data-out buffer shall be repeatedly written from the specified logical block address through the last user addressable logical sector on the media. If the number of blocks is not zero, the SATL shall repeatedly write the data-out buffer for the number of logical sectors specified to the device. The SATL shall send as many ATA commands as required to satisfy the number of logical blocks specified by the WRITE SAME (16) command."

to

"A NUMBER OF BLOCKS field set to 0h specifies that the SATL shall repeatedly write the data block transferred from the application client to the value specified in the LOGICAL BLOCK ADDRESS field through the last user addressable logical sector on the medium of the ATA device. If the value in the NUMBER OF BLOCKS field is non-zero, the SATL shall repeatedly write the data block transferred from the application client for the number of logical sectors specified to the ATA device. The SATL shall send as many ATA write commands as required to satisfy the number of blocks specified by the WRITE SAME (16) command."

RESOLUTION: see 06-216

Status
risheffi Completed 7/23/2006 2:00:16 PM

10 Parameters for SAT implementations

10.1 Mode parameters

10.1.1 General information

CSI mode parameters provide a mechanism to be used to set operating parameters for SCSI devices. MODE SENSE command is used to obtain operating parameters while MODE SELECT command is used to set operating parameters. In the context SCSI to SATA command translation most operating parameters defined by the contents of MODE PAGES are not supported due to lack of equivalent operations or features in ATA devices. The translator emulates a SCSI device server for all MODE SENSE and MODE SELECT commands and emulates the MODE PAGES listed in 10.1.3.

In SCSI, four types of mode page values are defined: current values, saved values, default values, and changeable values. The save parameters operation shall not be supported. Default values are manufacturing time initial values and are not changeable. All pages are shared between all logical units in the target. Mode Page Policy VPD is not implemented, therefore sharing of Mode pages across logical units is implied.

10.1.2 Changeable parameters

~~Except as specified in the descriptions of specific fields in supported mode pages, the SATL shall not implement changeable parameters mode pages.~~ If the SATL receives a MODE SENSE command with 01b in the PC field, the SATL shall terminate the command with CHECK CONDITION status. The sense key shall be set to ILLEGAL REQUEST, and the additional sense code set to INVALID FIELD IN CDB.

An attempt to change a non-changeable mode parameter using the MODE SELECT command shall result in an error condition, and the command shall be terminated with CHECK CONDITION status. The sense key shall be set to ILLEGAL REQUEST, and the additional sense code shall be set to INVALID FIELD IN CDB.

10.1.3 Commonly used SCSI mode pages overview

Mode parameters for which this standard defines translations are listed in table 64.

Table 64 — Summary of SCSI / ATA mode page mapping

SCSI mode page	Reference
Control	10.1.4
Read-Write Error Recovery	10.1.5
Caching	10.1.6
Informational Exceptions Control	10.1.7
All others	See SPC-3 and SBC-2 Unspecified (see 3.4.3)

10.1.4 Control mode page

10.1.4.1 General Translation

The control mode page provides controls and information about behavior of the emulated SCSI device.

Sequence number: 1
Author: HPQ[RElliott]
Subject: Cross-Out
Date: 6/23/2006 8:20:54 AM

 10.1.1

delete "be used to"
RESOLUTION: see DELL comment

Status
rlsheffi Completed 6/23/2006 8:20:57 AM

Sequence number: 2
Author: DELL[KMarks]
Subject: Highlight
Date: 5/9/2006 4:14:55 PM

 10.1.1 General information
1st Paragraph

"SCSI mode parameters provide a mechanism to be used to set operating parameters for SCSI devices. MODE SENSE command is used to obtain operating parameters while MODE SELECT command is used to set operating parameters. In the context SCSI to SATA command translation most operating parameters defined by the contents of MODE PAGES are not supported due to lack of equivalent operations or features in ATA devices. The translator emulates a SCSI device server for all MODE SENSE and MODE SELECT commands and emulates the MODE PAGES listed in 10.1.3."

to

"SCSI mode parameters provide a mechanism used to set operating parameters for SCSI devices and logical units. MODE SENSE command is used to obtain operating parameters while MODE SELECT command is used to set operating parameters. In the context SCSI to ATA command translation most operating parameters defined by the contents of mode pages are not supported due to lack of equivalent operations or features in ATA devices. The SATL emulates a SCSI device server for all MODE SENSE and MODE SELECT commands and emulates the mode pages listed in 10.1.3."

RESOLUTION: s/b

"SCSI mode parameters provide a mechanism to set operating parameters for SCSI devices and logical units. The MODE SENSE command obtains operating parameters while MODE SELECT command sets operating parameters. This standard does not define the content of most operating parameters defined in mode pages due to lack of equivalent operations or features defined for ATA devices. The SATL emulates a SCSI device server for all MODE SENSE and MODE SELECT commands, and emulates the mode pages listed in 10.1.3."

Status
rlsheffi Completed 6/23/2006 8:20:33 AM

Sequence number: 3
Author: HPQ[RElliott]
Subject: Highlight
Date: 5/6/2006 10:01:35 AM

 10.1.1

Add "The" before "MODE SENSE command"

RESOLUTION: See DELL comment

Status
rlsheffi Completed 6/23/2006 8:21:09 AM

Sequence number: 4
Author: HPQ[WBellamy]
Subject: Note
Date: 5/6/2006 10:01:57 AM

 supposed to be SATL
RESOLUTION: see DELL comment

Status
rlsheffi Completed 6/23/2006 8:21:16 AM

10 Parameters for SAT implementations

10.1 Mode parameters

10.1.1 General information

SCSI mode parameters provide a mechanism to be used to set operating parameters for SCSI devices. MODE SENSE command is used to obtain operating parameters while MODE SELECT command is used to set operating parameters. In the context SCSI to SATA command translation most operating parameters defined by the contents of MODE PAGES are not supported due to lack of equivalent operations or features in ATA devices. The translator emulates a SCSI device server for all MODE SENSE and MODE SELECT commands and emulates the MODE PAGES listed in 10.1.3.

SCSI, four types of mode page values are defined: current values, saved values, default values, and changeable values. The save parameters operation shall not be supported. Default values are manufacturing time initial values and are not changeable. All pages are shared between all logical units in the target. Mode Page Policy VPD is not implemented, therefore sharing of Mode pages across logical units is implied.

10.1.2 Changeable parameters

~~Except as specified in the descriptions of specific fields in supported mode pages, the SATL shall not implement changeable parameters mode pages.~~ If the SATL receives a MODE SENSE command with 01b in the PC field, the SATL shall terminate the command with CHECK CONDITION status. The sense key shall be set to ILLEGAL REQUEST, and the additional sense code set to INVALID FIELD IN CDB.

An attempt to change a non-changeable mode parameter using the MODE SELECT command shall result in an error condition, and the command shall be terminated with CHECK CONDITION status. The sense key shall be set to ILLEGAL REQUEST, and the additional sense code shall be set to INVALID FIELD IN CDB.

10.1.3 Commonly used SCSI mode pages overview

Mode parameters for which this standard defines translations are listed in table 64.

Table 64 — Summary of SCSI / ATA mode page mapping

SCSI mode page	Reference
Control	10.1.4
Read-Write Error Recovery	10.1.5
Caching	10.1.6
Informational Exceptions Control	10.1.7
All others	See SPC-3 and SBC-2 Unspecified (see 3.4.3)

10.1.4 Control mode page

10.1.4.1 General Translation

The control mode page provides controls and information about behavior of the emulated SCSI device.

Sequence number: 5
Author: HPQ[WBellamy]
Subject: Highlight
Date: 2/17/2006 1:09:30 PM

T

Status
rlsheffi Completed 6/23/2006 8:22:11 AM

Sequence number: 6
Author: HPQ[WBellamy]
Subject: Highlight
Date: 2/17/2006 1:09:10 PM

T

Status
rlsheffi Cancelled 5/6/2006 9:57:06 AM

Sequence number: 7
Author: INTC[RSheffield]
Subject: Rectangle
Date: 5/6/2006 10:04:27 AM

 10.1 Mode parameters
10.1.1 General information
second paragraph, and
10.1.2 Changable parameters

Delete these three paragraphs.

Add:

"The Mode Page Policy VPD page (see 10.3) should be implemented. If implemented, the MODE PAGE POLICY field in each mode page policy descriptor should be set to 00b (shared) for each mode page, and only one copy of mode page values should be maintained for all logical units within a target device (.i.e., the MLUS bit is set to one in each mode page policy descriptor).

If the Mode Page Policy VPD page is not implemented, the SATL shall maintain shared mode pages for all I_T nexuses and shall share mode pages across all logical units within a target device."

Status
rlsheffi Completed 6/23/2006 8:27:53 AM

Sequence number: 8
Author: DELL[KMarks]
Subject: Highlight
Date: 5/6/2006 10:06:35 AM

T

10.1.1 General information
2nd Paragraph
change

"In SCSI, four types of mode page values are defined: current values, saved values, default values, and changeable values. The save parameters operation shall not be supported. Default values are manufacturing time initial values and are not changeable. All pages are shared between all logical units in the target. Mode Page Policy VPD is not implemented, therefore sharing of Mode pages across logical units is implied."

to

"In SCSI, four types of mode page values are defined: current values, saved values, default values, and changeable values. The save parameters operation may be supported. Default values are manufacturing time initial values and are not changeable. All pages are shared between all logical units in the target device. If the Mode Page Policy VPD page is not implemented, sharing of mode pages across logical units is implied."

1. I see no reason that saveable pages can not be implemented by the SATL, and can think of reason why they might be useful. Additionally, the SP bit in the MODE SELECT command on each mode page is Unspecified, which to me conflicts with the statement that saving shall not be supported.

2. Saying "Mode Page Policy VPD is not implemented" goes against the MODE SENSE section that says should be implemented.

RESOLUTION: Delete paragraph (see INTC comment)

Comments from page 86 continued on next page

10 Parameters for SAT implementations

10.1 Mode parameters

10.1.1 General information

SCSI mode parameters provide a mechanism to be used to set operating parameters for SCSI devices. MODE SENSE command is used to obtain operating parameters while MODE SELECT command is used to set operating parameters. In the context SCSI to SATA command translation most operating parameters defined by the contents of MODE PAGES are not supported due to lack of equivalent operations or features in ATA devices. The translator emulates a SCSI device server for all MODE SENSE and MODE SELECT commands and emulates the MODE PAGES listed in 10.1.3.

In SCSI, four types of mode page values are defined: current values, saved values, default values, and changeable values. The save parameters operation shall not be supported. Default values are manufacturing time initial values and are not changeable. Mode pages are shared between all logical units in the target. Mode Page Policy is not implemented, therefore sharing of mode pages across logical units is implied.

10.1.2 Changeable parameters

Except as specified in the descriptions of specific fields in supported mode pages, the SATL shall not implement changeable parameters mode pages. If the SATL receives a MODE SENSE command with 01b in the PC field, the SATL shall terminate the command with CHECK CONDITION status. The sense key shall be set to ILLEGAL REQUEST, and the additional sense code set to INVALID FIELD IN CDB.

An attempt to change a non-changeable mode parameter using the MODE SELECT command shall result in an error condition, and the command shall be terminated with CHECK CONDITION status. The sense key shall be set to ILLEGAL REQUEST, and the additional sense code shall be set to INVALID FIELD IN CDB.

10.1.3 Commonly used SCSI mode pages overview

Mode parameters for which this standard defines translations are listed in table 64.

Table 64 — Summary of SCSI / ATA mode page mapping

SCSI mode page	Reference
Control	10.1.4
Read-Write Error Recovery	10.1.5
Caching	10.1.6
Informational Exceptions Control	10.1.7
All others	See SPC-3 and SBC-2 Unspecified (see 3.4.3)

10.1.4 Control mode page

10.1.4.1 General Translation

The control mode page provides controls and information about behavior of the emulated SCSI device.

Status
risheffi Completed 6/23/2006 8:28:01 AM

Sequence number: 9
Author: SIERLGC[BMartin]
Subject: Highlight
Date: 5/6/2006 10:06:50 AM

T Page 66, 10.1.1, paragraph 2

The save parameters operation should be optional. NOTE - in the PATA Control Mode page it is allowed to save the parameters.

RESOLUTION: Delete paragraph (see INTC comment)

Status
risheffi Completed 6/23/2006 8:28:10 AM

Sequence number: 10
Author: HPQ[RElliott]
Subject: Highlight
Date: 5/6/2006 10:06:57 AM

T 10.1.1

"All pages are shared between all logical units in the target" should not be mandated or even discussed by SAT. SAT should just define the behavior of one logical unit.

RESOLUTION: Delete paragraph (see INTC comment)

Status
risheffi Completed 6/23/2006 8:28:17 AM

Sequence number: 11
Author: HPQ[RElliott]
Subject: Highlight
Date: 5/6/2006 10:07:11 AM

T 10.1.1

Mode s/b mode

RESOLUTION: Delete paragraph (see INTC comment)

Status
risheffi Completed 6/23/2006 8:28:24 AM

Sequence number: 12
Author: HPQ[RElliott]
Subject: Highlight
Date: 5/6/2006 10:07:34 AM

T 10.1.1

Mode Page Policy VPD page

If SAT is going to comment on this page, it should require it, not prohibit it

RESOLUTION: Delete paragraph (see INTC comment)

Status
risheffi Completed 6/23/2006 8:28:34 AM

Sequence number: 13
Author: HPQ[RElliott]
Subject: Highlight
Date: 5/6/2006 10:07:57 AM

T 10.1.1

VPD s/b VPD page

RESOLUTION: Delete paragraph (see INTC comment)

Status
risheffi Completed 6/23/2006 8:28:41 AM

Sequence number: 14
Author: LSI[OParry]

Comments from page 86 continued on next page

10 Parameters for SAT implementations

10.1 Mode parameters

10.1.1 General information

SCSI mode parameters provide a mechanism to be used to set operating parameters for SCSI devices. MODE SENSE command is used to obtain operating parameters while MODE SELECT command is used to set operating parameters. In the context SCSI to SATA command translation most operating parameters defined by the contents of MODE PAGES are not supported due to lack of equivalent operations or features in ATA devices. The translator emulates a SCSI device server for all MODE SENSE and MODE SELECT commands and emulates the MODE PAGES listed in 10.1.3.

In SCSI, four types of mode page values are defined: current values, saved values, default values, and changeable values. The save parameters operation shall not be supported. Default values are manufacturing time initial values and are not changeable. All pages are shared between all logical units in the target. Mode Page Policy VPD is not implemented, therefore sharing of Mode pages across logical units is implied.

10.1.2 Changeable parameters

¹⁵ Except as specified in the descriptions of specific fields in supported mode pages, the SATL shall not implement changeable parameters mode pages. If the SATL receives a MODE SENSE command with 01b in the PC field, the SATL shall terminate the command with CHECK CONDITION status. The sense key shall be set to ILLEGAL REQUEST, and the additional sense code set to INVALID FIELD IN CDB.

¹⁶ attempt to change a non-changeable mode parameter using the MODE SELECT command shall result in an error condition, and the command shall be terminated with CHECK CONDITION status. The sense key shall be set to ILLEGAL REQUEST, and the additional sense code shall be set to INVALID FIELD IN CDB.

10.1.3 Commonly used SCSI mode pages overview

¹⁷ Mode parameters for which this standard defines translations are listed in table 64.

Table 64 — Summary of SCSI / ATA mode page mapping

SCSI mode page	Reference
Control	10.1.4
Read-Write Error Recovery	10.1.5
Caching	10.1.6
Informational Exceptions Control	10.1.7
All others	See SPC-3 and SBC-2 Unspecified (see 3.4.3)

10.1.4 Control mode page

10.1.4.1 General Translation

The control mode page provides controls and information about behavior of the emulated SCSI device.

Subject: Cross-Out
Date: 5/6/2006 10:08:13 AM
10.1.2 Changeable parameters

Support of changeable parameters should be left to the discretion of the SATL vendor.

RESOLUTION: Delete paragraph (see INTC comment)

Status
rsheffi Completed 6/23/2006 8:28:56 AM

Sequence number: 15
Author: DELL[KMarks]
Subject: Highlight
Date: 5/6/2006 10:08:34 AM

10.1.2 Changeable parameters

1st Paragraph change

"Except as specified in the descriptions of specific fields in supported mode pages, the SATL shall not implement changeable parameters mode pages. If the SATL receives a MODE SENSE command with 01b in the PC field, the SATL shall terminate the command with CHECK CONDITION status. The sense key shall be set to ILLEGAL REQUEST, and the additional sense code set to INVALID FIELD IN CDB."

to

"Except as specified in the descriptions of specific fields in supported mode pages, the SATL should not implement changeable parameter mode pages."

Based on current text:

1. Don't understand the "shall" not implement changeable parameters, except as specified. A SATL implementing changeable fields on a mode pages that are not defined in the document should be changeable since they are unspecified by default. This paragraph does not allow this.
2. If returning the changeable values generates an error, how would an application client know that WCE, DEXCPT, and DRA are changeable?

RESOLUTION: Delete paragraph (see INTC comment)

Status
rsheffi Completed 6/23/2006 8:29:05 AM

Sequence number: 16
Author: DELL[KMarks]
Subject: Highlight
Date: 5/6/2006 10:08:52 AM

10.1.2 Changeable parameters

change

"An attempt to change a non-changeable mode parameter using the MODE SELECT command shall result in an error condition, and the command shall be terminated with CHECK CONDITION status. The sense key shall be set to ILLEGAL REQUEST, and the additional sense code shall be set to INVALID FIELD IN CDB."

to

"An attempt to change a non-changeable mode parameter using the MODE SELECT command shall result in the command being terminated with CHECK CONDITION status with the sense key set to ILLEGAL REQUEST and additional sense code set to INVALID FIELD IN CDB."

RESOLUTION: Delete paragraph (see INTC comment)

Status
rsheffi Completed 6/23/2006 8:29:22 AM

Sequence number: 17
Author: DELL[KMarks]
Subject: Highlight
Date: 5/6/2006 10:10:47 AM

Comments from page 86 continued on next page

10 Parameters for SAT implementations

10.1 Mode parameters

10.1.1 General information

SCSI mode parameters provide a mechanism to be used to set operating parameters for SCSI devices. MODE SENSE command is used to obtain operating parameters while MODE SELECT command is used to set operating parameters. In the context SCSI to SATA command translation most operating parameters defined by the contents of MODE PAGES are not supported due to lack of equivalent operations or features in ATA devices. The translator emulates a SCSI device server for all MODE SENSE and MODE SELECT commands and emulates the MODE PAGES listed in 10.1.3.

In SCSI, four types of mode page values are defined: current values, saved values, default values, and changeable values. The save parameters operation shall not be supported. Default values are manufacturing time initial values and are not changeable. All pages are shared between all logical units in the target. Mode Page Policy VPD is not implemented, therefore sharing of Mode pages across logical units is implied.

10.1.2 Changeable parameters

~~Except as specified in the descriptions of specific fields in supported mode pages, the SATL shall not implement changeable parameters mode pages.~~ If the SATL receives a MODE SENSE command with 01b in the PC field, the SATL shall terminate the command with CHECK CONDITION status. The sense key shall be set to ILLEGAL REQUEST, and the additional sense code set to INVALID FIELD IN CDB.

An attempt to change a non-changeable mode parameter using the MODE SELECT command shall result in an error condition, and the command shall be terminated with CHECK CONDITION status. The sense key shall be set to ILLEGAL REQUEST, and the additional sense code shall be set to INVALID FIELD IN CDB.

10.1.3 Commonly used SCSI mode pages overview

Mode parameters for which this standard defines translations are listed in table 64.

Table 64 — Summary of SCSI / ATA mode page mapping

SCSI mode page	Reference
19 Control ¹⁸	10.1.4
20 Read-Write Error Recovery	10.1.5
21 Archiving	10.1.6
22 Informational Exceptions Control	10.1.7
All others	See SPC-3 and SBC-2 Unspecified (see 3.4.3)

10.1.4 Control mode page

²³ 10.1.4.1 General Translation

The control mode page provides controls and information about behavior of the emulated SCSI device.

T 10.1.3 Commonly used SCSI mode pages overview

1st Sentence

"Mode parameters for which this standard defines translations are listed in table 64."

to

"Mode pages for which this standard defines translations are listed in table 64."

RESOLUTION: s/b

"This standard defines translations for the mode pages listed in table 64."

Status
rlsheffi Completed 6/23/2006 8:33:05 AM

Sequence number: 18
Author: HPQ[WBellamy]
Subject: Note
Date: 5/6/2006 10:18:32 AM

 Why do the tables for log pages and vpd pages have hex identifiers (i. e., 0Ah, etc.) for their pages and this table doesn't. Which documentation process is correct?

RESOLUTION: add mode page encoding as follows:

" Control (i.e., 0Ah)
Read-Write Error Recovery (i.e., 01h)
Caching (i.e., 08h)
Informational Exceptions Control (i.e., 1Ch)"

Status
rlsheffi Completed 6/23/2006 8:36:08 AM

Sequence number: 19
Author: HPQ[WBellamy]
Subject: Highlight
Date: 2/17/2006 12:55:05 PM

T

Status
rlsheffi Cancelled 5/6/2006 10:12:45 AM

Sequence number: 20
Author: HPQ[WBellamy]
Subject: Highlight
Date: 2/17/2006 12:55:09 PM

T

Status
rlsheffi Cancelled 5/6/2006 10:12:45 AM

Sequence number: 21
Author: HPQ[WBellamy]
Subject: Highlight
Date: 2/17/2006 12:55:10 PM

T

Status
rlsheffi Cancelled 5/6/2006 10:12:44 AM

Sequence number: 22
Author: HPQ[WBellamy]
Subject: Highlight
Date: 2/17/2006 12:55:33 PM

T

Status
rlsheffi Cancelled 5/6/2006 10:12:45 AM

Sequence number: 23
Author: IBM[GPenokie]
Subject: Underline
Date: 2/16/2006 1:45:16 PM

T 10.1.4.1 General Translation

Status

Comments from page 86 continued on next page

10 Parameters for SAT implementations

10.1 Mode parameters

10.1.1 General information

SCSI mode parameters provide a mechanism to be used to set operating parameters for SCSI devices. MODE SENSE command is used to obtain operating parameters while MODE SELECT command is used to set operating parameters. In the context SCSI to SATA command translation most operating parameters defined by the contents of MODE PAGES are not supported due to lack of equivalent operations or features in ATA devices. The translator emulates a SCSI device server for all MODE SENSE and MODE SELECT commands and emulates the MODE PAGES listed in 10.1.3.

In SCSI, four types of mode page values are defined: current values, saved values, default values, and changeable values. The save parameters operation shall not be supported. Default values are manufacturing time initial values and are not changeable. All pages are shared between all logical units in the target. Mode Page Policy VPD is not implemented, therefore sharing of Mode pages across logical units is implied.

10.1.2 Changeable parameters

~~Except as specified in the descriptions of specific fields in supported mode pages, the SATL shall not implement changeable parameters mode pages.~~ If the SATL receives a MODE SENSE command with 01b in the PC field, the SATL shall terminate the command with CHECK CONDITION status. The sense key shall be set to ILLEGAL REQUEST, and the additional sense code set to INVALID FIELD IN CDB.

An attempt to change a non-changeable mode parameter using the MODE SELECT command shall result in an error condition, and the command shall be terminated with CHECK CONDITION status. The sense key shall be set to ILLEGAL REQUEST, and the additional sense code shall be set to INVALID FIELD IN CDB.

10.1.3 Commonly used SCSI mode pages overview

Mode parameters for which this standard defines translations are listed in table 64.

Table 64 — Summary of SCSI / ATA mode page mapping

SCSI mode page	Reference
Control	10.1.4
Read-Write Error Recovery	10.1.5
Caching	10.1.6
Informational Exceptions Control	10.1.7
All others	See SPC-3 and SBC-2 Unspecified (see 3.4.3)

10.1.4 Control mode page

²⁴ 10.1.4.1 General Translation

The ²⁵ control mode page provides controls and information about behavior of the emulated SCSI device.

risheffi Cancelled 5/6/2006 10:20:04 AM

Sequence number: 24

Author: MXO[MEvans]

Subject: Highlight

Date: 2/16/2006 12:02:50 PM

T 10.1.4.1 [Control mode page] General Translation: change to "General translation".

Status

risheffi Completed 6/23/2006 8:37:08 AM

Sequence number: 25

Author: MXO[MEvans]

Subject: Highlight

Date: 2/16/2006 12:02:34 PM

T 10.1.4.1 [Control mode page] General translation, first paragraph: change "control mode page..." to "...Control mode page...".

Status

risheffi Completed 6/23/2006 8:37:38 AM

Table 65 describes the translation of **Control mode page** for an **attached** ATA device.

Table 65 — Control mode page fields

Field	Changeable	Description or reference
PS	n/a	Unspecified (see 3.4.3)
PAGE CODE	no	Set to 01h. This field value is specific to the Read-Write Error Recovery mode page.
PAGE LENGTH	no	See SBC-2.
TST	no	Shall be set to 000b to indicate that a SCSI representation of an ATA device has one task set for all initiators
TMF_ONLY	no	Shall be set to 0b ^a
D_SENSE	no ^b	A SATL shall support 0b for this field indicating that the emulated SCSI device uses the fixed sense data format. A SATL may support 1b for this field to support the descriptor format sense data. SATL implementations that support 1b shall also support this field as being changeable.
GLTSD	no	Shall be set to 1b. Log page translations are implemented as emulated pages based on ATA data that may not be saved by the attached ATA device.
RLEC	no	Shall be set to 0b
QUEUE ALGORITHM MODIFIER	no	Shall be set to 1b if the ATA device supports any form of command queuing, otherwise shall be set to 0b
QERR	no	If the SATL resubmits queued commands that did not fail to the drive on behalf of any I_T Nexus, this field shall be set to 00b. Otherwise, the SATL shall set this field to 01b and comply with the unit attention requirements for a task completed with CHECK CONDITION status (see SPC-3)
TAS	no	Shall be set to 0b
RAC	Unspecified	Unspecified (see 3.4.3)
UA_INTLCK_CTRL	no	Shall be set to 00b
SWP	no	Shall be set to 0b
ATO	Unspecified	Unspecified (see 3.4.3)
AUTOLOAD MODE	no	Shall be set to 000b
BUSY TIMEOUT PERIOD	no ^b	The default value shall be set to FFFFh. A SATL may support variable timeout periods and allow the application client to set a new value through a MODE SELECT operation for this mode page (see SPC-3)
EXTENDED SELF-TEST COMPLETION TIME	no	10.1.4.2
^a SATL implementations shall not support ACA, therefore this field shall be 0b. ^b If the SATL supports the optional behavior for this field, the SATL may support this field as changeable.		

10.1.4.2 Extended self-test completion time

A SATL implementation shall set this field to 0000h unless the attached ATA device supports SMART self-tests and the SATL supports a non-000b value for the SELF-TEST CODE field for a SEND DIAGNOSTIC command. The SATL determines if the attached ATA device supports SMART self-test by examining the

Page: 87

Sequence number: 1
Author: DELL[KMarks]
Subject: Cross-Out
Date: 2/8/2006 9:14:29 PM

T attached

Status
risheffi Completed 6/23/2006 8:38:27 AM

Sequence number: 2
Author: HPQ[RElliott]
Date: 2/3/2006 7:52:01 AM

T 10.1.4.1
"a control" s/b "the Control"

Status
risheffi Completed 6/23/2006 8:38:49 AM

Sequence number: 3
Author: MXO[MEvans]
Subject: Highlight
Date: 2/16/2006 12:03:02 PM

T 10.1.4.1 [Control mode page] General translation, first paragraph: change "control mode page..." to "...Control mode page..."

Status
risheffi Completed 6/23/2006 8:39:02 AM

Sequence number: 4
Author: DELL[KMarks]
Subject: Highlight
Date: 2/8/2006 9:14:19 PM

T "a"
to
"the"

Status
risheffi Completed 6/23/2006 8:39:16 AM

Sequence number: 5
Author: DELL[KMarks]
Subject: Highlight
Date: 2/16/2006 8:42:30 PM

T Table 65 — Control mode page fields

1. Through out table change 1b and 0b to one and zero.
2. Missing SPF bit (0b) Row

Status
risheffi Completed 6/23/2006 8:44:08 AM

Sequence number: 6
Author: DELL[KMarks]
Subject: Highlight
Date: 5/6/2006 10:23:27 AM

T Table 65 — Control mode page fields
Row: PS

**Based on the current text, this shall be zero for MODE SENSE. I think saveable pages should be an options and therefore think Unspecified is correct.
RESOLUTION: SAT will not prohibit savable pages, so this remains "Unspecified".**

Status
risheffi Completed 6/23/2006 8:48:57 AM

Sequence number: 7
Author: DELL[KMarks]
Subject: Highlight
Date: 5/6/2006 10:24:12 AM

T Table 65 — Control mode page fields
Row: PAGE CODE

Comments from page 87 continued on next page

Table 65 describes the translation of a control mode page for an attached ATA device.

Table 65 — Control mode page fields

Field	Changeable	Description or reference
PS	n/a	Unspecified (see 3.4.3)
PAGE CODE	no	Set to 01h. This field value is specific to the Read-Write Error Recovery mode page.
PAGE LENGTH	no	See SBC-2.
TST	no	Shall be set to 000b to indicate that a SCSI representation of an ATA device has one task set for all initiators
TMF_ONLY	no	10 Shall be set to 0b ^a
D_SENSE	no ^b	11 SATL shall support 0b for this field indicating that the emulated SCSI device uses the fixed sense data format. A SATL may support 1b for this field to support the descriptor format sense data. SATL implementations that support 1b shall also support this field as being changeable.
GLTSD	no	Shall be set to 1b. Log page translations are implemented as emulated pages based on ATA data that may not be saved by the attached ATA device.
RLEC	no	Shall be set to 0b
QUEUE ALGORITHM MODIFIER	no	Shall be set to 1b if the ATA device supports any form of command queuing, otherwise shall be set to 0b
QERR	no	If the SATL resubmits queued commands that did not fail to the drive on behalf of any I_T Nexus, this field shall be set to 00b. Otherwise, the SATL shall set this field to 01b and comply with the unit attention requirements for a task completed with CHECK CONDITION status (see SPC-3)
TAS	no	Shall be set to 0b
RAC	Unspecified	Unspecified (see 3.4.3)
UA_INTLCK_CTRL	no	Shall be set to 00b
SWP	no	Shall be set to 0b
ATO	Unspecified	Unspecified (see 3.4.3)
AUTOLOAD MODE	no	Shall be set to 000b
BUSY TIMEOUT PERIOD	no ^b	The default value shall be set to FFFFh. A SATL may support variable timeout periods and allow the application client to set a new value through a MODE SELECT operation for this mode page (see SPC-3)
EXTENDED SELF-TEST COMPLETION TIME	no	10.1.4.2
<p>^a SATL implementations shall not support ACA, therefore this field shall be 0b.</p> <p>^b If the SATL supports the optional behavior for this field, the SATL may support this field as changeable.</p>		

10.1.4.2 Extended self-test completion time

A SATL implementation shall set this field to 0000h unless the attached ATA device supports SMART self-tests and the SATL supports a non-000b value for the SELF-TEST CODE field for a SEND DIAGNOSTIC command. The SATL determines if the attached ATA device supports SMART self-test by examining the

change
"Set to 01h. This field value is specific to the Read-Write Error
Recovery mode page."

to

"Shall be set to 0Ah."
RESOLUTION: see SIERLGC comment

Status
risheffi Completed 6/23/2006 8:49:54 AM

Sequence number: 8
Author: SIERLGC[BMartin]
Subject: Highlight
Date: 3/7/2006 2:50:58 PM

T Page 67, Table 65
Page Code is a cut and paste error should be 0Ah, and the text needs to
change.
RESOLUTION: change the description to:
This field shall be set to 0Ah.

Status
risheffi Completed 6/23/2006 8:49:45 AM

Sequence number: 9
Author: DELL[KMarks]
Subject: Highlight
Date: 2/9/2006 8:24:43 PM

T Table 65 — Control mode page fields
Row: PAGE LENGTH
change
"See SBC-2."
to
"Shall be set to 0Ah."

**See no reason why the length should just not be stated, instead of referring to another spec. In any case it should refer to
SPC-3 and not SBC-2 if recommended change not accepted.**

Status
risheffi Completed 6/23/2006 8:57:16 AM

Sequence number: 10
Author: IBM[GPenokie]
Subject: Comment on Text
Date: 2/16/2006 10:36:06 AM

T table 65 - row tmf_only
This << Shall be set to 0b >> should be << Shall be set to zero >>.
Bits are always zero and one not 0b and 1b. This statement applies to all the comments in this table. If these changes are not
accepted then all the other tables need to be changed.

Status
risheffi Completed 6/23/2006 8:57:50 AM

Sequence number: 11
Author: IBM[GPenokie]
Subject: Comment on Text
Date: 7/12/2006 11:42:14 PM

T table 65 - d_sense row
This << A SATL shall support 0b for this field indicating that the emulated SCSI device uses the fixed sense data format. A SATL
may support 1b for this field to support the descriptor format sense data. SATL implementations that support 1b shall also support
this field as being changeable. >> should be << A SATL shall support zero for this bit indicating that the emulated SCSI device uses
the fixed sense data format. A SATL may support one for this bit to support the descriptor format sense data. SATL
implementations that support one shall also support this bit as being changeable. >>
RESOLUTION: see EDITOR's comment

Status
risheffi Completed 6/23/2006 8:59:40 AM

Comments from page 87 continued on next page

Table 65 describes the translation of a control mode page for an attached ATA device.

Table 65 — Control mode page fields

Field	Changeable	Description or reference
PS	n/a	Unspecified (see 3.4.3)
PAGE CODE	no	Set to 01h. This field value is specific to the Read-Write Error Recovery mode page.
PAGE LENGTH	no	See SBC-2.
TST	no	Shall be set to 000b to indicate that a SCSI representation of an ATA device has one task set for all initiators
TMF_ONLY	no	Shall be set to 0b ^a
D_SENSE	no ^b	A SATL shall support 0b for this field indicating that the emulated device uses the fixed sense data format. A SATL may support 1b for this field to support the descriptor format sense data. SATL implementations that support 1b shall also support this field as being changeable.
GLTSD	no	Shall be set to 1b. Log page translations are implemented as emulated pages based on ATA data that may not be saved by the attached ATA device.
RLEC	no	Shall be set to 0b
QUEUE ALGORITHM MODIFIER	no	Shall be set to 1b if the ATA device supports any form of command queuing, otherwise shall be set to 0b
QERR	no	If the SATL resubmits queued commands that did not fail to the drive on behalf of any I_T Nexus, this field shall be set to 00b. Otherwise, the SATL shall set this field to 01b and comply with the unit attention requirements for a task completed with CHECK CONDITION status (see SPC-3)
TAS	no	Shall be set to 0b
RAC	Unspecified	Unspecified (see 3.4.3)
UA_INTLCK_CTRL	no	Shall be set to 00b
SWP	no	Shall be set to 0b
ATO	Unspecified	Unspecified (see 3.4.3)
AUTOLOAD MODE	no	Shall be set to 000b
BUSY TIMEOUT PERIOD	no ^b	The default value shall be set to FFFFh. A SATL may support variable timeout periods and allow the application client to set a new value through a MODE SELECT operation for this mode page (see SPC-3)
EXTENDED SELF-TEST COMPLETION TIME	no	10.1.4.2
<p>^a SATL implementations shall not support ACA, therefore this field shall be 0b.</p> <p>^b If the SATL supports the optional behavior for this field, the SATL may support this field as changeable.</p>		

10.1.4.2 Extended self-test completion time

A SATL implementation shall set this field to 0000h unless the attached ATA device supports SMART self-tests and the SATL supports a non-000b value for the SELF-TEST CODE field for a SEND DIAGNOSTIC command. The SATL determines if the attached ATA device supports SMART self-test by examining the

Sequence number: 12
Author: EDITOR[rlsheffi]
Subject: Rectangle
Date: 7/13/2006 12:29:17 AM

 Table 65 — Control mode page fields
Row: D_SENSE

Replace the text in the Description or reference column with:

"A SATL shall support a d_sense bit set to zero indicating that the logical unit returns the fixed sense data format, and a SATL may support a d_sense bit set to one indicating logical unit returns the descriptor sense data format."

The SATL shall return sense data in the format indicated when returning CHECK CONDITION status for any commands except the ATA PASS-THROUGH (12) command and the ATA PASS-THROUGH (16) command. The SATL shall return sense data for a CHECK CONDITION status returned by an ATA PASS-THROUGH (12) command or an ATA PASS-THROUGH (16) command in the descriptor format."

Delete table footnote b and make the Changeable column "Unspecified".

Status
rlsheffi Completed 7/12/2006 11:39:50 PM

Sequence number: 13
Author: DELL[KMarks]
Subject: Note
Date: 7/12/2006 11:40:41 PM

 Table 65 — Control mode page fields
Row: D_SENSE

add additional footnote to the effect

"D_SENSE set one shall be supported if the SATL supports the ATA PASSTHROUGH (12) and (16) commands"

Proposed resolution: add a table footnote as follows -

"(x) The SATL shall support a D_SENSE bit set to one if the SATL supports the ATA PASSTHROUGH (12) command or the ATA PASSTHROUGH (16) command."

RESOLUTION: see EDITOR's comment

Status
rlsheffi Completed 6/23/2006 9:04:37 AM

Sequence number: 14
Author: IBM[GPenokie]
Subject: Comment on Text
Date: 5/6/2006 10:49:10 AM

 table 65 - row gltsd
This << Shall be set to 1b. >> should be << Shall be set to one.>>
RESOLUTION: see DELL comment (but agree "one" instead of "1b")

Status
rlsheffi Completed 6/23/2006 9:06:27 AM

Sequence number: 15
Author: DELL[KMarks]
Subject: Note
Date: 5/9/2006 4:37:53 PM

 Table 65 — Control mode page fields
Row: GLTSD

Although the ATA device does not save the actual log parameters, Not sure that Set to 1b would be correct. Seems to me that the 2 defined log pages are both persistent across POR, etc, so it seems they do an implicitly save, when looking at it from a point of view of the SATL plus ATA drive being the SCSI target device.

Discussed: Supported Log Pages is clearly saved implicitly, but the Self-Test Results log page and the Informational Exceptions log page may contain information that does not persist across a power-on reset. Subsequent versions of SAT may define more log pages that have information which doesn't persist across POR, and nothing prevents a SATL from implementing defined log pages that have information that may not persist across power cycles. The definition of the GLTSD bit here applied to all log pages implemented by a SATL, whether SAT provides a specific translation for those log pages or not.

Comments from page 87 continued on next page

Table 65 describes the translation of a control mode page for an attached ATA device.

Table 65 — Control mode page fields

Field	Changeable	Description or reference
PS	n/a	Unspecified (see 3.4.3)
PAGE CODE	no	Set to 01h. This field value is specific to the Read-Write Error Recovery mode page.
PAGE LENGTH	no	See SBC-2.
TST	no	Shall be set to 000b to indicate that a SCSI representation of an ATA device has one task set for all initiators
TMF_ONLY	no	Shall be set to 0b ^a
D_SENSE	no ^b	A SATL shall support 0b for this field indicating that the emulated SCSI device uses the fixed sense data format. A SATL may support 1b for this field to support the descriptor format sense data. SATL implementations that support 1b shall also support this field as being changeable.
GLTSD	no	Shall be set to 1b. Log page translations are implemented as emulated pages based on ATA data that may not be saved by the attached ATA device.
RLEC	no	16 All be set to 0b
QUEUE ALGORITHM MODIFIER	no	17 All be 18 1b if the ATA device supports any form of command queuing, otherwise shall be set to 0b
QERR	no	19 The SATL resubmits queued commands that did not fail to the drive on behalf of any I_T Nexus, this field shall be set to 00b. Otherwise, the SATL shall set this field to 01b and comply with the unit attention requirements for a task completed with CHECK CONDITION status (see SPC-3)
TAS	no	Shall be set to 0b
RAC	Unspecified	Unspecified (see 3.4.3)
UA_INTLCK_CTRL	no	Shall be set to 00b
SWP	no	Shall be set to 0b
ATO	Unspecified	Unspecified (see 3.4.3)
AUTOLOAD MODE	no	Shall be set to 000b
BUSY TIMEOUT PERIOD	no ^b	The default value shall be set to FFFFh. A SATL may support variable timeout periods and allow the application client to set a new value through a MODE SELECT operation for this mode page (see SPC-3)
EXTENDED SELF-TEST COMPLETION TIME	no	10.1.4.2
<p>^a SATL implementations shall not support ACA, therefore this field shall be 0b.</p> <p>^b If the SATL supports the optional behavior for this field, the SATL may support this field as changeable.</p>		

10.1.4.2 Extended self-test completion time

A SATL implementation shall set this field to 0000h unless the attached ATA device supports SMART self-tests and the SATL supports a non-000b value for the SELF-TEST CODE field for a SEND DIAGNOSTIC command. The SATL determines if the attached ATA device supports SMART self-test by examining the

Also, this is a mode page, so the statement "shall be set to" needs to be qualified as to whether it applies to a device server or an application client. SAT shouldn't prohibit an application client from setting the bit one way or the other, but should define the SATL response if the application client sets the bit to a value that is not supported.

Now - if SAT is opening the door to allow mode pages to be saveable, should SAT not also permit implicit saving of log pages? If so, this field should be "Unspecified (see 3.4.3)".

RESOLUTION: Replace the text in the table cell with "Unspecified (see 3.4.3)", and make it "Unspecified" whether the bit is changeable.

Status
risheffi Completed 6/23/2006 9:06:34 AM

Sequence number: 16
Author: IBM[GPenokie]
Subject: Comment on Text
Date: 2/16/2006 10:31:14 AM

T table 65 - rlec
This << Shall be set to 0b >> should be << Shall be set to zero >>

Status
risheffi Completed 6/23/2006 9:06:57 AM

Sequence number: 17
Author: IBM[GPenokie]
Subject: Comment on Text
Date: 5/6/2006 11:10:06 AM

T table 65 - queue algorithm modifier
This << Shall be set to 1b if the ATA device supports any form of command queuing, otherwise shall be set to 0b >> should be << Shall be set to one if the ATA device supports any form of command queuing, otherwise shall be set to zero >>
RESOLUTION: See DELL comment

Status
risheffi Completed 6/23/2006 9:10:45 AM

Sequence number: 18
Author: DELL[KMarks]
Subject: Note
Date: 5/9/2006 4:50:10 PM

T Table 65 — Control mode page fields
Row: QUEUE ALGORITHM

This needs some work, in that if the basic task management model is implemented, then the QAR bit shall be set to 1b, regardless if the ATA device supports queuing.

Additional on a different front, if the SATL queues commands internally, but the ATA device does not support queuing, then why can't the SATL be capable of reordering.

RESOLUTION: suggested resolution - s/b
"The QUEUE ALGORITHM MODIFIER bit shall be set to one."

Status
risheffi Completed 6/23/2006 9:10:40 AM

Sequence number: 19
Author: DELL[KMarks]
Subject: Highlight
Date: 6/2/2006 2:25:18 PM

T Table 65 — Control mode page fields
Row: QERR
change

"If the SATL resubmits queued commands that did not fail to the drive on behalf of any I_T Nexus, this field shall be set to 00b. Otherwise, the SATL shall set this field to 01b and comply with the unit attention requirements for a task completed with CHECK CONDITION status (see SPC-3)"

to

Comments from page 87 continued on next page

Table 65 describes the translation of a control mode page for an attached ATA device.

Table 65 — Control mode page fields

Field	Changeable	Description or reference
PS	n/a	Unspecified (see 3.4.3)
PAGE CODE	no	Set to 01h. This field value is specific to the Read-Write Error Recovery mode page.
PAGE LENGTH	no	See SBC-2.
TST	no	Shall be set to 000b to indicate that a SCSI representation of an ATA device has one task set for all initiators
TMF_ONLY	no	Shall be set to 0b ^a
D_SENSE	no ^b	A SATL shall support 0b for this field indicating that the emulated SCSI device uses the fixed sense data format. A SATL may support 1b for this field to support the descriptor format sense data. SATL implementations that support 1b shall also support this field as being changeable.
GLTSD	no	Shall be set to 1b. Log page translations are implemented as emulated pages based on ATA data that may not be saved by the attached ATA device.
RLEC	no	Shall be set to 0b
QUEUE ALGORITHM MODIFIER	no	Shall be set to 1b if the ATA device supports any form of command queuing, otherwise shall be set to 0b
QERR	no	If the SATL resubmits queued commands that did not fail the drive on behalf of any I_T Nexus, this field shall be set to 00b. Otherwise, the SATL shall set this field to 01b and comply with the unit attention requirements for a task completed with CHECK CONDITION status (see SPC-3)
TAS	no	all be set to 0b
RAC	Unspecified	Unspecified (see 3.4.3)
UA_INTLCK_CTRL	no	Shall be set to 00b
SWP	no	all be set to 0b
ATO	Unspecified	Unspecified (see 3.4.3)
AUTOLOAD MODE	no	Shall be set to 000b
BUSY TIMEOUT PERIOD	no ^b	The default value shall be set to FFFFh. A SATL may support variable timeout periods and allow the application client to set a new value through a MODE SELECT operation for this mode page (see SPC-3)
EXTENDED SELF-TEST COMPLETION TIME	no	10.1.4.2
		²⁴ SATL implementations shall not support ACA, therefore this field shall be 0b.
		²⁵ If the SATL supports the optional behavior for this field, the SATL may support this field as changeable.

10.1.4.2 Extended self-test completion time

A SATL implementation shall set this field to 0000h unless the attached ATA device supports SMART self-tests and the SATL supports a non-000b value for the SELF-TEST CODE field for a SEND DIAGNOSTIC command. The SATL determines if the attached ATA device supports SMART self-test by examining the

"If the SATL supports the full task management model and ATA abort retry (see 3.1.x) of ATA queued commands (see 3.1.x) aborted by ATA collateral abort (see 3.1.x), the SATL shall set this field to 00b. Otherwise, the SATL shall set this field to 01b and comply with the unit attention requirements for a task completed with CHECK CONDITION status (see SPC-3)"

Status
rlsheffi Completed 6/23/2006 9:14:02 AM

Sequence number: 20
Author: MXO[MEvans]
Subject: Highlight
Date: 5/6/2006 11:16:17 AM

T Table 65, QERR row, description: change "...to the drive..." to "...to the ATA device...".
RESOLUTION: see DELL comment

Status
rlsheffi Completed 6/23/2006 9:14:37 AM

Sequence number: 21
Author: IBM[GPenokie]
Subject: Highlight
Date: 2/16/2006 10:33:45 AM

T table 65 - row tas
This << Shall be set to 0b >> should be << Shall be set to zero >>

Status
rlsheffi Completed 6/23/2006 9:14:48 AM

Sequence number: 22
Author: IBM[GPenokie]
Subject: Comment on Text
Date: 2/16/2006 10:36:35 AM

T table 65 - row swp
This << Shall be set to 0b >> should be << Shall be set to zero >>

Status
rlsheffi Completed 6/23/2006 9:15:09 AM

Sequence number: 23
Author: HPQ[RElliott]
Subject: Highlight
Date: 1/19/2006 9:24:00 AM

T 10.1.4.1
table 65

add . after (see SPC-3)

Status
rlsheffi Completed 6/23/2006 9:15:31 AM

Sequence number: 24
Author: DELL[KMarks]
Subject: Highlight
Date: 2/9/2006 8:26:33 PM

T Table 65 — Control mode page fields
Row: PAGE CODE
change

"a SATL implementations shall not support ACA, therefore this field shall be 0b."
to
"a SATL implementations shall not support ACA."

Status
rlsheffi Completed 6/23/2006 9:17:58 AM

Sequence number: 25
Author: DELL[KMarks]
Subject: Highlight
Date: 6/23/2006 9:17:28 AM

T Table 65 — Control mode page fields
Footnote c

Comments from page 87 continued on next page

Table 65 describes the translation of a control mode page for an attached ATA device.

Table 65 — Control mode page fields

Field	Changeable	Description or reference
PS	n/a	Unspecified (see 3.4.3)
PAGE CODE	no	Set to 01h. This field value is specific to the Read-Write Error Recovery mode page.
PAGE LENGTH	no	See SBC-2.
TST	no	Shall be set to 000b to indicate that a SCSI representation of an ATA device has one task set for all initiators
TMF_ONLY	no	Shall be set to 0b ^a
D_SENSE	no ^b	A SATL shall support 0b for this field indicating that the emulated SCSI device uses the fixed sense data format. A SATL may support 1b for this field to support the descriptor format sense data. SATL implementations that support 1b shall also support this field as being changeable.
GLTSD	no	Shall be set to 1b. Log page translations are implemented as emulated pages based on ATA data that may not be saved by the attached ATA device.
RLEC	no	Shall be set to 0b
QUEUE ALGORITHM MODIFIER	no	Shall be set to 1b if the ATA device supports any form of command queuing, otherwise shall be set to 0b
QERR	no	If the SATL resubmits queued commands that did not fail to the drive on behalf of any I_T Nexus, this field shall be set to 00b. Otherwise, the SATL shall set this field to 01b and comply with the unit attention requirements for a task completed with CHECK CONDITION status (see SPC-3)
TAS	no	Shall be set to 0b
RAC	Unspecified	Unspecified (see 3.4.3)
UA_INTLCK_CTRL	no	Shall be set to 00b
SWP	no	Shall be set to 0b
ATO	Unspecified	Unspecified (see 3.4.3)
AUTOLOAD MODE	no	Shall be set to 000b
BUSY TIMEOUT PERIOD	no ^b	The default value shall be set to FFFFh. A SATL may support variable timeout periods and allow the application client to set a new value through a MODE SELECT operation for this mode page (see SPC-3)
EXTENDED SELF-TEST COMPLETION TIME	no	10.1.4.2
^a SATL implementations shall not support ACA, therefore this field shall be 0b. ^b If the SATL supports the optional behavior for this field, the SATL may support this field as changeable.		

10.1.4.2 Extended self-test completion time

²⁶ SATL implementation shall set this field to 0000h unless the attached ATA device supports SMART self-tests and the SATL supports a non-000b value for the SELF-TEST CODE field for a SEND DIAGNOSTIC command. The SATL determines if the attached ATA device supports SMART self-test by examining the

change

"b If the SATL supports the optional behavior for this field, the SATL may support this field as changeable."

to

"b If the SATL supports the optional behavior for this field, the SATL shall support this field as changeable."

Both fields that define optional behaviors, imply a shall.

RESOLUTION: Delete footnote b and change the corresponding entries in the "Changeable" column to "Unspecified".

Status
risheffi Completed 6/23/2006 9:17:31 AM

Sequence number: 26
Author: DELL[KMarks]
Subject: Highlight
Date: 6/23/2006 9:23:06 AM

T 10.1.4.2 Extended self-test completion time

1st Paragraph
change

"A SATL implementation shall set this field to 0000h unless the attached ATA device supports SMART self-tests and the SATL supports a non-000b value for the SELF-TEST CODE field for a SEND DIAGNOSTIC command. The SATL determines if the attached ATA device supports SMART self-test by examining the..."

to

"The SATL shall set the EXTENDED SELF-TEST COMPLETION TIME field to 0000h unless the ATA device supports SMART self-tests and the SATL supports a value other than 000b for the SELF-TEST CODE field for a SEND DIAGNOSTIC command. The SATL determines if the ATA device supports SMART self-test by examining the value of ..."

Status
risheffi Completed 6/23/2006 9:24:10 AM

1 IDENTIFY DEVICE data for word 84, bit 1. If word 84, bit 1 is set to one, the device supports the SMART self-test. Under these conditions, the SATL shall set the EXTENDED SELF-TEST COMPLETION TIME field as follows:

- 1) The SATL shall obtain the device SMART data structure by sending a SMART READ DATA command to the attached device. The SATL may cache this information for future use when a subsequent MODE SENSE command requests the control mode page. If the SATL caches such data, it is not mandatory to send a SMART READ DATA more than one time.
- 2) If byte 373 of the SMART data structure is not FFh, the SATL shall set the extended self-test completion time to 60 times the contents of byte 373.
- 3) If byte 373 of the SMART data structure is FFh, the SATL shall set the extended self-test completion time to the lesser of FFFFh or the result of the following formula:

$$\text{EXTENDED SELF-TEST COMPLETION TIME field} = ((w \times 256) + z) \times 60;$$

where z is the contents of byte 375 and w is the contents of byte 376.

10.1.5 Read-Write Error Recovery mode page

The Read-Write Error Recovery mode page specifies the error recovery parameters the SATL shall use during any command that performs a read or write operation to the ATA device's medium (see SBC-2). Table 66 defines the translation for the Read-Write Error Recovery mode page.

Table 66 — Read-write error recovery mode page fields

Field	Changeable	Description or reference ^a
PS	n/a	Unspecified (see 3.4.3)
PAGE CODE	no	Set to 01h. This field value is specific to the Read-Write Error Recovery mode page.
PAGE LENGTH	no	See SBC-2.
ARRE	no	Shall be set to one (see SBC-2).
AWRE	no	Shall be set to zero (see SBC-2).
TB	n/a	Unspecified (see 3.4.3)
RC	no	Shall be set to zero (see SBC-2).
EER	no	Shall be set to zero (see SBC-2).
PER	no	Shall be set to zero (see SBC-2).
DTE	no	Shall be set to zero (see SBC-2).
DCR	no	Shall be set to zero (see SBC-2).
READ RETRY COUNT	n/a	Unspecified (see 3.4.3)
WRITE RETRY COUNT	n/a	Unspecified (see 3.4.3)
RECOVERY TIME LIMIT	no	Shall be set to 00h (see SBC-2).

^a ~~If the SATL receives a MODE SELECT command with a value other than zero set in this field the SATL shall terminate the command with CHECK CONDITION status with the sense key set to ILLEGAL REQUEST and the additional sense code set to INVALID FIELD IN PARAMETER LIST.~~

Sequence number: 1
Author: DELL[KMarks]
Subject: Highlight
Date: 6/23/2006 9:29:20 AM

T 10.1.4.2 Extended self-test completion time
1st Paragraph, Continuation of 2nd Sentence

Change

"... IDENTIFY DEVICE data word 84, bit 1. If word 84, bit 1 is set to one, the ATA device supports the SMART self-test. Under these conditions, the SATL shall set the EXTENDED SELF-TEST COMPLETION TIME field as follows:

1) The SATL shall obtain the device SMART data structure by sending a SMART READ DATA command to the attached device. The SATL may cache this information for future use when a subsequent MODE SENSE command requests the control mode page. If the SATL caches such data, it is not mandatory to send a SMART READ DATA more than one time.

2) If byte 373 of the SMART data structure is not FFh, the SATL shall set the extended self-test completion time to 60 times the contents of byte 373.

3) If byte 373 of the SMART data structure is FFh, the SATL shall set the extended self-test completion time to the lesser of FFFFh or the result of the following formula:

EXTENDED SELF-TEST COMPLETION TIME field = $((w \times 256) + z) \times 60$;

where z is the contents of byte 375 and w is the contents of byte 376."

to

"... ATA IDENTIFY DEVICE data for word 84, bit 1. If word 84, bit 1 is set to one, the ATA device supports the SMART self-test and shall obtain the ATA device SMART data structure by sending an ATA SMART READ DATA command to the ATA device. Then the SATL shall set the EXTENDED SELF-TEST COMPLETION TIME field as follows:

1) If byte 373 of the returned SMART data structure is not set to FFh, the SATL shall set the EXTENDED SELF-TEST COMPLETION TIME field to a value that is 60 times the contents of byte 373; or

3) If byte 373 of the returned SMART data structure is set to FFh, the SATL shall set the EXTENDED SELF-TEST COMPLETION TIME field to a value that is the lesser of FFFFh or the result of the following formula:

EXTENDED SELF-TEST COMPLETION TIME field = $((w \times 256) + z) \times 60$;

where w is the contents of byte 376 and z is the contents of byte 375."

Discussed: < Should SAT require the SATL to retrieve the SMART data structure each time, or should a cached copy suffice?

RESOLUTION:s/b

"... ATA IDENTIFY DEVICE data word 84, bit 1. If ATA IDENTIFY DEVICE data word 84, bit 1 is set to one, the ATA device supports the SMART self-test and shall retrieve the ATA device SMART data structure from the ATA device by sending an ATA SMART READ DATA command to the ATA device. The SATL may cache this information for future use when a subsequent MODE SENSE command requests the control mode page. If the SATL caches such data, the SATL may reference the cached copy instead of sending a new ATA SMART READ DATA command. Then the SATL shall set the EXTENDED SELF-TEST COMPLETION TIME field as follows:

1) If byte 373 of the returned SMART data structure is not set to FFh, the SATL shall set the EXTENDED SELF-TEST COMPLETION TIME field to a value that is 60 times the contents of byte 373; or

2) If byte 373 of the returned SMART data structure is set to FFh, the SATL shall set the EXTENDED SELF-TEST COMPLETION TIME field to a value that is the lesser of FFFFh or the result of the following formula:

EXTENDED SELF-TEST COMPLETION TIME field = $((w \times 256) + z) \times 60$;

where w is the contents of byte 376 and z is the contents of byte 375."

Status

Comments from page 88 continued on next page

IDENTIFY DEVICE data for word 84, bit 1. If word 84, bit 1 is set to one, the device supports the SMART self-test. Under these conditions, the SATL shall set the EXTENDED SELF-TEST COMPLETION TIME field as follows:

- 1) The SATL shall obtain the device SMART data structure by sending a SMART READ DATA command to the attached device. The SATL may cache this information for future use when a subsequent MODE SENSE command requests the control mode page. If the SATL caches such data, it is not mandatory to send a SMART READ DATA more than one time.
- 2) If byte 373 of the SMART data structure is not FFh, the SATL shall set the extended self-test completion time to 60 times the contents of byte 373.
- 3) If byte 373 of the SMART data structure is FFh, the SATL shall set the extended self-test completion time to the lesser of FFFFh or the result of the following formula:

$$\text{EXTENDED SELF-TEST COMPLETION TIME field} = ((w \times 256) + z) \times 60;$$

where z is the contents of byte 375 and w is the contents of byte 376.

10.1.5 Read-Write Error Recovery mode page

The Read-Write Error Recovery mode page specifies the error recovery parameters the SATL shall use during any command that performs a read or write operation to the ATA device's medium (see SBC-2). Table 66 defines the translation for the Read-Write Error Recovery mode page.

Table 66 — Read-write error recovery mode page fields

Field	Changeable	Description or reference
PS	n/a	Unspecified (see 3.4.3)
PAGE CODE	no	Set to 01h. This field value is specific to the Read-Write Error Recovery mode page.
PAGE LENGTH	no	See SBC-2.
ARRE	no	Shall be set to one (see SBC-2).
AWRE	no	Shall be set to zero (see SBC-2).
TB	n/a	Unspecified (see 3.4.3)
RC	no	Shall be set to zero (see SBC-2).
EER	no	Shall be set to zero (see SBC-2).
PER	no	Shall be set to zero (see SBC-2).
DTE	no	Shall be set to zero (see SBC-2).
DCR	no	Shall be set to zero (see SBC-2).
READ RETRY COUNT	n/a	Unspecified (see 3.4.3)
WRITE RETRY COUNT	n/a	Unspecified (see 3.4.3)
RECOVERY TIME LIMIT	no	Shall be set to 00h (see SBC-2).

^a If the SATL receives a MODE SELECT command with a value other than zero set in this field the SATL shall terminate the command with CHECK CONDITION status with the sense key set to ILLEGAL REQUEST and the additional sense code set to INVALID FIELD IN PARAMETER LIST.

risheffi Completed 6/23/2006 9:32:28 AM

Sequence number: 2
Author: HPQ[RElliott]
Date: 5/6/2006 11:34:37 AM
 10.1.4.2

control s/b Control
RESOLUTION: See DELL comment (deleted the sentence containing the word 'control')

Status
risheffi Completed 6/23/2006 9:33:23 AM

Sequence number: 3
Author: ENDL[RWeber]
Date: 2/14/2006 8:32:50 PM
 1,2,3 list

This list is not properly structured. Entries 1 and 2 end with periods. There is no conjunction between entries 2 and 3.

Status
risheffi Completed 6/23/2006 9:33:36 AM

Sequence number: 4
Author: ENDL[RWeber]
Date: 2/14/2006 8:34:42 PM
 1,2,3 list, entry 3

The formula needs to be indented farther than the second-line indent for the preceding paragraph. The line that begins 'where ...' needs to be indented farther than the formula. Otherwise it is not clear what belongs to what.

Status
risheffi Completed 6/23/2006 9:34:53 AM

Sequence number: 5
Author: HPQ[RElliott]
Subject: Highlight
Date: 1/19/2006 9:26:17 AM
 10.1.41

indent the equation more

Status
risheffi Completed 6/23/2006 9:35:06 AM

Sequence number: 6
Author: HPQ[WBellamy]
Subject: Note
Date: 5/6/2006 11:36:49 AM
 remove " ' "

RESOLUTION:
change "ATA device's medium" to "medium of the ATA device"

Status
risheffi Completed 6/23/2006 9:41:09 AM

Sequence number: 7
Author: DELL[KMarks]
Subject: Highlight
Date: 2/9/2006 8:52:59 PM
 **10.1.5 Read-Write Error Recovery mode page**
1st Sentence
change

"The Read-Write Error Recovery mode page specifies the error recovery parameters the SATL shall use during any command that performs a read or write operation to the ATA device's medium (see SBC-2)."

to

"The Read-Write Error Recovery mode page specifies the error recovery parameters the SATL shall use during a command that performs a read or write operation to the medium of the ATA device (see SBC-2)."

Status

Comments from page 88 continued on next page

IDENTIFY DEVICE data for word 84, bit 1. If word 84, bit 1 is set to one, the device supports the SMART self-test. Under these conditions, the SATL shall set the EXTENDED SELF-TEST COMPLETION TIME field as follows:

- 1) The SATL shall obtain the device SMART data structure by sending a SMART READ DATA command to the attached device. The SATL may cache this information for future use when a subsequent MODE SENSE command requests the control mode page. If the SATL caches such data, it is not mandatory to send a SMART READ DATA more than one time.
- 2) If byte 373 of the SMART data structure is not FFh, the SATL shall set the extended self-test completion time to 60 times the contents of byte 373.
- 3) If byte 373 of the SMART data structure is FFh, the SATL shall set the extended self-test completion time to the lesser of FFFFh or the result of the following formula:

$$\text{EXTENDED SELF-TEST COMPLETION TIME field} = ((w \times 256) + z) \times 60;$$

where z is the contents of byte 375 and w is the contents of byte 376.

10.1.5 Read-Write Error Recovery mode page

The Read-Write Error Recovery mode page specifies the error recovery parameters the SATL shall use during any command that performs a read or write operation to the ATA device's medium (see SBC-2). Table 66 defines the translation for the Read-Write Error Recovery mode page.

Table 66 — Read-write error recovery mode page fields

Field	Changeable	Description or reference
PS	n/a	10 specified (see 3.4.3)
PAGE CODE	no	12 t to 01h. This field value is specific to the Read-Write Error Recovery mode page.
PAGE LENGTH	no	13 e SBC-2.
ARRE	no	Shall be set to one (see SBC-2).
AWRE	no	Shall be set to zero (see SBC-2).
TB	n/a	Unspecified (see 3.4.3)
RC	no	Shall be set to zero (see SBC-2).
EER	no	Shall be set to zero (see SBC-2).
PER	no	Shall be set to zero (see SBC-2).
DTE	no	Shall be set to zero (see SBC-2).
DCR	no	Shall be set to zero (see SBC-2).
READ RETRY COUNT	n/a	Unspecified (see 3.4.3)
WRITE RETRY COUNT	n/a	Unspecified (see 3.4.3)
RECOVERY TIME LIMIT	no	Shall be set to 00h (see SBC-2).

^a If the SATL receives a MODE SELECT command with a value other than zero set in this field the SATL shall terminate the command with CHECK CONDITION status with the sense key set to ILLEGAL REQUEST and the additional sense code set to INVALID FIELD IN PARAMETER LIST.

risheffi Completed 6/23/2006 9:41:16 AM

Sequence number: 8
Author: DELL[KMarks]
Subject: Highlight
Date: 2/9/2006 8:51:23 PM

 Table 66 — Read-write error recovery mode page fields

change title to
"Table 66 — Read-Write Error Recovery mode page fields"

Status
risheffi Completed 6/23/2006 9:42:14 AM

Sequence number: 9
Author: HPQ[WBellamy]
Subject: Note
Date: 5/6/2006 11:40:38 AM

 I believe it is incorrect to apply reference note "a" here. It should be appropriately applied to each field when the criteria applies.
RESOLUTION: remove table footnote (see DELL comment).

Status
risheffi Completed 6/23/2006 9:44:14 AM

Sequence number: 10
Author: DELL[KMarks]
Subject: Highlight
Date: 5/6/2006 11:42:23 AM

 Table 66 — Read-write error recovery mode page fields

Row: PS

Based on the current text, this shall be zero for MODE SENSE. I think saveable pages should be an options and therefore think Unspecified is correct.

RESOLUTION: SAT will allow saveable mode pages, so leave it as "Unspecified".

Status
risheffi Completed 6/23/2006 9:45:22 AM

Sequence number: 11
Author: DELL[KMarks]
Subject: Note
Date: 5/9/2006 5:12:04 PM

 Table 66 — Read-write error recovery mode page fields

Missing SPF bit (0b) Row

REASON: SBC-2 does not define the SPF bit in the Read-Write Error Recovery mode page. SAT is written with SBC-2 as the normative reference.

Status
risheffi Rejected 5/9/2006 5:12:09 PM

Sequence number: 12
Author: DELL[KMarks]
Subject: Highlight
Date: 2/9/2006 9:33:29 PM

 Table 66 — Read-write error recovery mode page fields

Row: PAGE CODE

Change

"Set to 01h. This field value is specific to the Read-Write Error Recovery mode page."

to

"Shall be set to 01h"

Status
risheffi Completed 6/23/2006 9:46:47 AM

Sequence number: 13
Author: DELL[KMarks]
Subject: Highlight
Date: 2/9/2006 9:34:27 PM

Comments from page 88 continued on next page

IDENTIFY DEVICE data for word 84, bit 1. If word 84, bit 1 is set to one, the device supports the SMART self-test. Under these conditions, the SATL shall set the EXTENDED SELF-TEST COMPLETION TIME field as follows:

- 1) The SATL shall obtain the device SMART data structure by sending a SMART READ DATA command to the attached device. The SATL may cache this information for future use when a subsequent MODE SENSE command requests the control mode page. If the SATL caches such data, it is not mandatory to send a SMART READ DATA more than one time.
- 2) If byte 373 of the SMART data structure is not FFh, the SATL shall set the extended self-test completion time to 60 times the contents of byte 373.
- 3) If byte 373 of the SMART data structure is FFh, the SATL shall set the extended self-test completion time to the lesser of FFFFh or the result of the following formula:

$$\text{EXTENDED SELF-TEST COMPLETION TIME field} = ((w \times 256) + z) \times 60;$$

where z is the contents of byte 375 and w is the contents of byte 376.

10.1.5 Read-Write Error Recovery mode page

The Read-Write Error Recovery mode page specifies the error recovery parameters the SATL shall use during any command that performs a read or write operation to the ATA device's medium (see SBC-2). Table 66 defines the translation for the Read-Write Error Recovery mode page.

Table 66 — Read-write error recovery mode page fields

Field	Changeable	Description or reference
PS	n/a	Unspecified (see 3.4.3)
PAGE CODE	no	Set to 01h. This field value is specific to the Read-Write Error Recovery mode page.
PAGE LENGTH	no	See SBC-2.
18 RE	no	16 all be set to 15e (see SBC-2). 14
AWRE	no	Shall be set to 19ro (see SBC-2).
TB	n/a	Unspecified (see 3.4.3)
RC	no	Shall be set to zero (see SBC-2).
EER	no	Shall be set to zero (see SBC-2).
PER	no	Shall be set to zero (see SBC-2).
DTE	no	Shall be set to zero (see SBC-2).
DCR	no	Shall be set to zero (see SBC-2).
READ RETRY COUNT	n/a	Unspecified (see 3.4.3)
WRITE RETRY COUNT	n/a	Unspecified (see 3.4.3)
RECOVERY TIME LIMIT	no	Shall be set to 00h (see SBC-2).

^a If the SATL receives a MODE SELECT command with a value other than zero set in this field the SATL shall terminate the command with CHECK CONDITION status with the sense key set to ILLEGAL REQUEST and the additional sense code set to INVALID FIELD IN PARAMETER LIST.

T Table 66 — Read-write error recovery mode page fields

Row: PAGE LENGTH

Change

"See SBC-2."

to

"Shall be set to 0Ah."

Status
rlsheffi Completed 6/23/2006 9:47:25 AM

Sequence number: 14
Author: EDITOR[rlsheffi]
Subject: Rectangle
Date: 5/9/2006 5:28:06 PM

 Discussed: What is the reasoning behind the specified values for ARRE and AWRE? LB comments from HPQ and LSI as well as 05-241r2 suggest AWRE should be "one", and ARRE should be "zero". My understanding is that an ATA device will auto-reallocate on an unrecoverable READ error, but that the reallocation is deferred until the next time that same logical sector is written. An ATA device does not check data consistency on a write, and there is no write-and-verify equivalent, so I don't see that an ATA device will auto-reallocate due to an error on a write command. But..., the data that ends up in the alternate sector is the data from the write, not the data from the read, so AWRE is one and ARRE is zero.

RESOLUTION:

ARRE - "Shall be set to zero (see SBC-2)."

AWRE - "Shall be set to one (see SBC-2)."

Status
rlsheffi Completed 6/23/2006 9:48:30 AM

Sequence number: 15
Author: LSI[OParry]
Subject: Highlight
Date: 2/14/2006 3:06:28 PM

T 10.1.5 Read-Write Error Recovery mode page
Table 66 - Read-write error recovery mode page fields

Change "ARRE set to one" to "... zero".

Status
rlsheffi Completed 6/23/2006 12:07:56 PM

Sequence number: 16
Author: HPQ[WBellamy]
Subject: Highlight
Date: 2/17/2006 10:00:09 AM

T

Status
rlsheffi Cancelled 5/6/2006 11:53:46 AM

Sequence number: 17
Author: HPQ[WBellamy]
Subject: Highlight
Date: 2/17/2006 10:04:02 AM

T

Status
rlsheffi Cancelled 5/6/2006 11:53:51 AM

Sequence number: 18
Author: HPQ[WBellamy]
Subject: Note
Date: 2/17/2006 10:03:26 AM

 The settings AWRE and ARRE are not per 05-241r2. It appears that the rows for the bit fields got swapped (far L-H column). This must be corrected to comply with the working group agreement.

Status
rlsheffi Completed 6/23/2006 12:11:35 PM

Sequence number: 19
Author: LSI[OParry]
Subject: Highlight
Date: 2/14/2006 3:06:37 PM

Comments from page 88 continued on next page

IDENTIFY DEVICE data for word 84, bit 1. If word 84, bit 1 is set to one, the device supports the SMART self-test. Under these conditions, the SATL shall set the EXTENDED SELF-TEST COMPLETION TIME field as follows:

- 1) The SATL shall obtain the device SMART data structure by sending a SMART READ DATA command to the attached device. The SATL may cache this information for future use when a subsequent MODE SENSE command requests the control mode page. If the SATL caches such data, it is not mandatory to send a SMART READ DATA more than one time.
- 2) If byte 373 of the SMART data structure is not FFh, the SATL shall set the extended self-test completion time to 60 times the contents of byte 373.
- 3) If byte 373 of the SMART data structure is FFh, the SATL shall set the extended self-test completion time to the lesser of FFFFh or the result of the following formula:

$$\text{EXTENDED SELF-TEST COMPLETION TIME field} = ((w \times 256) + z) \times 60;$$

where z is the contents of byte 375 and w is the contents of byte 376.

10.1.5 Read-Write Error Recovery mode page

The Read-Write Error Recovery mode page specifies the error recovery parameters the SATL shall use during any command that performs a read or write operation to the ATA device's medium (see SBC-2). Table 66 defines the translation for the Read-Write Error Recovery mode page.

Table 66 — Read-write error recovery mode page fields

Field	Changeable	Description or reference
PS	n/a	Unspecified (see 3.4.3)
PAGE CODE	no	Set to 01h. This field value is specific to the Read-Write Error Recovery mode page.
PAGE LENGTH	no	See SBC-2.
ARRE	no	Shall be set to one (see SBC-2).
21 RE	no	20 all be set to zero (see SBC-2).
TB	n/a	Unspecified (see 3.4.3)
RC	no	Shall be set to zero (see SBC-2).
EER	no	Shall be set to zero (see SBC-2).
PER	no	Shall be set to zero (see SBC-2).
DTE	no	Shall be set to zero (see SBC-2).
DCR	no	Shall be set to zero (see SBC-2).
READ RETRY COUNT	n/a	Unspecified (see 3.4.3)
WRITE RETRY COUNT	n/a	Unspecified (see 3.4.3)
RECOVERY TIME LIMIT	no	Shall be set to 00h (see SBC-2).
22 If the SATL receives a MODE SELECT command with a value other than zero set in this field the SATL shall terminate the command with CHECK CONDITION status with the sense key set to ILLEGAL REQUEST and the additional sense code set to INVALID FIELD IN PARAMETER LIST.		

T 10.1.5 Read-Write Error Recovery mode page
Table 66 - Read-write error recovery mode page fields

Change "AWRE set to zero" to "... one".

Status
rlsheffi Completed 6/23/2006 12:11:56 PM

Sequence number: 20
Author: HPQ[WBellamy]
Subject: Highlight
Date: 2/17/2006 10:00:13 AM

T

Status
rlsheffi Cancelled 5/6/2006 12:04:44 PM

Sequence number: 21
Author: HPQ[WBellamy]
Subject: Highlight
Date: 2/17/2006 10:04:06 AM

T

Status
rlsheffi Cancelled 5/6/2006 12:04:48 PM

Sequence number: 22
Author: DELL[KMarks]
Subject: Cross-Out
Date: 6/23/2006 12:13:46 PM

T Remove footnote a from table 66, already stated in 10.1.2
T RESOLUTION: Remove footnote.

Status
rlsheffi Completed 6/23/2006 12:13:49 PM

Sequence number: 23
Author: HPQ[WBellamy]
Subject: Note
Date: 6/23/2006 12:14:01 PM

T Note "a" needs to be applied to each appropriate field.
T RESOLUTION: Remove footnote.

Status
rlsheffi Completed 6/23/2006 12:14:05 PM

4.1.6 Caching mode page (08h)

The caching mode page (08h) defines parameters that affect the behavior of the ATA device's cache.

Table 67 shows the translation of fields in the caching mode page.

Table 67 — Caching mode page fields (part 1 of 2)

Field	changeable	Description or reference
PS	n/a	Unspecified (see 3.4.3)
PAGE CODE	no	See SBC-2
PAGE LENGTH	no	See SBC-2
IC	no	Set to 0b. A value of 1b is not supported in this standard. ^a
ABPF	no	Set to 0b. A value of 1b is not supported in this standard. ^a
CAP	no	Set to 0b. A value of 1b is not supported in this standard. ^a
DISC	no	Set to 0b. A value of 1b is not supported in this standard. ^a
SIZE	no	Set to 0b. A value of 1b is not supported in this standard. ^a
WCE	yes	<p>When processing a MODE SELECT command, the SATL shall determine if the ATA device's write cache is enabled or disabled from the ATA IDENTIFY DEVICE data word 85, bit 5. If the ATA device's write cache is enabled the SATL shall return 1b for the WCE bit. If the ATA device's write cache is disabled the SATL shall return 0b for the WCE bit.</p> <p>When processing a MODE SELECT command,</p> <ul style="list-style-type: none"> a) if the WCE bit is set to zero, then the SATL shall disable the ATA device's write cache by issuing an ATA SET FEATURES – Disable write cache command (i.e., send a Command code of EFh with the Features register set to 82h); or b) if the WCE bit is set to one, then the SATL shall enable the ATA device's write cache by issuing an ATA SET FEATURES – Enable write cache command (i.e., send a Command code of EFh with the Features register set to 02h).
MF	no	Set to 0b. A value of 1b is not supported in this standard. ^a
RCD	no	Set to 0b. A value of 1b is not supported in this standard. ^a
DEMAND READ RETENTION PRIORITY	no	Set to 0h. Any other value is not supported in this standard. ^a
WRITE RETENTION PRIORITY	no	Set to 0h. Any other value is not supported in this standard. ^a
DISABLE PRE-FETCH TRANSFER LENGTH	no	Set to 0h. Any other value is not supported in this standard. ^a
MINIMUM PRE-FETCH	no	Set to 0h. Any other value is not supported in this standard. ^a
MAXIMUM PRE-FETCH	no	Set to 0h. Any other value is not supported in this standard. ^a
MAXIMUM PRE-FETCH CEILING	no	Set to 0h. Any other value is not supported in this standard. ^a
FSW	no	Set to 0b. A value of 1b is not supported in this standard. ^a
^a If the SATL receives a MODE SELECT command with a value other than zero set in this field the SATL shall terminate the command with CHECK CONDITION status with the sense key set to ILLEGAL REQUEST and the additional sense code set to INVALID FIELD IN PARAMETER LIST.		

Page: 89

Sequence number: 1
Author: HPQ[WBellamy]
Subject: Note
Date: 2/17/2006 9:13:45 AM
 remove the (08h) from here...

Status
risheffi Completed 6/23/2006 12:14:27 PM

Sequence number: 2
Author: HPQ[RElliott]
Subject: Cross-Out
Date: 1/19/2006 9:35:22 AM
 10.1.8

Delete (08h)

Status
risheffi Completed 6/23/2006 12:14:38 PM

Sequence number: 3
Author: IBM[GPenokie]
Subject: Underline
Date: 2/16/2006 1:30:18 PM
 10.1.6 Caching mode page (08h)

Status
risheffi Cancelled 6/24/2006 8:16:34 AM

Sequence number: 4
Author: DELL[KMarks]
Subject: Highlight
Date: 2/9/2006 10:04:13 PM
 10.1.6 Caching mode page (08h)

change title to
"10.1.6 Caching mode page"

to match other Mode page subclause titles

Status
risheffi Completed 6/23/2006 12:15:09 PM

Sequence number: 5
Author: HPQ[WBellamy]
Subject: Note
Date: 2/17/2006 9:29:25 AM
 When did we start personalizing device items? I believe the " " should be removed. This occurs in several places in this section and the table below. It was not in the proposal 05-239r1.

Status
risheffi Completed 6/23/2006 12:18:18 PM

Sequence number: 6
Author: HPQ[WBellamy]
Subject: Note
Date: 5/6/2006 12:07:08 PM
 Is this supposed to be capitalized like other mode page names?
RESOLUTION: "caching" s/b "Caching"

Status
risheffi Completed 6/23/2006 12:18:17 PM

Sequence number: 7
Author: HPQ[RElliott]
Subject: Highlight
Date: 2/1/2006 9:15:34 AM
 10.1.6
caching s/ Caching

Status
risheffi Completed 6/23/2006 12:18:17 PM

Comments from page 89 continued on next page

10.1.6 Caching mode page (08h)

The caching mode page (08h) defines parameters that affect the behavior of the ATA device's cache.

Table 67 shows the translation of fields in the caching mode page.

Table 67 — Caching mode page fields (part 1 of 2)

Field	13 Changeable	Description or reference
PS	n/a	Unspecified (see 3.4.3)
PAGE CODE	no	See SBC-2
PAGE LENGTH	no	See SBC-2
IC	no	Set to 0b. A value of 1b is not supported in this standard. ^a
ABPF	no	Set to 0b. A value of 1b is not supported in this standard. ^a
CAP	no	Set to 0b. A value of 1b is not supported in this standard. ^a
DISC	no	Set to 0b. A value of 1b is not supported in this standard. ^a
SIZE	no	Set to 0b. A value of 1b is not supported in this standard. ^a
WCE	yes	<p>When processing a MODE SENSE command, the SATL shall determine if the ATA device's write cache is enabled or disabled from the ATA IDENTIFY DEVICE data word 85, bit 5. If the ATA device's write cache is enabled the SATL shall return 1b for the WCE bit. If the ATA device's write cache is disabled the SATL shall return 0b for the WCE bit.</p> <p>When processing a MODE SELECT command,</p> <ul style="list-style-type: none"> a) if the WCE bit is set to zero, then the SATL shall disable the ATA device's write cache by issuing an ATA SET FEATURES – Disable write cache command (i.e., send a Command code of EFh with the Features register set to 82h); or b) if the WCE bit is set to one, then the SATL shall enable the ATA device's write cache by issuing an ATA SET FEATURES – Enable write cache command (i.e., send a Command code of EFh with the Features register set to 02h).
MF	no	Set to 0b. A value of 1b is not supported in this standard. ^a
RCD	no	Set to 0b. A value of 1b is not supported in this standard. ^a
DEMAND READ RETENTION PRIORITY	no	Set to 0h. Any other value is not supported in this standard. ^a
WRITE RETENTION PRIORITY	no	Set to 0h. Any other value is not supported in this standard. ^a
DISABLE PRE-FETCH TRANSFER LENGTH	no	Set to 0h. Any other value is not supported in this standard. ^a
MINIMUM PRE-FETCH	no	Set to 0h. Any other value is not supported in this standard. ^a
MAXIMUM PRE-FETCH	no	Set to 0h. Any other value is not supported in this standard. ^a
MAXIMUM PRE-FETCH CEILING	no	Set to 0h. Any other value is not supported in this standard. ^a
FSW	no	Set to 0b. A value of 1b is not supported in this standard. ^a
^a If the SATL receives a MODE SELECT command with a value other than zero set in this field the SATL shall terminate the command with CHECK CONDITION status with the sense key set to ILLEGAL REQUEST and the additional sense code set to INVALID FIELD IN PARAMETER LIST.		

Sequence number: 8
Author: MXO[MEvans]
Subject: Highlight
Date: 2/16/2006 12:06:46 PM

T 10.1.6 Caching mode page (08), first paragraph: change "...caching mode page..." to "...Caching mode page...".

Status
rlsheffi Completed 6/23/2006 12:18:17 PM

Sequence number: 9
Author: DELL[KMarks]
Subject: Highlight
Date: 2/16/2006 8:54:30 PM

T 10.1.6 Caching mode page (08h)
1st two Sentences
change

"The caching mode page (08h) defines parameters that affect the behavior of the ATA device's cache.
Table 67 shows the translation of fields in the caching mode page."

to

"The Caching mode page defines parameters that affect the behavior of the cache in the ATA device.
Table 67 shows the translation of fields in the Caching mode page."

Removed (08h), because none of the other mode pages have the number.

Status
rlsheffi Completed 6/23/2006 12:18:17 PM

Sequence number: 10
Author: HPQ[WBellamy]
Subject: Note
Date: 5/6/2006 12:08:19 PM

 Is this supposed to be capitalized like other mode page names?
RESOLUTION: "caching" s/b "Caching"

Status
rlsheffi Completed 6/23/2006 12:18:17 PM

Sequence number: 11
Author: HPQ[RElliott]
Subject: Highlight
Date: 2/1/2006 9:15:58 AM

T 10.1.6
caching s/b Caching

Status
rlsheffi Completed 6/23/2006 12:18:17 PM

Sequence number: 12
Author: MXO[MEvans]
Subject: Highlight
Date: 2/16/2006 12:06:59 PM

T page 89
10.1.6 Caching mode page (08), first paragraph: change "...caching mode page..." to "...Caching mode page...".

Status
rlsheffi Completed 6/23/2006 12:18:18 PM

Sequence number: 13
Author: HPQ[RElliott]
Subject: Highlight
Date: 2/1/2006 9:16:23 AM

T 10.1.6
table 67
changeable s/b Changeable

Status
rlsheffi Completed 6/23/2006 12:19:29 PM

Comments from page 89 continued on next page

10.1.6 Caching mode page (08h)

The caching mode page (08h) defines parameters that affect the behavior of the ATA device's cache.

Table 67 shows the translation of fields in the caching mode page.

Table 67 — Caching mode page fields (part 1 of 2)

Field	changeable	Description or reference
PS	n/a	14 specified (see 3.4.3)
PAGE CODE	no	15 See SBC-2
PAGE LENGTH	no	16 See SBC-2
IC	no	17 1 to 0b. A value of 1b is not supported in this standard. ^a
ABPF	no	18 1 to 0b. A value of 1b is not supported in this standard. ^a
CAP	no	19 1 to 0b. A value of 1b is not supported in this standard. ^a
DISC	no	Set to 0b. A value of 1b is not supported in this standard. ^a
SIZE	no	Set to 0b. A value of 1b is not supported in this standard. ^a
WCE	yes	<p>When processing a MODE SELECT command, the SATL shall determine if the ATA device's write cache is enabled or disabled from the ATA IDENTIFY DEVICE data word 85, bit 5. If the ATA device's write cache is enabled the SATL shall return 1b for the WCE bit. If the ATA device's write cache is disabled the SATL shall return 0b for the WCE bit.</p> <p>When processing a MODE SELECT command,</p> <ol style="list-style-type: none"> if the WCE bit is set to zero, then the SATL shall disable the ATA device's write cache by issuing an ATA SET FEATURES – Disable write cache command (i.e., send a Command code of EFh with the Features register set to 82h); or if the WCE bit is set to one, then the SATL shall enable the ATA device's write cache by issuing an ATA SET FEATURES – Enable write cache command (i.e., send a Command code of EFh with the Features register set to 02h).
MF	no	Set to 0b. A value of 1b is not supported in this standard. ^a
RCD	no	Set to 0b. A value of 1b is not supported in this standard. ^a
DEMAND READ RETENTION PRIORITY	no	Set to 0h. Any other value is not supported in this standard. ^a
WRITE RETENTION PRIORITY	no	Set to 0h. Any other value is not supported in this standard. ^a
DISABLE PRE-FETCH TRANSFER LENGTH	no	Set to 0h. Any other value is not supported in this standard. ^a
MINIMUM PRE-FETCH	no	Set to 0h. Any other value is not supported in this standard. ^a
MAXIMUM PRE-FETCH	no	Set to 0h. Any other value is not supported in this standard. ^a
MAXIMUM PRE-FETCH CEILING	no	Set to 0h. Any other value is not supported in this standard. ^a
FSW	no	Set to 0b. A value of 1b is not supported in this standard. ^a
^a If the SATL receives a MODE SELECT command with a value other than zero set in this field the SATL shall terminate the command with CHECK CONDITION status with the sense key set to ILLEGAL REQUEST and the additional sense code set to INVALID FIELD IN PARAMETER LIST.		

Sequence number: 14
Author: DELL[KMarks]
Subject: Highlight
Date: 5/6/2006 12:09:47 PM

T Table 67 — Caching mode page fields (part 1 of 2)

Row: PS

Based on the current text, this shall be zero for MODE SENSE. I think saveable pages should be an options and therefore think Unspecified is correct.

RESOLUTION: SAT allows savable mode parameters, so it will remain "Undefined"

Status
rlsheffi Completed 6/23/2006 12:19:56 PM

Sequence number: 15
Author: DELL[KMarks]
Subject: Highlight
Date: 2/9/2006 9:36:15 PM

T Table 67 — Caching mode page fields (part 1 of 2)

Row: PAGECODE

Change

"See SBC-2."

to

"Shall be set to 08h."

Status
rlsheffi Completed 6/23/2006 12:20:29 PM

Sequence number: 16
Author: DELL[KMarks]
Subject: Highlight
Date: 2/9/2006 9:36:03 PM

T Table 67 — Caching mode page fields (part 1 of 2)

Row: PAGE LENGTH

Change

"See SBC-2."

to

"Shall be set to 12h."

Status
rlsheffi Completed 6/23/2006 12:20:47 PM

Sequence number: 17
Author: IBM[GPenokie]
Subject: Comment on Text
Date: 6/23/2006 12:55:25 PM

T table 67 - row ic
This << Set to 0b. A value of 1b is not supported in this standard. >> should be << Set to zero. A value of one is not supported in this standard. >>
RESOLUTION: s/b
"Shall be set to zero"

Status
rlsheffi Completed 6/23/2006 12:21:10 PM

Sequence number: 18
Author: IBM[GPenokie]
Subject: Comment on Text
Date: 6/23/2006 12:55:32 PM

T table 67 - row abpf
This << Set to 0b. A value of 1b is not supported in this standard. >> should be << Set to zero. A value of one is not supported in this standard. >>
RESOLUTION: s/b
"Shall be set to zero"

Status
rlsheffi Completed 6/23/2006 12:21:19 PM

Sequence number: 19
Author: IBM[GPenokie]
Subject: Comment on Text

Comments from page 89 continued on next page

10.1.6 Caching mode page (08h)

The caching mode page (08h) defines parameters that affect the behavior of the ATA device's cache.

Table 67 shows the translation of fields in the caching mode page.

Table 67 — Caching mode page fields (part 1 of 2)

Field	changeable	Description or reference
PS	n/a	Unspecified (see 3.4.3)
PAGE CODE	no	See SBC-2
PAGE LENGTH	no	See SBC-2
IC	no	Set to 0b. A value of 1b is not supported in this standard. ^a
ABPF	no	Set to 0b. A value of 1b is not supported in this standard. ^a
CAP	no	Set to 0b. A value of 1b is not supported in this standard. ^a
DISC	no	Set to 0b. A value of 1b is not supported in this standard. ^a
SIZE	no	Set to 0b. A value of 1b is not supported in this standard. ^a
WCE	yes	<p>When processing a MODE SELECT command, the SATL shall determine if the ATA device's write cache is enabled or disabled from the ATA IDENTIFY DEVICE data word 85, bit 5. If the ATA device's write cache is enabled the SATL shall return 1b for the WCE bit. If the ATA device's write cache is disabled the SATL shall return 0b for the WCE bit.</p> <p>When processing a MODE SELECT command,</p> <ul style="list-style-type: none"> a) if the WCE bit is set to zero, then the SATL shall disable the ATA device's write cache by issuing an ATA SET FEATURES – Disable write cache command (i.e., send a Command code of EFh with the Features register set to 82h); or b) if the WCE bit is set to one, then the SATL shall enable the ATA device's write cache by issuing an ATA SET FEATURES – Enable write cache command (i.e., send a Command code of EFh with the Features register set to 02h).
MF	no	Set to 0b. A value of 1b is not supported in this standard. ^a
RCD	no	Set to 0b. A value of 1b is not supported in this standard. ^a
DEMAND READ RETENTION PRIORITY	no	Set to 0h. Any other value is not supported in this standard. ^a
WRITE RETENTION PRIORITY	no	Set to 0h. Any other value is not supported in this standard. ^a
DISABLE PRE-FETCH TRANSFER LENGTH	no	Set to 0h. Any other value is not supported in this standard. ^a
MINIMUM PRE-FETCH	no	Set to 0h. Any other value is not supported in this standard. ^a
MAXIMUM PRE-FETCH	no	Set to 0h. Any other value is not supported in this standard. ^a
MAXIMUM PRE-FETCH CEILING	no	Set to 0h. Any other value is not supported in this standard. ^a
FSW	no	Set to 0b. A value of 1b is not supported in this standard. ^a
^a If the SATL receives a MODE SELECT command with a value other than zero set in this field the SATL shall terminate the command with CHECK CONDITION status with the sense key set to ILLEGAL REQUEST and the additional sense code set to INVALID FIELD IN PARAMETER LIST.		

Date: 6/23/2006 12:55:38 PM

Table 67 - row cap

This << Set to 0b. A value of 1b is not supported in this standard. >> should be << Set to zero. A value of one is not supported in this standard. >>

RESOLUTION: s/b

"Shall be set to zero"

Status

risheffi Completed 6/23/2006 12:21:26 PM

Sequence number: 20

Author: IBM[GPenokie]

Subject: Comment on Text

Date: 6/23/2006 12:55:42 PM

Table 67 - row disc

This << Set to 0b. A value of 1b is not supported in this standard. >> should be << Set to zero. A value of one is not supported in this standard. >>

RESOLUTION: s/b

"Shall be set to zero"

Status

risheffi Completed 6/23/2006 12:21:34 PM

Sequence number: 21

Author: IBM[GPenokie]

Subject: Comment on Text

Date: 6/23/2006 12:55:47 PM

Table 67 - row size

This << Set to 0b. A value of 1b is not supported in this standard. >> should be << Set to zero. A value of one is not supported in this standard. >>

RESOLUTION: s/b

"Shall be set to zero"

Status

risheffi Completed 6/23/2006 12:21:42 PM

Sequence number: 22

Author: DELL[KMarks]

Subject: Highlight

Date: 5/6/2006 12:17:30 PM

Table 67 — Caching mode page fields (part 1 of 2)

Row: WCE

Change

“When processing a MODE SENSE command, the SATL shall determine if the ATA device’s write cache is enabled or disabled from the ATA IDENTIFY DEVICE data word 85, bit 5. If the ATA device’s write cache is enabled the SATL shall return 1b for the WCE bit. If the ATA device’s write cache is disabled the SATL shall return 0b for the WCE bit.

When processing a MODE SELECT command,

a) if the WCE bit is set to zero, then the SATL shall disable the ATA device’s write cache by issuing an ATA SET FEATURES– Disable write cache command (i.e., send a Command code of EFh with the Features register set to 82h); or

b) if the WCE bit is set to one, then the SATL shall enable the ATA device’s write cache by issuing an ATA SET FEATURES – Enable write cache command (i.e., send a Command code of EFh with the Features register set to 02h).”

to

“When processing a MODE SENSE command, the SATL shall determine if the write cache of the ATA device is enabled from the ATA IDENTIFY DEVICE data word 85, bit 5. If the write cache of the ATA device is enabled the SATL shall return a value of one for the WCE bit. If the write cache of the ATA device is disabled the SATL shall return a value of zero for the WCE bit.

When processing a MODE SELECT command:

a) if the WCE bit is set to zero, the SATL shall disable the write cache of the ATA device by issuing an ATA SET FEATURES – Disable write cache command (i.e., Features register set to 82h); or

b) if the WCE bit is set to one, the SATL shall enable the write cache of the ATA device by issuing an ATA SET FEATURES – Enable write cache command (i.e., Features register set to 02h).”

Comments from page 89 continued on next page

10.1.6 Caching mode page (08h)

The caching mode page (08h) defines parameters that affect the behavior of the ATA device's cache.

Table 67 shows the translation of fields in the caching mode page.

Table 67 — Caching mode page fields (part 1 of 2)

Field	changeable	Description or reference
PS	n/a	Unspecified (see 3.4.3)
PAGE CODE	no	See SBC-2
PAGE LENGTH	no	See SBC-2
IC	no	Set to 0b. A value of 1b is not supported in this standard. ^a
ABPF	no	Set to 0b. A value of 1b is not supported in this standard. ^a
CAP	no	Set to 0b. A value of 1b is not supported in this standard. ^a
DISC	no	Set to 0b. A value of 1b is not supported in this standard. ^a
SIZE	no	Set to 0b. A value of 1b is not supported in this standard. ^a
WCE	yes	<p>When processing a MODE SELECT ²³ command, the SATL shall determine if the ATA device's write cache is enabled or disabled from the ²⁵ IDENTIFY DEVICE data word 85, bit 5. If the ATA device's write cache is ²⁷ enabled the SATL ²⁶ shall return 1b for the WCE bit. If the ATA device's write cache is disabled the SATL shall return 0b for the WCE bit.</p> <p>When processing a MODE SELECT command,</p> <ol style="list-style-type: none"> if the WCE bit is set to zero, then the SATL shall disable the ATA device's write cache by issuing an ATA SET FEATURES – Disable write cache command (i.e., send a Command code of EFh with the Features register set to 82h); or if the WCE bit is set to one, then the SATL shall enable the ATA device's write cache by issuing an ATA SET FEATURES – Enable write cache command (i.e., send a Command code of EFh with the Features register set to 02h).
MF	no	Set to 0b. A value of 1b is not supported in this standard. ^a
RCD	no	Set to 0b. A value of 1b is not supported in this standard. ^a
DEMAND READ RETENTION PRIORITY	no	Set to 0h. Any other value is not supported in this standard. ^a
WRITE RETENTION PRIORITY	no	Set to 0h. Any other value is not supported in this standard. ^a
DISABLE PRE-FETCH TRANSFER LENGTH	no	Set to 0h. Any other value is not supported in this standard. ^a
MINIMUM PRE-FETCH	no	Set to 0h. Any other value is not supported in this standard. ^a
MAXIMUM PRE-FETCH	no	Set to 0h. Any other value is not supported in this standard. ^a
MAXIMUM PRE-FETCH CEILING	no	Set to 0h. Any other value is not supported in this standard. ^a
FSW	no	Set to 0b. A value of 1b is not supported in this standard. ^a
^a If the SATL receives a MODE SELECT command with a value other than zero set in this field the SATL shall terminate the command with CHECK CONDITION status with the sense key set to ILLEGAL REQUEST and the additional sense code set to INVALID FIELD IN PARAMETER LIST.		

RESOLUTION: s/b

“When processing a MODE SENSE command, the SATL shall determine if the write cache of the ATA device is enabled from the ATA IDENTIFY DEVICE data word 85, bit 5. If the write cache of the ATA device is enabled the SATL shall return a value of one for the WCE bit. If the write cache of the ATA device is disabled the SATL shall return a value of zero for the WCE bit.

When processing a MODE SELECT command:

- a) if the WCE bit is set to zero, the SATL shall disable the write cache of the ATA device by issuing an ATA SET FEATURES – Disable write cache command (i.e., with the Features register set to 82h); or
- b) if the WCE bit is set to one, the SATL shall enable the write cache of the ATA device by issuing an ATA SET FEATURES – Enable write cache command (i.e., with the Features register set to 02h).”

Status
rlsheffi Completed 6/23/2006 12:51:22 PM

Sequence number: 23
Author: HPQ[WBellamy]
Subject: Note
Date: 3/7/2006 2:20:28 PM
 remove " " "

Status
rlsheffi Completed 6/23/2006 12:51:29 PM

Sequence number: 24
Author: DELL[KMarks]
Subject: Note
Date: 5/6/2006 12:28:36 PM

 **Table 67 — Caching mode page fields (part 1 of 2) and Table 67 — Caching mode page fields (part 2 of 2)**

1. In table change all the 0b and 1b to zero and one.
2. In table change all the "Set to .." to "Shall be set to ..." and remove second sentence about A value of x is not supported in this standard", as "Shall be set to " implies this.
3. Remove Footnote a, as this is standard response to MODE SELECT trying to change a non-changeable mode page parameter and already stated in 10.1.2. If this footnote is not removed, then it needs to be added to every mode page fields table.
4. Missing SPF bit (0b) Row

RESOLUTION: As suggested, except I don't find the SPF field defined in SBC-2's description of the Caching mode page.

Status
rlsheffi Completed 6/23/2006 12:46:37 PM

Sequence number: 25
Author: HPQ[WBellamy]
Subject: Note
Date: 3/7/2006 2:20:46 PM
 remove " " "

Status
rlsheffi Completed 6/23/2006 12:51:36 PM

Sequence number: 26
Author: IBM[GPenokie]
Subject: Comment on Text
Date: 2/16/2006 10:46:09 AM

Table 67 - wce
This << shall return 1b for the WCE
bit. If the ATA device's write cache is disabled the SATL shall return
0b for the WCE bit. >> should be << shall return one for the WCE
bit. If the ATA device's write cache is disabled the SATL shall return
zero for the WCE bit. >>

Status
rlsheffi Completed 6/23/2006 12:47:24 PM

Sequence number: 27
Author: HPQ[WBellamy]
Subject: Note
Date: 2/17/2006 9:49:40 AM
 remove " " "

10.1.6 Caching mode page (08h)

The caching mode page (08h) defines parameters that affect the behavior of the ATA device's cache.

Table 67 shows the translation of fields in the caching mode page.

Table 67 — Caching mode page fields (part 1 of 2)

Field	changeable	Description or reference
PS	n/a	Unspecified (see 3.4.3)
PAGE CODE	no	See SBC-2
PAGE LENGTH	no	See SBC-2
IC	no	Set to 0b. A value of 1b is not supported in this standard. ^a
ABPF	no	Set to 0b. A value of 1b is not supported in this standard. ^a
CAP	no	Set to 0b. A value of 1b is not supported in this standard. ^a
DISC	no	Set to 0b. A value of 1b is not supported in this standard. ^a
SIZE	no	Set to 0b. A value of 1b is not supported in this standard. ^a
WCE	yes	<p>When processing a MODE SE ²⁸ command, the SATL shall determine if the ATA device's write cache is enabled or disabled from the ATA IDENTIFY DEVICE data word 85, bit 5. If the ATA device's write cache is enabled the SATL shall return 1b for the WCE bit. If the ATA device's write cache is disabled the SATL shall return 0b for the WCE bit.</p> <p>When processing a MODE SE ²⁸ command,</p> <ul style="list-style-type: none"> a) if the WCE bit ²⁹ is set to zero, then the SATL shall disable the ATA device's write cache by issuing an ATA SET FEATURES – Disable write cache command (i.e., send a Command code of EFh with the Features register set to 82h); or b) if the WCE bit ³⁰ is set to one, then the SATL shall enable the ATA device's write cache by issuing an ATA SET FEATURES – Enable write cache command (i.e., send a Command code of EFh with the Features register set to 02h).
MF	no	³¹ Set to 0b. A value of 1b is not supported in this standard. ^a
RCD	no	³² Set to 0b. A value of 1b is not supported in this standard. ^a
DEMAND READ RETENTION PRIORITY	no	³³ Set to 0h. Any other value is not supported in this standard. ^a
WRITE RETENTION PRIORITY	no	Set to 0h. Any other value is not supported in this standard. ^a
DISABLE PRE-FETCH TRANSFER LENGTH	no	Set to 0h. Any other value is not supported in this standard. ^a
MINIMUM PRE-FETCH	no	Set to 0h. Any other value is not supported in this standard. ^a
MAXIMUM PRE-FETCH	no	Set to 0h. Any other value is not supported in this standard. ^a
MAXIMUM PRE-FETCH CEILING	no	Set to 0h. Any other value is not supported in this standard. ^a
FSW	no	Set to 0b. A value of 1b is not supported in this standard. ^a
³⁴ If the SATL receives a MODE SELECT command with a value other than zero set in this field the SATL shall terminate the command with CHECK CONDITION status with the sense key set to ILLEGAL REQUEST and the additional sense code set to INVALID FIELD IN PARAMETER LIST.		

Status
rlsheffi Completed 6/23/2006 12:51:43 PM

Sequence number: 28
Author: HPQ[WBellamy]
Subject: Note

Date: 5/6/2006 12:35:21 PM

 Why is it sometimes "zero" and other times "0b"? When is appropriate to use the spelling? In this instance a "bit" is being addressed.

RESOLUTION: s/b "zero"

Status
rlsheffi Completed 6/23/2006 12:47:34 PM

Sequence number: 29
Author: HPQ[WBellamy]
Subject: Note
Date: 2/17/2006 9:51:38 AM

 remove " " "

Status
rlsheffi Completed 6/23/2006 12:51:50 PM

Sequence number: 30
Author: HPQ[WBellamy]
Subject: Note
Date: 2/17/2006 9:50:18 AM

 remove " " "

Status
rlsheffi Completed 6/23/2006 12:52:00 PM

Sequence number: 31
Author: IBM[GPenokie]
Subject: Comment on Text
Date: 6/23/2006 12:56:11 PM

 table 67 - row mf

This << Set to 0b. A value of 1b is not supported in this standard. >> should be << Set to zero. A value of one is not supported in this standard. >>

RESOLUTION: s/b
"Shall be set to zero"

Status
rlsheffi Completed 6/23/2006 12:47:55 PM

Sequence number: 32
Author: IBM[GPenokie]
Subject: Comment on Text
Date: 6/23/2006 12:56:20 PM

 table 67 - row rcd

This << Set to 0b. A value of 1b is not supported in this standard. >> should be << Set to zero. A value of one is not supported in this standard. >>

RESOLUTION: s/b
"Shall be set to zero"

Status
rlsheffi Completed 6/23/2006 12:53:08 PM

Sequence number: 33
Author: IBM[GPenokie]
Subject: Comment on Text
Date: 6/23/2006 12:53:22 PM

 table 65 - last 7 rows on page 69

This << Set to 0h >> should be << Set to zero >>.

RESOLUTION: s/b
"Shall be set to zero"

Status
rlsheffi Completed 6/23/2006 12:53:26 PM

Sequence number: 34
Author: DELL[KMarks]
Subject: Cross-Out
Date: 6/23/2006 12:56:42 PM

Comments from page 89 continued on next page

10.1.6 Caching mode page (08h)

The caching mode page (08h) defines parameters that affect the behavior of the ATA device's cache.

Table 67 shows the translation of fields in the caching mode page.

Table 67 — Caching mode page fields (part 1 of 2)

Field	changeable	Description or reference
PS	n/a	Unspecified (see 3.4.3)
PAGE CODE	no	See SBC-2
PAGE LENGTH	no	See SBC-2
IC	no	Set to 0b. A value of 1b is not supported in this standard. ^a
ABPF	no	Set to 0b. A value of 1b is not supported in this standard. ^a
CAP	no	Set to 0b. A value of 1b is not supported in this standard. ^a
DISC	no	Set to 0b. A value of 1b is not supported in this standard. ^a
SIZE	no	Set to 0b. A value of 1b is not supported in this standard. ^a
WCE	yes	<p>When processing a MODE SENSE command, the SATL shall determine if the ATA device's write cache is enabled or disabled from the ATA IDENTIFY DEVICE data word 85, bit 5. If the ATA device's write cache is enabled the SATL shall return 1b for the WCE bit. If the ATA device's write cache is disabled the SATL shall return 0b for the WCE bit.</p> <p>When processing a MODE SELECT command,</p> <ol style="list-style-type: none"> if the WCE bit is set to zero, then the SATL shall disable the ATA device's write cache by issuing an ATA SET FEATURES – Disable write cache command (i.e., send a Command code of EFh with the Features register set to 82h); or if the WCE bit is set to one, then the SATL shall enable the ATA device's write cache by issuing an ATA SET FEATURES – Enable write cache command (i.e., send a Command code of EFh with the Features register set to 02h).
MF	no	Set to 0b. A value of 1b is not supported in this standard. ^a
RCD	no	Set to 0b. A value of 1b is not supported in this standard. ^a
DEMAND READ RETENTION PRIORITY	no	Set to 0h. Any other value is not supported in this standard. ^a
WRITE RETENTION PRIORITY	no	Set to 0h. Any other value is not supported in this standard. ^a
DISABLE PRE-FETCH TRANSFER LENGTH	no	Set to 0h. Any other value is not supported in this standard. ^a
MINIMUM PRE-FETCH	no	Set to 0h. Any other value is not supported in this standard. ^a
MAXIMUM PRE-FETCH	no	Set to 0h. Any other value is not supported in this standard. ^a
MAXIMUM PRE-FETCH CEILING	no	Set to 0h. Any other value is not supported in this standard. ^a
FSW	no	Set to 0b. A value of 1b is not supported in this standard. ^a
^a If the SATL receives a MODE SELECT command with a value other than zero set in this field the SATL shall terminate the command with CHECK CONDITION status with the sense key set to ILLEGAL REQUEST and the additional sense code set to INVALID FIELD IN PARAMETER LIST.		

 Remove footnote a from table 67, already stated in 10.1.2

Status

rlsheffi Completed

6/23/2006 12:56:45 PM

Table 67 — Caching mode page fields (part 2 of 2)

Field	changeable	Description or reference
LBCSS	no	Set to 0b. A value of 1b is not supported in this standard. ^a
DRA	yes	<p>1) When processing a MODE SENSE command, the SATL shall determine if the ATA device look-ahead is enabled or disabled from the ATA IDENTIFY DEVICE data word 85, bit 6. 2) If the look-ahead is enabled the SATL shall return 0b for the DRA bit. If the look-ahead is disabled the SATL shall return 1b for the DRA bit.</p> <p>When processing a MODE SELECT command,</p> <ul style="list-style-type: none"> a) if the DRA bit is set to zero, the SATL shall enable the ATA device read look-ahead feature by issuing an ATA SET FEATURES – Enable read look-ahead feature command (i.e., send a Command code of EFh with Features register set to AAh); or b) if the DRA bit is set to one, the SATL shall disable the ATA device read look-ahead feature by issuing an ATA SET FEATURES – Disable read look-ahead feature command (i.e., send a Command code of EFh with Features register set to 55h).
NV_DIS	no	3) Set to 0b. A value of 1b is not supported in this standard. ^a
NUMBER OF CACHE SEGMENTS	no	Set to 0h. Any other value is not supported in this standard. ^a
CACHE SEGMENT SIZE	no	Set to 0h. Any other value is not supported in this standard. ^a
^a If the SATL receives a MODE SELECT command with a value other than zero set in this field the SATL shall terminate the command with CHECK CONDITION status with the sense key set to ILLEGAL REQUEST and the additional sense code set to INVALID FIELD IN PARAMETER LIST.		

Sequence number: 1
Author: DELL[KMarks]
Subject: Highlight
Date: 5/6/2006 12:48:30 PM

T Table 67 — Caching mode page fields (part 2 of 2)
Row: DRA
Change

“When processing a MODE SENSE command, the SATL shall determine if the ATA device look-ahead is enabled or disabled from the ATA IDENTIFY DEVICE data word 85, bit 6. If the look-ahead is enabled the SATL shall return 0b for the DRA bit. If the look-ahead is disabled the SATL shall return 1b for the DRA bit.

When processing a MODE SELECT command,

a) if the DRA bit is set to zero, the SATL shall enable the ATA device read look-ahead feature by issuing an ATA SET FEATURES – Enable read look-ahead feature command (i.e., send a Command code of EFh with Features register set to AAh); or

b) if the DRA bit is set to one, the SATL shall disable the ATA device read look-ahead feature by issuing an ATA SET FEATURES – Disable read look-ahead feature command (i.e., send a Command code of EFh with Features register set to 55h).”

to

“When processing a MODE SENSE command, the SATL shall determine if the ATA device look-ahead is enabled from the ATA IDENTIFY DEVICE data word 85, bit 6. If the look-ahead is enabled the SATL shall return a value of zero for the DRA bit. If the look-ahead is disabled the SATL shall return a value of one for the DRA bit.

When processing a MODE SELECT command,

a) if the DRA bit is set to zero, the SATL shall enable the ATA device read look-ahead feature by issuing an ATA SET FEATURES – Enable read look-ahead feature command (i.e., Features register set to AAh); or

b) if the DRA bit is set to one, the SATL shall disable the ATA device read look-ahead feature by issuing an ATA SET FEATURES – Disable read look-ahead feature command (i.e., Features register set to 55h).”

RESOLUTION: s/b

“When processing a MODE SENSE command, the SATL shall determine if the ATA device look-ahead is enabled from the ATA IDENTIFY DEVICE data word 85, bit 6. If the look-ahead is enabled the SATL shall return a value of zero for the DRA bit. If the look-ahead is disabled the SATL shall return a value of one for the DRA bit.

When processing a MODE SELECT command,

a) if the DRA bit is set to zero, the SATL shall enable the ATA device read look-ahead feature by issuing an ATA SET FEATURES – Enable read look-ahead feature command (i.e., with the Features register set to AAh); or

b) if the DRA bit is set to one, the SATL shall disable the ATA device read look-ahead feature by issuing an ATA SET FEATURES – Disable read look-ahead feature command (i.e., with the Features register set to 55h).”

Status
rlsheffi Completed 6/23/2006 1:00:52 PM

Sequence number: 2
Author: IBM[GPenokie]
Subject: Comment on Text
Date: 2/16/2006 10:51:21 AM

T table 67 - row dra
This << If the look-ahead is enabled the SATL shall return 0b for the DRA bit. If the look-ahead is disabled the SATL shall return 1b for the DRA bit. >> should be << If the look-ahead is enabled the SATL shall return zero for the DRA bit. If the look-ahead is disabled the SATL shall return one for the DRA bit. >>

Status
rlsheffi Completed 6/23/2006 1:01:31 PM

Sequence number: 3
Author: IBM[GPenokie]
Subject: Comment on Text

Table 67 — Caching mode page fields (part 2 of 2)

Field	changeable	Description or reference
LBCSS	no	Set to 0b. A value of 1b is not supported in this standard. ^a
DRA	yes	<p>When processing a MODE SENSE command, the SATL shall determine if the ATA device look-ahead is enabled or disabled from the ATA IDENTIFY DEVICE data word 85, bit 6. If the look-ahead is enabled the SATL shall return 0b for the DRA bit. If the look-ahead is disabled the SATL shall return 1b for the DRA bit.</p> <p>When processing a MODE SELECT command,</p> <ul style="list-style-type: none"> a) if the DRA bit is set to zero, the SATL shall enable the ATA device read look-ahead feature by issuing an ATA SET FEATURES – Enable read look-ahead feature command (i.e., send a Command code of EFh with Features register set to AAh); or b) if the DRA bit is set to one, the SATL shall disable the ATA device read look-ahead feature by issuing an ATA SET FEATURES – Disable read look-ahead feature command (i.e., send a Command code of EFh with Features register set to 55h).
NV_DIS	no	Set to 0b. A value of 1b is not supported in this standard. ^a
NUMBER OF CACHE SEGMENTS	no	Set to 0h. Any other value is not supported in this standard. ^a
CACHE SEGMENT SIZE	no	Set to 0h. Any other value is not supported in this standard. ^a
⁴ If the SATL receives a MODE SELECT command with a value other than zero set in this field the SATL shall terminate the command with CHECK CONDITION status with the sense key set to ILLEGAL REQUEST and the additional sense code set to INVALID FIELD IN PARAMETER LIST.		

Date: 6/23/2006 1:02:05 PM

T table 65 - last 3 rows

This << Set to 0h >> should be << Set to zero >>.

RESOLUTION: s/b

"Shall be set to zero"

Status

risheffi Completed

6/23/2006 1:02:08 PM

Sequence number: 4

Author: DELL[KMarks]

Subject: Cross-Out

Date: 6/23/2006 1:02:27 PM

T Remove footnote a from table 67, already stated in 10.1.2

Status

risheffi Completed

6/23/2006 1:02:17 PM

10.1.7 Informational Exceptions Control mode page

10.1.7.1 Informational Exceptions Control mode page overview

The Informational Exceptions Control mode page defines the methods used by the SATL to control the reporting and the operations of specific informational exception conditions. The Informational Exceptions Control mode page applies to informational exceptions that return an additional sense code of FAILURE PREDICTION THRESHOLD EXCEEDED or WARNING to the application client (see SPC-3).

Table 68 shows the translation of fields in the Informational Exceptions Control mode page.

Table 68 — Informational Exceptions Control mode page fields

Field	Changeable	Description or reference ^a
PS	n/a	1 Unspecified (see 3.4.3)
SPF	No	2 Unspecified (see 3.4.3)
PAGE CODE	No	3 Set to 1Ch. This field value is specific to the Informational Exceptions Control mode page. The SATL shall determine if the ATA SMART feature set is supported from the ATA IDENTIFY DEVICE data word 82, bit 0. If the ATA SMART feature set is not supported the SATL shall return CHECK CONDITION status with the sense key set to ILLEGAL REQUEST and the additional sense code set to INVALID FIELD IN CDB.
PAGE LENGTH	No	4 Unspecified (see 3.4.3)
PERF	No	Shall be set to zero (see SPC-3).
EBF	n/a	Unspecified (see 3.4.3)
EWASC	n/a	Unspecified (see 3.4.3)
DEXCPT	Yes	While processing a MODE SENSE command the SATL shall determine if the ATA SMART feature set is enabled or disabled from the ATA device ATA IDENTIFY DEVICE data word 85, bit 0. If the ATA SMART feature set is disabled the SATL shall return one for the DEXCPT bit. If the ATA SMART feature set is enabled the SATL shall return zero for the DEXCPT bit. While processing a MODE SELECT command, if the DEXCPT bit is : a) set to zero, then the SATL shall enable informational exceptions reporting by issuing an ATA SMART ENABLE OPERATIONS command (i.e., B0h with Feature register value of D8h) to the ATA device; or b) set to one, then the SATL shall disable informational exceptions reporting by issuing an ATA SMART DISABLE OPERATIONS command (i.e., B0h with Feature register value of D9h) to the ATA device.
TEST	No	Shall be set to zero (see SPC-3)
LOGERR	n/a	Unspecified (see 3.4.3)
MRIE	No	This field should be set to 6h (see 10.1.7.2).
INTERVAL TIMER	n/a	Unspecified (see 3.4.3)
REPORT COUNT	n/a	Unspecified (see 3.4.3)
^a When the SATL is processing a MODE SELECT command, if bits or fields are set to values other than those specified, the SATL shall terminate the command with CHECK CONDITION status with sense key set to ILLEGAL REQUEST and the additional sense code set to INVALID FIELD IN PARAMETER LIST.		

Sequence number: 1
Author: DELL[KMarks]
Subject: Highlight
Date: 5/6/2006 1:06:09 PM

T Table 68 — Informational Exceptions Control mode page fields
Row: SP

Based on the current text, this shall be zero for MODE SENSE. I think saveable pages should be an options and therefore think Unspecified is correct.

RESOLUTION: SAT does not prohibit saved mode pages, so this remains "Unspecified".

Status
rsheffi Completed 6/23/2006 1:03:15 PM

Sequence number: 2
Author: DELL[KMarks]
Subject: Highlight
Date: 2/9/2006 9:49:26 PM

T Table 68 — Informational Exceptions Control mode page fields
Row: SPF

"Unspecified (see 3.4.3)"

to
"Shall be set to zero"

Status
rsheffi Completed 6/23/2006 1:06:02 PM

Sequence number: 3
Author: DELL[KMarks]
Subject: Highlight
Date: 5/6/2006 1:16:59 PM

T Table 68 — Informational Exceptions Control mode page fields
Row :PAGE CODE
change

"Set to 1Ch. This field value is specific to the Informational Exceptions Control mode page. The SATL shall determine if the ATA SMART feature set is supported from the ATA IDENTIFY DEVICE data word 82, bit 0. If the ATA SMART feature set is not supported the SATL shall return CHECK CONDITION status with the sense key set to ILLEGAL REQUEST and the additional sense code set to INVALID FIELD IN CDB."

to
"Shall be set to 1Ch. The SATL shall determine if the ATA SMART feature set is supported from the ATA IDENTIFY DEVICE data word 82, bit 0. If the ATA SMART feature set is not supported the SATL shall return CHECK CONDITION status with the sense key set to ILLEGAL REQUEST and the additional sense code set to INVALID FIELD IN CDB for a MODE SENSE command or INVALID FIELD IN PARAMETER LIST for a MODE SELECT command."

RESOLUTION: s/b

"Shall be set to 1Ch. The SATL shall determine if the ATA SMART feature set is supported from the ATA IDENTIFY DEVICE data word 82, bit 0. If the ATA SMART feature set is not supported the SATL shall terminate the command with CHECK CONDITION status with the sense key set to ILLEGAL REQUEST and the additional sense code set to INVALID FIELD IN CDB for a MODE SENSE command or INVALID FIELD IN PARAMETER LIST for a MODE SELECT command."

Status
rsheffi Completed 6/23/2006 1:09:35 PM

Sequence number: 4
Author: DELL[KMarks]
Subject: Highlight
Date: 2/9/2006 9:48:39 PM

T Table 68 — Informational Exceptions Control mode page fields
Row: PAGE LENGTH

10.1.7 Informational Exceptions Control mode page

10.1.7.1 Informational Exceptions Control mode page overview

The Informational Exceptions Control mode page defines the methods used by the SATL to control the reporting and the operations of specific informational exception conditions. The Informational Exceptions Control mode page applies to informational exceptions that return an additional sense code of FAILURE PREDICTION THRESHOLD EXCEEDED or WARNING to the application client (see SPC-3).

Table 68 shows the translation of fields in the Informational Exceptions Control mode page.

Table 68 — Informational Exceptions Control mode page fields

Field	Changeable	Description or reference ^a
PS	n/a	Unspecified (see 3.4.3)
SPF	No	Unspecified (see 3.4.3)
PAGE CODE	No	Set to 1Ch. This field value is specific to the Informational Exceptions Control mode page. The SATL shall determine if the ATA SMART feature set is supported from the ATA IDENTIFY DEVICE data word 82, bit 0. If the ATA SMART feature set is not supported the SATL shall return CHECK CONDITION status with the sense key set to ILLEGAL REQUEST and the additional sense code set to INVALID FIELD IN CDB.
PAGE LENGTH	No	Unspecified (see 3.4.3)
PERF	No	Shall be set to zero (see SPC-3).
EBF	n/a	Unspecified (see 3.4.3)
EWASC	n/a	Unspecified (see 3.4.3)
DEXCPT	Yes	<p>While processing a MODE SENSE command the SATL shall determine if the ATA SMART feature set is enabled or disabled from the ATA device ATA IDENTIFY DEVICE data word 85, bit 0. If the ATA SMART feature set is disabled the SATL shall return one for the DEXCPT bit. If the ATA SMART feature set is enabled the SATL shall return zero for the DEXCPT bit.</p> <p>While processing a MODE SELECT command, if the DEXCPT bit is :</p> <ul style="list-style-type: none"> a) set to zero, then the SATL shall enable informational exceptions reporting by issuing an ATA SMART ENABLE OPERATIONS command (i.e., B0h with Feature register value of D8h) to the ATA device; or b) set to one, then the SATL shall disable informational exceptions reporting by issuing an ATA SMART DISABLE OPERATIONS command (i.e., B0h with Feature register value of D9h) to the ATA device.
TEST	No	Shall be set to zero (see SPC-3)
LOGERR	n/a	Unspecified (see 3.4.3)
MRIE	60	This field should be set to 6h (see 10.1.7.2).
INTERVAL TIMER	n/a	Unspecified (see 3.4.3)
REPORT COUNT	n/a	Unspecified (see 3.4.3)
^a When the SATL is processing a MODE SELECT command, if bits or fields are set to values other than those specified, the SATL shall terminate the command with CHECK CONDITION status with sense key set to ILLEGAL REQUEST and the additional sense code set to INVALID FIELD IN PARAMETER LIST.		

“Unspecified (see 3.4.3)”

to

“Shall be set to 0Ah”

Status
rlsheffi Completed 6/23/2006 1:10:13 PM

Sequence number: 5
Author: DELL[KMarks]
Subject: Highlight
Date: 5/11/2006 3:19:16 PM

T Table 68 — Informational Exceptions Control mode page fields
Row :DEXCPT
change

“While processing a MODE SENSE command the SATL shall determine if the ATA SMART feature set is enabled or disabled from the ATA device ATA IDENTIFY DEVICE data word 85, bit 0. If the ATA SMART feature set is disabled the SATL shall return one for the DEXCPT bit. If the ATA SMART feature set is enabled the SATL shall return zero for the DEXCPT bit.

While processing a MODE SELECT command, if the DEXCPT bit is :

- a) set to zero, then the SATL shall enable informational exceptions reporting by issuing an ATA SMART ENABLE OPERATIONS command (i.e., B0h with Feature register value of D8h) to the ATA device; or
- b) set to one, then the SATL shall disable informational exceptions reporting by issuing an ATA SMART DISABLE OPERATIONS command (i.e., B0h with Feature register value of D9h) to the ATA device.”

to

“While processing a MODE SENSE command the SATL shall determine if the ATA SMART feature set is enabled from the ATA device ATA IDENTIFY DEVICE data word 85, bit 0. If the ATA SMART feature set is disabled the SATL shall return a value of one for the DEXCPT bit. If the ATA SMART feature set is enabled the SATL shall return a value of zero for the DEXCPT bit.

While processing a MODE SELECT command, if the DEXCPT bit is :

- a) set to zero, the SATL shall enable informational exceptions reporting by issuing an ATA SMART ENABLE OPERATIONS command (i.e., Feature register value set to D8h) to the ATA device; or
- b) set to one, the SATL shall disable informational exceptions reporting by issuing an ATA SMART DISABLE OPERATIONS command (i.e., Feature register value set to D9h) to the ATA device.”

RESOLUTION: s/b

“Unspecified (see 3.4.3)”

REASON: The DEXCPT bit does not specify what self-test capabilities are enabled, but only specifies the reporting of results. Disabling SMART ops causes a problem with SEND DIAGNOSTIC because the expectation is that if the self-test is supported, the test will be executed independent of whether DEXCPT is zero or one. So the SATL should rely on other information to determine if/when to enable/disable SMART OPS, and should treat the SMART OPS disabled state as “unsupported”. SEND DIAGNOSTIC w/ SELFTEST set to one will terminate with CHECK CONDITION status if SMART OPS is disabled.

Status
rlsheffi Completed 6/15/2006 12:36:46 PM

Sequence number: 6
Author: DELL[KMarks]
Subject: Highlight
Date: 6/23/2006 1:17:58 PM

T Table 68 — Informational Exceptions Control mode page fields
Row :MRIE column: changeable.

Currently set to “No”. Since this is a should be set to 6h, the changeable field needs a footnote, says if other modes besides 6h, are implemented, then it’s changeable.

RESOLUTION: add a table footnote referenced under the Changeable column for the MRIE field as follows:

“The MRIE field should be set to 6h, however if the SATL supports other settings of the MRIE field the SATL should permit the MRIE field to be changeable.”

Comments from page 91 continued on next page

10.1.7 Informational Exceptions Control mode page

10.1.7.1 Informational Exceptions Control mode page overview

The Informational Exceptions Control mode page defines the methods used by the SATL to control the reporting and the operations of specific informational exception conditions. The Informational Exceptions Control mode page applies to informational exceptions that return an additional sense code of FAILURE PREDICTION THRESHOLD EXCEEDED or WARNING to the application client (see SPC-3).

Table 68 shows the translation of fields in the Informational Exceptions Control mode page.

Table 68 — Informational Exceptions Control mode page fields

Field	Changeable	Description or reference ^a
PS	n/a	Unspecified (see 3.4.3)
SPF	No	Unspecified (see 3.4.3)
PAGE CODE	No	Set to 1Ch. This field value is specific to the Informational Exceptions Control mode page. The SATL shall determine if the ATA SMART feature set is supported from the ATA IDENTIFY DEVICE data word 82, bit 0. If the ATA SMART feature set is not supported the SATL shall return CHECK CONDITION status with the sense key set to ILLEGAL REQUEST and the additional sense code set to INVALID FIELD IN CDB.
PAGE LENGTH	No	Unspecified (see 3.4.3)
PERF	No	Shall be set to zero (see SPC-3).
EBF	n/a	Unspecified (see 3.4.3)
EWASC	n/a	Unspecified (see 3.4.3)
DEXCPT	Yes	<p>While processing a MODE SENSE command the SATL shall determine if the ATA SMART feature set is enabled or disabled from the ATA device ATA IDENTIFY DEVICE data word 85, bit 0. If the ATA SMART feature set is disabled the SATL shall return one for the DEXCPT bit. If the ATA SMART feature set is enabled the SATL shall return zero for the DEXCPT bit.</p> <p>While processing a MODE SELECT command, if the DEXCPT bit is :</p> <ul style="list-style-type: none"> a) set to zero, then the SATL shall enable informational exceptions reporting by issuing an ATA SMART ENABLE OPERATIONS command (i.e., B0h with Feature register value of D8h) to the ATA device; or b) set to one, then the SATL shall disable informational exceptions reporting by issuing an ATA SMART DISABLE OPERATIONS command (i.e., B0h with Feature register value of D9h) to the ATA device.
TEST	No	Shall be set to zero (see SPC-3)
LOGERR	n/a	Unspecified (see 3.4.3)
MRIE	No	This field should be set to 6h (see 10.1.7.2).
INTERVAL TIMER	n/a	Unspecified (see 3.4.3)
REPORT COUNT	n/a	Unspecified (see 3.4.3)
 <p><input checked="" type="checkbox"/> When the SATL is processing a MODE SELECT command, if bits or fields are set to values other than those specified, the SATL shall terminate the command with CHECK CONDITION status with sense key set to ILLEGAL REQUEST and the additional sense code set to INVALID FIELD IN PARAMETER LIST.</p> 		

Status
risheffi Completed 6/24/2006 3:45:18 PM

Sequence number: 7
Author: DELL[KMarks]
Subject: Cross-Out
Date: 6/23/2006 1:18:14 PM

 Remove footnote a from table 68, already stated in 10.1.2

Status
risheffi Completed 6/23/2006 1:18:17 PM

10.1.7.2 Method of reporting informational exceptions (MRIE)

The SATL should support 6h. Support for any other value is unspecified (see 3.4.3).

When the MRIE field is set to 6h and the SATL receives a REQUEST SENSE command, the SATL shall issue an ATA SMART RETURN STATUS command to the ATA device and return status to the application client as defined in SPC-3. If the result of the ATA SMART RETURN STATUS command indicates a threshold exceeded condition the SATL shall set the additional sense code to HARDWARE IMPENDING FAILURE GENERAL HARD DRIVE FAILURE.

10.2 Log Pages

10.2.1 Log pages overview

Log parameters for which this standard defines translations are listed in table 69.

Table 69 — Summary of SCSI / ATA log page mapping

SCSI log page	Reference
Supported Log Pages (i.e., page code 5h)	10.2.5
Self-Test Results (i.e., page code 06h)	10.2.4
Informational Exceptions (i.e., page code 2Fh)	10.2.3
All others	Unspecified (see 3.4.3)

10.2.2 Retrieving SMART data from targets

An application client should use the LOG SENSE command (see 8.2) to retrieve 512 byte unaltered SMART data from ATA devices. The page head shall not be appended to SMART data. The transfer length is specified using the ALLOCATION LENGTH field in the LOG SENSE CDB.

Additional ATA SMART functions may be accessed using the ATA PASS THROUGH command (see 12.2).

10.2.3 Informational Exceptions log page

The Informational Exceptions log page provides detail about informational exceptions. Table 70 shows the log page header fields.

Table 70 — Informational Exceptions log page header fields

Field	Description or reference
PAGE CODE	Unspecified (see 3.4.3)
PAGE LENGTH	Unspecified (see 3.4.3)

Page: 92

Sequence number: 1
Author: HPQ[WBellamy]
Subject: Note
Date: 5/6/2006 1:25:11 PM



Status
rsheffi Cancelled 5/6/2006 1:25:19 PM

Sequence number: 2
Author: HPQ[WBellamy]
Subject: Highlight
Date: 5/6/2006 1:30:13 PM

T This seems incomplete as stated. May I suggest that a reference link be added here to reference 10.2.3.1, (i. e., "(see 10.2.3.1)"). This should clarify the "how is this actually done?" since that section provides the detail for this same situation.

RESOLUTION:

change

"... and return status to the application client as defined in SPC-3."

to

"... and return status to the application client as defined in SPC-3 (see 10.2.3.1)."

Status
rsheffi Completed 6/23/2006 2:01:19 PM

Sequence number: 3
Author: HPQ[RElliott]
Subject: Highlight
Date: 1/19/2006 9:33:30 AM

T 10.2

Pages s/b lowercase

Status
rsheffi Completed 6/23/2006 2:02:53 PM

Sequence number: 4
Author: DELL[KMarks]
Subject: Highlight
Date: 5/6/2006 1:45:23 PM

T **10.2.1 Log pages overview**
1st Sentence
change

"Log parameters for which this standard defines translations are listed in table 69."

to

"Log pages for which this standard defines translations are listed in table 69."

RESOLUTION: s/b

"This standard defines translations for the log pages listed in table 69."

Status
rsheffi Completed 6/23/2006 2:03:43 PM

Sequence number: 5
Author: HPQ[WBellamy]
Subject: Note
Date: 5/6/2006 1:46:03 PM



Status
rsheffi Cancelled 5/6/2006 1:46:19 PM

Sequence number: 6
Author: HPQ[WBellamy]
Subject: Highlight
Date: 2/17/2006 12:46:51 PM

Comments from page 92 continued on next page

10.1.7.2 Method of reporting informational exceptions (MRIE)

The SATL should support 6h. Support for any other value is unspecified (see 3.4.3).

When the MRIE field is set to 6h and the SATL receives a REQUEST SENSE command, the SATL shall issue an ATA SMART RETURN STATUS command to the ATA device and return status to the application client as defined in SPC-3. If the result of the ATA SMART RETURN STATUS command indicates a threshold exceeded condition the SATL shall set the additional sense code to HARDWARE IMPENDING FAILURE GENERAL HARD DRIVE FAILURE.

10.2 Log Pages

10.2.1 Log pages overview

Log parameters for which this standard defines translations are listed in table 69.

Table 69 — Summary of SCSI / ATA log page mapping

SCSI log page	Reference
Supported Log Pages (i.e., page code 90h)	10.2.5
Self-Test Results (i.e., page code 71h)	10.2.4
Informational Exceptions (i.e., page code 2Fh)	10.2.3
All others	Unspecified (see 3.4.3)

10.2.2 Retrieving SMART data from targets

An application client should use the LOG SENSE command (see 8.2) to retrieve 512 byte unaltered SMART data from ATA devices. The page head shall not be appended to SMART data. The transfer length is specified using the ALLOCATION LENGTH field in the LOG SENSE CDB.

Additional ATA SMART functions may be accessed using the ATA PASS THROUGH command (see 12.2).

10.2.3 Informational Exceptions log page

The Informational Exceptions log page provides detail about informational exceptions. Table 70 shows the log page header fields.

Table 70 — Informational Exceptions log page header fields

Field	Description or reference
PAGE CODE	Unspecified (see 3.4.3)
PAGE LENGTH	Unspecified (see 3.4.3)



Status
rlsheffi Cancelled 5/6/2006 1:46:24 PM

Sequence number: 7
Author: HPQ[WBellamy]
Subject: Highlight
Date: 5/6/2006 1:46:09 PM



supposed to be (10h)

Status
rlsheffi Completed 6/23/2006 2:04:26 PM

Sequence number: 8
Author: HPQ[WBellamy]
Subject: Note
Date: 5/6/2006 1:49:40 PM



This clause information is incorrect. There is currently no (T10 SPC -3 or SBC-2) SCSI log page accessed by the LOG SENSE command that will provide 512 bytes of log data. It just was never standardized. An ATA PASS-THROUGH command is the only way to get 512 bytes of ATA SMART data. PLEASE change this, move this, or remove this.

RESOLUTION: See EDITOR comment (delete subclause 10.2.2)

Status
rlsheffi Completed 6/23/2006 2:08:55 PM

Sequence number: 9
Author: HPQ[WBellamy]
Subject: Note
Date: 5/6/2006 1:49:47 PM



change "targets" to "ATA devices".

RESOLUTION: See EDITOR comment (delete subclause 10.2.2)

Status
rlsheffi Completed 6/23/2006 2:08:56 PM

Sequence number: 10
Author: HPQ[WBellamy]
Subject: Note
Date: 5/6/2006 1:49:56 PM



Please add "ATA" between "Retrieving" and "SMART" (if this clause is specific to ATA SMART data, not SCSI SMART data).

RESOLUTION: See EDITOR comment (delete subclause 10.2.2)

Status
rlsheffi Completed 6/23/2006 2:08:56 PM

Sequence number: 11
Author: EDITOR[rlsheffi]
Subject: Cross-Out
Date: 4/24/2006 11:05:52 AM



RESOLUTION: Fix all of these comments by deleting 10.2.2 Retrieving SMART data from targets

Status
rlsheffi Completed 6/23/2006 2:08:55 PM

Sequence number: 12
Author: HPQ[WBellamy]
Subject: Highlight
Date: 5/6/2006 1:50:04 PM



RESOLUTION: See EDITOR comment (delete subclause 10.2.2)

Status
rlsheffi Completed 6/23/2006 2:08:55 PM

Sequence number: 13
Author: HPQ[WBellamy]
Subject: Note
Date: 5/6/2006 1:50:09 PM



ATA PASS-THROUGH

RESOLUTION: See EDITOR comment (delete subclause 10.2.2)

Status

Comments from page 92 continued on next page

10.1.7.2 Method of reporting informational exceptions (MRIE)

The SATL should support 6h. Support for any other value is unspecified (see 3.4.3).

When the MRIE field is set to 6h and the SATL receives a REQUEST SENSE command, the SATL shall issue an ATA SMART RETURN STATUS command to the ATA device and return status to the application client as defined in SPC-3. If the result of the ATA SMART RETURN STATUS command indicates a threshold exceeded condition the SATL shall set the additional sense code to HARDWARE IMPENDING FAILURE GENERAL HARD DRIVE FAILURE.

10.2 Log Pages

10.2.1 Log pages overview

Log parameters for which this standard defines translations are listed in table 69.

Table 69 — Summary of SCSI / ATA log page mapping

SCSI log page	Reference
Supported Log Pages (i.e., page code 90h)	10.2.5
Self-Test Results (i.e., page code 01h)	10.2.4
Informational Exceptions (i.e., page code 2Fh)	10.2.3
All others	Unspecified (see 3.4.3)

10.2.2 Retrieving SMART data from targets

application client should use the LOG SENSE command (see 8.2) to retrieve 2 byte unaltered SMART data from ATA devices. The page header shall not be appended to SMART data. The transfer length is specified using the ALLOCATION LENGTH field in the LOG SENSE CDB.

Additional ATA SMART functions may be accessed using the ATA PASS THROUGH command (see 12.2).

10.2.3 Informational Exceptions log page

The Informational Exceptions log page provides detail about informational exceptions. Table 70 shows the log page header fields.

Table 70 — Informational Exceptions log page header fields

Field	Description or reference
PAGE CODE	Unspecified (see 3.4.3)
PAGE LENGTH	Unspecified (see 3.4.3)

risheffi Completed 6/23/2006 2:08:56 PM

Sequence number: 14
Author: HPQ[WBellamy]
Subject: Cross-Out
Date: 5/6/2006 1:50:17 PM
 RESOLUTION: See EDITOR comment (delete subclause 10.2.2)

Status
risheffi Completed 6/23/2006 2:08:55 PM

Sequence number: 15
Author: ENDL[RWeber]
Date: 5/6/2006 1:50:22 PM
 p 1, s 1
T RE: "An application client should use the LOG SENSE command (see 8.2) to retrieve 512 byte unaltered SMART data from ATA devices." What values are required in the PAGE CODE, PC, PPC, and PARAMETER POINTER fields of this LOG SENSE command?

RESOLUTION: See EDITOR comment (delete subclause 10.2.2)

Status
risheffi Completed 6/23/2006 2:08:54 PM

Sequence number: 16
Author: MXO[MEvans]
Subject: Highlight
Date: 5/6/2006 1:50:25 PM
 10.2.2 Retrieving SMART data from targets: change, "...512 byte unaltered SMART data..." to "...the 512-byte Device SMART data structure..."

RESOLUTION: See EDITOR comment (delete subclause 10.2.2)

Status
risheffi Completed 6/23/2006 2:08:56 PM

Sequence number: 17
Author: HPQ[WBellamy]
Subject: Note
Date: 5/6/2006 1:48:46 PM
 add "SCSI log" so as to read "The SCSI log page header shall not be appended"

RESOLUTION: See EDITOR comment (delete subclause 10.2.2)

Status
risheffi Completed 6/23/2006 2:08:55 PM

Sequence number: 18
Author: HPQ[WBellamy]
Subject: Cross-Out
Date: 5/6/2006 1:48:50 PM
 RESOLUTION: See EDITOR comment (delete subclause 10.2.2)

Status
risheffi Completed 6/23/2006 2:08:54 PM

Sequence number: 19
Author: QDSS[PSuhler]
Subject: Highlight
Date: 5/6/2006 1:48:56 PM
 Page: 92
10.2.2
Editorial/Technical
"The page header shall not be appended to SMART data." This seems to violate the usual LOG SENSE operation. Give further explanation or change behavior.

RESOLUTION: See EDITOR comment (delete subclause 10.2.2)

Status
risheffi Completed 6/23/2006 2:08:56 PM

Sequence number: 20
Author: ENDL[RWeber]

Comments from page 92 continued on next page

10.1.7.2 Method of reporting informational exceptions (MRIE)

The SATL should support 6h. Support for any other value is unspecified (see 3.4.3).

When the MRIE field is set to 6h and the SATL receives a REQUEST SENSE command, the SATL shall issue an ATA SMART RETURN STATUS command to the ATA device and return status to the application client as defined in SPC-3. If the result of the ATA SMART RETURN STATUS command indicates a threshold exceeded condition the SATL shall set the additional sense code to HARDWARE IMPENDING FAILURE GENERAL HARD DRIVE FAILURE.

10.2 Log Pages

10.2.1 Log pages overview

Log parameters for which this standard defines translations are listed in table 69.

Table 69 — Summary of SCSI / ATA log page mapping

SCSI log page	Reference
Supported Log Pages (i.e., page code 90h)	10.2.5
Self-Test Results (i.e., page code 01h)	10.2.4
Informational Exceptions (i.e., page code 2Fh)	10.2.3
All others	Unspecified (see 3.4.3)

10.2.2 Retrieving SMART data from targets

An application client should use the LOG SENSE command (see 8.2) to retrieve 512 byte unaltered SMART data from ATA devices. The page header is not be appended to SMART data. The transfer length is specified using the ALLOCATION LENGTH field in the LOG SENSE CDB.

Additional ATA SMART functions may be accessed using the ATA PASS THROUGH command (see 12.2).

10.2.3 Informational Exceptions log page

The Informational Exceptions log page provides detail about informational exceptions. Table 70 shows the log page header fields.

Table 70 — Informational Exceptions log page header fields

Field	Description or reference
PAGE CODE	specified (see 3.4.3)
PAGE LENGTH	Unspecified (see 3.4.3)

Date: 5/6/2006 1:49:03 PM

T p 1, s 2

T RE: "The page header shall not be appended to SMART data." SPC-3 states "Each log page begins with a four-byte page header ..." Remove this statement that clearly conflicts with SPC-3, or rephrase it to clarify that the reference is to some ATA page header or another.

RESOLUTION: See EDITOR comment (delete subclause 10.2.2)

Status
rlsheffi Completed 6/23/2006 2:08:55 PM

Sequence number: 21
Author: DELL[KMarks]
Subject: Note
Date: 5/6/2006 1:49:12 PM

 10.2.2 Retrieving SMART data from targets

Not sure what this is trying to say. Issue a LOG SENSE to what page, to get the unaltered SMART data?

RESOLUTION: See EDITOR comment (delete subclause 10.2.2)

Status
rlsheffi Completed 6/23/2006 2:08:54 PM

Sequence number: 22
Author: LSI[OParry]
Subject: Note
Date: 6/23/2006 2:08:12 PM

 10.2.2 Retrieving SMART data from targets

This section states to use the Log Sense command to retrieve SMART Unaltered data from the ATA device.

- 1) There is no specification of what Page Code should be used for this particular request
- 2) Perhaps the text should be removed and replaced with something to the effect that the application client should use the ATA PASS-THROUGH command to retrieve unaltered SMART data.

RESOLUTION: See EDITOR comment (delete subclause 10.2.2)

Status
rlsheffi Completed 6/23/2006 2:08:55 PM

Sequence number: 23
Author: HPQ[WBellamy]
Subject: Note
Date: 5/6/2006 1:54:12 PM



Status
rlsheffi Cancelled 5/6/2006 1:54:53 PM

Sequence number: 24
Author: HPQ[WBellamy]
Subject: Cross-Out
Date: 5/6/2006 1:54:37 PM



Status
rlsheffi Cancelled 5/6/2006 1:54:47 PM

Sequence number: 25
Author: DELL[KMarks]
Subject: Highlight
Date: 5/6/2006 2:49:01 PM

 **Table 70 — Informational Exceptions log page header fields**
Row: PAGE CODE

“Unspecified (see 3.4.3)”

to

“Shall be set to 2Fh.”

RESOLUTION: see HPQ comment

Status

Comments from page 92 continued on next page

10.1.7.2 Method of reporting informational exceptions (MRIE)

The SATL should support 6h. Support for any other value is unspecified (see 3.4.3).

When the MRIE field is set to 6h and the SATL receives a REQUEST SENSE command, the SATL shall issue an ATA SMART RETURN STATUS command to the ATA device and return status to the application client as defined in SPC-3. If the result of the ATA SMART RETURN STATUS command indicates a threshold exceeded condition the SATL shall set the additional sense code to HARDWARE IMPENDING FAILURE GENERAL HARD DRIVE FAILURE.

10.2 Log Pages

10.2.1 Log pages overview

Log parameters for which this standard defines translations are listed in table 69.

Table 69 — Summary of SCSI / ATA log page mapping

SCSI log page	Reference
Supported Log Pages (i.e., page code 90h)	10.2.5
Self-Test Results (i.e., page code 01h)	10.2.4
Informational Exceptions (i.e., page code 2Fh)	10.2.3
All others	Unspecified (see 3.4.3)

10.2.2 Retrieving SMART data from targets

An application client should use the LOG SENSE command (see 8.2) to retrieve 512 byte unaltered SMART data from ATA devices. The page header shall not be appended to SMART data. The transfer length is specified using the ALLOCATION LENGTH field in the LOG SENSE CDB.

Additional ATA SMART functions may be accessed using the ATA PASS THROUGH command (see 12.2).

10.2.3 Informational Exceptions log page

The Informational Exceptions log page provides detail about informational exceptions. Table 70 shows the log page header fields.

Table 70 — Informational Exceptions log page header fields

Field	Description or reference
PAGE CODE	26 specified (see 3.4.3)
PAGE LENGTH	Unspecified (see 3.4.3)

Sequence number: 26

Author: HPQ[WBellamy]

Subject: Highlight

Date: 6/23/2006 2:14:59 PM

T This is incorrect and not per 05-142r4. How could the PAGE CODE field be unspecified? Please apply the information from proposal 05-142r4 here. (Note the example of the Self-Test Results log page in 10.2.4.1.)

DISCUSS proposed resolution (restoring text from 05-142r4):

change

“Unspecified (see 3.4.3)”

to

“Shall be set to 2Fh. This field value is specific to the Informational Exceptions log page. The SATL shall issue the ATA SMART RETURN STATUS command to the non-packet device. Data returned from the non-packet device shall be translated into the appropriate log sense parameter data (see 10.2.1.1) to be returned to the application client.”

RESOLUTION: as suggested, except reference is, "(see 10.2.2.2)".

Status

rlsheffi Completed

6/23/2006 2:15:05 PM

The first log parameter is the informational exceptions general parameter shown in table 71.

Table 71 — Informational Exceptions general parameter data

Field	Description or reference
PARAMETER CODE	4 Unspecified (see 3.4.3)
DU	Unspecified (see 3.4.3)
DS	Unspecified (see 3.4.3)
TSD	Unspecified (see 3.4.3)
ETC	Unspecified (see 3.4.3)
TMC	5 Shall be set to 00b.
LBIN	Unspecified (see 3.4.3)
LP	Unspecified (see 3.4.3)
PARAMETER LENGTH	Unspecified (see 3.4.3)
INFORMATIONAL EXCEPTION ADDITIONAL SENSE CODE	10.2.3.1
INFORMATIONAL EXCEPTION ADDITIONAL SENSE CODE QUALIFIER	10.2.3.1
MOST RECENT TEMPERATURE READING	10.2.3.2
Vendor Specific	Unspecified (see 3.4.3)

10.2.3.1 Additional sense code and additional sense code qualifier translations

Data received from a ATA device in response to an ATA SMART RETURN STATUS command shall be translated by the SATL into the informational exceptions general parameter data returned to the application client. Table 72 provides the parameter data translations for the INFORMATIONAL EXCEPTION ADDITIONAL SENSE CODE and INFORMATIONAL EXCEPTION ADDITIONAL SENSE CODE QUALIFIER fields.

Table 72 — ATA SMART RETURN STATUS translations

Data returned to SATL from the ATA device by the ATA SMART RETURN STATUS command	SMART condition	Informational exceptions general parameter data fields
LBA Mid = 4Fh LBA High = C2h	threshold not exceeded	INFORMATIONAL EXCEPTION ADDITIONAL SENSE CODE = 00h, INFORMATIONAL EXCEPTION ADDITIONAL SENSE CODE QUALIFIER = 00h
LBA Mid = F4h LBA High = 2Ch	threshold exceeded	INFORMATIONAL EXCEPTION ADDITIONAL SENSE CODE = 5Dh, INFORMATIONAL EXCEPTION ADDITIONAL SENSE CODE QUALIFIER = 10h

10.2.3.2 Most recent temperature reading translation

If the ATA device supports the SCT Feature Set (see SCT), the MOST RECENT TEMPERATURE READING field of the Informational Exceptions log page should be translated by the SATL as follows:

- 1) Issue an SCT Status Request to the ATA device;
- 2) If the HDA Temp field (see SCT) is less than zero, the SATL shall set the MOST RECENT TEMPERATURE READING field to zero;

Sequence number: 1
Author: HPQ[WBellamy]
Subject: Note
Date: 5/6/2006 2:41:09 PM



Status
rsheffi Cancelled 5/6/2006 2:41:18 PM

Sequence number: 2
Author: HPQ[WBellamy]
Subject: Cross-Out
Date: 2/20/2006 9:31:01 AM



Status
rsheffi Cancelled 5/6/2006 2:40:50 PM

Sequence number: 3
Author: DELL[KMarks]
Subject: Highlight
Date: 5/6/2006 2:55:01 PM



Table 71 — Informational Exceptions general parameter data
Row: PARAMETER CODE
change
“Unspecified (see 3.4.3)”
to
“A log parameter with a PARAMETER CODE field set to 0000h shall be returned. A parameter code values other than 0000h may be returned and are vendor-specific.”
RESOLUTION: see HPQ comment

Status
rsheffi Completed 6/23/2006 2:17:06 PM

Sequence number: 4
Author: HPQ[WBellamy]
Subject: Highlight
Date: 5/6/2006 3:05:00 PM



If you are defining the "general parameter data", SPC-3 defines this as always "0000h". If you use "unspecified" here you must change the table name and the statement above this table (which I don't think you can do since this is specific to the "first" parameter of the informational exceptions log page). See proposal 05-142r4. Furthermore, our applications will fail this out if the value is not "0000h".

RESOLUTION: s/b
"Shall be set to 0000h."

Note: The change from what was in 05-142r4 was made in an editing session. SPC-3's requirement that the value be 0000h is precisely why it was changed to "Unspecified" in SAT-r08 (i.e., meaning SAT doesn't specify it, another standard does, so go look at SPC-3 or SBC-2). There is a general rule of thumb to avoid having the same definitions duplicated between different standards documents. Every instance is a potential oversight if one of the standards changes the definition - requiring all other documents with duplicate definitions to be modified as well for consistency. There is also the potential for editors to make mistakes in copying definitions, which results in inconsistency between standards and actually promotes non-interoperable behavior. However, in the interest of getting through letter-ballot, the editor is willing to include the duplicate definition in this case.

Status
rsheffi Completed 6/23/2006 2:16:51 PM

Sequence number: 5
Author: DELL[KMarks]
Subject: Note
Date: 5/6/2006 3:09:41 PM



Table 71 — Informational Exceptions general parameter data
Row: Control bits

change them to: "Shall be set to ..."

The first log parameter is the informational exceptions general parameter shown in table 71.

Table 71 — Informational Exceptions general parameter data

Field	Description or reference
PARAMETER CODE	Unspecified (see 3.4.3)
DU	Unspecified (see 3.4.3)
DS	Unspecified (see 3.4.3)
TSD	Unspecified (see 3.4.3)
ETC	Unspecified (see 3.4.3)
TMC	Shall be set to 00b.
LBIN	Unspecified (see 3.4.3)
LP	Unspecified (see 3.4.3)
PARAMETER LENGTH	Unspecified (see 3.4.3)
INFORMATIONAL EXCEPTION ADDITIONAL SENSE CODE	10.2.3.1
INFORMATIONAL EXCEPTION ADDITIONAL SENSE CODE QUALIFIER	10.2.3.1
MOST RECENT TEMPERATURE READING	10.2.3.2
Vendor Specific	Unspecified (see 3.4.3)

10.2.3.1 Additional sense code and additional sense code qualifier translations

Data received from a ATA device in response to an ATA SMART RETURN STATUS command shall be translated by the SATL into the informational exceptions general parameter data returned to the application client. Table 72 provides the parameter data translations for the INFORMATIONAL EXCEPTION ADDITIONAL SENSE CODE and INFORMATIONAL EXCEPTION ADDITIONAL SENSE CODE QUALIFIER fields.

Table 72 — ATA SMART RETURN STATUS translations

Data returned to SATL from the ATA device by the ATA SMART RETURN STATUS command	SMART condition	Informational exceptions general parameter data fields
LBA Mid = 4Fh LBA High = C2h	threshold not exceeded	INFORMATIONAL EXCEPTION ADDITIONAL SENSE CODE = 00h, INFORMATIONAL EXCEPTION ADDITIONAL SENSE CODE QUALIFIER = 00h
LBA Mid = F4h LBA High = 2Ch	threshold exceeded	INFORMATIONAL EXCEPTION ADDITIONAL SENSE CODE = 5Dh, INFORMATIONAL EXCEPTION ADDITIONAL SENSE CODE QUALIFIER = 10h

10.2.3.2 Most recent temperature reading translation

If the ATA device supports the SCT Feature Set (see SCT), the MOST RECENT TEMPERATURE READING field of the Informational Exceptions log page should be translated by the SATL as follows:

- 1) Issue an SCT Status Request to the ATA device;
- 2) If the HDA Temp field (see SCT) is less than zero, the SATL shall set the MOST RECENT TEMPERATURE READING field to zero;

DU - zero
DS - zero
TSD - zero
ETC - zero
TMC - 00b
LBIN - one
LP - one

RESOLUTION: s/b

" DU Shall be set to zero.
DS Shall be set to zero.
TSD Shall be set to zero.
ETC Shall be set to zero.
TMC Shall be set to zero.
LBIN Shall be set to one.
LP Shall be set to one."

Status
risheffi Completed 6/23/2006 2:21:57 PM

Sequence number: 6
Author: IBM[GPenokie]
Subject: Underline
Date: 2/16/2006 1:43:18 PM
T 10.2.3.1 Additional sense code and additional sense code qualifier translations

Status
risheffi Cancelled 5/6/2006 3:10:03 PM

Sequence number: 7
Author: IBM[GPenokie]
Subject: Comment on Text
Date: 5/6/2006 3:11:55 PM
T 1st paragraph
This << for the INFORMATIONAL EXCEPTION ADDITIONAL SENSE CODE and INFORMATIONAL EXCEPTION ADDITIONAL SENSE CODE QUALIFIER fields. >> should be << for the INFORMATIONAL EXCEPTION ADDITIONAL SENSE CODE field and INFORMATIONAL EXCEPTION ADDITIONAL SENSE CODE QUALIFIER field. >>
RESOLUTION: s/b (adding 'the')
<< for the INFORMATIONAL EXCEPTION ADDITIONAL SENSE CODE field and the INFORMATIONAL EXCEPTION ADDITIONAL SENSE CODE QUALIFIER field. >>

Status
risheffi Completed 6/23/2006 3:12:25 PM

Sequence number: 8
Author: EDITOR[risheffi]
Subject: Rectangle
Date: 6/23/2006 3:18:21 PM
 First paragraph, including ordered list items 1 through 4
Replace all the text in subclause 10.2.3.2 with:
"If the ATA device supports the SCT Feature Set (see SCT), then to translate the MOST RECENT TEMPERATURE READING field of the Informational Exceptions log page, the SATL shall Issue an SCT Status Request to the ATA device; and then:
a) If the HDA Temp field (see SCT) is less than zero, the SATL shall set the MOST RECENT TEMPERATURE READING field to zero;
b) If the HDA Temp field is equal to 80h, the SATL shall set the MOST RECENT TEMPERATURE READING field to FFh; or
c) The SATL shall set the MOST RECENT TEMPERATURE READING field to the value in the HDA Temp field.

If the ATA device does not support the SCT feature set, then the SATL shall set the MOST RECENT TEMPERATURE READING field to FFh.

Status
risheffi Completed 6/23/2006 3:19:12 PM

Sequence number: 9
Author: HPQ[WBellamy]
Subject: Highlight
Date: 5/6/2006 3:29:34 PM
T RESOLUTION: See EDITOR comment

The first log parameter is the informational exceptions general parameter shown in table 71.

Table 71 — Informational Exceptions general parameter data

Field	Description or reference
PARAMETER CODE	Unspecified (see 3.4.3)
DU	Unspecified (see 3.4.3)
DS	Unspecified (see 3.4.3)
TSD	Unspecified (see 3.4.3)
ETC	Unspecified (see 3.4.3)
TMC	Shall be set to 00b.
LBIN	Unspecified (see 3.4.3)
LP	Unspecified (see 3.4.3)
PARAMETER LENGTH	Unspecified (see 3.4.3)
INFORMATIONAL EXCEPTION ADDITIONAL SENSE CODE	10.2.3.1
INFORMATIONAL EXCEPTION ADDITIONAL SENSE CODE QUALIFIER	10.2.3.1
MOST RECENT TEMPERATURE READING	10.2.3.2
Vendor Specific	Unspecified (see 3.4.3)

10.2.3.1 Additional sense code and additional sense code qualifier translations

Data received from a ATA device in response to an ATA SMART RETURN STATUS command shall be translated by the SATL into the informational exceptions general parameter data returned to the application client. Table 72 provides the parameter data translations for the INFORMATIONAL EXCEPTION ADDITIONAL SENSE CODE and INFORMATIONAL EXCEPTION ADDITIONAL SENSE CODE QUALIFIER fields.

Table 72 — ATA SMART RETURN STATUS translations

Data returned to SATL from the ATA device by the ATA SMART RETURN STATUS command	SMART condition	Informational exceptions general parameter data fields
LBA Mid = 4Fh LBA High = C2h	threshold not exceeded	INFORMATIONAL EXCEPTION ADDITIONAL SENSE CODE = 00h, INFORMATIONAL EXCEPTION ADDITIONAL SENSE CODE QUALIFIER = 00h
LBA Mid = F4h LBA High = 2Ch	threshold exceeded	INFORMATIONAL EXCEPTION ADDITIONAL SENSE CODE = 5Dh, INFORMATIONAL EXCEPTION ADDITIONAL SENSE CODE QUALIFIER = 10h

10.2.3.2 Most recent temperature reading translation

If the ATA device supports the SCT Feature Set (see SCT), the MOST RECENT TEMPERATURE READING field of the Informational Exceptions log page should be translated by the SATL as follows:

- 1) Issue an SCT Status Request to the ATA device;
- 2) If the HDA Temp field (see SCT) is less than zero, the SATL shall set the MOST RECENT TEMPERATURE READING field to zero;

Status
risheffi Completed

6/23/2006 3:19:21 PM

- 3) ² the HDA Temp field is equal to 80h the SATL shall set the MOST RECENT TEMPERATURE READING field to FFh; and
- 4) ³ otherwise the SATL shall set the MOST RECENT TEMPERATURE READING FIELD to the value in the HDA Temp field.

If the ATA device does not support the SCT⁴ Feature Set, then the SATL shall set the MOST RECENT TEMPERATURE READING field to FFh.

10.2.4 Self-Test Results log page

10.2.4.1 Self-Test Results log page overview

The Self-Test Results log page provides the results from the most recent self-tests. Table 73 shows the Self-Test Results log page header fields.

Table 73 — Self-Test Results log page fields

Field	Description or reference
PAGE CODE	⁷ Set to 10h. This field value is specific to the Self-Test Results log page.
PAGE LENGTH	See SPC-3

Translations of the fields for the Self-Test Results log parameters for the Self-Test Results log page are shown in Table 74.

Table 74 — Self-Test Results log parameters (part 1 of 2)

Field	Description or reference
PARAMETER CODE	Unspecified (see 3.4.3)
DU	Unspecified (see 3.4.3)
DS	Unspecified (see 3.4.3)
TSD	Unspecified (see 3.4.3)
ET ⁸	Unspecified (see 3.4.3)
TMC	Shall be set to 00b.
LBIN	Unspecified (see 3.4.3)
LP	Unspecified (see 3.4.3)
PARAMETER LENGTH	Unspecified (see 3.4.3)
SELF-TEST CODE	Unspecified (see 3.4.3)
SELF-TEST RESULTS	<p>The SATL shall read the ATA log data as defined in 10.2.4.2.</p> <p>If the SATL reads the ATA log data using the READ LOG EXT command specifying the Extended SMART self-test log, then the SATL shall set the SELF-TEST RESULTS field to the value in the Self-test Execution Status bits from the Content of the self-test execution status byte (i.e., byte n + 1 of the Extended Self-test log descriptor entry) (see ATA/ATAPI-7).</p> <p>If the SATL reads the ATA log data using the SMART READ LOG command specifying the SMART self-test log, then the SATL shall set the SELF-TEST RESULTS field to the value in the Content of the self-test execution status byte (i.e., byte n + 1 of the Self-test log descriptor entry) for the Self-test execution status bits.</p>
SELF-TEST NUMBER	Unspecified (see 3.4.3)

Sequence number: 1
Author: HPQ[WBellamy]
Subject: Note
Date: 5/6/2006 3:29:49 PM

 This verbiage seems incorrect to me as stated. In other words, it seems better stated if statement 2 ends with "or". Statement 3 should end with "otherwise". Statement 4 should start with "The SATL shall set...."

RESOLUTION: See EDITOR comment

Status
risheffi Completed 6/23/2006 3:19:32 PM

Sequence number: 2
Author: HPQ[WBellamy]
Subject: Highlight
Date: 5/6/2006 3:30:05 PM

 RESOLUTION: See EDITOR comment

Status
risheffi Completed 6/23/2006 3:19:41 PM

Sequence number: 3
Author: HPQ[WBellamy]
Subject: Highlight
Date: 5/6/2006 3:30:15 PM

 RESOLUTION: See EDITOR comment

Status
risheffi Completed 6/23/2006 3:19:48 PM

Sequence number: 4
Author: HPQ[RElliott]
Date: 5/6/2006 3:31:06 PM

 10.2.3.2

Feature Set s/b feature set

RESOLUTION: See EDITOR comment

Status
risheffi Completed 6/23/2006 3:20:12 PM

Sequence number: 5
Author: IBM[GPenokie]
Subject: Underline
Date: 2/16/2006 1:41:27 PM

 10.2.4.1 Self-Test Results log page overview

Status
risheffi Cancelled 5/6/2006 3:32:03 PM

Sequence number: 6
Author: EDITOR[risheffi]
Subject: Highlight
Date: 8/28/2006 3:37:26 PM

 Change:

"The Self-Test Results log page provides the results from the most recent self-tests."

to

"The Self-Test Results log page provides the results from self-test results descriptor entry pointed to by the Self-test descriptor index."

Status
risheffi Completed 8/29/2006 4:39:02 PM

Sequence number: 7
Author: DELL[KMarks]
Subject: Highlight
Date: 2/10/2006 1:22:26 PM

 **Table 73 — Self-Test Results log page fields**
Row: PAGE CODE

- 3) If the HDA Temp field is equal to 80h the SATL shall set the MOST RECENT TEMPERATURE READING field to FFh; and
- 4) Otherwise the SATL shall set the MOST RECENT TEMPERATURE READING FIELD to the value in the HDA Temp field.

If the ATA device does not support the SCT Feature Set, then the SATL shall set the MOST RECENT TEMPERATURE READING field to FFh.

10.2.4 Self-Test Results log page

10.2.4.1 Self-Test Results log page overview

The Self-Test Results log page provides the results from the most recent self-tests. Table 73 shows the Self-Test Results log page header fields.

Table 73 — Self-Test Results log page fields

Field	Description or reference
PAGE CODE	Set to 10h. This field value is specific to the Self-Test Results log page.
PAGE LENGTH	8 See SPC-3

Translations of the fields for the Self-Test Results log parameters for the Self-Test Results log page are shown in Table 74.

Table 74 — Self-Test Results log parameters (part 1 of 2)

Field	Description or reference ¹⁰
PARAMETER CODE	¹¹ specified (see 3.4.3)
DU	Unspecified (see 3.4.3)
DS	Unspecified (see 3.4.3)
TSD	Unspecified (see 3.4.3)
ET ¹²	Unspecified (see 3.4.3)
TMC	Shall be set to 00b.
LBIN	Unspecified (see 3.4.3)
LP	Unspecified (see 3.4.3)
PARAMETER LENGTH	Unspecified (see 3.4.3)
SELF-TEST CODE	Unspecified (see 3.4.3)
SELF-TEST RESULTS	<p>The SATL shall read the ATA log data as defined in 10.2.4.2.</p> <p>If the SATL reads the ATA log data using the READ LOG EXT command specifying the Extended SMART self-test log, then the SATL shall set the SELF-TEST RESULTS field to the value in the Self-test Execution Status bits from the Content of the self-test execution status byte (i.e., byte n + 1 of the Extended Self-test log descriptor entry) (see ATA/ATAPI-7).</p> <p>If the SATL reads the ATA log data using the SMART READ LOG command specifying the SMART self-test log, then the SATL shall set the SELF-TEST RESULTS field to the value in the Content of the self-test execution status byte (i.e., byte n + 1 of the Self-test log descriptor entry) for the Self-test execution status bits.</p>
SELF-TEST NUMBER	Unspecified (see 3.4.3)

change

"Set to 10h. This field value is specific to the Self-Test Results log page."

to

"Shall be set to 10h."

Status
rlsheffi Completed 6/23/2006 3:22:24 PM

Sequence number: 8
Author: DELL[KMarks]
Subject: Highlight
Date: 2/10/2006 1:23:37 PM

 **Table 73 — Self-Test Results log page fields**

Row: PAGE LENGTH

Change

"See SPC-3"

to

"Unspecified (see 3.4.3)"

Status
rlsheffi Completed 6/23/2006 3:22:48 PM

Sequence number: 9
Author: IBM[GPenokie]
Subject: Oval
Date: 2/16/2006 8:51:00 AM

 Global

The capitalization of the references to tables is inconsistent. It should only be capitalized when it is the first word of a sentence.

Status
rlsheffi Completed 6/23/2006 3:23:11 PM

Sequence number: 10
Author: DELL[KMarks]
Subject: Note
Date: 8/28/2006 3:53:42 PM

 **Table 74 — Self-Test Results log parameters (part 1 of 2)**

The translation of this log page looks incomplete in terms of mapping the self-test index/descriptor index to the PARAMETER CODE field, and the byte n + 1. This then makes the text in the SELF-TEST RESULTS, TIMESTAMP, and ADDRESS OF FIRST FAILURE translations confusing as there is no indication of which descriptor these values are coming from.

If the PARAMETER CODE is used to indicate the descriptor then with limited word changes, these fields would make sense.

RESOLUTION: See EDITOR's comments on the descriptions of the PARAMETER CODE field and the SELF-TEST RESULTS field.

Status
rlsheffi Completed 8/29/2006 4:42:47 PM

Sequence number: 11
Author: EDITOR[rlsheffi]
Subject: Highlight
Date: 8/28/2006 3:40:12 PM

 s/b

"Shall be set to n where the parameter returned corresponds to the nth Self-test descriptor relative to by the Self-test descriptor index in the ATA Extended Self-test log (see ATA8-ACS)."

Status
rlsheffi Completed 8/29/2006 4:40:56 PM

Sequence number: 12
Author: DELL[KMarks]
Subject: Note
Date: 5/6/2006 3:36:20 PM

 **Table 74 — Self-Test Results log parameters (part 1 of 2)**

Row: Control bits

Comments from page 94 continued on next page

- 3) If the HDA Temp field is equal to 80h the SATL shall set the MOST RECENT TEMPERATURE READING field to FFh; and
- 4) Otherwise the SATL shall set the MOST RECENT TEMPERATURE READING FIELD to the value in the HDA Temp field.

If the ATA device does not support the SCT Feature Set, then the SATL shall set the MOST RECENT TEMPERATURE READING field to FFh.

10.2.4 Self-Test Results log page

10.2.4.1 Self-Test Results log page overview

The Self-Test Results log page provides the results from the most recent self-tests. Table 73 shows the Self-Test Results log page header fields.

Table 73 — Self-Test Results log page fields

Field	Description or reference
PAGE CODE	Set to 10h. This field value is specific to the Self-Test Results log page.
PAGE LENGTH	See SPC-3

Translations of the fields for the Self-Test Results log parameters for the Self-Test Results log page are shown in Table 74.

Table 74 — Self-Test Results log parameters (part 1 of 2)

Field	Description or reference
PARAMETER CODE	Unspecified (see 3.4.3)
DU	Unspecified (see 3.4.3)
DS	Unspecified (see 3.4.3)
TSD	Unspecified (see 3.4.3)
ET	Unspecified (see 3.4.3)
TMC	Shall be set to 00b.
LBIN	Unspecified (see 3.4.3)
LP	Unspecified (see 3.4.3)
PARAMETER LENGTH	¹³ specified (see 3.4.3)
SELF-TEST CODE	¹⁴ specified (see 3.4.3)
SELF-TEST RESULTS	<p>¹⁵The SATL shall read the ATA log data as defined in 10.2.4.2.</p> <p>If the SATL reads the ATA log data using the READ LOG EXT command specifying the Extended SMART self-test log, then the SATL shall set the SELF-TEST RESULTS field to the value in the Self-test Execution Status bits from the Content of the self-test execution status byte (i.e., byte n + 1 of the Extended Self-test log descriptor entry) (see ATA/ATAPI-7).</p> <p>If the SATL reads the ATA log data using the SMART READ LOG command specifying the SMART self-test log, then the SATL shall set the SELF-TEST RESULTS field to the value in the Content of the self-test execution status byte (i.e., byte n + 1 of the Self-test log descriptor entry) for the Self-test execution status bits.</p>
SELF-TEST NUMBER	Unspecified (see 3.4.3)

change them to: "Shall be set to ...

DU - zero
DS - zero
TSD - zero
ETC - zero
TMC - 00b
LBIN - one
LP - one

RESOLUTION: s/b

"	DU	Shall be set to zero.
	DS	Shall be set to zero.
	TSD	Shall be set to zero.
	ETC	Shall be set to zero.
	TMC	Shall be set to zero.
	LBIN	Shall be set to one.
	LP	Shall be set to one."

Status
rlsheffi Completed 6/23/2006 3:24:46 PM

Sequence number: 13
Author: DELL[KMarks]
Subject: Highlight
Date: 2/10/2006 1:25:08 PM

T Table 74 — Self-Test Results log parameters (part 1 of 2)

Row: PARAMETER LENGTH

change

"Unspecified (see 3.4.3)"

to

"Shall be set to 10h."

Status
rlsheffi Completed 6/23/2006 3:26:32 PM

Sequence number: 14
Author: DELL[KMarks]
Subject: Highlight
Date: 9/13/2006 8:32:20 AM

T Table 74 — Self-Test Results log parameters (part 1 of 2)

Row: SELF TEST CODE

Why is this Unspecified? It appears to me that the first byte of the self-test descriptor entry is the ATA self test that failed. This maps back to the SCSI SELF-TEST CODE using the text in the SEND DIAGNOSTIC command translation, i.e. a one to one mapping...

REASON: "Unspecified" is consistent with what was in proposal 05-245r4, "See SPC-3". 06-374r1 rewrites the description of the SELF-TEST CODE field (see).

Status
rlsheffi Rejected 9/13/2006 8:32:23 AM

Sequence number: 15
Author: rlsheffi
Subject: Highlight
Date: 8/28/2006 3:47:38 PM

T Table 74 — Self-Test Results log parameters (part 1 of 2)

Replace the description of the SELF-TEST RESULTS field with,

"The SATL shall read the ATA log data as defined in 10.2.4.2.

The SELF-TEST RESULTS field shall be set to the self-test execution status byte in the descriptor indicated by the Self-test descriptor index in the ATA Extended Self-test log (see ATA8-ACS)."

Comments from page 94 continued on next page

- 3) If the HDA Temp field is equal to 80h the SATL shall set the MOST RECENT TEMPERATURE READING field to FFh; and
- 4) Otherwise the SATL shall set the MOST RECENT TEMPERATURE READING FIELD to the value in the HDA Temp field.

If the ATA device does not support the SCT Feature Set, then the SATL shall set the MOST RECENT TEMPERATURE READING field to FFh.

10.2.4 Self-Test Results log page

10.2.4.1 Self-Test Results log page overview

The Self-Test Results log page provides the results from the most recent self-tests. Table 73 shows the Self-Test Results log page header fields.

Table 73 — Self-Test Results log page fields

Field	Description or reference
PAGE CODE	Set to 10h. This field value is specific to the Self-Test Results log page.
PAGE LENGTH	See SPC-3

Translations of the fields for the Self-Test Results log parameters for the Self-Test Results log page are shown in Table 74.

Table 74 — Self-Test Results log parameters (part 1 of 2)

Field	Description or reference
PARAMETER CODE	Unspecified (see 3.4.3)
DU	Unspecified (see 3.4.3)
DS	Unspecified (see 3.4.3)
TSD	Unspecified (see 3.4.3)
ET	Unspecified (see 3.4.3)
TMC	Shall be set to 00b.
LBIN	Unspecified (see 3.4.3)
LP	Unspecified (see 3.4.3)
PARAMETER LENGTH	Unspecified (see 3.4.3)
SELF-TEST CODE	Unspecified (see 3.4.3)
SELF-TEST RESULTS	<p>The SATL shall read the ATA log data as defined in 10.2.4.2.</p> <p>If the SATL reads the ATA log data using the READ LOG EXT command specifying the Extended SMART self-test log, then the SATL shall set the SELF-TEST RESULTS field to the value in the Self-test Execution Status bits from the Content of the self-test execution status byte (i.e., byte n + 1 of the Extended Self-test log descriptor entry) (see ATA/ATAPI-7).</p> <p>If the SATL reads the ATA log data using the SMART READ LOG command specifying the SMART self-test log, then the SATL shall set the SELF-TEST RESULTS field to the value in the Content of the self-test execution status byte (i.e., byte n + 1 of the Self-test log descriptor entry) for the Self-test execution status bits.</p>
SELF-TEST NUMBER	Unspecified (see 3.4.3)

Status
rlsheffi Completed 8/29/2006 4:42:38 PM

Sequence number: 16
Author: EDITOR[rlsheffi]
Subject: Highlight
Date: 5/25/2006 12:30:47 PM

T **Table 74 — Self-Test Results log parameters**

Row: SELF-TEST RESULTS

change

"(see ATA/ATAPI-7)"

to

"(see ATA8-ACS)"

Status
rlsheffi Completed 6/23/2006 3:28:12 PM

Table 74 — Self-Test Results log parameters (part 2 of 2)

Field	Description or reference
TIMESTAMP	<p>The SATL shall read the ATA log data as defined in 10.2.4.2.</p> <p>If the SATL reads the ATA log data using the READ LOG EXT command specifying the Extended SMART self-test log, then the SATL shall set the TIMESTAMP field to the values in the Life timestamp (most significant byte) and Life timestamp (least significant byte) of the Extended Self-test log descriptor entry.</p> <p>If the SATL reads the ATA log data using the SMART READ LOG command specifying the SMART self-test log, then the SATL shall set the TIMESTAMP field to the values in the Life timestamp (most significant byte) and Life timestamp (least significant byte) of the Self-test log descriptor entry.</p>
ADDRESS OF FIRST FAILURE	<p>The SATL shall read the ATA log data as defined in 10.2.4.2.</p> <p>If the SATL reads the ATA log data using the READ LOG ¹ command specifying the Extended SMART self-test log, then the SATL ² shall set the ADDRESS OF FIRST FAILURE field using the values in the Failing LBA (47:40), Failing LBA (39:32), Failing LBA (31:24), Failing LBA (23:16), Failing LBA (15:8), and Failing LBA (7:0) of the Extended Self-test log descriptor entry.</p> <p>If the SATL reads the ATA log data using the SMART READ LOG ⁴ command ³ specifying the SMART self-test log, then the SATL ⁵ shall set the ADDRESS OF FIRST FAILURE field using the values in the Failing LBA (most significant byte), Failing LBA (next most significant byte), Failing LBA (next least significant byte), and Failing LBA (least significant byte) of the Self-test log descriptor entry.</p>
SENSE KEY	10.2.4.3
ADDITIONAL SENSE CODE	10.2.4.3
ADDITIONAL SENSE CODE QUALIFIER	10.2.4.3

10.2.4.2 A method of determining ATA command selection for field translations

To translate the SELF-TEST RESULTS field, the TIMESTAMP field, the ADDRESS OF FIRST FAILURE field, the SENSE KEY field, the ADDITIONAL SENSE CODE field, and the ADDITIONAL SENSE CODE QUALIFIER field of Self-Test Results log parameters, the SATL shall:

- 1) Issue an IDENTIFY DEVICE command to the ATA device;
- 2) From the returned data the SATL shall determine if the ATA device supports the 48-bit Address feature set from bit 10 of word 83;
- 3) If the 48-bit Address feature set is supported the SATL shall issue a READ LOG EXT command with the Log address set to 07h (i.e., Extended SMART self-test log) to the ATA device; and
- 4) If the 48-bit Address feature set is not supported the SATL shall issue a SMART READ LOG command with the Log address set to 06h (i.e., SMART self-test log) to the ATA device.

10.2.4.3 Sense key and additional sense code

The SATL shall determine the sense key and additional sense code from the content of the self-test execution status byte returned from a READ LOG EXT command or SMART READ LOG command issued to the ATA

Sequence number: 1
Author: HPQ[WBellamy]
Subject: Note
Date: 5/6/2006 4:07:29 PM



Status
rlsheffi Cancelled 5/6/2006 4:07:32 PM

Sequence number: 2
Author: HPQ[WBellamy]
Subject: Highlight
Date: 9/13/2006 8:39:19 AM

T Verbiage is strange here, i. e., "shall set" the xxx field using the values". Shouldn't this be "shall set the xxx field to the values of". I suggest for this field going back to proposal 05-245r4 for better verbiage or building another translation just for these LBA values for this "set / using" process.

RESOLUTION: See 06-374r1. Wording changed to,
"If the Self-test descriptor index is set to a non-zero value, then the SATL shall set the ADDRESS OF FIRST FAILURE field to:"

Status
rlsheffi Completed 9/13/2006 2:33:14 PM

Sequence number: 3
Author: HPQ[WBellamy]
Subject: Note
Date: 5/6/2006 4:06:10 PM



Status
rlsheffi Cancelled 5/6/2006 4:06:14 PM

Sequence number: 4
Author: HPQ[WBellamy]
Subject: Note
Date: 2/20/2006 2:14:51 PM

Two "shalls" here, remove one of them.

Status
rlsheffi Completed 6/23/2006 3:31:34 PM

Sequence number: 5
Author: HPQ[WBellamy]
Subject: Highlight
Date: 9/13/2006 8:57:51 AM

T Verbiage is strange here, i. e., "shall set" the xxx field using the values". Shouldn't this be "shall set the xxx field to the values of". I suggest for this field going back to proposal 05-245r4 for better verbiage or building another translation just for these LBA values for this "set / using" process.

RESOLUTION: Per 06-374r1, the text is changed to:
"If the SATL reads the ATA log data using the ATA SMART READ LOG command specifying the SMART self-test log, then the SATL shall set the ADDRESS OF FIRST FAILURE field to the values contained ..."

Status
rlsheffi Completed 9/13/2006 2:33:19 PM

Sequence number: 6
Author: EDITOR[rlsheffi]
Subject: Rectangle
Date: 5/6/2006 4:18:06 PM

10.2.4.2 A method of determining ATA command selection for field translations

Replace the text of the subclause with the following:

"To translate the SELF-TEST RESULTS field, the TIMESTAMP field, the ADDRESS OF FIRST FAILURE field, the SENSE KEY field, the ADDITIONAL SENSE CODE field, and the ADDITIONAL SENSE CODE QUALIFIER field of Self-Test Results log parameters, the SATL shall issue an IDENTIFY DEVICE command to the ATA device, and from the returned data the SATL shall determine if the ATA device supports the 48-bit Address feature set. If the 48-bit Address feature set is supported (i.e., bit 10 of word 83 of IDENTIFY DEVICE data is set to one), then the SATL shall issue a READ LOG EXT command with the Log address set to 07h (i.e., Extended SMART self-test log) to the ATA device. If the 48-bit Address feature set is not supported (i.e., bit 10 of

Table 74 — Self-Test Results log parameters (part 2 of 2)

Field	Description or reference
TIMESTAMP	<p>The SATL shall read the ATA log data as defined in 10.2.4.2.</p> <p>If the SATL reads the ATA log data using the READ LOG EXT command specifying the Extended SMART self-test log, then the SATL shall set the TIMESTAMP field to the values in the Life timestamp (most significant byte) and Life timestamp (least significant byte) of the Extended Self-test log descriptor entry.</p> <p>If the SATL reads the ATA log data using the SMART READ LOG command specifying the SMART self-test log, then the SATL shall set the TIMESTAMP field to the values in the Life timestamp (most significant byte) and Life timestamp (least significant byte) of the Self-test log descriptor entry.</p>
ADDRESS OF FIRST FAILURE	<p>The SATL shall read the ATA log data as defined in 10.2.4.2.</p> <p>If the SATL reads the ATA log data using the READ LOG EXT command specifying the Extended SMART self-test log, then the SATL shall set the ADDRESS OF FIRST FAILURE field using the values in the Failing LBA (47:40), Failing LBA (39:32), Failing LBA (31:24), Failing LBA (23:16), Failing LBA (15:8), and Failing LBA (7:0) of the Extended Self-test log descriptor entry.</p> <p>If the SATL reads the ATA log data using the SMART READ LOG command specifying the SMART self-test log, then the SATL shall set the ADDRESS OF FIRST FAILURE field using the values in the Failing LBA (most significant byte), Failing LBA (next most significant byte), Failing LBA (next least significant byte), and Failing LBA (least significant byte) of the Self-test log descriptor entry.</p>
SENSE KEY	10.2.4.3
ADDITIONAL SENSE CODE	10.2.4.3
ADDITIONAL SENSE CODE QUALIFIER	10.2.4.3

10.2.4.2 A method of determining ATA command selection for field translations

To translate the SELF-TEST RESULTS field, the TIMESTAMP field, the ADDRESS OF FIRST FAILURE field, the SENSE KEY field, the ADDITIONAL SENSE CODE field, and the ADDITIONAL SENSE CODE QUALIFIER field of Self-Test Results log parameters, the SATL shall:

- 1) Issue an IDENTIFY DEVICE command to the ATA device;
- 2) From the returned data the SATL shall determine if the ATA device supports the 48-bit Address feature set from bit 10 of word 83;
- 3) If the 48-bit Address feature set is supported the SATL shall issue a READ LOG EXT command with the Log address set to 07h (i.e., Extended SMART self-test log) to the ATA device; and
- 4) If the 48-bit Address feature set is not supported the SATL shall issue a SMART READ LOG command with the Log address set to 06h (i.e., SMART self-test log) to the ATA device.

10.2.4.3 Sense key and additional sense code

The SATL shall determine the sense key and additional sense code from the content of the self-test execution status byte returned from a READ LOG EXT command or SMART READ LOG command issued to the ATA

word 83 of IDENTIFY DEVICE data is set to zero), then the SATL shall issue a SMART READ LOG command with the Log address set to 06h (i.e., SMART self-test log) to the ATA device.”

Status
rlsheffi Completed 6/23/2006 3:41:59 PM

Sequence number: 7
Author: DELL[KMarks]
Subject: Highlight
Date: 5/6/2006 4:18:30 PM

T 10.2.4.2 A method of determining ATA command selection for field translations
1st Paragraph 1,2,3,4 list

"1) Issue an IDENTIFY DEVICE command to the ATA device;
2) From the returned data the SATL shall determine if the ATA device supports the 48-bit Address feature set from bit 10 of word 83;
3) If the 48-bit Address feature set is supported the SATL shall issue a READ LOG EXT command with the Log address set to 07h (i.e., Extended SMART self-test log) to the ATA device; and
4) If the 48-bit Address feature set is not supported the SATL shall issue a SMART READ LOG command with the Log address set to 06h (i.e., SMART self-test log) to the ATA device."

to
"1) Issue an ATA IDENTIFY DEVICE command to the ATA device;
2) From the returned data the SATL shall determine if the ATA device supports the 48-bit Address feature set from bit 10 of word 83;
3) If the 48-bit Address feature set is supported the SATL shall issue an ATA READ LOG EXT command with the Log address set to 7 (i.e., Extended SMART self-test log) to the ATA device; and
4) If the 48-bit Address feature set is not supported the SATL shall issue a SMART READ LOG command with the Log address set to 6 (i.e., SMART self-test log) to the ATA device."

RESOLUTION: See EDITOR comment

Status
rlsheffi Completed 6/23/2006 3:42:12 PM

Sequence number: 8
Author: HPQ[RElliott]
Subject: Note
Date: 5/6/2006 4:19:01 PM

T 10.2.4.2

This might be interpreted as requiring the 4 steps be run on each log page access. Really, the IDENTIFY DATA is cached by th SATL.

Remove the 1)4) list and just say:

If the IDENTIFY DEVICE data indicates the 48-bit Address feature set is supported (i.e., word 83 bit 10 is set to 1), the SATL shall use the READ LOG EXT command... . If the IDENTIFY DEVICE data indicates the 48-bit Address feature is not supported (i.e., word 83 bit 10 is set to 0), then the SATL shall use the SMART READ LOG command... .

RESOLUTION: See EDITOR comment

Status
rlsheffi Completed 6/23/2006 3:42:38 PM

device (see 10.2.4.2). The values returned shall be translated into sense data for the sense key, and additional sense code as shown in table 75.

Table 75 — ATA Self-test execution status values translated to SCSI sense keys and sense codes

ATA	SCSI		
Self-Test execution status value	Sense key	Additional sense code	NN
0	NO SENSE	NO ADDITIONAL SENSE INFORMATION	n/a
1	ABORTED COMMAND	DIAGNOSTIC FAILURE ON COMPONENT NN (80h - FFh)	81h
2		DIAGNOSTIC FAILURE ON COMPONENT NN (80h - FFh)	82h
3		DIAGNOSTIC FAILURE ON COMPONENT NN (80h - FFh)	83h
4	HARDWARE ERROR	DIAGNOSTIC FAILURE ON COMPONENT NN (80h - FFh)	84h
5		DIAGNOSTIC FAILURE ON COMPONENT NN (80h - FFh)	85h
6		DIAGNOSTIC FAILURE ON COMPONENT NN (80h - FFh)	86h
7	MEDIUM ERROR	DIAGNOSTIC FAILURE ON COMPONENT NN (80h - FFh)	87h
8	HARDWARE ERROR	DIAGNOSTIC FAILURE ON COMPONENT NN (80h - FFh)	88h
9-14	Unspecified (see 3.4.3) ^a		
15	NO SENSE	NO ADDITIONAL SENSE INFORMATION	n/a

^a Self-Test execution status values from 9 to 14 are reserved in **ATA/ATAPI-7**.

10.2.5 Supported Log Pages log page

The Supported Log Pages log page (see table 76) returns the list of log pages supported by the SATL (see SPC-3).

Table 76 — Supported Log Pages log page fields

Field	Description or reference
PAGE CODE	Unspecified (see 3.4.3)
PAGE LENGTH	Unspecified (see 3.4.3)
SUPPORTED PAGE LIST	<p>As part of conforming to the requirements of SPC-3 the SATL shall identify log pages to add to the list of supported log pages by performing the following steps:</p> <ol style="list-style-type: none"> 1) The SATL shall determine if the ATA device supports the ATA SMART feature set from the ATA IDENTIFY DEVICE data word 82, bit 0. If the device supports the ATA SMART feature set the SATL shall add the Informational Exceptions log page to its list of supported log pages. If the device does not support the ATA SMART feature set the SATL shall not add either the Informational Exceptions log page or the Self-Test Results log page to its list of supported pages; and 2) If the ATA device supports the ATA SMART feature set, the SATL shall determine if the device supports the ATA SMART self-test from the ATA IDENTIFY DEVICE data word 84, bit 1. If the device supports the ATA SMART self-test the SATL shall add the Self-Test Results log page to its list of supported log pages.

Sequence number: 1
Author: EDITOR[risheffi]
Subject: Highlight
Date: 5/25/2006 12:35:18 PM

T **Table 75 — ATA Self-test execution status values translated to SCSI sense keys and sense codes**

Table footnote a)

change

"ATA/ATAPI-7"

to

"ATA8-ACS"

Status
risheffi Completed 6/23/2006 3:43:21 PM

Sequence number: 2
Author: EDITOR[risheffi]
Subject: Highlight
Date: 4/24/2006 11:06:11 AM

T pages

s/b

Pages

Status
risheffi Completed 6/23/2006 3:43:41 PM

Sequence number: 3
Author: HPQ[WBellamy]
Subject: Note
Date: 5/6/2006 4:20:24 PM



Status
risheffi Cancelled 5/6/2006 4:20:26 PM

Sequence number: 4
Author: HPQ[WBellamy]
Subject: Cross-Out
Date: 5/6/2006 4:24:38 PM



Status
risheffi Cancelled 5/6/2006 4:24:49 PM

Sequence number: 5
Author: DELL[KMarks]
Subject: Highlight
Date: 6/23/2006 3:44:29 PM

T **Table 76 — Supported Log pages log page fields**

Row: PAGE CODE

change

"Unspecified (see 3.4.3)"

to

"Shall be set to 00h."

RESOLUTION: s/b

"Shall be set to zero"

Status
risheffi Completed 6/23/2006 3:44:31 PM

Sequence number: 6
Author: HPQ[WBellamy]
Subject: Highlight
Date: 6/23/2006 3:44:48 PM

T This is the Supported Log Pages log page. Its PAGE CODE must be 00h. See proposal 05-142r4.

RESOLUTION: s/b

"Shall be set to 00h."

RESOLUTION: s/b

"Shall be set to zero"

device (see 10.2.4.2). The values returned shall be translated into sense data for the sense key, and additional sense code as shown in table 75.

Table 75 — ATA Self-test execution status values translated to SCSI sense keys and sense codes

ATA Self-Test execution status value	SCSI		
	Sense key	Additional sense code	NN
0	NO SENSE	NO ADDITIONAL SENSE INFORMATION	n/a
1	ABORTED COMMAND	DIAGNOSTIC FAILURE ON COMPONENT NN (80h - FFh)	81h
2		DIAGNOSTIC FAILURE ON COMPONENT NN (80h - FFh)	82h
3		DIAGNOSTIC FAILURE ON COMPONENT NN (80h - FFh)	83h
4	HARDWARE ERROR	DIAGNOSTIC FAILURE ON COMPONENT NN (80h - FFh)	84h
5		DIAGNOSTIC FAILURE ON COMPONENT NN (80h - FFh)	85h
6		DIAGNOSTIC FAILURE ON COMPONENT NN (80h - FFh)	86h
7	MEDIUM ERROR	DIAGNOSTIC FAILURE ON COMPONENT NN (80h - FFh)	87h
8	HARDWARE ERROR	DIAGNOSTIC FAILURE ON COMPONENT NN (80h - FFh)	88h
9-14	Unspecified (see 3.4.3) ^a		
15	NO SENSE	NO ADDITIONAL SENSE INFORMATION	n/a

^a Self-Test execution status values from 9 to 14 are reserved in **ATA/ATAPI-7**.

10.2.5 Supported Log Pages log page

The Supported Log Pages log page (see table 76) returns the list of log pages supported by the SATL (see SPC-3).

Table 76 — Supported Log pages log page fields

Field	Description or reference
PAGE CODE	Unspecified (see 3.4.3)
PAGE LENGTH	Unspecified (see 3.4.3)
SUPPORTED PAGE LIST	<p>As part of conforming to the requirements of SPC-3 the SATL shall identify log pages to add to the list of supported log pages by performing the following steps:</p> <ol style="list-style-type: none"> 1) The SATL shall determine if the ATA device supports the ATA SMART feature set from the ATA IDENTIFY DEVICE data word 82, bit 0. 8 the device supports the ATA SMART feature set the SATL shall add the Informational Exceptions log page to its list of supported log pages. 9 the device does not support the ATA SMART feature set the SATL shall not add either the Informational Exceptions log page or the Self-Test Results log page to its list of supported pages; and 2) 10 the ATA device supports the ATA SMART feature set, the SATL shall determine if the device supports the ATA SMART self-test from the ATA IDENTIFY DEVICE data word 84, bit 1. 11 the device supports the ATA SMART self-test the SATL shall add the Self-Test Results log page to its list of supported log pages.

Status
rlsheffi Completed 6/23/2006 3:44:51 PM

Sequence number: 7
Author: EDITOR[rlsheffi]
Subject: Rectangle
Date: 4/24/2006 11:06:20 AM

 RESOLUTION:

The SATL shall include log pages as follows:

- a) the Informational Exceptions log page if the ATA device supports the ATA SMART feature set (i.e., ATA IDENTIFY DEVICE data word 82, bit 0 is set to one); and
 - b) the Self-Test Results log page if the ATA device supports the ATA SMART self-test (i.e., ATA IDENTIFY DEVICE data word 84, bit 1 is set to one).
- TO DO: make change (per 3/20/06 SAT LB review).

Status
rlsheffi Completed 6/23/2006 3:48:28 PM

Sequence number: 8
Author: MXO[MEvans]
Subject: Highlight
Date: 5/6/2006 4:26:06 PM

 Table 76, SUPPORTED PAGE LIST row, list item 1: change, "If the device supports the ATA SMART feature set the SATL shall..." to "If the device supports the ATA SMART feature set, then the SATL shall..."

RESOLUTION: See EDITOR comment

Status
rlsheffi Completed 6/23/2006 3:48:36 PM

Sequence number: 9
Author: MXO[MEvans]
Subject: Highlight
Date: 5/6/2006 4:29:29 PM

 Table 76, SUPPORTED PAGE LIST row, list item 1: change, "If the device does not support the ATA SMART feature set the SATL shall..." to "If the device does not support the ATA SMART feature set, then the SATL shall not..."

RESOLUTION: See EDITOR comment

Status
rlsheffi Completed 6/23/2006 3:48:43 PM

Sequence number: 10
Author: MXO[MEvans]
Subject: Highlight
Date: 5/6/2006 4:29:50 PM

 Table 76, SUPPORTED PAGE LIST row, list item 2: change, "If the device supports the ATA SMART feature set, the SATL shall..." to "If the device supports the ATA SMART feature set, then the SATL shall..."

RESOLUTION: See EDITOR comment

Status
rlsheffi Completed 6/23/2006 3:48:52 PM

Sequence number: 11
Author: MXO[MEvans]
Subject: Highlight
Date: 5/6/2006 4:30:00 PM

 Table 76, SUPPORTED PAGE LIST row, list item 2: change, "If the device supports the ATA SMART self-test the SATL shall..." to "If the device supports the ATA SMART self-test, then the SATL shall..."

RESOLUTION: See EDITOR comment

Status
rlsheffi Completed 6/23/2006 3:48:59 PM

10.3 Vital product data parameters

10.3.1 Vital product data parameters overview

Table 77 provides a summary of the VPD page translations defined in this standard.

Table 77 — Summary of SCSI / ATA VPD page mapping



SCSI VPD page	Reference
Supported VPD Pages (i.e., 00h)	10.3.2
Unit Serial Number (i.e., 80h)	10.3.3
Device Identification (i.e., 83h)	10.3.4
ATA Information VPD page (i.e., 89h)	10.3.5

10.3.2 Supported VPD pages VPD page

Table 78 shows the fields of the Supported VPD pages VPD page.

Table 78 — Supported VPD pages VPD page fields

Field	Description or reference
PERIPHERAL DEVICE TYPE	The PERIPHERAL QUALIFIER field and the PERIPHERAL DEVICE TYPE field shall be set as described in 8.1.2.
PERIPHERAL QUALIFIER	
PAGE CODE	The SATL shall set the field to 00h.
PAGE LENGTH	The SATL shall set this field to indicate the length of the supported VPD page list returned in number of bytes.
SUPPORTED VPD LIST	This list shall contain the page codes of the pages supported by the SATL in ascending order of page codes beginning with page code 00h.

10.3.3 Unit Serial Number VPD page

Table 79 defines the Unit Serial Number VPD page (see SPC-3) returned by a SATL for an ATA device.

Table 79 — Unit Serial Number VPD page for SAT



Bit\Byte	7	6	5	4	3	2	1	0
0	PERIPHERAL QUALIFIER			PERIPHERAL DEVICE TYPE				
1	PAGE CODE (80h)							
2	Reserved							
3	PAGE LENGTH (14h)							
4								
23	PRODUCT SERIAL NUMBER							

The PERIPHERAL QUALIFIER field and the PERIPHERAL DEVICE TYPE field shall be set as described in 8.1.2.

The PAGE CODE field shall be set to 80h.

The PAGE LENGTH field shall be set to 14h.

Page: 97

Sequence number: 1
Author: HPQ[RElliott]
Subject: Note
Date: 6/23/2006 3:52:51 PM

 10.3.1

table 77

Add "VPD page" to first 3 two rows

RESOLUTION:

" Supported VPD Pages (i.e., 00h)
Unit Serial Number (i.e., 80h)
Device Identification (i.e., 83h)
ATA Information VPD page (i.e., 89h)"

s/b

" Supported VPD Pages VPD page(i.e., 00h)
Unit Serial Number VPD page(i.e., 80h)
Device Identification VPD page(i.e., 83h)
ATA Information VPD page (i.e., 89h)"

RESOLUTION: s/b

" Supported VPD Pages VPD page(i.e., 00h)
Unit Serial Number VPD page(i.e., 80h)
Device Identification VPD page(i.e., 83h)
Mode Page Policy VPD page (i.e., 87h)
ATA Information VPD page (i.e., 89h)"

Status

risheffi Completed 6/23/2006 3:52:53 PM

Sequence number: 2
Author: HPQ[RElliott]
Subject: Highlight
Date: 2/1/2006 9:39:41 AM

 10.3.2

table 78

the s/b this

Status

risheffi Completed 6/23/2006 3:53:28 PM

Sequence number: 3
Author: DELL[KMarks]
Subject: Note
Date: 9/13/2006 9:00:17 AM

 Why are the VPD page translation formats different than all the other translations, i.e. shown in Bit/Byte Format, instead of the Field/Description or Reference format?

Change to match format except for the ATA Information VPD.

WITHDRAWN: Per SAT WG, 9/11/06

Status

risheffi Cancelled 9/13/2006 8:59:46 AM

The PRODUCT SERIAL NUMBER field contains a representation of the SERIAL NUMBER field in the ATA IDENTIFY DEVICE data (i.e., words 20-19) last retrieved from the ATA device. Each pair of bytes in the SERIAL NUMBER field shall be swapped to create a valid ASCII string format in the PRODUCT SERIAL NUMBER field as described in table 80.

Table 80 — PRODUCT SERIAL NUMBER field

Byte	Contents
0	IDENTIFY DEVICE word 10 bits 15:8 (i.e., byte 1)
1	IDENTIFY DEVICE word 10 bits 7:0 (i.e., byte 0)
2	IDENTIFY DEVICE word 11 bits 15:8 (i.e., byte 3)
3	IDENTIFY DEVICE word 11 bits 7:0 (i.e., byte 2)
...	...
18	IDENTIFY DEVICE word 19 bits 15:8 (i.e., byte 19)
19	IDENTIFY DEVICE word 19 bits 7:0 (i.e., byte 18)

NOTE 8 - Although SPC-3 defines the PRODUCT SERIAL NUMBER field as right-aligned, ATA/ATAPI-7 does not require its SERIAL NUMBER field to be right-aligned. Therefore, the PRODUCT SERIAL NUMBER field for SAT may not be right-aligned.

10.3.4 Device Identification VPD page

10.3.4.1 Device Identification VPD page overview

The SATL shall return the Device Identification VPD page (see SPC-3) as defined in table 81.

Table 81 — Device Identification VPD page for SAT

Bit\Byte	7	6	5	4	3	2	1	0
0	PERIPHERAL QUALIFIER			PERIPHERAL DEVICE TYPE				
1	PAGE CODE (83h)							
2	Reserved							
3	PAGE LENGTH (n-3)							
4	Identification descriptor for the logical unit (see table 82 and table 84)							
15								
16	Additional identification descriptor(s) (if any)							
n								

The PERIPHERAL QUALIFIER field and the PERIPHERAL DEVICE TYPE field shall be set as described in 8.1.2. The PAGE CODE field shall be set to 83h.

The PAGE LENGTH field contains the length of the remaining bytes of the VPD page.

One identification descriptor for a logical unit (i.e., a logical unit name) shall be included (see clause 10.3.4.2).

In some environments, one or more additional identification descriptors may be included (see clause 10.3.4.3).

Sequence number: 1
Author: DELL[KMarks]
Subject: Highlight
Date: 5/6/2006 5:16:46 PM

T 4th Paragraph after Table 79 — Unit Serial Number VPD page for SAT

change

"The PRODUCT SERIAL NUMBER field contains a representation of the SERIAL NUMBER field in the ATA IDENTIFY DEVICE data (i.e., words 10-19) last retrieved from the ATA device. Each pair of bytes in the SERIAL NUMBER field shall be swapped to create a valid ASCII string format in the PRODUCT SERIAL NUMBER field as described in table 80."

to

"The PRODUCT SERIAL NUMBER field contains a representation of the Serial number field in the ATA IDENTIFY DEVICE data (i.e., words 10-19) last retrieved from the ATA device. Each pair of bytes in the Serial number field shall be swapped to create a valid ASCII string format in the PRODUCT SERIAL NUMBER field as described in table 80."

RESOLUTION:

"The PRODUCT SERIAL NUMBER field contains a representation of the Serial number field in the ATA IDENTIFY DEVICE data (i.e., words 19:10) last retrieved from the ATA device. Each pair of bytes in the Serial number field shall be swapped to create a valid ASCII string format in the PRODUCT SERIAL NUMBER field as described in table 80."

Status
risheffi Completed 6/23/2006 3:56:09 PM

Sequence number: 2
Author: HPQ[RElliott]
Subject: Highlight
Date: 2/1/2006 3:40:47 PM

T 10.3.3

Change 10-19 to 19:10

Status
risheffi Completed 6/23/2006 3:56:30 PM

Sequence number: 3
Author: EDITOR[risheffi]
Subject: Highlight
Date: 5/25/2006 12:38:14 PM

T 10.3.3 Unit Serial Number VPD page

NOTE 8

change

"ATA/ATAPI-7"

to

"ATA8-ACS"

Status
risheffi Completed 6/23/2006 3:56:57 PM

Sequence number: 4
Author: EDITOR[risheffi]
Subject: Highlight
Date: 4/25/2006 10:42:33 AM

T 10.3.4.1 Device Identification VPD page overview
Table 81 — Device Identification VPD page for SAT

Byte-2

This byte should be part of the page length, not reserved.

Status
risheffi Completed 6/23/2006 4:01:13 PM

Sequence number: 5
Author: DELL[KMarks]
Subject: Highlight
Date: 5/6/2006 5:18:28 PM

T "The PAGE LENGTH field contains the length of the remaining bytes of the VPD page."

The PRODUCT SERIAL NUMBER field contains a representation of the SERIAL NUMBER field in the ATA IDENTIFY DEVICE data (i.e., words 10-19) last retrieved from the ATA device. Each pair of bytes in the SERIAL NUMBER field shall be swapped to create a valid ASCII string format in the PRODUCT SERIAL NUMBER field as described in table 80.

Table 80 — PRODUCT SERIAL NUMBER field

Byte	Contents
0	IDENTIFY DEVICE word 10 bits 15:8 (i.e., byte 1)
1	IDENTIFY DEVICE word 10 bits 7:0 (i.e., byte 0)
2	IDENTIFY DEVICE word 11 bits 15:8 (i.e., byte 3)
3	IDENTIFY DEVICE word 11 bits 7:0 (i.e., byte 2)
...	...
18	IDENTIFY DEVICE word 19 bits 15:8 (i.e., byte 19)
19	IDENTIFY DEVICE word 19 bits 7:0 (i.e., byte 18)

NOTE 8 - Although SPC-3 defines the PRODUCT SERIAL NUMBER field as right-aligned, ATA/ATAPI-7 does not require its SERIAL NUMBER field to be right-aligned. Therefore, the PRODUCT SERIAL NUMBER field for SAT may not be right-aligned.

10.3.4 Device Identification VPD page

10.3.4.1 Device Identification VPD page overview

The SATL shall return the Device Identification VPD page (see SPC-3) as defined in table 81.

Table 81 — Device Identification VPD page for SAT

Bit\Byte	7	6	5	4	3	2	1	0
0	PERIPHERAL QUALIFIER			PERIPHERAL DEVICE TYPE				
1	PAGE CODE (83h)							
2	Reserved							
3	PAGE LENGTH (n-3)							
4	Identification descriptor for the logical unit (see table 82 and table 84)							
15								
16	Additional identification descriptor(s) (if any)							
n								

The PERIPHERAL QUALIFIER field and the PERIPHERAL DEVICE TYPE field shall be set as described in 8.1.2. The PAGE CODE field shall be set to 83h.

The PAGE LENGTH field contains the length of the remaining bytes of the VPD page.

One identification descriptor for a logical unit (i.e., a logical unit name) shall be included (see clause 10.3.4.2).

In some environments, one or more additional identification descriptors may be included (see clause 10.3.4.3).

This should change to Unspecified in the other format.
RESOLUTION: It's part of the page length (see EDITOR comment)

Status

rlsheffi Rejected 5/6/2006 5:18:34 PM

Sequence number: 6
Author: ENDL[RWeber]
Date: 2/14/2006 8:38:48 PM

T 2nd to last p on pg, s 1
(see clause 10.3.4.2) [s/b] (see 10.3.4.2)

Status

rlsheffi Completed 6/23/2006 4:14:51 PM

Sequence number: 7
Author: ENDL[RWeber]
Date: 2/14/2006 8:38:33 PM

T last p on pg, s 1
(see clause 10.3.4.3) [s/b] (see 10.3.4.3)

Status

rlsheffi Completed 6/23/2006 4:15:19 PM

10.3.4.2 Logical unit name

10.3.4.2.1 Logical unit name overview

1 the ATA device returns word 87 bit 8 set to one in its IDENTIFY DEVICE data indicating that it supports the WORLD WIDE NAME field (i.e., words 208-111), the SATL shall include an identification descriptor containing a logical unit name as defined in 10.3.4.2.2.

If the ATA device returns word 87 bit 8 set to zero in its IDENTIFY DEVICE data indicating that it does not support the WORLD WIDE NAME field (i.e., words 308-111), the SATL shall include an identification descriptor containing a logical unit name as defined in 10.3.4.2.3.

10.3.4.2.2 Logical unit name derived from the world wide name

Table 82 defines the logical unit name derived from the ATA device world wide name.

Table 82 — Logical unit name derived from the world wide name

Byte/Bit	7	6	5	4	3	2	1	0
0	4 PROTOCOL IDENTIFIER				CODE SET (1h)			
1	PIV (0b)	Reserved	ASSOCIATION (0h)		IDENTIFIER TYPE (3h)			
2	Reserved							
3	IDENTIFIER LENGTH (08h)							
4	NAA				(MSB)			
5	IEEE COMPANY_ID							
6								
7					(LSB)	(MSB)		
8								
11	VENDOR SPECIFIC IDENTIFIER (LSB)							

The PROTOCOL IDENTIFIER field shall be set to 0h.

The CODE SET field shall be set to 1h (i.e., binary).

The PIV bit shall be set to 0b.

The ASSOCIATION field shall be set to 0h (i.e., logical unit).

The IDENTIFIER TYPE field shall be set to 3h (i.e., NAA).

Sequence number: 1
Author: DELL[KMarks]
Subject: Highlight
Date: 5/6/2006 5:23:45 PM

T 10.3.4.2.1 Logical unit name overview
1st two paragraphs
change

"If the ATA device returns word 87 bit 8 set to one in its IDENTIFY DEVICE data indicating that it supports the WORLD WIDE NAME field (i.e., words 108-111), the SATL shall include an identification descriptor containing a logical unit name as defined in 10.3.4.2.2.

If the ATA device returns word 87 bit 8 set to zero in its IDENTIFY DEVICE data indicating that it does not support the WORLD WIDE NAME field (i.e., words 108-111), the SATL shall include an identification descriptor containing a logical unit name as defined in 10.3.4.2.3."

to

"If the ATA device returns the ATA IDENTIFY DEVICE data word 87 bit 8 is set to one indicating that the ATA device supports the World wide name field (i.e., ATA IDENTIFY DEVICE data words 108-111), the SATL shall include an identification descriptor containing a logical unit name as defined in 10.3.4.2.2.

If the ATA device returns the ATA IDENTIFY DEVICE data word 87 bit 8 is set to zero indicating that the ATA device does not supports the support the World wide name field (i.e., ATA IDENTIFY DEVICE data words 108-111), the SATL shall include an identification descriptor containing a logical unit name as defined in 10.3.4.2.3."

RESOLUTION: s/b

"If the ATA device returns the ATA IDENTIFY DEVICE data word 87 bit 8 is set to one indicating that the ATA device supports the World wide name field (i.e., ATA IDENTIFY DEVICE data words 111:108), the SATL shall include an identification descriptor containing a logical unit name as defined in 10.3.4.2.2.

If the ATA IDENTIFY DEVICE data returned by the ATA device word 87 bit 8 is set to zero, indicating that the ATA device does not supports the support the World wide name field (i.e., ATA IDENTIFY DEVICE data words 111:108), the SATL shall include an identification descriptor containing a logical unit name as defined in 10.3.4.2.3."

Status
rlsheffi Completed 6/23/2006 4:17:27 PM

Sequence number: 2
Author: HPQ[RElliott]
Subject: Highlight
Date: 2/1/2006 3:41:11 PM

T 10.3.4.2.1
Change 108-111 to 111:108

Status
rlsheffi Completed 6/23/2006 4:17:44 PM

Sequence number: 3
Author: HPQ[RElliott]
Subject: Highlight
Date: 2/1/2006 3:41:24 PM

T 10.3.4.2.1
Change 108-111 to 111:108

Status
rlsheffi Completed 6/23/2006 4:17:55 PM

Sequence number: 4
Author: DELL[KMarks]
Subject: Highlight
Date: 6/23/2006 4:19:50 PM

10.3.4.2 Logical unit name

10.3.4.2.1 Logical unit name overview

If the ATA device returns word 87 bit 8 set to one in its IDENTIFY DEVICE data indicating that it supports the WORLD WIDE NAME field (i.e., words 108-111), the SATL shall include an identification descriptor containing a logical unit name as defined in 10.3.4.2.2.

If the ATA device returns word 87 bit 8 set to zero in its IDENTIFY DEVICE data indicating that it does not support the WORLD WIDE NAME field (i.e., words 108-111), the SATL shall include an identification descriptor containing a logical unit name as defined in 10.3.4.2.3.

10.3.4.2.2 Logical unit name derived from the world wide name

Table 82 defines the logical unit name derived from the ATA device world wide name.

Table 82 — Logical unit name derived from the world wide name

Byte/Bit	7	6	5	4	3	2	1	0
0	PROTOCOL IDENTIFIER				CODE SET (1h)			
1	PIV (0b)	Reserved	ASSOCIATION (0h)		IDENTIFIER TYPE (3h)			
2	Reserved							
3	IDENTIFIER LENGTH (08h)							
4	NAA				(MSB)			
5	IEEE COMPANY_ID							
6								
7					(LSB)	(MSB)		
8								
11	VENDOR SPECIFIC IDENTIFIER (LSB)							

The PROTOCOL IDENTIFIER field shall be set to 0h.

The CODE SET field shall be set to 1h (i.e., binary).

The PIV bit shall be set to 0b.

The ASSOCIATION field shall be set to 0h (i.e., logical unit).

The IDENTIFIER TYPE field shall be set to 3h (i.e., NAA).

T Table 82 — Logical unit name derived from the world wide name
Byte 0
change
"PROTOCOL IDENTIFIER"
to
"PROTOCOL IDENTIFIER (0h)"

to match other fields in table if keeping

Status
risheffi Completed 6/23/2006 4:19:53 PM

Sequence number: 5
Author: DELL[KMarks]
Subject: Highlight
Date: 2/10/2006 8:56:14 PM

T Table 82 — Logical unit name derived from the world wide name
if keeping the format change byte 1
"ASSOCIATION (0h)"
to
"ASSOCIATION (00b)"

Status
risheffi Completed 6/23/2006 4:20:17 PM

Sequence number: 6
Author: DELL[KMarks]
Subject: Highlight
Date: 2/10/2006 8:55:08 PM

T 4th Paragraph after Table 82 — Logical unit name derived from the world wide name
change
"The ASSOCIATION field shall be set to 0h (i.e., logical unit)."
to
The ASSOCIATION field shall be set to 00b (i.e., logical unit)."

Status
risheffi Completed 6/23/2006 4:20:49 PM

The NAA field, IEEE COMPANY_ID field, and VENDOR SPECIFIC IDENTIFIER field shall be based on the IDENTIFY DEVICE data WORLD WIDE NAME field as described in table 83.

Table 83 — Fields in the logical unit name

Field		Contents
Field name	Specific bits in Table 7	
NAA	Byte 4 bits 7:4	IDENTIFY DEVICE word 108 bits 15:12 ^a
IEEE COMPANY_ID	Byte 4 bits 3:0	IDENTIFY DEVICE word 108 bits 11:8
	Byte 5	IDENTIFY DEVICE word 108 bits 7:0
	Byte 6	IDENTIFY DEVICE word 109 bits 15:8
	Byte 7 bit 7:4	IDENTIFY DEVICE word 109 bits 7:4
VENDOR SPECIFIC IDENTIFIER	Byte 7 bits 3:0	IDENTIFY DEVICE word 109 bits 3:0
	Byte 8	IDENTIFY DEVICE word 110 bits 15:8
	Byte 9	IDENTIFY DEVICE word 110 bits 7:0
	Byte 10	IDENTIFY DEVICE word 111 bits 15:8
	Byte 11	IDENTIFY DEVICE word 111 bits 7:0

^a This 4-bit field is required to be set to 5h (i.e., IEEE Registered) by ATA/ATAPI-7 Volume 1.

10.3.4.2.3 Logical unit name derived from the model number and serial number

Table 84 defines the logical unit name derived from the ATA device model number and serial number.

Table 84 — Logical unit name derived from the model number and serial number

Byte\Bit	7	6	5	4	3	2	1	0
0	PROTOCOL IDENTIFIER			CODE SET (2h)				
1	PIV (0b)	Reserved	ASSOCIATION (0h)		IDENTIFIER TYPE (1h)			
2	Reserved							
3	IDENTIFIER LENGTH (68)							
4	VENDOR IDENTIFICATION ('ATA-----')							
11	VENDOR SPECIFIC IDENTIFIER (see table 85)							
12								
71								

The PROTOCOL IDENTIFIER field shall be set to 0h.

The CODE SET field shall be set to 2h (i.e., ASCII).

The PIV bit shall be set to 0b.

The ASSOCIATION field shall be set to 0h (i.e., logical unit).

The IDENTIFIER TYPE field shall be set to 1h (i.e., T10 vendor identification).

The VENDOR IDENTIFICATION field contains the string 'ATA-----'.

Sequence number: 1
Author: DELL[KMarks]
Subject: Highlight
Date: 5/6/2006 5:27:46 PM

T 6th Paragraph after Table 82 — Logical unit name derived from the world wide name change

"The NAA field, IEEE COMPANY_ID field, and VENDOR SPECIFIC IDENTIFIER field shall be based on the IDENTIFY DEVICE data WORLD WIDE NAME field as described in table 83."

to

"The NAA , IEEE COMPANY_ID , and VENDOR SPECIFIC IDENTIFIER fields shall be based on the ATA IDENTIFY DEVICE data World wide name field as described in table 83."

RESOLUTION:

"The NAA field , the IEEE COMPANY_ID field, and the VENDOR SPECIFIC IDENTIFIER field shall be based on the ATA IDENTIFY DEVICE data World wide name field as described in table 83."

Status
risheffi Completed 6/23/2006 4:22:07 PM

Sequence number: 2
Author: HPQ[RElliott]
Date: 2/3/2006 7:52:01 AM

T 10.3.4.2.2
table 83

table 7 reference s/b 82

Status
risheffi Completed 6/23/2006 4:24:42 PM

Sequence number: 3
Author: DELL[KMarks]
Subject: Note
Date: 6/24/2006 3:28:24 PM

T Table 83 — Fields in the logical unit name

Not sure why footnote a is needed, any ATA device that implements the WWN will have it as 5h or its not compliant.
REASON: Seems like useful information.

Status
risheffi Rejected 6/24/2006 3:28:27 PM

Sequence number: 4
Author: EDITOR[risheffi]
Subject: Highlight
Date: 5/25/2006 12:40:26 PM

T 10.3.4.2.2 Logical unit name derived from the world wide name
Table 83 — Fields in the logical unit name
Table footnote a)
change
"ATA/ATAPI-7 Volume 1"
to
"ATA8-ACS"

Status
risheffi Completed 6/23/2006 4:26:12 PM

Sequence number: 5
Author: DELL[KMarks]
Subject: Highlight
Date: 2/10/2006 9:20:29 PM

T Table 84 — Logical unit name derived from the model number and serial number

The NAA field, IEEE COMPANY_ID field, and VENDOR SPECIFIC IDENTIFIER field shall be based on the IDENTIFY DEVICE data WORLD WIDE NAME field as described in table 83.

Table 83 — Fields in the logical unit name

Field		Contents
Field name	Specific bits in table 7	
NAA	Byte 4 bits 7:4	IDENTIFY DEVICE word 108 bits 15:12 ^a
IEEE COMPANY_ID	Byte 4 bits 3:0	IDENTIFY DEVICE word 108 bits 11:8
	Byte 5	IDENTIFY DEVICE word 108 bits 7:0
	Byte 6	IDENTIFY DEVICE word 109 bits 15:8
	Byte 7 bits 7:4	IDENTIFY DEVICE word 109 bits 7:4
VENDOR SPECIFIC IDENTIFIER	Byte 7 bits 3:0	IDENTIFY DEVICE word 109 bits 3:0
	Byte 8	IDENTIFY DEVICE word 110 bits 15:8
	Byte 9	IDENTIFY DEVICE word 110 bits 7:0
	Byte 10	IDENTIFY DEVICE word 111 bits 15:8
	Byte 11	IDENTIFY DEVICE word 111 bits 7:0

^a This 4-bit field is required to be set to 5h (i.e., IEEE Registered) by ATA/ATAPI-7 Volume 1.

10.3.4.2.3 Logical unit name derived from the model number and serial number

Table 84 defines the logical unit name derived from the ATA device model number and serial number.

Table 84 — Logical unit name derived from the model number and serial number

Byte\Bit	7	6	5	4	3	2	1	0
0	PROTOCOL IDENTIFIER				CODE SET (2h)			
1	PIV (0b)	Reserved	ASSOCIATION (0h)		IDENTIFIER TYPE (1h)			
2	Reserved							
3	IDENTIFIER LENGTH (68)							
4	VENDOR IDENTIFICATION (7ATA-----)							
11	VENDOR SPECIFIC IDENTIFIER (see table 85)							
12								
71								

The PROTOCOL IDENTIFIER field shall be set to 0h.

The CODE SET field shall be set to 2h (i.e., ASCII).

The PIV bit shall be set to 0b.

The ASSOCIATION field shall be set to 0h (i.e., logical unit).

The IDENTIFIER TYPE field shall be set to 1h (i.e., T10 vendor identification).

The VENDOR IDENTIFICATION field contains the string 7ATA-----.

Byte 0
change
"PROTOCOL IDENTIFIER"
to
"PROTOCOL IDENTIFIER (0h)"

Status
risheffi Completed 6/23/2006 4:27:09 PM

Sequence number: 6
Author: DELL[KMarks]
Subject: Highlight
Date: 2/10/2006 9:21:44 PM

T **Table 84 — Logical unit name derived from the model number and serial number**

if keeping the format change byte 1
"ASSOCIATION (0h)"
to
"ASSOCIATION (00b)"

Status
risheffi Completed 6/23/2006 4:27:33 PM

Sequence number: 7
Author: WDC[CStevens]
Subject: Comment on Text
Date: 5/6/2006 5:30:36 PM

T What is this?

Note: This is how ASCII spaces are represented (see notational conventions), as defined in the T10 style guide. With actual spaces the reader would be unable to determine how many spaces are required.

Status
risheffi Rejected 5/6/2006 5:30:41 PM

Sequence number: 8
Author: DELL[KMarks]
Subject: Highlight
Date: 2/10/2006 9:24:32 PM

T 4th Paragraph after **Table 84 — Logical unit name derived from the model number and serial number**

change
"The ASSOCIATION field shall be set to 0h (i.e., logical unit)."
to
The ASSOCIATION field shall be set to 00b (i.e., logical unit)."

Status
risheffi Completed 6/23/2006 4:28:01 PM

Sequence number: 9
Author: WDC[CStevens]
Subject: Comment on Text
Date: 5/6/2006 5:31:18 PM

T What is this? It appears in the doc a couple of times...

Note: This is how ASCII spaces are represented (see notational conventions), as defined in the T10 style guide. With actual spaces the reader would be unable to determine how many spaces are required.

Status
risheffi Rejected 5/6/2006 5:31:23 PM

The **VENDOR SPECIFIC IDENTIFIER** field shall be set to a representation of the IDENTIFY DEVICE data **MODEL NUMBER** field concatenated with a representation of the IDENTIFY DEVICE data **SERIAL NUMBER** field as described in table 85.

Table 85 — VENDOR SPECIFIC IDENTIFIER field for logical unit name

Byte	Contents	
	Source field name	Source location
0		IDENTIFY DEVICE word 27 bits 15:8
1		IDENTIFY DEVICE word 27 bits 7:0
2	MODEL NUMBER ² field	IDENTIFY DEVICE word 28 bits 15:8
...		...
39		IDENTIFY DEVICE word 46 bits 7:0
40	SERIAL NUMBER ³ field	IDENTIFY DEVICE word 10 bits 15:8
41		IDENTIFY DEVICE word 10 bits 7:0
42		IDENTIFY DEVICE word 11 bits 15:8
...		...
59		IDENTIFY DEVICE word 19 bits 7:0

NOTE 9 The logical unit name using the T10 vendor identification format is not guaranteed to be worldwide unique, since ATA/ATAPI-7 only requires the combination of the **MODEL NUMBER** field and **SERIAL NUMBER** field to be unique for a given manufacturer but defines no manufacturer identification field.

10.3.4.3 Examples of additional identification descriptors

10.3.4.3.1 Identification descriptors included by a SATL in an ATA host

Figure 5 shows the identification descriptor returned by a SATL in an ATA host (i.e., where the ATA device is being accessed with an ATA host port) containing a logical unit name based on ATA IDENTIFY DEVICE data (see table 82 or table 84 in 10.3.4.2).

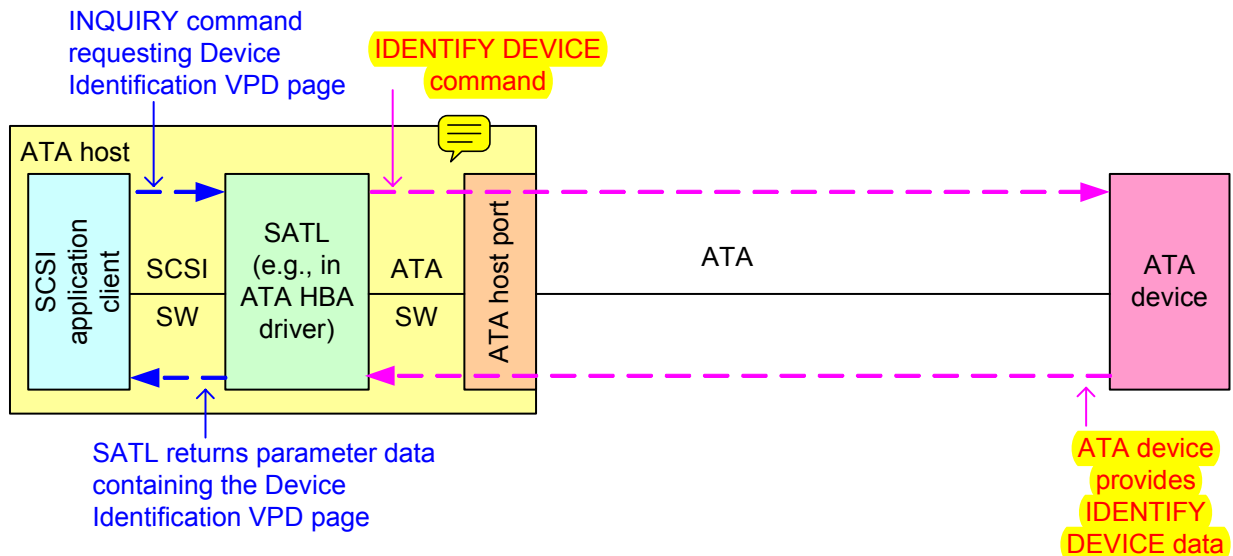

Figure 5 — Identification descriptors included by a SATL in an ATA host

Sequence number: 1
Author: DELL[KMarks]
Subject: Highlight
Date: 2/10/2006 9:31:41 PM

T 6th Paragraph after Table 84 — Logical unit name derived from the model number and serial number

change

"The **VENDOR SPECIFIC IDENTIFIER** field shall be set to a representation of the **IDENTIFY DEVICE** data **MODEL NUMBER** field concatenated with a representation of the **IDENTIFY DEVICE** data **SERIAL NUMBER** field as described in table 85."
to

"The **VENDOR SPECIFIC IDENTIFIER** field shall be set to a representation of the **ATA IDENTIFY DEVICE** data **Model number** field concatenated with a representation of the **ATA IDENTIFY DEVICE** data **Serial number** field as described in table 85."

Status
risheffi Completed 6/23/2006 4:29:26 PM

Sequence number: 2
Author: DELL[KMarks]
Subject: Highlight
Date: 2/16/2006 9:23:03 PM

T Table 85 — **VENDOR SPECIFIC IDENTIFIER** field for logical unit name

Column: **Source Field Name**

change

"**MODEL NUMBER** field"

to

"**Model number** field"

Status
risheffi Completed 6/23/2006 4:30:39 PM

Sequence number: 3
Author: DELL[KMarks]
Subject: Highlight
Date: 2/16/2006 9:23:46 PM

T Table 85 — **VENDOR SPECIFIC IDENTIFIER** field for logical unit name

Column: **Source Field Name**

change

"**SERIAL NUMBER** field"

to

"**Serial number** field"

Status
risheffi Completed 6/23/2006 4:30:51 PM

Sequence number: 4
Author: DELL[KMarks]
Subject: Highlight
Date: 5/25/2006 12:43:18 PM

T Note 9 after Table 85 — **VENDOR SPECIFIC IDENTIFIER** field for logical unit name

change

"**NOTE 9** The logical unit name using the **T10** vendor identification format is not guaranteed to be worldwide unique, since **ATA/ATAPI-7** only requires the combination of the **MODEL NUMBER** field and **SERIAL NUMBER** field to be unique for a given manufacturer but defines no manufacturer identification field."
to

"**NOTE 9** - The logical unit name using the **T10** vendor ID based format is not guaranteed to be worldwide unique, since **ATA/ATAPI-7** only requires the combination of the **Model number** field and **Serial number** field to be unique for a given manufacturer but defines no manufacturer identification field."
RESOLUTION: change to,

"**NOTE 9** - The logical unit name using the **T10** vendor ID based format is not guaranteed to be worldwide unique, since **ATA8-ACS** only requires the combination of the **Model number** field and **Serial number** field to be unique for a given manufacturer but defines no manufacturer identification field."

Status
risheffi Completed 6/23/2006 4:32:08 PM

The **VENDOR SPECIFIC IDENTIFIER** field shall be set to a representation of the IDENTIFY DEVICE data **MODEL NUMBER** field concatenated with a representation of the IDENTIFY DEVICE data **SERIAL NUMBER** field as described in table 85.

Table 85 — VENDOR SPECIFIC IDENTIFIER field for logical unit name

Byte	Contents	
	Source field name	Source location
0	MODEL NUMBER field	IDENTIFY DEVICE word 27 bits 15:8
1		IDENTIFY DEVICE word 27 bits 7:0
2		IDENTIFY DEVICE word 28 bits 15:8
...		...
39		IDENTIFY DEVICE word 46 bits 7:0
40	SERIAL NUMBER field	IDENTIFY DEVICE word 10 bits 15:8
41		IDENTIFY DEVICE word 10 bits 7:0
42		IDENTIFY DEVICE word 11 bits 15:8
...		...
59		IDENTIFY DEVICE word 19 bits 7:0

NOTE 9 The logical unit name using the T10 vendor identification format is not guaranteed to be worldwide unique, since ATA/ATAPI-7 only requires the combination of the **MODEL NUMBER** field and **SERIAL NUMBER** field to be unique for a given manufacturer but defines no manufacturer identification field.

10.3.4.3 Examples of additional identification descriptors

10.3.4.3.1 Identification descriptors included by a SATL in an ATA host

Figure 5 shows the identification descriptor returned by a SATL in an ATA host (i.e., where the ATA device is being accessed with an ATA host port) containing a logical unit name based on ATA IDENTIFY DEVICE data (see table 82 or table 84 in 10.3.4.2).

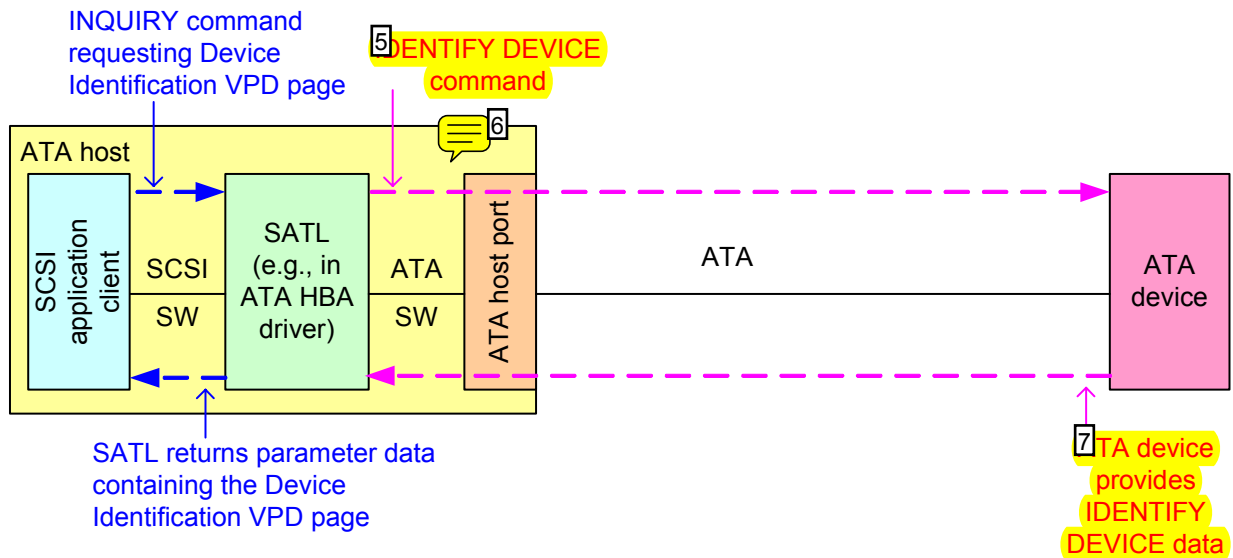



Figure 5 — Identification descriptors included by a SATL in an ATA host

Sequence number: 5
Author: DELL[KMarks]
Subject: Highlight
Date: 2/11/2006 10:43:04 AM

T In **Figure 5 — Identification descriptors included by a SATL in an ATA host**
change
"IDENTIFY DEVICE command"
to
"ATA IDENTIFY DEVICE command"

Status
rlsheffi Completed 6/23/2006 4:46:00 PM

Sequence number: 6
Author: WDC[CStevens]
Subject: Note
Date: 5/6/2006 7:58:08 PM

 I do not believe that an ATA host includes the SCSI application client. This is a SCSI host with an ATA host port.
EDITOR COMMENT: There is no such thing as a SCSI host, but I agree this is not an ATA host either.
RESOLUTION: delete "ATA host"

Status
rlsheffi Completed 6/23/2006 4:46:10 PM

Sequence number: 7
Author: DELL[KMarks]
Subject: Highlight
Date: 2/11/2006 5:03:56 PM

T In **Figure 5 — Identification descriptors included by a SATL in an ATA host**
change
"ATA device provides IDENTIFY DEVICE data"
to
"ATA device returns ATA IDENTIFY DEVICE data"

Status
rlsheffi Completed 6/23/2006 4:46:23 PM

10.3.4.3.2 Identification descriptors included by a SATL in a SAS initiator device

Figure 6 shows the identification descriptors returned by a SATL in a SAS initiator device (i.e., where the SATA device is being accessed with a SAS STP initiator port):

- a) a logical unit name based on ATA IDENTIFY DEVICE data (see table 82 or table 84 in 10.3.4.2);
- b) a target port identifier based on the SAS STP target port SAS address (see table 86); and
- c) a relative target port identifier set to 0001h (see SPC-3).

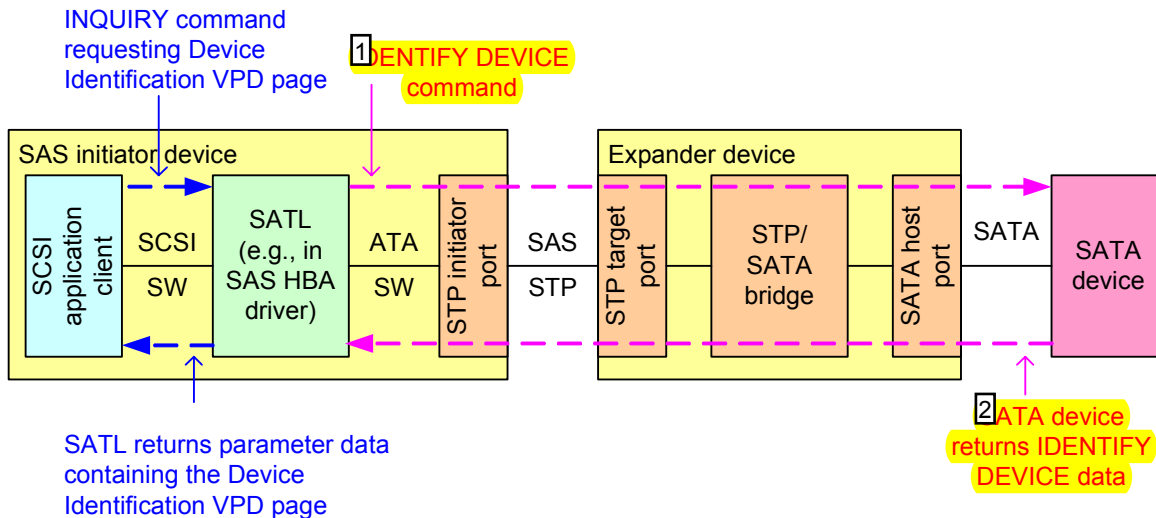

Figure 6 — Identification descriptors included by a SATL in a SAS initiator device

The SATL includes a target port identifier as defined in table 86.

Table 86 — Target port identifier for SAS

Byte\Bit	7	6	5	4	3	2	1	0
0	PROTOCOL IDENTIFIER (6h)				CODE SET (1h)			
1	PIV (1b)	Reserved	ASSOCIATION (3h)	IDENTIFIER TYPE (3h)				
2	Reserved							
3	IDENTIFIER LENGTH (08h)							
4	SAS ADDRESS							
11								

The CODE SET field is set to 1h (i.e., binary).

The PIV bit is set to one.

The ASSOCIATION field is set to 1h (i.e., target port).

The IDENTIFIER TYPE field is set to 3h (i.e., NAA).

The SAS ADDRESS field is set to the SAS address of the STP target port providing the STP/SATA bridge functionality (i.e., the SAS address of the SATA device).

Sequence number: 1
Author: DELL[KMarks]
Subject: Highlight
Date: 2/11/2006 5:05:09 PM

T In Figure 6 — Identification descriptors included by a SATL in a SAS initiator device

change
"IDENTIFY DEVICE command"
to
"ATA IDENTIFY DEVICE command"

Status
rlsheffi Completed 6/23/2006 4:46:35 PM

Sequence number: 2
Author: DELL[KMarks]
Subject: Highlight
Date: 2/11/2006 5:04:44 PM

T In Figure 6 — Identification descriptors included by a SATL in a SAS initiator device

change
"SATA device returns IDENTIFY DEVICE data"
to
"SATA device returns ATA IDENTIFY DEVICE data"

Status
rlsheffi Completed 6/23/2006 4:46:54 PM

Sequence number: 3
Author: DELL[KMarks]
Subject: Highlight
Date: 2/11/2006 11:26:00 AM

T In Table 86 — Target port identifier for SAS

change
"ASSOCIATION (1h)"
to
"ASSOCIATION (01b)"

Status
rlsheffi Completed 6/23/2006 4:47:44 PM

Sequence number: 4
Author: DELL[KMarks]
Subject: Highlight
Date: 2/11/2006 11:27:01 AM

T 3rd Paragraph after Table 86 — Target port identifier for SAS

change
"The ASSOCIATION field is set to 1h (i.e., target port)."
to
"The ASSOCIATION field is set to 01b (i.e., target port)."

Status
rlsheffi Completed 6/23/2006 4:48:06 PM

10.3.4.3.3 Identification descriptors included by a SATL in a SCSI to ATA protocol bridge

Figure 7 shows the identification descriptors returned by a SATL in a SCSI to ATA protocol bridge, where the ATA device is being accessed by an ATA host port, and the SATL is being accessed with a SCSI target port using a SCSI transport protocol (e.g., FCP-3 or iSCSI):

- a) a logical unit name based on **ATA IDENTIFY DEVICE data** (see table 82 or table 84 in 10.3.4.2);
- b) any target port identifiers specified by the SCSI transport protocol standard (e.g., for FCP-3, the SATL includes an identifier with identifier type 3h (i.e., NAA) containing the Port_Name, and may include an identifier with identifier type 4h (i.e., relative target port identifier)); and
- c) any other identification descriptors supported by the protocol bridge (e.g., a target device name).

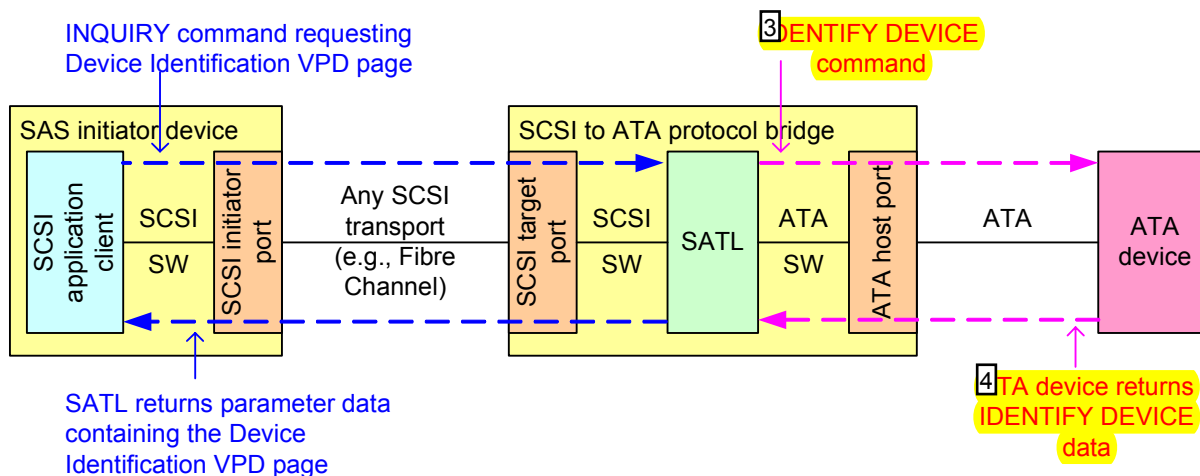

Figure 7 — Identification descriptors included by a SATL in a SCSI to ATA protocol bridge

10.3.5 ATA Information VPD page

The ATA Information VPD page shall contain:

- a) information about the SATL;
- b) Signature of the ATA or ATAPI device; and
- c) **IDENTIFY DEVICE or IDENTIFY PACKET DEVICE data from the ATA or ATAPI device.**

Sequence number: 1
Author: IBM[GPenokie]
Subject: Underline
Date: 2/16/2006 1:30:38 PM

T 10.3.4.3.3 Identification descriptors included by a SATL in a SCSI to ATA protocol bridge

Status
risheffi Cancelled 5/7/2006 8:15:55 AM

Sequence number: 2
Author: IBM[GPenokie]
Subject: Comment on Text
Date: 2/16/2006 11:05:34 AM

T item a
This << ATA IDENTIFY DEVICE data (see table 82 or table 84 in 10.3.4.2; >> should be << ATA IDENTIFY DEVICE data (see table 82 or table 84 in 10.3.4.2); >>

Status
risheffi Completed 6/23/2006 4:49:45 PM

Sequence number: 3
Author: DELL[KMarks]
Subject: Highlight
Date: 2/11/2006 5:02:26 PM

T In **Figure 7 — Identification descriptors included by a SATL in a SCSI to ATA protocol bridge**
change
"IDENTIFY DEVICE command"
to
"ATA IDENTIFY DEVICE command"

Status
risheffi Completed 6/23/2006 4:49:58 PM

Sequence number: 4
Author: DELL[KMarks]
Subject: Highlight
Date: 2/11/2006 5:03:36 PM

T In **Figure 7 — Identification descriptors included by a SATL in a SCSI to ATA protocol bridge**
change
"ATA device returns IDENTIFY DEVICE data"
to
"ATA device returns ATA IDENTIFY DEVICE data"

Status
risheffi Completed 6/23/2006 4:50:06 PM

Sequence number: 5
Author: EDITOR[risheffi]
Subject: Note
Date: 7/13/2006 12:35:58 AM

T **10.3 Vital product data parameters**
Add subclause 10.3.5 Mode Page Policy VPD page describing the Mode Page Policy VPD page for SAT (per 06-209).

Status
risheffi Completed 6/5/2006 1:50:23 PM

Sequence number: 6
Author: IBM[GPenokie]
Subject: Underline
Date: 2/16/2006 1:43:31 PM

T 10.3.5 ATA Information VPD page

Status
risheffi Cancelled 5/7/2006 8:17:51 AM

Sequence number: 7
Author: DELL[KMarks]
Subject: Note

10.3.4.3.3 Identification descriptors included by a SATL in a SCSI to ATA protocol bridge

Figure 7 shows the identification descriptors returned by a SATL in a SCSI to ATA protocol bridge, where the ATA device is being accessed by an ATA host port, and the SATL is being accessed with a SCSI target port using a SCSI transport protocol (e.g., FCP-3 or iSCSI):

- a logical unit name based on **ATA IDENTIFY DEVICE data (see table 82 or table 84 in 10.3.4.2;**
- any target port identifiers specified by the SCSI transport protocol standard (e.g., for FCP-3, the SATL includes an identifier with identifier type 3h (i.e., NAA) containing the Port_Name, and may include an identifier with identifier type 4h (i.e., relative target port identifier)); and
- any other identification descriptors supported by the protocol bridge (e.g., a target device name).

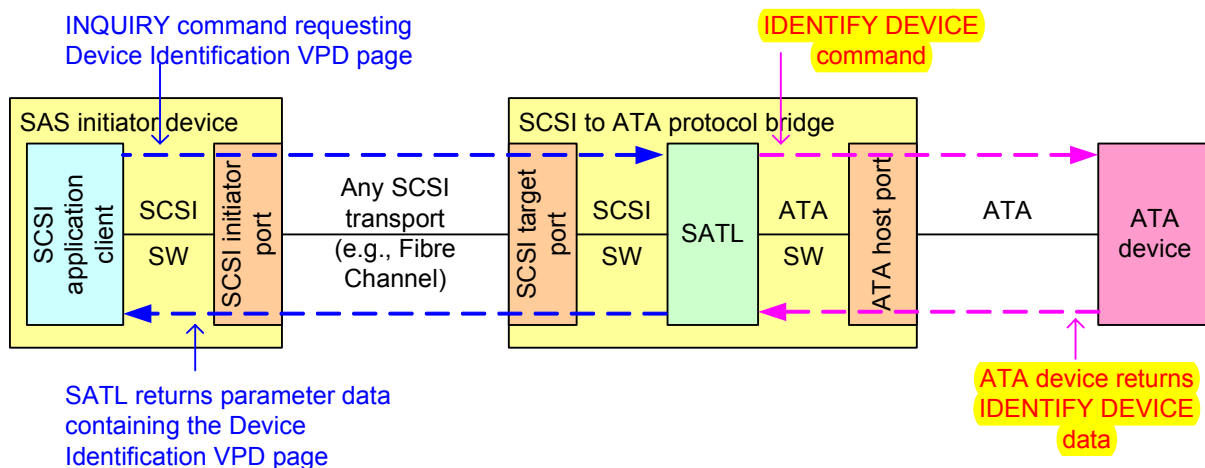



Figure 7 — Identification descriptors included by a SATL in a SCSI to ATA protocol bridge

10.3.5 ATA Information VPD page

The ATA Information VPD page shall contain:

- information about the SATL;
- Signature of the ATA or ATAPI device; and
- IDENTIFY DEVICE or IDENTIFY PACKET DEVICE data from the ATA or ATAPI device.**

Date: 5/7/2006 10:44:38 AM

 Why isn't the **ATA Information VPD** page in clause 12? Seems pretty **SAT** specific to me.
RESOLUTION: Move the subclause, 10.3.5 **ATA Information VPD** page, to clause 12 as subclause 12.4.2, and add brief text to subclause 12.1 (**SAT-Specific SCSI Extensions Overview**) to introduce the subclause:
"VPD pages defined for **SATL** implementations include:
a) **ATA Information VPD** page (see 12.4.2)."

Also add to clause 12 appropriate subheadings to introduce the **ATA Information VPD** page:
"12.4 **SAT-specific Vital Product Data**
12.4.1 **SAT-specific Vital Product Data overview**
This subclause defines **VPD** pages specific to **SAT** implementations."

Status
risheffi Completed 6/23/2006 7:32:18 PM

Sequence number: 8
Author: DELL[KMarks]
Subject: Highlight
Date: 2/10/2006 9:42:28 PM

 **10.3.5 ATA Information VPD** page
1st Paragraph c) in a,b,c list
change
"c) **IDENTIFY DEVICE** or **IDENTIFY PACKET DEVICE** data from the **ATA** or **ATAPI** device."
to
"c) **ATA IDENTIFY DEVICE** or **ATA IDENTIFY PACKET DEVICE** data from the **ATA** or **ATAPI** device."

Status
risheffi Completed 6/23/2006 7:33:09 PM

Sequence number: 9
Author: EDITOR[risheffi]
Subject: Note
Date: 5/9/2006 11:08:45 AM

 10.3.5 **ATA Information VPD** page
After the first a,b,c list add the following:
"Some **SATLs** may modify **ATA IDENTIFY DEVICE** data or **ATA IDENTIFY PACKET DEVICE** data. If a **SCSI** application client requires the unmodified **ATA IDENTIFY DEVICE** data or **ATA IDENTIFY PACKET DEVICE** data, then the **ATA PASS-THROUGH** command should be used to retrieve the **ATA IDENTIFY DEVICE** data or **ATA IDENTIFY PACKET DEVICE** data."

Note: Motion to include and accept from May-9 '06 **SAT WG**. 4 in favor, 1 against, and 6 abstentions.

Status
risheffi Completed 6/23/2006 7:35:20 PM

Table 87 defines the ATA Information VPD page.

Table 87 — ATA Information VPD page

Bit Byte	7	6	5	4	3	2	1	0
0	PERIPHERAL QUALIFIER			PERIPHERAL DEVICE TYPE				
1	PAGE CODE (89h)							
2	(MSB)	PAGE LENGTH (238h)						(LSB)
3								
4	Reserved							
7								
8	SAT VENDOR IDENTIFICATION							
15								
16	SAT PRODUCT IDENTIFICATION							
31								
32	SAT PRODUCT REVISION LEVEL							
35								
36	SIGNATURE							
55								
56	COMMAND CODE							
57								
59	Reserved							
60	IDENTIFY DEVICE or IDENTIFY PACKET DEVICE data							
571								

The PERIPHERAL QUALIFIER field and the PERIPHERAL DEVICE TYPE field shall be set as described in 8.1.2.

The PAGE CODE field shall be set to 89h.

The PAGE LENGTH field shall be set to 238h.

The SAT VENDOR IDENTIFICATION field shall contain an 8-byte ASCII string identifying the vendor of the SATL. The data shall be left aligned within the field. The vendor identification string shall be one assigned by INCITS for use in the Standard INQUIRY data VENDOR IDENTIFICATION field. A list of assigned vendor identification strings is in SPC-3 and on the T10 web site (<http://www.t10.org>).

The SAT PRODUCT IDENTIFICATION field shall contain sixteen bytes of ASCII data as defined by the vendor of the SATL. The data shall be left-aligned within the field.

The SAT PRODUCT REVISION LEVEL field shall contain four bytes of ASCII data as defined by the vendor of the SATL. The data shall be left-aligned within the field.

4 The SIGNATURE field shall contain the contents of the task file registers after the last power-on reset, hardware reset, software reset, or EXECUTE DEVICE DIAGNOSTIC command. It shall follow the format of the initial SATA Device-to-Host Register FIS (see ATA/ATAPI-7 V3). Tab. 3 defines the SIGNATURE field.

Page: 104

Sequence number: 1
Author: DELL[KMarks]
Subject: Highlight
Date: 6/23/2006 8:51:32 PM

T Is the SIGNATURE field really a field, since it is composed of more fields defined below? Should this be "Signature data (see Table 88)" and modify description text below?

RESOLUTION: change "signature field" to "ATA device signature (see x.y.z.w)", and restructure so that the description of the ATA device signature is in its own subclause.

Status
risheffi Completed 6/23/2006 8:51:36 PM

Sequence number: 2
Author: DELL[KMarks]
Subject: Highlight
Date: 6/23/2006 8:53:44 PM

T **Table 87 — ATA Information VPD page**
byte 60-571

change
"IDENTIFY DEVICE or IDENTIFY PACKET DEVICE data"

to
"IDENTIFY DEVICE OR IDENTIFY PACKET DEVICE DATA" in small CAPs, if this is indeed a field as indicated in the description further down.

RESOLUTION: s/b

"ATA IDENTIFY DEVICE data or ATA IDENTIFY PACKET DEVICE data (see 12.4.2.3)"
and restructure so the description is in its own subclause with consistent semantics.

Status
risheffi Completed 6/23/2006 8:53:47 PM

Sequence number: 3
Author: MXO[MEvans]
Subject: Highlight
Date: 6/23/2006 8:54:32 PM

T Table 87 and global: find all instances of "IDENTIFY DEVICE OR IDENTIFY PACKET DEVICE DATA", and, where ever it is used as a field name, make sure it is all in small caps.

RESOLUTION: s/b

"ATA IDENTIFY DEVICE data or ATA IDENTIFY PACKET DEVICE data (see 12.4.2.3)"
and restructure so the description is in its own subclause with consistent semantics.

Status
risheffi Completed 6/23/2006 8:54:35 PM

Sequence number: 4
Author: ELX[KHirata]
Subject: Note
Date: 6/23/2006 9:00:43 PM

 Location: Page 84, 10.3.5, SIGNATURE field description.

Comment:

The description for the SIGNATURE field indicates that the signature register values must be stored by the SATL so that they can be returned in the ATA Information VPD Page. For an HBA that may be communicating with a large number of attached targets this represents a potentially significant amount of storage space. Could the wording be changed to allow this data to be synthesized by the SATL given that the SATL must know the device type that is currently attached? This would allow the necessary storage requirements to be greatly reduced.

Preferred resolution:

We will be unable to support the storage of the signature FIS for each individual target. We either need a way to retrieve this information at command execution time, or must be able to create the data based on our knowledge of the attached device type.

REASON:

Most in the SAT WG advocate a general translation model that requires the SATL to maintain the results of the last ATA operation on a given ATA device until the results are retrieved or another ATA command is sent to the ATA device.

Comments from page 104 continued on next page

Table 87 defines the ATA Information VPD page.

Table 87 — ATA Information VPD page

Bit Byte	7	6	5	4	3	2	1	0
0	PERIPHERAL QUALIFIER			PERIPHERAL DEVICE TYPE				
1	PAGE CODE (89h)							
2	(MSB)	PAGE LENGTH (238h)						(LSB)
3								
4	Reserved							
7								
8								
15	SAT VENDOR IDENTIFICATION							
16								
31	SAT PRODUCT IDENTIFICATION							
32								
35	SAT PRODUCT REVISION LEVEL							
36								
55	SIGNATURE							
56	COMMAND CODE							
57								
59	Reserved							
60								
571	IDENTIFY DEVICE or IDENTIFY PACKET DEVICE data							

The PERIPHERAL QUALIFIER field and the PERIPHERAL DEVICE TYPE field shall be set as described in 8.1.2.





The PAGE CODE field shall be set to 89h.

The PAGE LENGTH field shall be set to 238h.

The SAT VENDOR IDENTIFICATION field shall contain an 8-byte ASCII string identifying the vendor of the SATL. The data shall be left aligned within the field. The vendor identification string shall be one assigned by INCITS for use in the Standard INQUIRY data VENDOR IDENTIFICATION field. A list of assigned vendor identification strings is in SPC-3 and on the T10 web site (<http://www.t10.org>).

The SAT PRODUCT IDENTIFICATION field shall contain sixteen bytes of ASCII data as defined by the vendor of the SATL. The data shall be left-aligned within the field.

The SAT PRODUCT REVISION LEVEL field shall contain four bytes of ASCII data as defined by the vendor of the SATL. The data shall be left-aligned within the field.

 The SIGNATURE field shall contain the contents of the task file registers after the last power-on reset, hardware reset, software reset, or EXECUTE DEVICE DIAGNOSTIC command  shall follow the format of the initial SATA Device-to-Host Register FIS (see ATA/ATAPI-7 ).  defines the SIGNATURE field.

Status

rsheffi Rejected 6/23/2006 9:01:30 PM

Sequence number: 5

Author: STX[GHoulder]

Subject: Note

Date: 6/24/2006 2:19:43 PM

 PDF page 104

section 10.3.5: "The SIGNATURE field..."

Table 88

- a) Why does the SIGNATURE field (bytes 0 and 1) have to contain this FIS header info even for a PATA device ?
- b) The reference to "ATA/ATAPI-7 V3" is not necessary if the FIS construction is removed.
(before and after table 88)

Discussion: What goes into the FIS header info if the device is a PATA device? Should the information reported by the SATL be more generic so that it applies the same to a PATA device or a SATA device?

RESOLUTION: See 06-291 - Marked PM_PORT field and INTERRUPT bit "reserved" if not SATA, and added a table footnote to bytes 2-13 (except 11) that the fields come from corresponding fields defined in ATA8-ACS.

Status

rsheffi Completed 6/24/2006 2:20:03 PM

Sequence number: 6

Author: MXO[MEvans]

Subject: Highlight

Date: 6/23/2006 9:04:35 PM

 10.3.5 ATA Information VPD page, ninth paragraph: change "It shall follow the format..." to "The SIGNATURE field shall follow the format..."

RESOLUTION: s/b

"The ATA device signature shall follow the format..."

Status

rsheffi Completed 6/23/2006 9:04:38 PM

Sequence number: 7

Author: DELL[KMarks]

Subject: Note

Date: 6/24/2006 3:49:58 PM

 If the ATA device is a PATA device, does the SIGNATURE contents still have the first byte set to 34h as the FIS type? Additionally, the FIS type is not part of the task file?

RESOLUTION: see 06-291

Status

rsheffi Completed 7/24/2006 11:33:19 AM

Sequence number: 8

Author: DELL[KMarks]

Subject: Highlight

Date: 6/24/2006 3:50:36 PM

 7th Paragraph, 3rd Sentence after **Table 87 — ATA Information VPD page** change

"Table 88 defines the SIGNATURE field."

to

"Table 88 defines the signature data."

DISCUSS: Need to define "signature data" as "the contents of the task file registers ..." (or whatever we decide is appropriate, and then define the "ATA device signature " as containing "signature data". Perhaps "signature data" could be different for a SATA device versus a PATA device?

RESOLUTION: see 06-291

Status

rsheffi Completed 7/24/2006 11:33:25 AM

Sequence number: 9

Author: ENDL[RWeber]

Date: 6/23/2006 9:06:24 PM

 last p on pg

"V3" might be confused with "Version 3". Recommend spelling out "Volume".

Comments from page 104 continued on next page

Table 87 defines the ATA Information VPD page.

Table 87 — ATA Information VPD page

Bit Byte	7	6	5	4	3	2	1	0
0	PERIPHERAL QUALIFIER			PERIPHERAL DEVICE TYPE				
1	PAGE CODE (89h)							
2	(MSB)	PAGE LENGTH (238h)						(LSB)
3								
4	Reserved							
7								
8	SAT VENDOR IDENTIFICATION							
15								
16	SAT PRODUCT IDENTIFICATION							
31								
32	SAT PRODUCT REVISION LEVEL							
35								
36	SIGNATURE							
55								
56	COMMAND CODE							
57								
59	Reserved							
60	IDENTIFY DEVICE or IDENTIFY PACKET DEVICE data							
571								

The PERIPHERAL QUALIFIER field and the PERIPHERAL DEVICE TYPE field shall be set as described in 8.1.2.

The PAGE CODE field shall be set to 89h.

The PAGE LENGTH field shall be set to 238h.

The SAT VENDOR IDENTIFICATION field shall contain an 8-byte ASCII string identifying the vendor of the SATL. The data shall be left aligned within the field. The vendor identification string shall be one assigned by INCITS for use in the Standard INQUIRY data VENDOR IDENTIFICATION field. A list of assigned vendor identification strings is in SPC-3 and on the T10 web site (<http://www.t10.org>).

The SAT PRODUCT IDENTIFICATION field shall contain sixteen bytes of ASCII data as defined by the vendor of the SATL. The data shall be left-aligned within the field.

The SAT PRODUCT REVISION LEVEL field shall contain four bytes of ASCII data as defined by the vendor of the SATL. The data shall be left-aligned within the field.

The SIGNATURE field shall contain the contents of the task file registers after the last power-on reset, hardware reset, software reset, or EXECUTE_DEVICE DIAGNOSTIC command. It shall follow the format of the initial SATA Device-to-Host Register FIS (see ATA/ATAPI-7 V3). Table 87 defines the SIGNATURE field.

RESOLUTION: s/b
(see SATA 2.5)

Status
rlsheffi Completed 6/23/2006 9:06:27 PM

Sequence number: 10
Author: EDITOR[rlsheffi]
Subject: Highlight
Date: 6/23/2006 9:07:02 PM

T 10.3.5 ATA Information VPD page
Ninth paragraph (describing the SIGNATURE field)
change
"(see ATA/ATAPI-7 V3)"
to
"(see SATA 2.5)"

Status
rlsheffi Completed 6/23/2006 9:07:05 PM

Table 88 — SIGNATURE field

Bit Byte	7	6	5	4	3	2	1	0
0	FIS TYPE (4h)							
1	Reserved	4 INTERRUPT	Reserved		3 M PORT			
2	STATUS							
3	ERROR							
4	LBA LOW							
5	LBA MID							
6	LBA HIGH							
7	DEVICE							
8	LBA LOW EXP							
9	LBA MID EXP							
10	LBA HIGH EXP							
11	Reserved							
12	SECTOR COUNT							
13	SECTOR COUNT EXP							
14	Reserved							
19	Reserved							

All fields within the SIGNATURE field are defined in ATA/ATAPI-7 V1 and ATA/ATAPI-7 V3.

Table 89 lists common signature values for fields within the SIGNATURE field.

Table 89 — Common signature values (informative)

Field	ATA device	ATAPI device
SECTOR COUNT	01h	01h
LBA LOW	01h	01h
LBA MID/BYTE COUNT LOW	00h	14h
LBA HIGH/BYTE COUNT HIGH	00h	EBh
DEVICE	00h	00h

The COMMAND CODE field contains the command code used to retrieve the data in the IDENTIFY DEVICE or IDENTIFY PACKET DEVICE DATA field (e.g., ECh for IDENTIFY DEVICE (i.e., the ATA device type) or A1h for IDENTIFY PACKET DEVICE (i.e., the ATAPI device type) or 00h for other device types).

The IDENTIFY DEVICE OR IDENTIFY PACKET DEVICE DATA field contains:

- a) if the device is an ATA device, the IDENTIFY DEVICE data (see ATA/ATAPI-7 V1). If the IDENTIFY DEVICE command fails, 512 bytes each set to 00h;
- b) if the device is an ATAPI device, the IDENTIFY PACKET DEVICE data (see ATA/ATAPI-7 V1). If the IDENTIFY PACKET DEVICE command fails, 512 bytes each set to 00h; or
- c) if the device is any other device type, 512 bytes each set to 00h.

Sequence number: 1
Author: DELL[KMarks]
Subject: Highlight
Date: 6/23/2006 9:08:07 PM
T Table 88 — SIGNATURE field

change table title to
"Table 88 — Signature data"
RESOLUTION: s/b
"Table 88 — ATA device signature"

Status
rlsheffi Completed 6/23/2006 9:08:10 PM

Sequence number: 2
Author: DELL[KMarks]
Subject: Highlight
Date: 6/23/2006 9:25:20 PM
T Table 88 — SIGNATURE field

byte 0 - FIS TYPE (34)
What about for PATA device?
Suggested resolution: Make bytes 0 and 1 reserved (but are there issues with PM field?)

RESOLUTION:
Rename this to be the TRANSPORT IDENTIFIER field and add a table of values:

00h	PATA
34h	SATA
other	Reserved

Add a table footnote to the INTERRUPT and PM PORT fields in the ATA device signature table: "The interrupt field and the pm port field are defined only if the transport identifier field is set to 34h (see SATA 2.5). Otherwise the interrupt field and the pm port field are reserved."

Status
rlsheffi Completed 6/23/2006 9:24:11 PM

Sequence number: 3
Author: DELL[KMarks]
Subject: Highlight
Date: 5/7/2006 8:43:31 AM
T DISCUSS: w/ C Stevens, J Hatfield, Kevin Marks, R. Elliott

Table 88 — SIGNATURE field
byte 1 - PM PORT

PM Port for PATA?
Suggested resolution: Make bytes 0 and 1 reserved (but are there issues with PM field?)

RESOLUTION:
Add a description for the PM_PORT field. PM_PORT field is reserved if the TRANSPORT IDENTIFIER field is not 34h.
Add reference to SATA 2.5.

Status
rlsheffi Completed 6/23/2006 9:25:25 PM

Sequence number: 4
Author: EDITOR[rlsheffi]
Subject: Highlight
Date: 5/7/2006 8:45:35 AM
T Table 88 — SIGNATURE field

byte 1 - INTERRUPT

RESOLUTION:
Add a description of the INTERRUPT field. The INTERRUPT field is reserved if the TRANSPORT IDENTIFIER field is not 34h.
Specify that this corresponds to the "i" bit bit 14 of dword 0 of the device to host register FIS.

Status
rlsheffi Completed 6/23/2006 9:38:44 PM

Table 88 — SIGNATURE field

Bit Byte	7	6	5	4	3	2	1	0
0	FIS TYPE (34h)							
1	Reserved	INTERRUPT	Reserved		PM PORT			
2	STATUS							
3	ERROR							
4	LBA LOW							
5	LBA MID							
6	LBA HIGH							
7	DEVICE							
8	LBA LOW EXP							
9	LBA MID EXP							
10	LBA HIGH EXP							
11	Reserved							
12	SECTOR COUNT							
13	SECTOR COUNT EXP							
14	Reserved							
19	Reserved							

All fields within the SIGNATURE field are defined in ATA/ATAPI-7 V1 and ATA/ATAPI-7 V3.

Table 89 lists common signature values for fields within the SIGNATURE field.

Table 89 — Common signature values (informative)

Field	ATA device	ATAPI device
SECTOR COUNT	01h	01h
LBA LOW	01h	01h
LBA MID/BYTE COUNT LOW	00h	14h
LBA HIGH/BYTE COUNT HIGH	00h	EBh
DEVICE	00h	00h

The COMMAND CODE field contains the command code used to retrieve the data in the IDENTIFY DEVICE or IDENTIFY PACKET DEVICE DATA field (e.g., ECh for IDENTIFY DEVICE (i.e., the ATA device type) or A1h for IDENTIFY PACKET DEVICE (i.e., the ATAPI device type) or 00h for other device types).

The IDENTIFY DEVICE OR IDENTIFY PACKET DEVICE DATA field contains:

- a) if the device is an ATA device, the IDENTIFY DEVICE data (see ATA/ATAPI-7 V1). If the IDENTIFY DEVICE command fails, 512 bytes each set to 00h;
- b) if the device is an ATAPI device, the IDENTIFY PACKET DEVICE data (see ATA/ATAPI-7 V1). If the IDENTIFY PACKET DEVICE command fails, 512 bytes each set to 00h; or
- c) if the device is any other device type, 512 bytes each set to 00h.

Sequence number: 5
Author: DELL[KMarks]
Subject: Note
Date: 6/23/2006 9:40:32 PM

Table 88 -

Editorially, can you have fields within a field.

RESOLUTION: Change the title of this table to be **"ATA device signature", and change other references accordingly.**

Status
risheffi Completed 6/23/2006 9:40:35 PM

Sequence number: 6
Author: WDC[CStevens]
Subject: Comment on Text
Date: 6/23/2006 9:41:22 PM

T or ATA8-ACS.

RESOLUTION (also, see DELL comment): change
"ATA/ATAPI-7 V1 and ATA/ATAPI-7 V3"

to
"ATA8-APT and SATA 2.5"

Status
risheffi Completed 6/23/2006 9:41:26 PM

Sequence number: 7
Author: ENDL[RWeber]
Date: 6/23/2006 9:41:52 PM

T 1st p after table 88

"V1" and "V3" might be confused with "Version 1" and "Version 3". Recommend spelling out "Volume".

RESOLUTION (also, see DELL comment): change
"ATA/ATAPI-7 V1 and ATA/ATAPI-7 V3"

to
"ATA8-APT and SATA 2.5"

Status
risheffi Completed 6/24/2006 1:22:11 PM

Sequence number: 8
Author: DELL[KMarks]
Subject: Highlight
Date: 5/25/2006 1:04:57 PM

T Do we want signatures for SATA PM and SATA Encl Management device?

Do we want to change the ATA/ATAPI-7 V3 reference to SATA 2.5 (probably yes)?

Should we have a reference to an ATA/ATAPI-7 amendment that fixes a signature issue?

Reference is: ANSI INCITS 397-2005 ATA/ATAPI-7 Amendment (just passed T13 letter ballot to forward to INCITS for public review).

1st Paragraph after Table 88

change

"All fields within the SIGNATURE field are defined in ATA/ATAPI-7 V1 and ATA/ATAPI-7 V3."

to

"All fields within the signature data (table 88) are defined in ATA/ATAPI-7 V1 and ATA/ATAPI-7 V3."

The "PM PORT" is not defined in ATA/ATAPI-7, it is only defined in SATA-2.5. Additionally all the fields in Table 88 are from an editorial perspective not defined in ATA/ATAPI-7, for example STATUS is not, but Status is. Does the standard need a text/footnote saying STATUS=Status, etc.?

RESOLUTION:

Add a table footnote to Table 88: "These fields are fields with the same names defined in ATA8-ACS" Applies to fields in bytes2 through 13 (not byte 11).

Status
risheffi Completed 6/23/2006 9:44:50 PM

Sequence number: 9
Author: STX[GHolder]
Subject: Highlight
Date: 9/13/2006 9:04:43 AM

Comments from page 105 continued on next page

Table 88 — SIGNATURE field

Bit Byte	7	6	5	4	3	2	1	0
0	FIS TYPE (34h)							
1	Reserved	INTERRUPT	Reserved		PM PORT			
2	STATUS							
3	ERROR							
4	LBA LOW							
5	LBA MID							
6	LBA HIGH							
7	DEVICE							
8	LBA LOW EXP							
9	LBA MID EXP							
10	LBA HIGH EXP							
11	Reserved							
12	SECTOR COUNT							
13	SECTOR COUNT EXP							
14	Reserved							
19	Reserved							

All fields within the SIGNATURE field are defined in ATA/ATAPI-7 V1 and ATA/ATAPI-7 V3.

Table 89 lists common signature values for fields within the SIGNATURE field.

Table 89 — Common signature values (informative)

Field	ATA device	ATAPI device
SECTOR COUNT	01h	01h
LBA LOW	01h	01h
LBA MID/BYTE COUNT LOW	00h	14h
LBA HIGH/BYTE COUNT HIGH	00h	EBh
DEVICE	12h	00h

The COMMAND CODE field contains the command code used to retrieve the data in the IDENTIFY DEVICE or IDENTIFY PACKET DEVICE DATA field (e.g., ECh for IDENTIFY DEVICE (i.e., the ATA device type) or A1h for IDENTIFY PACKET DEVICE (i.e., the ATAPI device type) or 00h for other device types).

The IDENTIFY DEVICE OR IDENTIFY PACKET DEVICE DATA field contains:

- a) if the device is an ATA device, the IDENTIFY DEVICE data (see ATA/ATAPI-7 V1). If the IDENTIFY DEVICE command fails, 512 bytes each set to 00h;
- b) if the device is an ATAPI device, the IDENTIFY PACKET DEVICE data (see ATA/ATAPI-7 V1). If the IDENTIFY PACKET DEVICE command fails, 512 bytes each set to 00h; or
- c) if the device is any other device type, 512 bytes each set to 00h.

T PDF page 105

Table 89

For the device types listed, the signature is normative (not informative). For other device types, say 'unspecified'
RESOLUTION: Remove table 89 and introductory sentence.

Status

risheffi Completed 9/13/2006 9:04:46 AM

Sequence number: 10

Author: DELL[KMarks]

Subject: Highlight

Date: 6/23/2006 9:49:40 PM

T Table 89 — Common signature values (informative)

Remove Table 89 - it provides no value, if for some reason the signature does not match this, then what?

or

Values in Field column should not be in small caps.

RESOLUTION: Remove small caps:

"Sector count

LBA Low

LBA Mid/Byte Count Low

LBA High/Byte Count High

Device"

Status

risheffi Completed 6/23/2006 9:49:43 PM

Sequence number: 11

Author: IBM[GPenokie]

Subject: Comment on Text

Date: 9/13/2006 9:04:01 AM

T table 89

The title should remove the << (informative) >> term. It has little or no meaning or value.

RESOLUTION: Remove table 89 and introductory sentence.

Status

risheffi Completed 9/13/2006 9:04:04 AM

Sequence number: 12

Author: STX[GHolder]

Subject: Highlight

Date: 9/13/2006 9:04:15 AM

T PDF page 105

Table 89

The DEVICE register is not part of the signature (per ATA/ATAPI-7)

RESOLUTION: Remove table 89 and introductory sentence.

Status

risheffi Completed 9/13/2006 9:04:19 AM

Sequence number: 13

Author: DELL[KMarks]

Subject: Highlight

Date: 5/7/2006 8:59:23 AM

T 1st Paragraph after Table 89 — Common signature values (informative)

change

"The COMMAND CODE field contains the command code used to retrieve the data in the IDENTIFY DEVICE or IDENTIFY PACKET DEVICE DATA field (e.g., ECh for IDENTIFY DEVICE (i.e., the ATA device type) or 01h for IDENTIFY PACKET DEVICE (i.e., the ATAPI device type) or 00h for other device types)."

to

"The COMMAND CODE field contains the ATA command code used to retrieve the data in the IDENTIFY DEVICE OR IDENTIFY PACKET DEVICE DATA field (e.g., ECh for IDENTIFY DEVICE (i.e., the ATA device type), 01h for IDENTIFY PACKET DEVICE (i.e., the ATAPI device type) or 00h for other device types)."

RESOLUTION: See MXO comment

Status

risheffi Completed 6/23/2006 9:53:04 PM

Sequence number: 14

Author: MXO[MEvans]

Subject: Highlight

Comments from page 105 continued on next page

Table 88 — SIGNATURE field

Bit Byte	7	6	5	4	3	2	1	0
0	FIS TYPE (34h)							
1	Reserved	INTERRUPT	Reserved		PM PORT			
2	STATUS							
3	ERROR							
4	LBA LOW							
5	LBA MID							
6	LBA HIGH							
7	DEVICE							
8	LBA LOW EXP							
9	LBA MID EXP							
10	LBA HIGH EXP							
11	Reserved							
12	SECTOR COUNT							
13	SECTOR COUNT EXP							
14	Reserved							
19	Reserved							

All fields within the SIGNATURE field are defined in ATA/ATAPI-7 V1 and ATA/ATAPI-7 V3.

Table 89 lists common signature values for fields within the SIGNATURE field.

Table 89 — Common signature values (informative)

Field	ATA device	ATAPI device
SECTOR COUNT	01h	01h
LBA LOW	01h	01h
LBA MID/BYTE COUNT LOW	00h	14h
LBA HIGH/BYTE COUNT HIGH	00h	EBh
DEVICE	00h	00h

The COMMAND CODE field contains the command code used to retrieve the data in the IDENTIFY DEVICE or IDENTIFY PACKET DEVICE DATA field (e.g., ECh for IDENTIFY DEVICE (i.e., the ATA device type) or A1h for IDENTIFY PACKET DEVICE (i.e., the ATAPI device type) or 00h for other device types).

¹⁵ The IDENTIFY DEVICE OR IDENTIFY PACKET DEVICE DATA field contains:

- a) if the device is an ATA device, the IDENTIFY DEVICE data (see ATA/ATAPI-7 ¹⁶). If the IDENTIFY DEVICE command fails, 512 bytes each set to 00h;
- b) if the device is an ATAPI device, the IDENTIFY PACKET DEVICE data (see ATA/ATAPI-7 V1). If the IDENTIFY PACKET DEVICE command fails, 512 bytes each set to 00h; or
- c) if the device is any other device type, 512 bytes each set to 00h.

Date: 5/7/2006 8:59:12 AM

T 10.3.5 ATA Information VPD page, twelfth paragraph: change to:

The COMMAND CODE field contains the command code used to retrieve the data in the IDENTIFY DEVICE or IDENTIFY PACKET DEVICE DATA field. The possible command codes are:

- a) ECh for an IDENTIFY DEVICE command (i.e., for an ATA device);
- b) A1h for an IDENTIFY PACKET DEVICE command (i.e., for an ATAPI device); or
- c) 00h for other device types.

RESOLUTION: s/b

"The COMMAND CODE field contains the command code of the ATA command used to retrieve the data in the IDENTIFY DEVICE or IDENTIFY PACKET DEVICE DATA field. The possible command codes are:

- a) ECh for an IDENTIFY DEVICE command (i.e., for an ATA device);
- b) A1h for an IDENTIFY PACKET DEVICE command (i.e., for an ATAPI device); or
- c) 00h for other device types."

Status

risheffi Completed 6/23/2006 9:52:28 PM

Sequence number: 15

Author: MXO[MEvans]

Subject: Highlight

Date: 5/25/2006 1:15:39 PM

T 10.3.5 ATA Information VPD page, thirteenth paragraph: change to be as follows:

If the command was an IDENTIFY DEVICE command, and the command was successful, then the IDENTIFY DEVICE OR IDENTIFY PACKET DEVICE DATA field shall contain the IDENTIFY DEVICE data (see ATA/ATAPI-7 V1).

If the command was an IDENTIFY PACKET DEVICE command, and the command was successful, then the IDENTIFY DEVICE OR IDENTIFY PACKET DEVICE DATA field shall contain the IDENTIFY PACKET DEVICE data (see ATA/ATAPI-7 V1).

The IDENTIFY DEVICE OR IDENTIFY PACKET DEVICE DATA field shall contains 512 bytes of 00h if:

- a) the command was an IDENTIFY DEVICE command or an IDENTIFY PACKET DEVICE command and the command failed; or
- b) the command code was 00h (i.e., some other device type).

RESOLUTION: s/b

"If the command is an ATA IDENTIFY DEVICE command, and the command completes without error, then the IDENTIFY DEVICE OR IDENTIFY PACKET DEVICE DATA field shall contain the ATA IDENTIFY DEVICE data (ATA8-ACS).

If the command is an ATA IDENTIFY PACKET DEVICE command, and the command completes without error, then the IDENTIFY DEVICE OR IDENTIFY PACKET DEVICE DATA field shall contain the IDENTIFY PACKET DEVICE data (see ATA8-ACS).

The IDENTIFY DEVICE OR IDENTIFY PACKET DEVICE DATA field shall contains 512 bytes of 00h if:

- a) the command is an IDENTIFY DEVICE command or an IDENTIFY PACKET DEVICE command and the command completes with an error; or
- b) the command code is 00h (i.e., some other device type)."

Status

risheffi Completed 6/23/2006 9:59:20 PM

Sequence number: 16

Author: ENDL[RWeber]

Date: 5/25/2006 1:16:14 PM

T a,b,c list after table 89, entries a and b

"V1" might be confused with "Version 1". Recommend spelling out "Volume".

[two times in this list]

RESOLUTION:

change

"ATA/ATAPI-7 V1"

to

"ATA8-ACS"

Table 88 — SIGNATURE field

Bit Byte	7	6	5	4	3	2	1	0
0	FIS TYPE (34h)							
1	Reserved	INTERRUPT	Reserved		PM PORT			
2	STATUS							
3	ERROR							
4	LBA LOW							
5	LBA MID							
6	LBA HIGH							
7	DEVICE							
8	LBA LOW EXP							
9	LBA MID EXP							
10	LBA HIGH EXP							
11	Reserved							
12	SECTOR COUNT							
13	SECTOR COUNT EXP							
14	Reserved							
19	Reserved							

All fields within the SIGNATURE field are defined in ATA/ATAPI-7 V1 and ATA/ATAPI-7 V3.

Table 89 lists common signature values for fields within the SIGNATURE field.

Table 89 — Common signature values (informative)

Field	ATA device	ATAPI device
SECTOR COUNT	01h	01h
LBA LOW	01h	01h
LBA MID/BYTE COUNT LOW	00h	14h
LBA HIGH/BYTE COUNT HIGH	00h	EBh
DEVICE	00h	00h

The COMMAND CODE field contains the command code used to retrieve the data in the IDENTIFY DEVICE or IDENTIFY PACKET DEVICE DATA field (e.g., ECh for IDENTIFY DEVICE (i.e., the ATA device type) or A1h for IDENTIFY PACKET DEVICE (i.e., the ATAPI device type) or 00h for other device types).

The IDENTIFY DEVICE OR IDENTIFY PACKET DEVICE DATA field contains:

- a) if the device is an ATA device, the IDENTIFY DEVICE data (see ATA/ATAPI-7 V1). If the IDENTIFY DEVICE command fails, 512 bytes each set to 00h;
- b) if the device is an ATAPI device, the IDENTIFY PACKET DEVICE data (see ATA/ATAPI-7 V1). If the IDENTIFY PACKET DEVICE command fails, 512 bytes each set to 00h; or
- c) if the device is any other device type, 512 bytes each set to 00h.

Status
risheffi Completed 6/23/2006 9:59:33 PM

Sequence number: 17
Author: DELL[KMarks]
Subject: Highlight
Date: 5/7/2006 9:07:14 AM

T 2nd Paragraph after Table 89 — Common signature values (informative)
a,b,c list

change

" a) if the device is an ATA device, the IDENTIFY DEVICE data (see ATA/ATAPI-7 V1). If the IDENTIFY DEVICE command fails, 512 bytes each set to 00h;
b) if the device is an ATAPI device, the IDENTIFY PACKET DEVICE data (see ATA/ATAPI-7 V1). If the IDENTIFY PACKET DEVICE command fails, 512 bytes each set to 00h; or
c) if the device is any other device type, 512 bytes each set to 00h."

to

" a) if the device is an ATA device, the ATA IDENTIFY DEVICE data. If the ATA IDENTIFY DEVICE command completes with an error, the SATL shall set each of the 512 bytes to 00h;
b) if the device is an ATAPI device, the ATA IDENTIFY PACKET DEVICE data. If the ATA IDENTIFY PACKET DEVICE command completes with an error, the SATL shall set each of the 512 bytes to 00h; or
c) if the device is any other device type, the SATL shall set each of the 512 bytes to 00h."

RESOLUTION: see MXO comment

Status
risheffi Completed 6/23/2006 9:59:47 PM

Sequence number: 18
Author: ENDL[RWeber]
Date: 5/25/2006 1:16:51 PM

T RESOLUTION:

change

"ATA/ATAPI-7 V1"

to

"ATA8-ACS"

Status
risheffi Completed 6/23/2006 10:00:08 PM

The data shall be presented with byte preservation (i.e., ATA byte n maps to SCSI byte n), as shown in table 90.

Table 90 — IDENTIFY DEVICE OR IDENTIFY PACKET DEVICE DATA field

Byte	Contents
0	IDENTIFY DEVICE OR IDENTIFY PACKET DEVICE word 0 bits 7:0 (i.e., byte 0)
1	IDENTIFY DEVICE OR IDENTIFY PACKET DEVICE word 0 bits 15:8 (i.e., byte 1)
2	IDENTIFY DEVICE OR IDENTIFY PACKET DEVICE word 1 bits 7:0 (i.e., byte 2)
3	IDENTIFY DEVICE OR IDENTIFY PACKET DEVICE word 1 bits 15:8 (i.e., byte 3)
...	...
510	IDENTIFY DEVICE OR IDENTIFY PACKET DEVICE word 255 bits 7:0 (i.e., the SIGNATURE field)
511	IDENTIFY DEVICE OR IDENTIFY PACKET DEVICE word 255 bits 15:8 (i.e., the CHECKSUM field)

NOTE 10 Although the SERIAL NUMBER field (words 5 to 19), FIRMWARE REVISION field (words 43 to 26), and MODEL NUMBER field (words 27-46) contain ASCII characters, every other byte is swapped within them (see ATA/ATAPI-7 V1). For example, the SERIAL NUMBER field is interpreted as: {word 10 bits 15:8, word 10 bits 7:0, word 11 bits 15:8, word 11 bits 7:0,...}, which corresponds to these bytes in the IDENTIFY DEVICE DATA field: {byte 21, byte 20, byte 23, byte 22,...}.

Since some of the fields within the IDENTIFY DEVICE command and IDENTIFY PACKET DEVICE command may change depending on the state of the attached ATA device, the SATL shall reissue the IDENTIFY DEVICE command or IDENTIFY PACKET DEVICE command to retrieve updated data whenever the ATA Information VPD page is requested.

Sequence number: 1
Author: DELL[KMarks]
Subject: Highlight
Date: 2/16/2006 9:33:49 PM

T **Table 90** — IDENTIFY DEVICE OR IDENTIFY PACKET DEVICE DATA field
byte 0

change

"IDENTIFY DEVICE OR IDENTIFY PACKET DEVICE word 0 bits 7:0 (i.e., byte 0)"

to

"ATA IDENTIFY DEVICE or ATA IDENTIFY PACKET DEVICE word 0 bits (7:0) (i.e., byte 0)"

change other rows similarly in table.

Status
rlsheffi Completed 6/23/2006 10:03:32 PM

Sequence number: 2
Author: DELL[KMarks]
Subject: Highlight
Date: 6/23/2006 10:04:44 PM

T **Table 90** — IDENTIFY DEVICE OR IDENTIFY PACKET DEVICE DATA field
in byte 510

change

"(i.e., the SIGNATURE field)"

to

(i.e., the Signature field)"

RESOLUTION: s/b

"(i.e., the signature byte of the Integrity word, see ATA8-ACS)"

Status
rlsheffi Completed 6/23/2006 10:04:47 PM

Sequence number: 3
Author: DELL[KMarks]
Subject: Highlight
Date: 6/23/2006 10:05:21 PM

T **Table 90** — IDENTIFY DEVICE OR IDENTIFY PACKET DEVICE DATA field
in byte 511

change

"(i.e., the CHECKSUM field)"

to

"(i.e., the Checksum field)"

RESOLUTION: s/b

"(i.e., the checksum byte of the Integrity word, see ATA8-ACS)"

Status
rlsheffi Completed 6/23/2006 10:05:30 PM

Sequence number: 4
Author: HPQ[RElliott]
Subject: Highlight
Date: 6/23/2006 10:08:58 PM

T 10.3.5

change "23 to 26" to "26:23"

RESOLUTION:

change "(words 23 to 26)"

to "(i.e., words 26:23)"

Status
rlsheffi Completed 6/23/2006 10:09:12 PM

Sequence number: 5
Author: HPQ[RElliott]
Subject: Highlight

The data shall be presented with byte preservation (i.e., ATA byte n maps to SCSI byte n), as shown in table 90.

Table 90 — IDENTIFY DEVICE OR IDENTIFY PACKET DEVICE DATA field

Byte	Contents
0	IDENTIFY DEVICE OR IDENTIFY PACKET DEVICE word 0 bits 7:0 (i.e., byte 0)
1	IDENTIFY DEVICE OR IDENTIFY PACKET DEVICE word 0 bits 15:8 (i.e., byte 1)
2	IDENTIFY DEVICE OR IDENTIFY PACKET DEVICE word 1 bits 7:0 (i.e., byte 2)
3	IDENTIFY DEVICE OR IDENTIFY PACKET DEVICE word 1 bits 15:8 (i.e., byte 3)
...	...
510	IDENTIFY DEVICE OR IDENTIFY PACKET DEVICE word 255 bits 7:0 (i.e., the SIGNATURE field)
511	IDENTIFY DEVICE OR IDENTIFY PACKET DEVICE word 255 bits 15:8 (i.e., the CHECKSUM field)

NOTE 10 Although the SERIAL NUMBER field (words 10 to 19), FIRMWARE REVISION field (words 23 to 26), and MODEL NUMBER field (words 47-46) contain ASCII characters, every other byte is swapped within them (see ATA/ATAPI-7 [91]). For example, the SERIAL NUMBER field is interpreted as: {word 10 bits 15:8, word 10 bits 7:0, word 11 bits 15:8, word 11 bits 7:0,...}, which corresponds to these bytes in the IDENTIFY DEVICE DATA field: {byte 21, byte 20, byte 23, byte 22,...}.

Since some of the fields within the IDENTIFY DEVICE command and IDENTIFY PACKET DEVICE command may change depending on the state of the attached ATA device, the SATL shall reissue the IDENTIFY DEVICE command or IDENTIFY PACKET DEVICE command to retrieve updated data whenever the ATA Information VPD page is requested.

Date: 2/1/2006 3:42:08 PM

T 10.3.5

change "10 to 19" to "19:10"

Status

rlsheffi Completed 6/23/2006 10:09:25 PM

Sequence number: 6

Author: DELL[KMarks]

Subject: Highlight

Date: 6/23/2006 10:11:56 PM

T Note 10 after Table 90 — IDENTIFY DEVICE OR IDENTIFY PACKET DEVICE DATA field

change

"NOTE 10 Although the SERIAL NUMBER field (words 10 to 19), FIRMWARE REVISION field (words 23 to 26), and MODEL NUMBER field (words 27-46) contain ASCII characters, every other byte is swapped within them (see ATA/ATAPI-7 V1). For example, the SERIAL NUMBER field is interpreted as: {word 10 bits 15:8, word 10 bits 7:0, word 11 bits 15:8, word 11 bits 7:0,...}, which corresponds to these bytes in the IDENTIFY DEVICE DATA field: {byte 21, byte 20, byte 23, byte 22,...}."

to

"NOTE 10 - Although the Serial number field (words 10 to 19), Firmware revision field (words 23 to 26), and Model number field (words 27-46) contain ASCII characters, every other byte is swapped within them (see ATA/ATAPI-7 V1). For example, the Serial number field is interpreted as: {word 10 bits 15:8, word 10 bits 7:0, word 11 bits 15:8, word 11 bits 7:0,...}, which corresponds to these bytes in the IDENTIFY DEVICE OR IDENTIFY PACKET DEVICE DATA field: {byte 21, byte 20, byte 23, byte 22,...}."

RESOLUTION: s/b

"NOTE 10 - Although the Serial number field (i.e., words 19:10), Firmware revision field (i.e., words 26:23), and Model number field (i.e., words 46:27) contain ASCII characters, every other byte is swapped within them (see ATA8-ACS) (e.g., the Serial number field is interpreted as: {word 10 bits 15:8, word 10 bits 7:0, word 11 bits 15:8, word 11 bits 7:0,...}, which corresponds to these bytes in the IDENTIFY DEVICE OR IDENTIFY PACKET DEVICE DATA field: {byte 21, byte 20, byte 23, byte 22,...})."

Status

rlsheffi Completed 6/23/2006 10:11:08 PM

Sequence number: 7

Author: HPQ[RElliott]

Subject: Highlight

Date: 2/1/2006 3:42:29 PM

T 10.3.5

change 27-46 to 46:27

Status

rlsheffi Completed 6/23/2006 10:12:19 PM

Sequence number: 8

Author: IBM[GPenokie]

Subject: Comment on Text

Date: 5/7/2006 9:17:25 AM

T note 10

This << (see ATA/ATAPI-7 V1). For example, the SERIAL NUMBER field is interpreted as: {word 10 bits 15:8, word 10 bits 7:0, word 11 bits 15:8, word 11 bits 7:0,...}, which corresponds to these bytes in the IDENTIFY DEVICE DATA field: {byte 21, byte 20, byte 23, byte 22,...}. >> should be << (see ATA/ATAPI-7 V1) (e.g., the SERIAL NUMBER field is interpreted as: {word 10 bits 15:8, word 10 bits 7:0, word 11 bits 15:8, word 11 bits 7:0,...}, which corresponds to these bytes in the IDENTIFY DEVICE DATA field: {byte 21, byte 20, byte 23, byte 22,...}). >>

RESOLUTION: see DELL comment

Status

rlsheffi Completed 6/23/2006 10:12:35 PM

Sequence number: 9

Author: ENDL[RWeber]

Date: 5/25/2006 1:18:49 PM

T Note 10

"V1" might be confused with "Version 1". Recommend spelling out "Volume".

RESOLUTION: see DELL comment (changed "ATA/ATAPI-7 V1" to "ATA8-ACS").

Comments from page 106 continued on next page

The data shall be presented with byte preservation (i.e., ATA byte n maps to SCSI byte n), as shown in table 90.

Table 90 — IDENTIFY DEVICE OR IDENTIFY PACKET DEVICE DATA field

Byte	Contents
0	IDENTIFY DEVICE OR IDENTIFY PACKET DEVICE word 0 bits 7:0 (i.e., byte 0)
1	IDENTIFY DEVICE OR IDENTIFY PACKET DEVICE word 0 bits 15:8 (i.e., byte 1)
2	IDENTIFY DEVICE OR IDENTIFY PACKET DEVICE word 1 bits 7:0 (i.e., byte 2)
3	IDENTIFY DEVICE OR IDENTIFY PACKET DEVICE word 1 bits 15:8 (i.e., byte 3)
...	...
510	IDENTIFY DEVICE OR IDENTIFY PACKET DEVICE word 255 bits 7:0 (i.e., the SIGNATURE field)
511	IDENTIFY DEVICE OR IDENTIFY PACKET DEVICE word 255 bits 15:8 (i.e., the CHECKSUM field)

NOTE 10 Although the SERIAL NUMBER field (words 10 to 19), FIRMWARE REVISION field (words 23 to 26), and MODEL NUMBER field (words 27-46) contain ASCII characters, every other byte is swapped within them (see ATA/ATAPI-7 V1). For example, the SERIAL NUMBER field is interpreted as: {word 10 bits 15:8, word 10 bits 7:0, word 11 bits 15:8, word 11 bits 7:0,...}, which corresponds to these bytes in the IDENTIFY DEVICE DATA field: {byte 21, byte 20, byte 23, byte 22,...}.

¹⁰ Since some of the fields within the IDENTIFY DEVICE command and IDENTIFY PACKET DEVICE command may change depending on the state of the attached ATA device, the SATL shall reissue the IDENTIFY DEVICE command or IDENTIFY PACKET DEVICE command to retrieve updated data whenever the ATA Information VPD page is requested.

Status
rlsheffi Completed 6/23/2006 10:12:44 PM

Sequence number: 10
Author: DELL[KMarks]
Subject: Highlight
Date: 2/16/2006 9:35:32 PM

T 1st Paragraph after Table 90 — IDENTIFY DEVICE OR IDENTIFY PACKET DEVICE DATA field
change

"Since some of the fields within the IDENTIFY DEVICE command and IDENTIFY PACKET DEVICE command may change depending on the state of the attached ATA device, the SATL shall reissue the IDENTIFY DEVICE command or IDENTIFY PACKET DEVICE command to retrieve updated data whenever the ATA Information VPD page is requested."

to

"Since some of the fields within the ATA IDENTIFY DEVICE data or ATA IDENTIFY PACKET DEVICE data may change depending on the state of the ATA device, the SATL shall reissue the ATA IDENTIFY DEVICE command or ATA IDENTIFY PACKET DEVICE command to retrieve updated data whenever the ATA Information VPD page is requested."

Status
rlsheffi Completed 6/23/2006 10:14:02 PM

1 Error Handling and Sense Reporting

1.1 Error Translation – ATA device error to SCSI error map

ATA device errors are translated to the appropriate SCSI errors. The ATA Status register and Error register bit settings provide the information to be translated into SCSI sense key, additional sense code, and additional sense code qualifier for error reporting. Unless otherwise specified in the subclause describing the translation of particular SCSI command, the SATL shall translate ATA non-packed device errors to SCSI errors as shown in table 91.

Table 91 — Translation of ATA errors to SCSI errors

ATA Error		SCSI Error	
Register			
Status	Error	Sense key	Additional sense code
DF	n/a	HARDWARE ERROR	INTERNAL TARGET FAILURE
ERR	NM	NOT READY	MEDIUM NOT PRESENT
ERR	UNC	MEDIUM ERROR	UNRECOVERED READ ERROR
ERR	IDNF	MEDIUM ERROR	RECORD NOT FOUND
ERR	ABRT ^a	ABORTED COMMAND	NO ADDITIONAL SENSE INFORMATION
ERR	MC	UNIT ATTENTION	NOT READY TO READY CHANGE, MEDIUM MAY HAVE CHANGED
ERR	MCR	UNIT ATTENTION	OPERATOR MEDIUM REMOVAL REQUEST
ERR	IDCRC	ABORTED COMMAND	INFORMATION UNIT iuCRC ERROR DETECTED
CORR	n/a	This condition is not considered an error.	

^a The ABRT bit is ignored if any other ATA error bit is set.

Sequence number: 1
Author: HPQ[RElliott]
Subject: Highlight
Date: 1/19/2006 9:29:12 AM

T 11

Handling and Sense Reporting s/b lower-case

Status
rlsheffi Completed 6/23/2006 10:19:02 PM

Sequence number: 2
Author: MXO[MEvans]
Subject: Highlight
Date: 6/19/2006 4:12:00 PM

T 11 Error Handling and Sense Reporting: change to, "Error handling and sense reporting" (i.e., remove the extra caps).

RESOLUTION: s/b
"11 Error and sense reporting"

Status
rlsheffi Completed 6/23/2006 10:19:36 PM

Sequence number: 3
Author: MXO[MEvans]
Subject: Highlight
Date: 2/13/2006 7:49:44 AM

T 11.1 Error Translation – ATA device error to SCSI error map: change to, "Error translation – ATA device error to SCSI error map" (i.e., remove the extra cap).

Status
rlsheffi Completed 6/23/2006 10:20:29 PM

Sequence number: 4
Author: HPQ[WBellamy]
Subject: Note
Date: 5/7/2006 10:14:08 AM

 Add "to be" here. Should read, "ATA device errors are to be translated to the appropriate SCSI errors".

REASON: The "to be" form is a more directive form, but is not the correct T10 form for normative text. If the sentence were written in normative form, it would read, "The SATL shall translate ATA device errors to the appropriate SCSI errors." However the sentence as it appears currently is intentionally written as informative text, and so simple use of the present tense "are translated" is appropriate, as this text is descriptive, not normative. The "shalls" appear later in the text.

Status
rlsheffi Rejected 6/23/2006 10:27:49 PM

Sequence number: 5
Author: DELL[KMarks]
Subject: Highlight
Date: 5/7/2006 10:18:54 AM

T 11.1 Error Translation – ATA device error to SCSI error map

1st Paragraph, 2nd Sentence
change

"Unless otherwise specified in the subclause describing the translation of particular SCSI command, the SATL shall translate ATA non-packed device errors to SCSI errors as shown in table 91."

to

"Unless otherwise specified in the subclause describing the translation of particular SCSI command, log page, mode page or VPD page, the SATL shall translate ATA non-packeted device errors to SCSI errors as shown in table 91."

RESOLUTION (added "a" before "particular"): s/b

"Unless otherwise specified in the subclause describing the translation of a particular SCSI command, log page, mode page or VPD page, the SATL shall translate ATA device errors to SCSI errors as shown in table 91."

Status

11 Error Handling and Sense Reporting

11.1 Error Translation – ATA device error to SCSI error map

ATA device errors are translated to the appropriate SCSI errors. The ATA Status register and Error register bit settings provide the information to be translated into SCSI sense key, additional sense code, and additional sense code qualifier for error reporting. Unless otherwise specified in the subclause describing the translation of particular SCSI command, the SATL shall translate ATA non-packed device errors to SCSI errors as shown in table 91.

Table 91 — Translation of ATA errors to SCSI errors

ATA Error		SCSI Error	
Register			
Status	Error	Sense key	Additional sense code
10f	n/a	HARDWARE ERROR	INTERNAL TARGET FAILURE
ERR	NM	NOT READY	MEDIUM NOT PRESENT
ERR	UNC	MEDIUM ERROR	UNRECOVERED READ ERROR
ERR	IDNF	MEDIUM ERROR	RECORD NOT FOUND
ERR	ABRT ^a	ABORTED COMMAND	NO ADDITIONAL SENSE INFORMATION
ERR	MC	UNIT ATTENTION	NOT READY TO READY CHANGE, MEDIUM MAY HAVE CHANGED
ERR	MCR	UNIT ATTENTION	OPERATOR MEDIUM REMOVAL REQUEST
ERR	IDCRC	ABORTED COMMAND	INFORMATION UNIT iuCRC ERROR DETECTED
CORR	n/a	This condition is not considered an error.	

^a The ABRT bit is ignored if any other ATA error bit is set.

risheffi Completed 6/23/2006 10:29:13 PM

Sequence number: 6
Author: HPQ[WBellamy]
Subject: Note
Date: 2/17/2006 8:22:56 AM
 Add "a" here.

Status
risheffi Completed 6/23/2006 10:29:31 PM

Sequence number: 7
Author: MXO[MEvans]
Subject: Highlight
Date: 5/7/2006 10:21:29 AM

 11.1 Error translation – ATA device error to SCSI error map, first paragraph: define "ATA non-packed device errors".

RESOLUTION:
"ATA non-packed device errors"
s/b
"ATA device errors"

Note - In an earlier revision all occurrences of "ATA non-packeted device" were changed to "ATA device". This one was overlooked because the word "packeted" was misspelled as "packed".

Status
risheffi Completed 6/23/2006 10:30:05 PM

Sequence number: 8
Author: HPQ[WBellamy]
Subject: Note
Date: 3/20/2006 2:15:00 PM

 "AMNF" bit is missing from this table. This bit must be translated because it does in current products still get asserted. T13 participants had not thought this to be true, but this is actually happening now. The bit must be added and translated. Originally it was proposed to be translated to 03/13/00 - MEDIUM ERROR - ADDRESS MARK NOT FOUND FOR DATA FIELD. This is a high priority correction request.

RESOLUTION: Add table footnote (b) to the "Error" column heading:
"If the Error register has an obsolete bit set to one, the SATL may return a vendor-specific additional sense code (e.g., if the AMNF bit is set to one, return MEDIUM ERROR - ADDRESS MARK NOT FOUND FOR DATA FIELD)."

Status
risheffi Completed 6/23/2006 10:35:12 PM

Sequence number: 9
Author: HPQ[WBellamy]
Subject: Note
Date: 5/7/2006 10:30:41 AM

 Not per 05-233r3. This table is missing the "WP" bit and its translation. This must be added to the table.

RESOLUTION:
Add WP back in per 05-233r3
After the third row (between UNC and IDNF rows) add under the indicated columns:
Status Error Sense key Additional sense code
"ERR WP DATA PROTECT WRITE PROTECTED"

Editor's note: I believe this was removed during draft review based on the contention that an ATA block storage device would not be write-protected.

Status
risheffi Completed 6/23/2006 10:37:03 PM

Sequence number: 10
Author: EDITOR[risheffi]
Subject: Highlight
Date: 5/7/2006 10:32:23 AM

 11.1 Error Translation – ATA device error to SCSI error map

Table 91 — Translation of ATA errors to SCSI errors

Row: DF,n/a

Add a table footnote, "After an ATA device returns a DF bit set to one, the SATL processes any subsequent commands received for the emulated logical unit corresponding to the ATA device by terminating the command with CHECK CONDITION status with the sense key set to HARDWARE ERROR and the additional sense code set to INTERNAL TARGET FAILURE."

11 Error Handling and Sense Reporting

11.1 Error Translation – ATA device error to SCSI error map

ATA device errors are translated to the appropriate SCSI errors. The ATA Status register and Error register bit settings provide the information to be translated into SCSI sense key, additional sense code, and additional sense code qualifier for error reporting. Unless otherwise specified in the subclause describing the translation of particular SCSI command, the SATL shall translate ATA non-packed device errors to SCSI errors as shown in table 91.

Table 91 — Translation of ATA errors to SCSI errors

ATA Error		SCSI Error	
Register			
Status	Error	Sense key	Additional sense code
DF	n/a	HARDWARE ERROR	INTERNAL TARGET FAILURE
ERR	NM	NOT READY	MEDIUM NOT PRESENT
ERR	UNC	MEDIUM ERROR	UNRECOVERED READ ERROR
ERR	IDNF	MEDIUM ERROR	RECORD NOT FOUND
ERR	ABRT ^a	ABORTED COMMAND	NO ADDITIONAL SENSE INFORMATION
ERR	MC	UNIT ATTENTION	NOT READY TO READY CHANGE, MEDIUM MAY HAVE CHANGED
ERR	MCR	UNIT ATTENTION	OPERATOR MEDIUM REMOVAL REQUEST
ERR	CRC	ABORTED COMMAND	INFORMATION UNIT CRC ERROR DETECTED
CORR	n/a	This condition is not considered an error.	

^a The ABRT bit is ignored if any other ATA error bit is set.

See LSI[OParry] comment on list-item 5 under subclause 8.11.2 TEST UNIT READY OPERATION CODE.

Status

risheffi Completed 6/23/2006 10:39:16 PM

Sequence number: 11

Author: HPQ[WBellamy]

Subject: Highlight

Date: 5/7/2006 10:32:44 AM

 This bit is correctly identified as "ICRC", not IDCRC. Proposal 05-233r3 correctly indicates this. Change to "ICRC".

Status

risheffi Completed 6/23/2006 10:39:49 PM

Sequence number: 12

Author: HPQ[WBellamy]

Subject: Note

Date: 5/7/2006 10:32:40 AM



Status

risheffi Cancelled 5/7/2006 10:32:47 AM

12 SAT-Specific SCSI Extensions

12.1 SAT-Specific SCSI Extensions Overview

This subclause defines additional SCSI commands, mode pages, and log pages that may be supported by a SATL to provide capabilities beyond those defined in the other SCSI command sets.

SCSI commands defined for SATL implementations include:

- a) ATA PASS-THROUGH (12) command; and
- b) ATA PASS-THROUGH (16) command.

Mode pages defined for SATL implementations include:

- a) PATA Control mode page.

12.2 ATA PASS-THROUGH commands

12.2.1 ATA PASS-THROUGH commands overview

This standard provides for an application client to:

- a) transmit an ATA command to an ATA device;
- b) optionally transfer data between the application client and an ATA device; and
- c) transfer completion status from an ATA device through the SATL.

This is accomplished by defining:

- a) CDBs containing ATA command information (see 12.2.2 and 12.2.3); and
- b) specific SCSI status and sense data usage for returning the results of an ATA command (see 12.2.4).

12.2.2 ATA PASS-THROUGH (12) command

Table 92 shows the CDB for the ATA PASS-THROUGH (12) command.

Table 92 — ATA PASS-THROUGH (12) command

Byte/Bit	7	6	5	4	3	2	1	0
0	OPERATION CODE (A1h)							
1	MULTIPLE_COUNT			PROTOCOL				Reserved
2	OFF_LINE	CK_COND	Reserved	T_DIR	BYTE_BLOCK	T_LENGTH		
3	FEATURES (7:0)							
4	SECTOR_COUNT (7:0)							
5	LBA_LOW (7:0)							
6	LBA_MID (7:0)							
7	LBA_HIGH (7:0)							
8	DEVICE							
9	COMMAND							
10	Reserved							
11	CONTROL (see 6.4)							

Sequence number: 1
Author: MXO[MEvans]
Subject: Highlight
Date: 7/24/2006 8:03:25 AM

T 12 SAT-Specific SCSI Extensions and 12.1 SAT-Specific SCSI Extensions Overview: change to "SAT-specific SCSI extensions" and "SAT-specific SCSI extensions overview" (i.e., remove the extra caps).
RESOLUTION: see 06-291 (fixed in SAT-r08c)

Status
rlsheffi Completed 7/24/2006 8:03:31 AM

Sequence number: 2
Author: HPQ[RElliott]
Subject: Highlight
Date: 7/24/2006 8:03:48 AM

T 12.1
Extensions Overview s/b lowercase
RESOLUTION: see 06-291 (Fixed in SAT-r08c)

Status
rlsheffi Completed 7/24/2006 8:03:57 AM

Sequence number: 3
Author: DELL[KMarks]
Subject: Highlight
Date: 6/23/2006 10:52:34 PM

T **12.1 SAT-Specific SCSI Extensions Overview**
1st Sentence
change

"...additional SCSI commands, mode pages, and log pages that may..."
to
"...additional SCSI commands and mode pages that may..."

This section does not define any log pages, unless this is a future statement?

RESOLUTION: see 06-291 - s/b
"...additional SCSI commands, mode pages, and VPD pages that may..."

Status
rlsheffi Completed 7/24/2006 8:04:34 AM

Sequence number: 4
Author: HPQ[RElliott]
Date: 6/23/2006 10:59:56 PM

T 12.1
After "command" add "(see 12.2.2)"
RESOLUTION: see 06-291

Status
rlsheffi Completed 7/24/2006 8:04:46 AM

Sequence number: 5
Author: HPQ[RElliott]
Date: 6/23/2006 11:00:25 PM

T 12.1
After "command" add "(see 12.2.3)"
RESOLUTION: see 06-291

Status
rlsheffi Completed 7/24/2006 8:05:34 AM

Sequence number: 6
Author: HPQ[RElliott]

12 SAT-Specific SCSI Extensions

12.1 SAT-Specific SCSI Extensions Overview

This subclause defines additional SCSI commands, mode pages, and log pages that may be supported by a SATL to provide capabilities beyond those defined in the other SCSI command sets.

SCSI commands defined for SATL implementations include:

- a) ATA PASS-THROUGH (12) command; and
- b) ATA PASS-THROUGH (16) command.

Mode pages defined for SATL implementations include:

- a) PATA Control mode page.

12.2 ATA PASS-THROUGH commands

12.2.1 ATA PASS-THROUGH commands overview

This standard provides for an application client to:

- a) transmit an ATA command to an ATA device;
- b) optionally transfer data between the application client and an ATA device; and
- c) transfer completion status from an ATA device through the SATL.

This is accomplished by defining:

- a) CDBs containing ATA command information (see 12.2.2 and 12.2.3); and
- b) specific SCSI status and sense data usage for returning the results of an ATA command (see 12.2.4).

12.2.2 ATA PASS-THROUGH (12) command

Table 92 shows the CDB for the ATA PASS-THROUGH (12) command.

Table 92 — ATA PASS-THROUGH (12) command

Byte/Bit	7	6	5	4	3	2	1	0
0	OPERATION CODE (A1h)							
1	MULTIPLE_COUNT			PROTOCOL				Reserved
2	OFF_LINE	CK_COND	Reserved	T_DIR	BYTE_BLOCK	T_LENGTH		
3	FEATURES (7:0)							
4	SECTOR_COUNT (7:0)							
5	LBA_LOW (7:0)							
6	LBA_MID (7:0)							
7	LBA_HIGH (7:0)							
8	DEVICE							
9	COMMAND							
10	Reserved							
11	CONTROL (see 6.4)							

Date: 6/23/2006 11:01:01 PM

T 12.1

After "mode page "add "(see 12.3.2)"
RESOLUTION: see 06-291

Status
risheffi Completed 7/24/2006 8:07:55 AM

Sequence number: 7
Author: DELL[KMarks]
Subject: Highlight
Date: 7/24/2006 8:08:51 AM

T 12.2.1 ATA PASS-THROUGH commands overview

1st Sentence

change

"This standard provides for an application client to:"

to

"This subclause provides for an application client to:"

RESOLUTION: see 06-291(accepted MXO suggestion)

Status
risheffi Completed 7/24/2006 8:08:54 AM

Sequence number: 8
Author: MXO[MEvans]
Subject: Highlight
Date: 6/23/2006 11:12:55 PM

T 12.2.1 ATA PASS-THROUGH commands overview, first paragraph: change to:

"ATA PASS-THROUGH commands provide a method for:

- a) an application client to transmit an ATA command to an ATA device;
- b) optionally, data transfer between an application client and an ATA device; and
- c) for an ATA device to transfer completion status through the SATL."

RESOLUTION: see 06-291

Status
risheffi Completed 7/24/2006 8:09:10 AM

Sequence number: 9
Author: IBM[GPenokie]
Subject: Underline
Date: 2/16/2006 1:43:05 PM

T 12.2.2 ATA PASS-THROUGH (12) command

Status
risheffi Cancelled 5/7/2006 11:07:17 AM

1 the SATL receives an ATA PASS-THROUGH (12) command it shall check the **PROTOCOL** field (see table 93) to determine the type of action requested.

Table 93 — PROTOCOL field

Code	Description
0	Hard Reset
1	SRST
2	Reserved
3	Non-data
4	PIO Data-In
5	PIO Data-Out
6	DMA
7	DMA Queued
8	Device Diagnostic
9	DEVICE RESET
10	UDMA Data In
11	UDMA Data Out
12	FPDMA ^a
13, 14	Reserved
15	Return Response Information
^a See SATA 2.5.	

The **PROTOCOL** field specifies the protocol to use when the ATA device executes the command. 2 ATA/ATAPI-7 defines the meaning of protocol values ranging from 0 to 11.

3 **PROTOCOL** value in the range from 3 to 12 requests the SATL to send an ATA command to the ATA device.

4 the **PROTOCOL** field contains 15 (i.e., Return Response Information) the SATL shall not access the ATA device, but shall return the ATA Status Return Descriptor as 5 defined in subclause 12.2.5. The SATL shall ignore all other fields in the CDB.

If the value in the **PROTOCOL** field is inappropriate for 6 command specified in the **COMMAND** field (see ATA/ATAPI-7 and SATA 2.5) the SATL may lose communication with the ATA device, and this standard does not specify the SATL behavior if this occurs.

If the value in the **PROTOCOL** field is set to zero (i.e., Hard Reset) and the 7 attached device is a PATA device, then the SATL shall issue a pin 1 reset to the PATA device (see ATA/ATAPI-7). If the value in the **PROTOCOL** field is set to zero (i.e., Hard Reset) and the 8 attached device is a SATA device, then the SATL shall issue a COMRESET to SATA device. When this protocol is selected, 9 only the **PROTOCOL** and **OFF_LINE** fields are valid. The SATL shall ignore all other fields in the CDB.

If the **PROTOCOL** field is set to one the SATL shall issue a soft reset to the 10 attached ATA device (see ATA/ATAPI-7). When this protocol is selected, 11 only the **PROTOCOL** and **OFF_LINE** fields are valid. The SATL shall ignore all other fields in the CDB.

~~Some **PROTOCOL** values cause the SATL to reset the ATA device or to return information about the ATA device.~~

If the value in the **PROTOCOL** field requests the SATL to send a command to the ATA device, then the SATL shall use the **FEATURES** (7:0), **SECTOR_C** 12 (7:0), **LBA_LOW** (7:0), **LBA_MID** (7:0), **LBA_HIGH** (7:0), **DEVICE** and the **COMMAND** fields to initiate a command in the ATA device. These fields correspond to the registers defined in ATA/ATAPI-7 volume 2 with the same names, and also to the FIS fields defined in ATA/ATAPI-7 volume 3 with the same names.

Sequence number: 1
Author: MXO[MEvans]
Subject: Highlight
Date: 6/23/2006 11:17:56 PM

T 12.2.2 ATA PASS-THROUGH (12) command, second paragraph: change "If the SATL receives an ATA PASS-THROUGH (12) command it shall check the PROTOCOL field..." to "If the SATL receives an ATA PASS-THROUGH (12) command, then the SATL shall check the PROTOCOL field..."

RESOLUTION: see 06-291

Status
rlsheffi Completed 7/24/2006 8:10:03 AM

Sequence number: 2
Author: EDITOR[rlsheffi]
Subject: Highlight
Date: 6/23/2006 11:19:53 PM

T 12.2.2 ATA PASS-THROUGH (12) command
Third paragraph (describing the PROTOCOL field)
change
"ATA/ATAPI-7"
to
"ATA8-ACS"
RESOLUTION: see 06-291 - s/b "ATA8-AAM"

Status
rlsheffi Completed 7/24/2006 8:10:24 AM

Sequence number: 3
Author: DELL[KMarks]
Subject: Highlight
Date: 6/23/2006 11:23:11 PM

T 2nd Paragraph after Table 93 — PROTOCOL field
change

"A PROTOCOL value in the range from 3 to 12 requests the SATL to send an ATA command to the ATA device."
to
"If the PROTOCOL field specified is in the range from 3 to 12, the SATL shall send an ATA command to the ATA device."

RESOLUTION: see 06-291

Status
rlsheffi Completed 7/24/2006 8:10:46 AM

Sequence number: 4
Author: MXO[MEvans]
Subject: Highlight
Date: 6/23/2006 11:28:51 PM

T 12.2.2 ATA PASS-THROUGH (12) command, fifth paragraph: change the first sentence to, "If the PROTOCOL field contains 15 (i.e., Return Response Information), then the SATL shall not access the ATA device, but the SATL shall return the ATA Status Return Descriptor as defined in 12.2.5."

RESOLUTION:
"If the PROTOCOL field contains 15 (i.e., Return Response Information), then the SATL shall:
a) if the transport is SATA, read the current Shadow Command Block registers; or
b) if the transport is PATA, read the current Command Block registers;

and return the contents in the ATA Status Return Descriptor as defined in 12.2.5."

RESOLUTION: see 06-291

Status
rlsheffi Completed 7/24/2006 8:14:23 AM

Sequence number: 5
Author: IBM[GPenokie]

If the SATL receives an ATA PASS-THROUGH (12) command it shall check the **PROTOCOL field** (see table 93) to determine the type of action requested.

Table 93 — PROTOCOL field

Code	Description
0	Hard Reset
1	SRST
2	Reserved
3	Non-data
4	PIO Data-In
5	PIO Data-Out
6	DMA
7	DMA Queued
8	Device Diagnostic
9	DEVICE RESET
10	UDMA Data In
11	UDMA Data Out
12	FPDMA ^a
13, 14	Reserved
15	Return Response Information
^a See SATA 2.5.	

The PROTOCOL field specifies the protocol to use when the ATA device executes the command. ATA/ATAPI-7 defines the meaning of protocol values ranging from 0 to 11.

A PROTOCOL value in the range from 3 to 12 requests the SATL to send an ATA command to the ATA device.

If the PROTOCOL field contains 15 (i.e., Return Response Information) the SATL shall not access the ATA device, but shall return the ATA Status Return Descriptor as defined in subclause 12.2.5. The SATL shall ignore all other fields in the CDB.

If the value in the PROTOCOL field is inappropriate for the command specified in the COMMAND field (see ATA/ATAPI-7 and SATA 2.5) the SATL may lose communication with the ATA device, and this standard does not specify the SATL behavior if this occurs.

If the value in the PROTOCOL field is set to zero (i.e., Hard Reset) and the attached device is a PATA device, the SATL shall issue a pin 1 reset to the PATA device (see ATA/ATAPI-7). If the value in the PROTOCOL field is set to zero (i.e., Hard Reset) and the attached device is a SATA device, then the SATL shall issue a COMRESET to SATA device. When this protocol is selected, only the PROTOCOL and OFF_LINE fields are valid. The SATL shall ignore all other fields in the CDB.

If the PROTOCOL field is set to one the SATL shall issue a soft reset to the attached ATA device (see ATA/ATAPI-7). When this protocol is selected, only the PROTOCOL and OFF_LINE fields are valid. The SATL shall ignore all other fields in the CDB.

~~Some PROTOCOL values cause the SATL to reset the ATA device or to return information about the ATA device.~~

If the value in the PROTOCOL field requests the SATL to send a command to the ATA device, then the SATL shall use the FEATURES (7:0), SECTOR_COUNT (7:0), LBA_LOW (7:0), LBA_MID (7:0), LBA_HIGH (7:0), DEVICE and the COMMAND fields to initiate a command in the ATA device. These fields correspond to the registers defined in ATA/ATAPI-7 volume 2 with the same names, and also to the FIS fields defined in ATA/ATAPI-7 volume 3 with the same names.

Subject: Comment on Text
Date: 6/23/2006 11:29:25 PM
T 3rd paragraph after table 93

This << defined in subclause 12.2.5. The SATL shall >> should be << defined in 12.2.5. The SATL shall >>.

RESOLUTION: see 06-291

Status
rlsheffi Completed 7/24/2006 8:14:39 AM

Sequence number: 6
Author: DELL[KMarks]
Subject: Note
Date: 6/19/2006 4:12:30 PM
4th Paragraph after Table 93

What about if the command value is for a 48 bit command with the protocol set correctly? Subclause says the SATL does not look at command code, only puts it in the Command register. Does this follow the error handling in clause 11?

Note: This is a general disclaimer - that an application needs to use the command in a sensible way or the result is not specified (or perhaps even predictable?).

REASON: This condition can cause an undetectable error.

Status
rlsheffi Rejected 6/19/2006 4:05:25 PM

Sequence number: 7
Author: MXO[MEvans]
Subject: Highlight
Date: 7/24/2006 8:16:15 AM

T 12.2.2 ATA PASS-THROUGH (12) command, sixth paragraph: change to, " If the value in the PROTOCOL field is inappropriate for the command specified in the COMMAND field (see ATA/ATAPI-7 and SATA 2.5), then the SATL may lose communication with the ATA device. This standard does not specify the SATL behavior if this occurs."

RESOLUTION: change to,

" If the value in the PROTOCOL field is inappropriate for the command specified in the COMMAND field (see ATA8-ACS), then the SATL may lose communication with the ATA device. This standard does not specify the SATL behavior if this occurs."

RESOLUTION: see 06-291 (Fixed in SAT-r08c)

Status
rlsheffi Completed 7/24/2006 8:16:19 AM

Sequence number: 8
Author: DELL[KMarks]
Subject: Cross-Out
Date: 6/23/2006 11:35:04 PM
T attached

RESOLUTION: see 06-291

Status
rlsheffi Completed 7/24/2006 8:17:14 AM

Sequence number: 9
Author: EDITOR[rlsheffi]
Subject: Highlight
Date: 6/23/2006 11:35:52 PM

T 12.2.1 ATA PASS-THROUGH commands overview
Seventh paragraph (describing a PROTOCOL field set to zero)
change
"(see ATA/ATAPI-7)"
to
"(see ATA8-ACS)"

RESOLUTION: see 06-291 - s/b "(see ATA8-APT)"

Status
rlsheffi Completed 7/24/2006 8:17:28 AM

Sequence number: 10

Comments from page 109 continued on next page

If the SATL receives an ATA PASS-THROUGH (12) command it shall check the **PROTOCOL** field (see table 93) to determine the type of action requested.

Table 93 — PROTOCOL field

Code	Description
0	Hard Reset
1	SRST
2	Reserved
3	Non-data
4	PIO Data-In
5	PIO Data-Out
6	DMA
7	DMA Queued
8	Device Diagnostic
9	DEVICE RESET
10	UDMA Data In
11	UDMA Data Out
12	FPDMA ^a
13, 14	Reserved
15	Return Response Information
^a See SATA 2.5.	

The PROTOCOL field specifies the protocol to use when the ATA device executes the command. ATA/ATAPI-7 defines the meaning of protocol values ranging from 0 to 11.

A PROTOCOL value in the range from 3 to 12 requests the SATL to send an ATA command to the ATA device.

If the PROTOCOL field contains 15 (i.e., Return Response Information) the SATL shall not access the ATA device, but shall return the ATA Status Return Descriptor as defined in subclause 12.2.5. The SATL shall ignore all other fields in the CDB.

If the value in the PROTOCOL field is inappropriate for a command specified in the COMMAND field (see ATA/ATAPI-7 and SATA 2.5) the SATL may lose communication with the ATA device, and this standard does not specify the SATL behavior if this occurs.

If the value in the PROTOCOL field is set to zero (i.e., Hard Reset) and the attached device is a PATA device, then the SATL shall issue a pin 1 reset to the PATA device (see ATA/ATAPI-7). If the value in the PROTOCOL field is set to zero (i.e., Hard Reset) and the attached device is a SATA device, then the SATL shall issue a DMRESET to SATA device. When this protocol is selected, only the PROTOCOL and OFF_LINE fields are valid. The SATL shall ignore all other fields in the CDB.

If the PROTOCOL field is set to one the SATL shall issue a soft reset to the attached ATA device (see ATA/ATAPI-7). When this protocol is selected, only the PROTOCOL and OFF_LINE fields are valid. The SATL shall ignore all other fields in the CDB.

~~Some PROTOCOL values cause the SATL to reset the ATA device or to return information about the ATA device.~~

If the value in the PROTOCOL field requests the SATL to send a command to the ATA device, then the SATL shall use the FEATURES (7:0), SECTOR_COUNT (7:0), LBA_LOW (7:0), LBA_MID (7:0), LBA_HIGH (7:0), DEVICE and the COMMAND fields to initiate a command in the ATA device. These fields correspond to the registers defined in ATA/ATAPI-7 volume 2 with the same names, and also to the FIS fields defined in ATA/ATAPI-7 volume 3 with the same names.

Author: MXO[MEvans]

Subject: Highlight

Date: 6/23/2006 11:38:34 PM

T 12.2.2 ATA PASS-THROUGH (12) command, seventh paragraph: change "...then the SATL shall issue a pin 1 reset to the PATA device..." to "...then the SATL shall cause RST- to be asserted...".

RESOLUTION: s/b

"... then the SATL shall assert RST-"

RESOLUTION: see 06-291

Status

risheffi Completed 7/24/2006 8:17:53 AM

Sequence number: 11

Author: DELL[KMarks]

Subject: Cross-Out

Date: 6/23/2006 11:39:24 PM

T attached

RESOLUTION: see 06-291

Status

risheffi Completed 7/24/2006 8:18:16 AM

Sequence number: 12

Author: IBM[GPenokie]

Subject: Comment on Text

Date: 6/23/2006 11:40:32 PM

T 5th paragraph after table 93

This << only the PROTOCOL and OFF_LINE fields are valid. >> should be << only the PROTOCOL field and OFF_LINE field are valid. >>

RESOLUTION: see 06-291

Status

risheffi Completed 7/24/2006 8:19:00 AM

Sequence number: 13

Author: DELL[KMarks]

Subject: Highlight

Date: 6/23/2006 11:41:56 PM

T 5th Paragraph, 2nd Sentence after **Table 93 — PROTOCOL field**

change

"...COMRESET to SATA device."

to

"...COMRESET to the SATA device."

RESOLUTION: see 06-291

Status

risheffi Completed 7/24/2006 8:19:38 AM

Sequence number: 14

Author: DELL[KMarks]

Subject: Cross-Out

Date: 6/23/2006 11:42:22 PM

T attached

RESOLUTION: see 06-291

Status

risheffi Completed 7/24/2006 8:19:50 AM

Sequence number: 15

Author: MXO[MEvans]

Subject: Highlight

Date: 6/23/2006 11:45:49 PM

T 12.2.2 ATA PASS-THROUGH (12) command, eighth paragraph: change "If the PROTOCOL field is set to one the SATL shall issue a soft reset to the attached ATA device..." to "If the PROTOCOL field is set to one, then the SATL shall issue a software reset to the attached ATA device...".

RESOLUTION: see 06-291

Status

risheffi Completed 7/24/2006 8:20:43 AM

Sequence number: 16

Author: EDITOR[risheffi]

Subject: Highlight

Date: 6/23/2006 11:46:21 PM

Comments from page 109 continued on next page

If the SATL receives an ATA PASS-THROUGH (12) command it shall check the **PROTOCOL** field (see table 93) to determine the type of action requested.

Table 93 — PROTOCOL field

Code	Description
0	Hard Reset
1	SRST
2	Reserved
3	Non-data
4	PIO Data-In
5	PIO Data-Out
6	DMA
7	DMA Queued
8	Device Diagnostic
9	DEVICE RESET
10	UDMA Data In
11	UDMA Data Out
12	FPDMA ^a
13, 14	Reserved
15	Return Response Information
^a See SATA 2.5.	

The **PROTOCOL** field specifies the protocol to use when the ATA device executes the command. **ATA/ATAPI-7** defines the meaning of protocol values ranging from 0 to 11.

A **PROTOCOL** value in the range from 3 to 12 requests the SATL to send an ATA command to the ATA device.

If the **PROTOCOL** field contains 15 (i.e., Return Response Information) the SATL shall not access the ATA device, but shall return the ATA Status Return Descriptor as defined in subclause 12.2.5. The SATL shall ignore all other fields in the CDB.

If the value in the **PROTOCOL** field is inappropriate for a command specified in the **COMMAND** field (see **ATA/ATAPI-7** and **SATA 2.5**) the SATL may lose communication with the ATA device, and this standard does not specify the SATL behavior if this occurs.

If the value in the **PROTOCOL** field is set to zero (i.e., Hard Reset) and the attached device is a PATA device, then the SATL shall issue a pin 1 reset to the PATA device (see **ATA/ATAPI-7**). If the value in the **PROTOCOL** field is set to zero (i.e., Hard Reset) and the attached device is a SATA device, then the SATL shall issue a **COMRESET** to SATA device. When this protocol is selected, only the **PROTOCOL** and **OFF_LINE** fields are valid. The SATL shall ignore all other fields in the CDB.

If the **PROTOCOL** field is set to one the SATL shall issue a soft reset to the attached ATA device (see **ATA/ATAPI-7**). When this protocol is selected, only the **PROTOCOL** and **OFF_LINE** fields are valid. The SATL shall ignore all other fields in the CDB.

~~Some PROTOCOL values cause the SATL to reset the ATA device or to return information about the ATA device.~~

If the value in the **PROTOCOL** field requests the SATL to send a command to the ATA device, then the SATL shall use the **FEATURES** (7:0), **SECTOR_COUNT** (20:0), **LBA_LOW** (7:0), **LBA_MID** (7:0), **LBA_HIGH** (7:0), **DEVICE** and the **COMMAND** fields to initiate a command in the ATA device. These fields correspond to the registers defined in **ATA/ATAPI-7** volume 2 with the same names, and also to the **FIS** fields defined in **ATA/ATAPI-7** volume 3 with the same names.

T 12.2.1 ATA PASS-THROUGH commands overview
Eighth paragraph (describing a PROTOCOL field set to one)
change
"(see ATA/ATAPI-7)"
to
"(see ATA8-ACS)"
RESOLUTION: see 06-291 s/b "(see ATA8-AAM)"

Status
risheffi Completed 7/24/2006 8:21:14 AM

Sequence number: 17
Author: IBM[GPenokie]
Subject: Comment on Text
Date: 6/23/2006 11:47:57 PM

T 6th paragraph after table 93
This << only the PROTOCOL and OFF_LINE fields are valid. >> should be << only the PROTOCOL field and OFF_LINE field are valid. >>
RESOLUTION: see 06-291

Status
risheffi Completed 7/24/2006 8:22:29 AM

Sequence number: 18
Author: DELL[KMarks]
Subject: Cross-Out
Date: 6/23/2006 11:48:35 PM

T 7th Paragraph, 1st Sentence after Table 93 — PROTOCOL field
remove

"Some PROTOCOL values cause the SATL to reset the ATA device or to return information about the ATA device."

Does not seem to say anything useful.
RESOLUTION: see 06-291 - line deleted

Status
risheffi Completed 7/24/2006 8:22:48 AM

Sequence number: 19
Author: IBM[GPenokie]
Subject: Comment on Text
Date: 7/24/2006 8:24:01 AM

T 8th paragraph after table 93
This << shall use the FEATURES (7:0), SECTOR_COUNT (7:0), LBA_LOW (7:0), LBA_MID (7:0), LBA_HIGH (7:0), DEVICE and the COMMAND fields to initiate >> should be << shall use the FEATURES (7:0) field, SECTOR_COUNT (7:0) field, LBA_LOW (7:0) field, LBA_MID (7:0) field, LBA_HIGH (7:0) field, DEVICE field, and the COMMAND field to initiate >>
RESOLUTION: see 06-291 (reworded to fit ATA8 and added a table to show field mapping)

Status
risheffi Completed 7/24/2006 8:24:05 AM

Sequence number: 20
Author: DELL[KMarks]
Subject: Note
Date: 6/23/2006 11:54:26 PM

T 8th Paragraph, after Table 93 — PROTOCOL field

1) Why Volume 2 for PATA and Vol 3 for SATA? Since these are the the register values associated with the COMMAND and PROTOCOL field, so I would argue that Vol 1 would be correct for both, with an additional note that for FPDMA see SATA 2.5.

2) Only if the command is 48 bit (EXT), which ATA PASS-THROUGH(12) does not support, does the (7:0) have meaning. So how can one say same names as in ATA/ATAPI-7?

proposed resolution:
change

"These fields correspond to the registers defined in ATA/ATAPI-7 volume 2 with the same names, and also to the FIS fields defined in ATA/ATAPI-7 volume 3 with the same names."

to
"These fields correspond to the fields defined in ATA8-ACS."
RESOLUTION: see 06-291 (deleted the sentence)

Comments from page 109 continued on next page

If the SATL receives an ATA PASS-THROUGH (12) command it shall check the **PROTOCOL** field (see table 93) to determine the type of action requested.

Table 93 — PROTOCOL field

Code	Description
0	Hard Reset
1	SRST
2	Reserved
3	Non-data
4	PIO Data-In
5	PIO Data-Out
6	DMA
7	DMA Queued
8	Device Diagnostic
9	DEVICE RESET
10	UDMA Data In
11	UDMA Data Out
12	FPDMA ^a
13, 14	Reserved
15	Return Response Information
^a See SATA 2.5.	

The **PROTOCOL** field specifies the protocol to use when the ATA device executes the command. **ATA/ATAPI-7** defines the meaning of protocol values ranging from 0 to 11.

A **PROTOCOL** value in the range from 3 to 12 requests the SATL to send an ATA command to the ATA device.

If the **PROTOCOL** field contains 15 (i.e., Return Response Information) the SATL shall not access the ATA device, but shall return the ATA Status Return Descriptor as defined in subclause 12.2.5. The SATL shall ignore all other fields in the CDB.

If the value in the **PROTOCOL** field is inappropriate for the command specified in the **COMMAND** field (see **ATA/ATAPI-7** and **SATA 2.5**) the SATL may lose communication with the ATA device, and this standard does not specify the SATL behavior if this occurs.

If the value in the **PROTOCOL** field is set to zero (i.e., Hard Reset) and the **attached** device is a PATA device, then the SATL shall issue a pin 1 reset to the PATA device (see **ATA/ATAPI-7**). If the value in the **PROTOCOL** field is set to zero (i.e., Hard Reset) and the **attached** device is a SATA device, then the SATL shall issue a **COMRESET** to SATA device. When this protocol is selected, only the **PROTOCOL** and **OFF_LINE** fields are valid. The SATL shall ignore all other fields in the CDB.

If the **PROTOCOL** field is set to one the SATL shall issue a soft reset to the **attached** ATA device (see **ATA/ATAPI-7**). When this protocol is selected, only the **PROTOCOL** and **OFF_LINE** fields are valid. The SATL shall ignore all other fields in the CDB.

~~Some **PROTOCOL** values cause the SATL to reset the ATA device or to return information about the ATA device.~~

If the value in the **PROTOCOL** field requests the SATL to send a command to the ATA device, then the SATL shall use the **FEATURES** (7:0), **SECTOR_COUNT** (7:0), **LBA_LOW** (7:0), **LBA_MID** (7:0), **LBA_HIGH** (7:0), **DEVICE** and the **COMMAND** fields to initiate a command in the ATA device. These fields correspond to the registers defined in **ATA/ATAPI-7** volume 2 with the same names, and also to the **FIS** fields defined in **ATA/ATAPI-7** volume 3 with the same names.

Status
risheffi Completed

7/24/2006 8:24:32 AM

The SATL shall determine if a data transfer is necessary and how to perform the data transfer by examining values in the MULTIPLE_COUNT field, PROTOCOL field, OFF_LINE field, T_DIR bit, BYTE_BLOCK bit, and T_LENGTH field. The SATL shall ignore the COMMAND field in the CDB except to copy the COMMAND field in the CDB to the COMMAND field in the Register – Host to Device FIS or to the ATA Command register. If the ATA command completes with an error, then a copy of the PATA registers, or a copy of the SATA Register - Device to Host FIS shall be returned in the ATA Status Return Descriptor (see 12.2.5).

The SATL shall configure the ATA host and device for the PIO, DMA, and UDMA speeds that both the SATL and ATA device support. The COMMAND field of the CDB may specify the ATA SET FEATURES command. The ATA PASS-THROUGH (12) command should not be used to issue an ATA SET FEATURES command that changes the PIO/DMA/UDMA or other transfer modes of the ATA device. The result of a SET FEATURES command that changes the PIO/DMA/UDMA or other transfer modes of the ATA device is outside the scope of this standard and may cause communication to be lost with the ATA device; preventing the SATL from performing any action based on the contents of the CDB.

The BYTE_BLOCK (Byte/Block) bit indicates whether the transfer length in the location specified by the T_LENGTH field specifies the number of bytes to transfer or the number of blocks to transfer. If the value in the BYTE_BLOCK bit is set to zero the SATL shall transfer the number of bytes specified in the location specified by the T_LENGTH field. If the value in the BYTE_BLOCK bit is set to one the SATL shall transfer the number of blocks specified in the location specified by the T_LENGTH field. The SATL shall ignore the BYTE_BLOCK bit when the T_LENGTH field is set to zero.

The CK_COND (Check Condition) bit may be used to request the SATL to return a copy of ATA register information in the sense data upon command completion. If the CK_COND bit is set to one the SATL shall return a status of CHECK CONDITION when the ATA command completes, even if the command completes successfully. If the command completes successfully, the SATL shall set the sense key to NO SENSE and shall set the additional sense code to NO ADDITIONAL SENSE INFORMATION. The SATL shall return the ATA registers and related information in the sense data using the ATA Status Return Descriptor (see table 12.2.5).

If the CK_COND bit is set to zero, the SATL shall terminate the command with CHECK CONDITION status only if an error occurs in processing the command. See clause 11 for a description of ATA error conditions. If the CK_COND bit is set to one and the command completes successfully the SATL shall terminate the command with CHECK CONDITION status with a sense key of RECOVERED ERROR and an additional sense code of ATA PASS-THROUGH INFORMATION AVAILABLE (see SPC-4) status.

The DEVICE field specifies a value for the SATL to load into the ATA DEVICE register or the DEVICE field of the Register - Host to Device FIS. Table 94 shows the bits in the DEVICE field.

Table 94 — ATA PASS-THROUGH (12) command and ATA PASS-THROUGH (16) command DEVICE field

Bit							
7	6	5	4	3	2	1	0
Obsolete	Command Specific	Obsolete	DEV	Command Specific			

The SATL shall ignore the DEV bit in the DEVICE field of the CDB. If the ATA host has two devices attached, the SATL may represent them as two distinct logical units or as two distinct SCSI target devices. The SATL shall set the DEV bit in the ATA DEVICE register to the value corresponding to the LUN or SCSI target port for each ATA device.

~~The SATL shall set the ATA host registers or construct the Register – Host to Device FIS using the values from the CDB in the FEATURES (7:0) field, the SECTOR_COUNT (7:0) field, the LBA_LOW (7:0) field, the LBA_MID (7:0) field, the LBA_HIGH (7:0) field, the DEVICE field, and the COMMAND field.~~

If the PROTOCOL field specifies a PIO data transfer, the SATL shall perform a PIO type transfer. The MULTIPLE_COUNT field specifies the power of two for the number of sectors transferred per DRQ Data Block (e.g, if the field is set to 4, the SATL shall transfer 2⁴ (i.e., 16) sectors of data in each DRQ Data Block). If the MULTIPLE_COUNT field is nonzero and the COMMAND field is not a READ MULTIPLE command, a READ MULTIPLE EXT command, a WRITE MULTIPLE command, a WRITE MULTIPLE EXT command, or a WRITE

Sequence number: 1
Author: DELL[KMarks]
Subject: Highlight
Date: 6/23/2006 11:56:36 PM

T 9th Paragraph, after 2nd sentence - **Table 93** — **PROTOCOL field change**

"...**COMMAND** field in..."
to
"...**Command** field in..."
RESOLUTION: see 06-291

Status
rsheffi Completed 7/24/2006 8:25:33 AM

Sequence number: 2
Author: DELL[KMarks]
Subject: Highlight
Date: 6/23/2006 11:57:43 PM

T 9th Paragraph, after 3rd sentence - **Table 93** — **PROTOCOL field change**

"If the ATA command completes with an error, then a copy of the PATA registers, or a copy of the SATA Register - Device to Host FIS shall be returned in the ATA Status Return Descriptor (see 12.2.5)."
to
"If the ATA command completes with an error, the SATL shall provide a copy of the PATA registers, or a copy of the SATA Register - Device to Host FIS available for reading using the ATA Status Return Descriptor (see 12.2.5) format."

Or something similar as previously written, implies requirement for autosense and descriptor based sense.

RESOLUTION: see 06-291 s/b
"If the ATA command completes with an error, then the SATL shall return the Error Output fields (see ATA8-ACS) in the ATA Return descriptor (see 12.2.5)."

Status
rsheffi Completed 7/24/2006 8:26:01 AM

Sequence number: 3
Author: MXO[MEvans]
Subject: Highlight
Date: 7/24/2006 8:27:48 AM

T 12.2.2 ATA PASS-THROUGH (12) command, twelfth paragraph: change the first sentence to, "The SATL shall configure the ATA host and device for the PIO, DMA, and UDMA transfer rates that both the SATL and the ATA device support. The SATL should set the transfer rates to the maximum supported by both the SATL and the ATA device."

RESOLUTION: see 06-291 s/b
"The SATL shall configure the ATA host and ATA device for the PIO, DMA, and UDMA transfer rates that both the SATL and the ATA device support. The SATL should set the transfer rates to the maximum supported by both the SATL and the ATA device."

Agree with "should set the transfer rates to the maximum..."

Status
rsheffi Completed 7/24/2006 8:27:52 AM

Sequence number: 4
Author: HPQ[RElliott]
Subject: Highlight
Date: 6/24/2006 12:03:05 AM

T 12.2.2

indicates s/b specifies
RESOLUTION: see 06-291

Status
rsheffi Completed 7/24/2006 8:28:11 AM

Sequence number: 5

The SATL shall determine if a data transfer is necessary and how to perform the data transfer by examining values in the MULTIPLE_COUNT field, PROTOCOL field, OFF_LINE field, T_DIR bit, BYTE_BLOCK bit, and T_LENGTH field. The SATL shall ignore the COMMAND field in the CDB except to copy the COMMAND field in the CDB to the COMMAND field in the Register – Host to Device FIS or to the ATA Command register. If the ATA command completes with an error, then a copy of the PATA registers, or a copy of the SATA Register - Device to Host FIS shall be returned in the ATA Status Return Descriptor (see 12.2.5).

The SATL shall configure the ATA host and device for the PIO, DMA, and UDMA speeds that both the SATL and ATA device support. The COMMAND field of the CDB may specify the ATA SET FEATURES command. The ATA PASS-THROUGH (12) command should not be used to issue an ATA SET FEATURES command that changes the PIO/DMA/UDMA or other transfer modes of the ATA device. The result of a SET FEATURES command that changes the PIO/DMA/UDMA or other transfer modes of the ATA device is outside the scope of this standard and may cause communication to be lost with the ATA device; preventing the SATL from performing any action based on the contents of the CDB.

The BYTE_BLOCK (Byte/Block) bit indicates whether the transfer length in the location specified by the T_LENGTH field specifies the number of bytes to transfer or the number of blocks to transfer. If the value in the BYTE_BLOCK bit is set to zero the SATL shall transfer the number of bytes specified in the location specified by the T_LENGTH field. If the value in the BYTE_BLOCK bit is set to one the SATL shall transfer the number of blocks specified in the location specified by the T_LENGTH field. The SATL shall ignore the BYTE_BLOCK bit when the T_LENGTH field is set to zero.

The CK_COND (Check Condition) bit may be used to request the SATL to return a copy of ATA register information in the sense data upon command completion. If the CK_COND bit is set to one the SATL shall return a status of CHECK CONDITION when the ATA command completes, even if the command completes successfully. If the command completes successfully, the SATL shall set the sense key to NO SENSE and shall set the additional sense code to NO ADDITIONAL SENSE INFORMATION. The SATL shall return the ATA registers and related information in the sense data using the ATA Status Return Descriptor (see table 12.2.5).

If the CK_COND bit is set to zero, the SATL shall terminate the command with CHECK CONDITION status only if an error occurs in processing the command. See clause 11 for a description of ATA error conditions. If the CK_COND bit is set to one and the command completes successfully the SATL shall terminate the command with CHECK CONDITION status with a sense key of RECOVERED ERROR and an additional sense code of ATA PASS-THROUGH INFORMATION AVAILABLE (see SPC-4) status.

The DEVICE field specifies a value for the SATL to load into the ATA DEVICE register or the DEVICE field of the Register - Host to Device FIS. Table 94 shows the bits in the DEVICE field.

Table 94 — ATA PASS-THROUGH (12) command and ATA PASS-THROUGH (16) command DEVICE field

Bit							
7	6	5	4	3	2	1	0
Obsolete	Command Specific	Obsolete	DEV	Command Specific			

The SATL shall ignore the DEV bit in the DEVICE field of the CDB. If the ATA host has two devices attached, the SATL may represent them as two distinct logical units or as two distinct SCSI target devices. The SATL shall set the DEV bit in the ATA DEVICE register to the value corresponding to the LUN or SCSI target port for each ATA device.

~~The SATL shall set the ATA host registers or construct the Register – Host to Device FIS using the values from the CDB in the FEATURES (7:0) field, the SECTOR_COUNT (7:0) field, the LBA_LOW (7:0) field, the LBA_MID (7:0) field, the LBA_HIGH (7:0) field, the DEVICE field, and the COMMAND field.~~

If the PROTOCOL field specifies a PIO data transfer, the SATL shall perform a PIO type transfer. The MULTIPLE_COUNT field specifies the power of two for the number of sectors transferred per DRQ Data Block (e.g, if the field is set to 4, the SATL shall transfer 2⁴ (i.e., 16) sectors of data in each DRQ Data Block). If the MULTIPLE_COUNT field is nonzero and the COMMAND field is not a READ MULTIPLE command, a READ MULTIPLE EXT command, a WRITE MULTIPLE command, a WRITE MULTIPLE EXT command, or a WRITE

Author: MXO[MEvans]
Subject: Highlight
Date: 6/24/2006 12:03:51 AM

T 12.2.2 ATA PASS-THROUGH (12) command, thirteenth paragraph: change "If the value in the BYTE_BLOCK bit is set to zero the SATL shall transfer..." to "If the value in the BYTE_BLOCK bit is set to zero, then the SATL shall transfer...".
RESOLUTION: see 06-291

Status
rlsheffi Completed 7/24/2006 8:28:44 AM

Sequence number: 6
Author: EDITOR[rlsheffi]
Subject: Rectangle
Date: 7/12/2006 11:45:49 PM

12.2.2 ATA PASS-THROUGH (12) command
Second to last and third to last paragraphs.

Notes:

These two paragraphs have several contradictions. One says if CK_COND is zero then return a CHECK CONDITION only if the command completes with an error, while the other says to return a CHECK CONDITION with RECOVERED ERROR sense key under the same conditions.

This may have been a result of a realization that if the command does not complete with CHECK CONDITION status, there is no way to fetch the results. But the text was never made fully consistent. It may be that this command has to complete with CHECK CONDITION status, regardless of the setting of the CK_COND bit?

These paragraphs need to define different but consistent behaviors for the following conditions:

- a) ck_cond set to one and ATA command completes successfully
- b) ck_cond set to one and ATA command completes with error
- c) ck_cond set to zero and ATA command completes successfully
- d) ck_cond set to zero and ATA command completes with error

RESOLUTION: see 06-291

Status
rlsheffi Completed 7/24/2006 8:30:19 AM

Sequence number: 7
Author: MXO[MEvans]
Subject: Highlight
Date: 6/24/2006 12:05:50 AM

T 12.2.2 ATA PASS-THROUGH (12) command, fourteenth paragraph: change to, "If the CK_COND bit is set to one, then the SATL shall return a status of CHECK CONDITION when the ATA command completes, even if the command completes without error. If the command completes without error, the SATL shall set the sense key to NO SENSE and the additional sense code to NO ADDITIONAL SENSE INFORMATION. The SATL shall return the ATA registers and related information in the sense data using the ATA Status Return Descriptor (see table 12.2.5)."

RESOLUTION: see 06-291

Status
rlsheffi Completed 7/24/2006 8:30:29 AM

Sequence number: 8
Author: DELL[KMarks]
Subject: Highlight
Date: 6/24/2006 12:06:08 AM

T Need to finish comment.

12th & 13th Paragraphs, - **Table 93 — PROTOCOL field**

These two paragraphs seem to conflict each other when CK_COND = 1. Not sure what the intended behavior is.

Is it NO SENSE or RECOVERED ERROR? Is it NO ADDITIONAL SENSE DATA INFORMATION OR ATA PASS-THROUGH INFORMATION AVAILIABLE (which is also stated in the in table 98 and 1st Paragraph after Table 98)

So I issue a pass thru command with ck_cond=1. The command completes with no error on the ATA side, the SATL then generates a check condition and if autosense autosense is supported return which sense/ASC + the ATA descriptor (assuming D_SENSE in control mode page is 1) is it No Sense for this, and if autosense is not supported, the response to

The SATL shall determine if a data transfer is necessary and how to perform the data transfer by examining values in the MULTIPLE_COUNT field, PROTOCOL field, OFF_LINE field, T_DIR bit, BYTE_BLOCK bit, and T_LENGTH field. The SATL shall ignore the COMMAND field in the CDB except to copy the COMMAND field in the CDB to the COMMAND field in the Register – Host to Device FIS or to the ATA Command register. If the ATA command completes with an error, then a copy of the PATA registers, or a copy of the SATA Register - Device to Host FIS shall be returned in the ATA Status Return Descriptor (see 12.2.5).

The SATL shall configure the ATA host and device for the PIO, DMA, and UDMA speeds that both the SATL and ATA device support. The COMMAND field of the CDB may specify the ATA SET FEATURES command. The ATA PASS-THROUGH (12) command should not be used to issue an ATA SET FEATURES command that changes the PIO/DMA/UDMA or other transfer modes of the ATA device. The result of a SET FEATURES command that changes the PIO/DMA/UDMA or other transfer modes of the ATA device is outside the scope of this standard and may cause communication to be lost with the ATA device; preventing the SATL from performing any action based on the contents of the CDB.

The BYTE_BLOCK (Byte/Block) bit indicates whether the transfer length in the location specified by the T_LENGTH field specifies the number of bytes to transfer or the number of blocks to transfer. If the value in the BYTE_BLOCK bit is set to zero the SATL shall transfer the number of bytes specified in the location specified by the T_LENGTH field. If the value in the BYTE_BLOCK bit is set to one the SATL shall transfer the number of blocks specified in the location specified by the T_LENGTH field. The SATL shall ignore the BYTE_BLOCK bit when the T_LENGTH field is set to zero.

The CK_COND (Check Condition) bit may be used to request the SATL to return a copy of ATA register information in the sense data upon command completion. If the CK_COND bit is set to one the SATL shall return a status of CHECK CONDITION when the ATA command completes, even if the command completes successfully. If the command completes successfully, the SATL shall set the sense key to NO SENSE and shall set the additional sense code to NO ADDITIONAL SENSE INFORMATION. The SATL shall return the ATA registers and related information in the sense data using the ATA Status Return Descriptor (see table 12.2.5).

If the CK_COND bit is set to zero, the SATL shall terminate the command with CHECK CONDITION status only if an error occurs in processing the command. See clause 11 for a description of ATA error conditions. If the CK_COND bit is set to one and the command completes successfully the SATL shall terminate the command with CHECK CONDITION status with a sense key of RECOVERED ERROR and an additional sense code of ATA PASS-THROUGH INFORMATION AVAILABLE (see SPC-4) status.

¹¹ The DEVICE field specifies a value for the SATL to load into the ATA DEVICE register or the DEVICE field of the Register - Host to Device FIS. Table 94 shows the bits in the DEVICE field.

Table 94 — ATA PASS-THROUGH (12) command and ATA PASS-THROUGH (16) command DEVICE field

Bit							
7	6	5	4	3	2	1	0
Obsolete	Command Specific	Obsolete	DEV	Command Specific			

The SATL shall ignore the DEV bit in the DEVICE field of the CDB. If the ATA host has two devices attached, the SATL may represent them as two distinct logical units or as two distinct SCSI target devices. The SATL shall set the DEV bit in the ATA DEVICE register to the value corresponding to the LUN or SCSI target port for each ATA device.

~~The SATL shall set the ATA host registers or construct the Register – Host to Device FIS using the values from the CDB in the FEATURES (7:0) field, the SECTOR_COUNT (7:0) field, the LBA_LOW (7:0) field, the LBA_MID (7:0) field, the LBA_HIGH (7:0) field, the DEVICE field, and the COMMAND field.~~

If the PROTOCOL field specifies a PIO data transfer, the SATL shall perform a PIO type transfer. The MULTIPLE_COUNT field specifies the power of two for the number of sectors transferred per DRQ Data Block (e.g, if the field is set to 4, the SATL shall transfer 2⁴ (i.e., 16) sectors of data in each DRQ Data Block). If the MULTIPLE_COUNT field is nonzero and the COMMAND field is not a READ MULTIPLE command, a READ MULTIPLE EXT command, a WRITE MULTIPLE command, or a WRITE MULTIPLE EXT command,

the REQUEST SENSE is RECOVERED ERROR + PASS-THRU INFO AVAILAIBLE + ATA descriptor, depending on DESC bit in the request sense?

What is the response with ck_cond=1 and the ATA command completes with an error?

If ck_cond=0 and ATA completes with an error, then check condition and use clause 11 for sense/asc?

Need to reword statements like "command completes successfully" to "ATA command completes with no error"

RESOLUTION: see 06-291

Status
risheffi Completed 7/24/2006 8:30:35 AM

Sequence number: 9
Author: MXO[MEvans]
Subject: Highlight
Date: 6/24/2006 12:06:21 AM

T 12.2.2 ATA PASS-THROUGH (12) command, fifteenth paragraph: change "If the CK_COND bit is set to one and the command completes successfully the SATL shall return..." to "If the CK_COND bit is set to one and the command completes without error, then the SATL shall return..."

RESOLUTION: see 06-291

Status
risheffi Completed 7/24/2006 8:30:42 AM

Sequence number: 10
Author: HPQ[RElliott]
Date: 6/24/2006 12:06:30 AM

T 12.2.2
one s/b zero

RESOLUTION: see 06-291

Status
risheffi Completed 7/24/2006 8:30:52 AM

Sequence number: 11
Author: DELL[KMarks]
Subject: Highlight
Date: 6/24/2006 12:08:50 AM

T 14th Paragraphs, after **Table 93 — PROTOCOL field**
change
"The **DEVICE** field specifies a value for the SATL to load into the ATA **DEVICE** register or the **DEVICE** field of the Register - Host to Device FIS."
to

"The **DEVICE** field specifies a value for the SATL to load into the ATA Device register or the Device field of the Register - Host to Device FIS."

RESOLUTION: see 06-291

Status
risheffi Completed 7/24/2006 9:28:51 AM

Sequence number: 12
Author: HPQ[RElliott]
Date: 6/19/2006 5:11:38 PM

T 12.2.2

Why define the bit, in the brand new command, if the SATL is going to completely ignore it?

Note: The structure of this field mirrors that of the Device field in the ATA registers, and so, to some degree, it's informational rather than normative. The DEV bit is listed for informational purposes. How do we split out the informational versus normative elements of the Device register / DEVICE field?

REASON: The DEV bit is relevant because the SATL has to treat it differently from other bits in the DEVICE register.

Status
risheffi Rejected 6/19/2006 5:10:39 PM

Comments from page 110 continued on next page

The SATL shall determine if a data transfer is necessary and how to perform the data transfer by examining values in the MULTIPLE_COUNT field, PROTOCOL field, OFF_LINE field, T_DIR bit, BYTE_BLOCK bit, and T_LENGTH field. The SATL shall ignore the COMMAND field in the CDB except to copy the COMMAND field in the CDB to the COMMAND field in the Register – Host to Device FIS or to the ATA Command register. If the ATA command completes with an error, then a copy of the PATA registers, or a copy of the SATA Register - Device to Host FIS shall be returned in the ATA Status Return Descriptor (see 12.2.5).

The SATL shall configure the ATA host and device for the PIO, DMA, and UDMA speeds that both the SATL and ATA device support. The COMMAND field of the CDB may specify the ATA SET FEATURES command. The ATA PASS-THROUGH (12) command should not be used to issue an ATA SET FEATURES command that changes the PIO/DMA/UDMA or other transfer modes of the ATA device. The result of a SET FEATURES command that changes the PIO/DMA/UDMA or other transfer modes of the ATA device is outside the scope of this standard and may cause communication to be lost with the ATA device; preventing the SATL from performing any action based on the contents of the CDB.

The BYTE_BLOCK (Byte/Block) bit indicates whether the transfer length in the location specified by the T_LENGTH field specifies the number of bytes to transfer or the number of blocks to transfer. If the value in the BYTE_BLOCK bit is set to zero the SATL shall transfer the number of bytes specified in the location specified by the T_LENGTH field. If the value in the BYTE_BLOCK bit is set to one the SATL shall transfer the number of blocks specified in the location specified by the T_LENGTH field. The SATL shall ignore the BYTE_BLOCK bit when the T_LENGTH field is set to zero.

The CK_COND (Check Condition) bit may be used to request the SATL to return a copy of ATA register information in the sense data upon command completion. If the CK_COND bit is set to one the SATL shall return a status of CHECK CONDITION when the ATA command completes, even if the command completes successfully. If the command completes successfully, the SATL shall set the sense key to NO SENSE and shall set the additional sense code to NO ADDITIONAL SENSE INFORMATION. The SATL shall return the ATA registers and related information in the sense data using the ATA Status Return Descriptor (see table 12.2.5).

If the CK_COND bit is set to zero, the SATL shall terminate the command with CHECK CONDITION status only if an error occurs in processing the command. See clause 11 for a description of ATA error conditions. If the CK_COND bit is set to one and the command completes successfully the SATL shall terminate the command with CHECK CONDITION status with a sense key of RECOVERED ERROR and an additional sense code of ATA PASS-THROUGH INFORMATION AVAILABLE (see SPC-4) status.

The DEVICE field specifies a value for the SATL to load into the ATA DEVICE register or the DEVICE field of the Register - Host to Device FIS. Table 94 shows the bits in the DEVICE field.

Table 94 — ATA PASS-THROUGH (12) command and ATA PASS-THROUGH (16) command DEVICE field

Bit							
7	6	5	4	3	2	1	0
Obsolete	Command Specific	Obsolete	DEV	Command Specific			

¹³ The SATL shall ignore the DEV bit in the DEVICE field of the CDB. ¹⁴ If the ATA host has two devices attached, the SATL may represent them as two distinct logical units or as two distinct SCSI target devices. The SATL shall set the DEV bit in the ATA DEVICE register to the ¹⁵ value corresponding to the LUN or SCSI target port for each ATA device.

~~¹⁶ The SATL shall set the ATA host registers or construct the Register – Host to Device FIS using the values from the CDB in the FEATURES (7:0) field, the SECTOR_COUNT (7:0) field, the LBA_LOW (7:0) field, the LBA_MID (7:0) field, the LBA_HIGH (7:0) field, the DEVICE field, and the COMMAND field.~~

If the PROTOCOL field specifies a PIO data transfer, the SATL shall perform a PIO type transfer. The MULTIPLE_COUNT field specifies the power of two for the number of sectors transferred per DRQ Data Block (e.g, if the field is set to 4, the SATL shall transfer 2⁴ (i.e., 16) sectors of data in each DRQ Data Block). If the MULTIPLE_COUNT field is nonzero and the COMMAND field is not a READ MULTIPLE command, a READ MULTIPLE EXT command, a WRITE MULTIPLE command, or a WRITE MULTIPLE EXT command,

Sequence number: 13
Author: DELL[KMarks]
Subject: Highlight
Date: 6/24/2006 12:10:23 AM

T 1st Paragraph after **Table 94 — ATA PASS-THROUGH (12) command and ATA PASS-THROUGH (16) command DEVICE field**
change

"The SATL shall ignore the DEV bit in the DEVICE field of the CDB. If the ATA host has two devices attached, the SATL may represent them as two distinct logical units or as two distinct SCSI target devices. The SATL shall set the DEV bit in the ATA DEVICE register to the value corresponding to the LUN or SCSI target port for each ATA device."

to

"The SATL shall ignore the DEV bit in the DEVICE field of the CDB. If the ATA host has two devices attached, the SATL may represent them as two distinct logical units or as two distinct SCSI target devices. The SATL shall set the DEV bit in the ATA Device register to the value corresponding to the logical unit or SCSI target device for each ATA device."

Not sure if this paragraph belongs her, as it is talking about the SATL model.

RESOLUTION: see 06-291 s/b

"The SATL shall ignore the dev bit in the device field of the CDB.

The SATL shall set the value of the DEV bit in the ATA device register based upon the mapping of ATA devices to I_T_L nexuses."

Status
rlsheffi Completed 7/24/2006 9:29:24 AM

Sequence number: 14
Author: HPQ[RElliott]
Date: 6/24/2006 12:10:59 AM

T 12.2.2

"If the ATA host has two devices attached, the SATL may represent them as two distinct logical units or as two distinct SCSI target devices. The SATL shall set the DEV bit in the ATA DEVICE register to the value corresponding to the LUN or SCSI target port for each ATA device." doesn't belong buried in a bit description in a command.

RESOLUTION: see 06-291

Status
rlsheffi Completed 7/24/2006 9:29:46 AM

Sequence number: 15
Author: IBM[GPenokie]
Subject: Comment on Text
Date: 6/24/2006 12:11:30 AM

T 1st paragraph after table 94

This << value corresponding to the LUN or SCSI target port for each >> should be << value corresponding to the logical unit or SCSI target port for each >>

RESOLUTION: see 06-291

Status
rlsheffi Completed 7/24/2006 9:29:53 AM

Sequence number: 16
Author: DELL[KMarks]
Subject: Cross-Out
Date: 6/24/2006 12:12:46 AM

T 2nd Paragraph after **Table 94 — ATA PASS-THROUGH (12) command and ATA PASS-THROUGH (16) command DEVICE field**
remove

"The SATL shall set the ATA host registers or construct the Register - Host to Device FIS using the values from the CDB in the FEATURES (7:0) field, the SECTOR_COUNT (7:0) field, the LBA_LOW (7:0) field, the LBA_MID (7:0) field, the LBA_HIGH (7:0) field, the DEVICE field, and the COMMAND field."

This is already stated a couple of paragraphs above and has the (7:0) parts, see comment above.

RESOLUTION: see 06-291

Status

Comments from page 110 continued on next page

The SATL shall determine if a data transfer is necessary and how to perform the data transfer by examining values in the MULTIPLE_COUNT field, PROTOCOL field, OFF_LINE field, T_DIR bit, BYTE_BLOCK bit, and T_LENGTH field. The SATL shall ignore the COMMAND field in the CDB except to copy the COMMAND field in the CDB to the COMMAND field in the Register – Host to Device FIS or to the ATA Command register. If the ATA command completes with an error, then a copy of the PATA registers, or a copy of the SATA Register - Device to Host FIS shall be returned in the ATA Status Return Descriptor (see 12.2.5).

The SATL shall configure the ATA host and device for the PIO, DMA, and UDMA speeds that both the SATL and ATA device support. The COMMAND field of the CDB may specify the ATA SET FEATURES command. The ATA PASS-THROUGH (12) command should not be used to issue an ATA SET FEATURES command that changes the PIO/DMA/UDMA or other transfer modes of the ATA device. The result of a SET FEATURES command that changes the PIO/DMA/UDMA or other transfer modes of the ATA device is outside the scope of this standard and may cause communication to be lost with the ATA device; preventing the SATL from performing any action based on the contents of the CDB.

The BYTE_BLOCK (Byte/Block) bit indicates whether the transfer length in the location specified by the T_LENGTH field specifies the number of bytes to transfer or the number of blocks to transfer. If the value in the BYTE_BLOCK bit is set to zero the SATL shall transfer the number of bytes specified in the location specified by the T_LENGTH field. If the value in the BYTE_BLOCK bit is set to one the SATL shall transfer the number of blocks specified in the location specified by the T_LENGTH field. The SATL shall ignore the BYTE_BLOCK bit when the T_LENGTH field is set to zero.

The CK_COND (Check Condition) bit may be used to request the SATL to return a copy of ATA register information in the sense data upon command completion. If the CK_COND bit is set to one the SATL shall return a status of CHECK CONDITION when the ATA command completes, even if the command completes successfully. If the command completes successfully, the SATL shall set the sense key to NO SENSE and shall set the additional sense code to NO ADDITIONAL SENSE INFORMATION. The SATL shall return the ATA registers and related information in the sense data using the ATA Status Return Descriptor (see table 12.2.5).

If the CK_COND bit is set to zero, the SATL shall terminate the command with CHECK CONDITION status only if an error occurs in processing the command. See clause 11 for a description of ATA error conditions. If the CK_COND bit is set to one and the command completes successfully the SATL shall terminate the command with CHECK CONDITION status with a sense key of RECOVERED ERROR and an additional sense code of ATA PASS-THROUGH INFORMATION AVAILABLE (see SPC-4) status.

The DEVICE field specifies a value for the SATL to load into the ATA DEVICE register or the DEVICE field of the Register - Host to Device FIS. Table 94 shows the bits in the DEVICE field.

Table 94 — ATA PASS-THROUGH (12) command and ATA PASS-THROUGH (16) command DEVICE field

Bit							
7	6	5	4	3	2	1	0
Obsolete	Command Specific	Obsolete	DEV	Command Specific			

The SATL shall ignore the DEV bit in the DEVICE field of the CDB. If the ATA host has two devices attached, the SATL may represent them as two distinct logical units or as two distinct SCSI target devices. The SATL shall set the DEV bit in the ATA DEVICE register to the value corresponding to the LUN or SCSI target port for each ATA device.

~~The SATL shall set the ATA host registers or construct the Register – Host to Device FIS using the values from the CDB in the FEATURES (7:0) field, the SECTOR_COUNT (7:0) field, the LBA_LOW (7:0) field, the LBA_MID (7:0) field, the LBA_HIGH (7:0) field, the DEVICE field, and the COMMAND field.~~

If the PROTOCOL field specifies a PIO data transfer, the SATL shall perform a PIO type transfer.¹⁸ The MULTIPLE_COUNT field specifies the number of two for the number of sectors transferred per DRQ Data Block (e.g, if the field is set to 4, the SATL shall transfer 2⁴ (i.e., 16) sectors of data in each DRQ Data Block).¹⁹ If the MULTIPLE_COUNT field is nonzero and the COMMAND field is not a READ MULTIPLE command, a READ MULTIPLE EXT command, a WRITE MULTIPLE command, a WRITE MULTIPLE EXT command, or a WRITE

risheffi Completed 7/24/2006 9:30:03 AM

Sequence number: 17
Author: HPQ[RElliott]
Date: 6/24/2006 12:13:16 AM
T 12.2.2

"the DEVICE field," is listed but the previous paragraph hints that at least one bit (bit 4) is ignored
RESOLUTION: see 06-291 - delete paragraph (see DELL comment)

Status
risheffi Completed 7/24/2006 9:30:13 AM

Sequence number: 18
Author: EDITOR[risheffi]
Subject: Highlight
Date: 6/24/2006 12:14:53 AM

T s/b
"The MULTIPLE_COUNT field specifies the logarithm base 2 of the number of logical sectors a ATA host shall transfer per DRQ Data Block (e.g, if the field is set to 4, the SATL shall transfer 2^4 (i.e., 16) logical sectors of data in each DRQ Data Block)."
RESOLUTION: see 06-291

Status
risheffi Completed 7/24/2006 9:30:55 AM

Sequence number: 19
Author: EDITOR[risheffi]
Subject: Underline
Date: 6/24/2006 12:15:29 AM

T Use "logarithm base 2".
RESOLUTION: see 06-291

Status
risheffi Completed 7/24/2006 9:31:01 AM

Sequence number: 20
Author: HPQ[RElliott]
Date: 6/24/2006 12:16:34 AM
T 9.2.2

The units for DRQ data blocks are bytes or words, according to ATA8-AAM, not sectors.

Editor's comment: I don't see this in AAM, but the SET MULTIPLE MODE command defined in ATA8-ACS sets the number of sectors per block, and this is consistent with ATA/ATAPI-7 V1. It could be that the latest draft revision of ATA8-AAM could have it incorrect.

RESOLUTION: see 06-291

Status
risheffi Completed 7/24/2006 9:31:28 AM

MULTIPLE FUA EXT command, then the SATL shall terminate the command with CHECK CONDITION status with the sense key set to ILLEGAL REQUEST, and the additional sense code set to INVALID FIELD IN CDB.

The OFF_LINE field specifies the time period during which the ATA Status register and the ATA Alternate Status register may be invalid after command acceptance. In a SATL with a PATA device attached, some commands may cause the PATA device to place the ATA bus in an indeterminate state. This may cause the ATA host to see command completion before the command is completed. When the application client issues a command that is capable of placing the bus in an indeterminate state, it shall set the OFF_LINE field to a value that specifies the maximum number of seconds from the time a command is issued until the ATA Status register is valid. The SATL shall not use the ATA Status register or ATA Alternate Status register to determine ATA command completion status until this time has elapsed. The valid status is available ($2^{\text{off_line}+1} - 2$) seconds (i.e., 0, 2, 6, and 14 seconds) after the command register is stored.

NOTE 11 - If the application client specifies an off_line value that is too small, the results are indeterminate and may compromise the integrity of the data.

1 the Transfer Direction (T_DIR) and the direction of the data transfer specified in the PROTOCOL field do not match, the SATL shall terminate the command with CHECK CONDITION status with the sense key set to ILLEGAL REQUEST and the additional sense code set to INVALID FIELD IN CDB.

3 T_DIR is set to zero the SATL shall transfer from the application client to the ATA device. If T_DIR is set to one the SATL shall transfer from the ATA device to the application client. The SATL shall ignore T_DIR if T_LENGTH is set to zero.

The Transfer Length (T_LENGTH) field specifies where in the CDB the SATL shall locate the transfer length for the command (see table 95). ~~4 The transfer length is an unsigned integer in the range of 00h to FFh.~~

Table 95 — T_LENGTH field

Code	Description
00b	No data is transferred
01b	The transfer length is specified in the FEATURES (7:0) field
10b	The transfer length is specified in the SECTOR_COUNT (7:0) field
11b	The transfer length is specified in the STPSIU field

~~The FEATURES (7:0) field, the SECTOR_COUNT (7:0) field, the LBA_LOW (7:0) field, the LBA_MID (7:0) field, the LBA_HIGH (7:0) field, the DEVICE field, and the COMMAND field shall be copied to the corresponding fields or registers of the same name in the ATA host within the SATL (see ATA/ATAPI 7).~~

12.2.3 ATA PASS-THROUGH (16) command

Table 96 shows format of the ATA PASS-THROUGH (16) command.

If the EXTEND bit is set to zero, then the SECTOR_COUNT (15:8) field, the LBA_LOW (15:8) field, the LBA_MID (15:8) field, and the LBA_HIGH (15:8) field shall be ignored by the SATL, and the SATL shall process this command as specified in 12.2.2.

Sequence number: 1
Author: DELL[KMarks]
Subject: Highlight
Date: 6/24/2006 12:18:21 AM

T 1st Paragraph 1st Sentence after Note 11
change

"If the Transfer Direction (T_DIR) and the..."

to

"If the Transfer Direction (T_DIR) bit and the..."

RESOLUTION: see 06-291

Status
rsheffi Completed 7/24/2006 9:32:16 AM

Sequence number: 2
Author: DELL[KMarks]
Subject: Highlight
Date: 7/24/2006 9:35:20 AM

T 2nd Paragraph after Note 11
change

"If T_DIR is set to zero the SATL shall transfer from the application client to the ATA device. If T_DIR is set to one the SATL shall transfer from the ATA device to the application client. The SATL shall ignore T_DIR if T_LENGTH is set to zero."

to

"If T_DIR bit is set to zero the SATL shall transfer from the application client to the ATA device. If T_DIR bit is set to one the SATL shall transfer from the ATA device to the application client. The SATL shall ignore T_DIR bit if T_LENGTH field is set to 00b."

Proposed resolution: s/b

"If the T_DIR bit is set to zero, then the SATL shall transfer data from the application client to the ATA device. If the T_DIR bit is set to one, then the SATL shall transfer data from the ATA device to the application client. The SATL shall ignore the T_DIR bit if the T_LENGTH field is set to 00b."

RESOLUTION: see 06-291 (Note: 06-291 read, "shall transfer from". In SAT-r08c it's changed to "shall transfer data from").

Status
rsheffi Completed 7/24/2006 9:35:25 AM

Sequence number: 3
Author: MXO[MEvans]
Subject: Highlight
Date: 6/24/2006 12:21:51 AM

T 12.2.2 ATA PASS-THROUGH (12) command, twenty-third paragraph: change "If T_DIR is set to zero the SATL shall transfer..." to "If T_DIR is set to zero, then the SATL shall transfer..."

RESOLUTION: see 06-291

Status
rsheffi Completed 7/24/2006 9:35:56 AM

Sequence number: 4
Author: DELL[KMarks]
Subject: Cross-Out
Date: 6/24/2006 12:25:04 AM

T Remove

"The transfer length is an unsigned integer in the range of 00h to FFh."

Already in table 95, based on field size, if it was restricted then OK.

RESOLUTION: Delete this sentence, but change the entries in table 95 to read as follows:

Code	Description
00b	No data is transferred
01b	The transfer length is an unsigned integer specified in the FEATURES (7:0) field
10b	The transfer length is an unsigned integer specified in the SECTOR_COUNT (7:0) field
11b	The transfer length is an unsigned integer specified in the STPSIU (see

RESOLUTION: see 06-291

MULTIPLE FUA EXT command, then the SATL shall terminate the command with CHECK CONDITION status with the sense key set to ILLEGAL REQUEST, and the additional sense code set to INVALID FIELD IN CDB.

The OFF_LINE field specifies the time period during which the ATA Status register and the ATA Alternate Status register may be invalid after command acceptance. In a SATL with a PATA device attached, some commands may cause the PATA device to place the ATA bus in an indeterminate state. This may cause the ATA host to see command completion before the command is completed. When the application client issues a command that is capable of placing the bus in an indeterminate state, it shall set the OFF_LINE field to a value that specifies the maximum number of seconds from the time a command is issued until the ATA Status register is valid. The SATL shall not use the ATA Status register or ATA Alternate Status register to determine ATA command completion status until this time has elapsed. The valid status is available ($2^{\text{off_line}+1} - 2$) seconds (i.e., 0, 2, 6, and 14 seconds) after the command register is stored.

NOTE 11 - If the application client specifies an off_line value that is too small, the results are indeterminate and may compromise the integrity of the data.

If the Transfer Direction (T_DIR) and the direction of the data transfer specified in the PROTOCOL field do not match, the SATL shall terminate the command with CHECK CONDITION status with the sense key set to ILLEGAL REQUEST and the additional sense code set to INVALID FIELD IN CDB.

If T_DIR is set to zero the SATL shall transfer from the application client to the ATA device. If T_DIR is set to one the SATL shall transfer from the ATA device to the application client. The SATL shall ignore T_DIR if T_LENGTH is set to zero.

The Transfer Length (T_LENGTH) field specifies where in the CDB the SATL shall locate the transfer length for the command (see table 95). ~~The transfer length is an unsigned integer in the range of 00h to FFh.~~

Table 95 — T_LENGTH field

Code	Description
00b	No data is transferred
01b	The transfer length is specified in the FEATURES (7:0) field
10b	The transfer length is specified in the SECTOR_COUNT (7:0) field
11b	The transfer length is specified in the 7:6 TPSIU field

~~8 The FEATURES (7:0) field, the SECTOR_COUNT (7:0) field, the LBA_LOW (7:0) field, the LBA_MID (7:0) field, the LBA_HIGH (7:0) field, the DEVICE field, and the COMMAND field shall be copied to the corresponding fields or registers of the same name in the ATA host within the SATL (see ATA/ATAPI 7).~~

9 12.2.3 ATA PASS-THROUGH (16) command

Table 96 shows format of the ATA PASS-THROUGH (16) command.

If the EXTEND bit is set to zero, then the SECTOR_COUNT (15:8) field, the LBA_LOW (15:8) field, the LBA_MID (15:8) field, and the LBA_HIGH (15:8) field shall be ignored by the SATL, and the SATL shall process this command as specified in 12.2.2.

Status
risheffi Completed 7/24/2006 9:36:17 AM

Sequence number: 5
Author: DELL[KMarks]
Subject: Note
Date: 7/12/2006 10:40:21 PM
 **Table 95 — T_LENGTH field**

In Row 11b - What and where is the STPSIU field?

RESOLUTION: See 06-291r2

Status
risheffi Completed 7/24/2006 9:36:44 AM

Sequence number: 6
Author: HPQ[RElliott]
Date: 6/24/2006 12:36:34 AM
 12.2.2
table 95

there is no such thing as a "STPSIU field". See the original proposal for an explanation of what this was (STPSIU was an acronym)

BACKGROUND: Came from 04-262r8, was an acronym for SCSI Transport Protocol-Specific Information Unit (not a field name).

RESOLUTION: see 06-291

Add a definitions entry:

"SCSI Transport Protocol-Specific Information Unit: A transport-specific information unit used to transport information defined in SCSI command standards between initiator ports and target ports that may contain additional information needed by the service delivery subsystem to effect the requested information unit transfers."

Status
risheffi Completed 7/24/2006 9:36:54 AM

Sequence number: 7
Author: ENDL[RWeber]
Date: 6/24/2006 12:36:44 AM
 table 95, row 4
T What is the STPSIU field? It is mentioned only three times in the working draft and none of them define it.

RESOLUTION: see 06-291

Status
risheffi Completed 7/24/2006 9:37:03 AM

Sequence number: 8
Author: DELL[KMarks]
Subject: Cross-Out
Date: 6/24/2006 12:37:54 AM
 **1st Paragraph after Table 95 — T_LENGTH field**

remove

"The FEATURES (7:0) field, the SECTOR_COUNT (7:0) field, the LBA_LOW (7:0) field, the LBA_MID (7:0) field, the LBA_HIGH (7:0) field, the DEVICE field, and the COMMAND field shall be copied to the corresponding fields or registers of the same name in the ATA host within the SATL (see ATA/ATAPI-7)."

This is already stated similarly above.

RESOLUTION: see 06-291 (reworded to reference a table showing the field correspondence)

Status
risheffi Completed 7/24/2006 9:37:54 AM

Sequence number: 9
Author: IBM[GPenokie]
Subject: Underline
Date: 2/16/2006 1:44:22 PM
 12.2.3 ATA PASS-THROUGH (16) command

Status
risheffi Cancelled 5/7/2006 11:32:04 PM

Comments from page 111 continued on next page

If the EXTEND bit is set to one, then the SECTOR_COUNT (15:8) field, the LBA_LOW (15:8) field, the LBA_MID (15:8) field, and the LBA_HIGH (15:8) field are valid, and the SATL shall process this command as specified in 12.2.2 except as described in the remainder of this subclause.

Table 96 — ATA PASS-THROUGH (16) command

Byte\Bit	7	6	5	4	3	2	1	0
0	OPERATION CODE (85h)							
1	MULTIPLE_COUNT			PROTOCOL				EXTEND
2	OFF_LINE	CK_COND	Reserved	T_DIR	BYTE_BLOCK	T_LENGTH		
3	FEATURES (15:8)							
4	FEATURES (7:0)							
5	SECTOR_COUNT (15:8)							
6	SECTOR_COUNT (7:0)							
7	LBA_LOW (15:8)							
8	LBA_LOW (7:0)							
9	LBA_MID (15:8)							
10	LBA_MID (7:0)							
11	LBA_HIGH (15:8)							
12	LBA_HIGH (7:0)							
13	DEVICE							
14	COMMAND							
15	CONTROL (see 6.4)							

¹ the EXTEND bit is set to one and the value in the PROTOCOL field requests the SATL to send an ATA command to the device, then the SATL shall send a 48 bit ATA command to the ATA device. The SATL shall use the FEATURES (7:0) field, the SECTOR_COUNT (7:0) field, the LBA_LOW (7:0) field, the LBA_MID (7:0) field, the LBA_HIGH (7:0) field, the FEATURES (15:8) field, the SECTOR_COUNT (15:8) field, the LBA_LOW (15:8) field, the LBA_MID (15:8) field, the LBA_HIGH (15:8) field, the DEVICE field and the COMMAND field to initiate a command in the ATA device. ² these fields correspond to the registers defined in ATA/ATAPI-7 volume 2 with the same names, and also to the FIS fields defined in ATA/ATAPI-7 volume 3 with the same names.

³

See 12.2.2 for a description of the MULTIPLE_COUNT field, the PROTOCOL field, the OFF_LINE field, the CK_COND bit, the T_DIR bit, and the BYTE_BLOCK bit.

Sequence number: 1
Author: DELL[KMarks]
Subject: Highlight
Date: 5/7/2006 11:36:22 PM

T 1st Sentence after Table 96 — ATA PASS-THROUGH (16) command

"If the EXTEND bit is set to one and the value in the PROTOCOL field requests the SATL to send an ATA command to the device, then the SATL shall send a 48 bit ATA command to the ATA device."

Is this sentence necessary, since the command code field defines if it is 48 bit or not? It's not like the SATL gets to decide which command to use on pass thru.

REASON: Presumably the ATA PASS-THROUGH (16) command may be used to send various ATA commands, both the 48-bit variety as well as the shorter ones. Since the ATA PASS-THROUGH (16) command is not supposed to parse the ATA command itself, it needs the EXTEND bit to define which fields in the CDB are used to set the ATA registers for the specified command.

Status
rlsheffi Rejected 5/7/2006 11:36:26 PM

Sequence number: 2
Author: EDITOR[rlsheffi]
Subject: Highlight
Date: 6/24/2006 1:39:45 PM

T 12.2.3 ATA PASS-THROUGH (16) command First paragraph after Table 96 — ATA PASS-THROUGH (16) command

proposed resolution:
change

"These fields correspond to the registers defined in ATA/ATAPI-7 volume 2 with the same names, and also to the FIS fields defined in ATA/ATAPI-7 volume 3 with the same names."

to

"These fields correspond to the fields defined in ATA8-ACS with the same names."

RESOLUTION: see 06-291(mapped the field correspondence with a table)

Status
rlsheffi Completed 7/24/2006 9:45:45 AM

Sequence number: 3
Author: EDITOR[rlsheffi]
Subject: Note
Date: 7/24/2006 9:46:12 AM

 Add the following for consistency with the ATA PASS-THROUGH (12) command description:

"12.2.4 describes the mapping from the features (15:8) field, the features (7:0) field, the sector_count (15:8) field, the sector_count (7:0) field, the lba_low (15:8) field, the lba_low (7:0) field, the lba_mid (15:8) field, the lba_mid (7:0) field, the lba_high (15:8) field, the lba_high (7:0) field, the device field, and the command field in the ATA PASS-THROUGH (16) CDB to corresponding ATA command fields (see ATA8-ACS)."

RESOLUTION: Completed in SAT-r08c

Status
rlsheffi Completed 7/24/2006 9:52:44 AM

The SATL shall determine the transfer length by the method specified in the T_LENGTH field (see table 97).¹
~~EXTEND bit is set to zero, the transfer length shall be an unsigned integer in the range from 00h to FFh. If
 EXTEND bit is set to one, the transfer length shall be an unsigned integer in the range from 0000h to FFFFh.~~

Table 97 — EXTEND bit and T_LENGTH field

EXTEND	T_LENGTH	Description
0b	00b	No data is transferred.
	01b	The transfer length is specified in the FEATURES (7:0) field.
	10b	The transfer length is specified in the SECTOR_COUNT (7:0) field.
	11b	The transfer length is specified in the STPSIU field.
1b	00b	No data is transferred.
	01b	The transfer length is specified in the FEATURES (7:0) field and the FEATURES (15:8) field.
	10b	The transfer length is specified in the SECTOR_COUNT (7:0) field and the SECTOR_COUNT (15:8) field.
	11b	The transfer length is specified in the STPSIU field.

12.2.4 ATA PASS-THROUGH status return

Table 98 shows the possible results of ATA PASS-THROUGH (12) command or ATA PASS-THROUGH (16) command processing as reflected in the ATA_ERR bit and DF bit in the ATA STATUS register or in the STATUS-HI field and the STATUS-LO field of the SATA Set Device Bits – Device to Host FIS.

Table 98 — ATA command results

ATA_ERR	DF	sense data returned
zero	zero	No error, successful completion or command in progress. If the CK_COND bit is set to zero in the ATA PASS-THROUGH (12) command or the ATA PASS-THROUGH (16) command, then the SATL shall respond to a REQUEST SENSE command and shall return sense data with the sense key set to NO SENSE with the additional sense code set to NO ADDITIONAL SENSE INFORMATION. If the CK_COND bit is set to one in the ATA PASS-THROUGH (12) command or the ATA PASS-THROUGH (16) command, then the SATL shall terminate the command with CHECK CONDITION status with the sense key set to NO SENSE with the additional sense code set to ATA PASS-THROUGH INFORMATION AVAILABLE (see SPC-4). The sense data shall include the ATA Status Return Descriptor.
zero	one	The command was not accepted or otherwise failed to complete successfully. The SATL shall terminate the command with CHECK CONDITION status with the additional sense code set to ATA PASS-THROUGH INFORMATION AVAILABLE. The sense data shall include the ATA Status Return Descriptor.
one	zero	
one	one	Undefined

If the sense data is provided in response to an ATA PASS-THROUGH (12) command or ATA PASSTHROUGH (16) command in which the CK_COND bit was set to one, then the SATL shall set the additional sense code to ATA PASS- THROUGH INFORMATION AVAILABLE (see SPC-4), and shall include the ATA Status Return Descriptor (see 12.2.5) in the sense data.

NOTE 12 -This capability allows the host to retrieve the ATA register or field information with successful command completion by returning data in the ATA registers or fields.

Sequence number: 1
Author: DELL[KMarks]
Subject: Cross-Out
Date: 6/24/2006 12:50:51 AM
 2 Sentence before Table 97.

This is already stated in Table 97, based on field size.

remove

"If EXTEND bit is set to zero, the transfer length shall be an unsigned integer in the range from 00h to FFh. If EXTEND bit is set to one, the transfer length shall be an unsigned integer in the range from 0000h to FFFFh."

RESOLUTION: see 06-291- As suggested, and in Table 97, change each occurrence of "The transfer length is specified..." to "The transfer length is an unsigned integer specified..."

Status
risheffi Completed 7/24/2006 9:48:56 AM

Sequence number: 2
Author: IBM[GPenokie]
Subject: Comment on Text
Date: 7/24/2006 9:49:53 AM
 table 97

The << 0b >> should be << 0 >> and << 1b >> should be << 1 >>.

RESOLUTION: see 06-291 (Fixed in SAT-r08c)

Status
risheffi Completed 7/24/2006 9:49:57 AM

Sequence number: 3
Author: DELL[KMarks]
Subject: Note
Date: 6/24/2006 12:53:32 AM

 **Table 97 — EXTEND bit and T_LENGTH field**

In Both Rows where T_LENGTH = 11b - What and where is the STPSIU field?

RESOLUTION: see 06-291

Add a definitions entry:

"SCSI Transport Protocol-Specific Information Unit: A transport-specific information unit used to transport information defined in SCSI command standards between initiator ports and target ports that may contain additional information needed by the service delivery subsystem to effect the requested information unit transfers."

Status
risheffi Completed 7/24/2006 9:50:33 AM

Sequence number: 4
Author: ENDL[RWeber]
Date: 6/24/2006 12:53:45 AM

 table 97, rows 4 & 8

T _T_ What is the STPSIU field? It is mentioned only three times in the working draft and none of them define it. [two times in this table]

RESOLUTION: see 06-291

Status
risheffi Completed 7/24/2006 9:50:41 AM

Sequence number: 5
Author: ENDL[RWeber]
Date: 6/24/2006 12:54:13 AM

 RESOLUTION: see 06-291

Status
risheffi Completed 7/24/2006 9:50:50 AM

The SATL shall determine the transfer length by the method specified in the T_LENGTH field (see table 97). ~~If EXTEND bit is set to zero, the transfer length shall be an unsigned integer in the range from 00h to FFh. If EXTEND bit is set to one, the transfer length shall be an unsigned integer in the range from 0000h to FFFFh.~~

Table 97 — EXTEND bit and T_LENGTH field

EXTEND	T_LENGTH	Description
0b	00b	No data is transferred.
	01b	The transfer length is specified in the FEATURES (7:0) field.
	10b	The transfer length is specified in the SECTOR_COUNT (7:0) field.
	11b	The transfer length is specified in the STPSIU field.
1b	00b	No data is transferred.
	01b	The transfer length is specified in the FEATURES (7:0) field and the FEATURES (15:8) field.
	10b	The transfer length is specified in the SECTOR_COUNT (7:0) field and the SECTOR_COUNT (15:8) field.
	11b	The transfer length is specified in the STPSIU field.

12.2.4 ATA PASS-THROUGH status return

Table 98 shows the possible results of ATA PASS-THROUGH (12) command or ATA PASS-THROUGH (16) command processing as reflected in the ATA_ERR bit and DF bit in the ATA STATUS register or in the STATUS-HI field and the STATUS-LO field of the SATA Set Device Bits – Device to Host FIS.

Table 98 — ATA command results

ATA_ERR	DF	Sense data returned
zero	zero	No error, successful completion or command in progress. If the CK_COND bit is set to zero in the ATA PASS-THROUGH (12) command or the ATA PASS-THROUGH (16) command, then the SATL shall respond to a REQUEST SENSE command and shall return sense data with the sense key set to NO SENSE with the additional sense code set to NO ADDITIONAL SENSE INFORMATION. ¹² If the CK_COND bit is set to one in the ATA PASS-THROUGH (12) command or the ATA PASS-THROUGH (16) command, then the SATL shall terminate the command with CHECK CONDITION status with the sense key set to NO SENSE with the additional sense code set to ATA PASS-THROUGH INFORMATION AVAILABLE (see SPC-4). The sense data shall include the ATA Status Return Descriptor.
zero	one	The command was not accepted or otherwise failed to complete successfully. The SATL shall terminate the command with CHECK CONDITION status with the additional sense code set to ATA PASS-THROUGH INFORMATION AVAILABLE. The sense data shall include the ATA Status Return Descriptor.
one	zero	
one	one	Undefined

If the sense data is provided in response to an ATA PASS-THROUGH (12) command or ATA PASSTHROUGH (16) command in which the CK_COND bit was set to one, then the SATL shall set the additional sense code to ATA PASS- THROUGH INFORMATION AVAILABLE (see SPC-4), and shall include the ATA Status Return Descriptor (see 12.2.5) in the sense data.

NOTE 12 -This capability allows the host to retrieve the ATA register or field information with successful command completion by returning data in the ATA registers or fields.

Sequence number: 6
Author: IBM[GPenokie]
Subject: Underline
Date: 2/16/2006 1:42:28 PM
T 12.2.4 ATA PASS-THROUGH status return

Status
rlsheffi Cancelled 5/7/2006 11:45:39 PM

Sequence number: 7
Author: DELL[KMarks]
Subject: Highlight
Date: 6/24/2006 1:00:20 AM

T 12.2.4

More conflicting text and table 98 vs whats above table 94?

RESOLUTION: see 06-291

Status
rlsheffi Completed 7/24/2006 9:53:00 AM

Sequence number: 8
Author: HPQ[RElliott]
Date: 6/24/2006 1:01:58 AM

T 12.2.4

Change "the ATA ERR bit and DF bit in the ATA STATUS register or in the STATUS-HI field and the STATUS-LO field of the SATA Set Device Bits – Device to Host FIS." to use ATA8-AAM and ATA8-ACS terminology. Don't refer to FISes or registers.

Suggestion: "ERR bit or the DF bit in the Status field (see ATA8-ACS)".

RESOLUTION: see 06-291

Status
rlsheffi Completed 7/24/2006 9:52:08 AM

Sequence number: 9
Author: MXO[MEvans]
Subject: Highlight
Date: 6/24/2006 1:02:31 AM

T Table 98, header: capitalize "sense".
RESOLUTION: see 06-291

Status
rlsheffi Completed 7/24/2006 9:53:12 AM

Sequence number: 10
Author: HPQ[RElliott]
Date: 6/24/2006 1:05:33 AM

T 12.2.4
table 98

Delete "ATA"
Add a straddled cell above ERR and DF called "Status field"
RESOLUTION: see 06-291

Status
rlsheffi Completed 7/24/2006 9:53:38 AM

Sequence number: 11
Author: IBM[GPenokie]
Subject: Highlight
Date: 6/24/2006 1:06:44 AM

T table 98
All the terms << zero >>s should be << 0 >> and << one >>s should be << 1 >>.
RESOLUTION: see 06-291

Status
rlsheffi Completed 7/24/2006 9:53:54 AM

Sequence number: 12

Comments from page 113 continued on next page

The SATL shall determine the transfer length by the method specified in the T_LENGTH field (see table 97). ~~If EXTEND bit is set to zero, the transfer length shall be an unsigned integer in the range from 00h to FFh. If EXTEND bit is set to one, the transfer length shall be an unsigned integer in the range from 0000h to FFFFh.~~

Table 97 — EXTEND bit and T_LENGTH field

EXTEND	T_LENGTH	Description
0b	00b	No data is transferred.
	01b	The transfer length is specified in the FEATURES (7:0) field.
	10b	The transfer length is specified in the SECTOR_COUNT (7:0) field.
	11b	The transfer length is specified in the STPSIU field.
1b	00b	No data is transferred.
	01b	The transfer length is specified in the FEATURES (7:0) field and the FEATURES (15:8) field.
	10b	The transfer length is specified in the SECTOR_COUNT (7:0) field and the SECTOR_COUNT (15:8) field.
	11b	The transfer length is specified in the STPSIU field.

12.2.4 ATA PASS-THROUGH status return

Table 98 shows the possible results of ATA PASS-THROUGH (12) command or ATA PASS-THROUGH (16) command processing as reflected in the ATA_ERR bit and DF bit in the ATA STATUS register or in the STATUS-HI field and the STATUS-LO field of the SATA Set Device Bits – Device to Host FIS.

Table 98 — ATA command results

ATA_ERR	DF	sense data returned
zero	zero	No error, successful completion or command in progress. If the CK_COND bit is set to zero in the ATA PASS-THROUGH (12) command or the ATA PASS-THROUGH (16) command, then the SATL shall respond to a REQUEST SENSE command and shall return sense data with the sense key set to NO SENSE with the additional sense code set to NO ADDITIONAL SENSE INFORMATION. If the CK_COND bit is set to one in the ATA PASS-THROUGH (12) command or the ATA PASS-THROUGH (16) command, then the SATL shall terminate the command with CHECK CONDITION status with the sense key set to NO SENSE with the additional sense code set to ATA PASS-THROUGH INFORMATION AVAILABLE (see SPC-4). The sense data shall include the ATA Status Return Descriptor.
zero	one	The command was not accepted or otherwise failed to complete successfully. The SATL shall terminate the command with CHECK CONDITION status with the additional sense code set to ATA PASS-THROUGH INFORMATION AVAILABLE. The sense data shall include the ATA Status Return Descriptor.
one	zero	
one	one	Undefined

If the sense data is provided in response to an ATA PASS-THROUGH (12) command or ¹⁵A¹⁴SSSTHROUGH (16) command in which the CK_COND bit was set to one, then the SATL shall set the additional sense code to ¹⁶A PASS-THROUGH INFORMATION AVAILABLE (see SPC-4), and shall include the ATA Status Return Descriptor (see 12.2.5) in the sense data.

NOTE 12 -This capability allows the host to retrieve the ATA register or field information with successful command completion by returning data in the ATA registers or fields.

Author: EDITOR[rlsheffi]
Subject: Highlight
Date: 6/24/2006 1:08:00 AM

Table 98 - row zero, zero

This contradicts the description of the CK_COND bit in subclause 12.2.3. Needs to be consistent.
RESOLUTION: see 06-291

Status
rlsheffi Completed 7/24/2006 9:54:46 AM

Sequence number: 13
Author: MXO[MEvans]
Subject: Highlight
Date: 6/24/2006 1:11:44 AM

Table 98, row 2, sense data: change "...otherwise failed to complete successfully." to "...completed with an error."
RESOLUTION: see 06-291

Status
rlsheffi Completed 7/24/2006 9:55:14 AM

Sequence number: 14
Author: HPQ[RElliott]
Date: 7/24/2006 9:56:37 AM

T 12.2.4

Global: Use either PASSTHROUGH or PASS-THROUGH consistently.
Suggested resolution: Change all instances of "PASSTHROUGH" to "PASS-THROUGH"
RESOLUTION: see 06-291 (Paragraph removed)

Status
rlsheffi Completed 7/24/2006 9:56:48 AM

Sequence number: 15
Author: MXO[MEvans]
Subject: Highlight
Date: 7/24/2006 9:57:00 AM

T 12.2.4 ATA PASS-THROUGH status return, second paragraph: change "ATA PASSTHROUGH" to "ATA PASS-THROUGH".
RESOLUTION: see 06-291 (paragraph removed)

Status
rlsheffi Completed 7/24/2006 9:57:03 AM

Sequence number: 16
Author: MXO[MEvans]
Subject: Highlight
Date: 7/24/2006 9:57:13 AM

T 12.2.4 ATA PASS-THROUGH status return, second paragraph: change "ATA PASS- THROUGH INFORMATION AVAILABLE" to "ATA PASS-THROUGH INFORMATION AVAILABLE".

RESOLUTION: see 06-291 (paragraph removed)

Status
rlsheffi Completed 7/24/2006 9:57:16 AM



Some ATA commands return information in the registers. ATA Register information may be retrieved by requesting the ATA Status Return Descriptor issuing the ATA PASS-THROUGH (12) command or ATA PASS-THROUGH (16) command with the PROTOCOL field set to 15 (i.e., Return Response Information).

12.2.5 ATA Status Return Descriptor

Table 99 shows the format of the ATA Status Return Descriptor returned in the sense data (see SPC-3 and SAM-3). The SATL shall return the ATA Status Return Descriptor if the PROTOCOL field in the ATA PASS-THROUGH (12) command or ATA PASS-THROUGH (16) command is set to 15 (i.e., Return Response Information).

The SATL shall support the ATA Status Return Descriptor if the SATL supports the ATA PASSTHROUGH (12) command or the ATA PASS-THROUGH (16) command. Each time the ATA Status Return Descriptor is requested; the SATL shall read the ATA registers and return those values in the sense data as shown in table 99. If the sense data is for an ATA PASS-THROUGH (12) command or for the ATA PASS-THROUGH (16) command with the EXTEND bit set to zero the SATL shall return the 28-bit extended status and shall set the EXTEND bit to zero. If the sense data is for an ATA PASS-THROUGH (16) command with the EXTEND bit set to one the SATL shall return the 48-bit extended status and shall set the EXTEND bit to one.

Table 99 — ~~Extended~~ ATA Status Return Descriptor

Byte\Bit	7	6	5	4	3	2	1	0
0	DESCRIPTOR CODE (09h)							
1	ADDITIONAL DESCRIPTOR LENGTH (0Ch)							
2	Reserved							EXTEND
3	ERROR							
4	SECTOR_COUNT (15:8)							
5	SECTOR_COUNT (7:0)							
6	LBA_LOW (15:8)							
7	LBA_LOW (7:0)							
8	LBA_MID (15:8)							
9	LBA_MID (7:0)							
10	LBA_HIGH (15:8)							
11	LBA_HIGH (7:0)							
12	DEVICE							
13	STATUS							

the EXTEND bit is set to one the SECTOR_COUNT (7:0) field and SECTOR_COUNT (15:8) field specify the ATA Sector Count. If the EXTEND bit is set to zero the SECTOR_COUNT (7:0) field specifies the ATA Sector Count and SECTOR_COUNT (15:8) field shall be ignored.

If the EXTEND bit is set to one the LBA_LOW (7:0) field, LBA_MID (7:0) field, LBA_HIGH (7:0) field, LBA_LOW (15:8) field, LBA_MID (15:8) field, and LBA_HIGH (15:8) field specify the ATA LBA. If the EXTEND bit is set to zero the LBA_LOW (7:0) field, LBA_MID (7:0) field, and LBA_HIGH (7:0) field specify the ATA LBA, and the LBA_LOW (15:8) field, LBA_MID (15:8) field, and LBA_HIGH (15:8) field shall be ignored.

12.3 SAT-specific mode pages

12.3.1 SAT-specific mode pages overview

This subclause describes mode pages that the SATL may implement that are unique to the SCSI – ATA translation environment. These mode pages are for use by the SATL and are shown in table 100 and

Page: 114

Sequence number: 1
Author: ELX[KHirata]
Subject: Note
Date: 7/24/2006 9:59:02 AM

 Discussion Notes: Can we define it so that if, for any given emulated SCSI device, the next command following an ATA PASSTROUGH command specifying a protocol other than protocol 15, and the next command is not an ATA PASSTROUGH command specifying a protocol of 15 to return the ATA status return descriptor, then the SATL can discard the ATA register content. If the SATL doesn't have the resources to hold the ATA register content when it receives an ATA PASSRHOUGH command, it may terminate the command with CHECK CONDITION and an appropriate additional sense code (to say insufficient resources were available) or return BUSY/TASK SET FULL. If the SATL receives an ATA PASSTROUGH command and the SATL has no ATA register information to return in the ATA status return descriptor, it returns CHECK CONDITION status with an additional sense code to indicate the status was discarded (new ASC/ASCQ?).

Location: Page 94, 12.2.4,

Comment:

Support for PROTOCOL 15 seems to imply that the register FIS from a previous command needs to be stored by the SATL. This represents a potentially large storage burden for an HBA based translation that may be communicating with large numbers of target devices simultaneously. If autosense is supported is PROTOCOL 15 also required to be supported? Can pass-through be supported without support for PROTOCOL 15?

Preferred resolution:

Clarification. If I've misinterpreted the intent of PROTOCOL 15 then there is no problem. If my interpretation of PROTOCOL 15 is correct then it may be difficult for us to support because of the limited memory resources available in the HBA.

Comment on comment (rls): The contention of SAT WG members is that correctly managing SATA protocol requires the SATA host to maintain the current state of the Command Shadow Block registers for each device anyway.

RESOLUTION: see 06-291

"ATA Register information may be retrieved..."

s/b

"ATA commands may return information in the ATA registers or the Shadow Command Block. The current ATA register information may be retrieved..."

Status
rlsheffi Completed 7/24/2006 9:59:05 AM

Sequence number: 2
Author: DELL[KMarks]
Subject: Note
Date: 7/12/2006 11:57:27 PM

 12.2.5 - This implies support the descriptor format period.

RESOLUTION: see 02-291, and modify the definition of the D_SENSE bit so that it only applies to commands other than PASS-THROUGH, and PASS-THROUGH always returns descriptor format (per SAT WG 7/11/06). See EDITOR comment on D_SENSE bit in 10.1.4

Status
rlsheffi Completed 7/24/2006 12:11:22 PM

Sequence number: 3
Author: ELX[Allen Martin]
Subject: Cross-Out
Date: 7/24/2006 10:00:20 AM

 Table 99 - Extended ATA Status Return Descriptor
All the references just say ATA Status Return Descriptor
Delete "Extended"
RESOLUTION: see 06-291(Fixed in SAT-r08c)

Status
rlsheffi Completed 7/24/2006 10:00:22 AM

Sequence number: 4
Author: MXO[MEvans]

Comments from page 114 continued on next page

Some ATA commands return information in the registers. ATA Register information may be retrieved by requesting the ATA Status Return Descriptor issuing the ATA PASS-THROUGH (12) command or ATA PASS-THROUGH (16) command with the PROTOCOL field set to 15 (i.e., Return Response Information).

12.2.5 ATA Status Return Descriptor

Table 99 shows the format of the ATA Status Return Descriptor returned in the sense data (see SPC-3 and SAM-3). The SATL shall return the ATA Status Return Descriptor if the PROTOCOL field in the ATA PASS-THROUGH (12) command or ATA PASS-THROUGH (16) command is set to 15 (i.e., Return Response Information).

The SATL shall support the ATA Status Return Descriptor if the SATL supports the ATA PASSTHROUGH (12) command or the ATA PASS-THROUGH (16) command. Each time the ATA Status Return Descriptor is requested; the SATL shall read the ATA registers and return those values in the sense data as shown in table 99. If the sense data is for an ATA PASS-THROUGH (12) command or for the ATA PASS-THROUGH (16) command with the EXTEND bit set to zero the SATL shall return the 28-bit extended status and shall set the EXTEND bit to zero. If the sense data is for an ATA PASS-THROUGH (16) command with the EXTEND bit set to one the SATL shall return the 48-bit extended status and shall set the EXTEND bit to one.

Table 99 — Extended ATA Status Return Descriptor

Byte\Bit	7	6	5	4	3	2	1	0
0	DESCRIPTOR CODE (09h)							
1	ADDITIONAL DESCRIPTOR LENGTH (0Ch)							
2	Reserved							EXTEND
3	ERROR							
4	SECTOR_COUNT (15:8)							
5	SECTOR_COUNT (7:0)							
6	LBA_LOW (15:8)							
7	LBA_LOW (7:0)							
8	LBA_MID (15:8)							
9	LBA_MID (7:0)							
10	LBA_HIGH (15:8)							
11	LBA_HIGH (7:0)							
12	DEVICE							
13	STATUS							

If the EXTEND bit is set to one the SECTOR_COUNT (7:0) field and SECTOR_COUNT (15:8) field specify the ATA Sector Count. If the EXTEND bit is set to zero the SECTOR_COUNT (7:0) field specifies the ATA Sector Count and SECTOR_COUNT (15:8) field shall be ignored.

If the EXTEND bit is set to one the LBA_LOW (7:0) field, LBA_MID (7:0) field, LBA_HIGH (7:0) field, LBA_LOW (15:8) field, LBA_MID (15:8) field, and LBA_HIGH (15:8) field specify the ATA LBA. If the EXTEND bit is set to zero the LBA_LOW (7:0) field, LBA_MID (7:0) field, and LBA_HIGH (7:0) field specify the ATA LBA, and the LBA_LOW (15:8) field, LBA_MID (15:8) field, and LBA_HIGH (15:8) field shall be ignored.

12.3 SAT-specific mode pages

12.3.1 SAT-specific mode pages overview

This subclause describes mode pages that the SATL may implement that are unique to the SCSI – ATA translation environment. These mode pages are for use by the SATL and are shown in table 100 and

Subject: Highlight

Date: 6/24/2006 1:22:50 AM

T 12.2.5 ATA Status Return Descriptor, third paragraph: change to, "If the EXTEND bit is set to one, then the SECTOR_COUNT (7:0) field and SECTOR_COUNT (15:8) field specify the ATA Sector Count. If the EXTEND bit is set to zero, then the SECTOR_COUNT (7:0) field specifies the ATA Sector Count, and the SECTOR_COUNT (15:8) field shall be ignored."

RESOLUTION: see 06-291

Status

rlsheffi Completed 7/24/2006 10:01:36 AM

Sequence number: 5

Author: MXO[MEvans]

Subject: Highlight

Date: 6/24/2006 1:24:12 AM

T 12.2.5 ATA Status Return Descriptor, fourth paragraph: change to, "If the EXTEND bit is set to one, then the LBA_LOW (7:0) field, LBA_MID (7:0) field, LBA_HIGH (7:0) field, LBA_LOW (15:8) field, LBA_MID (15:8) field, and LBA_HIGH (15:8) field specify the ATA LBA. If the EXTEND bit is set to zero, then the LBA_LOW (7:0) field, LBA_MID (7:0) field, and LBA_HIGH (7:0) field specify the ATA LBA, and the LBA_LOW (15:8) field, LBA_MID (15:8) field, and LBA_HIGH (15:8) field shall be ignored."

RESOLUTION: see 06-291

Status

rlsheffi Completed 7/24/2006 10:02:06 AM

Sequence number: 6

Author: DELL[KMarks]

Subject: Highlight

Date: 6/24/2006 1:30:51 AM

T **12.3.1 SAT-specific mode pages overview**

1st Paragraph

"This subclause describes mode pages that the SATL may implement that are unique to the SCSI – ATA translation environment. These mode pages are for use by the SATL and are shown in table 100 and ..."

to

"This subclause describes mode pages that the SATL may implement that are unique to this SCSI/ATA Translation standard These mode pages are for use by the SATL and are shown in table 100. ..."

RESOLUTION: see 06-291

Status

rlsheffi Completed 7/24/2006 10:04:21 AM

1 described in this subclause. Support for these mode pages is optional. A SATL should support the appropriate mode page for the attached ATA environment (e.g., PATA).

2 **Table 100 — SCSI - ATA Translation specific mode pages**

PAGE CODE	SUB PAGE CODE	Page name
0Ah	F1h	PATA Control Mode Page
0Ah	F2h	Reserved for SAT

4 **2.3.2 PATA Control Mode Page** 5 **Mode Page** 3 **Page 0Ah, Sub Page F1h**

The PATA Control mode page provides PATA specific controls for a SATL to configure the underlying PATA host and to understand what parameters are communicated to the PATA device to ensure proper communication for specific transfer rates. This standard specifies the mode parameters that are provided for this mode page.

SATL implementations that support the attachment of PATA devices shall support this mode page when requested through MODE SENSE command. SATL implementations should allow application clients to configure alternate PATA timings using the MODE SELECT command.

Table 101 — PATA Control mode page

Byte/bit	7	6	5	4	3	2	1	0
0	PS	SPF (1b)	PAGE CODE (0Ah)					
1	SUBPAGE CODE (F1h)							
2	(MSB)	PAGE LENGTH (4h)						(LSB)
3								
4	Reserved	MWDMA ^a field			Reserved		PIO ^b field	
		MWD2	MWD1	MWD0		PIO4	PIO3	
5	Reserved	UDMA ^c field						
		UDMA6	UDMA5	UDMA4	UDMA3	UDMA2	UDMA1	UDMA0
6	Reserved							
7	Reserved							

^a MWDMA stands for Multi-Word Direct Memory Access and the MWDx bits specify a number of hardware-assisted data transfer modes defined in ATA/ATAPI-7.

^b PIO stands for Programmed Input and Output and the PIOx bits specify transfer modes performed under program control defined in ATA/ATAPI-7.

^c UDMA stands for Ultra Direct Memory Access and the UDMAX bits represent a number of hardware-assisted data transfer modes defined in ATA/ATAPI-7.

The parameters saveable (PS) bit is defined in SPC-3.

The SPF bit (see SPC-3) shall be set to one to access this mode page.

The PAGE CODE field shall be set to 0Ah.

The SUBPAGE CODE field shall be set to F1h.

SATL implementations may save the state of the timing parameters defined in this mode page. However, SATL implementations should not use any saved parameters to configure the ATA host timing modes to an illegal configuration for the attached PATA device.

Application clients may use the MODE SENSE command for changeable values to determine the underlying ATA host support for a given timing mode. The SATL shall support changeable mode parameters for this mode page.

Page: 115

Sequence number: 1
Author: DELL[KMarks]
Subject: Highlight
Date: 7/24/2006 10:05:43 AM

T 12.3.1 SAT-specific mode pages overview

1st Paragraph - continued from previous page
change

"... described in this subclause. Support for these mode pages is optional. A SATL should support the appropriate mode page for the attached ATA environment (e.g., PATA)."

to

"... A SATL should support the appropriate mode page for the ATA environment (e.g., PATA)."

or you could delete this sentence also, by changing the may to should in the first sentence of the paragraph.

RESOLUTION: see 06-291 - Make suggested change, keeping the second sentence as modified. The SAT WG agreed to use "shall" rather than "should".

Status
risheffi Completed 7/24/2006 10:05:47 AM

Sequence number: 2
Author: DELL[KMarks]
Subject: Highlight
Date: 7/24/2006 10:07:09 AM

T Table 100 — SCSI - ATA Translation specific mode pages

change table title to
"Table 100 — SCSI/ATA Translation specific mode pages"

Additionally change 3rd column to "Mode page name"

Lastly I question having the "Reserved for SAT" in the table or at least just make it Reserved.

Notes / suggested resolution: As suggested, and change the page name for the "F2h" sub page code to "Unspecified (see 3.2.3)". The definition of Unspecified conveys the intent that the field may be used in a future version of SAT, though it also suggests it may be found in SBC-2 or SPC-3, which it won't. Perhaps it should be both Reserved and Unspecified.

RESOLUTION: see 06-291 change "Reserved for SAT" to "Reserved" (Changed "Reserved for SAT" to "Reserved" in SAT-r08c)

Status
risheffi Completed 7/24/2006 10:07:24 AM

Sequence number: 3
Author: HPQ[RElliott]
Subject: Cross-Out
Date: 6/24/2006 1:37:25 AM

T 12.3.2

Delete "(Page 0Ah, Sub Page F1h)"

RESOLUTION: see 06-291

Status
risheffi Completed 7/24/2006 10:07:42 AM

Sequence number: 4
Author: IBM[GPenokie]
Subject: Underline
Date: 2/16/2006 1:41:32 PM

T 12.3.2 PATA Control Mode Page (Page 0Ah, Sub Page F1h)

Status
risheffi Cancelled 5/8/2006 12:32:33 AM

Sequence number: 5
Author: HPQ[RElliott]
Subject: Highlight

Comments from page 115 continued on next page

described in this subclause. Support for these mode pages is optional. A SATL should support the appropriate mode page for the attached ATA environment (e.g., PATA).

Table 100 — SCSI - ATA Translation specific mode pages

PAGE CODE	SUB PAGE CODE	Page name
0Ah	F1h	PATA Control Mode Page
0Ah	F2h	Reserved for SAT

12.3.2 PATA Control Mode Page (Page 0Ah, Sub Page F1h)

The PATA Control mode page provides PATA specific controls for a SATL to configure the underlying PATA host and to understand what parameters are communicated to the PATA device to ensure proper communication for specific transfer rates. This standard specifies the mode parameters that are provided for this mode page.

SATL implementations that support the attachment of PATA devices shall support this mode page when requested through MODE SENSE command. SATL implementations should allow application clients to configure alternate PATA timings using the MODE SELECT command.

Table 101 — PATA Control mode page

Byte/Bit	7	6	5	4	3	2	1	0
0	PS	SPF (1b)	PAGE CODE (0Ah)					
1	SUBPAGE CODE (F1h)							
2	(MSB)	PAGE LENGTH (9h)						(LSB)
3								
4	Reserved	MWDMA ^a field			Reserved		PIO ^b field	
		MWD2	MWD1	MWD0			PIO4	PIO3
5	Reserved	UDMA ^c field						
		UDMA6	UDMA5	UDMA4	UDMA3	UDMA2	UDMA1	UDMA0
6	Reserved							
7	Reserved							

^a MWDMA stands for Multi-Word Direct Memory Access and the MWDx bits specify a number of hardware-assisted data transfer modes defined in ATA/ATAPI-7.

^b PIO stands for Programmed Input and Output and the PIOx bits specify transfer modes performed under program control defined in ATA/ATAPI-7.

^c UDMA stands for Ultra Direct Memory Access and the UDMAX bits represent a number of hardware-assisted data transfer modes defined in ATA/ATAPI-7.

The parameters saveable (PS) bit is defined in SPC-3.

The SPF bit (see SPC-3) shall be set to one to access this mode page.

The PAGE CODE field shall be set to 0Ah.

The SUBPAGE CODE field shall be set to F1h.

SATL implementations may save the state of the timing parameters defined in this mode page. However, SATL implementations should not use any saved parameters to configure the ATA host timing modes to an illegal configuration for the attached PATA device.

Application clients may use the MODE SENSE command for changeable values to determine the underlying ATA host support for a given timing mode. The SATL shall support changeable mode parameters for this mode page.

Date: 6/24/2006 1:37:59 AM

T 12.3.2

Mode Page s/b lowercase
RESOLUTION: see 06-291

Status
rlsheffi Completed 7/24/2006 10:07:51 AM

Sequence number: 6
Author: HPQ[RElliott]
Date: 7/13/2006 12:04:22 AM
T 12.3.2

need a reference to table 101

Suggested resolution: add a sentence just prior to table 101:
"Table 101 shows the PATA Control mode page."
RESOLUTION: see 06-291

Status
rlsheffi Completed 7/24/2006 10:08:07 AM

Sequence number: 7
Author: DELL[KMarks]
Subject: Note
Date: 7/13/2006 12:07:28 AM
T In 12.3.2 PATA Control Mode Page (Page 0Ah, Sub Page F1h)

Section 12.3.1 says mode pages in this section are a may, and then should if PATA attached, and now this section says Shall if attached to PATA?

RESOLUTION: see 06-291
change

"SATL implementations that support the attachment of PATA devices shall support this mode page when requested through MODE SENSE command. SATL implementations should allow application clients to configure alternate PATA timings using the MODE SELECT command."

to

"SATL implementations that support the attachment of PATA devices may support this mode page, and if this mode page is supported, the SATL should allow application clients to configure alternate PATA timings using the MODE SELECT command."

REASON: The SAT WG (7/11/06) agreed to say the SATL "shall" support the PATA control mode page for PATA devices.

Status
rlsheffi Rejected 7/13/2006 12:07:32 AM

Sequence number: 8
Author: IBM[GPenokie]
Subject: Highlight
Date: 7/13/2006 12:08:16 AM

T There is no reference to table 101. This needs to be fixed as all tables have to be referenced.

Suggested resolution: add a sentence just prior to table 101:
"Table 101 shows the PATA Control mode page."
RESOLUTION: see 06-291

Status
rlsheffi Completed 7/24/2006 10:08:31 AM

Sequence number: 9
Author: DELL[KMarks]
Subject: Highlight
Date: 6/24/2006 1:45:43 AM
T Table 101 — PATA Control mode page

Byte 2 & 3
change

"PAGE LENGTH (4h)"

to

"PAGE LENGTH (0004h)"

RESOLUTION: see 06-291

Comments from page 115 continued on next page

described in this subclause. Support for these mode pages is optional. A SATL should support the appropriate mode page for the attached ATA environment (e.g., PATA).

Table 100 — SCSI - ATA Translation specific mode pages

PAGE CODE	SUB PAGE CODE	Page name
0Ah	F1h	PATA Control Mode Page
0Ah	F2h	Reserved for SAT

12.3.2 PATA Control Mode Page (Page 0Ah, Sub Page F1h)

The PATA Control mode page provides PATA specific controls for a SATL to configure the underlying PATA host and to understand what parameters are communicated to the PATA device to ensure proper communication for specific transfer rates. This standard specifies the mode parameters that are provided for this mode page.

SATL implementations that support the attachment of PATA devices shall support this mode page when requested through MODE SENSE command. SATL implementations should allow application clients to configure alternate PATA timings using the MODE SELECT command.

Table 101 — PATA Control mode page

Byte/Bit	7	6	5	4	3	2	1	0
0	PS	SPF (1b)	PAGE CODE (0Ah)					
1	SUBPAGE CODE (F1h)							
2	(MSB)							
3	PAGE LENGTH (4h) (LSB)							
4	Reserved	MWDMA ¹¹ field			Reserved		PIO ¹⁰ field	
		MWD2	MWD1	MWD0			PIO4	PIO3
5	Reserved	UDMA ¹² field						
		UDMA6	UDMA5	UDMA4	UDMA3	UDMA2	UDMA1	UDMA0
6	Reserved							
7	Reserved							
<p>a ¹³UDMA stands for Multi-Word Direct Memory Access and the MWDx bits specify a number of hardware-assisted data transfer modes defined in ¹⁴ATA/ATAPI-7.</p> <p>b PIO stands for Programmed Input and Output and the PIOx bits specify transfer modes performed under program control defined in ATA/ATAPI-7.</p> <p>c UDMA stands for Ultra Direct Memory Access and the UDMAx bits represent a number of hardware-assisted data transfer modes defined in ATA/ATAPI-7.</p>								

The parameters saveable (PS) bit is defined in SPC-3.

The SPF bit (see SPC-3) shall be set to one to access this mode page.

The PAGE CODE field shall be set to 0Ah.

The SUBPAGE CODE field shall be set to F1h.

SATL implementations may save the state of the timing parameters defined in this mode page. However, SATL implementations should not use any saved parameters to configure the ATA host timing modes to an illegal configuration for the attached PATA device.

Application clients may use the MODE SENSE command for changeable values to determine the underlying ATA host support for a given timing mode. The SATL shall support changeable mode parameters for this mode page.

Status
risheffi Completed 7/24/2006 10:08:52 AM

Sequence number: 10
Author: DELL[KMarks]
Subject: Highlight
Date: 6/24/2006 1:48:58 AM

Table 101 — PATA Control mode page
byte 4
change

"PIO b field"
to
"PIO b bits", with PIO not in small CAPS.

RESOLUTION: see 06-291

Status
risheffi Completed 7/24/2006 10:09:17 AM

Sequence number: 11
Author: DELL[KMarks]
Subject: Highlight
Date: 6/24/2006 1:49:09 AM

Table 101 — PATA Control mode page
byte 4
change

"MWDMA a field"
to
"MWDMA a bits", with MWDMA not in small CAPS.

RESOLUTION: see 06-291

Status
risheffi Completed 7/24/2006 10:09:33 AM

Sequence number: 12
Author: DELL[KMarks]
Subject: Highlight
Date: 6/24/2006 1:49:17 AM

Table 101 — PATA Control mode page
byte 4
change

"UDMA c field"
to
"UDMA c bits", with UDMA not in small CAPS.

RESOLUTION: see 06-291

Status
risheffi Completed 7/24/2006 10:09:41 AM

Sequence number: 13
Author: IBM[GPenokie]
Subject: Comment on Text
Date: 6/24/2006 1:51:32 AM

Table 101 footnote a
This << MWDMA stands for Multi-Word Direct Memory Access and the >> should be << The Multi-Word Direct Memory Access (MWDMA) and the >>

RESOLUTION: change

"MWDMA stands for Multi-Word Direct Memory Access and the MWDx bits specify..."

to
"The Multi-Word Direct Memory Access (MWDMA) bits specify..."

RESOLUTION: see 06-291

Status
risheffi Completed 7/24/2006 10:10:03 AM

Sequence number: 14

Comments from page 115 continued on next page

described in this subclause. Support for these mode pages is optional. A SATL should support the appropriate mode page for the attached ATA environment (e.g., PATA).

Table 100 — SCSI - ATA Translation specific mode pages

PAGE CODE	SUB PAGE CODE	Page name
0Ah	F1h	PATA Control Mode Page
0Ah	F2h	Reserved for SAT

12.3.2 PATA Control Mode Page (Page 0Ah, Sub Page F1h)

The PATA Control mode page provides PATA specific controls for a SATL to configure the underlying PATA host and to understand what parameters are communicated to the PATA device to ensure proper communication for specific transfer rates. This standard specifies the mode parameters that are provided for this mode page.

SATL implementations that support the attachment of PATA devices shall support this mode page when requested through MODE SENSE command. SATL implementations should allow application clients to configure alternate PATA timings using the MODE SELECT command.

Table 101 — PATA Control mode page

Byte\Bit	7	6	5	4	3	2	1	0
0	PS	SPF (1b)	PAGE CODE (0Ah)					
1	SUBPAGE CODE (F1h)							
2	(MSB)	PAGE LENGTH (4h)						(LSB)
3								
4	Reserved	MWDMA ^a field			Reserved		PIO ^b field	
		MWD2	MWD1	MWD0			PIO4	PIO3
5	Reserved	UDMA ^c field						
		UDMA6	UDMA5	UDMA4	UDMA3	UDMA2	UDMA1	UDMA0
6	Reserved							
7	Reserved							

^a MWDMA stands for Multi-Word Direct Memory Access and the MWDx bits specify a number of hardware-assisted data transfer modes defined in ATA/ATAPI-7.

^b PIO stands for Programmed Input and Output and the PIOx bits specify transfer modes performed under program control defined in ATA/ATAPI-7.

^c UDMA stands for Ultra Direct Memory Access and the UDMAX bits represent a number of hardware-assisted data transfer modes defined in ATA/ATAPI-7.

The parameters saveable (PS) bit is defined in SPC-3.

The SPF bit (see SPC-3) shall be set to one to access this mode page.

The PAGE CODE field shall be set to 0Ah.

The SUBPAGE CODE field shall be set to F1h.

SATL implementations may save the state of the timing parameters defined in this mode page. However, SATL implementations should not use any saved parameters to configure the ATA host timing modes to an illegal configuration for the attached PATA device.

Application clients may use the MODE SENSE command for changeable values to determine the underlying ATA host support for a given ATA timing mode. The SATL shall support changeable mode parameters for this mode page.

Author: EDITOR[rlsheffi]
Subject: Highlight
Date: 6/24/2006 1:51:49 AM

T 12.3.2 PATA Control Mode Page
Table 101 — PATA Control mode page
Table footnote a)
change
"ATA/ATAPI-7"
to
"ATA8-APT"

RESOLUTION: see 06-291

Status
rlsheffi Completed 7/24/2006 10:10:11 AM

Sequence number: 15
Author: EDITOR[rlsheffi]
Subject: Highlight
Date: 6/24/2006 1:52:04 AM

T 12.3.2 PATA Control Mode Page
Table 101 — PATA Control mode page
Table footnote b)
change
"ATA/ATAPI-7"
to
"ATA8-APT"

RESOLUTION: see 06-291

Status
rlsheffi Completed 7/24/2006 10:10:22 AM

Sequence number: 16
Author: IBM[GPenokie]
Subject: Comment on Text
Date: 6/24/2006 1:53:14 AM

T table 101 footnote c
This << UDMA stands for Ultra Direct Memory Access and the >> should be << The Ultra Direct Memory Access (UDMA) and the >>.
RESOLUTION: change
"UDMA stands for Ultra Direct Memory Access and the UDMA bits represent..."
to
"The Ultra Direct Memory Access (UDMA) bits represent..."

RESOLUTION: see 06-291

Status
rlsheffi Completed 7/24/2006 10:10:36 AM

Sequence number: 17
Author: EDITOR[rlsheffi]
Subject: Highlight
Date: 6/24/2006 1:53:22 AM

T 12.3.2 PATA Control Mode Page
Table 101 — PATA Control mode page
Table footnote c)
change
"ATA/ATAPI-7"
to
"ATA8-APT"

RESOLUTION: see 06-291

Status
rlsheffi Completed 7/24/2006 10:10:44 AM

Sequence number: 18
Author: HPQ[RElliott]
Date: 6/24/2006 1:56:34 AM

Comments from page 115 continued on next page

described in this subclause. Support for these mode pages is optional. A SATL should support the appropriate mode page for the attached ATA environment (e.g., PATA).

Table 100 — SCSI - ATA Translation specific mode pages

PAGE CODE	SUB PAGE CODE	Page name
0Ah	F1h	PATA Control Mode Page
0Ah	F2h	Reserved for SAT

12.3.2 PATA Control Mode Page (Page 0Ah, Sub Page F1h)

The PATA Control mode page provides PATA specific controls for a SATL to configure the underlying PATA host and to understand what parameters are communicated to the PATA device to ensure proper communication for specific transfer rates. This standard specifies the mode parameters that are provided for this mode page.

SATL implementations that support the attachment of PATA devices shall support this mode page when requested through MODE SENSE command. SATL implementations should allow application clients to configure alternate PATA timings using the MODE SELECT command.

Table 101 — PATA Control mode page

Byte/Bit	7	6	5	4	3	2	1	0
0	PS	SPF (1b)	PAGE CODE (0Ah)					
1	SUBPAGE CODE (F1h)							
2	(MSB)	PAGE LENGTH (4h)						(LSB)
3								
4	Reserved	MWDMA ^a field			Reserved		PIO ^b field	
		MWD2	MWD1	MWD0			PIO4	PIO3
5	Reserved	UDMA ^c field						
		UDMA6	UDMA5	UDMA4	UDMA3	UDMA2	UDMA1	UDMA0
6	Reserved							
7	Reserved							

^a MWDMA stands for Multi-Word Direct Memory Access and the MWDx bits specify a number of hardware-assisted data transfer modes defined in ATA/ATAPI-7.

^b PIO stands for Programmed Input and Output and the PIOx bits specify transfer modes performed under program control defined in ATA/ATAPI-7.

^c UDMA stands for Ultra Direct Memory Access and the UDMAx bits represent a number of hardware-assisted data transfer modes defined in ATA/ATAPI-7.

The parameters saveable (PS) bit is defined in SPC-3.

The SPF bit (see SPC-3) shall be set to one to access this mode page.

The PAGE CODE field shall be set to 0Ah.

The SUBPAGE CODE field shall be set to F1h.

SATL implementations may save the state of the timing parameters defined in this mode page. However, SATL implementations shall not use any saved parameters to configure the ATA host timing modes to an illegal configuration for the attached PATA device.

Application clients may use the MODE SENSE command for changeable values to determine the underlying ATA host support for a given ATA timing mode. The SATL shall support changeable mode parameters for this mode page.

 12.3.2

Missing a PAGE LENGTH paragraph
RESOLUTION: see 06-291 - add
"The PAGE LENGTH field shall be set to 0004h"

Status
risheffi Completed 7/24/2006 10:11:09 AM

Sequence number: 19
Author: DELL[KMarks]
Subject: Note
Date: 5/8/2006 12:51:09 AM

 6th Paragraph after Table 101 — PATA Control mode page.

May save contradicts the Mode Sense material, which has a shall not, assuming my comment (changing saving to unspecified) is rejected.
REASON: Saving of mode pages is not prohibited by SAT (after LB comment resolution)

Status
risheffi Rejected 5/8/2006 12:51:18 AM

Sequence number: 20
Author: DELL[KMarks]
Subject: Note
Date: 7/24/2006 12:17:48 PM

 6th Paragraph after Table 101 — PATA Control mode page.

This mode page shall support changeable parameters, does this imply that returning changeable parameters is required (PC=01b) as seems stated after table 102? If so this contradicts the text in the MODE SENSE command, but I think that changeable and saving should be unspecified for the other mode pages and shall for this mode page after the may/ should/shall supported is determined.
DISCUSS FLAG
RESOLUTION: see 06-291 (support for changeable mode pages is "unspecified") in MODE SENSE.

Status
risheffi Completed 7/24/2006 12:17:54 PM

When processing a MODE SENSE command, the SATL shall set the PIO3 bit and PIO4 bit as shown table 102 to identify the configured PIO mode.

Table 102 — PIO modes



PIO3	PIO4	PIO mode
0	0	Reserved
0	1	The ATA host shall use PIO mode 3 transfers.
1	0	The ATA host shall use PIO mode 4 transfers.
1	1	Reserved

When changeable values are requested, the PIO3 bit and the PIO4 bit indicate if the underlying ATA host supports those transfer modes. The PIO3 bit shall be set to one if the ATA host support PIO mode 3. The PIO3 bit and the PIO4 bit shall be set to one if the ATA host supports PIO mode 4.

If the SATL receives a MODE SELECT command³ and the PIO field² indicates a change from the current setting, the SATL shall configure the ATA host to use the new PIO transfer rate, if supported.⁴ The application client shall not request a PIO mode setting that the ATA device is unable to support.⁵ If the application client requests a PIO setting that the ATA device is unable to support the SATL shall return a CHECK CONDITION status with the sense key set to ILLEGAL REQUEST and the additional sense code set to INVALID FIELD IN PARAMETER LIST.

The MWD0 bit, the MWD1 bit, and the MWD2 bit are collectively referred to⁶ as the MWDMA field. If the ATA host in the SATL is currently configured to use multi word DMA (MWDMA) the MWDMA field is used to determine what mode is currently being used, what modes are supported by the ATA host, and control of the MWDMA mode.

If the SATL receives a MODE SENSE command requesting the current values of the PATA Control mode page, the MWD0 bit shall be set to one by the SATL when the host and device are configured to use MWDMA mode 0. The MWD1 bit shall be set to one by the SATL when the host and device are configured to use MWDMA mode 1. The MWD2 bit shall be set to one by the SATL when the host and device are configured to use MWDMA mode 2.

If the SATL receives a MODE SENSE command requesting the changeable values of the PATA Control mode page, the MWD0 bit shall be set to one if the ATA host supports MWDMA mode 0. The MWD1 bit and MWD0 bit shall each be set to one if the ATA host supports MWDMA mode 1. The MWD2 bit, the MWD1 bit, and the MWD0 bit shall each be set to one if the ATA host supports MWDMA mode 2.

Page: 116

Sequence number: 1
Author: HPQ[RElliott]
Date: 6/24/2006 2:19:27 AM

 12.3.2
table 102

reorder the columns so PIO4 is on the left, to match table 101
RESOLUTION: see 06-291

Status
risheffi Completed 7/24/2006 10:11:28 AM

Sequence number: 2
Author: HPQ[RElliott]
Subject: Highlight
Date: 6/24/2006 2:20:14 AM

 12.3.2

indicates s/b specifies
RESOLUTION: see 06-291

Status
risheffi Completed 7/24/2006 10:11:51 AM

Sequence number: 3
Author: DELL[KMarks]
Subject: Highlight
Date: 6/24/2006 2:22:45 AM

 **2nd Paragraph, 1st Sentence after Table 102 — PIO modes change**

"...and the PIO field indicates a change..."
to
"...and the PIO bits specify a change..." with PIO not in small CAPS

RESOLUTION: see 06-291

Status
risheffi Completed 7/24/2006 10:11:59 AM

Sequence number: 4
Author: MXO[MEvans]
Subject: Highlight
Date: 7/24/2006 10:12:45 AM

 12.3.2 PATA Control Mode page (Page 0Ah, Subpage F1h), eleventh paragraph: change, "The application client shall not request a PIO mode setting that the ATA device is unable to support." to "The application client shall not request a PIO mode setting that the ATA device does not support."
RESOLUTION: see 06-291(deleted)

Status
risheffi Completed 7/24/2006 10:12:48 AM

Sequence number: 5
Author: MXO[MEvans]
Subject: Highlight
Date: 6/24/2006 2:27:28 AM

 12.3.2 PATA Control Mode Page (Page 0Ah, Sub Page F1h), eleventh paragraph: change, "If the application client requests a PIO setting that the ATA device is unable to support the SATL shall return..." to, "If the application client requests a PIO setting that the ATA device does not support, then the SATL shall return...".
RESOLUTION: see 06-291

Status
risheffi Completed 7/24/2006 10:13:08 AM

Sequence number: 6
Author: DELL[KMarks]
Subject: Highlight
Date: 6/24/2006 2:29:46 AM

Comments from page 116 continued on next page

When processing a MODE SENSE command, the SATL shall set the PIO3 bit and PIO4 bit as shown table 102 to identify the configured PIO mode.

Table 102 — PIO modes



PIO3	PIO4	PIO mode
0	0	Reserved
0	1	The ATA host shall use PIO mode 3 transfers.
1	0	The ATA host shall use PIO mode 4 transfers.
1	1	Reserved

When changeable values are requested, the PIO3 bit and the PIO4 bit indicate if the underlying ATA host supports those transfer modes. The PIO3 bit shall be set to one if the ATA host support PIO mode 3. The PIO3 bit and the PIO4 bit shall be set to one if the ATA host supports PIO mode 4.

If the SATL receives a MODE SELECT command and the PIO field indicates a change from the current setting, the SATL shall configure the ATA host to use the new PIO transfer rate, if supported. The application client shall not request a PIO mode setting that the ATA device is unable to support. If the application client requests a PIO setting that the ATA device is unable to support the SATL shall return a CHECK CONDITION status with the sense key set to ILLEGAL REQUEST and the additional sense code set to INVALID FIELD IN PARAMETER LIST.

The MWD0 bit, the MWD1 bit, and the MWD2 bit are collectively referred to as the MWDMA field. ⁷ the ATA host in the SATL is currently configured to use multi word DMA (MWDMA) ⁸ the MWDMA field is used to determine what mode is currently being used, what modes are supported by the ATA host, and control of the MWDMA mode.

If the SATL receives a MODE SENSE command requesting the current values of the PATA Control mode page, the MWD0 bit shall be set to one by the SATL when the host and device are configured to use MWDMA mode 0. The MWD1 bit shall be set to one by the SATL when the host and device are configured to use MWDMA mode1. The MWD2 bit shall be set to one by the SATL when the host and device are configured to use MWDMA mode 2.

If the SATL receives a MODE SENSE command requesting the changeable values of the PATA Control mode page, the MWD0 bit shall be set to one if the ATA host supports MWDMA mode 0. The MWD1 bit and MWD0 bit shall each be set to one if the ATA host supports MWDMA mode 1. The MWD2 bit, the MWD1 bit, and the MWD0 bit shall be each be set to one if the ATA host supports MWDMA mode 2.

T 3rd Paragraph, 1st Sentence after Table 102 — PIO modes change
"...as the MWDMA field."
to
"... as the MWDMA bits." with MWDMA not in small CAPS.
RESOLUTION: see 06-291

Status
risheffi Completed 7/24/2006 10:13:19 AM

Sequence number: 7
Author: MXO[MEvans]
Subject: Highlight
Date: 7/24/2006 10:14:35 AM

T 12.3.2 PATA Control Mode Page (Page 0Ah, Sub Page F1h), twelfth paragraph: change, "If the ATA host in the SATL is currently configured to use multi word DMA (MWDMA) the MWDMA field is used..." to, "If the ATA host in the SATL is currently configured to use multiword DMA (MWDMA), then the MWDMA field is used..."

Suggested resolution: s/b
"If the ATA host in the SATL is currently configured to use multiword DMA (MWDMA), then the MWDMA bits are used..." (not in small caps)
RESOLUTION: see 06-291 (Note: changed "mwdma" in SAT-r08b to "MWDMA" in SAT-r08c.

Status
risheffi Completed 7/24/2006 10:14:44 AM

Sequence number: 8
Author: DELL[KMarks]
Subject: Highlight
Date: 7/13/2006 12:14:52 AM

T 3rd Paragraph, 2st Sentence after Table 102 — PIO modes change
"...the MWDMA field is used..."
to
"... the MWDMA bits are used ..." with MWDMA not in small CAPS.
RESOLUTION: see 06-291

Status
risheffi Completed 7/24/2006 10:15:17 AM

Table 103 specifies values set by the SATL in the MWD0 bit, the MWD1 bit, and the MWD2 bit for current and changeable MWDMA settings.

Table 103 — MWDMA modes reported by MODE SENSE

MWDMA ¹ field			ATA host and device shared configuration settings returned as current values	ATA host support returned as changeable values
MWD0	MWD1	MWD2		
0	0	0	Configured not to use multiword DMA	Illegal combination
0	0	1	Configured to use MWDMA mode 1	
0	1	0	Configured to use MWDMA mode 2	
0	1	1	Configured to use MWDMA modes 1 and 2	
1	0	0	Configured to use MWDMA mode 0	MWDMA mode 0 supported
1	0	1	Configured to use MWDMA modes 0 and 2	Illegal combination
1	1	0	Configured to use MWDMA modes 0 and 1	MWDMA mode 1 supported
1	1	1	Configured to use MWDMA modes 0, 1 and 2	MWDMA mode 2 supported
^a If the application client attempts to set a MWDMA mode that is not supported by the ATA host environment, the SATL shall return a CHECK CONDITION status with the sense key set to ILLEGAL REQUEST with the additional sense code set to INVALID FIELD IN PARAMETER LIST.				

⁴ the SATL receives a MODE SELECT command³ and the MWDMA field indicates a change from the current settings, the SATL shall:

- 1) issue a SET FEATURES, sub-command 03h (Set Transfer Mode) to the ATA device, to set the MWDMA mode on the device to the requested state;
- 2) check the status of the SET FEATURES command once completed, and if the command completes in error, the SATL shall not change any host timing modes and shall complete the MODE SELECT command with a CHECK CONDITION status with the sense key set to ABORTED COMMAND and the additional sense code set to ATA DEVICE FAILED SET FEATURES, and the SATL shall take no further action regarding this MWDMA mode request; or
 - 1) if the SET FEATURES command completes without error the SATL shall configure the ATA host to communicate with the device at the requested MWDMA mode; and
 - 2) complete the MODE SELECT command with good status.

The MWDMA field values to configure ATA hosts and ATA devices using MODE SELECT have the same meaning as the MWDMA field values returned by MODE SENSE when current values are requested as shown in table 103.

If the SATL receives a request to set a MWDMA mode that is not supported by the ATA host or the attached PATA device, the SATL shall return a CHECK CONDITION status with the sense key set to ILLEGAL REQUEST with the additional sense code set to INVALID FIELD IN PARAMETER LIST.

The UDMA0 bit, the UDMA1 bit, the UDMA2 bit, the UDMA3 bit, the UDMA4 bit, the UDMA5 bit, and the UDMA6 bit are collectively referred to as the UDMA field, and are used to determine support for, current use of, and control of Ultra DMA (UDMA) timings on the ATA host and device. The SATL shall determine the highest UDMA mode supported as being the lower of the ATA host maximum transfer mode and the device maximum transfer mode.

NOTE 13 - The ATA device returns the UDMA transfer mode specified in IDENTIFY DEVICE data, word 88, bits 6:0 (see ATA/ATAPI-7).

Sequence number: 1
Author: DELL[KMarks]
Subject: Highlight
Date: 6/24/2006 2:33:57 AM

T In Table 103 — MWDMA modes reported by MODE SENSE

Change column 1 title to:

**"WMDMA a bits" with MWDMA not in small CAPS.
RESOLUTION: see 06-291**

Status
risheffi Completed 7/24/2006 10:15:40 AM

Sequence number: 2
Author: HPQ[RElliott]
Date: 6/24/2006 2:37:12 AM

T 12.3.2
table 103

reorder the columns so MWD2 is on the left, like in table 101
RESOLUTION: see 06-291

Status
risheffi Completed 7/24/2006 10:16:02 AM

Sequence number: 3
Author: DELL[KMarks]
Subject: Highlight
Date: 6/24/2006 2:38:43 AM

T 1st Sentence after Table 103 — MWDMA modes reported by MODE SENSE

change
"...and the MWDMA field indicates a change..."
to
"...and the MWDMA bits specify a change..." with MWDMA not in small CAPS.
RESOLUTION: see 06-291

Status
risheffi Completed 7/24/2006 10:16:28 AM

Sequence number: 4
Author: MXO[MEvans]
Subject: Highlight
Date: 6/24/2006 2:48:50 AM

T 12.3.2 PATA Control Mode page (Page 0Ah, Subpage F1h), paragraph following Table 103 – MWDMA modes reported by MODE SENSE: change the paragraph to:

If the SATL receives a MODE SELECT command and the MWDMA field indicates a change from the current settings, then the SATL shall:

- 1) issue a SET FEATURES, subcommand 03h (Set Transfer Mode) to the ATA device to set the MWDMA mode on the device to the requested state;
- 2) if the SET FEATURES command completes with an error, then the SATL shall:
 - A) not change any host transfer modes;
 - B) complete the MODE SELECT command with a CHECK CONDITION status with the sense key set to ABORTED COMMAND with the additional sense code set to ATA DEVICE FAILED SET FEATURES; and take no further action regarding this request to change the MWDMA transfer rate;and
- 3) if the SET FEATURES command completes without error, then the SATL shall:
 - A) configure the ATA host to communicate with the device at the requested MWDMA transfer rate; and
 - B) complete the MODE SELECT command with GOOD status.

RESOLUTION: see 06-291 s/b

"If the SATL receives a MODE SELECT command and the MWDMA bits specify a change from the current settings, then the SATL

Table 103 specifies values set by the SATL in the MWD0 bit, the MWD1 bit, and the MWD2 bit for current and changeable MWDMA settings.

Table 103 — MWDMA modes reported by MODE SENSE

MWDMA ^a field			ATA host and device shared configuration settings returned as current values	ATA host support returned as changeable values
MWD0	MWD1	MWD2		
0	0	0	Configured not to use multiword DMA	Illegal combination
0	0	1	Configured to use MWDMA mode 1	
0	1	0	Configured to use MWDMA mode 2	
0	1	1	Configured to use MWDMA modes 1 and 2	
1	0	0	Configured to use MWDMA mode 0	MWDMA mode 0 supported
1	0	1	Configured to use MWDMA modes 0 and 2	Illegal combination
1	1	0	Configured to use MWDMA modes 0 and 1	MWDMA mode 1 supported
1	1	1	Configured to use MWDMA modes 0, 1 and 2	MWDMA mode 2 supported

^a If the application client attempts to set a MWDMA mode that is not supported by the ATA host environment, the SATL shall return a CHECK CONDITION status with the sense key set to ILLEGAL REQUEST with the additional sense code set to INVALID FIELD IN PARAMETER LIST.

If the SATL receives a MODE SELECT command and the MWDMA field⁵ indicates a change from the current settings, the SATL shall:

- 6) issue a SET FEATURES, sub-command 03h (Set Transfer Mode) to the ATA device, to set the MWDMA mode on the device to the requested state;
- 2) check the status of the SET FEATURES command once completed, and if the command completes in error, the SATL shall not change any host timing modes and shall complete the MODE SELECT command with a CHECK CONDITION status with the sense key set to ABORTED COMMAND and the additional sense code set to ATA DEVICE FAILED SET FEATURES, and the SATL shall take no further action regarding this MWDMA mode request; or
 - 1) if the SET FEATURES command completes without error the SATL shall configure the ATA host to communicate with the device at the requested MWDMA mode; and
 - 2) complete the MODE SELECT command with good status.

The MWDMA field values to configure ATA hosts and ATA devices using MODE SELECT have the same meaning as the MWDMA field values returned by MODE SENSE when current values are requested as shown in table 103.

If the SATL receives a request to set a MWDMA mode that is not supported by the ATA host or the attached PATA device, the SATL shall return a CHECK CONDITION status with the sense key set to ILLEGAL REQUEST with the additional sense code set to INVALID FIELD IN PARAMETER LIST.

The UDMA0 bit, the UDMA1 bit, the UDMA2 bit, the UDMA3 bit, the UDMA4 bit, the UDMA5 bit, and the UDMA6 bit are collectively referred to as the UDMA field, and are used to determine support for, current use of, and control of Ultra DMA (UDMA) timings on the ATA host and device. The SATL shall determine the highest UDMA mode supported as being the lower of the ATA host maximum transfer mode and the device maximum transfer mode.

NOTE 13 - The ATA device returns the UDMA transfer mode specified in IDENTIFY DEVICE data, word 88, bits 6:0 (see ATA/ATAPI-7).

shall :

- a) if the ATA SET FEATURES command completes with an error, then the SATL shall:
 - 1) not change any host transfer modes;
 - 2) complete the MODE SELECT command with a CHECK CONDITION status with the sense key set to ABORTED COMMAND with the additional sense code set to ATA DEVICE FAILED SET FEATURES; and
 - 3) take no further action regarding this request to change the MWDMA transfer rate;
- or
- b) if the SET FEATURES command completes without error, then the SATL shall:
 - 1) configure the ATA host to communicate with the device at the requested MWDMA transfer rate; and
 - 2) complete the MODE SELECT command with GOOD status."

Status
rlsheffi Completed 7/24/2006 10:17:11 AM

Sequence number: 5
Author: HPQ[RElliott]
Subject: Highlight
Date: 6/24/2006 2:49:27 AM



12.3.2

indicates s/b specifies

RESOLUTION: see 06-291

Status
rlsheffi Completed 7/24/2006 10:17:29 AM

Sequence number: 6
Author: DELL[KMarks]
Subject: Highlight
Date: 6/24/2006 2:49:55 AM



1,2 list in 1st Sentence after **Table 103 — MWDMA modes reported by MODE SENSE**
change

- "1) issue a SET FEATURES, sub-command 03h (Set Transfer Mode) to the ATA device, to set the MWDMA mode on the device to the requested state;
- 2) check the status of the SET FEATURES command once completed, and if the command completes in error, the SATL shall not change any host timing modes and shall complete the MODE SELECT command with a CHECK CONDITION status with the sense key set to ABORTED COMMAND and the additional sense code set to ATA DEVICE FAILED SET FEATURES, and the SATL shall take no further action regarding this MWDMA mode request; or
- 1) if the SET FEATURES command completes without error the SATL shall configure the ATA host to communicate with the device at the requested MWDMA mode; and
 - 2) complete the MODE SELECT command with good status."

to

- "1) issue an ATA SET FEATURES - Set Transfer Mode (i.e., Features register set to 03h) to the ATA device, to set the MWDMA mode on the device to the requested state;
- 2) if the ATA SET FEATURES command completes with an error, the SATL shall not change any host timing modes and shall complete the MODE SELECT command with a CHECK CONDITION status with the sense key set to ABORTED COMMAND and the additional sense code set to ATA DEVICE FAILED SET FEATURES, and the SATL shall take no further action regarding this MWDMA mode request; or
- 3) if the ATA SET FEATURES command completes with no error, the SATL shall:
- 1) configure the ATA host to communicate with the device at the requested MWDMA mode; and
 - 2) complete the MODE SELECT command with GOOD status."

RESOLUTION: see 06-291

Status
rlsheffi Completed 7/24/2006 10:17:51 AM

Sequence number: 7
Author: ENDL[RWeber]
Date: 6/24/2006 2:50:14 AM



1,2 list

This list is structured incorrectly and I cannot tell for sure what is wrong with it. The clear syntax error is the 'or' at the end of the first list entry 2.

Comments from page 117 continued on next page

Table 103 specifies values set by the SATL in the MWD0 bit, the MWD1 bit, and the MWD2 bit for current and changeable MWDMA settings.

Table 103 — MWDMA modes reported by MODE SENSE

MWDMA ^a field			ATA host and device shared configuration settings returned as current values	ATA host support returned as changeable values
MWD0	MWD1	MWD2		
0	0	0	Configured not to use multiword DMA	Illegal combination
0	0	1	Configured to use MWDMA mode 1	
0	1	0	Configured to use MWDMA mode 2	
0	1	1	Configured to use MWDMA modes 1 and 2	
1	0	0	Configured to use MWDMA mode 0	MWDMA mode 0 supported
1	0	1	Configured to use MWDMA modes 0 and 2	Illegal combination
1	1	0	Configured to use MWDMA modes 0 and 1	MWDMA mode 1 supported
1	1	1	Configured to use MWDMA modes 0, 1 and 2	MWDMA mode 2 supported

^a If the application client attempts to set a MWDMA mode that is not supported by the ATA host environment, the SATL shall return a CHECK CONDITION status with the sense key set to ILLEGAL REQUEST with the additional sense code set to INVALID FIELD IN PARAMETER LIST.

If the SATL receives a MODE SELECT command and the MWDMA field indicates a change from the current settings, the SATL shall:

- 1) issue a SET FEATURES, sub-command 03h (Set Transfer Mode) to the ATA device, to set the MWDMA mode on the device to the requested state;
- 2) check the status of the SET FEATURES command once completed, and if the command completes in error, the SATL shall not change any host timing modes and shall complete the MODE SELECT command with a CHECK CONDITION status with the sense key set to ABORTED COMMAND and the additional sense code set to ATA DEVICE FAILED SET FEATURES, and the SATL shall take no further action regarding this MWDMA mode request; or
 - 1) if the SET FEATURES command completes without error the SATL shall configure the ATA host to communicate with the device at the requested MWDMA mode; and
 - 2) complete the MODE SELECT command with good status.

The MWDMA field values to configure ATA hosts and ATA devices using MODE SELECT have the same meaning as the MWDMA field values returned by MODE SENSE when current values are requested as shown in table 103.

If the SATL receives a request to set a MWDMA mode that is not supported by the ATA host or the attached PATA device, the SATL shall return a CHECK CONDITION status with the sense key set to ILLEGAL REQUEST with the additional sense code set to INVALID FIELD IN PARAMETER LIST.

The UDMA0 bit, the UDMA1 bit, the UDMA2 bit, the UDMA3 bit, the UDMA4 bit, the UDMA5 bit, and the UDMA6 bit are collectively referred to as the UDMA field, and are used to determine support for, current use of, and control of Ultra DMA (UDMA) timings on the ATA host and device. The SATL shall determine the highest UDMA mode supported as being the lower of the ATA host maximum transfer mode and the device maximum transfer mode.

¹¹ TE 13 - The ATA device returns the UDMA transfer mode specified in IDENTIFY DEVICE data, word 88, bits 6:0 (see ATA/ATAPI-7).

RESOLUTION: see 06-291

Status
rlsheffi Completed 7/24/2006 10:18:06 AM

Sequence number: 8
Author: DELL[KMarks]
Subject: Highlight
Date: 6/24/2006 2:53:22 AM

T 2nd Paragraph after **Table 103 — MWDMA modes reported by MODE SENSE**
change

"The MWDMA field values to configure ATA hosts and ATA devices using MODE SELECT have the same meaning as the MWDMA field values returned by MODE SENSE when current values are requested as shown in table 103."

to

"The MWDMA bits values used to configure ATA hosts and ATA devices using MODE SELECT command have the same meaning as the MWDMA bits values returned by MODE SENSE command when current values are requested as shown in table 103." with MWDMA not in small CAPS

RESOLUTION: see 06-291

Status
rlsheffi Completed 7/24/2006 10:18:55 AM

Sequence number: 9
Author: DELL[KMarks]
Subject: Highlight
Date: 6/24/2006 2:55:45 AM

T In 3rd Paragraph 1st Sentence after **Table 103 — MWDMA modes reported by MODE SENSE**
change

"...to as the UDMA field, and are used..."

to

"...to as the UDMA bits, and are used..." with UDMA not in small CAPS.

RESOLUTION: see 06-291

Status
rlsheffi Completed 7/24/2006 10:19:44 AM

Sequence number: 10
Author: MXO[MEvans]
Subject: Highlight
Date: 6/24/2006 2:56:54 AM

T 12.3.2 PATA Control Mode page (Page 0Ah, Subpage F1h), fourth paragraph following Table 105 – UDMA for current MODE SENSE settings: change "...Ultra DMA (UDMA) timings on the ATA host and device." to "...Ultra DMA (UDMA) transfer rates on the ATA host and device."

RESOLUTION: see 06-291

Status
rlsheffi Completed 7/24/2006 10:20:10 AM

Sequence number: 11
Author: DELL[KMarks]
Subject: Highlight
Date: 6/24/2006 2:58:31 AM

T Note 13
change

"NOTE 13 - The ATA device returns the UDMA transfer mode specified in IDENTIFY DEVICE data, word 88, bits 6:0 (see ATA/ATAPI-7)."

to

"NOTE 13 - The ATA device returns the UDMA transfer mode specified in ATA IDENTIFY DEVICE data, word 88, bits 6:0 (see ATA/ATAPI-7)."

RESOLUTION: change to,

"NOTE 13 - The ATA device returns the UDMA transfer mode specified in ATA IDENTIFY DEVICE data, word 88, bits 6:0 (see ATA8-ACS)."

RESOLUTION: see 06-291

Status
rlsheffi Completed 7/24/2006 10:20:45 AM

Comments from page 117 continued on next page

If the SATL receives a MODE SENSE command requesting the changeable values of the PATA Control mode page, ¹the UDMA field shall be set according to table 104.

²Table 104 — UDMA Field Requirements for changeable MODE SENSE

Highest UDMA mode supported	UDMA0	UDMA1	UDMA2	UDMA3	UDMA4	UDMA5	UDMA6
UDMA Unsupported	0	0	0	0	0	0	0
0	1	0	0	0	0	0	0
1	1	1	0	0	0	0	0
2	1	1	1	0	0	0	0
3	1	1	1	1	0	0	0
4	1	1	1	1	1	0	0
5	1	1	1	1	1	1	0
6	1	1	1	1	1	1	1

⁴the SATL receives a MODE SENSE command requesting the current values of the PATA Control mode page, the SATL shall set the UDMA field as defined in table 105. Only one UDMA bit shall be set to one at any time for such a request. If UDMA is not the current DMA transfer mode, all the bits in the UDMA field shall be set to zero. If a UDMA transfer mode is being used, all the bits in the MWDMA field shall be set to zero.

Table 105 — UDMA for current MODE SENSE settings

UDMA bit	Value	Description
UDMA0	0	ATA host and device are not communicating using UDMA Mode 0
	1	ATA host and device are communicating using UDMA Mode 0
UDMA1	0	ATA host and device are not communicating using UDMA Mode 1
	1	ATA host and device are communicating using UDMA Mode 1
UDMA2	0	ATA host and device are not communicating using UDMA Mode 2
	1	ATA host and device are communicating using UDMA Mode 2
UDMA3	0	ATA host and device are not communicating using UDMA Mode 3
	1	ATA host and device are communicating using UDMA Mode 3
UDMA4	0	ATA host and device are not communicating using UDMA Mode 4
	1	ATA host and device are communicating using UDMA Mode 4
UDMA5	0	ATA host and device are not communicating using UDMA Mode 5
	1	ATA host and device are communicating using UDMA Mode 5
UDMA6	0	ATA host and device are ⁵ communicating using UDMA Mode 6
	1	ATA host and device are communicating using UDMA Mode 6

When the SATL receives a MODE SELECT command and the UDMA field indicates a change in the requested UDMA speed in the communications interface, the SATL shall:

- 1) issue a SET FEATURES, sub-command 03h, to set the UDMA timing mode on the device to the requested state;
- 2) check the status of the SET FEATURES command once completed, and if the command completes in error, the SATL shall not change any host timing modes and shall complete the MODE SELECT command with a CHECK CONDITION status with the sense key set to ABORTED COMMAND with the additional sense code set to ATA DEVICE FAILED SET FEATURES, and the SATL shall take no further action regarding this timing mode request; or

Sequence number: 1
Author: DELL[KMarks]
Subject: Highlight
Date: 6/24/2006 2:59:21 AM

T 4th Paragraph after Table 103 — MWDMA modes reported by MODE SENSE
change

"...the UDMA field shall be set..."
to
"...the UDMA bits shall be set..." with UDMA not in small CAPS.
RESOLUTION: see 06-291

Status
risheffi Completed 7/24/2006 10:21:03 AM

Sequence number: 2
Author: DELL[KMarks]
Subject: Highlight
Date: 6/24/2006 3:00:46 AM

T Table 104 — UDMA Field Requirements for changeable MODE SENSE

change table 104 title to
"Table 104 — UDMA Bits Requirements for changeable MODE SENSE parameters"
RESOLUTION: see 06-291

Status
risheffi Completed 7/24/2006 10:21:18 AM

Sequence number: 3
Author: HPQ[RElliott]
Date: 6/24/2006 3:03:49 AM

 12.3.2
table 104

reorder the columns so the bits are on the left and the DMA mode supported is on the right, then so that bit UDMA6 is on the far left.
RESOLUTION: see 06-291

Status
risheffi Completed 7/24/2006 10:21:40 AM

Sequence number: 4
Author: DELL[KMarks]
Subject: Highlight
Date: 6/24/2006 3:10:47 AM

T 1st Paragraph after Table 104 — UDMA Field Requirements for changeable MODE SENSE
change

"If the SATL receives a MODE SENSE command requesting the current values of the PATA Control mode page, the SATL shall set the UDMA field as defined in table 105. Only one UDMA bit shall be set to one at any time for such a request. If UDMA is not the current DMA transfer mode, all the bits in the UDMA field shall be set to zero. If a UDMA transfer mode is being used, all the bits in the MWDMA field shall be set to zero."
to

"If the SATL receives a MODE SENSE command requesting the current values of the PATA Control mode page, the SATL shall set the UDMA bits as defined in table 105. Only one of the UDMA bits shall be set to one at any time for such a request. If UDMA is not the current DMA transfer mode, all the UDMA bits shall be set to zero. If a UDMA transfer mode is being used, all the MWDMA bits shall be set to zero." with UDMA and MWDMA not SMALL CAPS

RESOLUTION: see 06-291

Status
risheffi Completed 7/24/2006 10:23:30 AM

Sequence number: 5
Author: HPQ[RElliott]

If the SATL receives a MODE SENSE command requesting the changeable values of the PATA Control mode page, the UDMA field shall be set according to table 104.

Table 104 — UDMA Field Requirements for changeable MODE SENSE

Highest UDMA mode supported	UDMA0	UDMA1	UDMA2	UDMA3	UDMA4	UDMA5	UDMA6
UDMA Unsupported	0	0	0	0	0	0	0
0	1	0	0	0	0	0	0
1	1	1	0	0	0	0	0
2	1	1	1	0	0	0	0
3	1	1	1	1	0	0	0
4	1	1	1	1	1	0	0
5	1	1	1	1	1	1	0
6	1	1	1	1	1	1	1

If the SATL receives a MODE SENSE command requesting the current values of the PATA Control mode page, the SATL shall set the UDMA field as defined in table 105. Only one UDMA bit shall be set to one at any time for such a request. If UDMA is not the current DMA transfer mode, all the bits in the UDMA field shall be set to zero. If a UDMA transfer mode is being used, all the bits in the MWDMA field shall be set to zero.

Table 105 — UDMA for current MODE SENSE settings

UDMA bit	Value	Description
UDMA0	0	ATA host and device are not communicating using UDMA Mode 0
	1	ATA host and device are communicating using UDMA Mode 0
UDMA1	0	ATA host and device are not communicating using UDMA Mode 1
	1	ATA host and device are communicating using UDMA Mode 1
UDMA2	0	ATA host and device are not communicating using UDMA Mode 2
	1	ATA host and device are communicating using UDMA Mode 2
UDMA3	0	ATA host and device are not communicating using UDMA Mode 3
	1	ATA host and device are communicating using UDMA Mode 3
UDMA4	0	ATA host and device are not communicating using UDMA Mode 4
	1	ATA host and device are communicating using UDMA Mode 4
UDMA5	0	ATA host and device are not communicating using UDMA Mode 5
	1	ATA host and device are communicating using UDMA Mode 5
UDMA6	0	ATA host and device are communicating using UDMA Mode 6
	1	ATA host and device are communicating using UDMA Mode 6

When the SATL receives a MODE SELECT command and the UDMA field indicates a change in the requested UDMA speed in the communications interface, the SATL shall:

- 1) issue a SET FEATURES, sub-command 03h, to set the UDMA timing mode on the device to the requested state;
- 2) check the status of the SET FEATURES command once completed, and if the command completes in error, the SATL shall not change any host timing modes and shall complete the MODE SELECT command with a CHECK CONDITION status with the sense key set to ABORTED COMMAND with the additional sense code set to ATA DEVICE FAILED SET FEATURES, and the SATL shall take no further action regarding this timing mode request; or

Date: 6/24/2006 3:12:49 AM

T 12.3.2
table 105

communicating s/b not communicating in UDMA6=0
RESOLUTION: see 06-291

Status
risheffi Completed 7/24/2006 10:23:56 AM

Sequence number: 6
Author: DELL[KMarks]
Subject: Highlight
Date: 6/24/2006 3:13:00 AM

T Table 105 — UDMA for current MODE SENSE settings

Row: UDMA 6 0
change
"ATA host and device are communicating using UDMA Mode 6"
to
"ATA host and device are not communicating using UDMA Mode 6"
RESOLUTION: see 06-291

Status
risheffi Completed 7/24/2006 10:24:06 AM

Sequence number: 7
Author: DELL[KMarks]
Subject: Highlight
Date: 6/24/2006 3:32:02 AM

T 1st Paragraph after Table 105 — UDMA for current MODE SENSE settings

change
"...command and the UDMA field indicates a change..."
to
"...command and the UDMA bits specify a change..."

RESOLUTION: see 06-291

Status
risheffi Completed 7/24/2006 10:24:29 AM

Sequence number: 8
Author: MXO[MEvans]
Subject: Highlight
Date: 7/13/2006 12:18:55 AM

T 12.3.2 PATA Control Mode page (Page 0Ah, Subpage F1h), paragraph following Table 105 – UDMA for current MODE SENSE settings: change the paragraph to:

When the SATL receives a MODE SELECT command and the UDMA bits requests a change in the UDMA transfer rate, then the SATL shall:

- 1) issue a SET FEATURES subcommand 03h to set the UDMA transfer mode on the device to the requested rate;
- 2) if the SET FEATURES command completes with an error, then the SATL shall:
 - A) not change any host transfer modes;
 - B) complete the MODE SELECT command with a CHECK CONDITION status with the sense key set to ABORTED COMMAND with the additional sense code set to ATA DEVICE FAILED SET FEATURES; and
 - C) take no further action regarding this request to change the UDMA transfer rate;and
- 3) if the SET FEATURES command completes without error, then the SATL shall:
 - A) configure the ATA host to communicate with the device at the requested UDMA transfer rate; and
 - B) complete the MODE SELECT command with GOOD status.

suggested resolution: s/b

"When the SATL receives a MODE SELECT command and the UDMA bits request a change in the UDMA transfer rate, then the SATL shall issue a SET FEATURES - Set Transfer Mode (i.e., with the Features register set to 03h) to set the UDMA transfer mode on the device to the requested rate; and then:

- 1) if the SET FEATURES command completes with an error, then the SATL:
 - A) shall not change any host transfer modes;

Comments from page 118 continued on next page

If the SATL receives a MODE SENSE command requesting the changeable values of the PATA Control mode page, the UDMA field shall be set according to table 104.

Table 104 — UDMA Field Requirements for changeable MODE SENSE

Highest UDMA mode supported	UDMA0	UDMA1	UDMA2	UDMA3	UDMA4	UDMA5	UDMA6
UDMA Unsupported	0	0	0	0	0	0	0
0	1	0	0	0	0	0	0
1	1	1	0	0	0	0	0
2	1	1	1	0	0	0	0
3	1	1	1	1	0	0	0
4	1	1	1	1	1	0	0
5	1	1	1	1	1	1	0
6	1	1	1	1	1	1	1

If the SATL receives a MODE SENSE command requesting the current values of the PATA Control mode page, the SATL shall set the UDMA field as defined in table 105. Only one UDMA bit shall be set to one at any time for such a request. If UDMA is not the current DMA transfer mode, all the bits in the UDMA field shall be set to zero. If a UDMA transfer mode is being used, all the bits in the MWDMA field shall be set to zero.

Table 105 — UDMA for current MODE SENSE settings

UDMA bit	Value	Description
UDMA0	0	ATA host and device are not communicating using UDMA Mode 0
	1	ATA host and device are communicating using UDMA Mode 0
UDMA1	0	ATA host and device are not communicating using UDMA Mode 1
	1	ATA host and device are communicating using UDMA Mode 1
UDMA2	0	ATA host and device are not communicating using UDMA Mode 2
	1	ATA host and device are communicating using UDMA Mode 2
UDMA3	0	ATA host and device are not communicating using UDMA Mode 3
	1	ATA host and device are communicating using UDMA Mode 3
UDMA4	0	ATA host and device are not communicating using UDMA Mode 4
	1	ATA host and device are communicating using UDMA Mode 4
UDMA5	0	ATA host and device are not communicating using UDMA Mode 5
	1	ATA host and device are communicating using UDMA Mode 5
UDMA6	0	ATA host and device are communicating using UDMA Mode 6
	1	ATA host and device are communicating using UDMA Mode 6

When the SATL receives a MODE SELECT command and the UDMA field indicates a change in the requested UDMA speed in the communications interface, the SATL shall:

1) issue a SET FEATURES, sub-command 03h, to set the UDMA timing mode on the device to the requested state;

2) check the status of the SET FEATURES command once completed, and if the command completes in error, the SATL shall not change any host timing modes and shall complete the MODE SELECT command with a CHECK CONDITION status with the sense key set to ABORTED COMMAND with the additional sense code set to ATA DEVICE FAILED SET FEATURES, and the SATL shall take no further action regarding this timing mode request; or

- B) shall complete the MODE SELECT command with a CHECK CONDITION status with the sense key set to ABORTED COMMAND with the additional sense code set to ATA DEVICE FAILED SET FEATURES; and
C) shall take no further action regarding this request to change the UDMA transfer rate;
and
2) if the SET FEATURES command completes without error, then the SATL shall:
A) configure the ATA host to communicate with the device at the requested UDMA transfer rate; and
B) complete the MODE SELECT command with GOOD status"

RESOLUTION: see 06-291

Status
rsheffi Completed 7/24/2006 10:25:08 AM

Sequence number: 9
Author: HPQ[RElliott]
Subject: Highlight
Date: 7/24/2006 10:25:48 AM

T 12.3.2

indicates s/b specifies
RESOLUTION: see 06-291 (changed to "requests")

Status
rsheffi Completed 7/24/2006 10:25:50 AM

Sequence number: 10
Author: DELL[KMarks]
Subject: Highlight
Date: 6/24/2006 3:33:27 AM

T 1,2 list in 1st Paragraph after **Table 105 — UDMA for current MODE SENSE settings**
change

- "
- 1) issue a SET FEATURES, sub-command 03h, to set the UDMA timing mode on the device to the requested state;
 - 2) check the status of the SET FEATURES command once completed, and if the command completes in error, the SATL shall not change any host timing modes and shall complete the MODE SELECT command with a CHECK CONDITION status with the sense key set to ABORTED COMMAND with the additional sense code set to ATA DEVICE FAILED SET FEATURES, and the SATL shall take no further action regarding this timing mode request; or"

to

1,2 list in 1st Paragraph after **Table 105 — UDMA for current MODE SENSE settings**
change

- "
- 1) issue an ATA SET FEATURES - Set Transfer Mode (i.e., Feature register set to 03h), to set the UDMA timing mode on the device to the requested state;
 - 2) if the ATA SET FEATURES command completes with an error, the SATL shall not change any host timing modes and shall complete the MODE SELECT command with a CHECK CONDITION status with the sense key set to ABORTED COMMAND with the additional sense code set to ATA DEVICE FAILED SET FEATURES, and the SATL shall take no further action regarding this timing mode request; or
 - 3) ..." see next comment for 3) content.

RESOLUTION: see 06-291

Status
rsheffi Completed 7/24/2006 10:26:09 AM

Sequence number: 11
Author: ENDL[RWeber]
Date: 6/24/2006 3:33:38 AM

 1,2 list

This list is structured incorrectly and I cannot tell for sure what is wrong with it. The clear syntax error is the 'or' at the end of the first list entry 2.

RESOLUTION: see 06-291

Status
rsheffi Completed 7/24/2006 10:26:25 AM

- 2) if the SET FEATURES command completes without error the SATL shall configure the ATA host to communicate with the device at the requested UDMA timing speeds; and
 - 2) complete the MODE SELECT command with GOOD status.
- 3) the application client attempts to set a mode that the underlying host or device does not support the SATL shall return a CHECK CONDITION status with the sense key set to ILLEGAL REQUEST with the additional sense code set to INVALID FIELD IN PARAMETER LIST.

Sequence number: 1
Author: DELL[KMarks]
Subject: Highlight
Date: 6/24/2006 3:33:57 AM

T Continuation of 1,2 list in 1st Paragraph after **Table 105 — UDMA for current MODE SENSE settings**
change

" 1) if the **SET FEATURES** command completes without error the SATL shall configure the ATA host to communicate with the device at the requested UDMA timing speeds; and
2) complete the **MODE SELECT** command with **GOOD** status."

to

" 3) if the **ATA SET FEATURES** command completes with no error the SATL shall:
1) configure the ATA host to communicate with the device at the requested UDMA timing speeds; and
2) complete the **MODE SELECT** command with **GOOD** status."

RESOLUTION: see 06-291

Status
rsheffi Completed 7/24/2006 10:26:42 AM

Sequence number: 2
Author: MXO[MEvans]
Subject: Highlight
Date: 6/24/2006 3:34:40 AM

T 12.3.2 PATA Control Mode page (Page 0Ah, Subpage F1h), paragraph following Table 105 – UDMA for current MODE SENSE settings: delete the portion on this page as it is replaced by the comment on the previous page.
RESOLUTION: see 06-291

Status
rsheffi Completed 7/24/2006 10:26:47 AM

Sequence number: 3
Author: MXO[MEvans]
Subject: Highlight
Date: 6/24/2006 3:38:10 AM

T 12.3.2 PATA Control Mode page (Page 0Ah, Subpage F1h), last paragraph: change to, "If the application client attempts to set a transfer mode that the underlying host or device does not support, then the SATL shall return a CHECK CONDITION status with the sense key set to ILLEGAL REQUEST with the additional sense code set to INVALID FIELD IN PARAMETER LIST."

RESOLUTION: see 06-291 - s/b

"If the application client attempts to set a transfer mode that the ATA host or ATA device does not support, then the SATL shall terminate the **MODE SELECT** command with **CHECK CONDITION** status with the sense key set to **ILLEGAL REQUEST** with the additional sense code set to **INVALID FIELD IN PARAMETER LIST**."

Status
rsheffi Completed 7/24/2006 10:27:21 AM

~~13 Translation for ATAPI devices~~¹

~~13.1 Overview~~²

~~This subclause describes those elements of SCSI / ATA Translation that are specific to ATAPI devices.~~

~~13.2 Commands~~

~~13.2.1 INQUIRY command~~

~~3.2.1.1 INQUIRY command overview~~

For ATAPI devices, the SATL may support the ATA Information VPD page (see 13.2.1.3) to provide information about the SATL and provide the IDENTIFY PACKET DEVICE data from the ATAPI device.

⁴ the SATL does not support the ATA Information VPD page, it shall pass through all INQUIRY commands and parameter data unaltered to the ATAPI device.

⁵ the SATL supports the ATA Information VPD page, the SATL shall:

- a) pass through INQUIRY commands requesting the standard INQUIRY data unaltered;
- b) pass through INQUIRY commands requesting VPD pages other than the Supported VPD Pages VPD page and the ATA Information VPD page unaltered;
- c) process INQUIRY commands requesting the Supported VPD Pages VPD page (see SPC-3) as described in 13.2.1.2; and
- d) process INQUIRY commands requesting the ATA Information VPD page (see 10.3.5) as described in 13.2.1.3.

~~13.2.1.2 Supported VPD Pages VPD page~~

If the SATL supports the ATA Information VPD page, the SATL shall pass through an INQUIRY command requesting the Supported VPD Pages VPD page (see SPC-3) to the ATAPI device unaltered.

If the ATAPI device returns CHECK CONDITION status with the sense key set to ILLEGAL REQUEST and the additional sense code set to INVALID FIELD IN CDB, and the field pointer in the sense data points to the EVPD bit or the PAGE CODE field, the SATL shall return GOOD status and return parameter data containing the Supported VPD Pages VPD page with only two supported VPD page codes:

- a) 00h (i.e., Supported VPD Pages); and
- b) 89h (i.e., ATA Information).

If the ATAPI device returns GOOD status, the SATL shall modify the parameter data containing the Supported VPD Pages VPD page returned by the ATAPI device to add 89h (i.e., the ATA Information VPD page) into the supported VPD page code list.

~~13.2.1.3 ATA Information VPD page~~

If the SATL supports the ATA Information VPD page (see 10.3.5) and it receives an INQUIRY command requesting the ATA Information VPD page, the SATL shall process the command (i.e., return parameter data and status) itself and shall not pass through the INQUIRY command to the ATAPI device.

~~The SATL shall use the IDENTIFY PACKET DEVICE command (A1h) rather than the IDENTIFY DEVICE command (ECh) to retrieve information for the ATA Information VPD page from the attached ATAPI device.~~



Sequence number: 1
Author: WDC[CStevens]
Subject: Replacement Text
Date: 3/9/2006 12:17:28 PM

T This makes it look like we have spec'ed how to do ATAPI, but we really have not. There is a major piece of work missing. I would suggest that this clause be removed, or just limit it to the overview and state that this subclause will be developed in a future version of SAT. If you leave this in, you will be limiting SAT-2's ability to define ATAPI.

RESOLUTION:

change "13 Translation for ATAPI devices" to
"Annex A INQUIRY command translation considerations for ATAPI devices"

Status
risheffi Completed 6/24/2006 4:05:11 AM

Sequence number: 2
Author: EDITOR[risheffi]
Subject: Cross-Out
Date: 4/24/2006 11:05:00 AM

T

Status
risheffi Completed 6/24/2006 4:05:19 AM

Sequence number: 3
Author: EDITOR[risheffi]
Subject: Highlight
Date: 4/24/2006 11:05:36 AM

T

s/b
A.1

Status
risheffi Completed 6/24/2006 4:05:28 AM

Sequence number: 4
Author: MXO[MEvans]
Subject: Highlight
Date: 6/24/2006 4:11:14 AM

T 13.2.1.1 INQUIRY command overview, second paragraph: change to, "If the SATL does not support the ATA Information VPD page, then the SATL shall use the PACKET Command feature set to pass all INQUIRY commands and parameter data to the ATAPI device without altering the INQUIRY commands or the parameter data.

RESOLUTION: s/b

"If the SATL does not support the ATA Information VPD page, then the SATL shall use the ATA PACKET Command feature set to pass all INQUIRY commands and parameter data to the ATAPI device without altering the INQUIRY commands or the parameter data."

Status
risheffi Completed 6/24/2006 4:07:14 AM

Sequence number: 5
Author: MXO[MEvans]
Subject: Highlight
Date: 6/24/2006 4:11:34 AM

T

13.2.1.1 INQUIRY command overview, third paragraph: change to:

If the SATL supports the ATA Information VPD page, then the SATL shall:

- use the PACKET Command feature set to pass all INQUIRY commands requesting standard INQUIRY data to an ATAPI device without altering the INQUIRY commands;
- use the PACKET Command feature set to pass all INQUIRY commands requesting VPD pages, other than the Supported VPD Pages VPD page and the ATA Information VPD page, to an ATAPI device without altering the INQUIRY commands;
- process INQUIRY commands requesting the Supported VPD Pages VPD page (see SPC-3) as described in 13.2.1.2; and
- process INQUIRY commands requesting the ATA Information VPD page (see 10.3.5) as described in 13.2.1.3.

RESOLUTION: s/b

~~13 Translation for ATAPI devices~~

~~13.1 Overview~~

~~This subclause describes those elements of SCSI / ATA Translation that are specific to ATAPI devices.~~

~~13.2 Commands~~

~~13.2.1 INQUIRY command~~

13.2.1.1 INQUIRY command overview

For ATAPI devices, the SATL may support the ATA Information VPD page (see 13.2.1.3) to provide information about the SATL and provide the IDENTIFY PACKET DEVICE data from the ATAPI device.

If the SATL does not support the ATA Information VPD page, it shall pass through all INQUIRY commands and parameter data unaltered to the ATAPI device.

If the SATL supports the ATA Information VPD page, the SATL shall:

- a) pass through INQUIRY commands requesting the standard INQUIRY data unaltered;
- b) pass through INQUIRY commands requesting VPD pages other than the Supported VPD Pages VPD page and the ATA Information VPD page unaltered;
- c) process INQUIRY commands requesting the Supported VPD Pages VPD page (see SPC-3) as described in 13.2.1.2; and
- d) process INQUIRY commands requesting the ATA Information VPD page (see 10.3.5) as described in 13.2.1.3.

6 13.2.1.2 Supported VPD Pages VPD page

7 the SATL supports the ATA Information VPD page, the SATL shall pass through an INQUIRY command requesting the Supported VPD Pages VPD page (see SPC-3) to the ATAPI device unaltered.

If the ATAPI device returns CHECK CONDITION status with the sense key set to ILLEGAL REQUEST and the additional sense code set to INVALID FIELD IN CDB, and the field pointer in the sense data points to the EVPD bit or the PAGE CODE field, the SATL shall return GOOD status and return parameter data containing the Supported VPD Pages VPD page with only two supported VPD page codes:

- a) 00h (i.e., Supported VPD Pages); and
- b) 89h (i.e., ATA Information).

If the ATAPI device returns GOOD status, the SATL shall modify the parameter data containing the Supported VPD Pages VPD page returned by the ATAPI device to add 89h (i.e., the ATA Information VPD page) into the supported VPD page code list.

8 13.2.1.3 ATA Information VPD page

9 the SATL supports the ATA Information VPD page (see 10.3.5) and it receives an INQUIRY command requesting the ATA Information VPD page, the SATL shall process the command ¹⁰, return parameter data and status) itself and shall not pass through the INQUIRY command to the ATAPI device.

~~11 The SATL shall use the IDENTIFY PACKET DEVICE command (A1h) rather than the IDENTIFY DEVICE command (ECh) to retrieve information for the ATA Information VPD page from the attached ATAPI device.~~



"If the SATL supports the ATA Information VPD page, then the SATL shall:

- a) use the ATA PACKET Command feature set to pass all INQUIRY commands requesting standard INQUIRY data to an ATAPI device without altering the INQUIRY commands;
- b) use the ATA PACKET Command feature set to pass all INQUIRY commands requesting VPD pages, other than the Supported VPD Pages VPD page and the ATA Information VPD page, to an ATAPI device without altering the INQUIRY commands;
- c) process INQUIRY commands requesting the Supported VPD Pages VPD page (see SPC-3) as described in 13.2.1.2; and
- d) process INQUIRY commands requesting the ATA Information VPD page (see 10.3.5) as described in 13.2.1.3."

Status
risheffi Completed 6/24/2006 4:10:29 AM

Sequence number: 6
Author: EDITOR[risheffi]
Subject: Highlight
Date: 4/24/2006 11:05:57 AM

Ts/b
A.2

Status
risheffi Completed 6/24/2006 4:10:43 AM

Sequence number: 7
Author: MXO[MEvans]
Subject: Highlight
Date: 6/24/2006 4:12:02 AM

T 13.2.1.2 Supported VPD Pages VPD page, first paragraph: change to, "If the SATL supports the ATA Information VPD page, then the SATL shall use the PACKET Command feature set to pass all INQUIRY commands requesting the Supported VPD Pages VPD page (see SPC-3) to the ATAPI device without altering the INQUIRY commands."

RESOLUTION: s/b

"If the SATL supports the ATA Information VPD page, then the SATL shall use the ATA PACKET Command feature set to pass all INQUIRY commands requesting the Supported VPD Pages VPD page (see SPC-3) to the ATAPI device without altering the INQUIRY commands."

Status
risheffi Completed 6/24/2006 4:12:21 AM

Sequence number: 8
Author: EDITOR[risheffi]
Subject: Highlight
Date: 4/24/2006 11:06:16 AM

Ts/b
A.3

Status
risheffi Completed 6/24/2006 4:12:42 AM

Sequence number: 9
Author: MXO[MEvans]
Subject: Highlight
Date: 2/16/2006 2:13:18 PM

T 13.2.1.3 ATA Information VPD page, first paragraph: change to, "If the SATL supports the ATA Information VPD page (see 10.3.5), and the SATL receives an INQUIRY command requesting the ATA Information VPD page, then the SATL shall process the command (i.e., return parameter data and status) itself and shall not pass the INQUIRY command through to the ATAPI device."

Status
risheffi Completed 6/24/2006 4:13:54 AM

Sequence number: 10
Author: DELL[KMarks]
Subject: Highlight
Date: 2/12/2006 10:49:13 PM

T 13.2.1.3 ATA Information VPD page
1st Paragraph
remove period between "itself.and"

Status
risheffi Completed 6/24/2006 4:14:13 AM

Sequence number: 11
Author: DELL[KMarks]

Comments from page 120 continued on next page

~~13 Translation for ATAPI devices~~

~~13.1 Overview~~

~~This subclause describes those elements of SCSI / ATA Translation that are specific to ATAPI devices.~~

~~13.2 Commands~~

~~13.2.1 INQUIRY command~~

13.2.1.1 INQUIRY command overview

For ATAPI devices, the SATL may support the ATA Information VPD page (see 13.2.1.3) to provide information about the SATL and provide the IDENTIFY PACKET DEVICE data from the ATAPI device.

If the SATL does not support the ATA Information VPD page, it shall pass through all INQUIRY commands and parameter data unaltered to the ATAPI device.

If the SATL supports the ATA Information VPD page, the SATL shall:

- a) pass through INQUIRY commands requesting the standard INQUIRY data unaltered;
- b) pass through INQUIRY commands requesting VPD pages other than the Supported VPD Pages VPD page and the ATA Information VPD page unaltered;
- c) process INQUIRY commands requesting the Supported VPD Pages VPD page (see SPC-3) as described in 13.2.1.2; and
- d) process INQUIRY commands requesting the ATA Information VPD page (see 10.3.5) as described in 13.2.1.3.

13.2.1.2 Supported VPD Pages VPD page

If the SATL supports the ATA Information VPD page, the SATL shall pass through an INQUIRY command requesting the Supported VPD Pages VPD page (see SPC-3) to the ATAPI device unaltered.

If the ATAPI device returns CHECK CONDITION status with the sense key set to ILLEGAL REQUEST and the additional sense code set to INVALID FIELD IN CDB, and the field pointer in the sense data points to the EVPD bit or the PAGE CODE field, the SATL shall return GOOD status and return parameter data containing the Supported VPD Pages VPD page with only two supported VPD page codes:

- a) 00h (i.e., Supported VPD Pages); and
- b) 89h (i.e., ATA Information).

If the ATAPI device returns GOOD status, the SATL shall modify the parameter data containing the Supported VPD Pages VPD page returned by the ATAPI device to add 89h (i.e., the ATA Information VPD page) into the supported VPD page code list.

13.2.1.3 ATA Information VPD page

If the SATL supports the ATA Information VPD page (see 10.3.5) and it receives an INQUIRY command requesting the ATA Information VPD page, the SATL shall process the command (i.e., return parameter data and status) itself and shall not pass through the INQUIRY command to the ATAPI device.

~~The SATL shall use the IDENTIFY PACKET DEVICE command (A1h) rather than the IDENTIFY DEVICE command (ECh) to retrieve information for the ATA Information VPD page from the attached ATAPI device.~~



Subject: Cross-Out
Date: 6/24/2006 4:15:36 AM

 13.2.1.3 ATA Information VPD page

remove

"The SATL shall use the IDENTIFY PACKET DEVICE command (A1h) rather than the IDENTIFY DEVICE command (ECh) to retrieve information for the ATA Information VPD page from the attached ATAPI device."

The ATA Information VPD page material already takes care of ATA and ATAPI devices.

Status
rlsheffi Completed 6/24/2006 4:15:39 AM

Sequence number: 12
Author: STX[GHolder]
Subject: Note
Date: 9/13/2006 9:06:40 AM

 PDF page 120

That this is the final page is not easily determined.
Please either put in a section that says 'this is the end'
or make the page footer say 'page xxx of yyy' so that
it is easy to determine if some pages are missing

REASON: The T10 style guide does not include any special annotation for the last page of the document, and no other SCSI standards specifically annotate the final page.

Status
rlsheffi Rejected 9/13/2006 9:06:44 AM
