

T10/05-384r1 SAS-2 Channel Models (3-Connector, Board-to-Board)

To: T10 Technical Committee
From: Barry Olawsky, HP (barry.olawsky@hp.com)
Date: 4 November 2005
Subject: T10/05-384r1 SAS-2 Channel Models (3-Connector, Board-to-Board)

Revision History

Revision 0 (14 October 2005) first revision
Revision 1 (4 November 2005) crosstalk models were added

Related Documents

05-357r0 - SAS-2 External Cable Electrical Specification (Alvin Cox, Seagate)

Overview

Provide sample channel models to the storage industry. Channel designs HP01 to HP08 consist of three connector interfaces with a total of 12 to 18 inches of FR-4. Two of the connector interfaces are grid array board-to-board designs and the third one is an SFF8482 hybrid.

Models HP15 to HP19 are near-end crosstalk models from the same DUT. HP19 is the between the tx and rx pairs of the primary port of an SFF8482 hybrid connector has seen by a hard drive. HP15 to HP18 are near-end crosstalk models of a grid array board-to-board connector as seen by the host chip. For that interface, at most six pairs can have a non-negligible contribution to the near-end crosstalk of a receiver pair. Two of the same row and four from adjacent rows. The total near-end crosstalk for a receiver pair is then $HP15 + HP16 + HP17 + HP18 + HP17 + HP18$.

S21dd Measurement Setup

S21dd measurements were performed with an E8362B Agilent VNA and N4419A test set. The frequency range is 50MHz to 20GHz with a 10MHz step size. The format of the data is (magnitude, angle) ... but not dB magnitude. Input to output port mapping through the DUT is shown in the following figure. Ports 2 and 4 are connected to the SFF8482 end of the DUT.

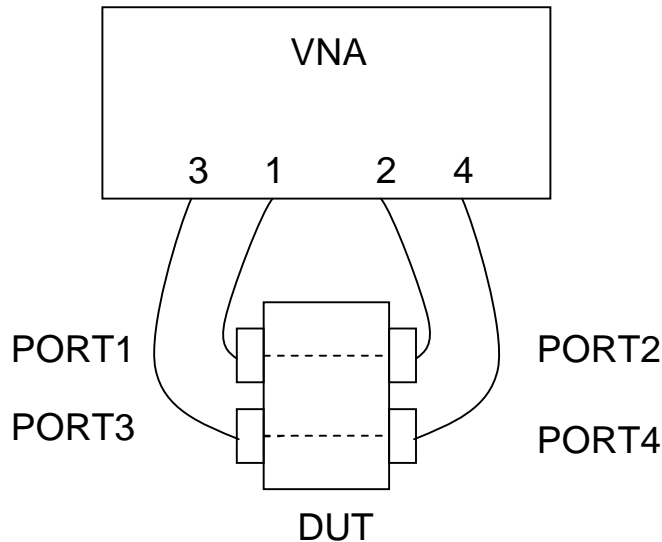

S21dd Plots

S21 plots are provided below to assist in selecting sample channels to evaluate. **Note that plots HP01 to HP08 are S21dd and not S21 single ended.**

HP01_BtoB_3Connector:

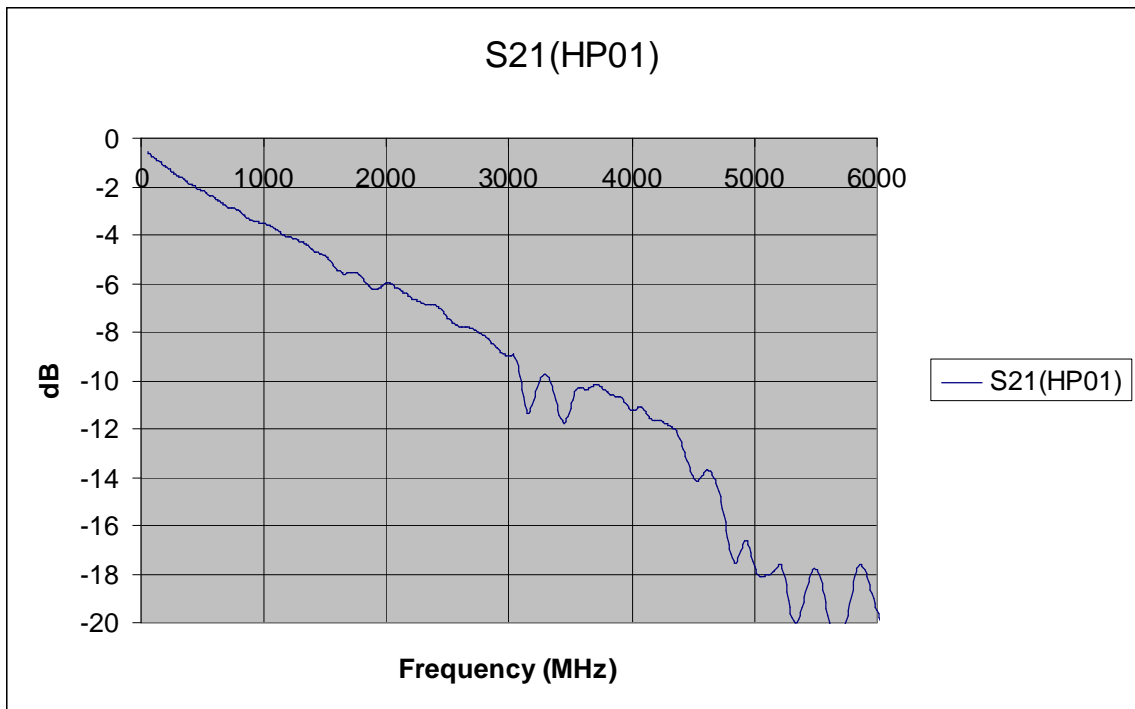
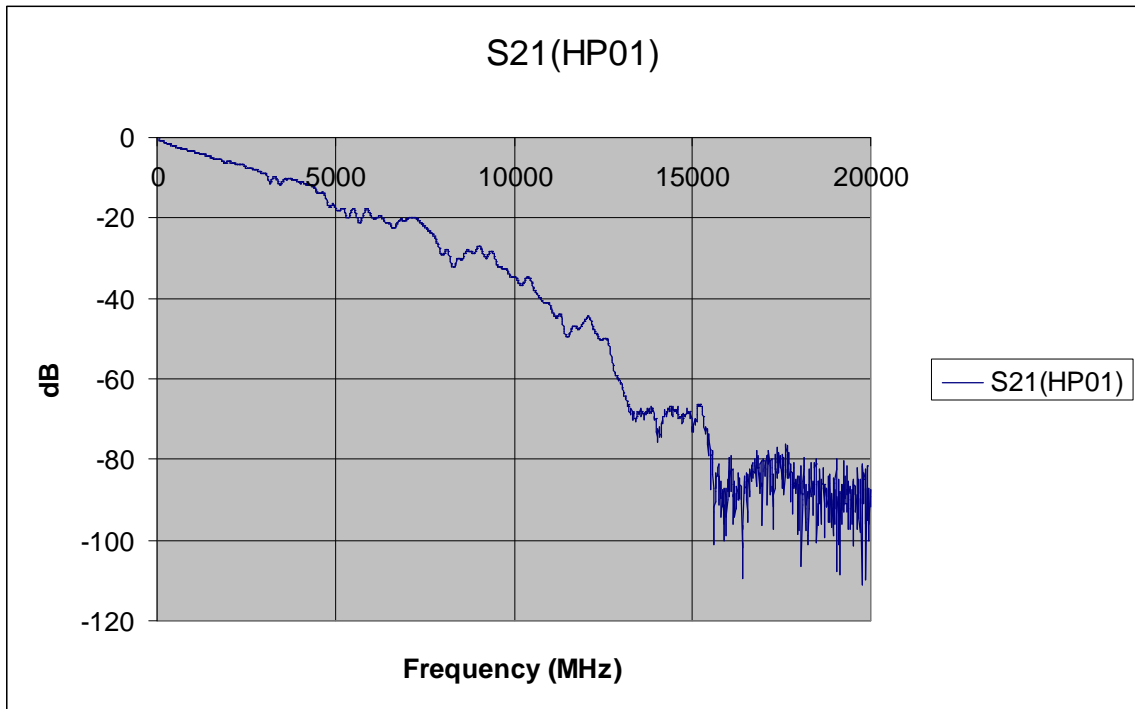

HP02_BtoB_3Connector:

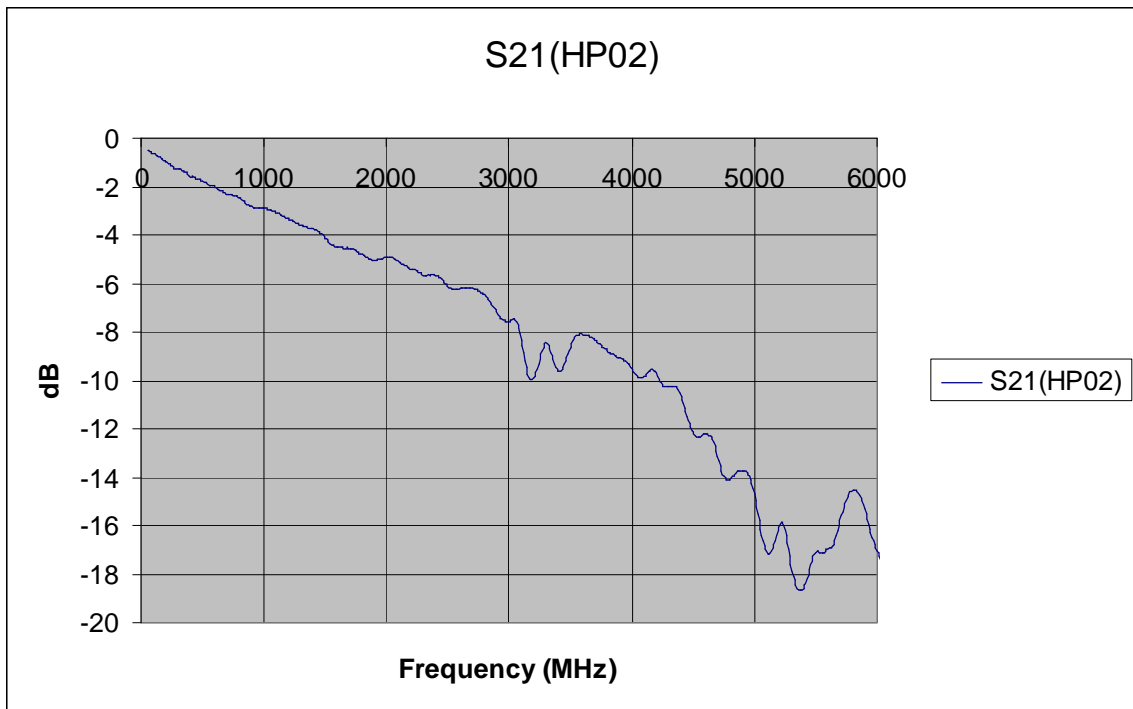
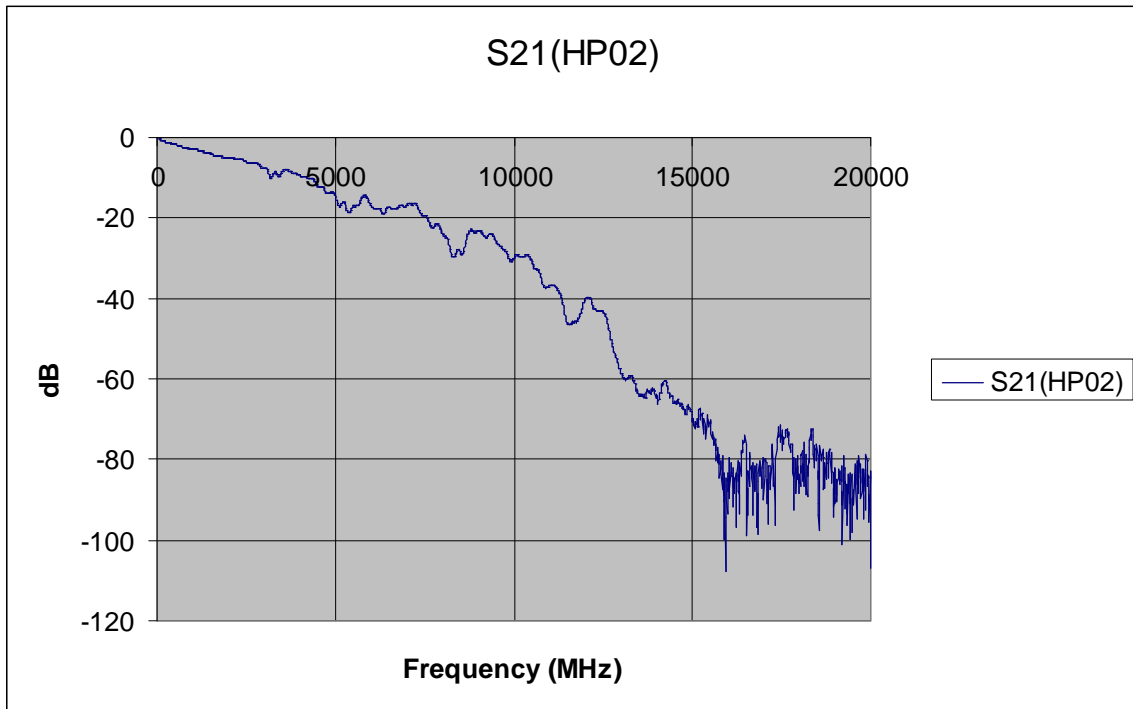

HP03_BtoB_3Connector:

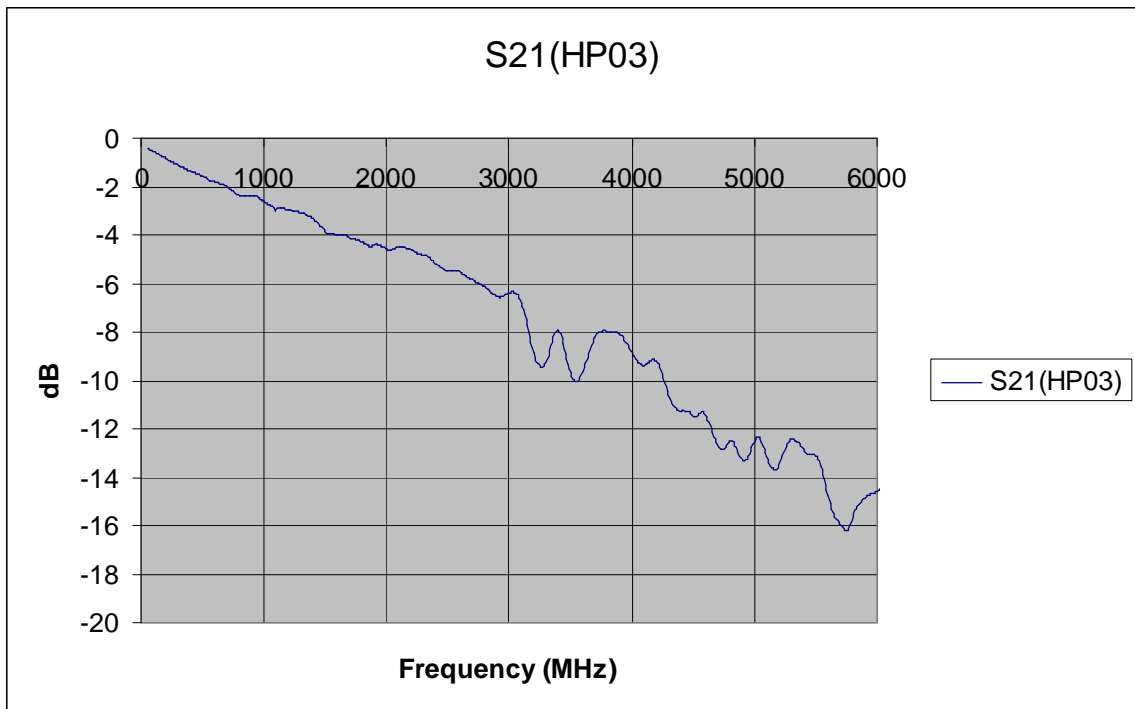
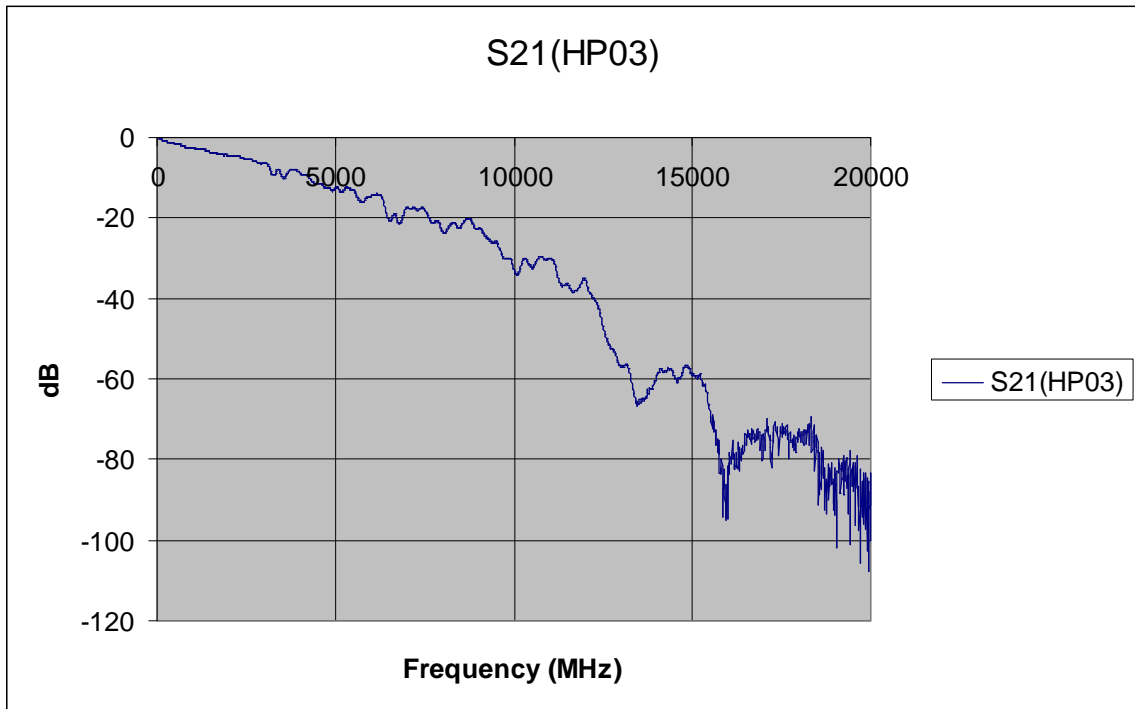

HP04_BtoB_3Connector:

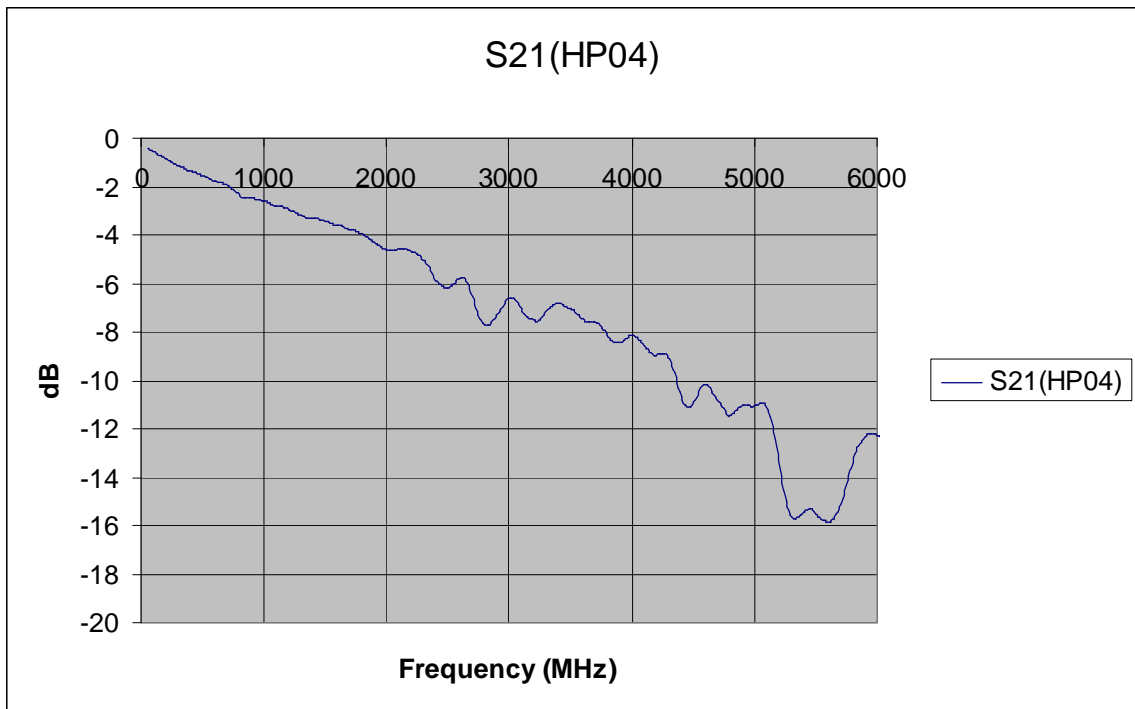
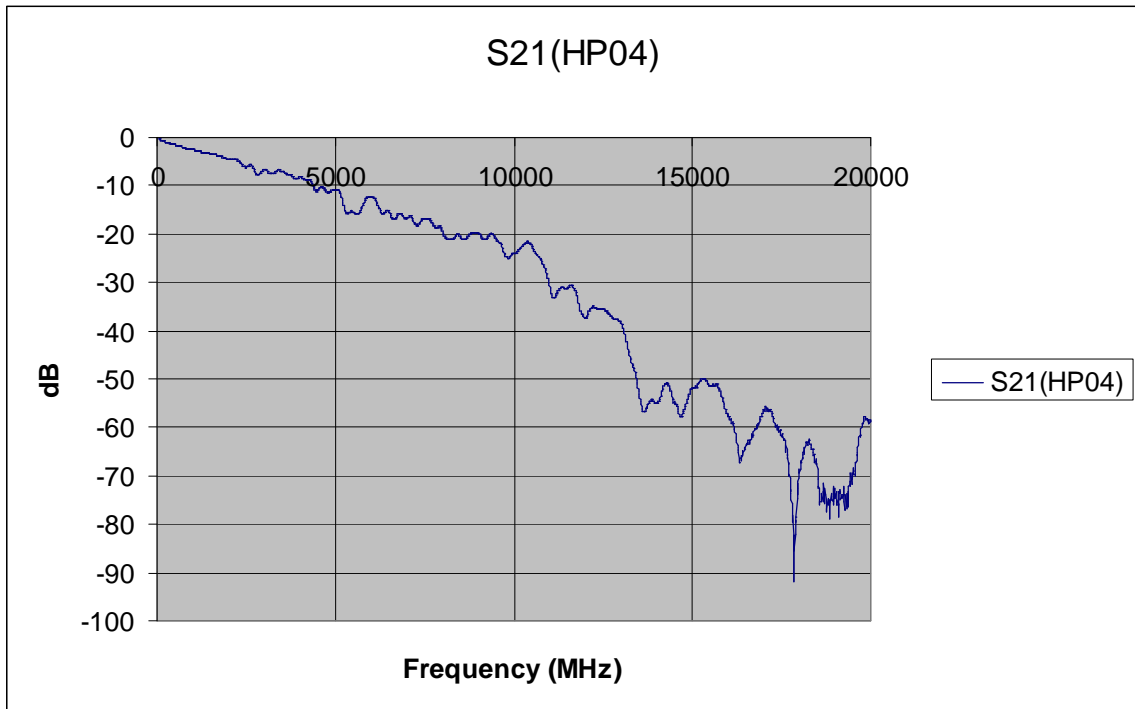

HP05_BtoB_3Connector:

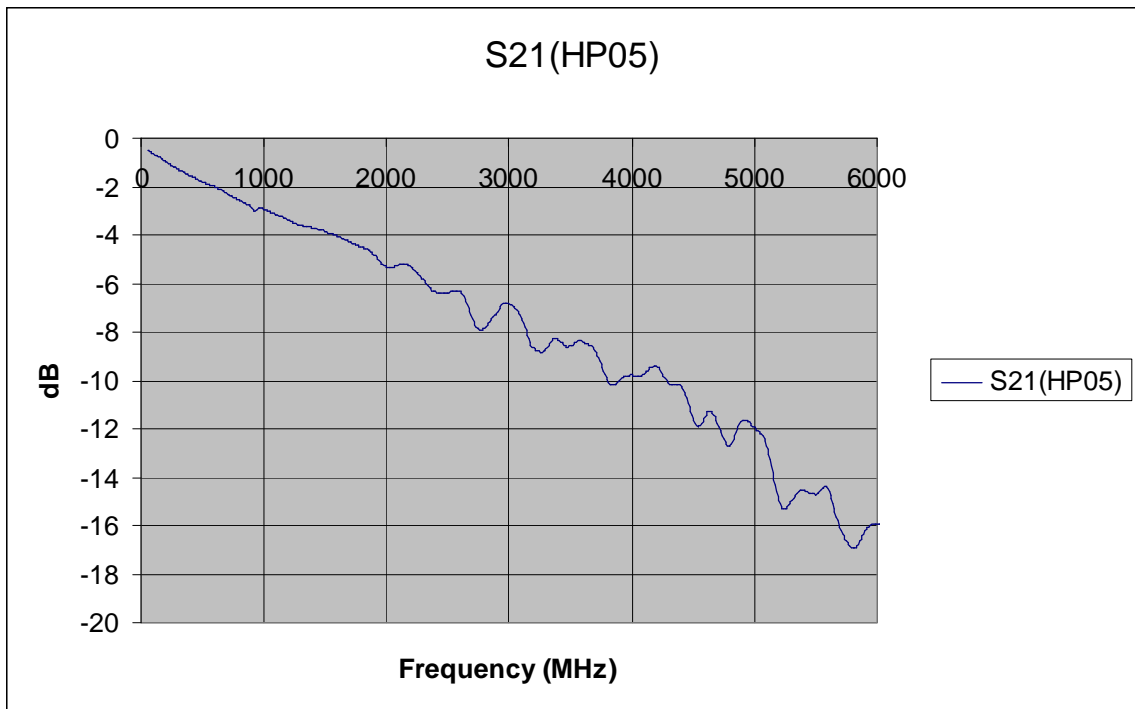
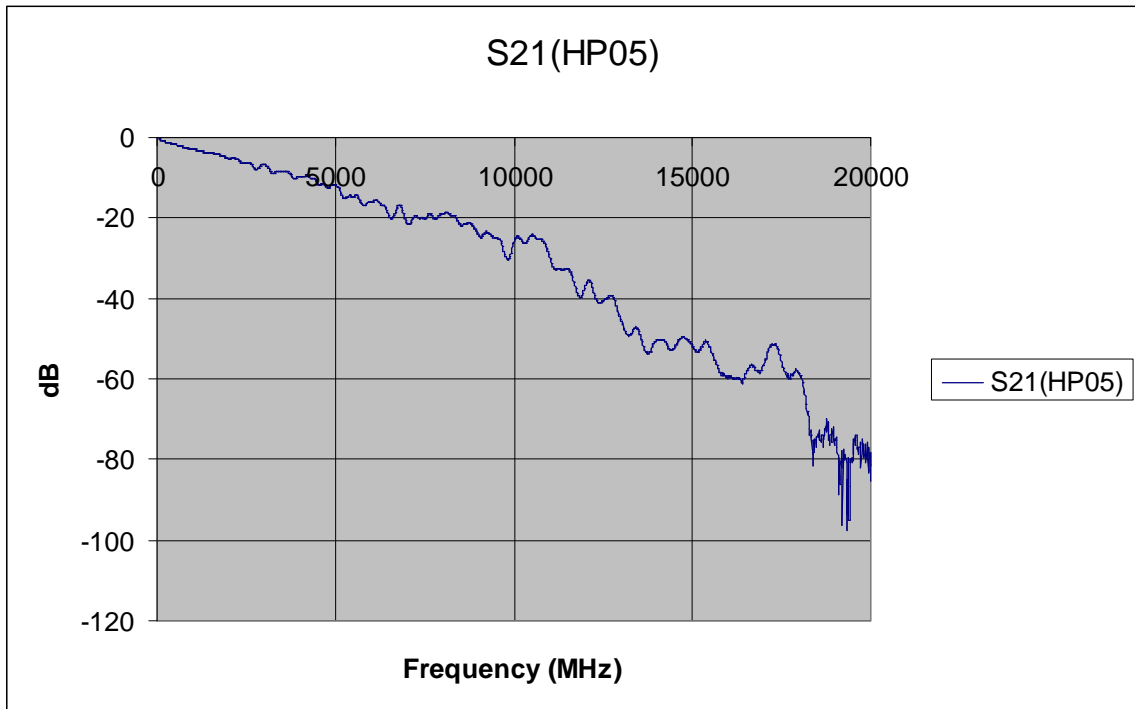

HP06_BtoB_3Connector:

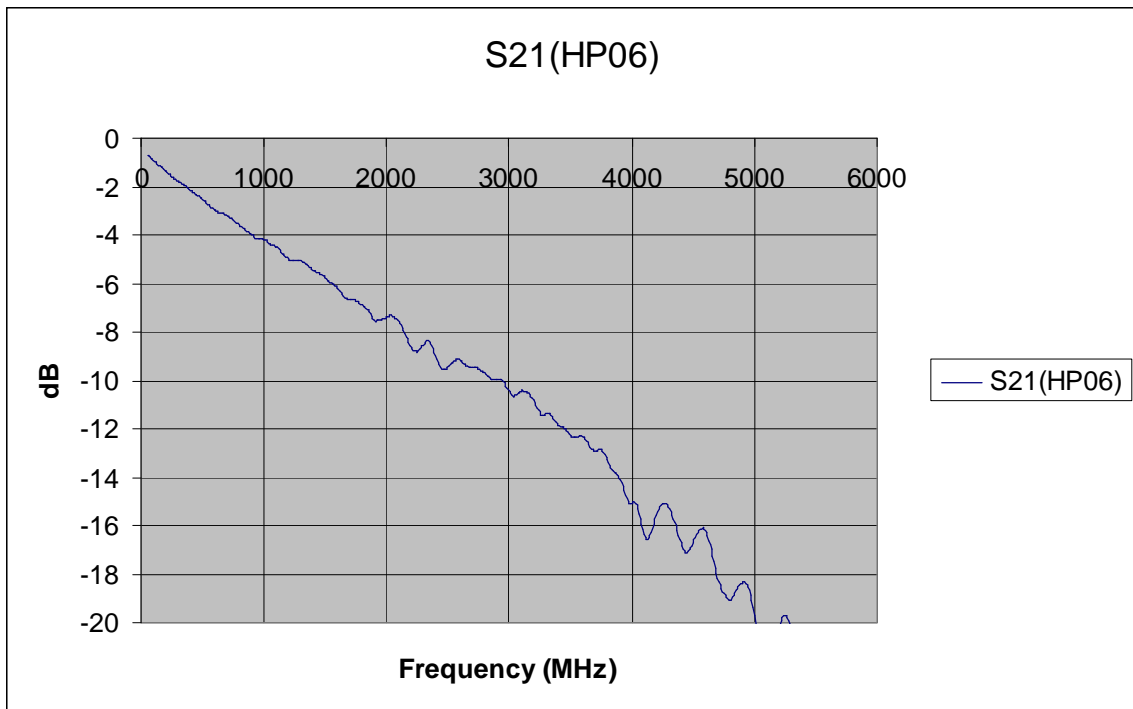
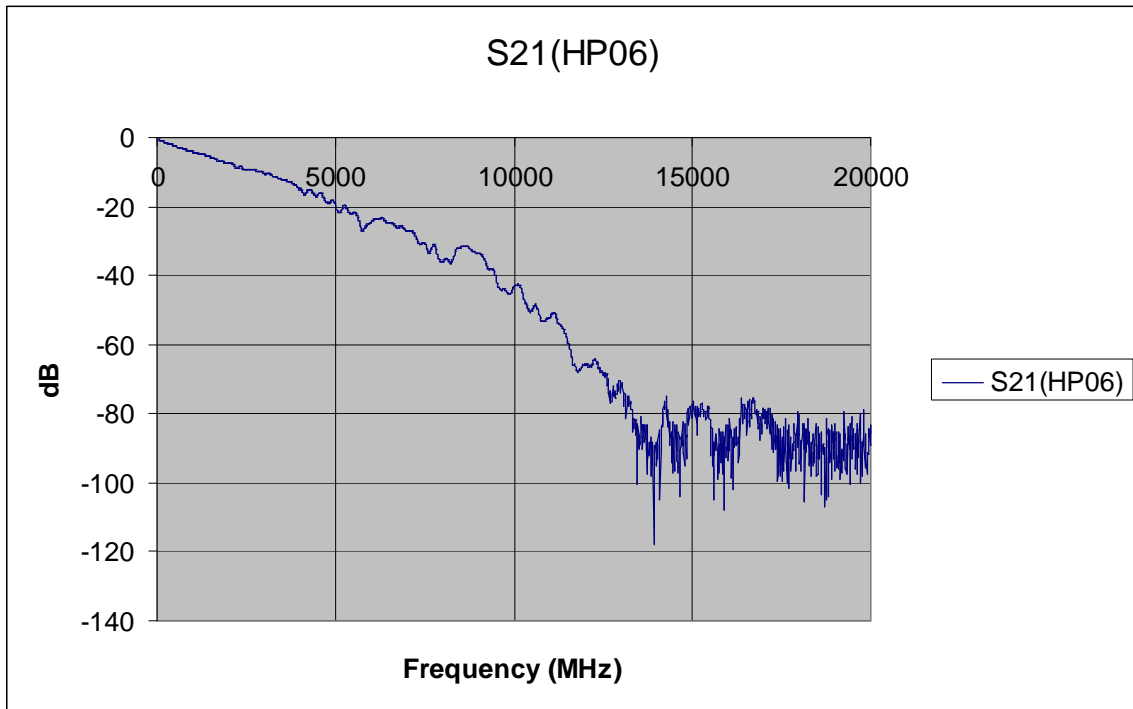

HP07_BtoB_3Connector:

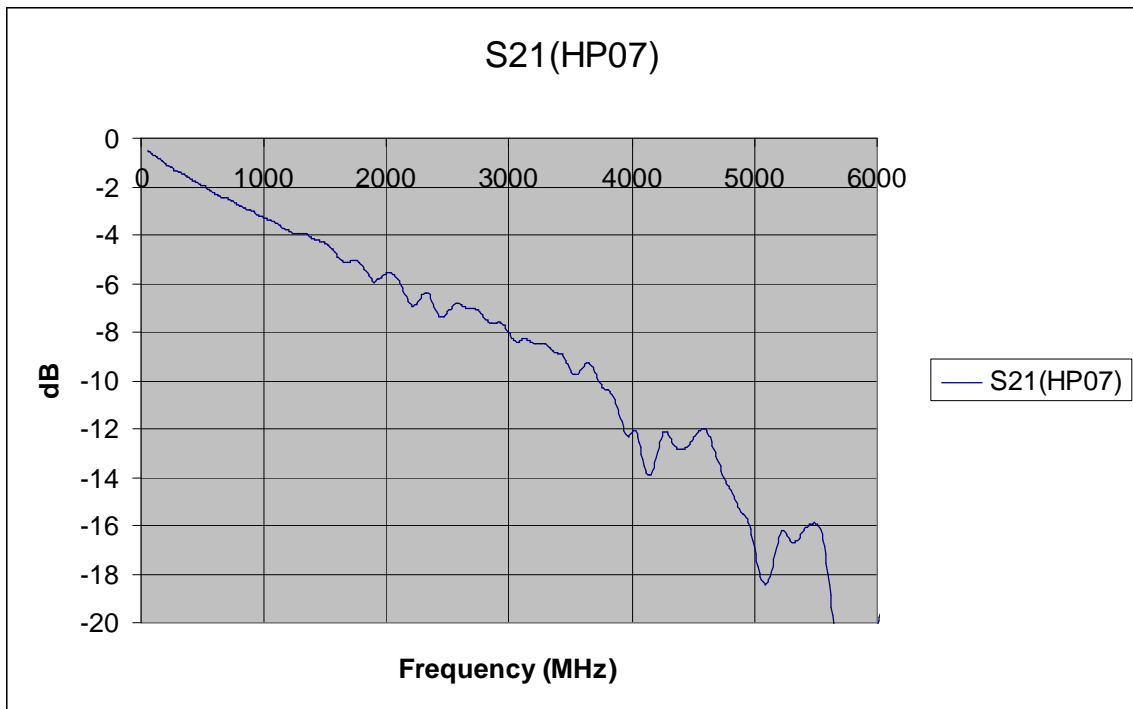
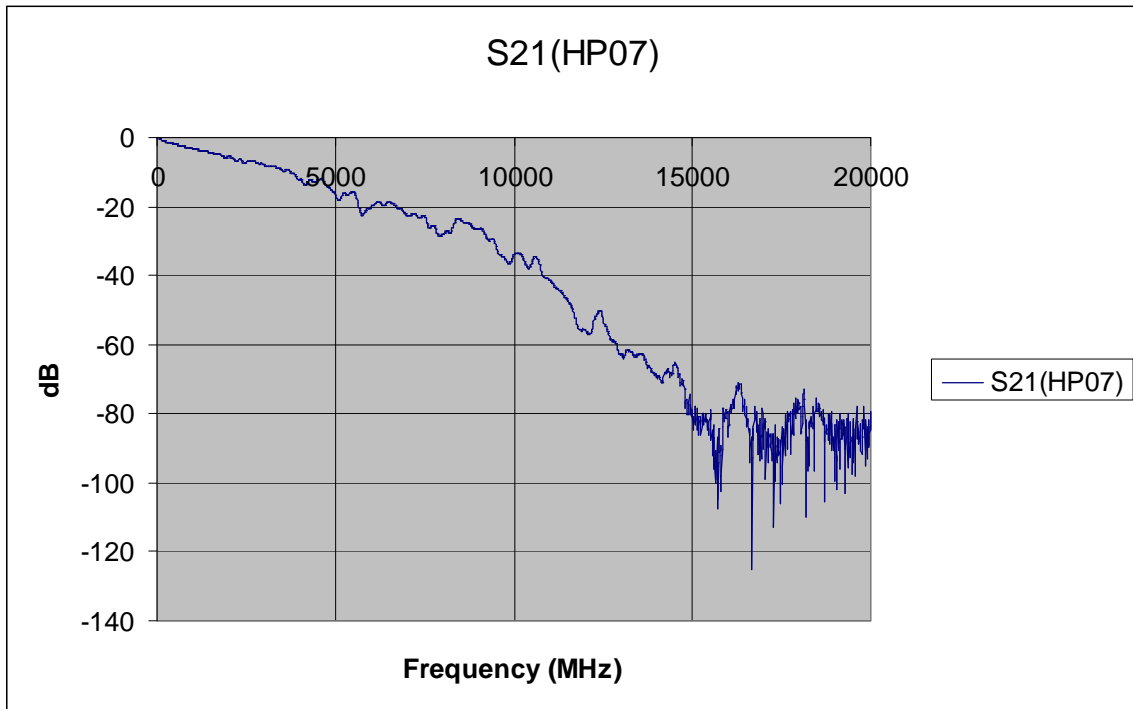

HP08_BtoB_3Connector:

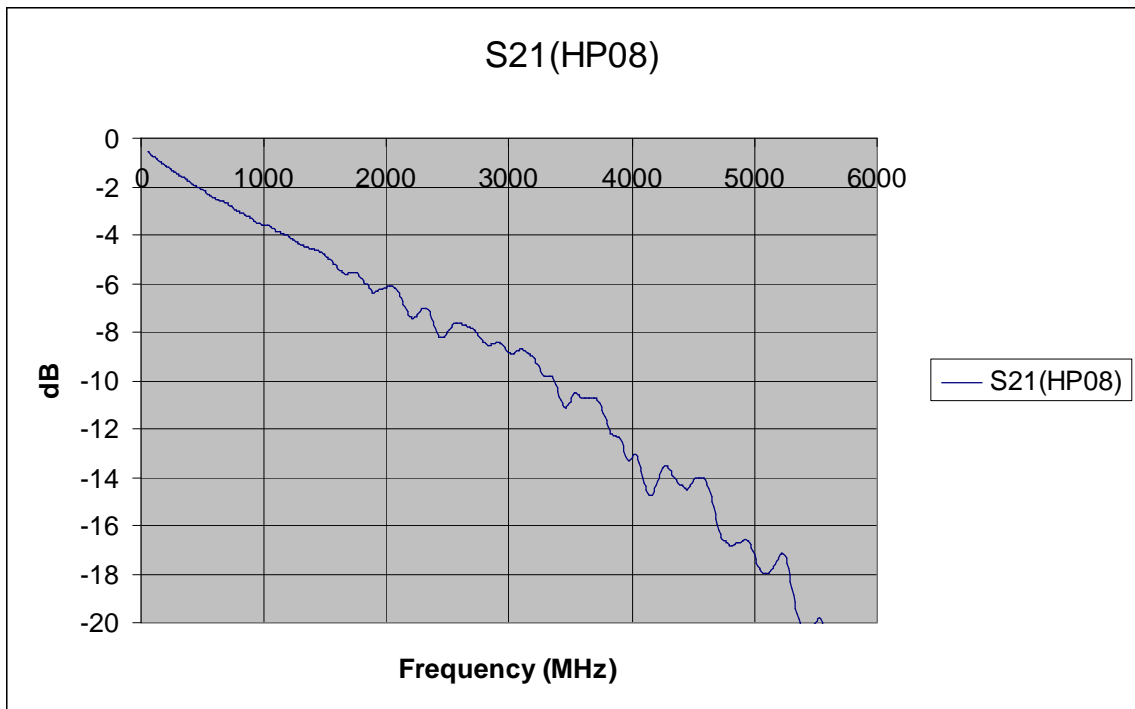
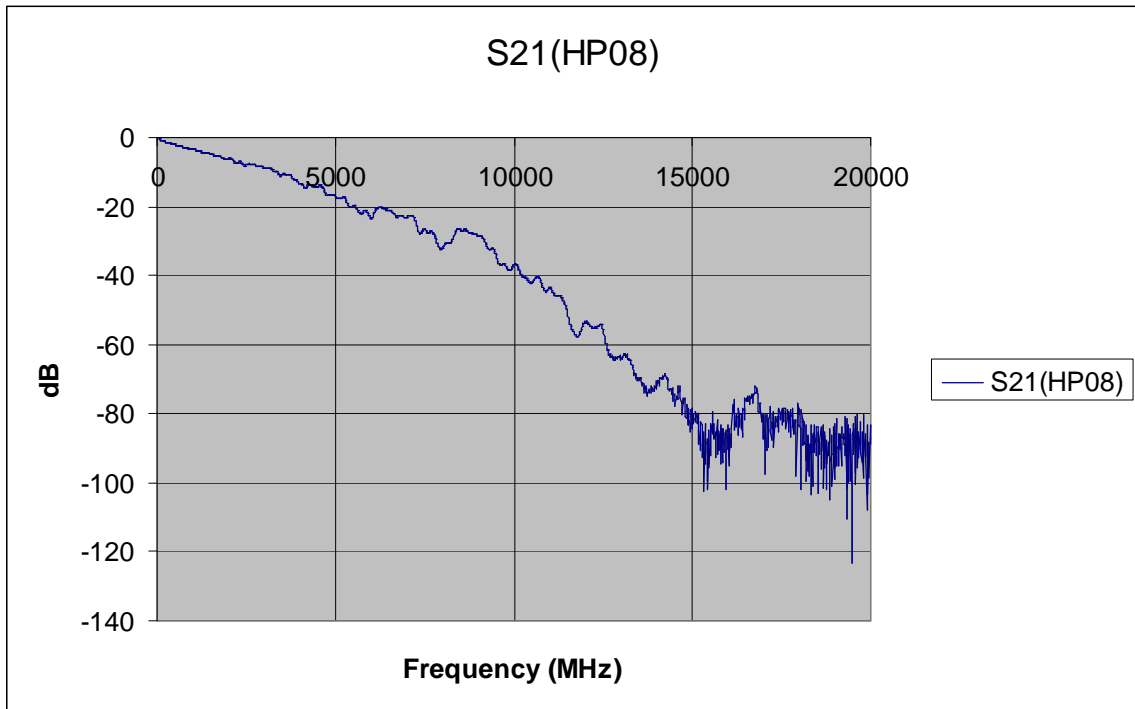

HP15_Xtalk_PF_GridArray_SameRow:

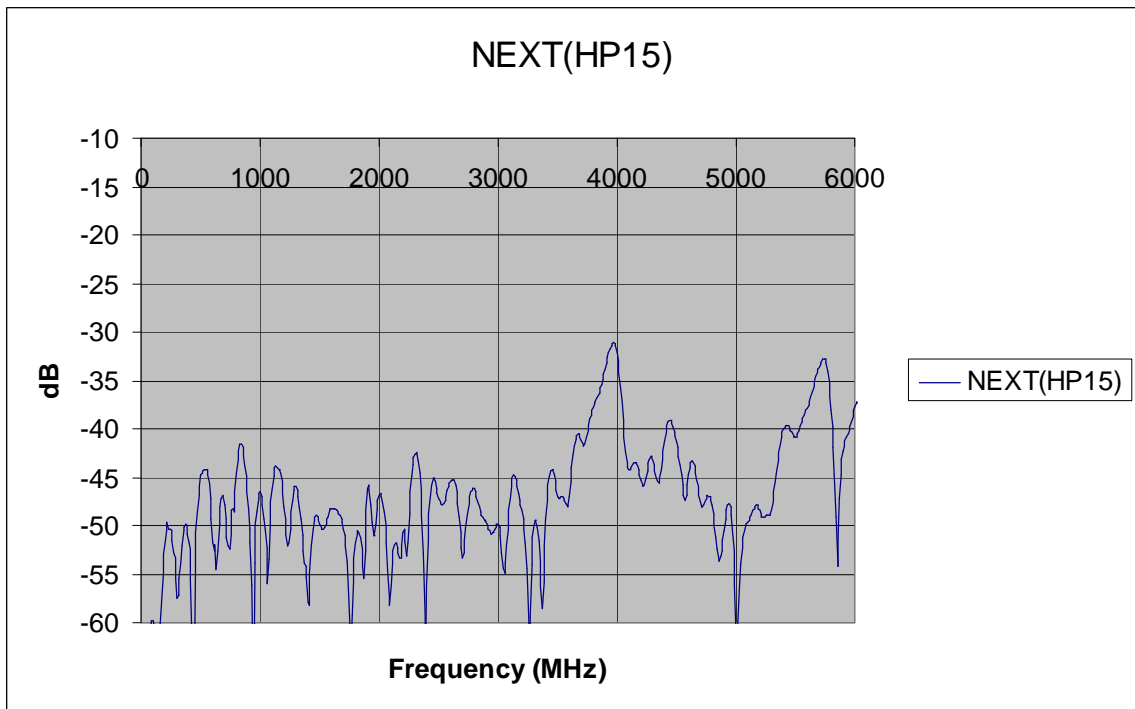
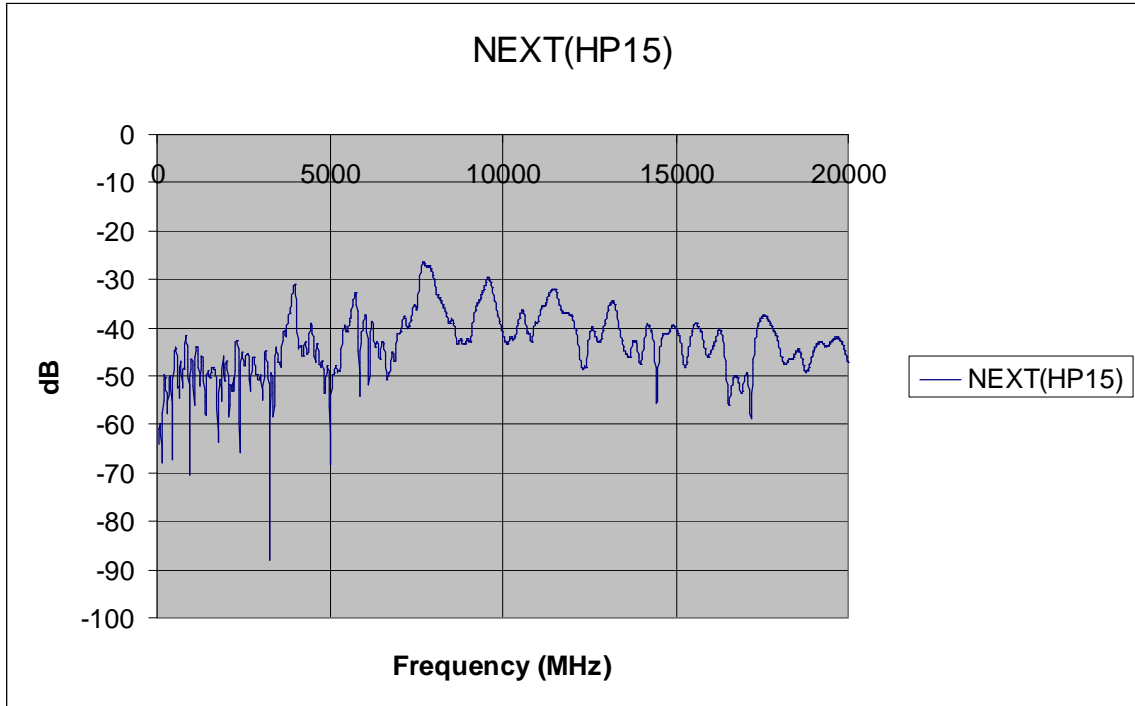

HP16_Xtalk_PF_GridArray_SameRow:

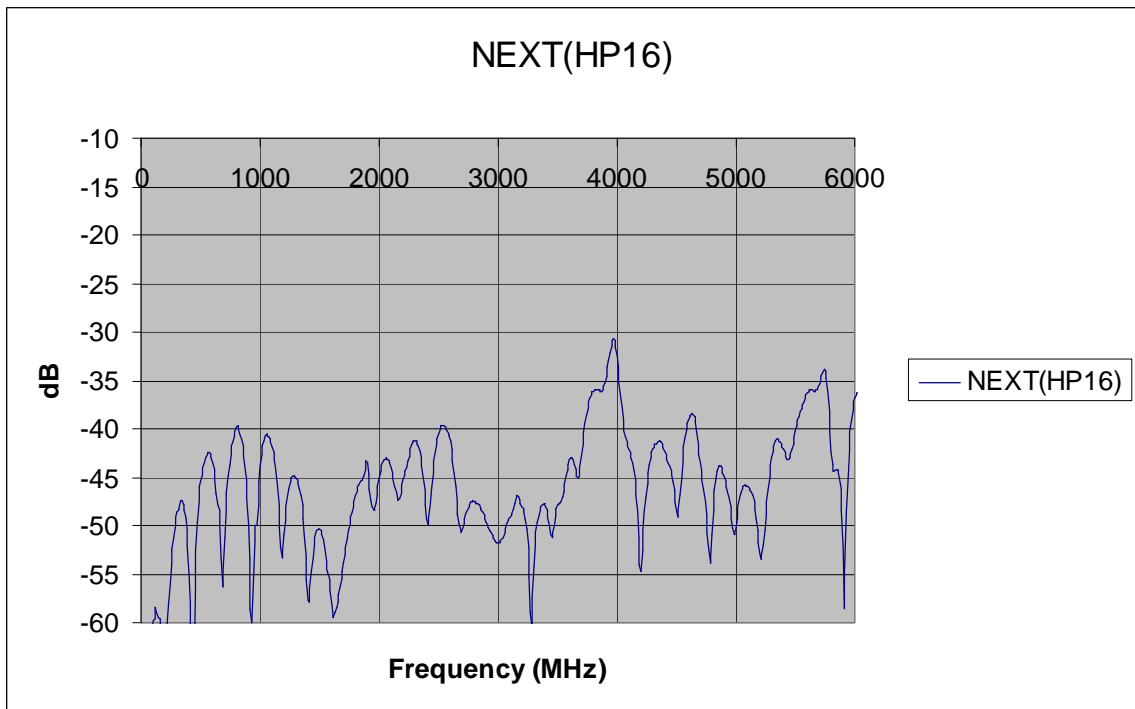
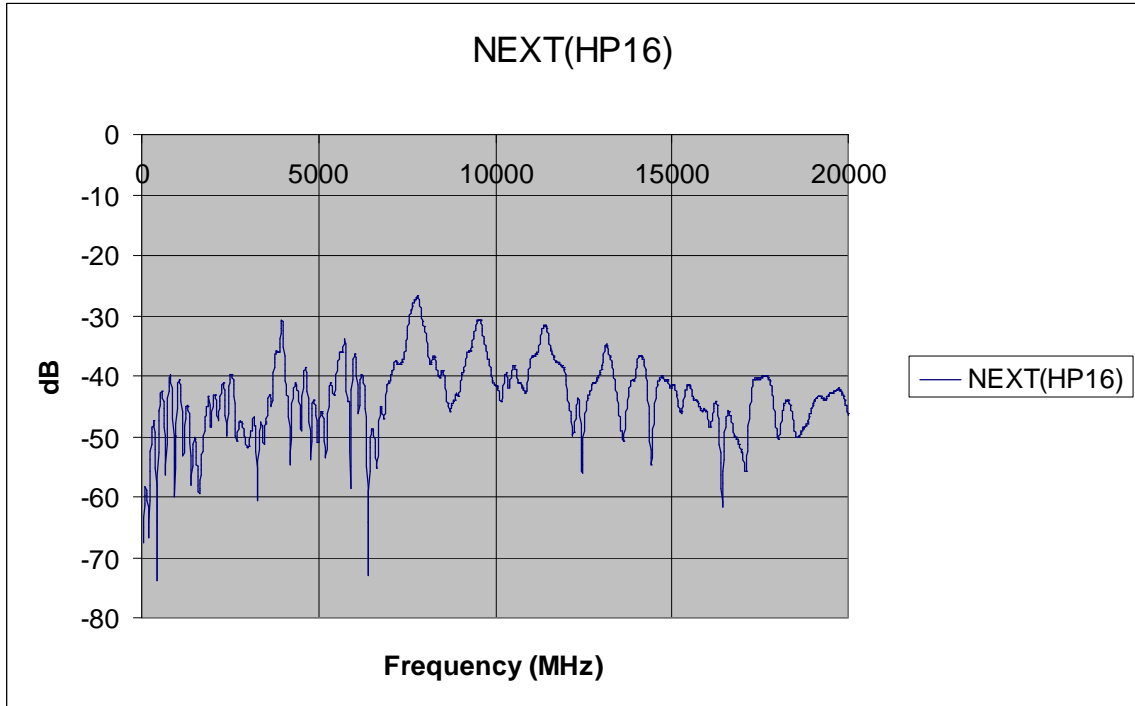

HP17 Xtalk PF GridArray AdjRow:

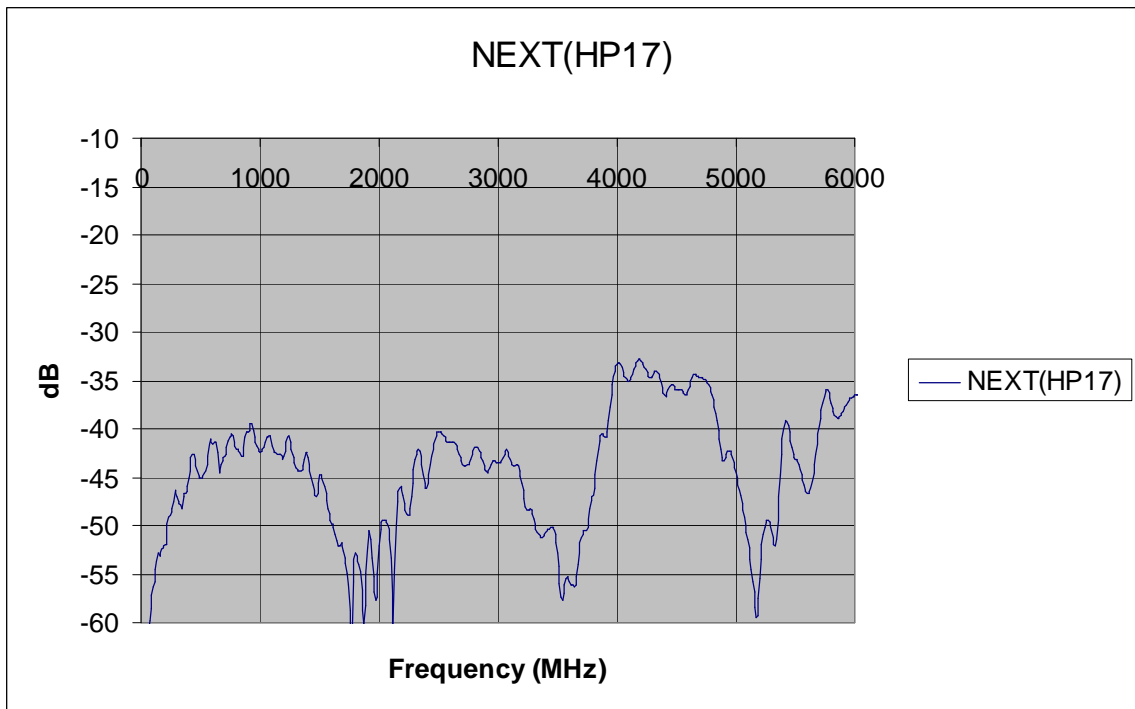
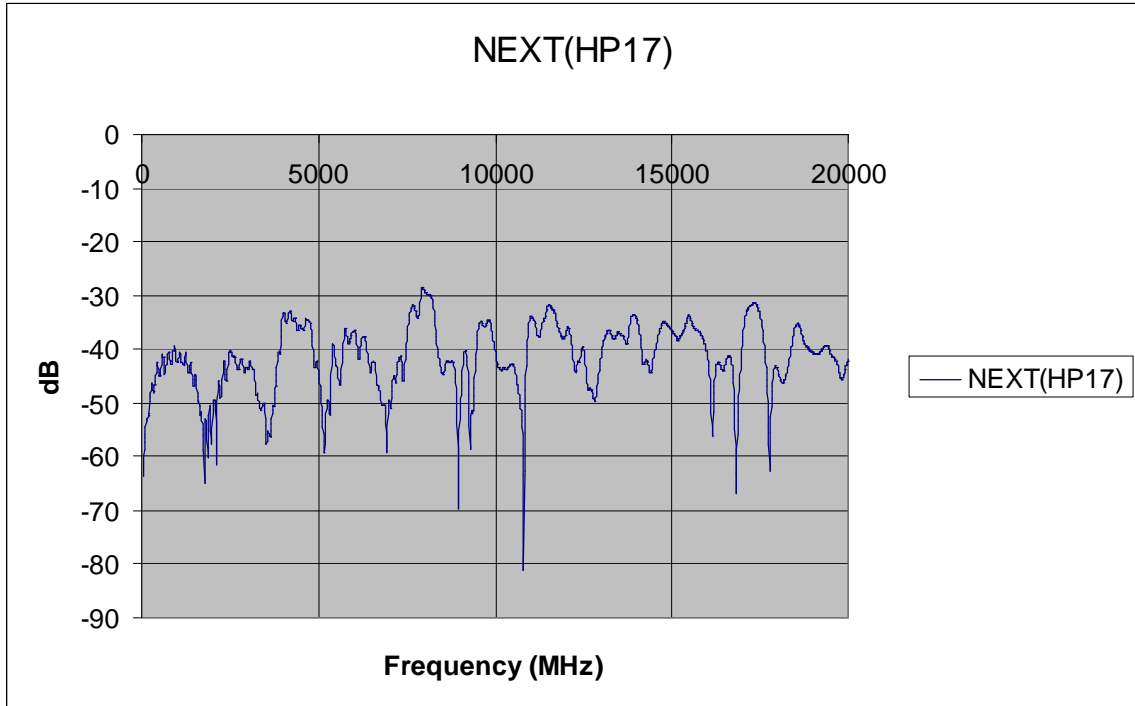

HP18_Xtalk_PF_GridArray_AdjRow:

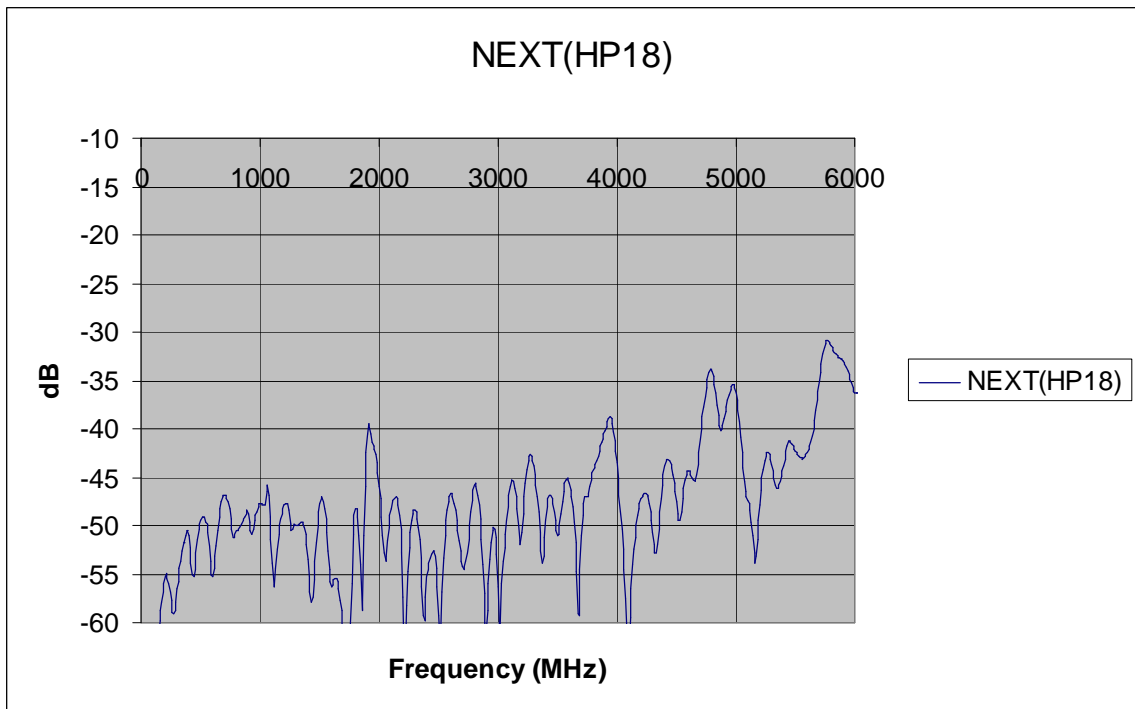
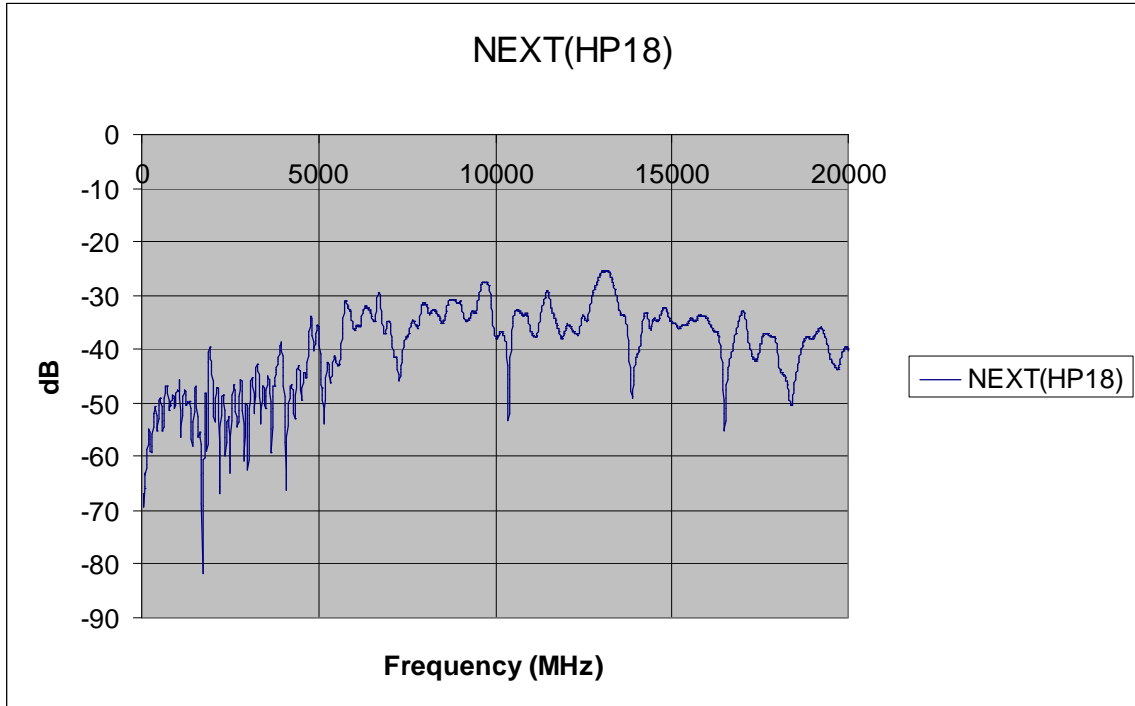

[HP19_Xtalk_SFF8482_Hyb:](#)

