

T10/05-085 revision 3

Date: May 19, 2005

To: T10 Committee (SCSI)

From: George Penokie (IBM/Tivoli)

Subject: T10 Style Guide

1 Overview

This document contains a major revision of the T10 Style Guide.

Information technology - Your Standards Title Here (YST)

This is an internal working document of T10, a Technical Committee of Accredited Standards Committee INCITS (InterNational Committee for Information Technology Standards). As such this is not a completed standard and has not been approved. The contents may be modified by the T10 Technical Committee. The contents are actively being modified by T10. This document is made available for review and comment only.

Permission is granted to members of INCITS, its technical committees, and their associated task groups to reproduce this document for the purposes of INCITS standardization activities without further permission, provided this notice is included. All other rights are reserved. Any duplication of this document for commercial or for-profit use is strictly prohibited.

T10 Technical Editor:

Your Name
Your Company Name
Address Line 1
Address Line 2
Address Line 3
USA

Telephone: xxx-xxx-xxxx
Facsimile: xxx-xxx-xxxx
Email: xxxxxx@xxxxxx

**Reference number
ISO/IEC xxxx-xxx:200x
ANSI INCITS. ***:200x**

Points of Contact

InterNational Committee for Information Technology Standards (INCITS) T10 Technical Committee

T10 Chair

John B. Lohmeyer
LSI Logic
4420 Arrows West Drive
Colorado Springs, CO 80907-3444
USA

Telephone: (719) 533-7560
Email: lohmeyer@t10.org

T10 Vice-Chair

George O. Penokie
IBM Corporation
MS: 2C6
3605 Highway 52 N
Rochester, MN 55901
USA

Telephone:(507) 253-5208
Email: gop@us.ibm.com

T10 Web Site: <http://www.t10.org>

T10 E-mail reflector:

Server: majordomo@t10.org

To subscribe send e-mail with "subscribe" in message body

To unsubscribe send e-mail with "unsubscribe" in message body

INCITS Secretariat

Suite 200
1250 Eye Street, NW
Washington, DC 20005
USA

Telephone: 202-737-8888
Web site: <http://www.incits.org>
Email: incits@itic.org

Information Technology Industry Council

Web site: <http://www.itic.org>

Document Distribution

INCITS Online Store
managed by Techstreet
1327 Jones Drive
Ann Arbor, MI 48105
USA

Web site: <http://www.techstreet.com/incits.html>
Telephone: (734) 302-7801 or (800) 699-9277

Global Engineering Documents, an IHS Company

15 Inverness Way East
Englewood, CO 80112-5704
USA

Web site: <http://global.ihs.com>
Telephone: (303) 397-7956 or (303) 792-2181 or (800) 854-7179

Draft

-Your Standards Title Here-

Secretariat
Information Technology Industry Council

Approved mm.dd.yy

American National Standards Institute, Inc.

ABSTRACT

This standard specifies something of interest, and here is where you give a brief description of that. This abstract should be confined to one or two short paragraphs.

Draft

American National Standard

Approval of an American National Standard requires verification by ANSI that the requirements for due process, consensus, and other criteria for approval have been met by the standards developer. Consensus is established when, in the judgment of the ANSI Board of Standards Review, substantial agreement has been reached by directly and materially affected interests. Substantial agreement means much more than a simple majority, but not necessarily unanimity. Consensus requires that all views and objections be considered, and that effort be made towards their resolution.

The use of American National Standards is completely voluntary; their existence does not in any respect preclude anyone, whether he has approved the standards or not, from manufacturing, marketing, purchasing, or using products, processes, or procedures not conforming to the standards.

The American National Standards Institute does not develop standards and will in no circumstances give interpretation on any American National Standard. Moreover, no person shall have the right or authority to issue an interpretation of an American National Standard in the name of the American National Standards Institute. Requests for interpretations should be addressed to the secretariat or sponsor whose name appears on the title page of this standard.

CAUTION NOTICE: This American National Standard may be revised or withdrawn at any time. The procedures of the American National Standards Institute require that action be taken periodically to reaffirm, revise, or withdraw this standard. Purchasers of American National Standards may receive current information on all standards by calling or writing the American National Standards Institute.

[The patent statement goes here.](#)

[If no patents have been disclosed place the statement in 5.5.2 shall be used.](#)

[If any patents have been disclosed place the statement in 5.5.3 shall be used.](#)

Published by

American National Standards Institute
11 W. 42nd Street, New York, New York 10036

Copyright © 2004 by Information Technology Industry Council (ITI).
All rights reserved.

No part of this publication may be reproduced in any form, in an electronic retrieval system or otherwise, without prior written permission of ITI, 1250 Eye Street NW, Suite 200, Washington, DC 20005.

Printed in the United States of America

Revision Information

R.1 Revision YSTr00 (dd month yyyy)

This is revision 0 of this working draft.

R.2 Revision YSTr01 (dd month yyyy)

The following T10 approved proposals were incorporated in YST in this revision:

- a) yy-xxxx - Proposal title
- b) yy-xxxx - Proposal title

No other changes were made in revision 1.

Contents

	Page
1 Scope	1
1.1 MY standards family	1
2 Normative References	3
2.1 Normative references	3
2.2 Approved references	3
2.3 References under development	3
2.4 Other references	3
3 Definitions, symbols, abbreviations, and conventions	4
3.1 Definitions	4
3.2 Symbols and abbreviations	5
3.3 Keywords	5
3.4 Editorial conventions	6
3.5 Numeric and character conventions	6
3.5.1 Numeric conventions	6
3.5.2 Byte encoded character strings conventions	7
3.5.3 Class diagram conventions	7
3.6 State machine conventions	13
3.6.1 State machine conventions overview	13
3.6.2 Transitions	14
3.6.3 Messages, requests, indications, confirmations, responses, and event notifications	14
3.6.4 State machine counters, timers, and variables	14
3.7 Bit and byte ordering	14
3.8 Notation conventions	15
3.8.1 Notation for procedure calls	15
4 General	17
5 Framemaker Working Draft Template Instruction	18
5.1 Introduction	18
5.2 Framemaker information	18
5.2.1 Master pages	18
5.2.2 Reference pages	18
5.2.3 Paragraph and font catalogs	19
5.2.4 Variables	19
5.3 Front matter	19
5.4 Revision history	19
5.5 ANSI cover	19
5.5.1 ANSI cover overview	19
5.5.2 Patent statement for ANSI cover if no patents disclosed	19
5.5.3 Patent statement for ANSI cover if patents have been disclosed	20
5.6 Table of contents (TOC), list of tables (LOT), and list of figures (LOF)	20
5.6.1 TOC, LOT, and LOF overview	20
5.6.2 Producer for setting up TOC, LOT, and LOF files	20
5.7 Forward and introduction	21
5.8 Body of draft	21
5.9 Annexes	22
5.10 Document preparation	22
5.10.1 PDF introduction	22
5.10.2 General	22
5.11 FrameMaker PDF Setup	22
6 General principles and structures	23

6.1 Consistency of draft standards	23
6.2 Description and numbering of divisions and subdivisions	23
6.2.1 Clause	23
6.2.2 Subclause	23
6.2.3 Definitions subclause construction	23
6.2.4 Paragraph	24
6.2.5 Lists	25
6.2.5.1 Lists overview	25
6.2.5.2 Unordered lists	25
6.2.5.3 Ordered lists	25
6.2.6 Programing source code	25
6.2.7 Annex	26
6.2.7.1 Annex overview	26
6.2.7.2 Normative annexes	26
6.2.7.3 Informative annexes	26
6.3 Notes, examples, and footnotes	26
6.3.1 Notes and examples in text	26
6.3.2 Footnotes to the text	27
6.4 Verbal forms	27
6.4.1 Verbal forms for the expression of provisions	27
6.4.2 Other recommended verbal form expressions	30
6.4.2.1 Arabic numerals	30
6.4.2.2 For example	30
6.4.2.3 Such as	30
6.4.2.4 If/then vs. when	30
6.4.2.5 Specify vs. indicate	30
6.4.2.6 Which vs. that	30
6.4.2.7 Single quotes vs. double quotes	30
6.4.3 Prohibited verbal forms	31
6.4.4 Spelling, reference works, and abbreviated terms	31
6.4.5 Use of trade names	31
6.5 Figures	32
6.5.1 Usage	32
6.5.2 Form	32
6.5.3 Designation	32
6.5.4 Layout of figure designation and title	32
6.5.5 Continuation of figures	32
6.5.6 Keys in figures	32
6.5.7 Notes in figures	32
6.5.8 Footnotes in figures	33
6.6 Tables	33
6.6.1 Usage	33
6.6.2 Form	34
6.6.3 Designation	34
6.6.4 Layout of table designation and title	34
6.6.5 Headings	35
6.6.6 Continuation of tables	35
6.6.7 Keys in tables	35
6.6.8 Notes in tables	35
6.6.9 Footnotes in tables	35
6.7 References	36
6.7.1 General	36
6.7.2 References to the draft standard as a whole in its own text	36
6.7.3 References to elements of text	36
6.7.4 References to figures and tables	37
6.7.5 References to other documents	37
6.7.5.1 General	37

6.7.5.2 References	37
6.8 Representation of numbers and numerical values	37
6.9 Quantities, units, symbols and signs	38
6.10 Mathematical formulae	38
6.10.1 Types of equation	38
6.10.2 Presentation	40
6.10.3 Numbering	40
6.11 Values, dimensions and tolerances	41
Annex A (Informative) Elements of this template	42
A.1 Paragraph formats	42
A.1.1 Character formats	44
A.1.2 Fonts	45
A.2 Variables	45
A.2.1 Standard variables	45
A.2.2 Draft standard variables	46
A.3 Cross reference formats	46
A.4 Table formats	47
A.5 Master pages	47
Annex B (Informational) SCSI CDB and Data Structure Examples	49
B.1 Example of a 6 byte CDB format	49
B.3 Ten byte CDB	50
B.2 Example data structure	50
B.4 Twelve byte data structure	51
B.5 Sixteen byte CDB example	51
Annex C (Normative) Quantities and units	53

Tables

	Page
1 ISO and American numbering conventions examples	7
2 Multiplicity notation	9
3 Data dword containing a value	15
4 Data dword containing four one-byte fields	15
5 Hanging paragraph example	24
6 Requirement	28
7 Recommendations	28
8 Permission	29
9 Possibility and capability	29
10 Miscellaneous	29
11 No row ruling table example	34
12 Row ruling table example	34
13 Mechanical properties	34
14 Table title (part 1 of 2)	35
15 Table with notes and footnotes	36
A.1 Draft standard paragraph formats	42
A.2 Draft standard character formats	45
A.3 Draft standard fonts	45
A.4 FrameMaker variables modified for draft standards	45
A.5 Draft standard variables	46
A.6 Draft standard cross reference formats	46
A.7 Draft standard table formats	47
A.8 Draft standard master page	48
B.1 Example 6 byte CDB	49
B.2 Example data structure	50
B.3 Ten byte CDB example	51
B.4 Parameter data for the COPY STATUS service action	51
B.5 Sixteen byte CDB example	52

Figures

	Page
1 MY document structure	2
2 Class diagram conventions	8
3 Object diagram conventions	9
4 Notation for association relationships for class diagrams	10
5 Notation for aggregation relationships for class diagrams	11
6 Notation for generalization relationships for class diagrams	12
7 Notation for dependency relationships for class diagrams	12
8 State machine conventions	13
9 Details of apparatus	32
10 Details of apparatus (part 1 of 2)	32
11 Blind rivet	33

Foreword

This foreword is not part of American National Standard INCITS.***:200x.

Editor's Note 1: Place a short description of the standard or technical report here. Should not be more than two or three paragraphs in length. For example: The purpose of this standard is to provide a basis for the coordination of SCSI standards development and to define requirements, common to all SCSI technologies and implementations, that are essential for compatibility with host SCSI application software and device-resident firmware across all SCSI transport protocols. These requirements are defined through a reference model that specifies the behavior and abstract structure that is generic to all SCSI I/O system implementations.

With any technical document there may arise questions of interpretation as new products are implemented. INCITS has established procedures to issue technical opinions concerning the standards developed by INCITS. These procedures may result in SCSI Technical Information Bulletins being published by INCITS.

These Bulletins, while reflecting the opinion of the Technical Committee that developed the standard, are intended solely as supplementary information to other users of the standard. This standard, ANSI INCITS.***:200x, as approved through the publication and voting procedures of the American National Standards Institute, is not altered by these bulletins. Any subsequent revision to this standard may or may not reflect the contents of these Technical Information Bulletins.

Current INCITS practice is to make Technical Information Bulletins available through:

INCITS Online Store	http://www.techstreet.com/INCITS.html
managed by Techstreet	Telephone: 1-734-302-7801 or
1327 Jones Drive	1-800-699-9277
Ann Arbor, MI 48105	Facsimile: 1-734-302-7811

or

Global Engineering	http://global.ihs.com/
15 Inverness Way East	Telephone: 1-303-792-2181 or
Englewood, CO 80112-5704	1-800-854-7179
	Facsimile: 1-303-792-2192

Requests for interpretation, suggestions for improvement and addenda, or defect reports are welcome. They should be sent to the INCITS Secretariat, National Committee for Information Technology Standards, Information Technology Institute, 1250 Eye Street, NW, Suite 200, Washington, DC 20005- 3922.

This standard was processed and approved for submittal to ANSI by the InterNational Committee for Information Technology Standards (INCITS). Committee approval of the standard does not necessarily imply that all committee members voted for approval. At the time of it approved this standard, INCITS had the following members:

<<Insert INCITS member list>>

The INCITS Technical Committee T10 on SCSI Storage Interfaces, that reviewed this standard, had the following members:

Introduction

The -Your Standards Title Here- standard is divided into the following clauses and annexes:

- Clause 1 is the scope.
- Clause 2 enumerates the normative references that apply to this standard.
- Clause 3 describes the definitions, symbols, and abbreviations used in this standard.
- Clause 4 describes a model of whatever this standard standardizes.

Clause 5 describes or defines some aspect of this standard.

.....

Clause n describes or defines some aspect of this standard.

Annex A describes or defines some aspect of this standard that assists with implementation of this standard.

.....

Editor's Note 2: The number and types of clauses and annexes depends on the content of this draft standard and you would fill out this clause with the appropriate information.

Editor's Note 3: There are two types of annex: Informative is not allowed to define any requirements and normative that may define requirements.

American National Standard for Information Technology -

Your Standards Title Here (YST)

1 Scope

Editor's Note 4: This clause contains a brief description of what this draft standard covers and how it relates to other standards within the scope of this draft standard. The example below is intended to show the type of information you might want in your draft standard and may be edited or replaced.

This standard defines the mechanical, electrical, timing, and protocol requirements of the Moonbeam-42 interface to allow conforming MY devices to inter-operate. The Moonbeam-42 interface is local to this solar system and may be operated over a wide range of transfer rates. The objectives of the Moonbeam-42 interface are:

- a) To provide host computers with device independence within a class of devices. Thus, different disk drives, tape drives, printers, optical media drives, and other MY devices may be added to the host computers without requiring modifications to generic system hardware. Provision is made for the addition of special features and functions through the use of vendor-specific options. Reserved areas are provided for future standardization.
- b) To provide compatibility such that conforming devices may interoperate with Moonbeam devices given that the systems engineering is correctly done. Conforming devices should respond in an acceptable manner to reject Moonbeam-42 protocol extensions. Moonbeam-42 protocol extensions are designed to be permissive of such rejections and thus allow conforming devices to continue operation without requiring the use of the extensions.

The interface protocol includes provision for the connection of multiple MY ports (i.e., MY devices capable of initiating an I/O process) and multiple MY ports (i.e., MY devices capable of responding to a request to perform an I/O process). Distributed arbitration (i.e., Moonbeam contention logic) is built into the architecture of this standard. A default priority system awards interface control to the highest priority MY device that is contending for use of the Moonbeam and an optional fairness algorithm is defined.

This standard defines the physical attributes of an input/output Moonbeam for interconnecting computers and peripheral devices.

A set of MY standards specifies the interfaces, functions, and operations necessary to ensure interoperability between conforming MY implementations. This standard is a functional description. Conforming implementations may employ any design technique that does not violate interoperability.

This standard has made obsolete the following:

- a) The special function that no one uses.

1.1 MY standards family

Figure 1 shows the relationship of this standard to the other standards and related projects in the MY family of standards as of the publication of this standard.

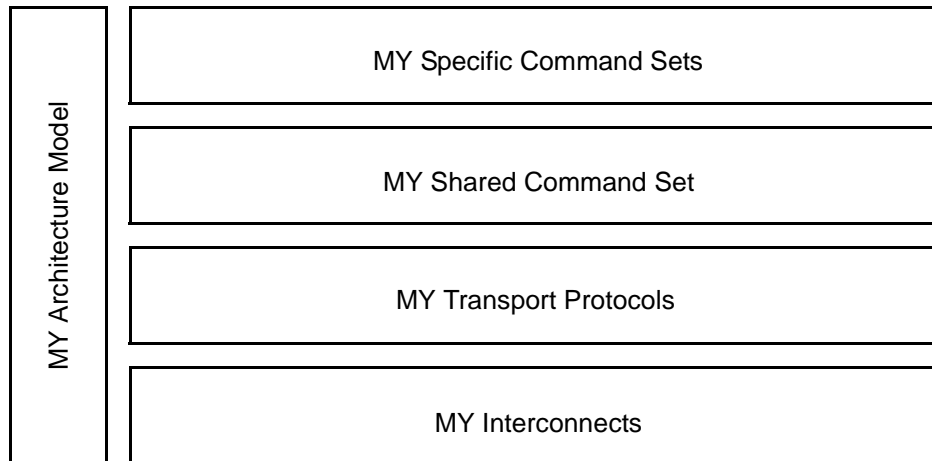

Figure 1 — MY document structure

The roadmap in figure 1 is intended to show the general applicability of the documents to one another. Figure 1 is not intended to imply a relationship such as a hierarchy, protocol stack, or system architecture.

The functional areas identified in figure 1 characterize the scope of standards within a group as follows:

Architecture Model: Defines the MY systems model, the functional partitioning of the MY standard set and requirements applicable to all MY implementations and implementation standards.

Device-Type Specific Command Sets: Implementation standards that define specific device types including a device model for each device type. These standards specify the required commands and behavior that is specific to a given device type and prescribe the requirements to be followed by a MY transmitting device when sending commands to MY receiving device having the specific device type. The commands and behaviors for a specific device type may include by reference commands and behaviors that are shared by all MY devices.

Shared Command Set: An implementation standard that defines a model for all MY device types. This standard specifies the required commands and behavior that is common to all MY devices, regardless of device type, and prescribes the requirements to be followed by a MY transmitting device when sending commands to any MY receiving device.

MY Transport Protocols: Implementation standards that define the requirements for exchanging information so that different MY devices are capable of communicating.

Interconnects: Implementation standards that define the communications mechanism employed by the MY transport protocols. These standards may describe the electrical and signaling requirements essential for MY devices to interoperate over a given interconnect. Interconnect standards may allow the interconnection of devices other than MY devices in ways that are outside the scope of this standard.

The term MY is used to refer to the family of standards described in this subclause.

Editor's Note 5: How much of the example Scope you use is up to you but Figure 1 or equivalent should remain.

2 Normative References

Editor's Note 6: This clause contains a list of other standards whose requirements are incorporated in this standard by reference. This may include approved references, references in the development process, or others. The references list in this clause are examples to show the format of the entries and should be changed as appropriate. It is allowed, but not preferred, that standards have the contact information in the subclause to which they apply.

2.1 Normative references

The following standards contain provisions that, by reference in the text, constitute provisions of this standard. At the time of publication, the editions indicated were valid. All standards are subject to revision, and parties to agreements based on this standard are encouraged to investigate the possibility of applying the most recent editions of the standards listed below.

Copies of the following documents may be obtained from ANSI: approved ANSI standards, approved and draft international and regional standards (ISO, IEC, CEN/CENELEC, ITUT), and approved and draft foreign standards (including BSI, JIS, and DIN). For further information, contact ANSI Customer Service Department at 212-642-4900 (phone), 212-302-1286 (fax) or via the World Wide Web at <http://www.ansi.org>.

Additional availability contact information is provided below as needed.

2.2 Approved references

ISO/IEC 14776-452, *SCSI Primary Commands - 2 (SPC-2)* [ANSI INCITS.351-2001]

ISO/IEC 60027-2-am2, (1999-01) *Letter symbols to be used in electrical technology - Part 2: Telecommunications and electronics (Amendment 2)*

2.3 References under development

At the time of publication, the following referenced standards were still under development. For information on the current status of the document, or regarding availability, contact the relevant standards body or other organization as indicated.

ISO/IEC 14776-453, *SCSI Primary Commands - 3 (SPC-3)* [T10/1416-D]

ISO/IEC 14776-322, *SCSI Block Commands - 2 (SBC-2)* [T10/1417-D]

2.4 Other references

For information on the current status of the listed document(s), or regarding availability, contact the indicated organization.

SFF-8451, *SCA-2 Unshielded Connections*

NOTE 1 - For more information on the current status of the document, contact the SFF committee at 408-867-6630 (phone), or 408-867-2115 (fax). To obtain copies of this document, contact the SFF committee at 14426 Black Walnut Court, Saratoga, CA 95070 at 408-867-6630 (phone) or 408-741-1600 (fax).

3 Definitions, symbols, abbreviations, and conventions

3.1 Definitions

Editor's Note 7: Clause 3.1 is an example of what you may want in your definitions list. Edit as appropriate.

3.1.1 aggregation: When used in class diagrams, a form of association that defines a whole-part relationship between the whole (i.e., aggregate) and its parts.

3.1.2 association: When used in class diagrams a relationship between two or more classes that specifies connections among their objects (i.e., relationship that specifies that objects of one class are connected to objects of another class).

3.1.3 attribute: When used in class diagrams, a named property of a class that describes the range of values that the class or its objects may hold. When used in object diagrams, a named property of an instance of a class.

3.1.4 byte: Indicates an 8-bit construct.

3.1.5 constraint: When used in class diagrams and object diagrams, a mechanism for specifying semantics or conditions that are maintained as true between entities (e.g., a required condition between associations).

3.1.6 class: A description of a set of objects that share the same attributes, operations, relationships, and semantics. Classes may have attributes and may support operations.

3.1.7 cyclic redundancy check (CRC): An error checking mechanism that checks data integrity by computing a polynomial algorithm based checksum.

3.1.8 field: A group of one or more contiguous bits.

3.1.9 generalization: When used in class diagrams, a relationship among classes where one class (i.e., super-class) shares the attributes and/or operations on one or more classes (i.e., subclasses).

3.1.10 multiplicity: When used in class diagrams, an indication of the range of allowable instances that a class or an attribute may have.

3.1.11 object: An entity with a well-defined boundary and identity that encapsulates state and behavior. All objects are instances of classes (i.e., a concrete manifestation of a class is an object).

3.1.12 operation: When used in class diagrams, a service that may be requested from any object of the class in order to effect behavior. Operations describe what a class is allowed to do and may be a request or a question. A request may change the state of the object but a question should not.

3.1.13 role: When used in class diagrams and object diagrams, a label at the end of an association or aggregation that defines a relationship to the class on the other side of the association or aggregation.

3.1.14 vendor-specific: Something (e.g., a bit, field, code value) that is not defined by this standard and may be used differently in various implementations.

3.2 Symbols and abbreviations

Abbreviation	Meaning
XOR	exclusive logical OR
^	exclusive logical OR
x	multiplication
/	division
≠ or NE	not equal
≤ or LE	less than or equal to
±	plus or minus
≈	approximately
x	multiply
+	add
-	subtract
< or LT	less than
= or EQ	equal
> or GT	greater than
≥ or GE	greater than or equal to
AWG	American wire gauge
CRC	Cyclic Redundancy Check (see 3.1.7)
DUT	Device under test
EMI	Electromagnetic interference
EMC	Electromagnetic compatibility
ESD	Electrostatic discharge
ISI	Intersymbol interference
LSB	Least significant bit
LUN	Logical unit number
MSB	Most significant bit
SBC-2	SCSI Block Commands-2 (see 2.3)
SPC-3	SCSI Primary Commands-3 (see 2.3)

3.3 Keywords

Editor's Note 8: Changes in the keyword definitions or the addition of keywords requires a specific vote by the organization responsible for approving the draft standard (e.g., T10, T11).

3.3.1 invalid: A keyword used to describe an illegal or unsupported bit, byte, word, field or code value. Receipt by a device server of an invalid bit, byte, word, field or code value shall be reported as error.

3.3.2 mandatory: A keyword indicating an item that is required to be implemented as defined in this standard.

3.3.3 may: A keyword that indicates flexibility of choice with no implied preference.

3.3.4 may not: A keyword that indicates flexibility of choice with no implied preference.

3.3.5 obsolete: A keyword indicating that an item was defined in prior SCSI standards but has been removed from this standard.

3.3.6 option, optional: Keywords that describe features that are not required to be implemented by this standard. However, if any optional feature defined by this standard is implemented, then it shall be implemented as defined in this standard.

3.3.7 reserved: A keyword referring to bits, bytes, words, fields, and code values that are set aside for future standardization. A reserved bit, byte, word, or field shall be set to zero, or in accordance with a future extension to this standard. Recipients are not required to check reserved bits, bytes, words, or fields for zero values. Receipt of reserved code values in defined fields shall be reported as error.

3.3.8 shall: A keyword indicating a mandatory requirement. Designers are required to implement all such mandatory requirements to ensure interoperability with other products that conform to this standard.

3.3.9 should: A keyword indicating flexibility of choice with a strongly preferred alternative.

3.3.10 vendor specific: Specification of the referenced item is determined by the SCSI device vendor.

3.4 Editorial conventions

Certain words and terms used in this standard have a specific meaning beyond the normal English meaning. These words and terms are defined either in the glossary or in the text where they first appear.

Upper case is used when referring to the name of a numeric value defined in this specification or a formal attribute possessed by an entity. When necessary for clarity, names of objects, procedure calls, arguments or discrete states are capitalized or set in bold type. Names of fields are identified using small capital letters (e.g., NACA bit).

Names of procedure calls are identified by a name in bold type (e.g., **Execute Command**). Names of arguments are denoted by capitalizing each word in the name (e.g., Sense Data is the name of an argument in the **Execute Command** procedure call). For more information on procedure calls see 3.8.1.

Quantities having a defined numeric value are identified by large capital letters (e.g., CHECK CONDITION). Quantities having a discrete but unspecified value are identified using small capital letters. (e.g., TASK COMPLETE, indicates a quantity returned by the **Execute Command** procedure call). Such quantities are associated with an event or indication whose observable behavior or value is specific to a given implementation standard.

Lists sequenced by letters (e.g., a-red, b-blue, c-green) show no priority relationship between the listed items. Numbered lists (e.g., 1-red, 2-blue, 3-green) show a priority ordering between the listed items.

If a conflict arises between text, tables, or figures, the order of precedence to resolve the conflicts is text; then tables; and finally figures. Not all tables or figures are fully described in the text. Tables show data format and values.

Notes and examples do not constitute any requirements for implementors.

3.5 Numeric and character conventions

3.5.1 Numeric conventions

A binary number is represented in this standard by any sequence of digits comprised of only the Arabic numerals 0 and 1 immediately followed by a lower-case b (e.g., 0101b). Underscores or spaces may be included in binary

number representations to increase readability or delineate field boundaries (e.g., 0 0101 1010b or 0_0101_1010b).

A hexadecimal number is represented in this standard by any sequence of digits comprised of only the Arabic numerals 0 through 9 and/or the upper-case English letters A through F immediately followed by a lower-case h (e.g., FA23h). Underscores or spaces may be included in hexadecimal number representations to increase readability or delineate field boundaries (e.g., B FD8C FA23h or B_FD8C_FA23h).

A decimal number is represented in this standard by any sequence of digits comprised of only the Arabic numerals 0 through 9 not immediately followed by a lower-case b or lower-case h (e.g., 25).

This standard uses the ISO convention for representing decimal numbers (e.g., the thousands and higher multiples are separated by a space and a comma is used as the decimal point). Table 1 shows some examples of decimal numbers represented using the ISO and American conventions. The decimal representation for a year is 1999 not 1 999.

Table 1 — ISO and American numbering conventions examples

ISO	American
0,6	0.6
3,141 592 65	3.14159265
1 000	1,000
1 323 462,95	1,323,462.95

3.5.2 Byte encoded character strings conventions

When this standard requires one or more bytes to contain specific encoded characters, the specific characters are enclosed in single quotation marks. The single quotation marks identify the start and end of the characters that are required to be encoded but are not themselves to be encoded. The characters that are to be encoded are shown in the case that is to be encoded.

An ASCII space character (i.e., 20h) may be represented in a string by the character '¬' (e.g., 'SCSI¬device').

The encoded characters and the single quotation marks that enclose them are preceded by text that specifies the character encoding methodology and the number of characters required to be encoded.

EXAMPLE - Using the notation described in this subclause, stating that eleven ASCII characters 'SCSI device' are to be encoded would be the same writing out the following sequence of byte values: 53h 43h 53h 49h 20h 64h 65h 76h 69h 63h 65h.

[Editor's Note 9: The next few subclauses define conventions for UML diagrams, state machines, and procedure calls. Any of these may be deleted if the described convention is not used in the draft standard.](#)

3.5.3 Class diagram conventions

The notation in this subclause is based on the Unified Modeling Language (UML) specification.

Figure 2 shows the notation used for classes in class diagrams.

Notation for a class with no attributes or operations

Class Name

Notation for a class with attributes and no operations

Class Name
Attribute01
Attribute02

Notation for a class with operations and no attributes

Class Name
Operation01()
Operations02()

Notation for a class with attributes and operations

Class Name
Attribute01
Attribute02
Operation01()
Operation02()

Notation for a class with attributes showing multiplicity and operations

Class Name
Attribute01[1..*]
Attribute02[1]
Operation01()
Operation02()

Figure 2 — Class diagram conventions

Figure 3 shows the notation used for objects in class diagrams.

Notation for a named object with no attributes

label : Class Name

Notation for a named object with attributes

label : Class Name
Attribute01 = x
Attribute02 = y

Notation for a anonymous object with no attributes

: Class Name

Notation for a anonymous object with attributes

: Class Name
Attribute01 = x
Attribute02 = y

Figure 3 — Object diagram conventions

See table 2 for the notation used to indicate multiplicity.

Table 2 — Multiplicity notation

Notation	Description
	The number of instances of an attribute is not specified.
1	One instance of the object or attribute exists.
0..*	Zero or more instances of the object or attribute exist.
1..*	One or more instances of the object or attribute exist.
0..1	Zero or one instance of the object or attribute exists.
n..m	n to m instances of the object or attribute exists (e.g., 2..8).
x, n..m	Multiple disjoint instances of the object or attribute exists (e.g., 2, 8..15).

For the notation describing the relationships that may exist between classes see:

- a) figure 4 for association;
- b) figure 5 for aggregation;
- c) figure 6 generalization; and
- d) figure 7 dependency.

Association (“knows about” relationship)

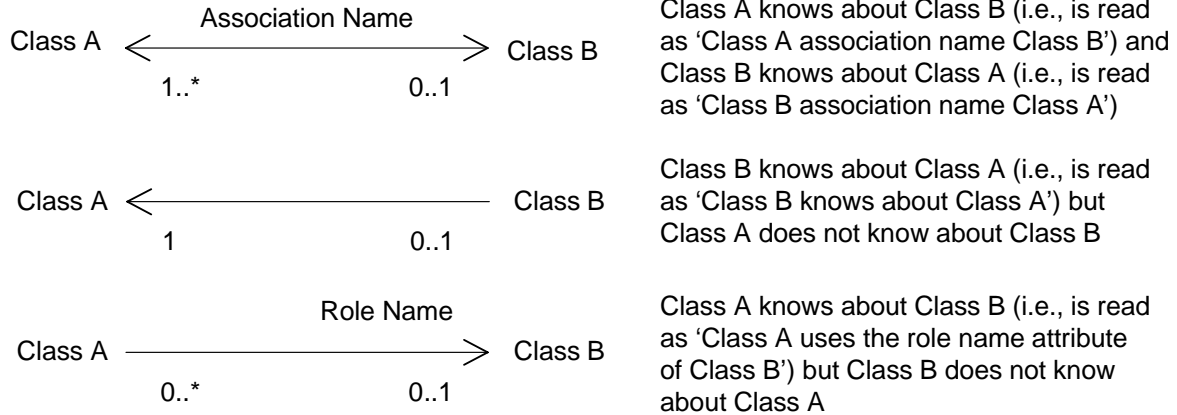

Note: The role name and association name are optional

Examples of class diagrams using associations

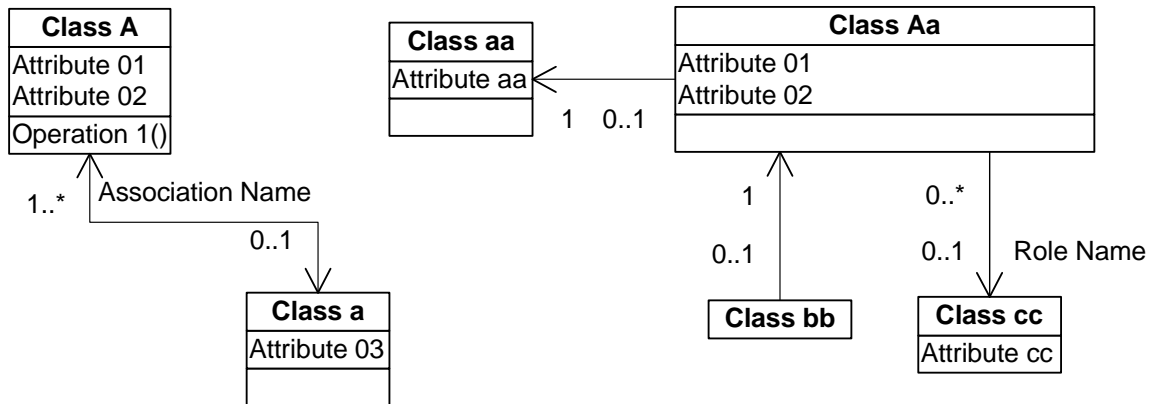
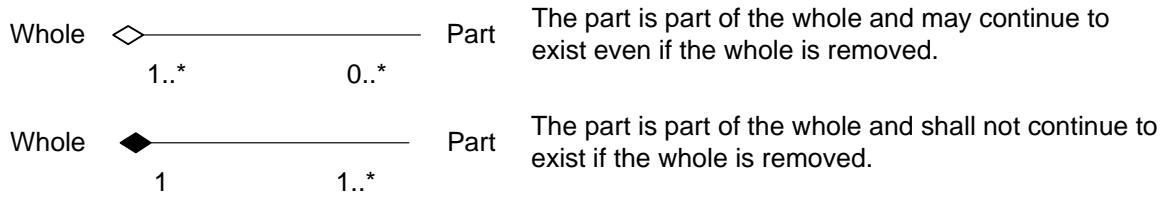

Figure 4 — Notation for association relationships for class diagrams

Aggregation (“is a part of” or “contains” relationship)



Examples of class diagrams using aggregation

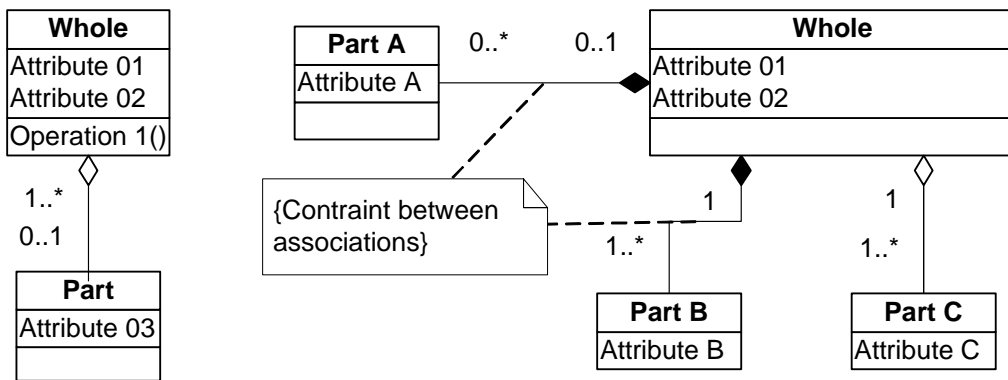
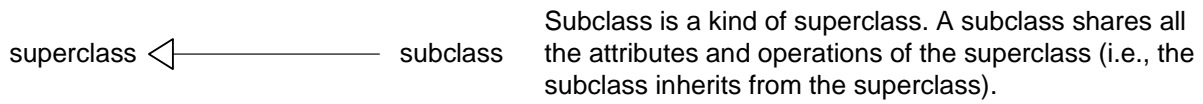

Figure 5 — Notation for aggregation relationships for class diagrams

Generalization (“is a kind of” relationship)



Examples of class diagrams using generalization

Single superclass/single subclass:

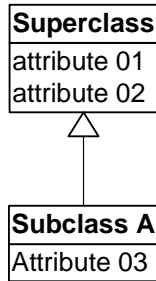

Multiple superclass/single subclass (i.e., multiple inheritance):

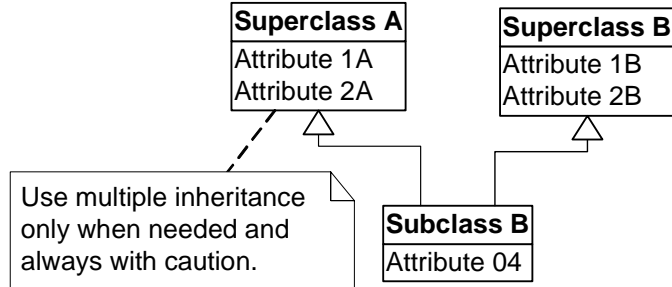

Single superclass/multiple subclass:

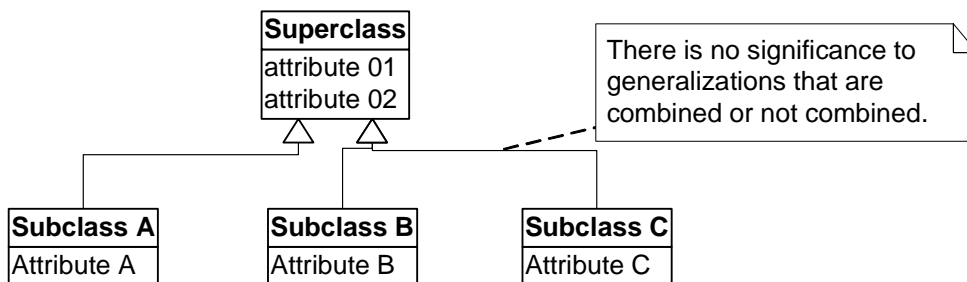
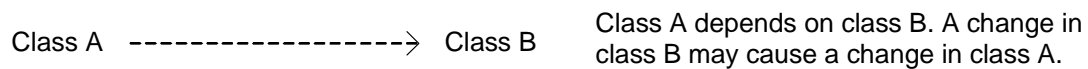

Figure 6 — Notation for generalization relationships for class diagrams

Dependency (“depends on” relationship)



Example of class diagram using dependency

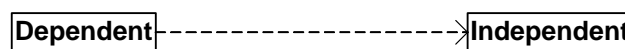

Figure 7 — Notation for dependency relationships for class diagrams

3.6 State machine conventions

3.6.1 State machine conventions overview

Figure 8 shows how state machines are described.

Editor's Note 10: There is a visio version of figure 8 in the zip file that contains the native FrameMaker Style Guide files. The name of that visio file is "ch3 State diagram conventions.vsd".

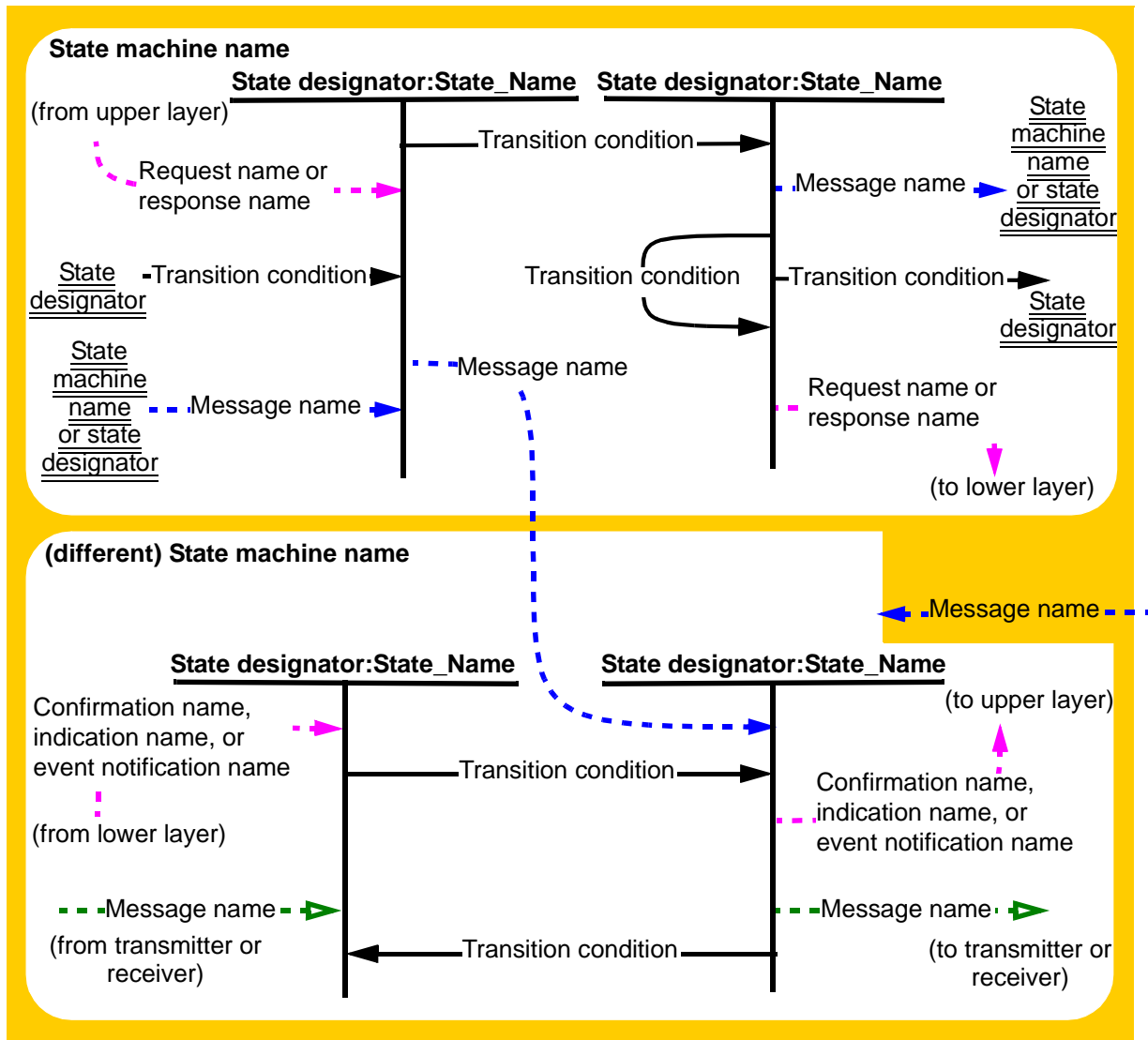

Figure 8 — State machine conventions

When multiple state machines are present in a figure, they are enclosed in boxes with rounded corners.

Each state is identified by a state designator and a state name. The state designator (e.g., SL1) is unique among all state machines in this standard. The state name (e.g., Idle) is a brief description of the primary action taken during the state, and the same state name may be used by other state machines. Actions taken while in each state are described in the state description text.

3.6.2 Transitions

Transitions between states are shown with solid lines, with an arrow pointing to the destination state. A transition may be labeled with a transition condition label, a brief description of the event or condition that causes the transition to occur.

If the state transition leaves the page, the transition label goes to or from a state designator label with double underlines rather than to or from a state.

The conditions and actions are described fully in the transition description text. In case of a conflict between a figure and the text, the text shall take precedence.

Upon entry into a state, all actions to be processed in that state are processed. If a state is re-entered from itself, all actions to be processed in the state are processed again. A state may be entered and exited in zero time if the conditions for exiting the state are valid upon entry into the state. Transitions between states are instantaneous.

3.6.3 Messages, requests, indications, confirmations, responses, and event notifications

Messages passed between state machines are shown with dashed lines labeled with a message name. When messages are passed between state machines within the same layer of the protocol, they are identified by either:

- a) a dashed line to or from a state machine name label with double underlines and/or state name label with double underlines, if the destination is in a different figure from the source;
- b) a dashed line to or from a state in another state machine in the same figure; or
- c) a dashed line from a state machine name label with double underlines to a “(to all states)” label, if the destination is every state in the state machine.

The meaning of each message is described in the state description text.

Requests, indications, confirmations, responses, and event notifications are shown with curved dashed lines originating from or going to the top or bottom of the figure. Each request, indication, confirmation, response, and event notification is labeled. The meaning of each request, indication, confirmation, response, and event notification is described in the state description text.

Messages with unfilled arrowheads are passed to or from the state machine's transmitter or receiver, not shown in the state machine figures, and are directly related to data being transmitted on or received from the physical link.

3.6.4 State machine counters, timers, and variables

State machines may contain counters, timers, and variables that affect the operation of the state machine. The scope of state machine counters, timers, and variables is the state machine itself. They are created and deleted with the state machines with which they are associated. State machine transitions specify the initialization and modification of state machine timers, counters, and variables. Transitions out of a state may be conditioned upon specific criteria regarding the current value of a state machine counter, timer, or variable. State machine timers may continue to run while a state machine is in a given state, and a timer may cause a state transition upon reaching a defined threshold value (e.g., zero for a timer that counts down).

3.7 Bit and byte ordering

In a field in a table consisting of more than one bit that contains a single value (e.g., a number), the least significant bit (LSB) is shown on the right and the most significant bit (MSB) is shown on the left (e.g., in a byte, bit 7 is the MSB and is shown on the left, bit 0 is the LSB and is shown on the right). The MSB and LSB are not labeled if the field consists of 8 or fewer bits.

In a field in a table consisting of more than one byte that contains a single value (e.g., a number), the byte containing the MSB is **stored** at the lowest address and the byte containing the LSB is stored at the highest address (i.e., big-endian byte ordering). The MSB and LSB are labeled.

Editor's Note 11: The term 'stored' in the above paragraph should be changed. What should be used?

In a field in a table consisting of more than one byte that contains multiple fields each with their own values (e.g., a descriptor), there is no MSB and LSB of the field itself and thus there are no MSB and LSB labels. Each individual field has an MSB and LSB, but they are not labeled.

In a field containing a text string (e.g., ASCII or UTF-8), the MSB label is the MSB of the first character and the LSB label is the LSB of the last character.

Multiple byte fields are represented with only two rows, with the non-sequentially increasing byte number indicating the presence of additional bytes.

A data dword consists of 32 bits. Table 3 shows a data dword containing a single value, where the MSB is on the left in bit 31 and the LSB is on the right in bit 0.

Table 3 — Data dword containing a value

3	3	2	2	2	2	2	2	2	2	2	2	1	1	1	1	1	1	1	1	1	1	0	9	8	7	6	5	4	3	2	1	0
MSB											Value																LSB					

Table 4 shows a data dword containing four one-byte fields, where byte 0 (the first byte) is on the left and byte 3 (the fourth byte) is on the right. Each byte has an MSB on the left and an LSB on the right.

Table 4 — Data dword containing four one-byte fields

3	3	2	2	2	2	2	2	2	2	2	2	1	1	1	1	1	1	1	1	1	1	0	9	8	7	6	5	4	3	2	1	0
MSB		Byte 0 (First byte)				LSB		MSB		Byte 1 (Second byte)				LSB		MSB		Byte 2 (Third byte)				LSB		MSB		Byte 3 (Fourth byte)				LSB		

3.8 Notation conventions

3.8.1 Notation for procedure calls

In this standard, the model for functional interfaces between entities is a procedure call. Such interfaces are specified using the following notation:

[Result =] Procedure Name (IN ([input-1] [,input-2] ...), OUT ([output-1] [,output-2] ...))

Where:

Result: A single value representing the outcome of the procedure call.

Procedure Name: A descriptive name for the function modeled by the procedure call.

Input-1, Input-2, ...: A comma-separated list of names identifying caller-supplied input arguments.

Output-1, Output-2, ...: A comma-separated list of names identifying output arguments to be returned by the procedure call.

"[...]": Brackets enclosing optional or conditional arguments.

This notation allows arguments to be specified as inputs and outputs. The following is an example of a procedure call specification:

Found = **Search** (IN (Pattern, Item List), OUT ([Item Found]))

Where:

Found = Flag

Flag, if set to one, indicates that a matching item was located.

Input Arguments:

Pattern = ... /* Definition of **Pattern** argument */

Argument containing the search pattern.

Item List = Item<NN> /* Definition of **Item List** as an array of NN **Item** arguments*/

Contains the items to be searched for a match.

Output Arguments:

Item Found = Item ... /* Item located by the search procedure call */

This argument is only returned if the search succeeds.

4 General

Editor's Note 12: This clause contains a description of what you are doing and setting the ground work for the rest of the clauses/annexes that contain the remaining normative/informative information for your project.

5 Framemaker Working Draft Template Instruction

5.1 Introduction

This document contains instructions on the preparation of draft standards and technical reports and should be used as a template when creating a projects first draft standard . The instructions and comments imbedded in it provide the user guidance. Those instructions/comments are inserted as Editors Note in **BLUE FONT** so that the user is able to identify and remove them when appropriate. Annex A contains a description of the following Framemaker styles, their meaning, and use:

- a) Paragraph catalog entries;
- b) Character catalog entries;
- c) Variables;
- d) Cross-reference format;
- e) Table formats; and
- f) Master pages.

Annex B contains examples of SCSI CDBs and data structure formats that may be used to create tables by copying and pasting.

This template uses the following Framemaker files:

- a) Book file (WDTemplate.book);
- b) Front matter file (WDCover.fm);
- c) Revision History file (WDRevHistory.fm);
- d) Table of Contents file (WDTemplateTOC.fm);
- e) List of Tables file (WDTemplateLOT.fm);
- f) List of Figures file (WDTemplateLOF.fm);
- g) Forward and Introduction file (WDForIntro.fm);
- h) Body file (WDBody.fm); and
- i) Annex file (WDAnnex.fm).

The files may be renamed as appropriate for your project. You may add additional files as necessary to make the draft standard more manageable.

There are examples throughout the template that may be used (e.g., tables, unordered lists, ordered lists, figures, examples). Just copy and paste what is needed.

Everything from this clause to the end of this document should be deleted as it contains reference material (e.g., general rules and examples) that is useful in the mechanics of creating a draft standard but should not appear as part of a draft standard.

5.2 Framemaker information

5.2.1 Master pages

Framemaker master pages for these files have to be edited to reflect the correct information for your project. See A.5 for a list of master pages.

5.2.2 Reference pages

Framemaker reference pages are used to define the layout of the table of contents, list of figures, and list of tables.

5.2.3 Paragraph and font catalogs

The Paragraph catalog contains the basic settings required to develop a draft standard. A list of the entries, their meaning and use is in A.1 of this document.

The Font catalog contains the basic fonts needed to develop a draft standard. A list of the entries, their meaning and use is in A.1.2 of this document.

5.2.4 Variables

Variables are used to define text and phrases that are used throughout a draft standard or technical report that may be changed by editing the variable. There is a set of variables (see A.2) that have been defined for use in the development of draft standards and technical reports. Variables should be checked to be sure you have them set to the correct values.

5.3 Front matter

The front matter consists of boilerplate information except for the draft standards name and number, the editors information, and the abstract. The editor changes the document name and number based on the name of the project and the assigned project number. There are names and contact information on the second page that are subject to change and should be checked to ensure accuracy. The abstract is a brief description about the project.

5.4 Revision history

There is a revision history section that indicates what major changes have been incorporated since the last revision. The revision history should included a list of proposals included in the draft standard version listed by proposal number and title. The revision history is removed prior to forwarding for public review.

5.5 ANSI cover

5.5.1 ANSI cover overview

The sample ANSI cover should be modified to reflect the project being defined by the draft standard. The ANSI cover requires one of two patent statements. The choice of patent statement depends on whether there are any known patents that are necessary to implement the requirements of your draft standard. If no patents have been brought forth the patent statement indicated in 5.5.2 is used. If patents have been brought forth the patent statement indicated in 5.5.3 is used.

5.5.2 Patent statement for ANSI cover if no patents disclosed

CAUTION: The developers of this standard have requested that holders of patents that may be required for the implementation of the standard, disclose such patents to the publisher. However, neither the developers nor the publisher have undertaken a patent search in order to identify which, if any, patents may apply to this standard. As of the date of publication of this standard, following calls for the identification of patents that may be required for the implementation of the standard, no such claims have been made. No further patent search is conducted by the developer or the publisher in respect to any standard it processes. No representation is made or implied that licenses are not required to avoid infringement in the use of this standard.

5.5.3 Patent statement for ANSI cover if patents have been disclosed

CAUTION: The developers of this standard have requested that holders of patents that may be required for the implementation of the standard, disclose such patents to the publisher. However, neither the developers nor the publisher have undertaken a patent search in order to identify which, if any, patents may apply to this standard. As of the date of publication of this standard, following calls for the identification of patents that may be required for the implementation of the standard, notice of one or more claims has been received. By publication of this standard, no position is taken with respect to the validity of this claim or of any rights in connection therewith. The known patent holder(s) has (have), however, filed a statement of willingness to grant a license under these rights on reasonable and nondiscriminatory terms and conditions to applicants desiring to obtain such a license. Details may be obtained from the publisher. No further patent search is conducted by the developer or the publisher in respect to any standard it processes. No representation is made or implied that licenses are not required to avoid infringement in the use of this standard.

5.6 Table of contents (TOC), list of tables (LOT), and list of figures (LOF)

5.6.1 TOC, LOT, and LOF overview

These files are automatically generated by Framemaker any time you update book generation. They should be checked to ensure they are properly generated.

The order of the TOC, LOT, and LOF within a standard shall be:

- 1) TOC;
- 2) LOT, if any; and
- 3) LOF, if any.

The format of these clauses shall be as shown in the TOC, LOT, and LOF clauses of this document.

5.6.2 Producer for setting up TOC, LOT, and LOF files

The process for setting up the TOC, LOT, and LOF is tedious, but you only have to do it once for the entire lifetime of the project.

NOTE 2 - Although the process defined in this subclause should work for all versions of FrameMaker, it has only been verified to work in FrameMaker version 6.

To create the .toc, .lot, and .lof files do the following:

- 1) Copy the ?? .toc, ?? .lot, and ?? .lof from the style guide template file to the directory containing your book;
- 2) If the file names that make up the book are different than the names used to make the style guide template then change the file names preceding the extension (i.e., the ?? shown in step 1) to match the ?? in the book file (i.e., ?? .book);
- 3) Open the ?? .book file;
- 4) If there are .toc, .lot, or .lof file entries in the .book file, delete them;
- 5) Select the file in the book into which you want to add the Table Of Contents;
- 6) Pull down the Add menu and select Table Of Contents;
- 7) In the Set Up Table of Contents dialog box:
 - A) Ensure that the suffix is TOC;
 - B) Ensure that the Create Hypertext Link box is checked;
 - C) In the Don't Include box scroll to each of the following, paragraph tags, select it, and use the <--- button to move it to the Include Paragraphs Tagged box:
 - a) Annex0i;
 - b) Annex0t;
 - c) Annex1;
 - d) Annex2;
 - e) Annex3;

- f) Annex4;
- g) Annex5;
- h) Head0;
- i) Head1;
- j) Head2;
- k) Head3;
- l) Head4;
- m) Head5;
- n) Head6; and
- o) Head7;
- and
- D) Press the Set button;
- 8) Select the file in the book into which you want to add the List of Tables;
- 9) Pull down the Add menu and select Table Of Contents;
- 10) In the Set Up Table of Contents dialog box:
 - A) Ensure that the suffix is LOT;
 - B) Ensure that the Create Hypertext Link box is checked;
 - C) In the Don't Include box scroll to each of the following, paragraph tags, select it, and use the <-- button to move it to the Include Paragraphs Tagged box:
 - a) Table; and
 - b) TableAnnex;
 - and
 - D) Press the Set button;
- 11) Select the file in the book into which you want to add the List of Figures;
- 12) Pull down the Add menu and select Table Of Contents; and
- 13) In the Set Up Table of Contents dialog box:
 - A) Ensure that the suffix is LOF;
 - B) Ensure that the Create Hypertext Link box is checked;
 - C) In the Don't Include box scroll to each of the following, paragraph tags, select it, and use the <-- button to move it to the Include Paragraphs Tagged box:
 - a) Figure; and
 - b) FigureAnnex;
 - and
 - D) Press the Set button.

If you update the book, the .toc, .lot, and .lof files should be right.

5.7 Forward and introduction

These are modified as necessary as required by the project. Look at 2.1 and other existing draft standards for examples.

5.8 Body of draft

The body of the draft standard is the beginning of normative information.

Clause 1 (Scope) contains a brief description of what this project covers and how it relates to other projects within the scope of the standard organization. See clause 1 for an example of a scope clause.

Clause 2 (Normative References) lists the references used by the draft standard. These references consist of a list of approved standards, standards under development, and standards from other organizations that are referenced from the draft standard. See clause 2 for examples of the format of the references.

Clause 3 (Definitions, symbols, abbreviations, and conventions) contains information required for a reader to understand and interrupt the draft standard. See clause 3 for examples.

Clause 4 (General) describes the project and lays the ground work for the rest of the draft standard. Examples may be found in other existing draft standards.

Clause 5 - n (Normative information) provide the requirements for your project within its scope and objectives.

5.9 Annexes

Annexes are added as necessary to convey additional normative or informative information. Normative annexes precede informative ones within the draft standard structure. Annexes appear in the order referenced in the body of the working draft given normative before informative.

5.10 Document preparation

5.10.1 PDF introduction

All working drafts shall be posted as Acrobat (*.pdf) files. When saving draft standards all the source files (e.g., framemaker, visio) that compose the draft standard shall be collected into a zip file and saved along with the PDF files. This allows the administrator to rebuild documents if necessary.

5.10.2 General

Compare the PDF file size to the Framemaker file size, the PDF should be smaller.

Verify that the bookmarks are all there and that they work.

Verify that the Table of Contents links work.

Verify that the see x.y links work.

5.11 FrameMaker PDF Setup

In Framemaker to setup the PDF file select the "Format/Document/PDF Setup..." menu and fill in the appropriate information for the draft standard.

6 General principles and structures

6.1 Consistency of draft standards

Uniformity of structure, of style and of terminology shall be maintained not only within each draft standard, but also within a series of associated draft standards. The structure of associated draft standards and the numbering of their clauses shall, as far as possible, be identical.

Analogous wording shall be used to express analogous provisions and identical wording shall be used to express identical provisions.

The same term shall be used throughout each draft standard or series of associated draft standards to designate a given concept. The use of an alternative term (i.e., synonym) for a concept already defined shall be avoided. As far as possible, only one meaning shall be attributed to each term chosen.

These requirements are particularly important not only to ensure comprehension of the draft standard, or of the series of associated draft standards, but also to derive the maximum benefit available through automated text processing techniques and computer-aided translation.

6.2 Description and numbering of divisions and subdivisions

6.2.1 Clause

A clause is the basic component in the subdivision of the content of a draft standard.

The clauses in each draft standard shall be numbered with Arabic numerals, beginning with 1 for the Scope clause. The numbering shall be continuous up to but excluding any annexes.

Each clause shall have a title, placed immediately after its number, on a line separate from the text that follows it.

6.2.2 Subclause

A subclause is a numbered subdivision of a clause. A primary subclause (e.g., 5.1, 5.2) may be subdivided into secondary subclauses (e.g., 5.1.1, 5.1.2), and this process of subdivision may be continued as far as the seventh level (e.g., 5.1.1.1.1.1.1.1, 5.1.1.1.1.1.1.2).

Subclauses shall be numbered with Arabic numerals (e.g., 5.1, 5.2).

A subclause shall not be created unless there is at least one further subclause at the same level (e.g., text in Clause 10 shall not be designated subclause 10.1 unless there is also a subclause 10.2).

Each subclause shall be given a title, which is placed immediately after its number.

6.2.3 Definitions subclause construction

As a result of the different definition styles defined by ANSI and ISO the method defined in this subclause should be used to construct definitions. This method allows for a quick and simple conversion between the two different styles.

There are three paragraph tags used to construct a single definition or glossary subclause. For definition subclauses in the main body of the draft standard Gloss2n, Gloss2t, and GlossParagraph should be used to construct the definition entry. If a definition subclause is required for an annex then AnnexGloss2n, AnnexGloss2t, and AnnexGlossPara should be used to construct the definition entry.

A definition should be constructed as follows:

- 1) Use the Gloss2n or AnnexGloss2n tag to provide the subclause number (e.g., 3.2.33, A.2.3);
- 2) Use the Gloss2t or AnnexGloss2t tag for the term to be defined; and
- 3) Use the GlossParagraph or AnnexGlossPara tag to define the term.

EXAMPLE - This shows an example of the paragraph tags and the resulting text:

Gloss2n	Gloss2t	GlossParagraph
3.1.1	field:	A group of one or more contiguous bits.

When a cross-reference is made to a definition the Gloss2n or AnnexGloss2n paragraph tag is what shall be referenced. The editor should assure that the correct cross-reference paragraph is selected as no title shows up in the paragraphs window when the Gloss2n tag is selected.

6.2.4 Paragraph

A paragraph is an unnumbered subdivision of a clause or subclause.

Hanging paragraphs, such as those shown in table 5 shall be avoided since reference to them is ambiguous.

EXAMPLE - In table 5, the hanging paragraphs indicated are not able to be uniquely identified as being in Clause 5 since strictly speaking the paragraphs in 5.1 and 5.2 are also in Clause 5. To avoid this problem it is necessary to identify the unnumbered paragraphs as subclause 5.1 General, or other suitable title, and to renumber the existing 5.1 and 5.2 accordingly, to move the hanging paragraphs elsewhere, or to delete.

Table 5 — Hanging paragraph example

Incorrect	Correct
<p>5 Designation</p> <p>The quick brown fox jumps over the lazy dog. ^a</p> <p>The quick brown fox jumps over the lazy dog. ^a</p> <p>The quick brown fox jumps over the lazy dog. ^a</p> <p>5.1 XXXXXXXXXXXXX</p> <p>The quick brown fox jumps over the lazy dog. ^a</p> <p>5.1.1 YYYYYYYYYYYYYY</p> <p>The quick brown fox jumps over the lazy dog.</p> <p>5.1.2 YYYYYYYYYYYYYY</p> <p>The quick brown fox jumps over the lazy dog.</p> <p>5.2 XXXXXXXXXXXXX</p> <p>The quick brown fox jumps over the lazy dog.</p> <p>The quick brown fox jumps over the lazy dog. The quick brown fox jumps over the lazy dog. The quick brown fox jumps over the lazy dog.</p> <p>6 Test report</p>	<p>5 Designation</p> <p>5.1 General</p> <p>The quick brown fox jumps over the lazy dog.</p> <p>The quick brown fox jumps over the lazy dog.</p> <p>The quick brown fox jumps over the lazy dog.</p> <p>5.2 XXXXXXXXXXXXX</p> <p>5.2.1 YYYYYYYYYYYYYY</p> <p>The quick brown fox jumps over the lazy dog.</p> <p>5.2.2 YYYYYYYYYYYYYY</p> <p>The quick brown fox jumps over the lazy dog.</p> <p>5.2.3 YYYYYYYYYYYYYY</p> <p>The quick brown fox jumps over the lazy dog.</p> <p>5.3 XXXXXXXXXXXXX</p> <p>The quick brown fox jumps over the lazy dog.</p> <p>The quick brown fox jumps over the lazy dog. The quick brown fox jumps over the lazy dog. The quick brown fox jumps over the lazy dog.</p> <p>6 Test report</p>
<p>^a Hanging paragraph</p>	

6.2.5 Lists

6.2.5.1 Lists overview

Lists shall be introduced by a complete grammatical proposition followed by a colon completed by the items in the list.

Each item in a list shall be preceded by an identification with the style of the identification being determined by whether the list is intended to be an ordered list or an unordered list.

The first word of the item should be capitalized only if the item is a complete sentence.

Each item in the list shall end with a semi-colon except the last which ends in a period.

The second to the last entry in the list shall end with a semi-colon followed by an “and” or an “or” (i.e., ; and, ; or). The “and” is used if all the items in the list are required. The “or” is used if only one or more items in the list are required.

6.2.5.2 Unordered lists

An unordered list is one in which the order of the listed items is unimportant (i.e., it does not matter where in the list the item occurs as all have equal importance). Each listed item starts with a lower case letter followed by a parenthesis. If it is necessary to subdivide further an item in the latter type of list, upper case letter followed by a parenthesis shall be used. Further subdivision alternate between lower case letters followed by a parenthesis and uppercase letters followed by a parenthesis. See the example in this subclause.

The following is an example of a multi-level unordered list.

The cart contains the following:

- a) a big box containing:
 - A) a medium box containing:
 - a) thing 1;
 - b) thing 2; or
 - c) thing 3;
 - and
 - B) a cylinder;
- b) a little box; and
- c) a small animal.

6.2.5.3 Ordered lists

An ordered list is one in which the order of the listed items is important (i.e., item n is required before item n+1). Each listed item starts with an Arabic numeral followed by a parenthesis. If it is necessary to subdivide further an item in the latter type of list, an Arabic numeral followed by a parenthesis shall be used.

The following is an example of a multi-level ordered list.

Assemble the device using the following procedure:

- 1) remove contents from box;
- 2) assemble item; and
 - 1) place tab A in slot A;
 - 2) place screw in screw hole; and
 - 3) tighten screw;
- 3) throw away all excess materials.

6.2.6 Programing source code

When a draft standard lists programing source code (e.g., C, C++, Java, XML) a monospace font shall be used. The recommended font is 10 point Courier New.

EXAMPLE - This is an example of what C source code would look like in a draft standard:

```
#define OPEN_REJECT_RESERVE_STOP          9
#define OPEN_REJECT_RETRY                10
#define OPEN_REJECT_STP_RESOURCES_BUSY   11
#define OPEN_REJECT_WRONG_DESTINATION    12
// definitions for discovery algorithm use enum
{
    SAS_SIMPLE_LEVEL_DESCENT = 0,
    SAS_UNIQUE_LEVEL_DESCENT
};
// definitions for discovery compatibility enum
{
    SAS_10_COMPATIBLE = 0,
    SAS_11_COMPATIBLE
};
```

6.2.7 Annex

6.2.7.1 Annex overview

Each annex shall be designated by a heading comprising the word Annex followed by a capital letter designating its serial order, beginning with “A” (e.g. Annex A). The annex heading shall be followed by the indication (normative) or (informative), and by the title, each on a separate line. Numbers given to the clauses, subclauses, tables, figures, and mathematical formulae of an annex shall be preceded by the letter designating that annex followed by a full-stop (e.g., clauses in Annex A are designated A.1, A.2, A.3, etc.). The numbering shall start afresh with each annex. A single annex shall be designated Annex A.

6.2.7.2 Normative annexes

Normative annexes give provisions additional to those in the body of the document. Their presence is optional. An annex’s normative status shall be made clear by an indication in the table of contents and under the heading of the annex.

6.2.7.3 Informative annexes

Informative annexes give additional information intended to assist the understanding or use of the document. They shall not contain requirements, except as described in this subclause.

Their presence is optional. An annex’s informative status shall be made clear by an indication in the table of contents and under the heading of the annex.

Informative annexes may contain optional requirements (e.g., a test method that is optional may contain requirements but there is no need to comply with these requirements to claim compliance with the draft standard).

6.3 Notes, examples, and footnotes

6.3.1 Notes and examples in text

Notes and examples integrated in the text of a draft standard shall only be used for giving additional information intended to assist the understanding or use of the draft standard. Notes and example shall not contain requirements or any information considered indispensable for the use of the draft standard.

EXAMPLE - The following note is incorrectly drafted as a note since it contains a requirement that is explained in parentheses after the example and clearly does not constitute additional information.

NOTE 3 - Alternatively, test at a load of ... (an instruction, expressed here using the imperative, is a requirement).

Notes and examples should be placed after the paragraph, to which they refer.

All notes in the draft standard shall be preceded by NOTE n -, placed at the beginning of the first line of the text of the note. All notes shall be numbered from 1 to n where n is the last note in the draft standard.

A single example in a clause or subclause shall be preceded by EXAMPLE -, placed at the beginning of the first line of the text of the example. When several examples occur within the same clause or subclause, they shall be numbered from 1 to n, within the clause or subclause, where n is the last example in the clause or subclause (e.g., EXAMPLE 1 -, EXAMPLE 2 -, EXAMPLE 3 -).

In draft standards, all lines of a note shall be inset from the margin and shall be set in smaller type (i.e., 9 point), so that its extent is able to be determined.

In draft standards, all lines of an example may be indented from the margin and shall be set in smaller type (i.e., 9 point), so that its extent is able to be determined.

6.3.2 Footnotes to the text

Footnotes in text should not be used in a draft standard. However, if they are used, rules in this subclause shall apply.

Footnotes to the text give additional information. A footnote shall not contain requirements or any normative information.

Footnotes in figures and tables follow different rules (see 6.5.8 and 6.6.9).

Footnotes to the text shall be placed at the foot of the relevant page and be separated from the text by a short thin horizontal line on the left of the page.

Footnotes to the text shall normally be distinguished by Arabic numerals, beginning with 1, followed by one parenthesis and forming a continuous numerical sequence throughout the document (i.e., 1), 2), 3)). The footnotes shall be referred to in the text by inserting the same numerals, as superscripts, after the word or sentence in question (i.e., ^{1) 2) 3)}).

6.4 Verbal forms

6.4.1 Verbal forms for the expression of provisions

This subclause gives, in the first column of each table, the verbal form that shall be used to express each kind of provision. The equivalent expressions given in the second column shall be used only in exceptional cases when the form given in the first column is not able to be used for linguistic reasons.

The verbal forms shown in table 6 shall be used to indicate requirements strictly to be followed in order to conform to the document and from which no deviation is permitted.

Table 6 — Requirement

Verbal form	Equivalent expressions for use in exceptional cases
shall	is to is required to it is required that has to only ... is permitted it is necessary is mandatory
shall not	is not allowed is required to be not is required that ... be not is not to be
<p>Do not use “may not” instead of “shall not” to express a prohibition.</p> <p>To express a direct instruction, for example referring to steps to be taken in a test method, use the imperative mood in English.</p> <p>EXAMPLE - Switch on the recorder.</p>	

The verbal forms shown in table 7 shall be used to indicate that among one of the following possibilities:

- a) one is recommended as particularly suitable, without mentioning or excluding others;
- b) that a certain course of action is preferred but not necessarily required; or
- c) that, in the negative form, a certain possibility or course of action is deprecated but not prohibited.

Table 7 — Recommendations

Verbal form	Equivalent expressions for use in exceptional cases
should	it is recommended that ought to
should not	it is not recommended that ought not to

The verbal forms shown in table 8 shall be used to indicate a course of action permissible within the limits of the draft standard.

Table 8 — Permission

Verbal form	Equivalent expressions for use in exceptional cases
may	is permitted is allowed is permissible
may not	it is not required that no ... is required need not
<p>Do not use “possible” or “impossible” in this context.</p> <p>Do not use “can” instead of “may” in this context.</p> <p>Do not use “might” instead of “may”.</p> <p>Note - “May” signifies permission expressed by the draft standard, whereas “can” refers to the ability of a user of the draft standard or to a possibility open to them.</p>	

The verbal forms shown in table 9 shall be used for statements of possibility and capability, whether material, physical or causal.

Table 9 — Possibility and capability

Verbal form	Equivalent expressions that shall not be used
be able to there is a possibility of it is possible	can could would
be unable to there is not possibility of it is not possible to	cannot could not would not
<p>Due to the likelihood of misinterpretation of the verbal form “can” and “cannot” as a “may” and possibly a “shall” its use shall be avoided in a draft standard.</p> <p>Note - “May” signifies permission expressed by the draft standard, whereas “can” refers to the ability of a user of the draft standard or to a possibility open to them.</p>	

The verbal forms shown in table 10 shall be used as indicated.

Table 10 — Miscellaneous

Verbal form	Equivalent expressions that shall not be used
process processed processing	execute executed executing

6.4.2 Other recommended verbal form expressions

6.4.2.1 Arabic numerals

The verbal forms for Arabic numerals contained in statements shall be written out for numerals zero through ten and listed as numbers in all other cases (e.g., 11, 16, 1 321). This rule shall apply when the numeral is:

- a) a decimal representation of a value when not followed by units (e.g., 7 % not seven percent, 5 m not five meters or five m) or a single bit binary value (e.g., one not 1b, zero not 0b); and
- b) contained within a sentence.

The verbal form for indicating the state of a single bit field is set to one or set to zero.

EXAMPLE - The I support this (ISP) bit when set to zero specifies.... An ISP bit set to one specifies....

6.4.2.2 For example

When an example is contained within a paragraph body it shall be highlighted using the verbal form “(e.g., the example text)”. The verbal form “for example” shall not be used. Examples not contained within a paragraph are handled as defined in 6.3.1.

6.4.2.3 Such as

When there is a restatement of an expression the verbal form of the restatement shall be “(i.e., the restatement text)”. The verbal form “such as” shall not be used.

6.4.2.4 If/then vs. when

The verbal form “if “ should be followed by the verbal form “then”, however, the “then” is not required if the context of the statement is clear. The “if expression, then expression” verbal form should be used if it is possible that the expression may not happen. The “when expression” verbal form should be used when it is certain that the expression is going to happen at some point.

EXAMPLE - The statement “if the world ends then, humans no longer have a home” does not assume the world is going to end but if it does then humans no longer have a home. The statement “when the world ends humans no longer have a home” makes the assumption that the world is going to end and at that point humans lose their home.

6.4.2.5 Specify vs. indicate

Editor’s Note 13: Need some wording for this.

6.4.2.6 Which vs. that

Editor’s Note 14: Need some wording for this.

6.4.2.7 Single quotes vs. double quotes

Verbal forms shall only be enclosed in single quotes when the enclosed verbal form represents a byte encoded character string (see 3.5.2). The use of double quotes should be used to set off titles (e.g., of published works, essays, articles) and may be used to call attention to individual words or phrases. However, the use of double quotes should be minimized within a draft standard.

6.4.3 Prohibited verbal forms

The following verbal forms shall not be used in draft standards:

- a) must;
- b) can;
- c) cannot;
- d) execute; and
- e) will.

NOTE 4 - This prohibition avoids confusion between the requirements of a draft standard and external statutory obligations.

6.4.4 Spelling, reference works, and abbreviated terms

All words follow common English meaning unless defined. The following reference works for English are suggested:

- a) "The Shorter Oxford English Dictionary";
- b) "The Concise Oxford Dictionary";
- c) "The Collins Concise English Dictionary";
- d) "Webster's New World College Dictionary"; or
- e) "Chambers Concise Dictionary".

Abbreviated terms shall be used with care, and their use shall be limited to those cases where it is not likely to cause confusion. Once an abbreviated form is defined use that form consistently throughout the draft standard (i.e., do not mix the abbreviated form of a term with the non-abbreviated form within a draft standard).

If a list of abbreviated terms is not given in the draft standard or the abbreviated term is not in the list, then the first time that an abbreviated term is used, the full term shall be given with the abbreviated term following in parentheses.

An abbreviated term shall be specified only if used subsequently in the draft standard.

The general rule is that an abbreviated term comprises capital letters, without a full-stop after each letter.

6.4.5 Use of trade names

A correct designation or description of a product shall be given rather than a trade name (brand name).

Proprietary trade names (i.e. trade marks) for a particular product should as far as possible be avoided, even if they are in common use.

If, exceptionally, trade names are unavoidable, their nature shall be indicated (e.g., by the symbol ® for a registered trade mark) as shown in example 1.

EXAMPLE 1 - Instead of Teflon®, write polytetrafluoroethylene (PTFE).

If it is known that only one product is currently available that is suitable for the successful application of the draft standard, the trade name of the product may be given in the text of the draft standard but shall be associated with a footnote as shown in example 2.

EXAMPLE 2 - 1) ... [trade name of product] ... is the trade name of a product supplied by ... [supplier] This information is given for the convenience of users of this draft standard and does not constitute an endorsement by ... [ANSI, ISO, or IEC] ... of the product named. Equivalent products may be used if they lead to the same results.

If it is considered essential to give an example, or examples, of commercially available products suitable for successful application of the draft standard because the product characteristics are difficult to describe in detail, trade names may be given in a footnote as shown in Example 3.

EXAMPLE 3 - 1) ... [trade name(s) of product(s)] ... is (are) an example(s) of a suitable product(s) available commercially. This information is given for the convenience of users of this standard and does not constitute an endorsement by ... [ANSI, ISO, or IEC] ... of this (these) product(s).

6.5 Figures

6.5.1 Usage

Figures should be used when they are the most efficient means of presenting information in an easily comprehensible form. Each figure shall be explicitly referred to from text.

6.5.2 Form

Figures shall be in the form of line drawings. Photographs may be used only if it is not possible to convert them into line drawings.

Figures shall be clearly delineated from body text. This may be accomplished by white space around the figure or by placing a single line frame around the figure.

The font size for text within a figure should be no smaller than 10 pt., however font sizes as small as 8 pt. may be used.

6.5.3 Designation

Figures shall be designated figure n where n is an Arabic numeral, beginning with 1. This numbering shall be independent of the numbering of the clauses and of any tables. A single figure shall be designated figure 1.

For the numbering of figures in annexes, see 6.2.7.1.

6.5.4 Layout of figure designation and title

The figure title shall be centred horizontally below the figure and laid out as in the following example:

Figure 9 — Details of apparatus

The figure designation and title shall be separated by a em dash.

6.5.5 Continuation of figures

When a figure is continued over several pages, the figure designation shall be repeated, followed by the title and by (part n of n), as in the following example:

Figure 10 — Details of apparatus (part 1 of 2)

Any statements concerning units shall be repeated on all pages after the first, where applicable.

6.5.6 Keys in figures

Keys, when used, shall be located above the figure title and shall precede figure notes. The list of keys shall be preceded with the term "Key:" following by a list of keys and a description of the key. See figure 11 for an example.

6.5.7 Notes in figures

Notes in figures shall be treated independently from notes integrated in the text (see 6.3.1).

Notes, when used, shall be located above the figure title and shall precede figure footnotes. A single note in a figure shall be preceded by "NOTE -", placed at the beginning of the first line of the text of the note. When several

notes occur in the same figure, they shall be designated "NOTE n -". All notes shall be number from 1 to n where n is the last note in the figure. A separate numbering sequence shall be used for each figure. See figure 11 for an example.

Notes in figures shall not contain requirements or any normative information. Any requirements relating to the content of a figure shall be given in the text, in a footnote in the figure, or as a paragraph between the figure and its title.

It is not necessary that notes in figures be referred to.

6.5.8 Footnotes in figures

Footnotes in figures shall be treated independently from footnotes in the text (see 6.3.2).

Footnotes, when used, shall be located immediately above the figure title.

Footnotes in figures shall be distinguished by superscript lower case letters, beginning with "a". The footnotes shall be referred to in the figure by inserting the same superscript lower case letter. See figure 11 for an example.

Footnotes in figures may contain requirements.

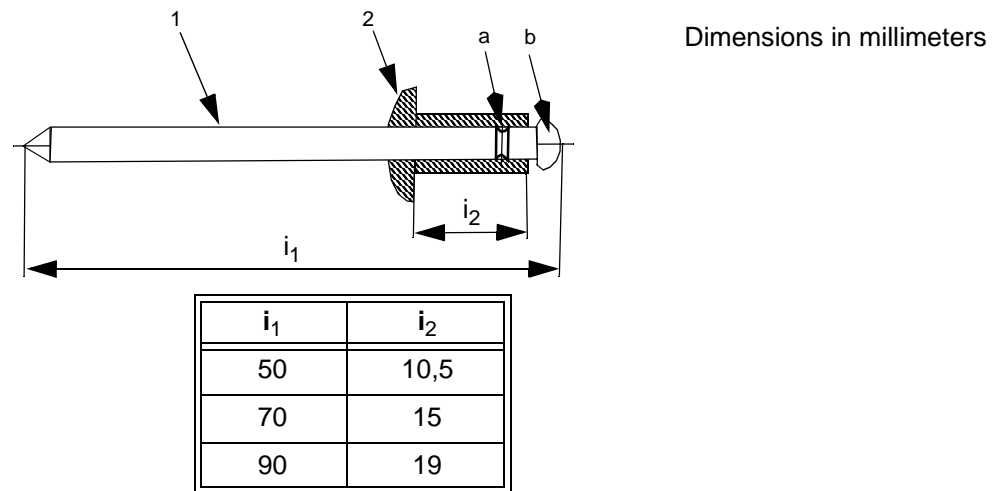

Key:

- 1 = mandrel shank
- 2 = blind rivet head

The mandrel shall be designed such that the blind rivet end deforms during installation, and the shank may expand.

NOTE - This figure illustrates a type A rivet head.

- a The break area shall be milled.
- b The mandrel head is commonly chromium plated.

Figure 11 — Blind rivet

6.6 Tables

6.6.1 Usage

Tables should be used when they are the most efficient means of presenting information in an easily comprehensible form. Each table shall be explicitly referred to from text.

A table within a table is not permitted. Subdivision of a table into subsidiary tables is not permitted.

6.6.2 Form

The outside ruling shall consist of double line ruling. The ruling between headings and footings, if any, shall be:

- a) if row ruling is "none", then single line ruling (see table 11); or
- b) if row ruling is "single line" ruling, then double line ruling (see table 12).

The font size for text within a table should be no smaller than 10 pt., however font sizes as small as 8 pt. may be used.

Table 11 — No row ruling table example

Heading 1	Heading 2
cell 11 words	cell 21 words
cell 12 words	cell 22 words
cell 13 words	cell 23 words
cell 14 words	cell 24 words
Note - Words in footnote.	

Table 12 — Row ruling table example

Heading 1	Heading 2
cell 11 words	cell 21 words
cell 12 words	cell 22 words
cell 13 words	cell 23 words
cell 14 words	cell 24 words
Note - Words in footnote.	

6.6.3 Designation

Table shall be designated Table n where n is an Arabic numeral, beginning with 1. This numbering shall be independent of the numbering of the clauses and of any figures. A single table shall be designated Table 1.

For the numbering of figures in annexes, see 6.2.7.1.

6.6.4 Layout of table designation and title

The table title shall be centered horizontally above the table and laid out as in the following example:

Table 13 — Mechanical properties

The table designation and title shall be separated by a em dash.

The font size for text within a table cell should be no smaller than 10 pt., however font sizes as small as 8 pt. may be used.

6.6.5 Headings

Heading shall be in bold text. The first word in the heading of each column or row shall begin with a capital letter. The units used in a given column, if any, shall be indicated under the column heading.

6.6.6 Continuation of tables

When a table is continued over several pages, the table designation shall be repeated, followed by the title and by (part n of n), as in the following example:

Table 14 — Table title (part 1 of 2)

The column headings together with any statement concerning units shall be repeated on all pages after the first. Footers shall be displayed on the last page and should be repeated on all other pages.

6.6.7 Keys in tables

Keys, when used, shall be located within a separate table footer and shall precede figure notes. The list of keys shall be preceded with the term “Key:” following by a list of keys and a description of the key. See table 15 for an example.

6.6.8 Notes in tables

Notes in tables shall be treated independently from notes integrated in the text (see 6.3.1).

Notes, when used, shall be located within a table footer of the relevant table and shall precede table footnotes. A single note in a table shall be preceded by “NOTE - ”, placed at the beginning of the first line of the text of the note. When several notes occur in the same table, they shall be designated “NOTE n”. All notes shall be numbered from 1 to n where n is the last note in the table. A separate numbering sequence shall be used for each table. See table 15 for an example.

Notes in tables shall not contain requirements or any normative information. Any requirements relating to the content of a table shall be given in the text, in a footnote to the table or as a paragraph within the table.

It is not necessary that notes in tables be referred to.

6.6.9 Footnotes in tables

Footnotes in tables shall be treated independently from footnotes to the text (see 6.3.2). They shall be located within the footer of the relevant table.

Footnotes in tables shall be distinguished by superscript lower case letters, beginning with “a”. The footnotes shall be referred to in the table by inserting the same superscript lower case letter. See table 15 for an example.

Footnotes in tables may contain requirements.

Table 15 — Table with notes and footnotes

Type	Length mm	Inside diameter mm	Description
O	l_1^a	d_1	A paragraph containing a requirement.
M	l_2	$d_2^{b c}$	
Key: M = Implementation is mandatory. O = Implementation is optional.			
Note 1 - Table note. Note 2 - Table note.			
^a Table footnote. ^b Table footnote. ^c Table footnote.			

6.7 References

6.7.1 General

As a general rule, references to particular pieces of text shall be used instead of repetition of the original source material, since such repetition involves the risk of error or inconsistency and increases the length of the draft standard. However, if it is considered necessary to repeat such material, its source shall be identified precisely.

References shall be made in the forms indicated in 6.7.2 to 6.7.5 and shall not be made to page numbers.

6.7.2 References to the draft standard as a whole in its own text

For an individual draft standard the form “this standard” shall be used, except in the introductory texts for the Normative references (see clause 2) and the Terms and definitions (see clause 3) clauses.

The wording shall be altered as a function of the document type concerned (e.g., this standard, this technical report).

Such references are understood to include all amendments and revisions to the draft standard or technical report.

Do not use the form document or specification when referring to a standard or technical report.

6.7.3 References to elements of text

For references to element on text use, for example, the following forms:

- a) in accordance with clause 3;
- b) according to 3.1;
- c) as defined in 3.1 b);
- d) details as given in 3.1.1;
- e) see Annex B;
- f) the requirements given in B.2;
- g) see the note in table 2;

- h) see 6.6.3, example 2; or
- i) see 3.1, equation (3).

The term subclause shall not be used.

6.7.4 References to figures and tables

Every figure and table included in the document shall normally be referred to in the text.

To reference figure and table use, for example, the following forms:

- a) shown in figure A.6;
- b) (see figure 3);
- c) given in table 2; or
- d) (see table B.2).

6.7.5 References to other documents

6.7.5.1 General

All normative references shall be given in the Normative references clause (see clause 2).

6.7.5.2 References

References may be made only to a complete document or a part thereof.

References shall be understood to include all amendments to and revisions of the referenced document.

Use the following forms:

- a) as specified in ISO/IEC 15888:1996;
- b) (see ISO/IEC 15888:1996);
- c) as specified in SCSI-2; or
- d) (see SCSI-2).

[Editor's Note 15: May review stopped here.](#)

6.8 Representation of numbers and numerical values

The decimal sign shall be a comma on the line in all language versions.

If a value less than one is written in decimal form, the decimal sign shall be preceded by a zero.

EXAMPLE 1 - 0,001

Each group of three digits reading to the left or to the right of a decimal sign shall be separated by a space from preceding digits or following digits respectively, except for four digit numbers designating years.

EXAMPLE 2 - 23 456; 2 345; 2,345; 2,345 6; 2,345 67; but the year 1997

For clarity, the symbol x shall be used to indicate multiplication of numbers and numerical values.

EXAMPLE 3 - Write 1,8 x 10.3 not 1,8 * 10.3.

To express values of physical quantities, Arabic numerals followed by the international symbol for the unit (see ISO 31, ISO 1000 and IEC 60027) shall be used.

6.9 Quantities, units, symbols and signs

The International System of units (SI) as set out in ISO 31 shall be used. Symbols for quantities shall be chosen, wherever possible, from the various parts of ISO 31 and IEC 60027. For further guidance on application see ISO 1000.

The units in which any values are expressed shall be indicated.

The unit symbols for degree, minute and second shall follow immediately the numerical value. All other unit symbols shall be preceded by a space. (See Annex C)

Mathematical signs and symbols shall be in accordance with ISO 31-11.

A list concerning quantities and units to be used is given for information in Annex C.

6.10 Mathematical formulae

6.10.1 Types of equation

Equations between quantities are preferred to equations between numerical values. Equations shall be expressed in mathematically correct form, the variables being represented by letter symbols the meanings of which are explained in connection with the equations, unless they appear in a Definitions, symbols, abbreviations, and conventions clause (see clause 3).

The style shown in example 1 shall be followed.

EXAMPLE 1 -

$$v = \frac{l}{t}$$

where:

- v is the speed of a point in uniform motion;
- l is the distance travelled; and
- t is the duration.

If an equation between numerical values is used, the style shown in example 2 shall be followed.

EXAMPLE 2 -

$$v = 3,6 \times \frac{l}{t}$$

where:

- v is the numerical value of the speed, expressed in kilometres per hour (km/h), of a point in uniform motion;
- l is the numerical value of the distance travelled, expressed in metres (m); and
- t is the numerical value of the duration, expressed in seconds (s).

However, the same symbol shall never be used within a draft standard both for a quantity and for its corresponding numerical value (e.g., use of the equation in example 1 and of the equation in example 2 in the same context would imply that $1 = 3,6$ which obviously is not true).

Descriptive terms or names of quantities shall not be arranged in the form of an equation. Names of quantities or multiletter abbreviated terms (e.g., presented in italics or with subscripts), shall not be used in the place of symbols.

EXAMPLE 3 -

Write

$$\rho = \frac{m}{V}$$

and not

$$\text{density} = \frac{\text{mass}}{\text{volume}}$$

EXAMPLE 4 -

Write

$$\dim(E) = \dim(F) \times \dim(L)$$

where:

- E is energy;
- F is force; and
- L is length.

and not

$$\dim(\text{energy}) = \dim(\text{force}) \times \dim(\text{length})$$

EXAMPLE 5 -

Write

$$t_i = \frac{\sqrt{S_{ME,i}}}{\sqrt{S_{MR,i}}}$$

where:

- t_i is the statistical value for the system i ;
- $S_{ME,i}$ is the residual mean square for the system i ; and
- $S_{MR,i}$ is the mean square due to regression for the system.

and not

$$t_i = \frac{\sqrt{MSE_i}}{\sqrt{MSR_i}}$$

where:

- t_i is the statistical value for the system i ;
- MSE_i is the residual mean square for the system i ; and

MSR_i is the mean square due to regression for the system i .

Notations such as $\frac{v}{\text{km/h}}$, $\frac{l}{m}$, and $\frac{t}{s}$ or $v/(km/h)$, l/m , and t/s for numerical values may be used. They may be useful on the axes of graphs and in the headings of columns in tables.

6.10.2 Presentation

As far as possible, symbols having more than one level of subscript or superscript (see example 1) shall be avoided, as shall any symbols and formulae that would involve printing more than two lines of type (see example 3).

EXAMPLE 1 - $D_{1, \max}$ is preferable to $D_{1_{\max}}$.

EXAMPLE 2 - In the text, a/b is preferable to $\frac{a}{b}$

EXAMPLE 3 - In a displayed formula, use:

$$\frac{\sin[((N+1)\varphi)/2]\sin((N\varphi)/2)}{\sin(\varphi/2)}$$

rather than

$$\frac{\sin\left[\frac{(N+1)}{2}\varphi\right]\sin\left(\frac{N}{2}\varphi\right)}{\sin\left(\frac{\varphi}{2}\right)}$$

EXAMPLE 4 - To express a mass fraction the following method of expression is sufficient:

$$w = \frac{m_D}{m_S}$$

However, the following equation is also acceptable:

$$w = \frac{m_D}{m_S} \times 100 \%$$

but other expressions (i.e., the percentage by mass) should be avoided.

6.10.3 Numbering

If it is necessary to number some or all of the formulae in a draft standard in order to facilitate cross-reference, Arabic numbers in parentheses shall be used, beginning with 1:

$$x^2 + y^2 < z^2 \quad (1)$$

The numbering shall be continuous and independent of the numbering of clauses, tables and figures. Subdivision of formulae (e.g., (2a), (2b)) is not permitted.

For the numbering of formulae in annexes see 6.2.7.

6.11 Values, dimensions and tolerances

Values and dimensions shall be indicated as being minimum or maximum, and specified with their tolerances in an unambiguous manner.

EXAMPLE 1 - 80 mm x 25 mm x 50 mm instead of 80 x 25 x 50 mm.

EXAMPLE 2 - 80 $\mu\text{F} \pm 2 \mu\text{F}$ or $(80 \pm 2) \mu\text{F}$.

EXAMPLE 3 - $80 \frac{+2}{0}$ instead of $80 \frac{+2}{-0}$.

EXAMPLE 4 - 80 mm $\frac{+50}{-25} \mu\text{m}$

EXAMPLE 5 - 10 kPa to 12 kPa instead of 10 to 12 kPa or 10 - 12 kPa.

EXAMPLE 6 - 0 °C to 10 °C instead of 0 to 10 °C or 0 - 10 °C).

In order to avoid misunderstanding, tolerances on values expressed in percent shall be expressed in a mathematically correct form.

EXAMPLE 7 - Write "from 63 % to 67 %" to express a range.

EXAMPLE 8 - Write $(65 \pm 2) \%$ to express a centre value with tolerance.

The form $65 \pm 2 \%$ shall not be used.

The degree should be divided decimally, for example write $17,25^\circ$ rather than $17^\circ 15'$.

See also Annex C.

Any value or dimension that is mentioned for information only shall be clearly distinguishable from requirements.

Annex A (Informative)

Elements of this template

A.1 Paragraph formats

This file is a reference for the paragraph catalog in the template for the body of a draft standard. This paragraph is the basic paragraph format for draft standard, called “paragraph”.

Table A.1 shows the paragraph formats available from the paragraph catalog for this document.

Table A.1 — Draft standard paragraph formats (part 1 of 3)

Paragraph Name	Description
Head0 Head1 Head2 Head3 Head4 Head5 Head6 Head7 Gloss2n, Gloss2t, Gloss2Para	The are the clause and subclause header paragraphs for the standard's body. Head0 is used for a clause title. Head1, ...2, ...3, ...4, ...5, ...6, and ...7, are used to insert the x.1, x.1.1, x.1.1.1, x.1.1.1.1, x.1.1.1.1.1, x.1.1.1.1.1.1, and x.1.1.1.1.1.1.1 subclauses, respectively. Gloss2n is used for glossary entries number followed by Gloss2t and Gloss2Para which are the glossary title and glossary paragraph, respectively.
NoNumHd	This is a clause heading with the same styles as Head0 except this is no clause number and it does not forced to start at the top of a page.
Annex0 Annex0i Annex0t Annex1 Annex2 Annex3 Annex4 Annex5 AnnexGloss2n, AnnexGloss2t, AnnexGloss2Para	These are the clause and subclause header paragraphs for an Annex. Annex0, ...0i, and ...0t are used for the annex title. Annex0t is used to add (Normative) on the second annex title line or Annex0i is used to add (Informational) on the second annex title line. Annex1, ...2, ...3, ...4, and ...5 are used to insert the A.1, A.1.1, A.1.1.1, A.1.1.1.1, and A.1.1.1.1.1 subclauses, respectively. AnnexGloss2n is used for glossary entries number followed by AnnexGloss2t and AnnexGloss2Para which are the glossary title and glossary paragraph, respectively.
RevHead0 RevHead1	These are the clause and subclause header paragraphs for a Revisions clause. RevHead0 is used for the Revisions clause title. The RevHead1 is used to insert the R.x subclause.
Paragraph ParaNoSpace ParagarphWhere	Paragraph is used for most body paragraphs ParaNoSpace is used when there should be no white space before or after the paragraph. ParagarphWhere indents all the lines in the paragraph except the first. This is useful for descriptions of variables that following an equation or the arguments following a procedure call. The paragraph formats that surround a paragraph also affect the white space before and after the paragraph.

Table A.1 — Draft standard paragraph formats (part 2 of 3)

Paragraph Name	Description
IndentList	This is an indented paragraph with no prefix (e.g., no a), 1), or bullet)
UnOrderList0Reset UnOrderList0 UnOrderList1 UnOrderList2 UnOrderList3	These tags produce an a,b,c ordered list. The a) entry should use the UnOrderList0Reset paragraph. Subsequent list entries at the same level as a) use the UnOrderList0 paragraph. Additional levels of indentation and numbering are obtained using the UnOrderList1, UnOrderList2, and UnOrderList3 paragraphs.
OrderedList0Reset OrderedList0 OrderedList1	These tags produce a 1,2,3 ordered list. The 1) entry should use the OrderedList0Reset paragraph. Subsequent list entries at the same level as 1) use the OrderList0 paragraph. One additional level of indentation and numbering are obtained using the OrderedList1 paragraph.
Note NoteExampleText NoteUnorderList0	These paragraph formats are used for notes. The Note paragraph starts a note. If another paragraph needs to be added to a note the NoteExampleText paragraph is used. If an unordered list needs to be added to the note the NoteUnorderList0 paragraph is used.
ExampleNoNumber ExampleList ExampleListAnnex NoteExampleText	These paragraph formats are used for examples. The ExampleNoNumber paragraph starts an example when there is only one example in the subclause (i.e., the example is not numbered). In the main body of the text (i.e., anything but annexes) if there is more than one example in the subclause the ExampleList is used. In the annexes use the ExampleListAnnex paragraph. If another paragraph needs to be added to an example the NoteExampleText paragraph is used.
Table TableAnnex Figure FigureAnnex	These are the table and figure title paragraph formats for the draft standard's body and annexes.
TableFootnote TableFootnoteAnnex TableFootnoteText	This paragraph is used for normative table notes (called table footnotes by ISO). Normative table notes appear in the bottom most footing row in the table. Use Table > Add Rows or Columns (Add Row To Footing) to get footing rows. Do not put normative table notes in a row in the body of the table. For tables in the main body of the text (i.e., anything but annexes) use the TableFootnote paragraph. For tables in the annexes use the TableFootnoteAnnex paragraph. If another paragraph needs to be added to a footnote the TableFootnoteText paragraph is used.
TableNote TableNoteAnnex TableNoteNoNumber	This paragraph is used for informative table notes. Informative table notes appear in a separate footing row above the footing row with footnotes, in any. Use Table > Add Rows or Columns (Add Row To Footing) to get footing rows. Do not put informative notes in a row in the body of the table. The TableNoteNoNumber paragraph starts a note when there is only one note in the table (i.e., the note is not numbered). For tables in the main body of the draft standard (i.e., anything but annexes) if there is more than one note in the table the TableNote paragraph is used all the notes. For tables in the annexes use the TableNoteAnnex paragraph.

Table A.1 — Draft standard paragraph formats (part 3 of 3)

Paragraph Name	Description
FigureFootnote FigureFootnoteAnnex FigureFootnoteText	This paragraph is used for normative figure notes (called figure footnotes by ISO). Normative figure notes appear in the bottom of the figure. For figures in the main body of the draft standard (i.e., anything but annexes) use the FigureFootnote paragraph. For figures in the annexes use the FigureFootnoteAnnex paragraph. If another paragraph needs to be added to a footnote the FigureFootnoteText paragraph is used.
FigureNote FigureNoteAnnex FigureNoteNoNumber	This paragraph is used for informative figure notes. The FigureNoteNoNumber paragraph starts a note when there is only one note in the figure (i.e., the note is not numbered). For figures in the main body of the draft standard (i.e., anything but annexes) if there is more than one note in the figure the FigureNote paragraph is used for all the notes. For figures in the annexes use the FigureNoteAnnex paragraph.
CellBodyCenterMiddle CellBodyLeftMiddle CellBodyRightMiddle	CellBodyCenterMiddle, CellBodyLeftMiddle, and CellBodyRightMiddle are the paragraphs used in the standard cell body in tables. CellBodyCenterMiddle is centered text in the middle of a cell. CellBodyLeftMiddle is a left aligned text in the middle of a cell. CellBodyRightMiddle is a right aligned text in the middle of a cell.
CellHeadingCenterMiddle CellHeadingLeftMiddle CellHeadingRightTop	CellHeadingCenterMiddle, CellHeadingLeftMiddle, and CellHeadingRightTop are the paragraphs used for column headings in tables. CellHeadingCenterMiddle is centered text in the middle of a cell. CellHeadingLeftMiddle is a left aligned text in the middle of a cell. CellHeadingRightTop text is right aligned at the top of a cell.
PageHeader PageFooter	These are the paragraph formats for page headings and footings. They should be used only in the master pages.
EdNote	This is the Editor's Note paragraph format. You may edit the paragraph numbering to insert your initials
Code	This is a monospaced font that should only be used when the draft standard requires code listings.
Contant Cover Title	These are paragraph formats that are used in the front matter, specifically the first two cover pages.

A.1.1 Character formats

Table A.2 shows the character formats available from the character catalog for this document.

Table A.2 — Draft standard character formats

Name	Description
Arial	Use to set the font to 10pt Arial. Good to use in figures.
ClearChangeBar	Use to clear a change bar from a line of text.
NotBold	Used by the Table Sheet variable.
SmallCaps/FieldName	Use this to put field names in small caps.
Strikethrough/Delete	Use to indicate text that will be removed from the document.
Subscript	Used in equations and variables.
Symbol	Used in equations and for non-text characters
Superscript	Used by cross reference for table footnotes and in equations.

A.1.2 Fonts

Table A.3 shows the fonts that should be used in a draft standard. Use of fonts other than those listed in table A.2 may result in errors during generation of the Acrobat file.

Table A.3 — Draft standard fonts

Name	Description
Arial	Used for all text except as indicated in this table.
Courier New	Used for programing source code listings.
Symbol	Used for equations and for characters that are available in the standard character set.

A.2 Variables

A.2.1 Standard variables

Table A.4 shows the FrameMaker standard variables modified by this document for use in working drafts.

Table A.4 — FrameMaker variables modified for draft standards

Name	Description
Table Sheet	Append this to the end of a table title when the table crosses a page boundary

A.2.2 Draft standard variables

Table A.5 shows the draft standard related variables defined in this document.

Table A.5 — Draft standard variables

Name	Description
DocANSNumber	ANSI number for the draft standard (e.g., INCITS 367.2004)
DocISONumber	ISO number for the draft standard (e.g., 14776-313 : 2005)
DocName	Name of draft standard (e.g., “SCSI Primary Commands -2”)
DocName + acronym	Name of draft standard with acronym (e.g., “SCSI Primary Commands -2 (SPC-2)”)
DocProject	INCITS project number for draft standard (e.g., T10/1416-D)
DocRevDate	Date of current revision (e.g., 18 March 2005)
DocRevNumber	Number of current revision (e.g., Revision x)
DocStatusType	Either “Working Draft” (typical) or “dpANS” (after letter ballot)

A.3 Cross reference formats

Table A.6 shows the draft standard related variables defined in this document.

Table A.6 — Draft standard cross reference formats (part 1 of 2)

Name	Text	Description
(see clause)	(see clause x)	Use for parenthetical references to clauses
(see dot-clause)	(see x.y.z)	Use for parenthetical references to subclauses
(see figure)	(see figure x)	Use for parenthetical references to figures
(see table)	(see table x)	Use for parenthetical references to tables
Annex	Annex x	Use for a start of sentence reference to an annex
annex	annex x	Use for a mid-sentence reference to an annex
Clause	Clause x	Use for a start of sentence reference to a clause or any reference to a subclause (avoid doing this)
clause	clause x	Use for a mid-sentence reference to a clause
dot-clause	x.y.z	Use for a mid-sentence reference to a subclause
Figure	Figure x	Use for a start of sentence reference to a figure

Table A.6 — Draft standard cross reference formats (part 2 of 2)

Name	Text	Description
figure	figure x	Use for a mid-sentence reference to an figure
Table	Table x	Use for a start of sentence reference to a table
table	table x	Use for a mid-sentence reference to an table
tableFootnote	x	Use in tables for references to table footnotes

A.4 Table formats

Table A.7 shows the draft standard related variables defined in this document.

Table A.7 — Draft standard table formats

Name ^a	Example	Description
CodeList	table A.1	Used for a table where there are lines between the rows
CodeList0Lines	this table	Used for a table where there are no lines between the rows
DataStructure	table B.3	Used for a data structures (e.g., in a mode page or a CDB format)
NoLinesNoBorder	none	Used for making lists of items (e.g., list of abbreviations)
^a This column contains a list of defined table formats and is an example of how to place a normative note in a table.		

A.5 Master pages

Table A.8 shows the master pages defined in this document.

Table A.8 — Draft standard master page

Name	Description
Left	Used for all left pages except as noted in this table. This master page is selected automatically by Framemaker for all left hand pages.
Right	Used for all right pages except as noted in this table. This master page is selected automatically by Framemaker for all right hand pages.
X3CoverPage	Used for the first page of the cover material in the draft standard (i.e., the first INCITS cover page).
GenCoverPage	Used for cover material pages other than the first one (i.e., the second, third, and fourth cover pages).
First numbered page	Used for the first page of the main body material in the draft standard (i.e., the page that starts with clause 1).

Annex B
(Informational)

SCSI CDB and Data Structure Examples

B.1 Example of a 6 byte CDB format

Editor's Note 16: An example 6 byte CDB is shown in table B.1. An example data structure is shown in table B.2. Edit, cut, copy, paste as desired.

Table B.1 — Example 6 byte CDB

Bit Byte	7	6	5	4	3	2	1	0
0	OPERATION CODE (03h)							
1	Reserved							
2	Reserved							
3	Reserved							
4	ALLOCATION LENGTH							
5	CONTROL							

B.2 Example data structure

Editor's Note 17: Example data structure that you can cut, copy, paste, etc.

Table B.2 — Example data structure

Bit Byte	7	6	5	4	3	2	1	0
0	VALID	RESPONSE CODE (70h or 71h)						
1	Obsolete							
2	FILEMARK	EOM	ILI	Reserved	SENSE KEY			
3	(MSB)	INFORMATION						
6								(LSB)
7	ADDITIONAL SENSE LENGTH (n-7)							
8	(MSB)	COMMAND-SPECIFIC INFORMATION						
11								(LSB)
12	ADDITIONAL SENSE CODE							
13	ADDITIONAL SENSE CODE QUALIFIER							
14	FIELD REPLACEABLE UNIT CODE							
15	SKSV	SENSE-KEY SPECIFIC						
17								
18	Additional sense bytes							
n								

B.3 Ten byte CDB

Editor's Note 18: Table B.1 is an example of a ten byte CDB. Use the entire structure and edit or use those pieces you need.

Table B.3 — Ten byte CDB example

Bit Byte	7	6	5	4	3	2	1	0
0	OPERATION CODE (4Dh)							
1	Reserved						PPC	SP
2	PC		PAGE CODE					
3	Reserved							
4	Reserved							
5	(MSB) _____							
6	PARAMETER POINTER						(LSB) _____	
7	(MSB) _____							
8	ALLOCATION LENGTH						(LSB) _____	
9	CONTROL							

B.4 Twelve byte data structure

Table B.2 is a twelve byte data structure example.

Table B.4 — Parameter data for the COPY STATUS service action

Bit Byte	7	6	5	4	3	2	1	0
0	(MSB) _____							
3	AVAILABLE DATA (00000008h)						(LSB) _____	
4	HDD		STATUS					
5	(MSB) _____							
6	SEGMENTS PROCESSED						(LSB) _____	
7	TRANSFER COUNT UNITS							
8	(MSB) _____							
11	TRANSFER COUNT						(LSB) _____	

B.5 Sixteen byte CDB example

Table B.3 is a sixteen byte CDB example.

Table B.5 — Sixteen byte CDB example

Bit Byte	7	6	5	4	3	2	1	0
0	OPERATION CODE (84h)							
1	Reserved			SERVICE ACTION				
2	LIST IDENTIFIER							
3	Reserved							
4	Reserved							
5	Reserved							
6	Reserved							
7	Reserved							
8	Reserved							
9	Reserved							
10	(MSB)							
11								
12	ALLOCATION LENGTH							
13	(LSB)							
14	Reserved							
15	CONTROL							

Annex C (Normative)

Quantities and units

The following list comprises provisions that are specified elsewhere in the ISO/IEC Directives, or in the particular International Standards dealing with quantities and units:

- a) The decimal sign shall be a comma;
- b) International Standards shall use only:
 - A) SI units, as given in the various parts of ISO 31;
 - B) a few additional units used with the SI, namely minute (min), hour (h), day (d), degree ($^{\circ}$), minute ($'$), second ($''$), litre (l), tonne (t), electronvolt (eV), and unified atomic mass unit (u), as shown in ISO 31-0:1992;
 - C) the units neper (Np), bel (B), sone, phon and octave, which are also given in ISO 31;
 - D) the units baud (Bd), bit (bit), octet (o), byte (B), erlang (E), hartley (Hart), natural unit of information (nat), shannon (Sh), and var (var), which are given in IEC 60027 for use in electrical technology and information technology.

NOTE 5 - For consistency, in International Standards only the symbol "l" is used for litre, although the symbol "L" is also given in ISO 31.

- c) Do not mix symbols and names of units (e.g., write either "kilometres per hour" or "km/h", and not "km per hour" or "kilometres/hour");
- d) Combine numerical values written in figures with unit symbols (e.g., "5 m"). Avoid such combinations as "five m" and "5 metres". There shall be a space between the numerical value and the unit symbol except in the case of superscript-type unit symbols used for plane angle (e.g., $5^{\circ}6'7''$). However, the degree should be subdivided decimally;
- e) Do not use non-standardized abbreviated terms for units (e.g., "sec" instead of "s" for seconds, "mins" instead of "min" for minutes, "hrs" instead of "h" for hours, "cc" instead of "cm³" for cubic centimeters, "lit" instead of "l" for liters, "amps" instead of "A" for amperes, "rpm" instead of "r/min" for revolutions per minute);
- f) Internationally standardized unit symbols shall not be modified by adding subscripts or other information;

EXAMPLE 1 -

- a) "U_{max} = 500 V" and not "U = 500 V_{max}";
- b) "a mass fraction of 5 %" and not "5 % (m/m)";
- c) "a volume fraction of 7 %" and not "7 % (V/V)"; or
- g) Do not mix information with unit symbols (e.g., write "the water content is 20 ml/kg" and not "20 ml H₂O/kg" or "20 ml of water/kg").
- h) Abbreviated terms such as "ppm", "pphm" and "ppb" shall not be used as they only stand for numbers, which are always more clearly expressed by means of digits;

EXAMPLE 2 -

- a) "the mass fraction is 4,2 $\mu\text{g/g}$ " or "the mass fraction is $4,2 \times 10^6$ " and not "the mass fraction is 4,2 ppm"; or
- b) "the relative uncertainty is $6,7 \times 10^{12}$ " and not "the relative uncertainty is 6,7 ppb";
- i) Equations between quantities are preferred to equations between numerical values.
- j) The quantity "weight" is a force (i.e., gravitational force) and is measured in newtons (N). The quantity "mass" is measured in kilograms (kg);
- k) Quotient quantities shall not contain the word "unit" in the denominator (e.g., write "mass per length" or "lineic mass" and not "mass per unit length");
- l) Distinguish between an object and any quantity describing the object (e.g., between "surface" and "area", "body" and "mass", "resistor" and "resistance", "coil" and "inductance");

- m) Units shall be placed on all numerical values when a range is specified;

EXAMPLE 3 -

- a) "10 mm to 12 mm" and not "10 to 12 mm" or "10 – 12 mm";
 - b) "0 °C to 10 °C" and not "0 to 10 °C" or "0 – 10 °C";
 - c) "24 mm . 36 mm" and not "24 . 36 mm" or "(24 . 36) mm";
 - d) "23 °C ± 2 °C" or "(23 ± 2) °C" and not "23 ± 2 °C"; and
 - e) "(60 ± 3) %" and not "60 ± 3 %" or "60 % ± 3 %";
- n) Two or more physical quantities shall not be added or subtracted unless they belong to the same category of mutually comparable quantities. Accordingly, the method of expression for a relative tolerance such as $230 \text{ V} \pm 5 \%$ does not conform to this basic law of algebra.

The following methods of expression may be employed instead:

- A) "(230 ± 11,5) V"; or
- B) "230 V, with a relative tolerance of ± 5 %".

The following form is often used, although not correct: $(230 \pm 5 \%) \text{ V}$;

- o) Do not write "log" in formulae if the base needs to be specified. Write "lg", "ln", "lb" or "log_a"; and
- p) Use the mathematical signs and symbols recommended in ISO 31-11 (e.g., "tan" and not "tg").