

Passive interconnect performance working group (PIP) 01-191r1
August 14, 2001
Santa Ana, CA

Subject: Approved minutes for the SCSI passive interconnect performance working group, PIP, in Hartford, CT on June 12-13, 2001

Zane Daggett of Hitachi, chair led the meeting. Bill Ham of Compaq, secretary, took these minutes. Greg Vaupotic of Amphenol Spectra-Strip hosted the meeting.

Previous approved minutes: 01-127r1

1. Introduction.....	2
2. Attendance.....	2
3. Agenda development.....	2
4. Approval of previous minutes.....	2
5. Review of action items.....	3
6. Administrative structure:.....	3
7. Review of industry activities.....	3
8. Presentations on new topics.....	3
8.1 Ultra 640 attenuation values, Larry Barnes.....	3
8.2 Periodic structure swept z vs sample length, Greg Vaupotic.....	4
9. Presentations on old topics.....	4
9.1 Effects of periodic structures continued, Larry Barnes, LSI Logic.....	4
9.2 Backplane and cable assembly characterization methodology, Bruce Manildi, Seagate.....	4
10. Effects of non-uniformities and/or periodic structures.....	4
10.1 Effects of periodic structures continued, Larry Barnes, LSI Logic.....	4
11. Round robins.....	5
11.1 Bulk cable round robin 1.....	5
11.2 Bulk cable round robin 2 (Expanded parameter set), Greg Vaupotic, Amphenol Spectra Strip.....	5
11.2.1 Status of bulk cable round robin 2.....	11
11.3 Backplane round robin 1, Umesh Chandra, Seagate.....	12
11.4 Cable Assembly round robin 1, Martin O., Molex.....	12
11.4.1 Update / con call minutes review, Martin O., Bob G.	13
12. Propagation Time:.....	19
13. Proposed new round robins.....	23
14. Frequency dependence of dielectric constant test methodology - Barnes, LSI Logic; Vaupotic, Spectra strip.....	23
15. Worst case vs spec numbers strategy.....	24
15.1 To meet the non-precomp receiver requirements.....	24
15.2 To meet the precomp receiver requirements.....	25
15.3 Interoperability points.....	25
16. Project proposal for PIP - all.....	26
17. PIP documentation - Daggett.....	26
17.1 Topics for consideration for the passive interconnect test document.....	26
17.1.1 Components of passive interconnect.....	26
17.1.2 Instrumentation / measurement methods:.....	27
17.1.3 Acceptable performance values.....	27
18. Starting point for specifying application of tests.....	27
18.1 Definitions for the document - Barnes.....	28

19. Architectural definitions.....	28
20. Old business.....	28
21. New business.....	34
21.1 Standardization of cable sub assemblies, Greg Vaupotic.....	28
21.2 Skew measurement and specification methodology, Ham.....	36
22. Next meetings.....	36
23. Action Items:.....	36
23.1 Old action items from previous meetings.....	36
23.2 New actions from this meeting.....	37
24. Adjourn.....	37

1. Introduction

Zane Daggett opened the meeting, thanked the host, conducted the introductions, and reviewed the meeting purpose.

2. Attendance

The following folks were present:

Name	Organization	e-mail	Phone
Bill Ham	Compaq	Bill_ham@ix.netcom.com	978-828-9102
Bob Gannon	JPM	rgannon@jpmco.com	860-537-6800
Greg Vaupotic	Amphenol Spectra-Strip	Greg.vaupotic@snet.net	203-287-7425
Larry Barnes	LSI Logic	Larry.barnes@lsil.com	719-533-7432
Nicholaos Limberopoulos	C&M	nlimberopoulos@cmcorpor ation.com	860 779-4815
Paul Aloisi	Texas Instruments	paul_aloisi@ti.com	603-429-8687
Richard Uber	Maxtor	Richard.uber@quantum.co m	508-770-2568
Zane Daggett	Hitachi Cable	zdaggett@hcm.hitachi.co m	603-669-4347 x.236

3. Agenda development

The agenda shown was that used (moved by Ham / Daggett). Passed unanimously.

4. Approval of previous minutes

Greg Vaupotic moved and Bill Ham seconded that the draft minutes from the previous meeting be approved as modified. Motion passed unanimously.

The methodology for minutes uses the draft/approved minutes scheme with posting to the t10 web site of the minutes as the vehicle for publication. Postings are announced to the SCSI reflector after the posting is verified to be on the web site.

Minutes will be in .pdf format.

5. Review of action items

Action items were reviewed and the status is listed below in the action items section.

6. Administrative structure:

The present administrative structure is:

Chair: Zane Daggett, Hitachi

Vice Chair: open

Secretary: Bill Ham, Compaq

Due to Dave Chapman focusing on serial instead of parallel a call for a new vice chair was made. Greg Vaupotic agreed to take on the vice chair role.

7. Review of industry activities

Bill Ham briefly reviewed the T10, T11, and SFF activities relating to testing and modeling. He noted that the T11 modeling activity has had its third meeting and is in the process of producing its first draft document. The next meeting scheduled for T11 week in June 2001.

8. Presentations on new topics

8.1 Ultra 640 attenuation values, Larry Barnes

Larry presented a few slides that claimed that no more than 6dB at any frequency can be compensated by either precompensation or AAF schemes. Larry is actioned to put his document on the web site.

The assertion that 6 dB is a fundamental limit was challenged by Maxtor.

Bill Ham pointed out that the limits will be different depending on whether a precompensation or an AAF scheme is being used.

8.2 Periodic structure swept z vs sample length, Greg Vaupotic

Greg showed several examples where the swept frequency impedance exhibited a very regular but quite unexpected response to the different lengths of sample tested. The samples were twist and flat with the flats spaced at the same interval along the entire length.

Greg is actioned to put this data on the T10 web site.

9. Presentations on old topics

9.1 Effects of periodic structures continued, Larry Barnes, LSI Logic

9.2 Backplane and cable assembly characterization methodology, Bruce Manildi, Seagate

Bruce presented a set of approaches for characterizing backplanes and cable assemblies. He also proposed engaging Gigatest Labs for purposes of helping the PIP and SSM groups with developing procedures and sharing the cost amongst group members. No detailed statement of work was presented. It was agreed by the group that this approach could have merit but may need special consideration for execution under the procedures of T10.

Bill Ham is actioned to contact John Lohmeyer to determine what process to use, if any, to share the cost of consultants to help develop procedures for test and modeling of passive interconnect.

10. Effects of non-uniformities and/or periodic structures

10.1 Effects of periodic structures continued, Larry Barnes, LSI Logic

[not discussed in April]

Larry presented a spread sheet that reports the loaded impedance and velocity of propagation based on frequency, unloaded impedance, separation of loads, capacitance of loads assuming no stub length. Larry agreed to make this spreadsheet available on the web.

Larry Barnes is actioned to place his spreadsheet on the T10 web site.

11. Round robins

A new document has been created to document the details of the round robin testing activities for PIP that have been substantially completed. All details for completed round robins will be contained in this new document and will be removed from the active minutes. At the moment the only round robin in this category is cable media round robin 1. Please see the new document "PIP round robin testing" for information about cable media round robin 1.

The following motion made in the last meeting is retained due to its important content for round robin testing.

Motion Daggett/Martin O that samples used for round robins will be identified by the manufacturer of the samples in the active minutes unless the manufacturer specifically requests that his sample be identified in a way that does not indicate the manufacturer. It is understood that the final published results and details in the "PIP round robin testing" document will not contain any manufacturer identifications.

Motion passes 11/0/1

11.3. Cable Assembly round robin 1, Martin O., Molex

11.3.1. Update / con call minutes review, Martin O., Bob G.

11.1 Bulk cable round robin 1

[Data from this round robin has been transferred to 01-076.

Adaptec presented data that does not agree well with other data. Adaptec did not use the same set up (did not use the baluns) but did use ATN VNA. See 00-076r1 for details.

Spectra strip data was added to 01-076r1.

This round robin is complete except for one data point from Adaptec.

11.2 Bulk cable round robin 2 (Expanded parameter set), Greg Vaupotic, Amphenol Spectra Strip

[Material in this section is retained in the minutes until such time as the report for this round robin is complete enough to transfer to 01-076.]

Round robin 2 is based on a significantly more precise specification of the measurement details than round robin 1.

OBJECTIVE

For several characteristics, determine simplest measurement method which compares favorably to the best method. This is accomplished by measuring several samples using several methods, with results being compared later. Most Round-Robin participants will not be able to use all methods; each will do what they can.

DATA PRESENTATION

- Data presented in MS Excel spreadsheets, for later by compilation by coordinator. Participants not able to present electronically are, of course, permitted to present data as recorded.
- Graphs/plots presented prior to final compilation shall be 1 to 1000 MHz, log frequency, even though impedance data is only collected down to 10 MHz. This facilitates comparing data sets for resonance effects.
- Report impedance as differential Ohms. "Attenuation" shows gain as dB / meter.
- Report Propagation time Skew as measured (e.g.: 127 ps / 25 meter length) as table (Excel).

SAMPLES

All samples are 25 meter length. Unshielded samples (twisted pair ribbons) are to be suspended from ceiling, with minimum of crossovers and keeping sample as spread out as possible (to minimize crosstalk effects).

Sample 1 Round twisted pair cable having overall shield, 28 AWG 7-36 TC (Hitachi)

Measure pairs 1 (Heat shrink 1), 7 (Heat shrink 2), and 34 (Heat shrink 3) (each pair to be secured with heat shrink tubing)

Sample 2 Round twisted pair cable having overall shield, 30 AWG solid TC (Madison)

Measure pairs 1 (Heat shrink 1), 7 (Heat shrink 2), and 34 (Heat shrink 3) (each pair to be secured with heat shrink tubing)

Sample 3 Twisted pair ribbon having no flats. (Spectra-Strip)

Measure pairs 1, 3, and 5 (wires 1-2, 5-6, and 9-10)

Sample 4 Twisted pair ribbon having flats at TDB inch intervals (Hitachi)

Measure pairs 1, 3, and 5 (wires 1-2, 5-6, and 9-10)

ATTENUATION

Record S21 using log scale (really is gain). Use 30 Hz IF BW. Where possible, use 401 points. Record from 1 to 1000 MHz, log sweep. In addition to recording sweep, record actual values (using "markers") at 80, 160, and 200 MHz.

Balun Methods, using fixture described in 00-339r0 (balun with matching resistors). For consistency, use matching network comprised of one 68 Ω shunt and two 47 Ω series resistors (1/8 W 5% carbon).

Method A Calibrate by storing fixture response. Then measure sample. Then remove fixture response. ("normalized")

Method B Full 2-port calibration. Use $121 \Omega \pm 1\%$ chip resistor (Panasonic EJR series) for "load", for "short" solder test points of fixture together, for "open" position matching resistors as will be when measurement is made. For "thru", attach both fixtures together.

4-port Network Analyzer Methods:

Method C Full 4-port calibration. Calibrate for 100Ω environment.

Method D Full 4-port calibration. Calibrate for 122Ω environment (software "corrects" for Z).

DIFFERENTIAL IMPEDANCE

Use 30 Hz IF BW. Where possible, use 401 points. Record from 10 to 1000 MHz, log sweep.

Hybrid Junction Method

Method E See Appendix 1 for outline regarding fixture and calibration.

4-port Network Analyzer Method

Method F Full calibration of one differential port. Calibrate for 100 Ω environment.

SKEW PAIR to PAIR

Per SPI-3 TDR method. Please record propagation time of each leg of each pair. Pair propagation time is the average of these two readings. Doing this allows us to examine within pair skew.

Pair #	Propagation time + signal	Propagation time - signal	Pair propagation time Average (+,-Sig)
1 (or shrink 1)			
3 (or shrink 2)			
5 (or shrink 3)			

LOGISTICS

Companies providing a sample will send to first name on below list. Round cable sample shall be on spools. Flat cable sample shall be on pads.

The first person on the list will send samples to second person. The second to the third, and so forth.

Company	Person	Address	
Amphenol Spectra-Strip	Greg Vaupotic (203) 287-8725	720 Sherman Ave Hamden CT 06410	greg.vaupotic@snet.net
Hitachi Cable	Zane Daggett (603) 669-4347	900 Holt Avenue Manchester NH 03109	zdaggett@hcm.hitachi.com
Madison Cable	Jie Fan (508) 752-2884	125 Goddard Memorial Dr. Worcester MA 01603	jie.fan@madisoncable.com
Seagate	Umesh Chandra (831) 439-7264	4585 Scotts Valley Drive Scotts Valley CA 95066	Umesh_chandra@seagate.com
Adaptec	Dave MacQuown 408 957-6749	691 South Milpitas Blvd, Milpitas CA 95035	david_macquown@corp.adaptec.com
END Amphenol	Greg Vaupotic	720 Sherman Ave	greg.vaupotic@snet.net

Spectra-Strip	(203) 287-8725	Hamden CT 06410	et
---------------	----------------	-----------------	----

TEST METHOD CAPABILITIES

Table below shows anticipated test capabilities of participants.

Company	Balun A	Balun B	4-port C	4-port D	Hybrid E	"4-port" F
Amphenol	yes	yes	maybe	maybe	yes	maybe
Hitachi Cable	yes	yes	no	no	yes	no
Madison Cable	no	no	yes	yes	no	yes
Seagate	yes	yes	no	no	yes	no
Adaptec	tbd	tbd	yes	yes	tbd	tbd

APPENDIX 1

Hybrid Junction Test Fixture

The hybrid junction converts an unbalanced 50 Ω input into two balanced 50 Ω outputs (two signals having 180° phase, 100 Ω differential). The selected hybrid junction is the M/A-COM H-183-4. This is specified from 30 MHz to 3 GHz. However, it may be used from 10 MHz to 3 GHz when used with a careful calibration.

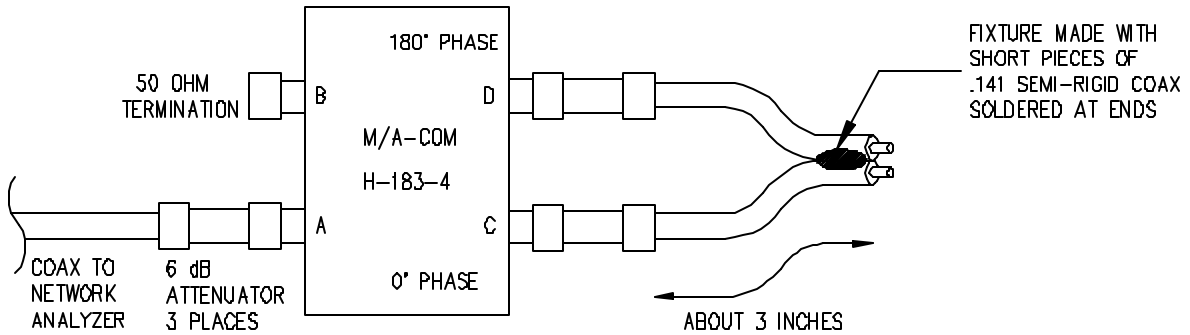

OUTLINE for Calibration Procedure

Attach fixture to analyzer port 1. Semi-rigid coax strongly recommended.

Preset Network Analyzer to default condition. Then set analyzer to:
Power = 10 dBm Points = 401 Linear Sweep (??) Start = 10 MHz
Stop = 1 GHz
30 Hz IF BW

With attenuators attached, BUT with semi-rigid fixture removed, calibrate port 1. This is accomplished using precision standards attached to the two attenuators on the right.

Two sets of standards are required.

When finished calibrating port 1, attach semi-rigid coax fixture (which, having no sample attached, is an "open" circuit)

- Set analyzer to look at S11 Phase. Set phase scale to 10° per division.
- Enable port extensions
- Adjust port-1 extension for 0° across the frequency range (expected for an open circuit). This compensates for the fixture's propagation propagation time. Above 800 MHz, it will not be possible to achieve exactly 0°. This is because the fixture is not a perfect open circuit. The attachment stubs cause small undesired parasitics. (Port extension for above fixture is about 380 ps.)
- Set the analyzer to look at S11 Set Z Reflected = On Set scale = Linear

Important - The analyzer has been calibrated to 50 Ω . The actual impedance at the calibration plane was, in fact, 100 Ω differential. Multiply measurements by two for differential impedance.

Measurement using Open/Short Method

Two measurements are required for each pair that is examined. First, record the impedance of the pair with the far-end "open". Then record again with the far end "shorted". The impedance is then calculated with the following equation:

$$Z = \sqrt{(Z_{\text{OPEN}})(Z_{\text{SHORT}})} \quad \text{This is the value to}$$

report.

11.2.1 Status of bulk cable round robin 2

Seagate now has the samples and Seagate will forward to Adaptec in the sequence shown in the chart.

All samples are 25 meter length.

Hitachi Cable Manchester: Sample 1

Round twisted pair cable having overall shield, 28 AWG 7-36 TC (Hitachi)

Prep both ends:

pair 1 (Heat shrink 1),
pair 7 (Heat shrink 2),
and pair 34 (Heat shrink 3) (each pair to be secured with heat shrink tubing)

Madison: Sample 2

Round twisted pair cable having overall shield, 30 AWG solid TC (Madison)

Prep both ends:

pairs

1 (Heat shrink 1),
7 (Heat shrink 2),
and 34 (Heat shrink 3) (each pair to be secured with heat shrink tubing)

Spectra-Strip: Sample 3

Twisted pair ribbon having no flats, 30 AWG Solid TC

Zane: Sample 4

Twisted pair ribbon having flats at 250mm intervals (Hitachi)

11.3 Backplane round robin 1, Umesh Chandra, Seagate

This effort is needed to add backplane testing methodology to the test suite. The basic idea is to acquire some small selection of SCSI backplanes and send these around for testing at different companies.

Umesh has a non-product backplane design that could be used. Bill Ham thinks that he may have some older backplanes that are not products that could be used.

Umesh is actioned to select 2 boards for use in the round robin.

Ham is actioned to select 2 boards for use in the round robin.

Umesh is actioned to propose a set of tests to be used including things like test fixtures and specific slots to be measured.

Participants include: Seagate, Compaq?, Adaptec?, IBM?, Quantum?,

Umesh has certain hardware that could be useful in exciting the interconnect under test. The initial cut should focus on the "Data spewing" card (disk drive card) with a data interface through the SCA connector that allows programming of the data pattern through an HBA using the SCSI transport. Umesh is actioned to determine if/when the data spewing card could be made available to the industry for use in PIP applications.

Motion Ham / Umesh that PIP will document a cost effective eye diagram based test methodology for passive interconnect that will be part of a test suite for performance requirements.

Motion passes 10/0.

11.4 Cable Assembly round robin 1, Martin O., Molex

Martin O. presented his view of the content and timing of this round robin. As there was not enough time to explore all the details in this meeting needed to structure a "good" round robin a reduced, two company round robin will be completed before February 2001. Martin agreed to structure a preliminary round robin intended to refine the parameters of the real cable assembly round robin 1. The companies that will deliver results to the February meeting are Molex and JPM.

As this is the first attempt to do a round robin on cable assemblies and since the details of the tests for cable assemblies are still not defined this round robin must be considered as a preliminary investigation of test methods.

11.4.1 Update / con call minutes review, Martin O., Bob G.

Document contains minutes from two separate teleconference.

Notes by Martin O. from 2/15/01 Teleconference for PIP round robin cable assembly testing .

1. Update on the PIP round robin cable assembly:

a) The following cable assemblies have been received by Molex:

Sample A-[30 (7/38) AWG non shielded flat multidrop Micro Quick Twist] Hitachi Cable Manchester

2m total length built from a 2m section of the 10m supplied.

500mm center to center drops with a total of 5 HD68 connectors

Sample B-[30 (7/38) AWG non shielded round multidrop] Madison Cable Corporation

2m total length built from a 2m section of the 10m supplied. 500mm

center to center drops total 5 connectors HD68 Connectors

Sample C-[30 AWG solid non shielded twisted flat point to point] Spectra-Strip (Amphenol) (without flats on the ends)

6m total length built from a 6m section of the 20m supplied. VHDCI connectors on the ends (last resort HD connectors)

Sample D-[30 AWG solid shielded round point to point] Madison Cable Corporation

6m total length made from 6m of a total of 20m supplied.

VHDCI connectors on the ends.

Sample E-[34 AWG solid shielded round point to point] Temp-flex

6m total length made from 6m of a total of 20m supplied.

VHDCI connectors on the ends.

2. There were concerns that the idt termination will be damaged after several repeated plug in and plug out in the course of testing. A couple of remedies were suggested: 1) To make several samples with identical characterizations. 2) To use adapters to protect the damage to the connector/cable termination. 3) To eliminate damaged lines in the course of the round robin and collect data only where the lines are in good condition.

3. Impedance Measurement:

Network analyzer impedance measurement was ruled out as an option because of measurement difficulties for the sample lengths.

Everyone in the meeting agreed to use TDR measurement instrument.

Also everyone confirmed he or she has TEK 11801 available.

There was a measurement resolution concern measuring with launch signals at 1 ns. It was suggested to add impedance measurement at launch signals of 500 ps risetime.

4. Attenuation measurement:

It was pointed out that the SPI-4 spec recommended attenuation measurement with raw cable lengths that can yield 6 dB loss. Since the cable assemblies are fixed in length, the group plan to come up with measurement method to be reviewed in the next week meeting. This was an action item for Molex.

5. Group member update:

Notes by Zane D. from 12/19/00 conference call as amended in this meeting.

1. Discussions on cables to use for the test.
 - a. Cable assemblies?
 - b. Point to Point!
 - c. Multi-drops!

2. Availability of connectors and tooling.

3. Cable shipping packaging and total lengths.
 - a. See above

4. Time frame for cable delivery and shipping address.
 - a. Send to Bob Gannon
 - b. By the 29th of December all samples should be in Bob Gannon's hands. Attn: Mario Sahagun
JPM Pantera
Montemorelos No. 121
Fracc. Loma Bonita
Zapopan, Jalisco 45060 Mexico

5. Run down of tests to be conducted by Molex and JPM.
 - a. Attenuation [1Mhz to 1Ghz]
 - b. Crosstalk [NEXT & FEXT - TDR]
 - c. Impedance [Diff- first company to test needs to organize a conf. call to discuss test parameters TDR]
 - d. Propagation time [Time Domain TDT] for entire length
 - e. Number of pairs to test is 6 pairs. 2 pairs from the center 4 pairs against the shield. In the case of flat cable, test 2 from each edge and ACK and REQ in the inner pairs of the cable.
 - f. Basically data pairs 10, 11, 12 & 13 then ACK and REQ pairs. However, Bob Gannon can change these parameters if he feels it is necessary. It is requested, though, that we leave ACK and REQ in the pairs identified.

6. Time frame for phase 1 cable round robin test.
 - a. February 6th is the final deadline for testing

- b. It is requested that JPM and Molex complete the testing by the February meeting.
- c. All samples will be sent to Bob Gannon at JPM then built and tested by JPM.
- d. Bob Gannon of JPM will forward samples to Martin O. at Molex.
- e. Martin O. of Molex will make fixtures and send them onto Bob Gannon by January 5th.
- f. Bob Gannon will need to test and send samples to Martin at Molex by the 16th of January (Bob to coordinate other time arrangements with Martin). Both JPM and Molex will present results at the next meeting in February, schedule in S. California.
- g. Ken Plourde Temp-flex to submit sample E to Bob Gannon by Friday Feb 23. Bob will make the assembly and send to Martin at Molex by March 02.

The following is detail of Martin O's proposed test procedures for cable assembly round robin 1.

Objective:

This note describes a set of test to characterize the electrical performance of cable assemblies for the cable assembly round robin test. Test will be conducted at different locations and data and methods compared for measurement data consistencies. This will be accomplished by measuring several samples, and results compared later. Most Round-Robin participant will not be able to conduct all tests, each will do what they can.

Samples:

Sample A-[30 (7/38) AWG non shielded flat] Hitachi Cable
Manchester Micro Quick Twist with 2m build sampling 10m
500mm center to center drops total 5 cables HD Cables

Sample B-[30 (7/38) AWG non shielded round] Madison Cable
Corporation Round non-shielded with 2m build sampling 10m
500mm center to center drops total 5 cables HD Cables

Sample C-[30 AWG solid non shielded round] Spectra-Strip
(Amphenol) Flat Twisted cable (with or without flats on the ends)
with 6m build sampling 20m
Point to point at 6m, VHDCI cables

Sample D-[30 AWG solid shielded round] Madison Cable Corporation
Round shielded cable with 6m build sampling 20m, Point to point at
6m,
VHDCI cables

Test Parameter:

- a. Attenuation [1Mhz to 1Ghz]
- b. Crosstalk [NEXT & FEXT - TDR]
- c. Impedance [Diff- TDR]
- d. Propagation time [Time Domain TDT] for entire length
- e. Number of pairs to test is 6 pairs. 2 pairs from the center, 4 pairs against the shield. In the case of flat cable, test 2 from each edge and ACK and REQ in the inner pairs of the cable.

f. Basically data pair 10, 11, 12 & 13 then ACK and REQ pairs

Test Equipment:

1. Network Analyzer
2. TDR
2. Molex Proprietary Test Fixtures
4. Coax Test Leads
5. Differential Baluns

Attenuation:

Frequency domain Measurement conducted in differential mode. Record S_{21} using log scale. Use 30 Hz IF bandwidth. For better resolution, use 1601 points. Record from 1Mhz to 1GHz. Use Log frequency sweep. Also record values at 80, 160, 200, and 320 MHz.

Test Setup:

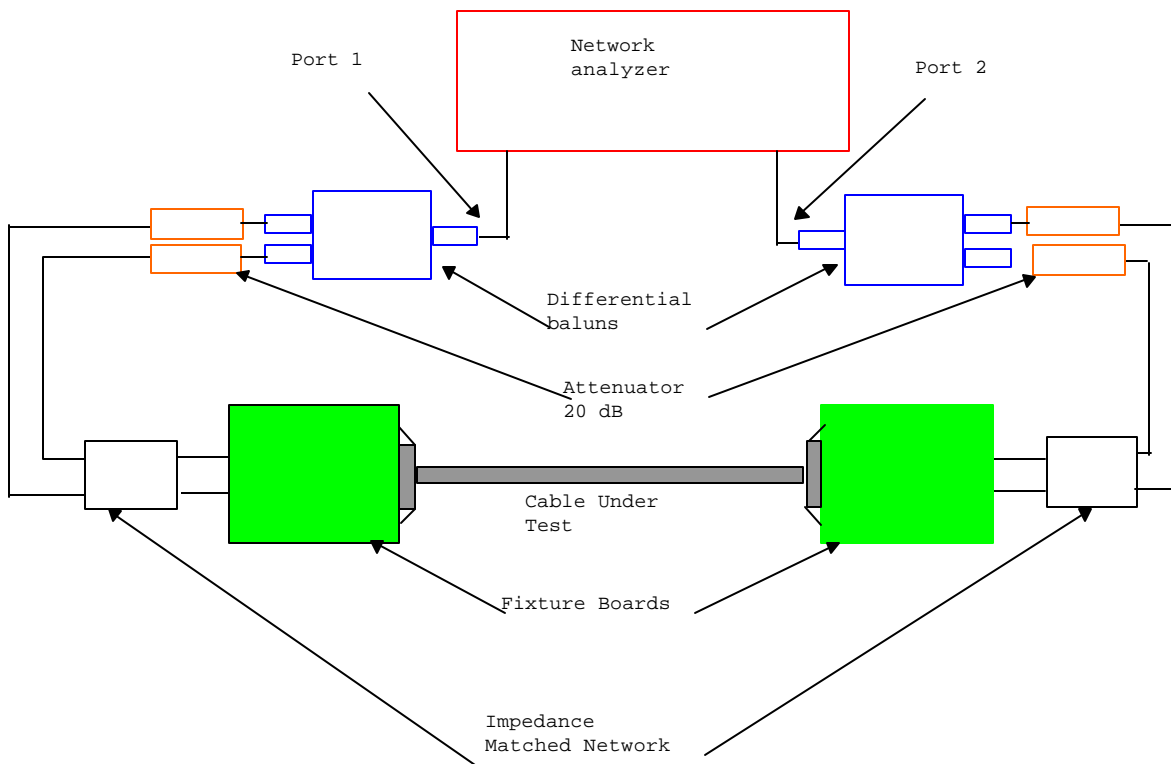

Figure 1 - Test setup

Test conditions

A network analyzer is used both as the source of the test signal and as a means of measuring the cable attenuation.

The cal kit contains the precision coax cables and the connector system whose models are stored in the analyzer memory for error correction purposes.

Test Fixture Board Validation

Measure the impedance of the test fixture board with a 35 ps launch signal. The impedance of the SMA or launch pad on the board shall remain in the range of 50 to 65 ohms for a 61 ohm controlled impedance board. See fig. 2 for a comparison profile between traditional and acceptable test fixture board impedance for measurements up to 10 GHz signals. For the case of the traditional impedance profile, use matching impedance network to reduce the effect of the SMA or pad. The blue curve is acceptable. The red curve is not acceptable.

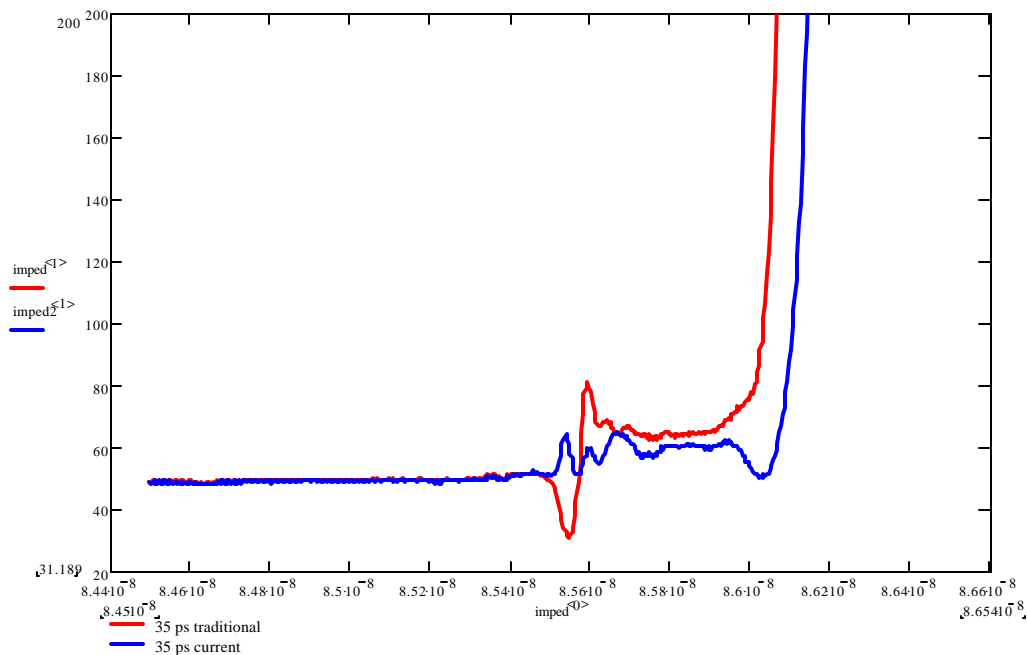

Figure 2 - Test board validation

Measurement Issues:

For a long electrical delay device such as a cable, the network analyzer presents some unusual measurement problems when operating in swept frequency mode. Often the measured response depends on the analyzer's swept time, and incorrect data may be obtained. The magnitude of the response can drop at faster sweep rate and look distorted. At slower sweep rate correct magnitude can be measured. The result may indicate that a cable has more loss than it truly does or it may indicate presence of ripples which is truly not there.

The cause of the measurement problem arise when using a network analyzer to measure a devise that has long electrical delay, dt , the device's time delay causes a frequency shift between it's input and output signals. The frequency shift, df equals the product of the sweep rate and the time delay.

Since frequency is changing with time as the analyzer sweeps, the time delay of the DUT causes a frequency offset between its input and output. In the analyzer receiver, the test and reference input signals will differ in frequency by df . Because the test signal frequency is slightly different than the receiver frequency, the analyzer will err in measuring its magnitude or phase. The faster the analyzer's sweep rate the larger df becomes, and the larger the error in the test channel.

To improve the measurement accuracy, decrease the sweep rate or decrease the time delay. We will choose to decrease the time delay. Since the time delay is the property of the test device, the better thing to do is decrease the delay difference between the R channel and the B channel. This can be achieved by adding a length of cable with equal electrical length as the test device. This length of cable can be inserted between the R channel in and out connectors on the front panel of the analyzer. The delay of this cable must be less than 5 usec.

Differential Impedance:

The impedance will be measured using a Time Domain Reflectometer (TDR) system. TDR employs a step generator and an oscilloscope to capture signal reflections due to device discontinuities. This test will use a 500 psec risetime step signal for the launch signal. As the step propagates through the test fixture and the cable under test, any discontinuities will cause voltage reflections back into the scope. These reflected voltages are used to calculate the reflection impedance of the cable under test.

Test conditions

A Time Domain Reflectometry system (TDR) is used both as the source of the test signal and as a means of measuring the reflected signals of the test device.

Two precision coax cables whose characteristic impedance matches the impedance of the TDR system, are used to connect the test fixture to the TDR system.

The launched signal is adjusted for 500 psec. risetime.

The schedule and sequence is still under development: the first three are Molex, JPM (has it now may go back to Molex for new test fixture, and Madison, Hitachi, Foxconn, TDA, C&M, Tempflex, Amphenol (AIPC)?,

The present (20010612) status: gone to Foxconn (Jason Chou) goes to Madison, next then C&M Some inconsistencies are being found with the attenuation data due to test fixture differences.

12. Propagation Time:

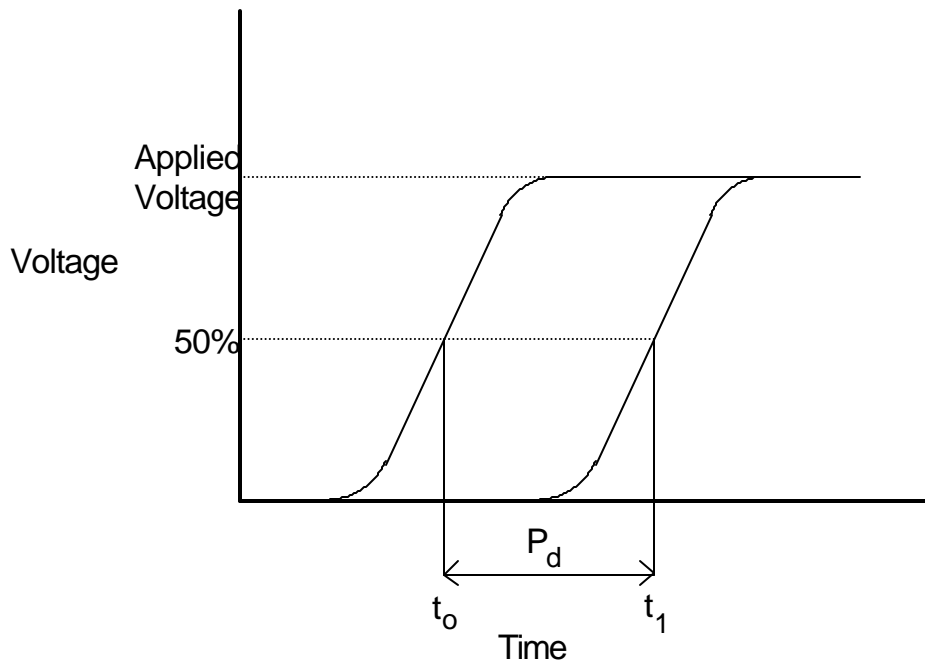

Figure 3 - Propagation time measurements

Use the TDR to measure the propagation time. Capture the input signal at the receiver and store in the instrument memory. Connect the cable assembly and capture the output signal.

The cable propagation delay will be determined by establishing the difference between t_0 and t_1 (See fig. 3). This will yield the cable delay performance.

Test conditions

A Time Domain Transmission system (TDT) is used both as the source of the test signal and as a means of measuring the propagation delay of the system.

Two precision coax cables whose characteristic impedance matches the impedance of the TDT system, are used to connect the test fixture to the TDT system.

The combined test system/fixture step response time should be equal to or less than the cable step response time.

Crosstalk:

This test will evaluate the cross talk performance for differential pairs of SCSI cable assemblies.

Test Conditions:

Source Signal: 504 mV p-p differential
Source Resistance: 100 ohms differential matched to 122 ohm board trace split differential.
Termination Resistance: 122 ohms split differential
Signal risetime: 500 psec. (20 - 80%)
S:G Ratio based on SPI-4 pin-out
Tek 11801C Scope
Proprietary designed test fixture boards, impedance controlled 61 ohm
Single ended.
Impedance matched risetime filters

Test Data Presentation:

Impedance Ohms (risetime: 500 ps)				
Data Lines	Round Cable	Twist/Flat	Twist Only	Comments

DB12				
DB13				
ACK				
REQ				
DB10				
DB11				

Attenuation Round Cable DB/m					
Data Lines	3 dB BW (MHz)	80 MHz	160 MHz	200 MHz	320 MHz
DB12					
DB13					
ACK					
REQ					
DB10					
DB11					

Attenuation Twist/Flat DB/m					
Data Lines	3 dB BW (MHz)	80 MHz	160 MHz	200 MHz	320 MHz
DB12					
DB13					
ACK					
REQ					
DB10					
DB11					

Attenuation Twist Only DB/m					

Data Lines	3 dB BW (MHz)	80 MHz	160 MHz	200 MHz	320 MHz
DB12					
DB13					
ACK					
REQ					
DB10					
DB11					

Propagation Time Round Cable (ns)				
Differential Pair	Conductor 1	Conductor 2	Propagation Time	Propagation Time/Meter
DB(12)	1	35		
DB(13)	2	36		
ACK	24	58		
REQ	29	63		
DB(10)	33	67		
DB(11)	34	68		

Propagation Time Twist/Flat (ns)				
Data Line	Conductor 1	Conductor 2	Propagation Time	Propagation Time/Meter
DB(12)	1	35		
DB(13)	2	36		
ACK	24	58		
REQ	29	63		
DB(10)	33	67		
DB(11)	34	68		

Propagation Time Twist Only (ns)				
Data Line	Conductor 1	Conductor 2	Propagation Time	Propagation Time/Meter
DB(12)	1	35		
DB(13)	2	36		
ACK	24	58		
REQ	29	63		
DB(10)	33	67		
DB(11)	34	68		

Cross Talk (Differential) Rise time (20-80%): 500 ps							
Differential Pair		Round Cable		Twist/Flat		Twist Only	
Driven	Victim	NEXT %	FEXT %	NEXT %	FEXT %	NEXT %	FEXT %
24, 58	29, 63						
1, 35	2, 36						

Bob Gannon agreed to attempt to define a signal degradation test based on eye diagrams and with independent aggressor signals operating during the acquisition of the primary pair under test eye.

13. Proposed new round robins

No new round robins were proposed this meeting. See however, the next item.

14. Frequency dependence of dielectric constant test methodology - Barnes, LSI Logic; Vaupotic, Spectra strip

Deferred (again) to June due to scheduling issues with available time from Larry Barnes. This work is intended to use the HP polished probe method according to the following table. A round robin is planned when the method is stabilized.

Greg Vaupotic provided swept frequency data from the slab method for several samples. The samples in both pellet and extruded form along with data were provided to Larry B.

This discussion produced collaboration containing the following:

Pure polyethelyne samples to be provided by Spectra Strip (unlikely to be affected by processing)	slab method data from Spectra Strip's supplier measurements	coax probe method from LSI Logic measurements
raw material processed into a slab	Spectra strip	NA due to slab samples no longer existing
raw material extruded over single conductor 30 AWG with approximately 10 mils dielectric thickness	NA	LSI logic -- strip material off conductor and measure by inserting the probe through slit in the conductor to the opposite side

The range of frequency will be at least 1 MHz to 1 GHz linear sweep.

The samples and slab data have been delivered to Larry.

Greg Vaupotic and Larry Barnes are actioned to complete the work outlined in the above table.

15. Worst case vs spec numbers strategy

In order to ensure that the performance measurements are executed with the most aggressive conditions a set of detailed requirements were developed in this meeting.

15.1 To meet the non-precomp receiver requirements

Aggressor lines (used to generate cross talk noise) shall have 1.6v pp +/- 0.1 v differential amplitude with a rise time of 1.0 ns +/-0.1 ns at the source. Far end aggressor signals shall not be time correlated to (i.e. not derived from the same timing source) the launch signal used on

the pair under test. Time correlation is allowed on near end aggressors.

The pair under test launched signal shall have 740 mv pp +-50mV with a rise time of 1.0ns +-0.1 ns

Max allowed jitter is present in launched signal - receiver requirements adjusted to account for max launch jitter if max jitter is not present in launch signal used for the test.

Data pattern running during the testing shall be 2**7-1.

15.2 To meet the precomp receiver requirements

Far end aggressor signals shall have 1.6v pp +- 0.1 v differential amplitude with a rise time of 1.0 ns +-0.1 ns at the source and shall not be time correlated to the launch signal on pair under test)

The launched signal on the pair under test shall use 33% cutback (max amplitude - 33%) with a weak driver at 740 mv pp +-50mV and a rise time of 1.0ns +-0.1 ns

Near end aggressor signals shall use same precomp properties as the driver for the pair under test (time correlation is allowed on the near end).

Max allowed jitter is present in launched signal for the pair under test - receiver requirements are adjusted to account for max launch jitter if max jitter is not present in launch signal used for the test.

There was a significant concern than real interconnect may not pass these test requirements and that some finite error rate be established as acceptable. It was pointed out that to have a finite error rate that some specific distribution and mechanism for errors needs to be established and that the Gaussian content of the jitter in SCSI is very low. Therefore it is not clear that having a finite error rate will help to mitigate the concern. No specific number was suggested in this meeting.

If real interconnect does not pass these tests then one would expect a worst case system to fail.

15.3 Interoperability points

[The following has not yet been resolved by the PIP working group.]

Question: should separable connectors that belong to terminators be considered interoperability points? The group agreed that these connectors should be included in the interoperability suite.(Y)

16. Project proposal for PIP - all

It was noted that the project proposal that changes PIP from a technical report to a standard was approved at the T10 plenary in March. The project number is expected to remain 1439-D.

17. PIP documentation - Daggett

This working group will proceed to develop an internal committee document Titled: "SCSI Passive Interconnect Performance Requirements" whose schedule is independent from SPI-x standards schedule. Zane Daggett is editor, Bill Ham and Greg Vaupotic are assistant editors. The document will follow the same general format as 99-219rx.

The document number is 00-160rx.

The following describes the document section assignments:

Zane Daggett: Editor in chief
Bill Ham: General and overview
Greg Vaupotic: Bulk cable (both point to point and multidrop)
Bob Gannon: Cable assemblies (both point to point and multidrop)
Larry Barnes: Backplanes

17.1 Topics for consideration for the passive interconnect test document

[This section was discussed in earlier meetings and modified slightly in this meeting. It will be retained in the minutes until transferred into the PIP document.]

The material in this section was reviewed from the last meeting as possible candidates for consideration for the PIP document 00-160rx.

17.1.1 Components of passive interconnect

The following constitute the basic building blocks of passive interconnect:

media (wire and backplane)
connectors
transition regions (connector termination / comb out / lacing regions /
vias)

17.1.2 Instrumentation / measurement methods:

- Baluns
- Eye diagram / signal degradation testing (including cross talk noise)
- Filtering schemes for eye pattern generation

These topics are in addition to other issues already identified for bulk cable.

17.1.3 Acceptable performance values

All level 1 tests will have specific acceptable values proposed.

18. Starting point for specifying application of tests

The following configurations were agreed to be used for the next steps in developing specifications for the application of the tests.

SIMPLEST POINT TO POINT

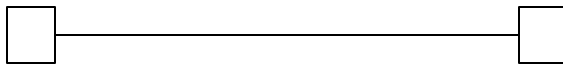

SIMPLEST MULTIDROP

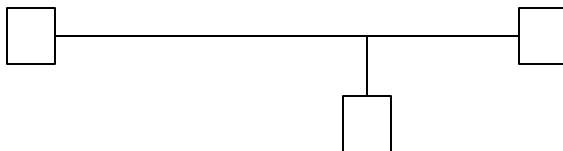

 UNMATED CONNECTOR

The point to point construction allows inclusion of connectors and transition regions, multiple line cross talk, resonance issues and other issues not previously considered in uniform cable media.

The simplest multidrop construction adds a single connector and greatly increases the number of possible interactions between lines as well as adding a known non-uniformity in addition to the connectors and transitions regions in the point to point construction.

Clearly these simple constructions do not have the desired complexity of some interesting applications. These more complex constructions, such as backplanes will be considered after we complete these initial constructions. [Note: the complexity for these simple constructions is significantly greater than that previously considered.]

18.1 Definitions for the document - Barnes

Not addressed at this meeting.

19. Architectural definitions

This refers to issues like defining the test points, nomenclature, and the like. It was decided to use the same conventions commonly used for modeling and transmission lines if possible. Larry B to propose a specific syntax for the next meeting.

All measurements will be through a mated connector. This means that the test fixturing specification will be critical since part of the tested interconnect will remain with the test environment and part will be removable with the IUT.

Zane is creating a summary table for all tests defined above and to start the document.

It was agreed that a special filtering function is needed for some tests to account for the filtering that may occur in the receivers. See 00-149r0 for more detail.

20. Old business

20.1 Standardization of cable sub assemblies, Greg Vaupotic

[It was agreed in the June meeting that the term "multidrop" would be used to describe constructions that have transition regions in addition to those needed to attach the end connectors.]

Per the last PIP meeting the term media will not be used to refer to bulk cable. Greg noted that the concept of non-uniform media is not really describing the situation. He proposed that the term "cable sub-assembly" be used to describe bulk cable modified to accommodate the next higher level of assembly. Examples of cable sub assemblies are: twist and flat, and round cable prepared for termination.

This terminology was accepted by the PIP working group.

The following material was offered for discussion but was not reviewed in detail. The material in its present state does not represent agreement by the PIP group.

The material following is related to measuring cable subassemblies composed of twisted pairs, having transition regions added to facilitate final-assembly operations.

- SPI-3 specifically excludes these products from the measurement / test specification, recognizing the fact that these are not uniform media, but are subassemblies.
- Large demand exists for non-uniform media.
- No measurement standards exist for these subassemblies. Suppliers and customers are therefore forced to develop ad hoc methods which are often incompatible or contradictory.

Measurement methods must be specified, even if test limits are not presently understood. It will be difficult, perhaps impossible, to eventually develop limits without generally accepted measurement methods.

Simplifying Assumptions (suggested)

These issues were not previously addressed due to the complexity of the subassembly problem. Dramatic simplification might result from the following assumptions, which appear to cover most actual end-use situations.

- Non concatenated
- Maximum length perhaps 4 meters (which significantly exceeds prior PIP/SSM discussions) or maybe determined by an attenuation mask discussed later.

Impedance, Time Domain

A fundamental contradiction exists between the treatment of uniform media (often called "round cable") and subassemblies.

120 Ω uniform media is always called 120 Ω , even after transitions have been later added.

But, for example, a 120 Ω twist and flat cable is treated very differently. It is still and always a 120 Ω twist section, but as we place transition regions into a subassembly, the average impedance

increases, no surprise. But we no longer call it a 120 Ω . This is highly inconsistent.

For flat cable subassemblies, many users specify the impedance by looking at the average impedance over several regions. Suddenly, the 120 Ω cable becomes 125 or 135 Ω . This is absurd - it's still a 120 Ω cable with added transition regions.

Greg noted that it may happen that "false" flats may be seen in the TDR trace and that due to roll off in the sample it may not be possible to see a well developed impedance flats for physical flats that are far away from the instrument attachment point.

The use of filtering to emulate the signals that are used in the application also serves well to obscure the impedance of the flat.

[A method to specify the impedance requirements.]

Twisted region

This is the "uniform media" section of the subassembly. Often twist regions are long enough to achieve a reasonably accurate impedance measurement. Very short twist regions are problematic, as reflections induced by discontinuities obscure the region of interest. When the twist region is very short, it might be allowable to measure a twist region of a VERY similar sample having sufficient length for reflections to settle. (This special sample might be produced as part of the same production-run that produced the item of interest.)

Transition region

The first transition region is obscured by fixture effects, while the second region is frequently rounded by attenuation. The transition region is not specified on round-cable assemblies. Why do we specify the transition region here? Might it be sufficient to characterize the transition region?

Impedance, Extended distance

Recommend not including. Evidence indicates subassemblies need to be very long (>> 50 meters) to damp-out measurement resonances. It is extremely impractical to measure very long samples because of the usual lack of shielding. (Understood by anyone who has actually tried to suspend 50+ meters of ribbon from a ceiling, while maintaining distance and minimizing sample crossovers. Even 25 meters is only marginally practical.)

Attenuation

Not all subassembly producers can produce long samples without built-in transition regions. Therefore it might be best to measure attenuation of subassemblies with the transition regions in-place. (25 meter length is feasible.)

Because we might assume a short maximum length, we might specify that the subassembly meet some specified mask. For example, define a maximum attenuation as 6 dB at 200 MHz. For a 4 meter maximum length, this is 1.5 dB / meter maximum at 200 MHz.

Apply a $\sqrt{\text{frequency}}$ relationship as shown:

$$1.5 \text{ dB / meter} = k \sqrt{f} \quad \text{then } k = 0.106066 \text{ with } f \text{ in MHz}$$

$$\text{Mask Attenuation dB / meter} = 0.106066 \sqrt{f} \quad \text{with } f \text{ in MHz}$$

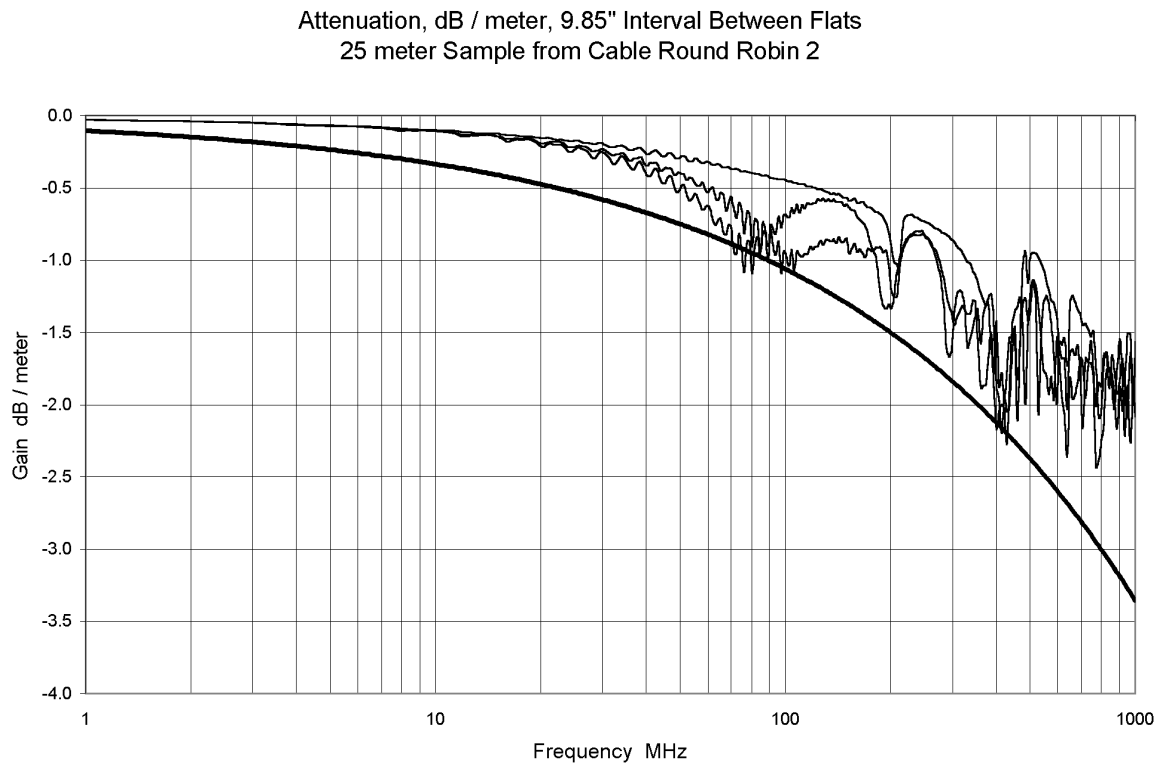

Figure 4 - Attenuation of 3 different pairs, mask added

This sample from Cable Round Robin 2 would pass a 200 MHz attenuation specification, but would fail the example mask specification for 4 meter length at about 75 MHz. However, at 3 meter length it would be quite good. Based on attenuation only, this example might be marked "for 3 meter max length" (based on all the assumptions).

Propagation Delay and Skew

For measurement simplicity, and based on assumed 4 meter maximum length, all delays and skews should be specified as xxx ns / 4 meters or xxx ps / 4 meters. Unit-length specifications are irrelevant based on non concatenated assumption.

Dielectric Constant Variation with Frequency

Suggest deleting this requirement for these subassemblies. If assembly is very short and cost sensitive, the group might not want to automatically disallow economical PVC.

When modeling periodic structures, slightly variable permittivity is probably the smallest problem faced by a modeler. (When necessary, reasonably accurate permittivity vs. frequency data could be provided.)

Crosstalk

Below are plots showing FEXT for two structures.

Figure 5 shows flat cable that is twisted along it's entire length (no transition regions).

Crosstalk is about - 46 dB at 100 MHz.

Figure 6 shows a subassembly similar to above, but with transition regions on 9.85 inch intervals.

The subassembly's crosstalk is about - 20 dB at 100 MHz.

The added crosstalk is not due to the "uniform cable", but instead is due to the structure introduced in the subassembly process.

The same thing would happen to a uniform round media that had transition regions applied at similar intervals!

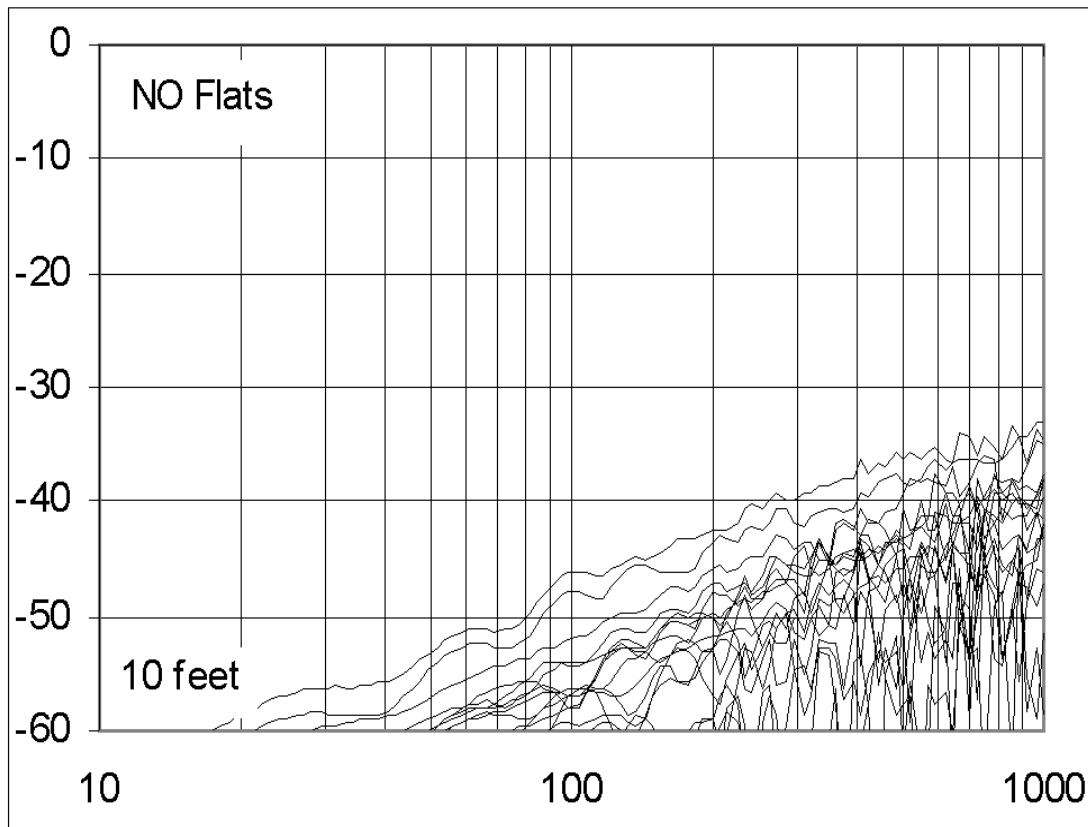

Figure 5 - "Uniform Media" Flat Twisted Pair Cable

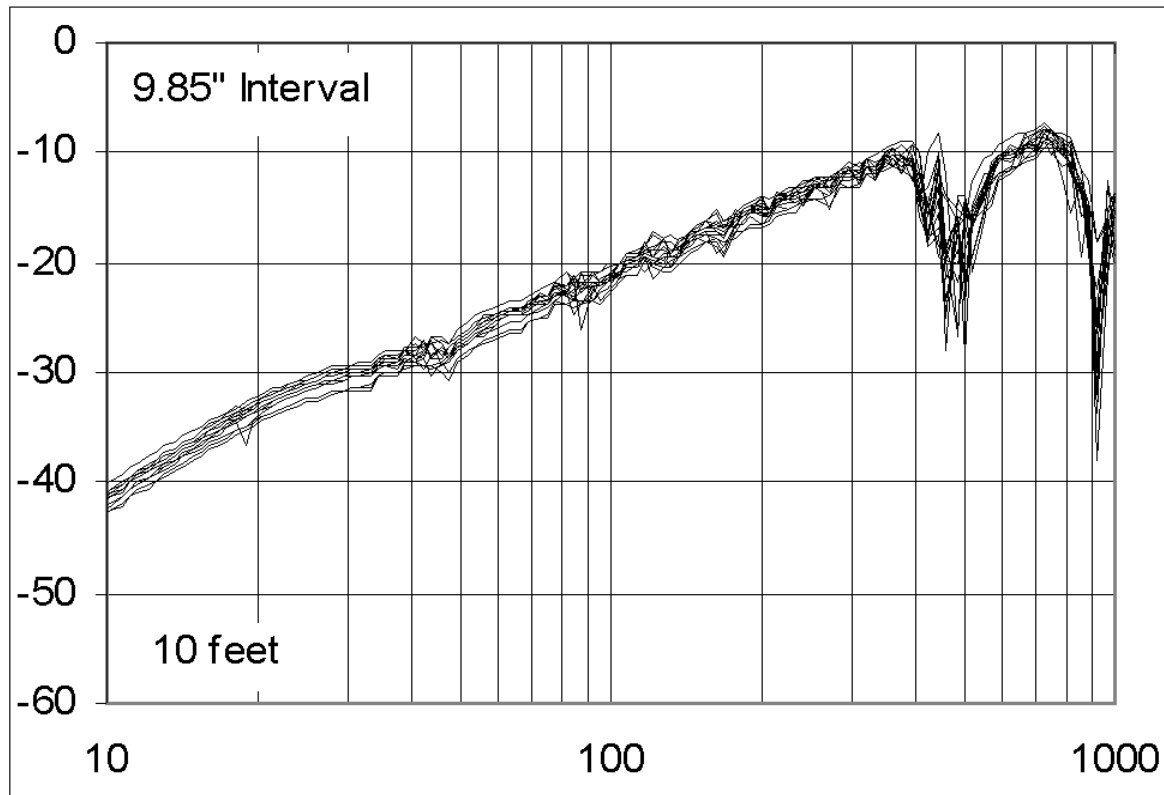

Figure 6 - Same, but with added Transition Regions

To be consistent with the specification of uniform media, three alternatives are evident.

- Measure uniform cable similar to that used in subassemblies (e.g.: specially made ribbons without transition regions).
- Don't measure crosstalk at all under the media specification.
- Measure subassemblies to comply with an as yet to be developed subassembly specification.

21. New business

21.1 Definition of the requirements for different configurations

The following figure defines the S21 (attenuation/gain) requirements based on three configurations:

- uniform bulk cable used in point to point applications
- non-uniform bulk cable and unpopulated backplanes (no connectors) used for multidrop applications
- populated (with loads) multidrop cable assemblies and backplanes

The curves are based on using a maximum multidrop cable assembly length of 3 meters in non-concatenated applications. For point to point assemblies the maximum length is assumed to be 25 meters. The point to point requirements are the same for the cable assembly and the bulk cable because of the dominance of the cable losses.

Note that the losses for the multidrop configurations are assumed to be significantly caused by resonant effects due to the loads and non-uniformities. More allowance is made for multidrop cable assemblies than for multidrop cable assemblies. Due to the assumed short length for multidrop applications less primary wire loss is expected. The budget for accommodating the resonant losses comes from this lower primary wire losses in the shorter lengths for multidrop.

The low frequency losses are also less for the multidrop applications due to the assumed shorter length.

Note that these performance requirements are independent of length and apply to all physical constructions including backplanes.

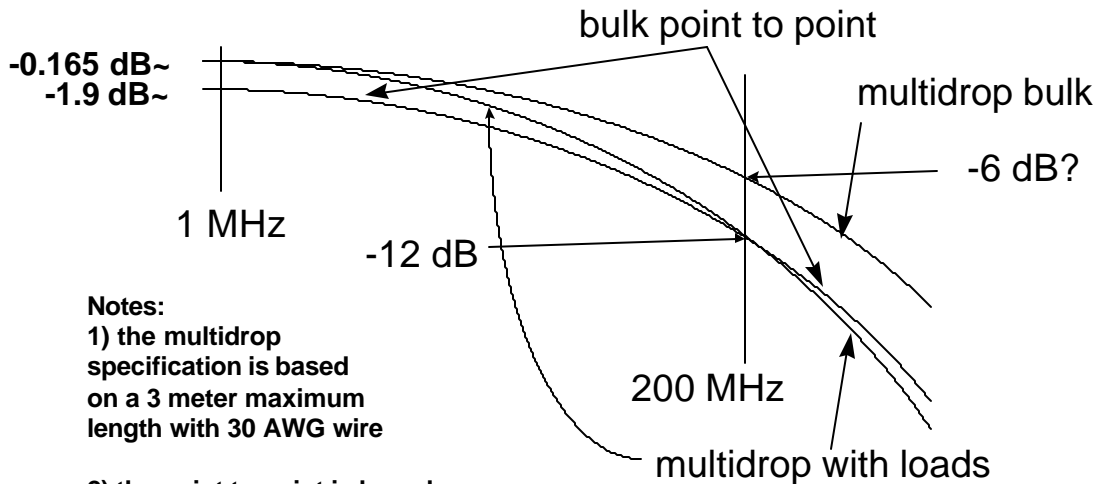

- Notes:
- 1) the multidrop specification is based on a 3 meter maximum length with 30 AWG wire
 - 2) the point to point is based on a 25 meters maximum length with 30 AWG wire
 - 3) curve shape is $K \cdot \sqrt{f}$

Maximum allowable (end to end) S21 vs log frequency

21.2 Skew measurement and specification methodology, Ham

This topic was not discussed in April.

22. Next meetings

Approved schedule:

July 13, 2001, 9AM to 5PM Compaq, Shrewsbury, MA (editing session)

August 14-15, 2001 9AM to 5 PM 08/14; 9AM to 12PM 08/14 Orange Co, CA (TI)

Requested schedule:

October 23-24, 2001 9AM to 5 PM 10/23; 9AM to 12PM 10/24 Colorado Springs, CO (LSI Logic)

December 11-12, 2001 9AM to 5 PM 12/11; 9AM to 12PM 12/12 Guadalajara, MX (JPM)

23. Action Items:

23.1 Old action items from previous meetings

Larry Barnes to acquire data from the polished coax probe method for dielectric constant frequency variations.
Status: equipment now in hand, preliminary setup created with software but test results now expected before August meeting due to Larry not having adequate bandwidth this period to complete

Zane to provide a methodology specification for the HP slab method for dielectric constant vs. frequency
Status: approx 50% complete

Bill Ham to post the draft minutes to the T10 web site
Status: done 01-127r0

Bill Ham to extract this section on interoperability points for presentation at the next SCSI plenary meeting and to produce a version suitable for use in the SSM document.
Status: done

Umesh to propose a set of tests to be used including things like test fixtures and specific slots to be measured for backplane round robin 1.

Status: done - except for S21 tests

Larry Barnes to place his spreadsheet on periodic structures on the T10 web site.

Status: done

Bill Troop to select 1 or 2 boards for use in the backplane round robin 1.

Status: done but boards are not yet supplied to the backplane round robin

Ham to deliver a single 10 slot Compaq backplane (one that is presently shipping) for backplane round robin 1.

Status: carried over

Bill Ham is actioned to contact John Lohmeyer to determine what process to use, if any, to share the cost of consultants to help develop procedures for test and modeling of passive interconnect.

Status: done - T10 cannot be involved in this kind of activity

Bob Gannon to attempt to define a signal degradation test based on eye diagrams and with independent aggressor signals operating during the acquisition of the primary pair under test eye.

Status: carried over

Greg V. is actioned to put the swept frequency impedance data on the T10 web site.

Status: done - T10/01-130r0

Greg Vaupotic and Larry Barnes to complete the work outlined in the table relating to the frequency dependence of dielectric constant.

Status: carried over

23.2 New actions from this meeting

Bill Ham to post the minutes to the T10 web site

Status: new

24. Adjourn

The meeting adjourned at 12:30PM on April 04, 2001